

# PREFACE

This Service Manual describes the technical features and servicing procedures for the **KYMCO *Agility Carry / Delivery 50i* SCOOTER**.

Section 1 contains the precautions for all operations stated in this manual. Read them carefully before starting any operation.

Section 2 is the removal/installation procedures for the frame covers which are subject to higher removal/installation frequency during maintenance and servicing operations.

Section 3 describes the inspection/adjustment procedures, safety rules and service information for each part, starting from periodic maintenance.

Sections 6 to 17 give instructions for disassembly, assembly and inspection of engine, chassis frame and electrical equipment.

Most sections start with an assembly or system illustration and troubleshooting for the section. The subsequent pages give detailed procedures for the section.

Our company reserves the right to make any alteration in the design. The information and contents included in this manual may be different from the motorcycle in case specifications are changed.

**KWANG YANG MOTOR CO., LTD.**  
**OVERSEAS SALES DEPARTMENT**  
**OVERSEAS SERVICE SECTION**

## TABLE OF CONTENTS

ENGINE	GENERAL INFORMATION	1
	FRAME COVERS/EXHAUST MUFFLER	2
	INSPECTION/ADJUSTMENT	3
	LUBRICATION SYSTEM	4
	FUEL SYSTEM	5
	ENGINE REMOVAL/INSTALLATION	6
	CYLINDER HEAD/VALVES	7
	CYLINDER/PISTON	8
	DRIVE AND DRIVEN PULLEYS	9
	FINAL REDUCTION	10
	CRANKCASE/CRANKSHAFT	11
CHASSIS	FRONT WHEEL/FRONT BRAKE/ FRONT SUSPENSION	12
	REAR WHEEL /REAR BRAKE /REAR SUSPENSION	13
ELECTRICAL EQUIPMENT	BATTERY/CHARGING SYSTEM/A.C. GENERATOR	14
	IGNITION SYSTEM	15
	STARTING SYSTEM	16
	LIGHTS/INSTRUMENTS/SWITCHES	17

# 1. GENERAL INFORMATION

Agility Carry / Delivery 50i

1

ENGINE SERIAL NUMBER .....	1- 1	LUBRICATION POINTS.....	1-13
SPECIFICATIONS.....	1- 2	CABLE & HARNESS ROUTING.....	1-15
SERVICE PRECAUTIONS .....	1- 3	WIRING DIAGRAM .....	1-20
TORQUE VALUES .....	1-11	TROUBLESHOOTUNG.....	1-21
SPECIAL TOOLS .....	1-12		

## ENGINE SERIAL NUMBER



Agility Carry 50i



Delivery 50i

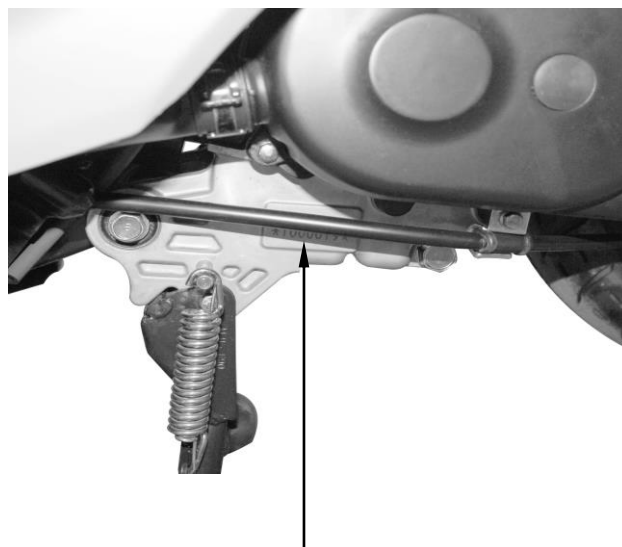

Location of Engine Serial Number

# 1. GENERAL INFORMATION

## SPECIFICATIONS Agility carry 50 45km/h

Motorcycle Name & Type		<b>Agility Carry 50i</b>		
Name & Model No.		AAF1		
Overall length (mm)		1950		
Overall width (mm)		685		
Overall height (mm)		1145		
Wheel base (mm)		1315		
Engine type		O.H.C.		
Displacement		50cc		
Fuel Used		92# nonleaded gasoline		
Net weight (kg)	Front wheel	45		
	Rear wheel	60		
	Total	105		
Gross weight(kg)	Front wheel	96		
	Rear wheel	124		
	Total	220		
Tires	Front wheel	120/70-12		
	Rear wheel	130/70-12		
Ground clearance (mm)		112		
Performance	Braking distance (m)	4 (Initial speed 20km/h)		
	Min. turning radius (mm)	1955/1885		
Engine	Starting system		Starting motor	
	Type		Gasoline, 4-stroke	
	Cylinder arrangement		Single cylinder	
	Combustion chamber type		Semi-sphere	
	Valve arrangement		O.H.C.	
	Bore x stroke (mm)		φ39.0 x 41.4	
	Compression ratio		10.5±0.2	
	Compression pressure (kg/cm <sup>2</sup> -rpm)		15±2	
	Max. output		2.4/8000 kw/(r/min)	
	Max. torque		3.0/7000N. m/rpm	
	Port timing	Intake	Open	-4
			Close	12
		Exhaust	Open	20
			Close	-8
	Valve clearance (cold) (mm)	Intake	0.04	
		Exhaust	0.04	
	Idle speed (rpm)		2000±100rpm	
	Lubrication System	Lubrication type		Forced pressure & wet sump
		Oil pump type		Inner/outer rotor type
		Oil filter type		Full-flow filtration
		Oil capacity		0.8 liter
	Cooling Type		Forced air cooling	

Fuel System	Air cleaner type & No		Paper element, wet	
	Fuel capacity		5 liter	
Electrical Equipment	Ignition System	Type	ECU	
		Ignition timing	20°---29°	
		Contact breaker	Ignition coil	
		Spark plug	NGK CR6HSA	
	Spark plug gap	0.6~0.7mm.		
Battery	Capacity	12V6AH		
Power Drive System	Clutch	Type	Dry multi-disc clutch	
		Transmission Gear	Type	CVT
	Reduction Gear	Operation	Automatic centrifugal type	
		Type	Two-stage reduction	
Reduction ratio	1st	0.75-2.47		
	2nd	13.61		
Moving Device	Front Axle	Caster angle	----	
		Trail length	—	
	Tire pressure (kg/cm <sup>2</sup> )	Front	1.75/1.75	
		Rear	2.0/2.25	
Turning angle	Left	45°		
	Right	45°		
Brake system type		Front	Disk	
		Rear	Drum	
Damping Device	Suspension type	Front	TELESCOPE	
		Rear	Unit Swing	
	Shock absorber distance	Front	--	
		Rear	--	
Frame type		Under Bone		

# 1. GENERAL INFORMATION

## SPECIFICATIONS Agility carry 50 25km/h

Motorcycle Name & Type		<b>Agility Carry 50i</b>		
Name & Model No.		AAF1		
Overall length (mm)		1950		
Overall width (mm)		685		
Overall height (mm)		1145		
Wheel base (mm)		1315		
Engine type		O.H.C.		
Displacement		50cc		
Fuel Used		92# nonleaded gasoline		
Net weight (kg)	Front wheel	45		
	Rear wheel	60		
	Total	105		
Gross weight(kg)	Front wheel	96		
	Rear wheel	124		
	Total	220		
Tires	Front wheel	120/70-12		
	Rear wheel	130/70-12		
Ground clearance (mm)		112		
Performance	Braking distance (m)	4 (Initial speed 20km/h)		
	Min. turning radius (mm)	1955/1885		
Engine	Starting system		Starting motor	
	Type		Gasoline, 4-stroke	
	Cylinder arrangement		Single cylinder	
	Combustion chamber type		Semi-sphere	
	Valve arrangement		O.H.C.	
	Bore x stroke (mm)		φ39.0 x 41.4	
	Compression ratio		10.5±0.2	
	Compression pressure (kg/cm <sup>2</sup> -rpm)		15±2	
	Max. output		1.1/4750 kw/(r/min)	
	Max. torque		2.3/7000-1500/rpm	
	Port timing	Intake	Open	-4
			Close	12
		Exhaust	Open	20
			Close	-8
	Valve clearance (cold) (mm)	Intake	0.04	
		Exhaust	0.04	
	Idle speed (rpm)		2000±100rpm	
	Lubrication System	Lubrication type		Forced pressure & wet sump
		Oil pump type		
		Oil filter type		Full-flow filtration
Oil capacity		0.8 liter		
Cooling Type		Forced air cooling		
Fuel System	Air cleaner type & No		Paper element, wet	
	Fuel capacity		5 liter	
Electrical Equipment	Ignition System	Type	ECU	
		Ignition timing	20°---29°	
		Contact breaker	Ignition coil	
		Spark plug	NGK CR6HSA	
	Spark plug gap	0.6~0.7mm.		
Battery	Capacity	12V6AH		
Power Drive System	Clutch	Type	Dry multi-disc clutch	
		Transmission Gear	Type	CVT
	Reduction Gear	Operation	Automatic centrifugal type	
		Type	Two-stage reduction	
Reduction ratio	1st	1.25-2.47		
	2nd	18.72		
Moving Device	Front Axle	Caster angle	----	
		Trail length	—	
	Tire pressure (kg/cm <sup>2</sup> )	Front	1.75/2.0	
		Rear	2.0/2.25	
Turning angle	Left	45°		
	Right	45°		
Brake system type		Front	Disk	
		Rear	Drum	
Damping Device	Suspension type	Front	TELESCOPE	
		Rear	Unit Swing	
	Shock absorber distance	Front	--	
Rear		--		
Frame type		Under Bone		



# 1. GENERAL INFORMATION

Agility Carry / Delivery 50i

## SPECIFICATIONS Agility Delivery 50i 45km/h

Motorcycle Name & Type		<b>Delivery 50i</b>		
Name & Model No.		ALC9		
Overall length (mm)		1950		
Overall width (mm)		685		
Overall height (mm)		1130		
Wheel base (mm)		1315		
Engine type		O.H.C.		
Displacement		50cc		
Fuel Used		92# nonleaded gasoline		
Net weight (kg)	Front wheel	39		
	Rear wheel	61		
	Total	100		
Gross weight(kg)	Front wheel	70		
	Rear wheel	125		
	Total	195		
Tires	Front wheel	120/70-12		
	Rear wheel	130/70-12		
Ground clearance (mm)		115		
Perform- ance	Braking distance (m)	4 (Initial speed 20km/h)		
	Min. turning radius (mm)	2100/1810		
Engine	Starting system		Starting motor	
	Type		Gasoline, 4-stroke	
	Cylinder arrangement		Single cylinder	
	Combustion chamber type		Semi-sphere	
	Valve arrangement		O.H.C.	
	Bore x stroke (mm)		φ39.0 x 41.4	
	Compression ratio		10.5 ± 0.2	
	Compression pressure (kg/cm <sup>2</sup> -rpm)		15 ± 2	
	Max. output		2.37/8000kw/(r/min)	
	Max. torque		3.0/7000N. m/rpm	
	Port timing	Intake	Open	-4
			Close	12
		Exhaust	Open	20
			Close	-8
	Valve clearance (cold) (mm)	Intake	0.04	
		Exhaust	0.04	
	Idle speed (rpm)		2000±100rpm	
	Lubrication System	Lubrication type		Forced pressure & wet sump
		Oil pump type		Inner/outer rotor type
		Oil filter type		Full-flow filtration
		Oil capacity		0.8 liter
	Cooling Type		Forced air cooling	

Fuel System	Air cleaner type & No		Paper element, wet	
	Fuel capacity		5 liter	
Electrical Equipment	Ignition System	Type	ECU	
		Ignition timing	20°---29°	
		Contact breaker	Ignition coil	
		Spark plug	NGK CR6HSA	
	Spark plug gap	0.6~0.7mm.		
Battery	Capacity	12V6AH		
Power Drive System	Clutch	Type	Dry multi-disc clutch	
		Transmission Gear	CVT	
	Reduction Gear	Operation	Automatic centrifugal type	
		Type	Two-stage reduction	
Reduction ratio	1st	0.75-2.47		
	2nd	13.61		
Moving Device	Front Axle	Caster angle	----	
		Trail length	—	
	Tire pressure (kg/cm <sup>2</sup> )	Front	1.75/2.0	
		Rear	2.0/2.25	
Turning angle	Left	45°		
	Right	45°		
Brake system type		Front	Disk	
		Rear	Drum	
Damping Device	Suspension type	Front	TELESCOPE	
		Rear	Unit Swing	
	Shock absorber distance	Front	--	
Rear		--		
Frame type		Under Bone		

# 1. GENERAL INFORMATION

**Agility Carry / Delivery 50i**

## SPECIFICATIONS Agility Delivery 50i 25km/h

Motorcycle Name & Type		<b>Delivery 50i</b>		
Name & Model No.		ALC9		
Overall length (mm)		1950		
Overall width (mm)		685		
Overall height (mm)		1130		
Wheel base (mm)		1315		
Engine type		O.H.C.		
Displacement		50cc		
Fuel Used		92# nonleaded gasoline		
Net weight (kg)	Front wheel	39		
	Rear wheel	61		
	Total	100		
Gross weight(kg)	Front wheel	70		
	Rear wheel	125		
	Total	195		
Tires	Front wheel	120/70-12		
	Rear wheel	130/70-12		
Ground clearance (mm)		115		
Performance	Braking distance (m)	4 (Initial speed 20km/h)		
	Min. turning radius (mm)	2100/1810		
Engine	Starting system		Starting motor	
	Type		Gasoline, 4-stroke	
	Cylinder arrangement		Single cylinder	
	Combustion chamber type		Semi-sphere	
	Valve arrangement		O.H.C.	
	Bore x stroke (mm)		φ39.0 x 41.4	
	Compression ratio		10.5±0.2	
	Compression pressure (kg/cm <sup>2</sup> -rpm)		15±2	
	Max. output		1.12/4750kw/(r/min)	
	Max. torque		2.3/4500N. m/rpm	
	Port timing	Intake	Open	-4
			Close	12
		Exhaust	Open	20
			Close	-8
	Valve clearance (cold) (mm)	Intake	0.04	
		Exhaust	0.04	
	Idle speed (rpm)		2000±100rpm	
	Lubrication System	Lubrication type		Forced pressure & wet sump
		Oil pump type		Inner/outer rotor type
		Oil filter type		Full-flow filtration
		Oil capacity		0.8 liter
	Cooling Type		Forced air cooling	

Fuel System	Air cleaner type & No		Paper element, wet	
	Fuel capacity		5 liter	
Electrical Equipment	Ignition System	Type	ECU	
		Ignition timing	20°---29°	
		Contact breaker	Ignition coil	
		Spark plug	NGK CR6HSA	
	Spark plug gap	0.6~0.7mm.		
Battery	Capacity	12V6AH		
Power Drive System	Clutch	Type	Dry multi-disc clutch	
	Transmission Gear	Type	CVT	
		Operation	Automatic centrifugal type	
	Reduction Gear	Type	Two-stage reduction	
Reduction ratio		1st	1.25-2.47	
		2nd	18.72	
Moving Device	Front Axle	Caster angle	----	
		Trail length	—	
	Tire pressure (kg/cm <sup>2</sup> )	Front	1.75/1.75	
		Rear	2.0/2.25	
	Turning angle	Left	45°	
Right		45°		
Brake system type		Front	Disk	
		Rear	Drum	
Damping Device	Suspension type	Front	TELESCOPE	
		Rear	Unit Swing	
	Shock absorber distance	Front	--	
Rear		--		
Frame type		Under Bone		

# 1. GENERAL INFORMATION

## SERVICE PRECAUTIONS

- Make sure to install new gaskets, O-rings, circlips, cotter pins, etc. when reassembling.

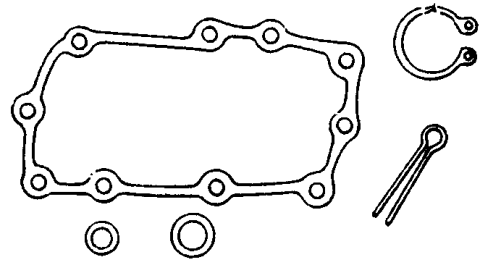

- When tightening bolts or nuts, begin with larger-diameter to smaller ones at several times, and tighten to the specified torque diagonally.

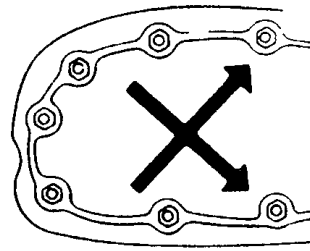

- Use genuine parts and lubricants

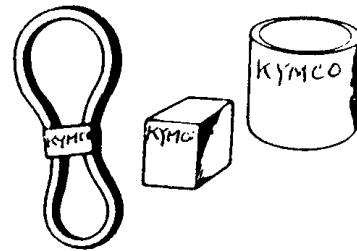

- When servicing the motorcycle, be sure to use special tools for removal and installation.



- After disassembly, clean removed parts. Lubricate sliding surfaces with engine oil before reassembly.

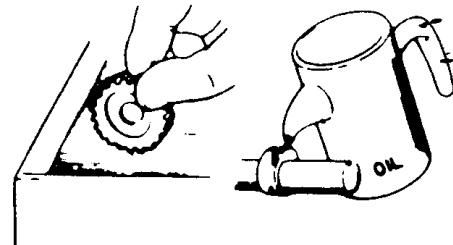

# 1. GENERAL INFORMATION

- Apply or add designated greases and lubricants to the specified lubrication points.

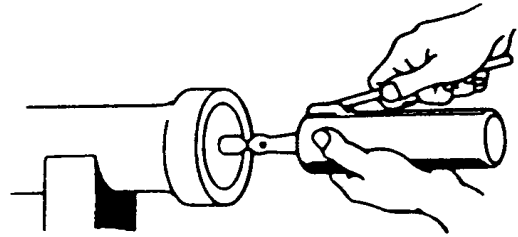

- After reassembly, check all parts for proper tightening and operation.

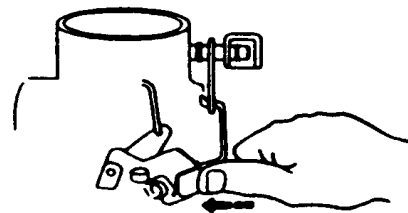

- When two persons work together, pay attention to the mutual working safety.

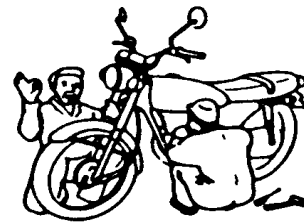

- Disconnect the battery negative (-) terminal before operation.
- When using a spanner or other tools, make sure not to damage the motorcycle surface.

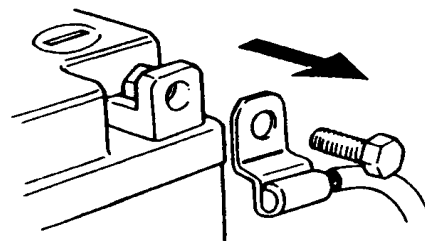

- After operation, check all connecting points, fasteners, and lines for proper connection and installation.
- When connecting the battery, the positive (+) terminal must be connected first.
- After connection, apply grease to the battery terminals.
- Terminal caps shall be installed securely.

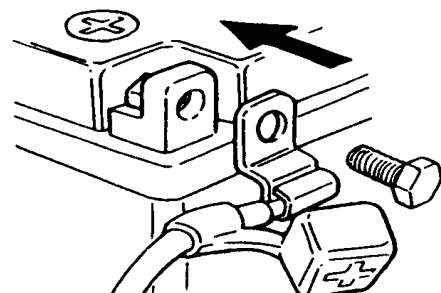

# 1. GENERAL INFORMATION

- If the fuse is burned out, find the cause and repair it. Replace it with a new one according to the specified capacity.

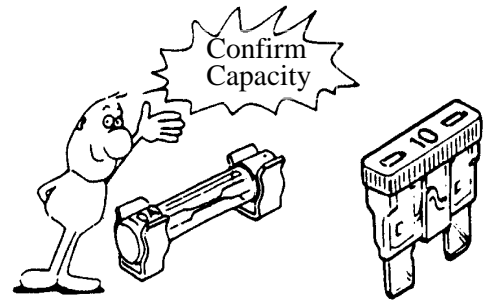

- After operation, terminal caps shall be installed securely.

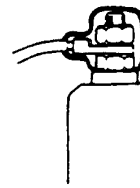

- When taking out the connector, the lock on the connector shall be released before operation.

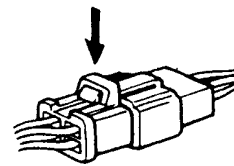

- Hold the connector body when connecting or disconnecting it.
- Do not pull the connector wire.



- Check if any connector terminal is bending, protruding or loose.

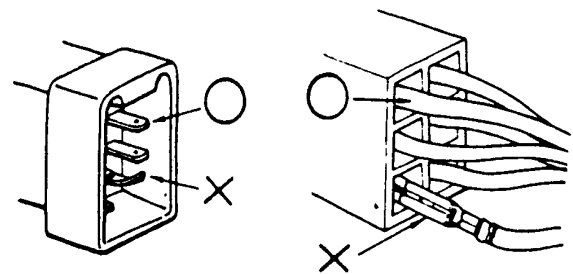

# 1. GENERAL INFORMATION

- The connector shall be inserted completely.
- If the double connector has a lock, lock it at the correct position.
- Check if there is any loose wire.

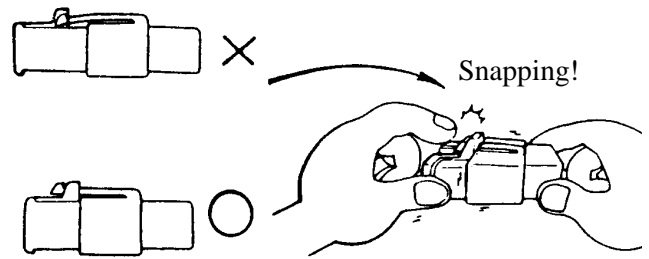

- Before connecting a terminal, check for damaged terminal cover or loose negative terminal.

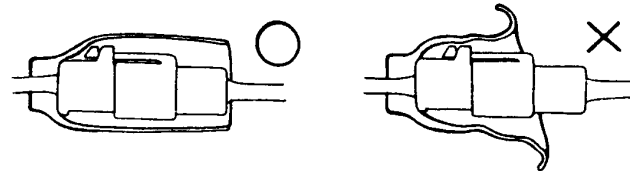

- Check the double connector cover for proper coverage and installation.

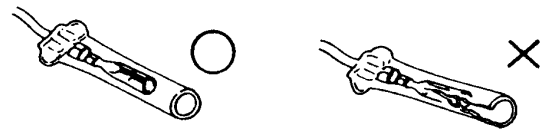

- Insert the terminal completely.
- Check the terminal cover for proper coverage.
- Do not make the terminal cover opening face up.

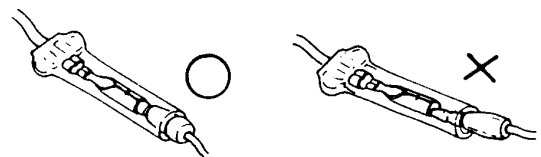

- Secure wire harnesses to the frame with their respective wire bands at the designated locations. Tighten the bands so that only the insulated surfaces contact the wire harnesses.

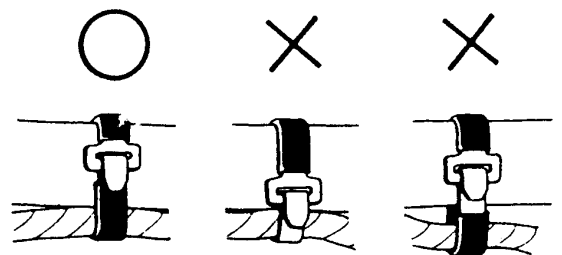

# 1. GENERAL INFORMATION

- After clamping, check each wire to make sure it is secure.

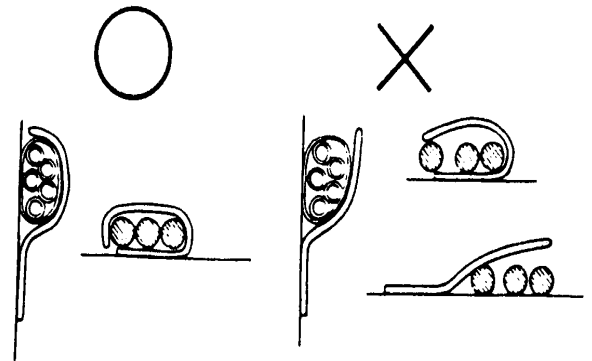

- Do not squeeze wires against the weld or its clamp



- After clamping, check each harness to make sure that it is not interfering with any moving or sliding parts.

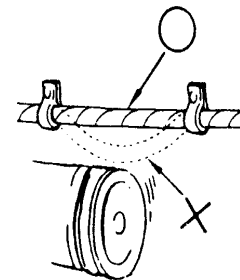

- When fixing the wire harnesses, do not make it contact the parts which will generate high heat.

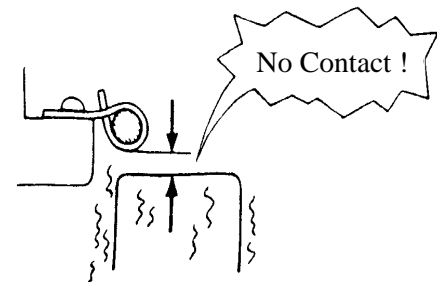

- Route wire harnesses to avoid sharp edges or corners. Avoid the projected ends of bolts and screws.
- Route wire harnesses passing through the side of bolts and screws. Avoid the projected ends of bolts and screws.

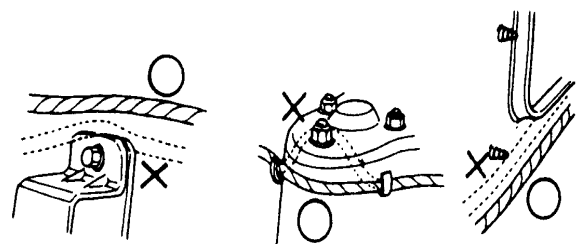

# 1. GENERAL INFORMATION

- Route harnesses so they are neither pulled tight nor have excessive slack.

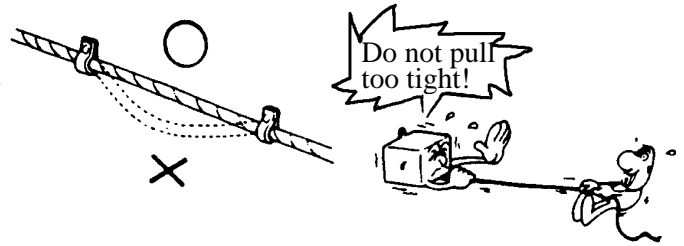

- Protect wires and harnesses with electrical tape or tube if they contact a sharp edge or corner

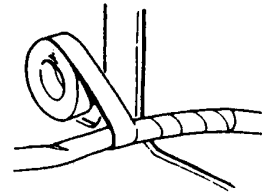

- When rubber protecting cover is used to protect the wire harnesses, it shall be installed securely.

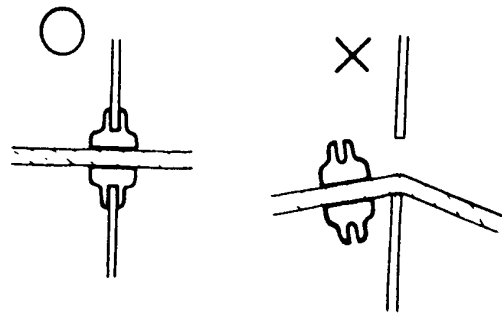

- Do not break the sheath of wire.
- If a wire or harness is with a broken sheath, repair by wrapping it with protective tape or replace it.

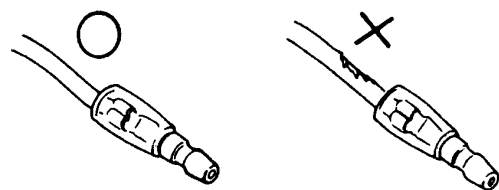

- When installing other parts, do not press or squeeze the wires.





# 1. GENERAL INFORMATION

- After routing, check that the wire harnesses are not twisted or kinked.

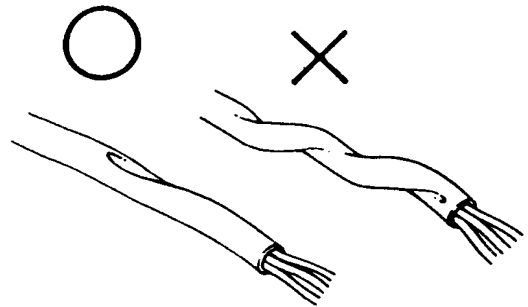

- Wire harnesses routed along with handlebar should not be pulled tight, have excessive slack or interfere with adjacent or surrounding parts in all steering positions.

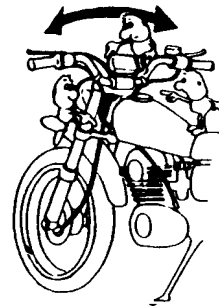

- When a testing device is used, make sure to understand the operating methods thoroughly and operate according to the operating instructions.

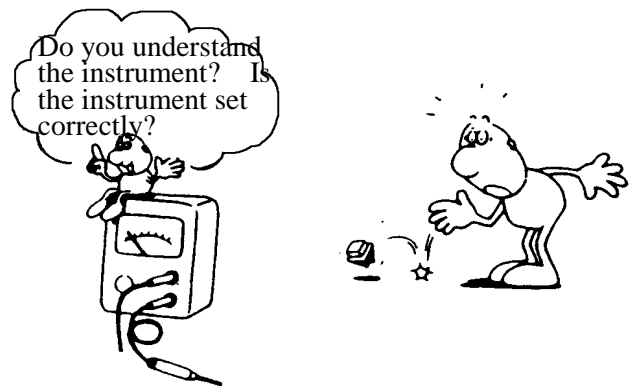

- Be careful not to drop any parts.

- When rust is found on a terminal, remove the rust with sand paper or equivalent before connecting.

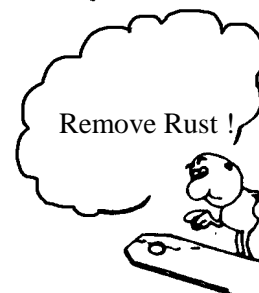

- Do not bend or twist control cables. Damaged control cables will not operate smoothly and may stick or bind.

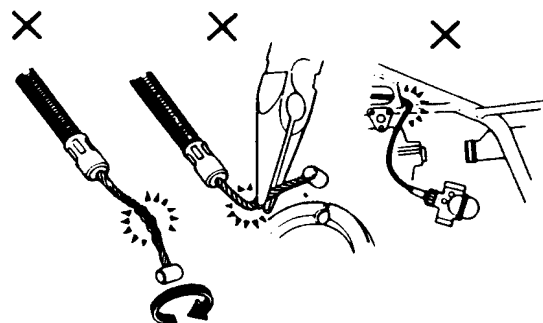

# 1. GENERAL INFORMATION

---

## ■ Symbols:

The following symbols represent the servicing methods and cautions included in this service manual.



Engine Oil

: Apply engine oil to the specified points. (Use designated engine oil for lubrication.)



Grease

: Apply grease for lubrication.



Gear Oil

: Transmission Gear Oil (90#)



: Use special tool.



: Caution



: Warning

(⇒12-3) : Refer to page 12-3.

# 1. GENERAL INFORMATION

## TORQUE VALUES

### STANDARD TORQUE VALUES

Item	Torque (kg-m)	Item	Torque (kg-m)
5mm bolt, nut	0.45-0.6	5mm screw	0.35-0.5
6mm bolt, nut	0.6-1.2	6mm screw, SH bolt	0.7-1.1
8mm bolt, nut	1.8-2.5	6mm flange bolt, nut	1.0-1.4
10mm bolt, nut	3.0-4.0	8mm flange bolt, nut	2.4-3.0
12mm bolt, nut	5.0-6.0	10mm flange bolt, nut	3.5-4.5

Torque specifications listed below are for important fasteners.

### ENGINE

Item	Q'ty	Thread dia.(mm)	Torque (kg-m)	Remarks
Cylinder head bolt A	2	6	0.7-1.1	Double end bolt
Cylinder head bolt B	4	6	0.7-1.1	
Oil filter screen cap	1	30	1.0-2.0	Double end bolt Apply oil to threads
Exhaust muffler lock bolt	2	6	0.7-1.1	
Cylinder head flange nut	4	7	1.2-1.6	
Valve adjusting lock nut	2	3	0.07-0.09	
Cam chain tensioner slipper bolt	1	8	0.4-0.7	
Oil bolt	1	8	1.1-1.5	
Clutch outer nut	1	10	3.5-4.5	
Clutch drive plate nut	1	28	5.0-6.0	
Starter motor mounting bolt	2	6	0.8-1.2	
Oil pump bolt	3	4	0.1-0.3	
Drive face nut	1	10	5.5-6.5	
Spark plug	1	10	1.0-1.4	
A.C. generator stator bolt	2	6	0.8-1.2	
Cam chain tensioner bolt	1	6	0.8-1.2	

### FRAME

Item	Q'ty	Thread dia.(mm)	Torque (kg-m)	Remarks
Steering stem lock nut	1	25.4	8.0-12.0	U-nut
Front axle nut	1	10	5.0-7.0	U-nut
Rear axle nut	1	14	11.0-13.0	U-nut
Rear shock absorber upper bolt	1	10	4.0-5.0	Apply locking agent
Rear shock absorber lower bolt	1	8	2.0-3.0	
Speedometer cable set screw	1	5	0.45-0.6	
Rear shock absorber lock nut	1	8	3.0-3.6	

# 1. GENERAL INFORMATION

## SPECIAL TOOLS



Description	Tool No.	Photo
Flywheel puller	A120E00002	
Oil seal and bearing installer	A120E00014	
Universal holder	A120E00017	
Flywheel holder	A120E00021	
Clutch spring compressor	A120E00034	
Valve adjuster	A120E00036	
Bearing puller	A120E00037	
Cylinder Compression Gauge	A120E00039	

# 1. GENERAL INFORMATION

Description	Tool No.	Photo
Valve spring compressor	A120E00040	
Fuel Pressure Gauge	A120E00048	
INJECTOR CLEANER for Synerjet	A120E00075	
Wires Injector Connector	A120E00090	
Lock nut wrench	A120F00002	
Lower/Upper Race Remover & Installer	A120F00008	
Steering Stem Top Thread Wrench (shoter type)	A120F00024	
Steering Stem Top Thread Wrench	A120F00029	
Band Remover/Installer	A120F00030	

# 1. GENERAL INFORMATION

Agility Carry / Delivery 50i

Description	Tool No.	Photo
Pliers Fuel Pipe	A120F00031	
Electric Repair Kit	A120F00032	

# 1. GENERAL INFORMATION

## LUBRICATION POINTS

### ENGINE

Lubrication Points	Lubricant
Valve guide/valve stem movable part Cam lobes Valve rocker arm friction surface Cam chain Cylinder lock bolt and nut Piston surroundings and piston ring grooves Piston pin surroundings Cylinder inside wall Connecting rod/piston pin hole Connecting rod big end Crankshaft R/L side oil seal Starter reduction gear engaging part Countershaft gear engaging part Final gear engaging part Bearing movable part O-ring face Oil seal lip	<ul style="list-style-type: none"> <li>•Genuine KYMCO Engine Oil (SAE15W-40)</li> <li>•API-SG Engine Oil</li> </ul>
Starter idle gear Friction spring movable part/shaft movable part Shaft movable grooved part Kick starter spindle movable part	High-temperature resistant grease
A.C. generator connector Transmission case breather tube	Adhesive

# 1. GENERAL INFORMATION

Agility Carry / Delivery 50i

## FRAME

The following is the lubrication points for the frame.

Use general purpose grease for parts not listed.

Apply clean engine oil or grease to cables and movable parts not specified.

This will avoid abnormal noise and rise the durability of the motorcycle.

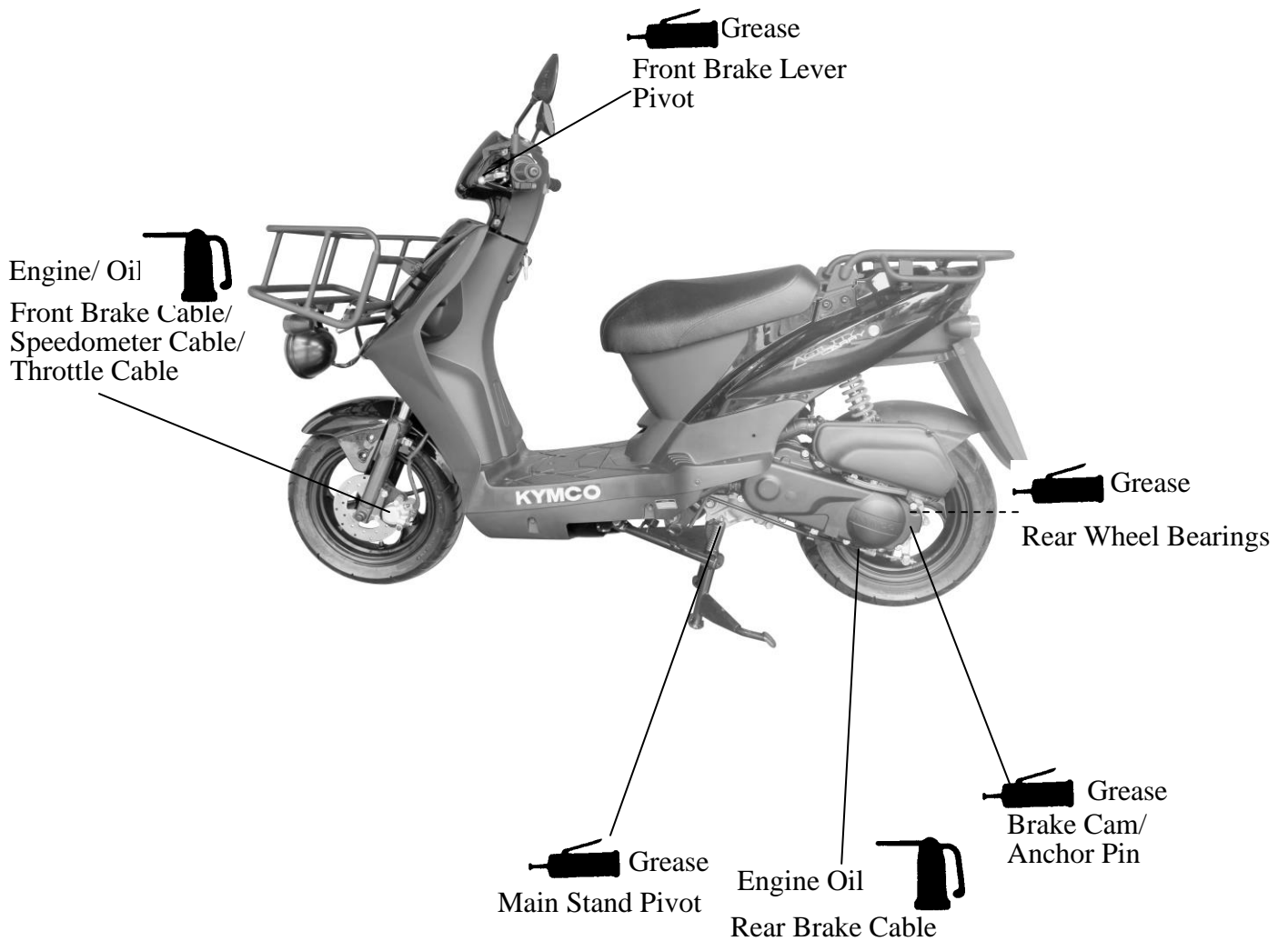



# 1. GENERAL INFORMATION

## CABLE & HARNESS ROUTING

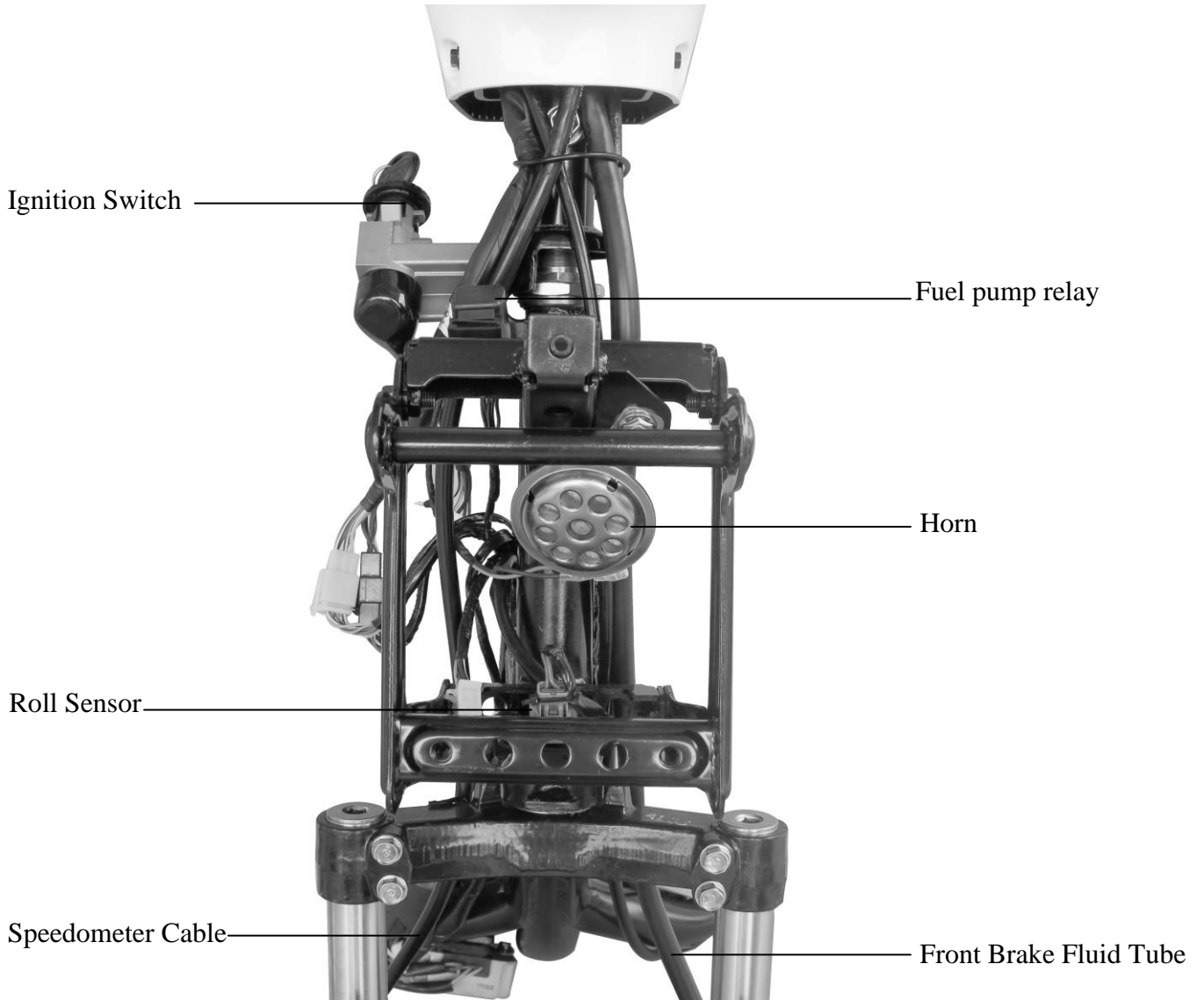
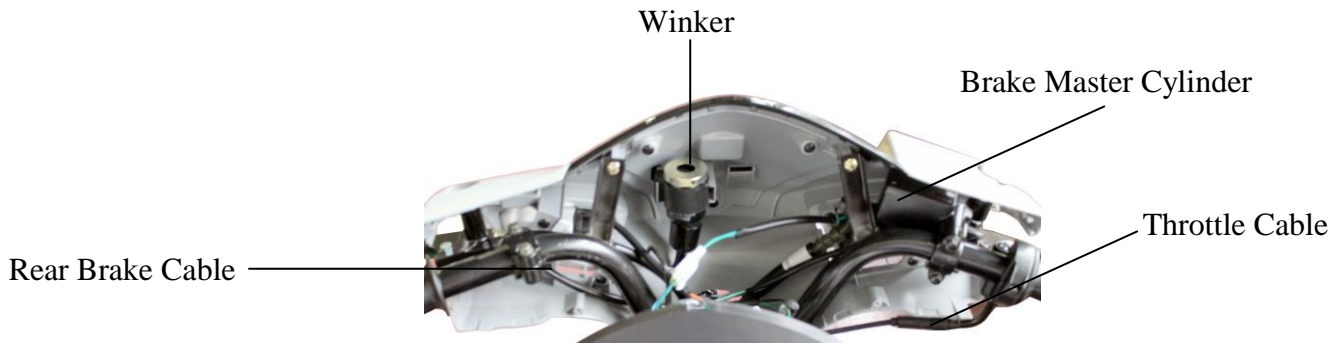

Agility Carry 50i

# 1. GENERAL INFORMATION

Agility Carry / Delivery 50i

## CABLE & HARNESS ROUTING

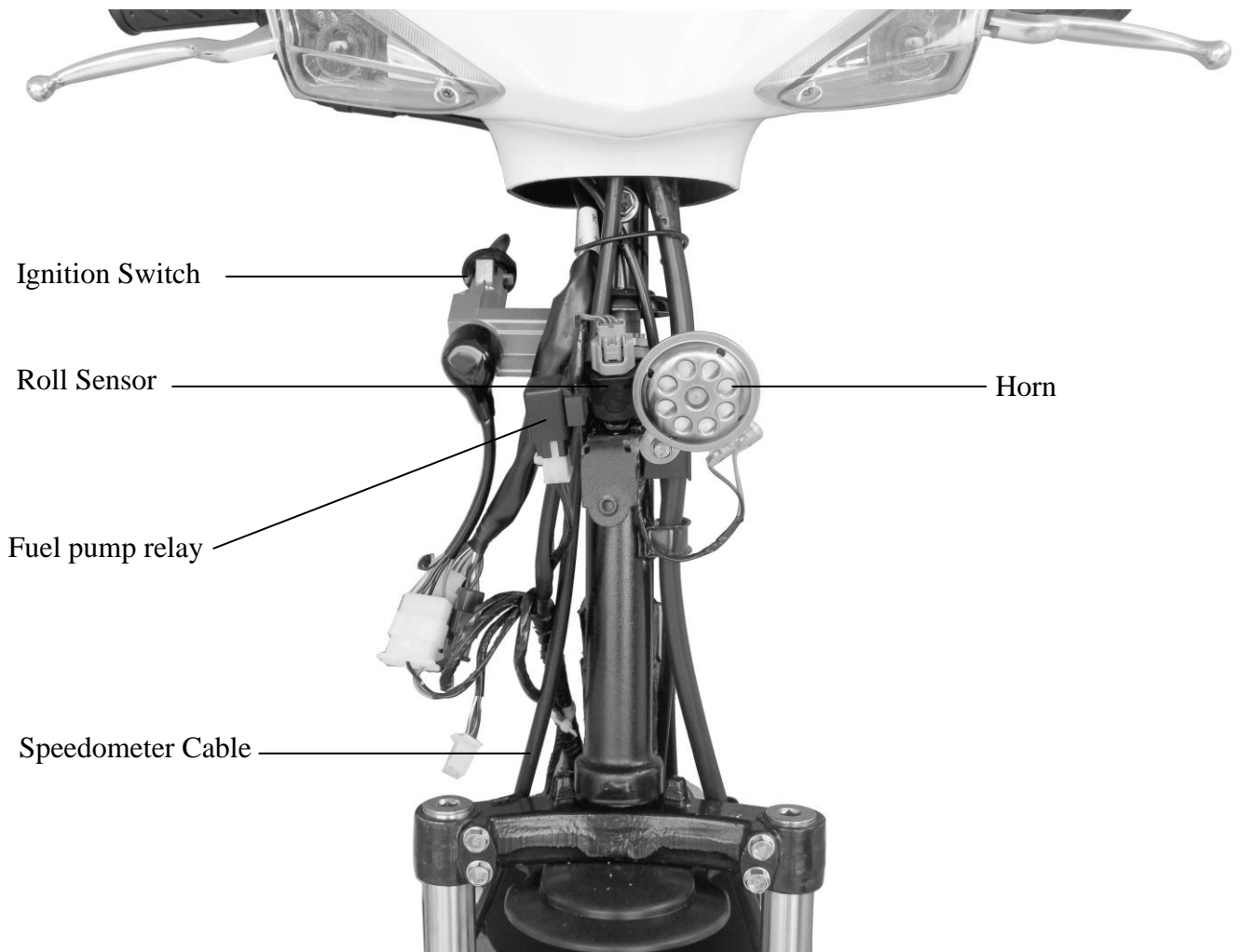
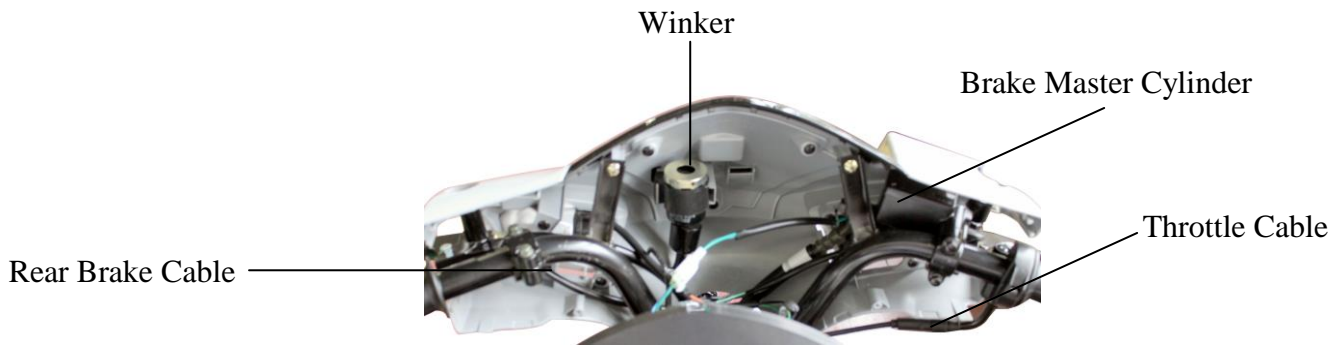

Delivery 50i

# 1. GENERAL INFORMATION

---

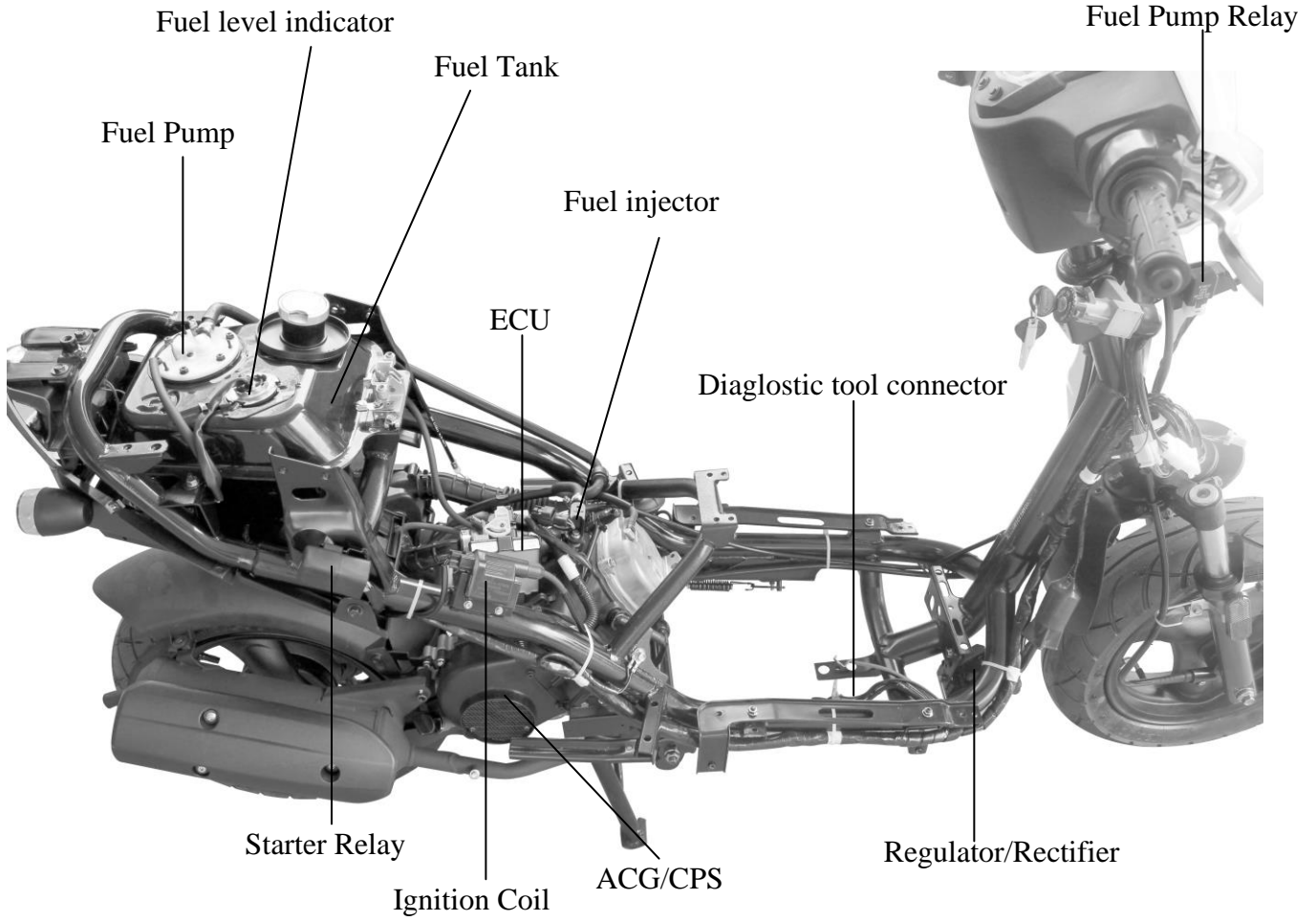

# 1. GENERAL INFORMATION

Agility Carry / Delivery 50i

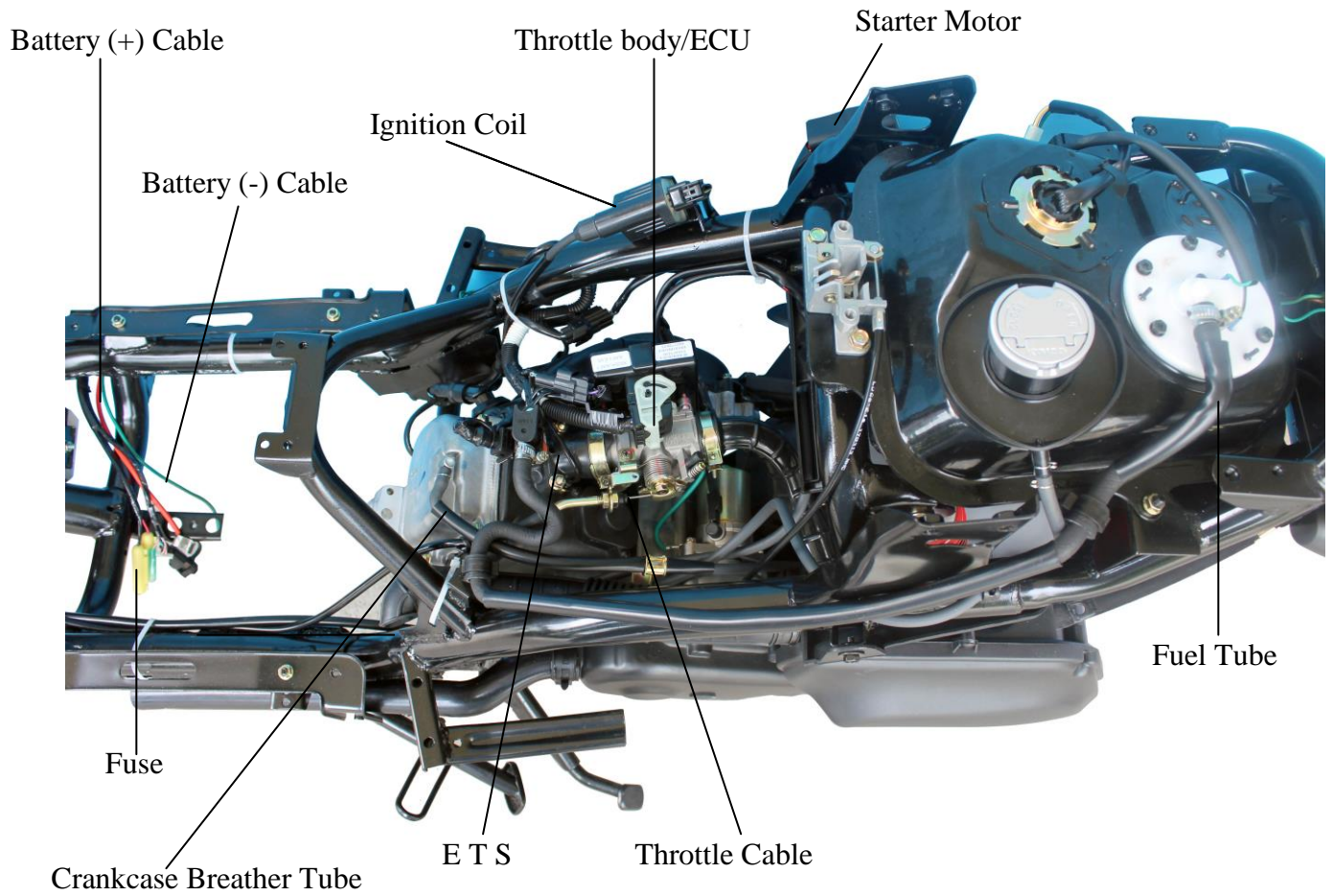

# **1. GENERAL INFORMATION**

---

## **WIRING DIAGRAM**

# **1. GENERAL INFORMATION**

---

## **Troubleshooting**

### **Vehicle can not be started**

#### **Preliminary 6 Step Inspection**

1. Is the battery fully charged (12 V or higher). See the Battery topic for more information.
2. Key-On and listen for any action with Fuel Pump / Fuel Pump Relay (It will turn off automatically in 5-10 seconds)
3. Key-On to check for any failure lamp light up on dashboard. See the Self-Diagnosis topic for more information.
4. Is the Idle screw of Throttle Valve being changed or loose?
5. Has the vehicle under regular service? Is the gas station a good one?
6. Is the spark plug the correct model of specified by the vehicle builder?

# 1. GENERAL INFORMATION

## General Troubleshooting

### ENGINE WILL NOT START OR IS HARD TO START

<b>Possible cause</b>
-----------------------

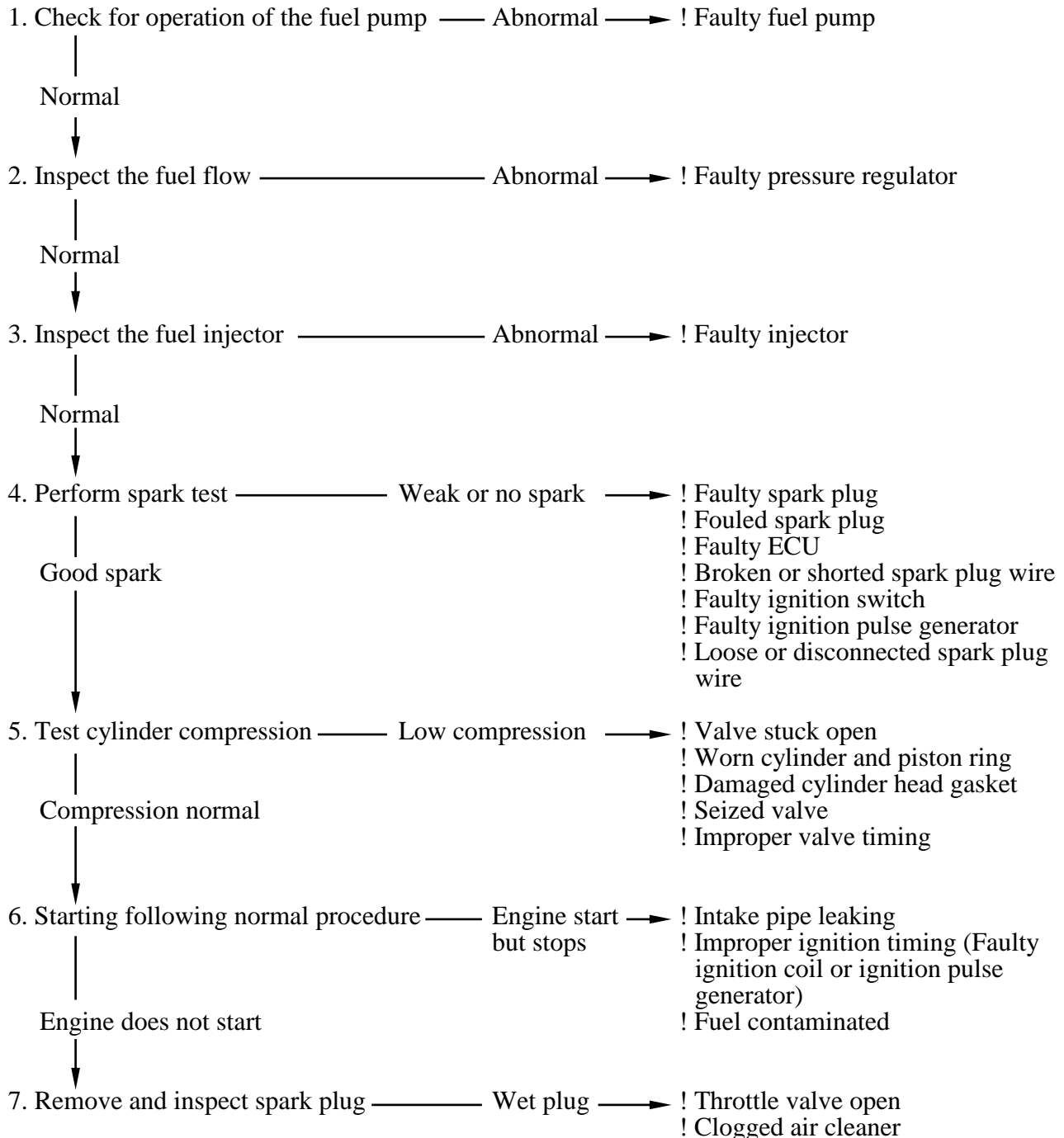

# 1. GENERAL INFORMATION

## Agility Carry / Delivery 50i

### ENGINE LACKS POWER

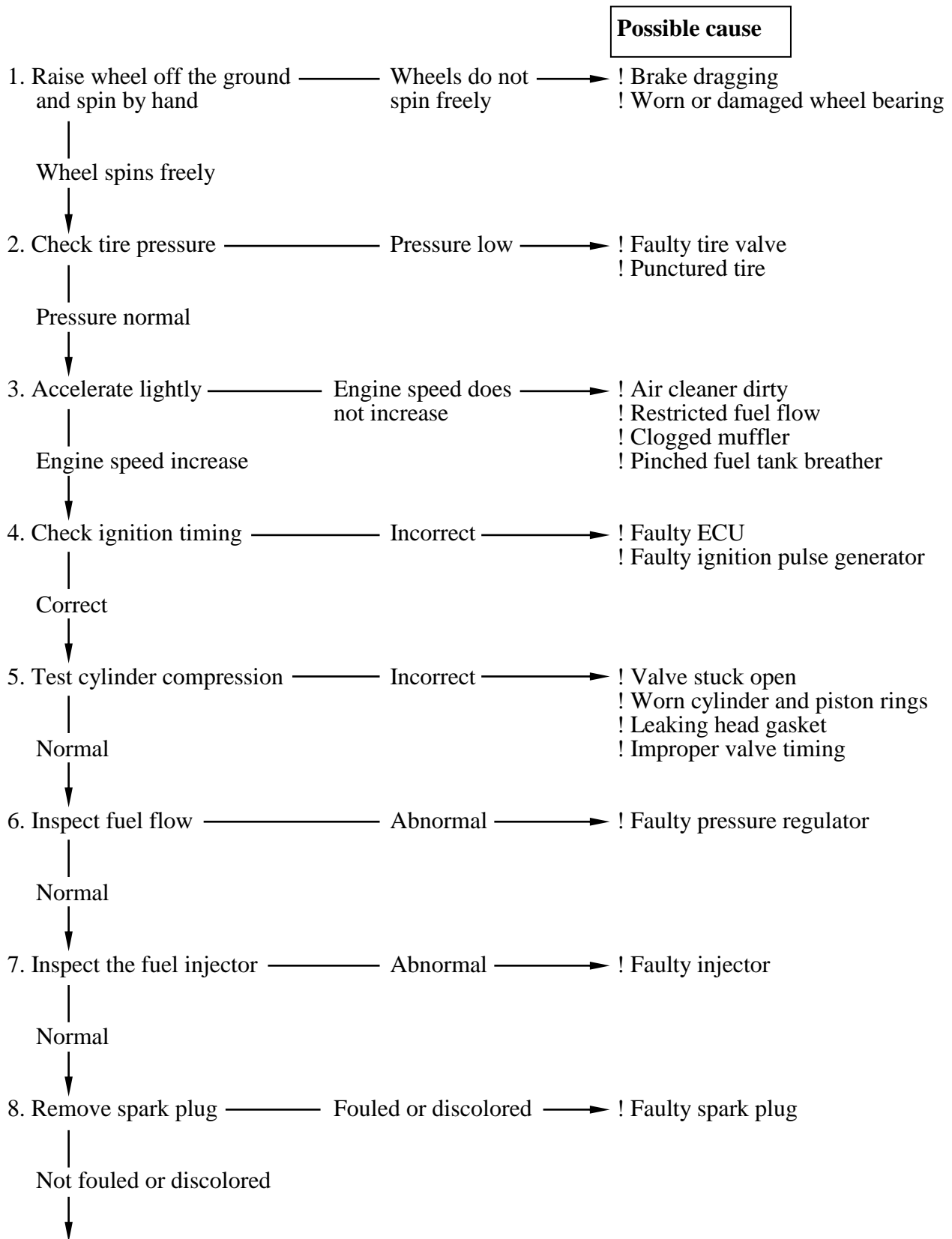



# 1. GENERAL INFORMATION

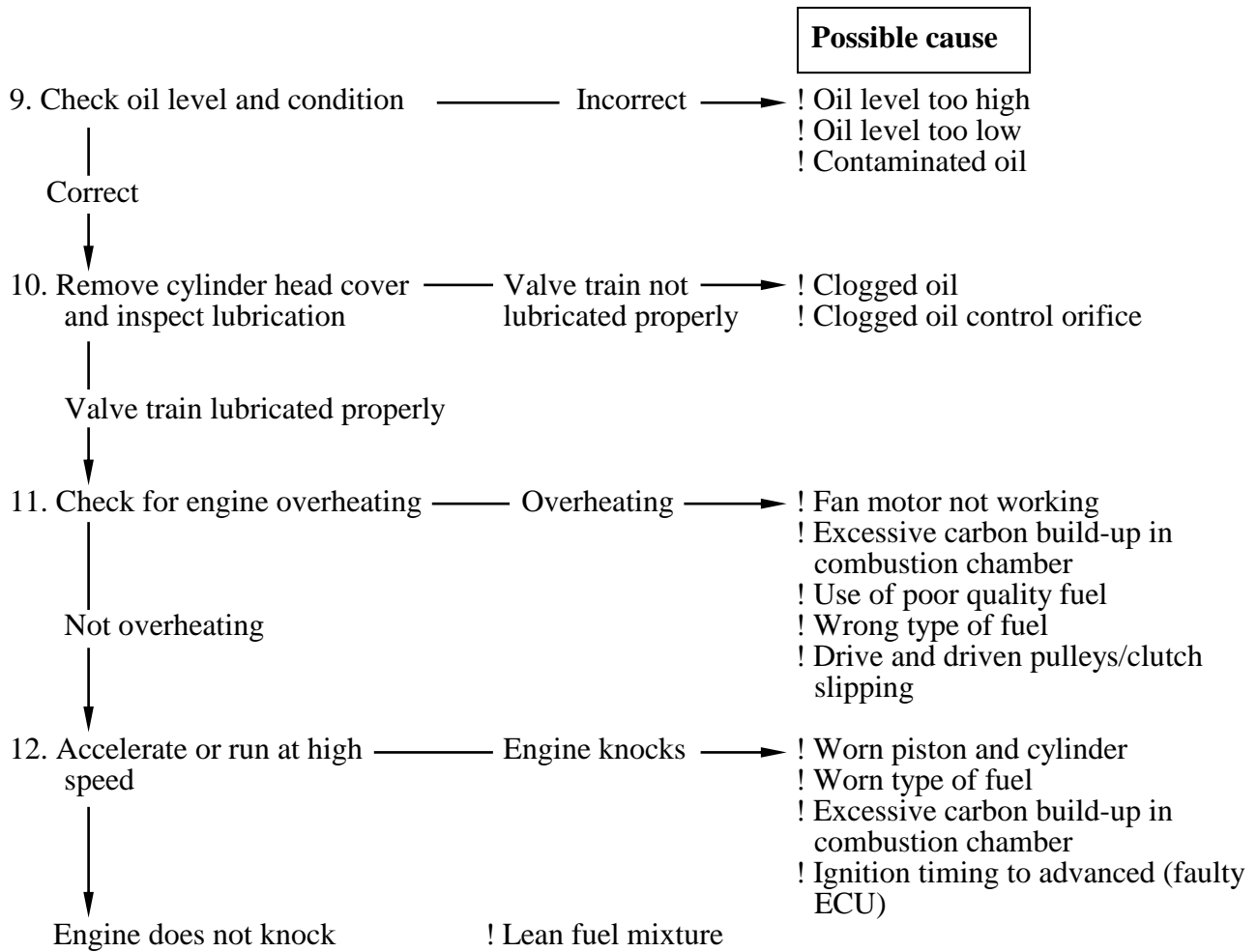

# 1. GENERAL INFORMATION

Agility Carry / Delivery 50i

## POOR PERFORMANCE AT LOW AND IDLE SPEED

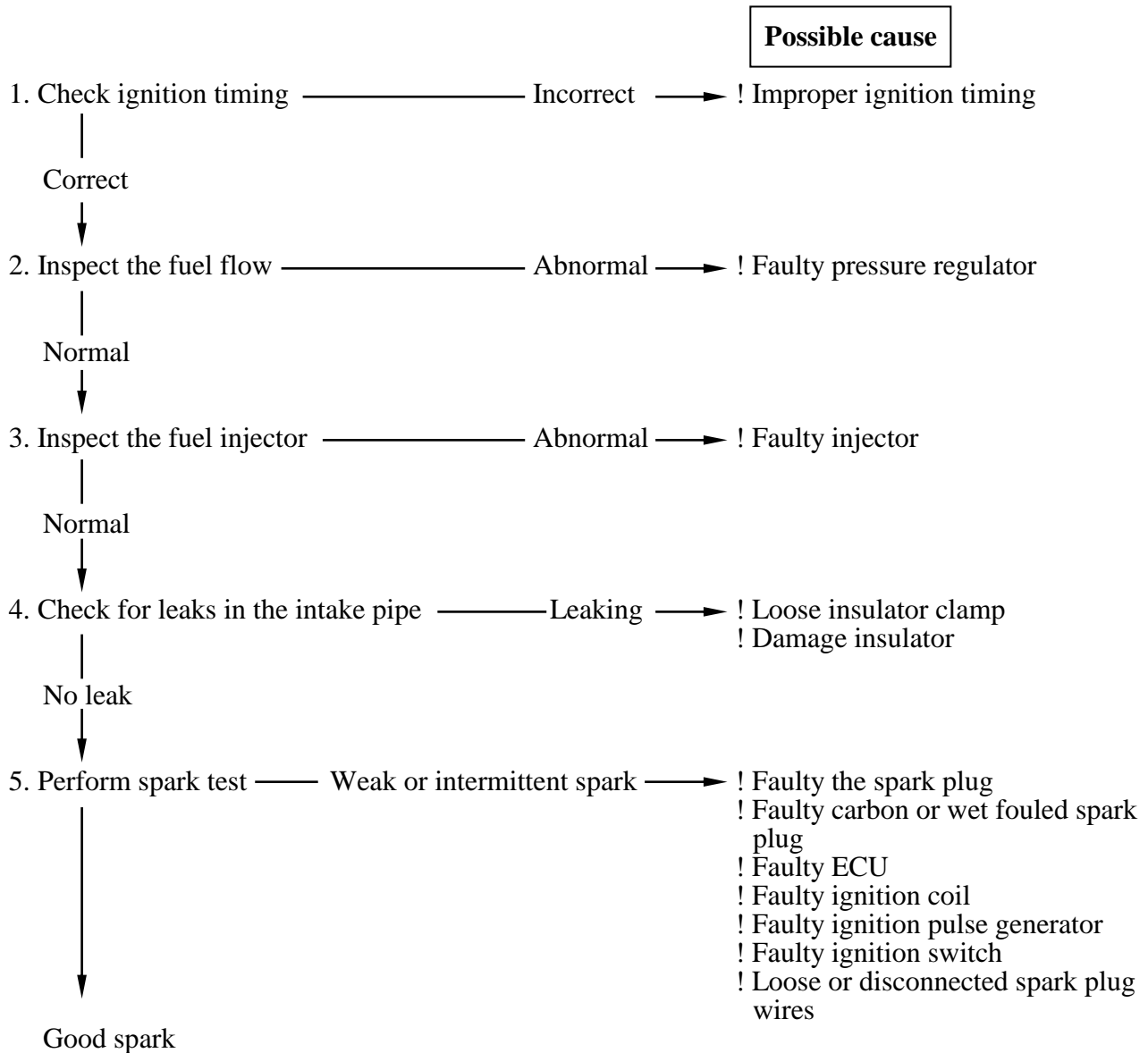

# 1. GENERAL INFORMATION

---

## POOR PERFORMANCE AT HIGH SPEED

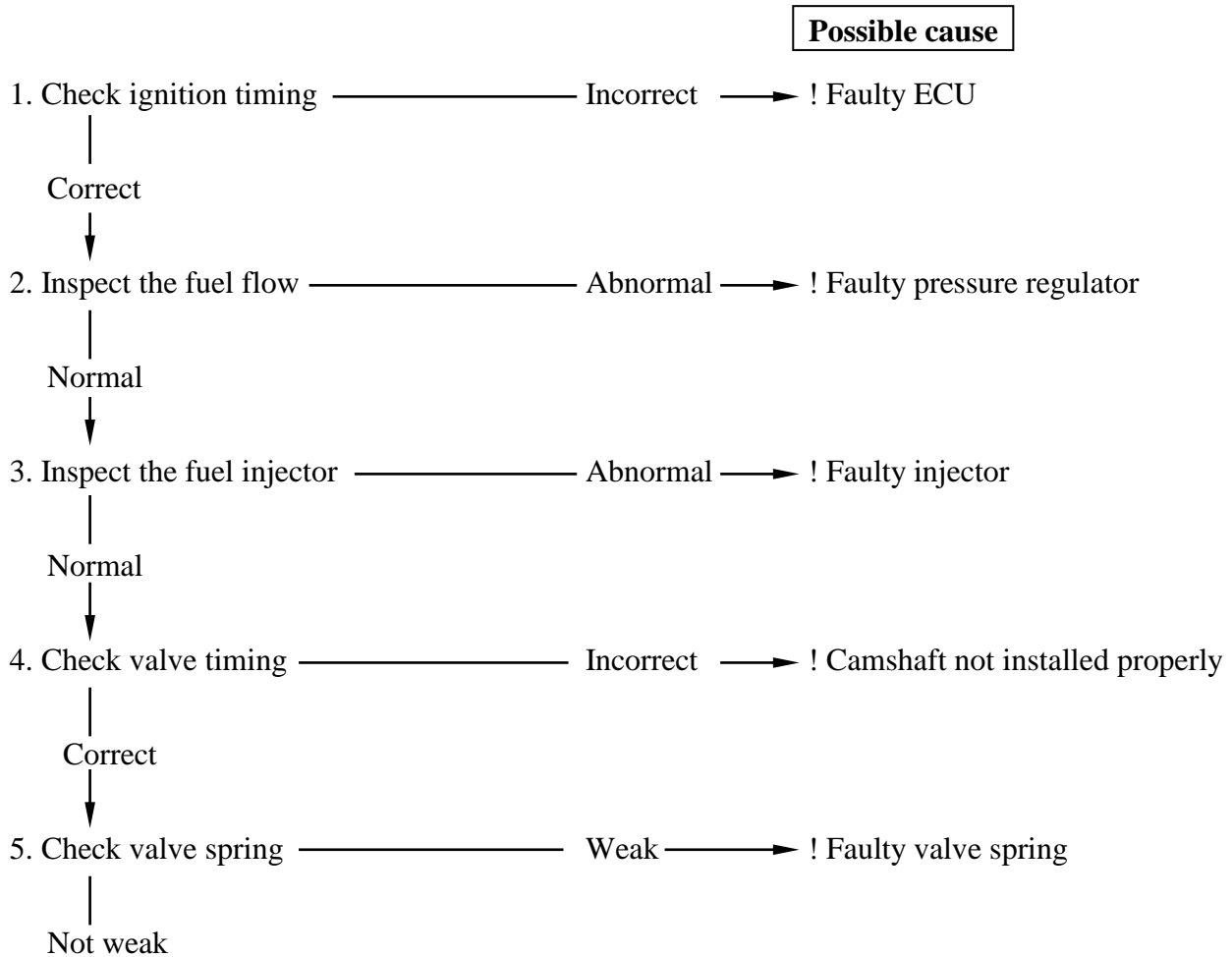

## POOR HANDLING

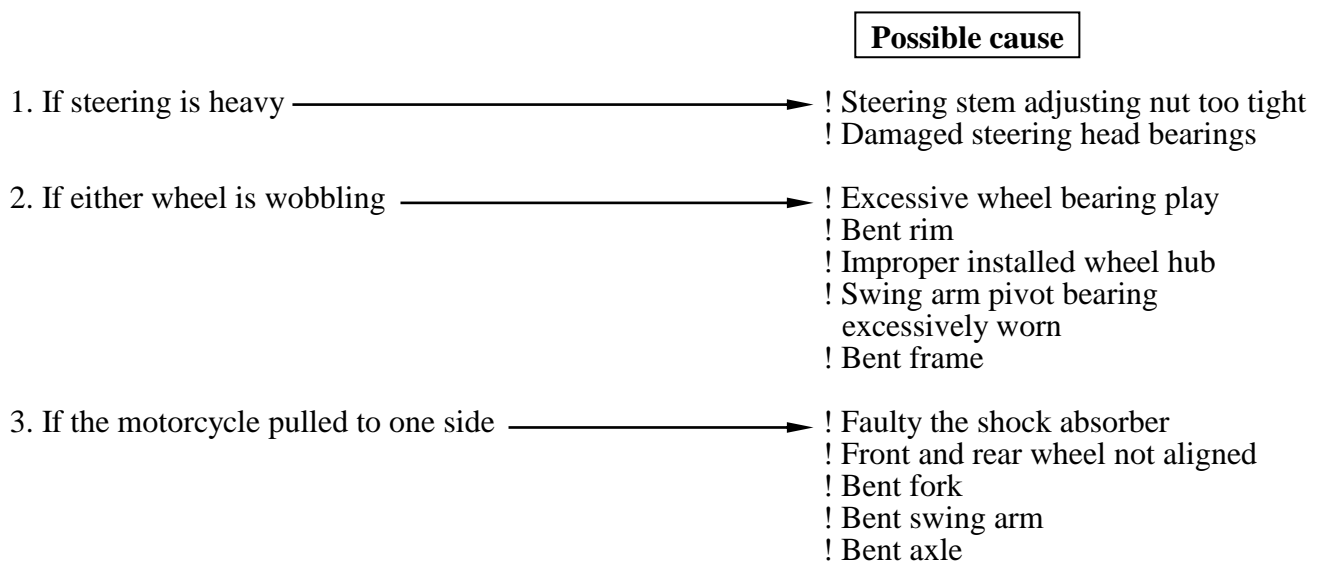

# 2. FRAME COVERS/EXHAUST MUFFLER



Agility Carry / Delivery 50i

## COVERS DISASSEMBLY

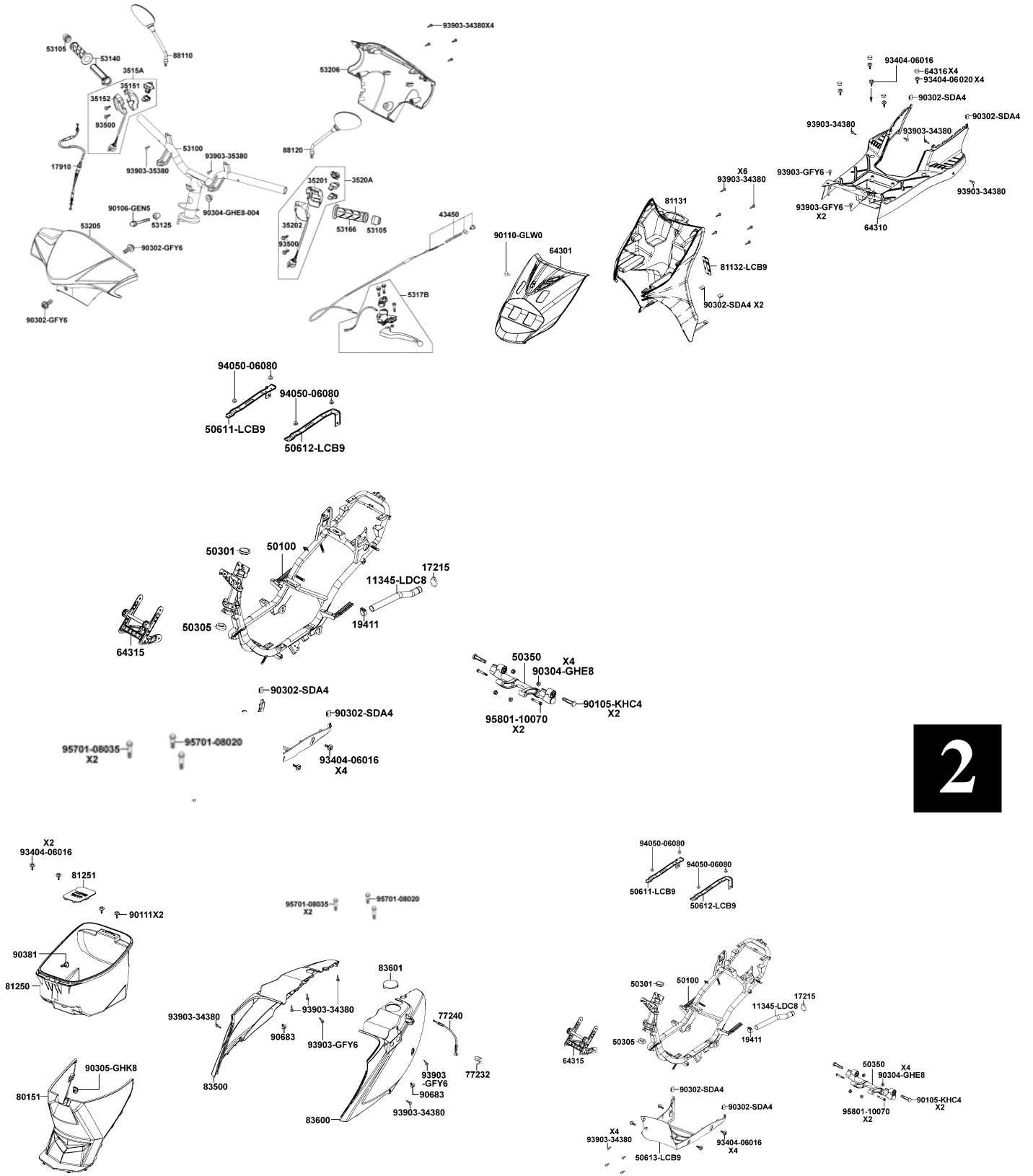

2

SERVICE INFORMATION .....	2-1	EXHAUST MUFFLER REMOVAL .....	2-5
FRAME COVERS .....	2-2		

### SERVICE INFORMATION

#### GENERAL INSTRUCTIONS

- When removing frame covers, use special care not to pull them by force because the cover joint claws may be damaged.

#### Items Related for Removal

- Handlebar front cover ——— Handlebar rear cover  
Headlight wire connector
- Handlebar rear cover ——— Speedometer cable and instrument light  
wire connectors, etc.
- Frame body cover ——— Met-in box, rear grip, rear turn signal  
lights, floor board
- Floor board ——— Frame body cover  
Battery and wire connectors
- Front tool box ——— Front cover, floor board

#### TORQUE VALUES

- |                                |              |
|--------------------------------|--------------|
| Exhaust muffler joint lock nut | 1.0~1.4kgf-m |
| Exhaust muffler lock bolt      | 3.0~3.6kgf-m |

### Front Panel Removal

Remove the 3 bolts from the hook.

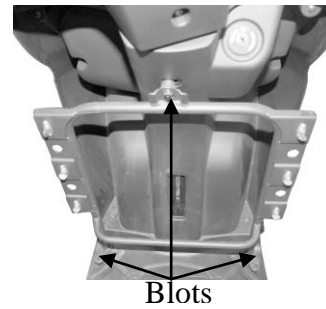

Disconnect the headlight connector.  
Remove the 4 bolts attaching to the frame.  
Remove the front luggage carrier.

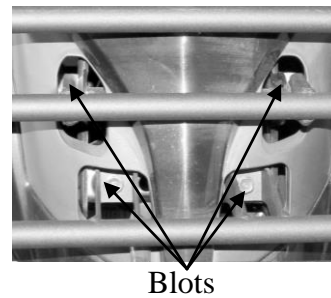
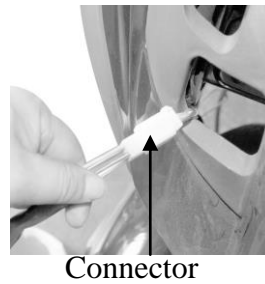

Remove the 1 screw on the front panel.  
Remove the 4 screws from the back side on the front panel.  
Remove the front panel.

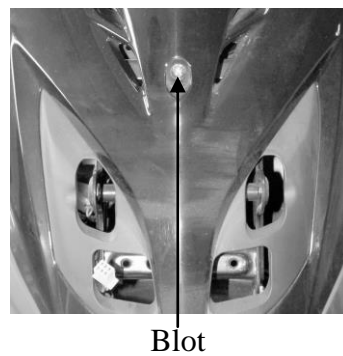

## 2. FRAME COVERS/EXHAUST MUFFLER



Agility Carry / Delivery 50i

### MET-IN BOX REMOVAL

Open the seat  
Remove the 5 bolts attaching the met-in box.  
Remove the met-in box .

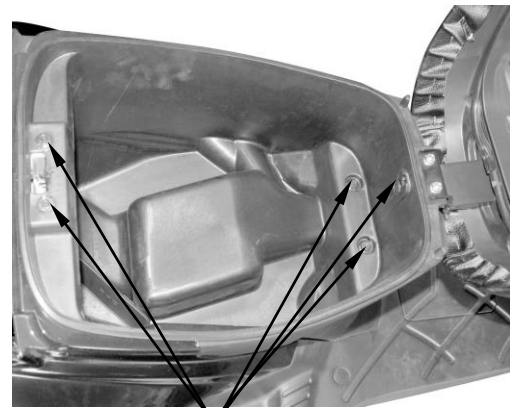

Bolts

### FLOOR BOARD REMOVAL

Remove the 7 bolts attaching the rear carrier.  
Remove the rear carrier.

Remove the met-in box.

Remove the 6 screws attaching the frame body cover.

Disconnect the seat lock wire.  
Remove the frame body cover.



Bolts

Frame Body Cover

Remove the 5 bolts and 4 screws attaching the floor board.

Remove the floor board.

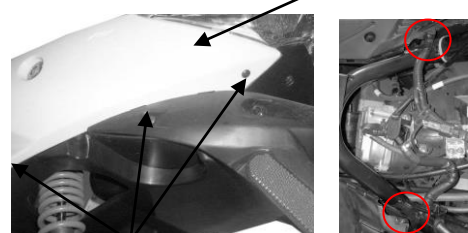

Screws

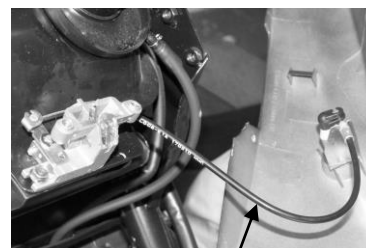

Seat Lock Wire

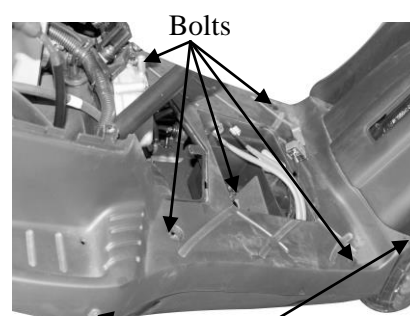

Bolts

Screws

Floor Board.

### LEG SHIELD REMOVAL

Remove the floor board.(2-3)

Remove the front panel.(2-2)

Remove the 4 screws from the back of the leg shield.

Remove the leg shield.

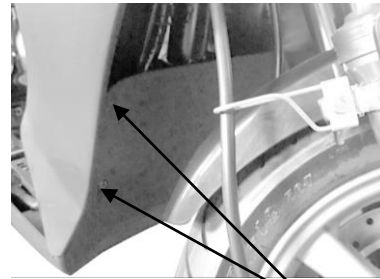

Screws

Remove the 2 bolts and 2 clips.

Remove the rear fender.

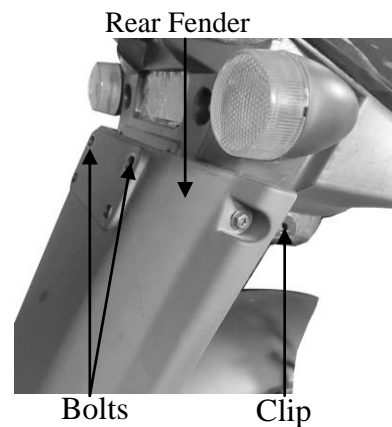

Rear Fender

Bolts

Clip

### FRONT FENDER REMOVAL

Remove the 4 bolts attaching the front fender bracket.

Remove the front fender.

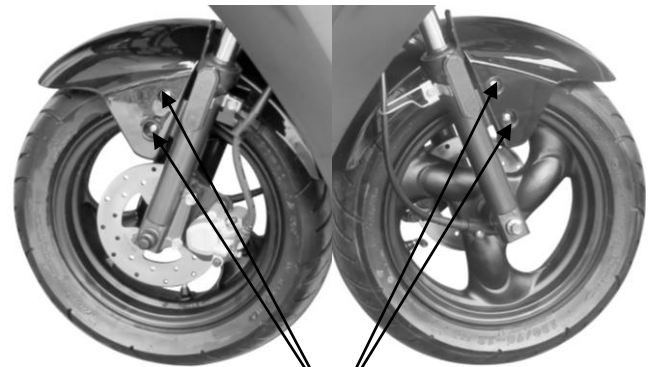

Bolts



#### Handlebar Cover Removal

Remove the 4 screws and 1 bolt attaching to the front handlebar cover.  
Remove the front handlebar cover

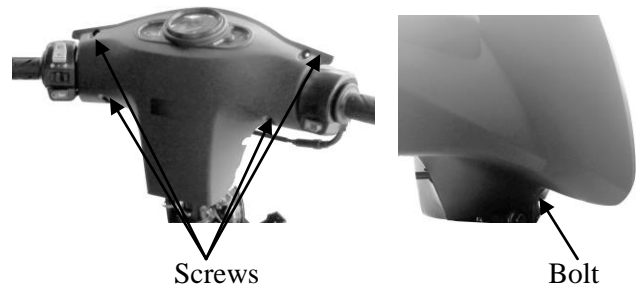

Remove the 2 screws and 1 bolt attaching to the rear handlebar cover.

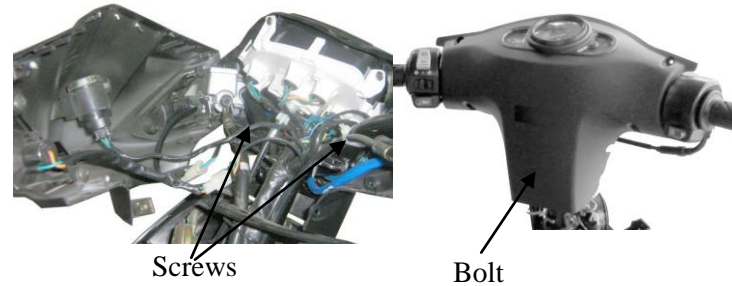

#### EXHAUST MUFFLER REMOVAL

Disconnect the O<sub>2</sub>sensor connector.  
Remove the two exhaust muffler joint lock nuts.  
Remove the 2 exhaust muffler lock bolts.  
Remove the exhaust muffler.  
Remove the exhaust muffler joint packing collar.

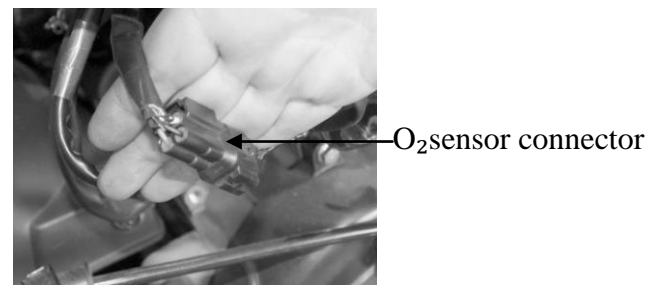

When installing, first install the exhaust muffler packing collar and then install the exhaust muffler.  
First install and tighten the exhaust muffler joint lock nuts. Then, install and tighten the exhaust muffler lock bolts.  
Connect the O<sub>2</sub>sensor connector.

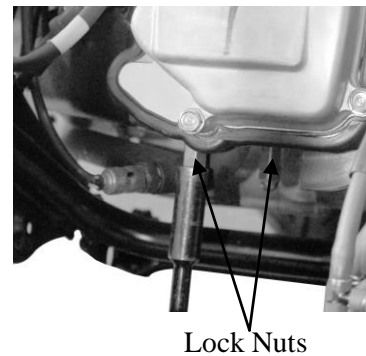

#### Torques:

Exhaust muffler lock bolt: 3.0~3.6kgf-m  
Exhaust muffler joint lock nut: 1.0~1.4kgf-m

\* Be sure to install a new exhaust muffler packing collar.

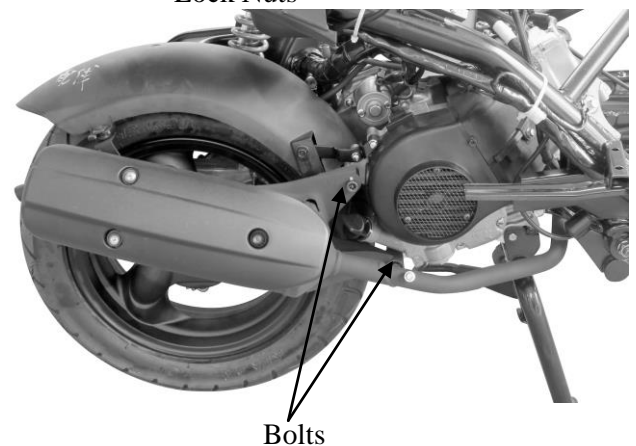

### 3. INSPECTION/ADJUSTMENT

**3**

<b>SERVICE INFORMATION.....3-0</b>	<b>FINAL REDUCTION GEAR OIL.....3- 7</b>
<b>MAINTENANCE SCHEDULE .....3-2</b>	<b>DRIVE BELT.....3- 7</b>
<b>FUEL FILTER.....3-3</b>	<b>BRAKE SHOE.....3- 8</b>
<b>THROTTLE OPERATION .....3-3</b>	<b>BRAKE ADJUSTING NUT.....3- 8</b>
<b>AIR CLEANER .....3-4</b>	<b>HEADLIGHT AIM .....3- 9</b>
<b>SPARK PLUG .....3-4</b>	<b>CLUTCH SHOE WEAR.....3- 9</b>
<b>VALVE CLEARANCE.....3-5</b>	<b>SUSPENSION .....3- 9</b>
<b>CARBURETOR IDLE SPEED .....3-5</b>	<b>NUTS/BOLTS/FASTENERS .....3-10</b>
<b>IGNITION TIMING .....3-6</b>	<b>WHEELS/TIRES.....3-10</b>
<b>CYLINDER COMPRESSION.....3-6</b>	<b>STEERING HANDLEBAR.....3-11</b>

#### SERVICE INFORMATION

##### GENERAL

 **WARNING**

- Before running the engine, make sure that the working area is well-ventilated. Never run the engine in a closed area. The exhaust contains poisonous carbon monoxide gas which may cause death to people.
- Gasoline is extremely flammable and is explosive under some conditions. The working area must be well-ventilated and do not smoke or allow flames or sparks near the working area or fuel storage area.

##### SPECIFICATIONS

###### ENGINE

- Throttle grip free play : 2~6mm
- Spark plug gap : 0.6~0.7mm
- Spark plug : NGK-CR6HSA
- Valve clearance : IN: 0.04mm  
: EX: 0.04mm
- Idle speed : 2000 ±100rpm
- Engine oil capacity:
  - At disassembly : 0.8 liter
  - At change : 0.7 liter
- Gear oil capacity :
  - At disassembly : 0.18 liter
  - At change : 0.15 liter

### 3. INSPECTION/ADJUSTMENT

---

Cylinder compression :  $15 \pm 2$  kg/cm<sup>2</sup>

Ignition timing: 20° ~ 29°

#### CHASSIS

Front brake free play: 10~20mm

Rear brake free play : 10~20mm

#### TIRE PRESSURE

	1 Rider	2 Riders
Front	1.75kg/cm <sup>2</sup>	1.75kg/cm <sup>2</sup>
Rear	2.0kg/cm <sup>2</sup>	2.25kg/cm <sup>2</sup>

#### TIRE SIZE:

Front : 120/70-12

Rear : 130/70-12

#### TORQUE VALUES

Front axle nut 5.0~7.0kgf-m

Rear axle nut 11~13kgf-m

### 3. INSPECTION/ADJUSTMENT

---

#### MAINTENANCE SCHEDULE

Perform the pre-ride inspection at each scheduled maintenance period. This interval should be judged by odometer reading or months, whichever comes first.

#### Maintenance schedule legend

I: INSPECT AND CLEAN, ADJUST, LUBRICATE OR REPLACE IF NECESSARY

C: CLEAN R: REPLACE A: ADJUST L: LUBRICATE T: TIGHTEN D:DIAGNOSE

The maintenance schedule specifies the maintenance required to keep your VP50 scooter in peak operating condition. Maintenance work should be performed in accordance with KYMCO standards and specifications by properly trained and equipped technicians. Your KYMCO dealer meets all of these requirements.

\* Should be serviced by your KYMCO dealer, unless you have the proper tools, service data and are technically qualified

\* In the interest of safety, we recommend these items be serviced only by your KYMCO dealer.

KYMCO recommends that your KYMCO dealer road test your scooter after each periodic maintenance service is completed.

#### Maintenance schedule notes :

1. At higher odometer readings, repeat at the frequency interval listed here.
2. Service more frequently if the scooter is ridden in unusually wet or dusty areas.
3. Service more frequently when riding in rain or at full throttle.
4. Clean every 1200 miles (2000 km) after replacement, and replace every 3000 miles (5000 km).
5. Replace every 1 year, or every 2400 miles (4000 km), whichever comes first. Replacement requires mechanical skill.
6. Replace every 6000 miles (10000 km). Replacement requires mechanical skill.
7. Replace every 2 years. Replacement requires mechanical skill.

### 3. INSPECTION/ADJUSTMENT

ITEM	FREQUENCY	WHICHEVER COMES FIRST	ODOMETER READING [NOTE(1)]								REFER TO PAGE
			→	0.3	1	3	5	7	9	11	
			×1000km	0.2	0.6	1.8	3	4.2	5.4	6.6	
NOTE	MONTH		3	6	12	18	24	30			
AIR CLEANER		NOTE2		I	R	I	R	I	R		
SPARK PLUGS		NOTE4				R					
THROTTLE OPERATION						I		I			
VALVE CLEARANCE			A		A		A		A		
FUEL LINE						I		I			
CRANKCASE BREATHER	NOTE3			C	C	C	C	C	C		
ENGINE OIL			R	R	R	R	R	R	R		
FI SYSTEM				D	D	D	D	C	D		
ENGINE OIL STRAINER SCREEN			C		C		C		C		
ENGINE DILE SPEED					I		I		I		
COOLING SYSTEM						I		I			
SECONDARY AIR SUPPLY SYSTEM						I		I			

ITEM	FREQUENCY	WHICHEVER COMES FIRST	ODOMETER READING [NOTE(1)]								REFER TO PAGE
			→	0.3	1	3	5	7	9	11	
			×1000km	0.2	0.6	1.8	3	4.2	5.4	6.6	
NOTE	MONTH		3	6	12	18	24	30			
TRANSMISSION OIL		NOTE5		R		R		R		R	
DRIVE BELT							I				
CLUTCH SHOE WEAR							I				
BRAKE FLUID		NOTE7			I	I	I	R	I		
BRAKE PAD WEAR				I	I	I	I	I	I		
BRAKE SYSTEM				I	I	I	I	I	I		
BRAKE LIGHT SWITCH						I		I			
SIDE STAND						I		I			
SUSPENSION						I		I			
HEADLIGHT AIM						I		I			
NUTS,BOLTS,FASTENERS			I			I		I			
WHEELS/TIRES				I	I	I	I	I	I		
STEERING BEARINGS			I			I		I			

### 3. INSPECTION/ADJUSTMENT

#### THROTTLE OPERATION

Check the throttle grip for smooth movement.  
Measure the throttle grip free play.

**Free Play:** 2~6mm

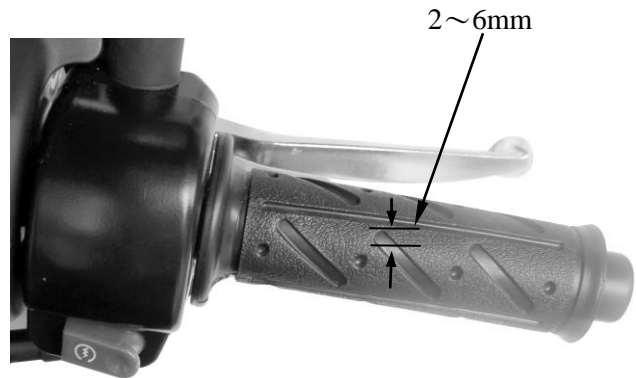

Major adjustment of the throttle grip free play is made at the throttle body..  
Adjust by loosening the lock nut and turning the adjusting nut.

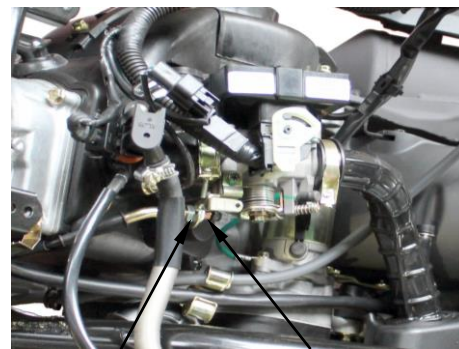

Lock Nut      Adjusting Nut

Minor adjustment is made with the adjusting nut at the throttle grip side.  
Slide the rubber cover out and adjust by loosening the lock nut and turning the adjusting nut.



Adjusting Nut      Lock Nut

### 3. INSPECTION/ADJUSTMENT

#### AIR CLEANER

##### AIR CLEANER REPLACEMENT

Remove the air cleaner case cover screws and the cover by removing the five screws.

Remove the air cleaner element by removing the four screws.

Check the element and replace it if it is excessively dirty or damaged.

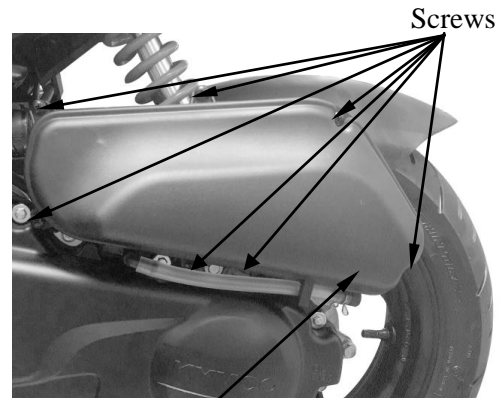

Air Cleaner Case Cover

##### CHANGE INTERVAL

More frequent replacement is required when riding in unusually dusty or rainy areas.

- \* The air cleaner element has a viscous type paper element. Do not clean it with any fluid.
- Be sure to install the air cleaner element and cover securely.

Air Cleaner Element



#### SPARK PLUG

Remove the spark plug.

Check the spark plug for wear and fouling deposits.

Clean any fouling deposits with a spark plug cleaner or a wire brush.

##### Specified Spark Plug:

NGK-CR6HSA

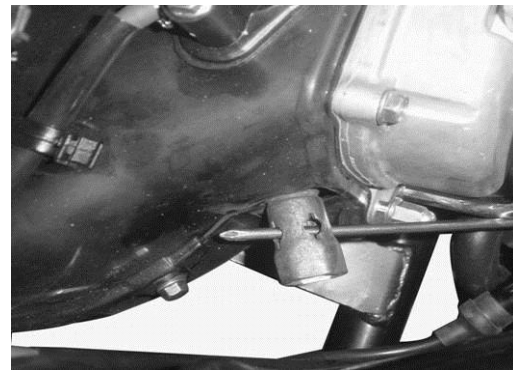

Measure the spark plug gap.

**Spark Plug Gap:** 0.6~0.7mm

- \* When installing, first screw in the spark plug by hand and then tighten it with a spark plug wrench.

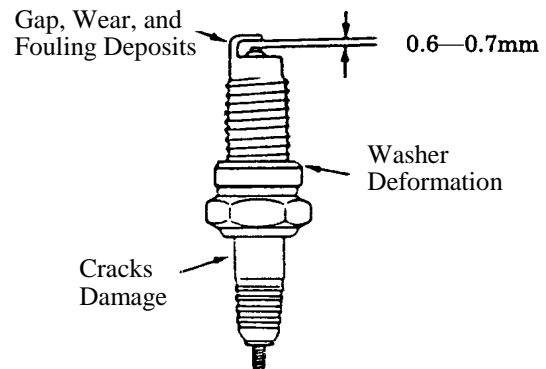



### 3. INSPECTION/ADJUSTMENT

#### VALVE CLEARANCE

\* Inspect and adjust valve clearance while the engine is cold (below 35°C).

- Remove the frame cover. (⇒2-3)
- Remove the four bolts on the cylinder head cover.
- Remove the cylinder head cover. (⇒7-3)
- Remove the cylinder head cover..

Cylinder Head Cover

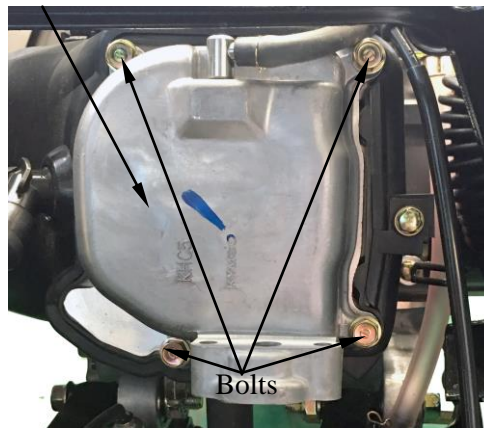

Turn the flywheel counterclockwise so that the “T” mark on the flywheel aligns with the index mark on the crankcase to bring the round hole on the camshaft gear facing up to the top dead center on the compression stroke.

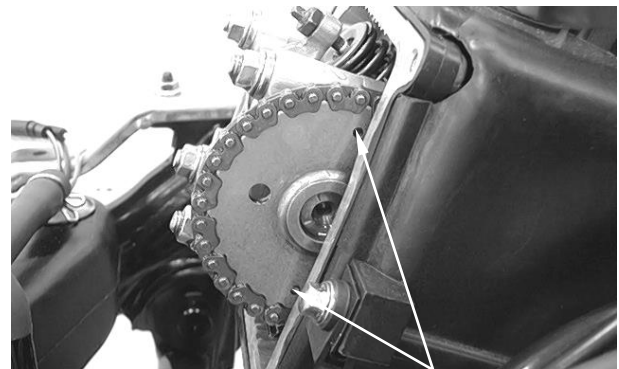

Round Hole

Inspect and adjust the valve clearance.

**Valve Clearance:** IN : 0.04mm  
EX: 0.04mm

Loosen the lock nut and adjust by turning the adjusting nut

Special

Tappet Adjuster

\* • Check the valve clearance again after the lock nut is tightened.

Tappet Adjuster

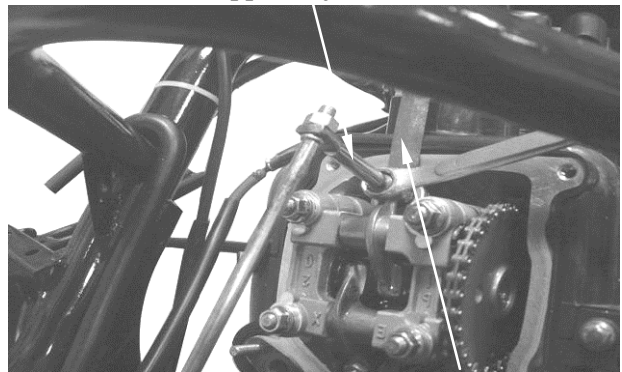

Feeler Gauge



### 3. INSPECTION/ADJUSTMENT

#### IGNITION TIMING

Remove the right of the fan cover.

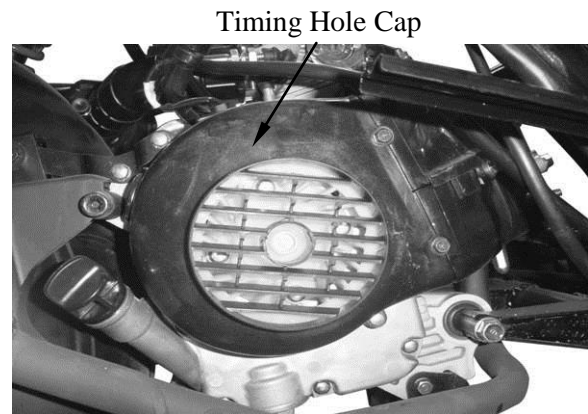

Check the ignition timing with a timing light. When the engine is running at idle speed, the ignition timing is correct if the "F" mark on the flywheel aligns with the index mark on the crankcase.

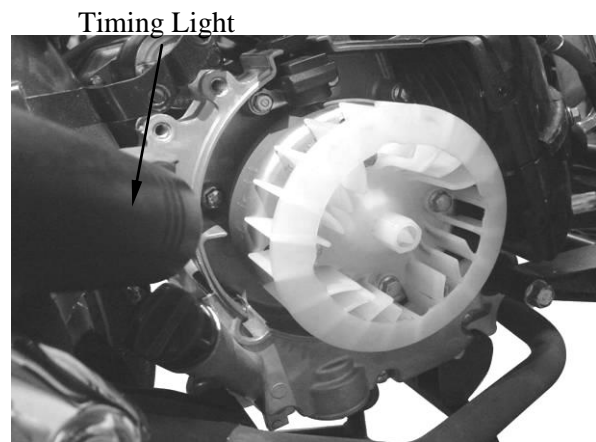

Also use a timing light to check the advance. Raise the engine speed to 4,000rpm and the index mark on the crankcase cover should be aligned with the advance mark on the flywheel.

#### CYLINDER COMPRESSION

Warm up the engine before compression test. Remove the met-in box and center cover. (⇒2-3)

Remove the spark plug.

Insert a compression gauge.

Open the throttle valve fully and push the starter button to test the compression.

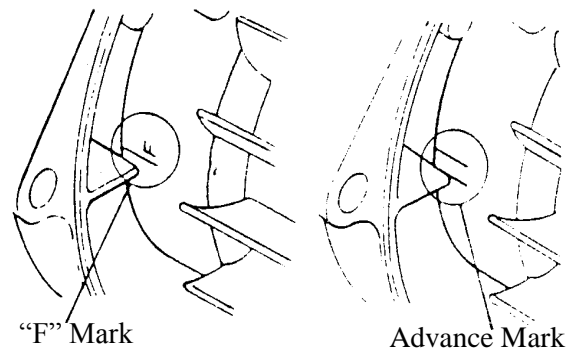

**Compression:**  $15 \pm 2 \text{kg/cm}^2$  rpm

If the compression is low, check for the following:

- Leaky valves
- Valve clearance too small
- Leaking cylinder head gasket
- Worn piston rings
- Worn piston/cylinder

If the compression is high, it indicates that carbon deposits have accumulated on the combustion chamber and the piston head.

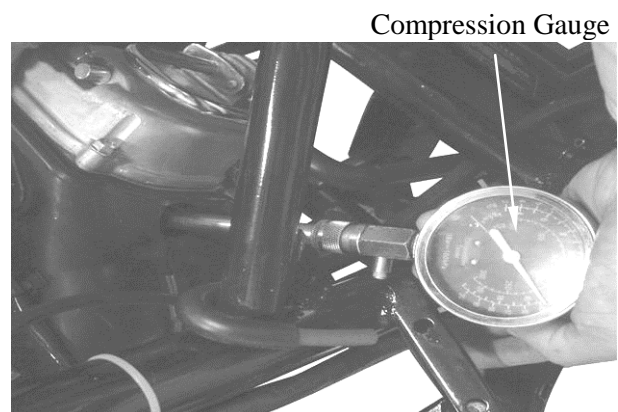

### 3. INSPECTION/ADJUSTMENT

#### FINAL REDUCTION GEAR OIL OIL LEVEL CHECK

- \* Place the motorcycle on its main stand on level ground for oil level check.

Stop the engine and remove the oil check bolt. The oil level shall be at the oil check bolt hole.

If the oil level is low, add the recommended oil to the proper level.

**Recommended Oil: SAE90#**

Install the oil check bolt.

- \* Make sure that the sealing washer is in good condition.



Oil Check Bolt/Sealing Washer

#### OIL CHANGE

Remove the oil check bolt.

Remove the oil drain bolt and drain the oil thoroughly.

Install the oil drain bolt.

**Torque: 0.8~1.2kgf-m**

- \* Make sure that the sealing washer is in good condition.

Fill with the recommended oil.

**Oil Capacity:** At disassembly : 0.18 liter  
At change : 0.15 liter

Reinstall the oil check bolt and check for oil leaks.

**Torque:0.8~1.2kgf-m**



Oil Drain Bolt/ Sealing Washer

#### DRIVE BELT

Remove the left crankcase cover. (⇒9-2)

Inspect the drive belt for cracks or excessive wear.

Replace the drive belt with a new one if necessary and in accordance with the Maintenance Schedule.

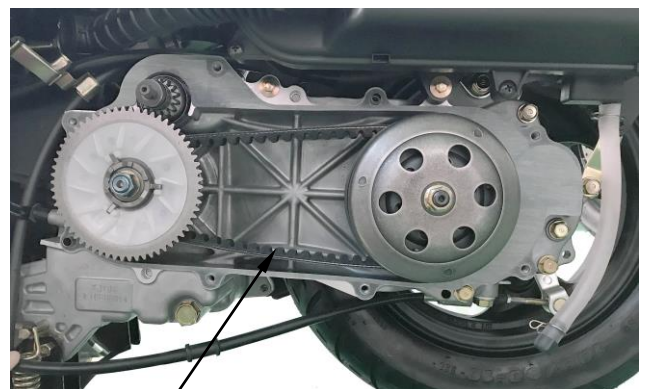

Drive Belt

### 3. INSPECTION/ADJUSTMENT

#### BRAKE SHOE

Replace the brake shoes if the arrow on the wear indicator plate aligns with the punch mark on the brake panel when the brake is fully applied.

Refer to page 12-7 and 13-3 for brake shoe replacement.

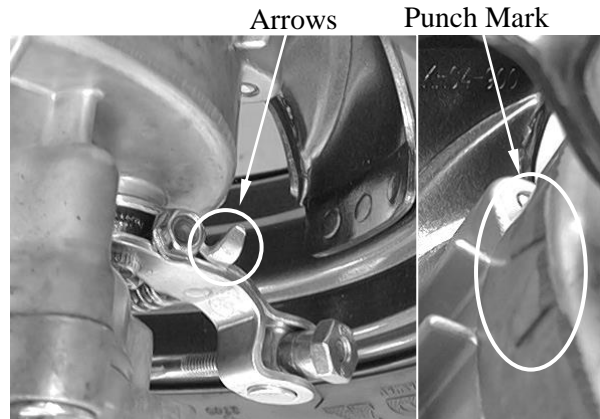

#### REAR BRAKE

Measure the rear brake lever free play.

**Free Play:** 10~20mm



#### BRAKE ADJUSTING NUT

If the free play do not fall within the limit, adjust by turning the adjusting nut.

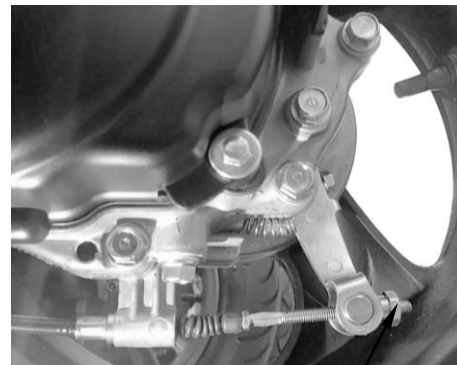

Adjusting Nut

#### BRAKE FLUID

Turn the steering handlebar upright and check if the rear brake fluid level should be between the upper and lower level lines.

**Specified Brake Fluid:** DOT-4 ◦

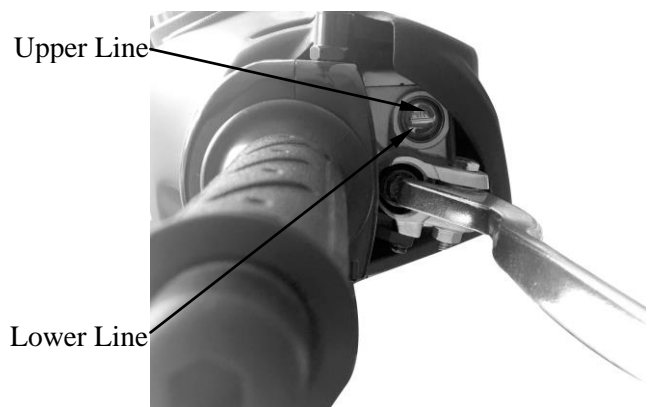

### 3. INSPECTION/ADJUSTMENT

If the free play do not fall within the limit, adjust by turning the adjusting nut.



Adjusting Nut

#### HEADLIGHT AIM

Turn the ignition switch ON and start the engine.

Adjust the headlight aim by turning the headlight aim adjusting screw.



Adjusting Screw

#### CLUTCH SHOE WEAR

Start the engine and check the clutch operation by increasing the engine speed gradually.

If the motorcycle tends to creep, or the engine stalls, check the clutch shoes for wear and replace if necessary. (⇒9-11)

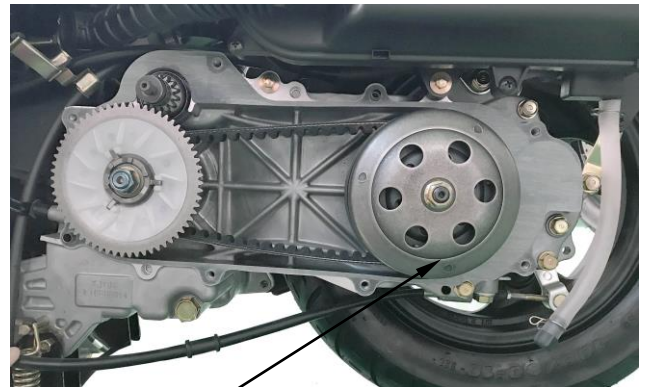

clutch

#### SUSPENSION

##### FRONT

Fully apply the front brake lever and check the action of the front shock absorbers by compressing them several times. Check the entire shock absorber assembly for oil leaks, looseness or damage.



### 3. INSPECTION/ADJUSTMENT

#### REAR

Check the action of the rear shock absorber by compressing it several times.  
 Check the entire shock absorber assembly for oil leaks, looseness or damage.  
 Jack the rear wheel off the ground and move the rear wheel sideways with force to see if the engine hanger bushings are worn.



#### NUTS/BOLTS/FASTENERS

Check all important chassis nuts and bolts for looseness.  
 Tighten them to their specified torque values if any looseness is found. (⇒1-11)

#### WHEELS/TIRES

Check the tires for cuts, imbedded nails or other damages.

Check the tire pressure.



\* Tire pressure should be checked when tires are cold.

#### TIRE PRESSURE

	1 Rider	2 Riders
Front	1.75kg/cm <sup>2</sup>	1.75kg/cm <sup>2</sup>
Rear	2.00kg/cm <sup>2</sup>	2.25kg/cm <sup>2</sup>

#### TIRE SIZE

**Front** : 120/70-12

**Rear** : 130/70-12

Check the front axle nut for looseness.  
 Check the rear axle nut for looseness.  
 If the axle nuts are loose, tighten them to the specified torques.

**Torques: Front** : 5.0~7.0kgf-m

**Rear** : 11~13kgf-m



Front Axle Nut

### 3. INSPECTION/ADJUSTMENT

---

#### STEERING HANDLEBAR

Check that the control cables do not interfere with handlebar rotation.

Raise the front wheel off the ground and check that the steering handlebar rotates freely.

If the handlebar moves unevenly, binds, or has vertical movement, adjust the steering head bearing.

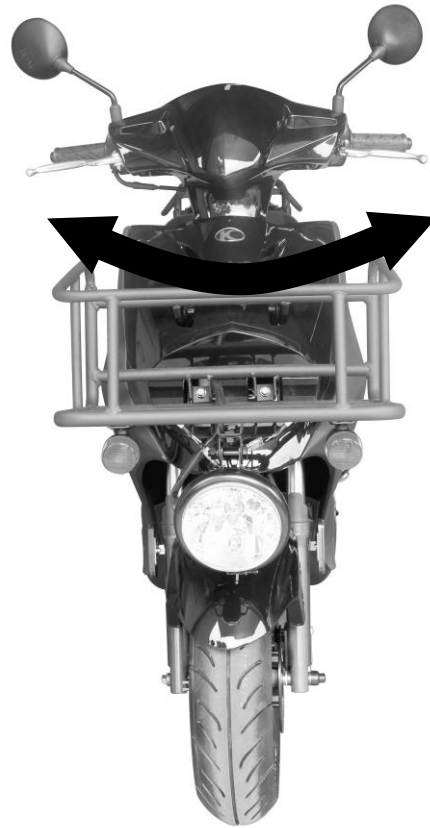

# 4. LUBRICATION SYSTEM

## LUBRICATION SYSTEM

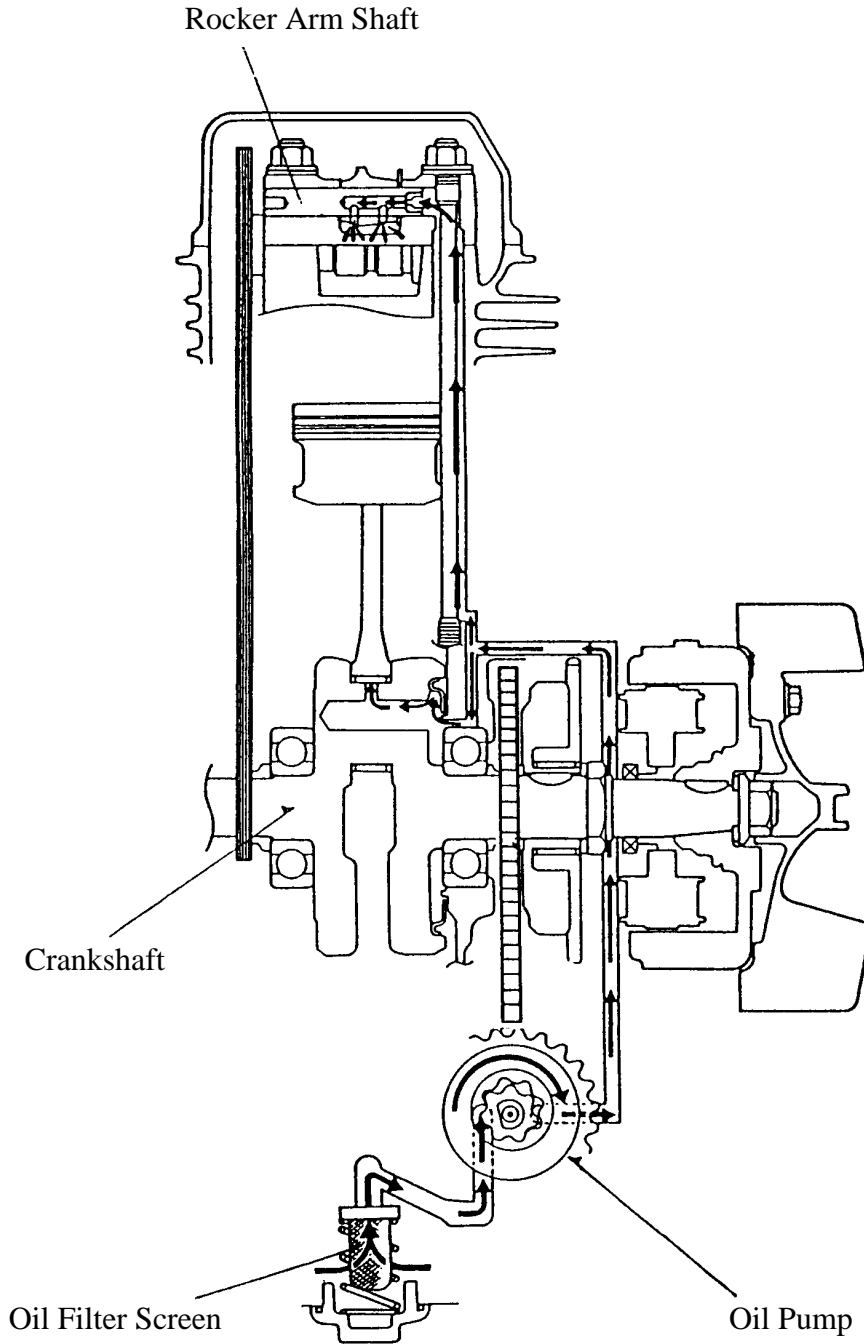

4

# 4. LUBRICATION SYSTEM

SERVICE INFORMATION.....4-1	ENGINE OIL/OIL FILTER..... 4-2
TROUBLESHOOTING .....4-1	OIL PUMP..... 4-3

## SERVICE INFORMATION

### GENERAL INSTRUCTIONS

- The maintenance of lubrication system can be performed with the engine installed in the frame.
- Use care when removing and installing the oil pump not to allow dust and foreign matters to enter the engine and oil line.
- Do not attempt to disassemble the oil pump. The oil pump must be replaced as a set when it reaches its service limit.
- After the oil pump is installed, check each part for oil leaks.

### SPECIFICATIONS

Item		Standard (mm)	Service Limit (mm)
Oil pump	Inner rotor-to-outer rotor clearance	—	0.12
	Outer rotor-to-pump body clearance	—	0.12
	Rotor end-to-pump body clearance	0.05~0.10	0.2

## TROUBLESHOOTING

### Oil level too low

- Natural oil consumption
- Oil leaks
- Worn or poorly installed piston rings
- Worn valve guide or seal

### Poor lubrication pressure

- Oil level too low
- Clogged oil filter or oil passages
- Not use the specified oil



## 4. LUBRICATION SYSTEM

### ENGINE OIL/OIL FILTER

#### OIL LEVEL

- \* Place the motorcycle upright on level ground for engine oil level check.
- Run the engine for 2~3 minutes and check the oil level after the engine is stopped for 2~3 minutes.

Remove the oil dipstick and check the oil level with the oil dipstick.  
If the level is near the lower level, fill to the upper level with the specified engine oil.

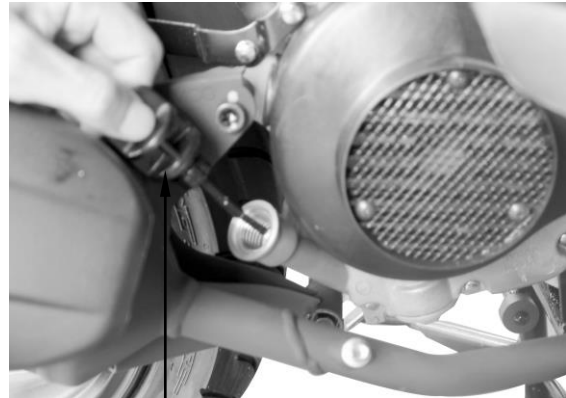

Oil Dipstick

#### OIL CHANGE

- \* The engine oil will drain more easily while the engine is warm.

Remove the drain bolt to drain the engine oil thoroughly.  
Remove the oil filter screen cap and clean the oil filter screen with compressed air.



Oil Filter Screen Cap

Check the filter screen O-ring for damage and replace if necessary.

Install the oil filter screen, spring and filter screen cap.

**Torque:** 1.0~2.0kgf-m

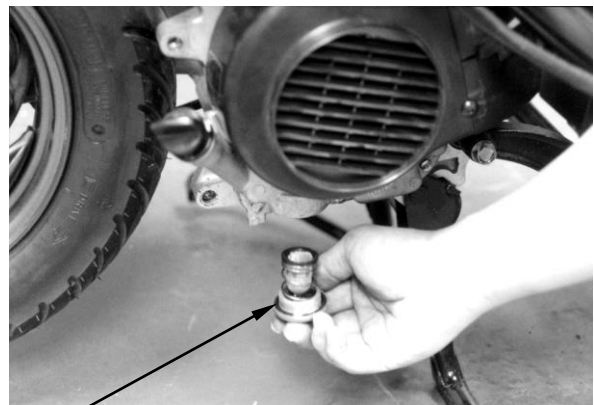

O-ring

Fill the crankcase with the specified engine oil to the proper level.

Oil Capacity: At disassembly : 0.8 liter

At change : 0.7 liter

Check for oil leaks and then start the engine and let it idle for few minutes.

Recheck the oil level.

## 4. LUBRICATION SYSTEM

### OIL PUMP

#### REMOVAL

Remove the A.C. generator flywheel. (⇒14-7)

Remove the A.C. generator stator and pulsar coil. (⇒14-6)

Remove the eight right crankcase cover bolts and the right crankcase cover.

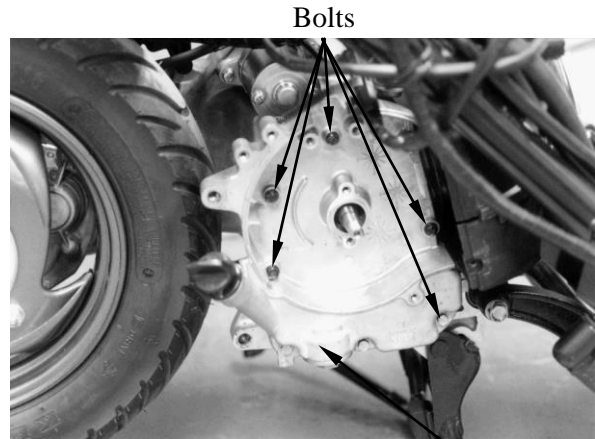

Bolts

Remove the gasket and dowel pins.

Remove the oil pump drive gear circlip.

Remove the oil pump gear.

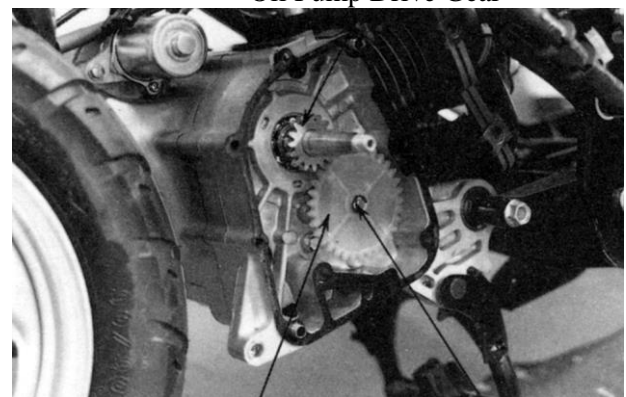

Right Crankcase Cover

Oil Pump Drive Gear

Oil Pump Gear

Remove the oil pump mounting bolts.

Remove the oil pump.

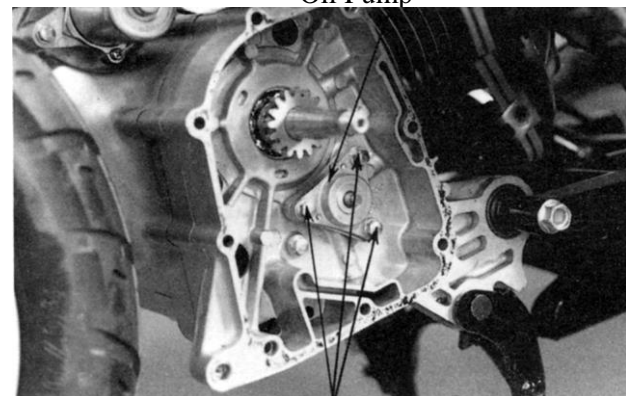

Circlip

Oil Pump

Remove the two O-rings.

Inspect the two O-rings for damage or deterioration.

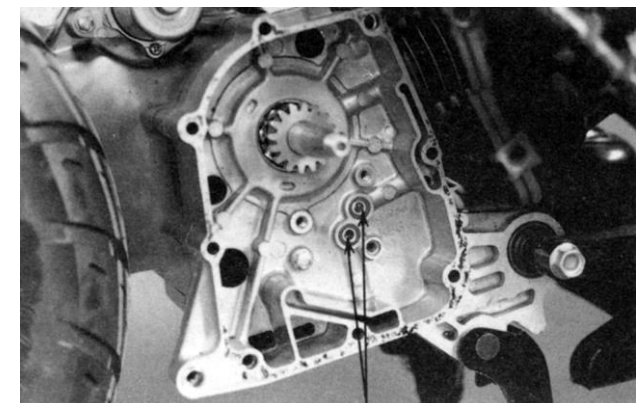

Bolts

O-rings

## 4. LUBRICATION SYSTEM

### DISASSEMBLY

Remove the three oil pump boby screws.  
Disassembly the oil pump.

Oil Pump Bobby

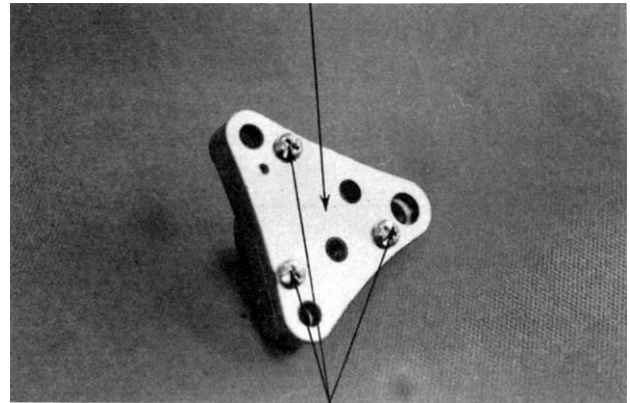

Screws

### INSPECTION

Measure the pump boby-to-outer rotor clearance.

**Service Limit:** 0.12mm

Outer Rotor

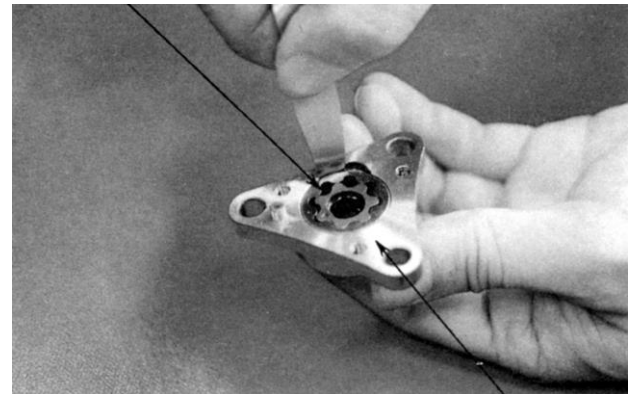

Oil Pump Bobby

Measure the inner rotor-to-outer rotor clearance.

**Service Limit:** 0.12mm

Outer Rotor

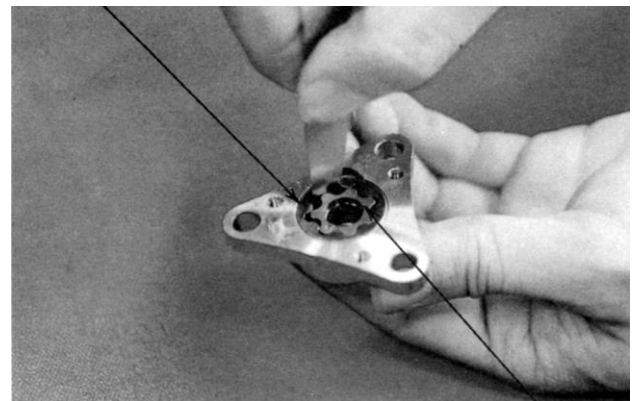

Inner Rotor

Measure the rotor end-to- pump boby clearance.

**Service Limit:** 0.2mm

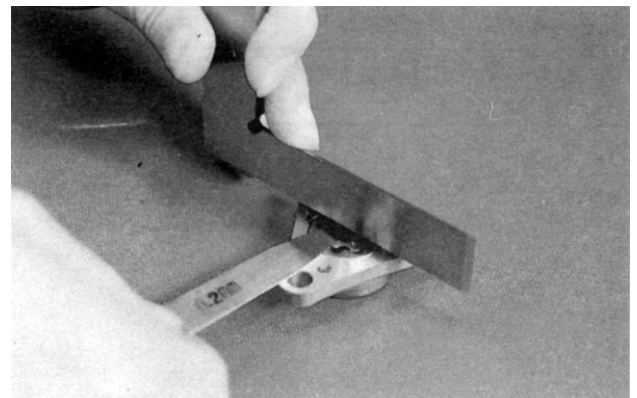

## 4. LUBRICATION SYSTEM

### ASSEMBLY

Install the outer rotor, inner rotor and pump shaft into the pump body.

\* Install the pump shaft by aligning the flat on the shaft with the flat in the inner rotor.

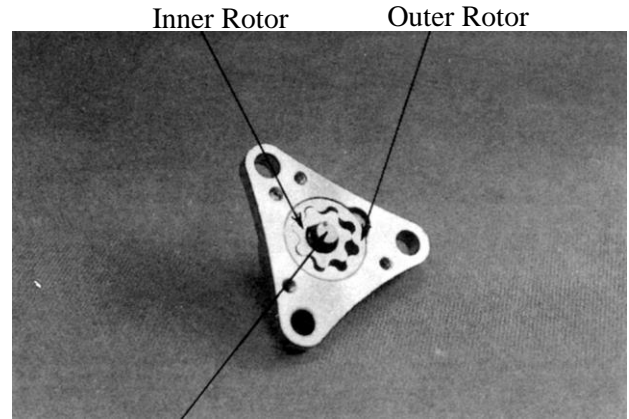

Pump Shaft

Install the pump cover and tighten the screws to secure the pump cover.

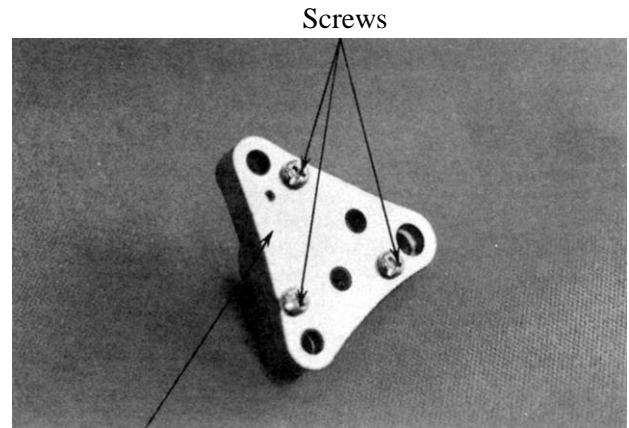

Pump Cover

### INSTALLATION

First install the two O-rings onto the oil pump base.

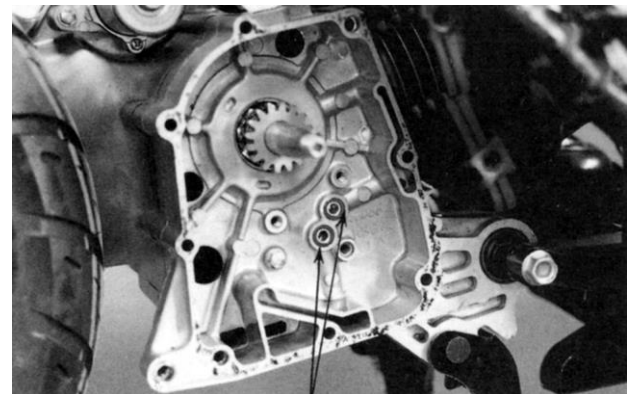

O-rings

Install the oil pump into the crankcase.

\* Fill the oil pump with engine oil before installation.

After the oil pump is installed, tighten the three mounting bolts.

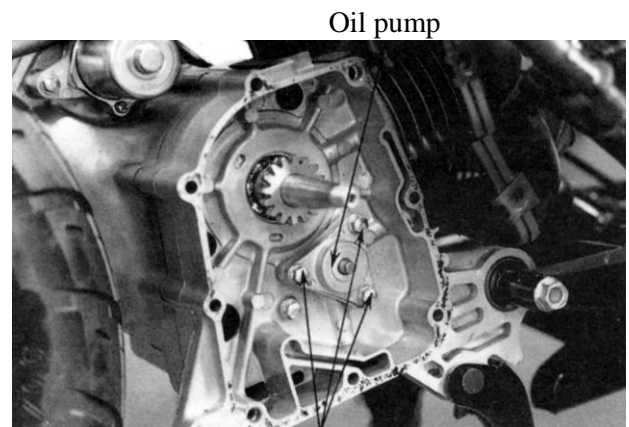

Bolts

## 4. LUBRICATION SYSTEM

Install the pump driven gear and secure it with the circlip.

**Torque:** 0.8~1.2kg-m

Pump Driven Gear



Circlip

Install the right crankcase cover and tighten the eight bolts.

**Torque:** 0.8~1.2kgf-m

\* Diagonally tighten the bolts in 2~3 times.

Right Crankcase Cover

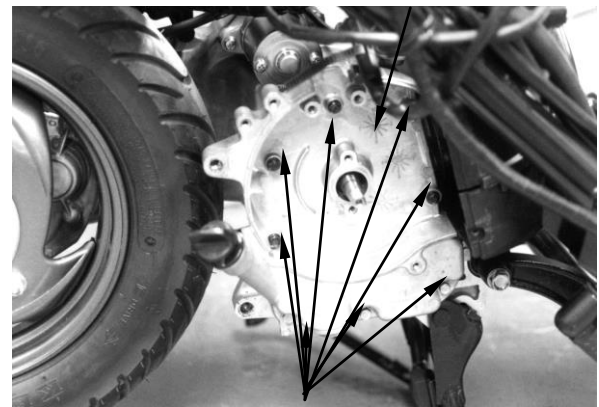

Bolts

**FUEL INJECTION SYSTEM****5**

SYSTEM DIAGRAM .....	5 - 1
SYSTEM LOCATION.....	5 - 2
SERVICE INFORMATION .....	5 - 3
TROUBLESHOOTING .....	5 - 4
CHECK ENGINE LAMP (CELP).....	5 - 5
HOW TO SHOW THE FAILURE CODE.....	5 - 6
FAILURE CODES CHART .....	5 - 7
ECU .....	5-11
FUEL PUMP .....	5-12
T-MAP & TPS.....	5-13
ETS .....	5-14
INJECTOR .....	5-14
O <sub>2</sub> SENSOR.....	5-15
ROLL SENSOR .....	5-16

**5. FUEL INJECTION SYSTEM**

Agility Carry / Delivery 50i

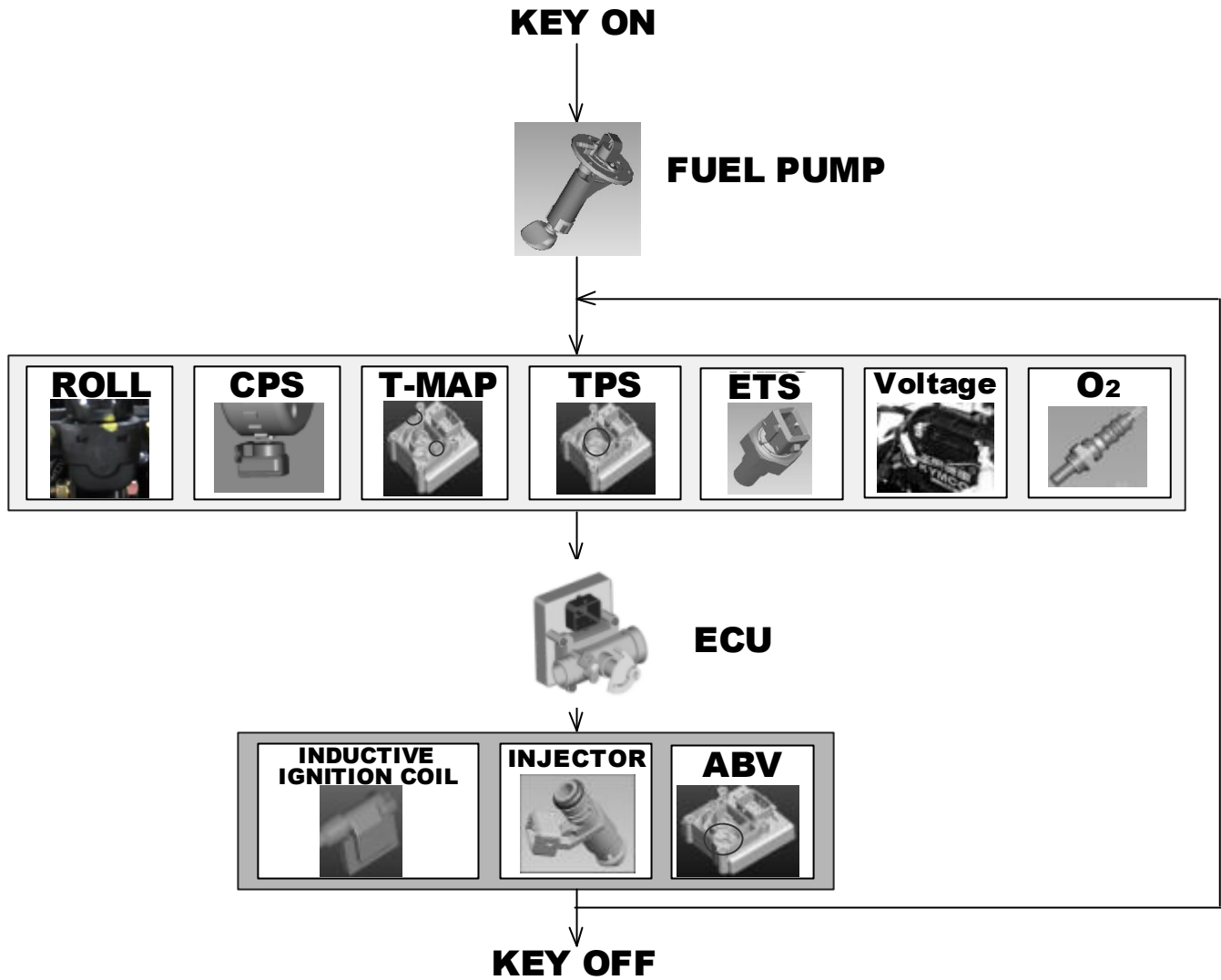

**SYSTEM DIAGRAM**



**5. FUEL INJECTION SYSTEM**

Agility Carry / Delivery 50i

**Parts Location**

- 01: Inductive ignition coil**
- 02: Fuel pump**
- 03: ECU**
- 04: Fuel injector**
- 05: ETS sensor**
- 06: T-MAP sensor**
- 07: ABV**
- 08: TPS**
- 09: Roll sensor**
- 10: CPS**
- 11: O2/O2 HT sensor**

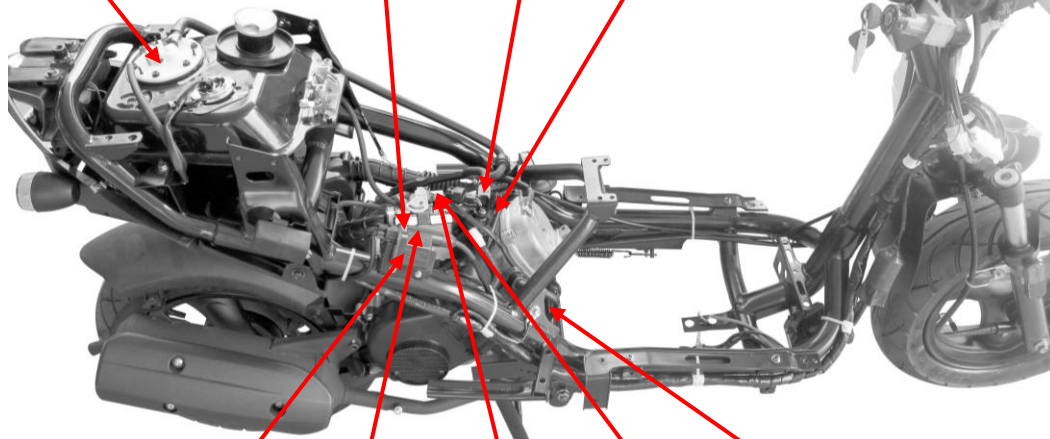
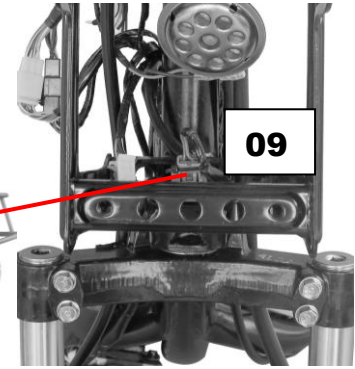
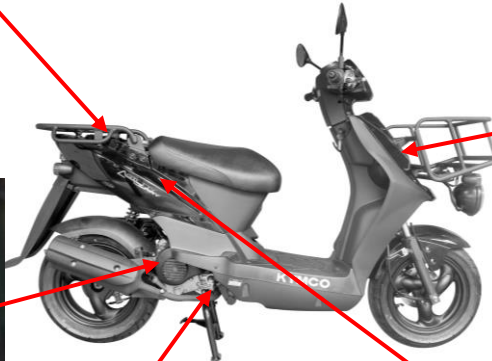
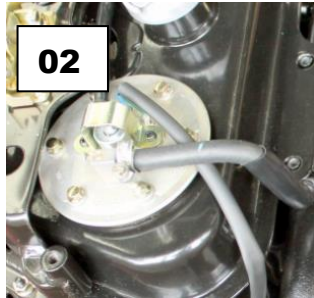



### SERVICE INFORMATION

#### GENERAL INSTRUCTIONS

\* Gasoline is very dangerous. When working with gasoline, keep sparks and flames away from the working area.  
Gasoline is extremely flammable and is explosive under certain conditions. Be sure to work in a well-ventilated area.

- Disconnect the cables of the battery when the engine is running, which could lead to ECU damage.
- Connect the harness positive (+) cable to the battery negative (-) terminal or connect the harness negative (-) to the battery positive (+) terminal, which could lead to ECU damage.
- Always keep fuel over 750 cc in fuel tank.

#### SPECIFICATIONS

Item		Standard	
Charging voltage of battery		13.5 ~ 14.5V	
Voltage from the ECU to sensor		5±0.1V	
Fuel injector resistance (20 °C/68 °F)		10.6 ~ 15.9Ω	
Temperature sensor resistance		10--12 KΩ (25 °C)	
Throttle position sensor voltage		Idle (0 °) = 0.23±0.05V Throttle fully (90 °/3.27V over)	
Fuel pump resistance (20 °C/68 °F)		F: about 33Ω E: about 566Ω	
O2 sensor	O2 sensor heater resistance	6.7 ~ 9.5Ω	
	Voltage	Air/Fuel<14.7 (Rich)	>0.7V
		Air/Fuel>14.7 (Lean)	<0.18V
Crank position sensor (Pulser) resistance		95 ~ 144Ω	
Inductive ignition coil resistance (20 °C/68 °F)		0.55 ~ 0.75Ω	
Roll sensor voltage (diagnostics)		Normal: 0.3 ~ 1.4V Fall down (>65 °): 3.5 ~ 4.7V	
Idle speed		2000±100 rpm	

**TROUBLESHOOTING****Engine won't start**

- Battery voltage too low
- Fuel level too low
- Pinched or clogged fuel hose
- Faulty fuel pump operating system
- Clogged fuel filter (fuel pump)
- Clogged fuel injector
- Faulty spark plug or wrong type
- Cut by ECU due to angle detect sensor or incorrect function

**Backfiring or misfiring during acceleration**

- Ignition system malfunction

**Poor performance (drive ability) and poor fuel economy**

- Pinched or clogged fuel hose
- Faulty fuel injector

**Engine stall, hard to start, rough idling**

- Intake air leak
- Fuel contaminated/deteriorated
- Pinched or clogged fuel hose
- Idle speed misadjusted

## 5. FUEL INJECTION SYSTEM

Agility Carry / Delivery 50i

### CHECK ENGINE LAMP (CELP)

- When turning on the switch, the lamp will be lighted for 2 seconds then off. Let user to know the lamp is available and connect to ECU.
- But after then or during riding, if the CELP start to blink or keep lighting, it means something wrong with this vehicle, you better do the further check to find out the failure code to know which part get trouble
- There are three kinds of priority grade let user to know what kind of trouble was happened.
- Priority grade 1: CELP blinks continuously. This is the most emergent situation like engine over heat. User should be slow down the riding and go to dealer for checking.
- Priority grade 2: CELP lights all the time. It means components gets trouble or circuit something wrong. Do the further check to find out the failure code to know which part get trouble.
- Priority grade 3: CELP just blinks once suddenly and then disappear. It sometimes just warning like the RPM was too high in a short term.

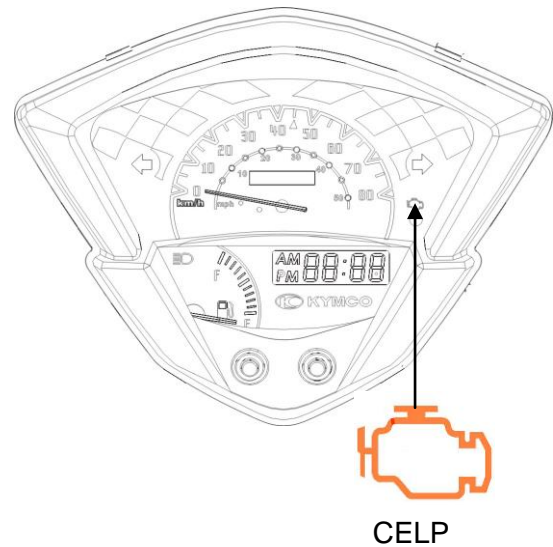
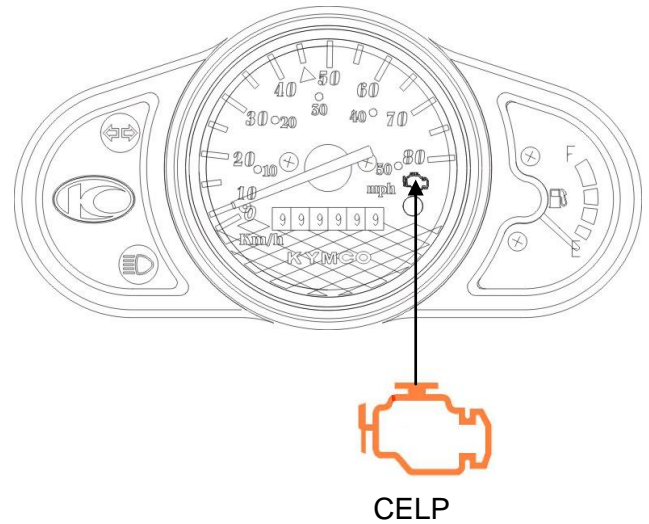

PRIORITY	LAMP ACTION
1	<p>ON</p> <p>OFF</p>
2	<p>ON</p> <p>OFF</p>
3	<p>ON</p> <p>OFF</p>

## 5. FUEL INJECTION SYSTEM

Agility Carry / Delivery 50i

### How To Show Failure Code

- You can read the failure code by as below :
- Turn switch on. The CELP will be lighted for 2 seconds then off. The CELP start to blink to show the failure codes
- (The number of blinks from 1 to 25).
- If vehicle got more than one failure code, the CELP will be shown from lower number failure code and then show the other higher number one after four seconds. All the failure codes would be shown repeatedly.

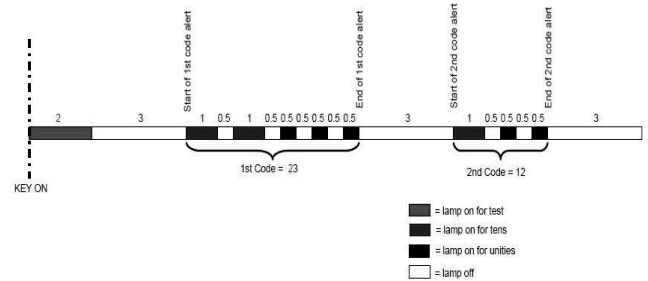

### How To Reset Failure Code

- After repairing the trouble, you should clear the failure code or it will still exist in the ECU memory. When you do a next maintain, it will show again and you get confuse.
- Turn switch on. The CELP will be lighted for two seconds then off.
- The CELP begins to blink to show the failure codes.
- The self-diagnosis memory data will be erased when all the failure codes has showed for four cycles.

**Failure Code Chart**

Blink	Failure Codes	Fault description	Priority	Fault management
1	P0217	Engine temperature overheat	1	1.Slow down the vehicle and go to workshop for checking immediately. 2.Confirm if the engine temperature sensor or electric circuit is abnormality.
2	P0335	Crankshaft position sensor or circuit malfunction	2	1.Check if the connector of crankshaft position sensor is loosen. 2.Check if the Rotor is align with Crankshaft position sensor during the crankshaft running.
3	P1120	Throttle position sensor setting value problem	2	1.Make sure if the connector of Throttle position sensor is connected correctly. 2.Check if the Throttle position sensor is adjusted.
4	P1121	Throttle position sensor output range problem	2	1.Make sure if the connector of Throttle position sensor is connected correctly. 2.Check if the Throttle position sensor is adjusted.

## 5. FUEL INJECTION SYSTEM

Agility Carry / Delivery 50i

### Failure Code

Blink	Failure Codes	Fault description	Priority	Fault management
5	P1122	Throttle position sensor movement speed problem	2	<ol style="list-style-type: none"> <li>1. Make sure if the connector of Throttle position sensor is connected correctly.</li> <li>2. Check if the Throttle position sensor is adjusted.</li> </ol>
6	P0560	Battery voltage malfunction	1	<ol style="list-style-type: none"> <li>1. Check if the battery voltage is lower or higher.</li> <li>2. Check if the charge system is malfunction.</li> </ol>
7	P0110	Inlet air temperature sensor or electric circuit malfunction	2	<ol style="list-style-type: none"> <li>1. Check if the connector of Inlet air temperature sensor loosen.</li> <li>2. Check if the resistance of sensor is normal .</li> </ol>
8	P0410	Idle air valve or electric circuit malfunction	2	<ol style="list-style-type: none"> <li>1. Check if the connector of Idle air valve loosen.</li> <li>2. Check if the resistance of valve is normal.</li> </ol>
9	P0505	Idle speed volume control range	2	<ol style="list-style-type: none"> <li>1. Check if the opening angle is over 180° for Idle air valve.</li> <li>2. Check if the opening angle is malfunction.</li> </ol>
10	P0251	Injector or electric circuit	2	<ol style="list-style-type: none"> <li>1. Check if the connector of Injector is loosen.</li> <li>2. Check if the ECU send signal to Injector.</li> <li>3. Check if the power source and resistance of Injector are malfunction.</li> </ol>

## 5. FUEL INJECTION SYSTEM

Agility Carry / Delivery 50i

### Failure Code

Blink	Failure Codes	Fault description	Priority	Fault management
11	P0350	Ignition coil or electric circuit malfunction	2	<ol style="list-style-type: none"> <li>1. Check if the connector of ignition coil is loosen.</li> <li>2. Check if the ECU send signal to Ignition coil.</li> <li>3. Check if the power source and resistance is malfunction.</li> </ol>
12	P0230	Fuel pump relay or electric circuit malfunction	2	<ol style="list-style-type: none"> <li>1. Check if the connector of relay is loosen.</li> <li>2. Check if the ECU send signal to relay.</li> <li>3. Check the fuel pump relay resistance</li> </ol>
13	P0219	Engine speed is over than top speed	2	Check if the belt of CVT is broken.
14	P1560	Sensor don't receive power source from ECU	2	<ol style="list-style-type: none"> <li>1. Check if ECU output DC5V to sensor.</li> <li>2. Check if the power source of all sensor is DC5V.</li> <li>3. Replace a new ECU if the CELP still blinks even the output power source of ECU is normal.</li> </ol>
15	P0700	Engine starting speed exceed CVT speed limited	2	<ol style="list-style-type: none"> <li>1. Check if the throttle wire locked.</li> <li>2. Check if the position of throttle screw is correct.</li> <li>3. Check if the belt of CVT is broken.</li> </ol>
16	P0115	Engine temperature sensor or electric circuit malfunction	2	<ol style="list-style-type: none"> <li>1. Check if the connector of sensor is loosen.</li> <li>2. Check if ECU pin is broken.</li> <li>3. Check if the resistance of sensor is malfunction.</li> </ol>
17	P1561	Temperature gauge electric circuit malfunction	2	Don't use it at present.

## 5. FUEL INJECTION SYSTEM

Agility Carry / Delivery 50i

### Failure Code

Blink	Failure Codes	Fault description	Priority	Fault management
18	P0650	CELP electric circuit malfunction	3	<ol style="list-style-type: none"> <li>1. Check if the lamp of CELP is broken.</li> <li>2. Check if wires of CELP is broken.</li> </ol>
21	P0105	Atmospheric Pressure Sensor or electric Circuit Malfunction	2	<ol style="list-style-type: none"> <li>1. Check if the connector of sensor is loosen.</li> <li>2. Check if ECU pin is broken.</li> <li>3. Check if voltage of sensor is fit in specification.</li> </ol>
22	P1110	Roll sensor or electric circuit malfunction	2	<ol style="list-style-type: none"> <li>1. Check if the sensor installation direction is correct.</li> <li>2. Check if voltage of sensor is fit in specification.</li> <li>3. Check if ECU pin is broken.</li> </ol>
23	P0136	O2 sensor malfunction	1	<ol style="list-style-type: none"> <li>1. Check if the connector of sensor is loosen.</li> <li>2. Check if ECU pin is broken.</li> </ol>
24	P0141	O2 sensor heater malfunction	1	<ol style="list-style-type: none"> <li>1. Check if the connector of sensor is loosen.</li> <li>2. Check if ECU pin is broken.</li> <li>3. Check if the resistance of sensor is malfunction.</li> </ol>
25	P0171	O2 sensor electric circuit malfunction	1	<ol style="list-style-type: none"> <li>1. Check if the connector of sensor is loosen.</li> <li>2. Check if O2 sensor is blocked.</li> <li>3. Don't follow a routine maintenance.</li> </ol>



## 5. FUEL INJECTION SYSTEM

Agility Carry / Delivery 50i

### ECU

There are 36 pins attaching the ECU.  
Part number: 3920A-LHB6-900

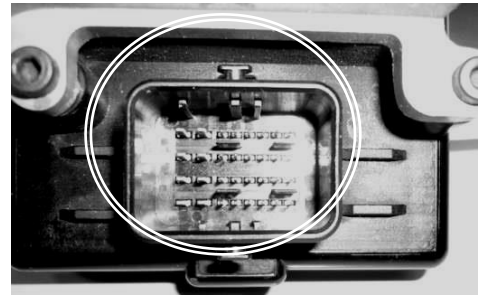

### Voltage inspection

Connect the meter (+) probe to the F4(R/W) wire  
and the meter (-) probe to the H4(G/B) wire to  
measure the voltage.



MAP content (edition issue no.)

Model name:	ALC9
Calib- rate:	E4ALC9E4TB
Soft- ware:	QK0A00

## **5. FUEL INJECTION SYSTEM**

**Agility Carry / Delivery 50i**

### **FUEL PUMP**

Connect the meter (+) probe to the red/black wire and the meter (-) probe to the green wire to measure the voltage from the ECU input to fuel pump unit.

Standard : 8~16 V (Battery volt)

To measure the resistance of the fuel pump to see if it is short circuit or not.



## 5. FUEL INJECTION SYSTEM

Agility Carry / Delivery 50i

### T-MAP(Manifold Air Temperature Pressure) Sensor

Connect the PDA or Fi diagnostic tool.

Enter the Data Analyze

Check if the manifold pressure data is malfunction.

Turn the ignition switch to the “ON” position.

If data is incorrect, and the T-map sensor is problem.

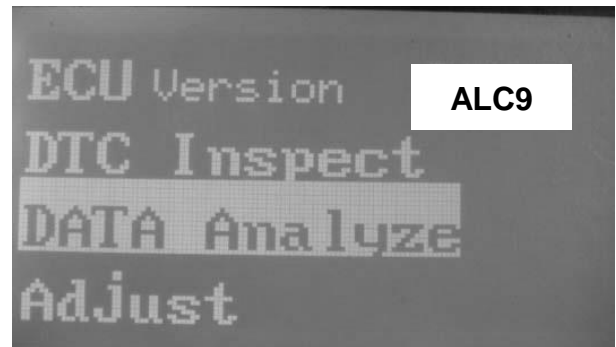

**Standard : 101.3 ±3 kpa on sea altitude**

The ambient pressure drop is about **12Kpa** according to the altitude raises.

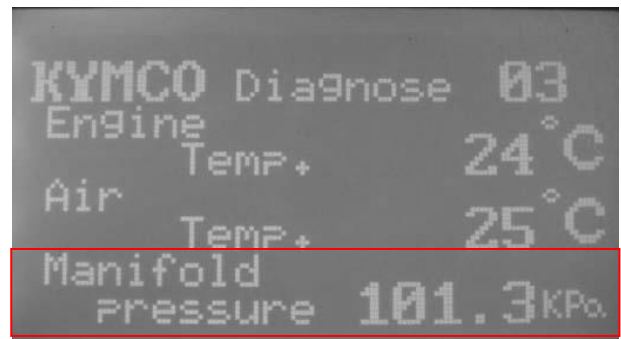

### TPS (Throttle Position Sensor)

Enter the Data Analyze

Check if the TPS position data is malfunction.

Turn the ignition switch to the “ON” position.

If data is incorrect even the Idle and throttle fully, the TPS is problem.

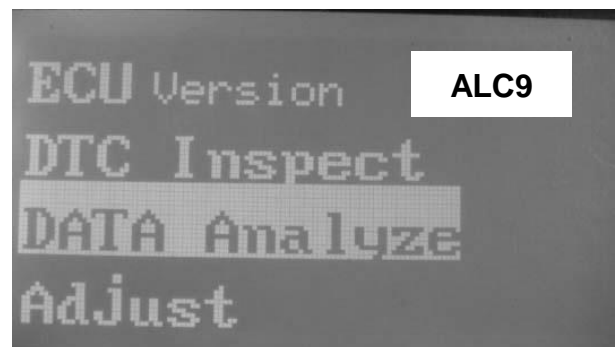

**Standard :**

Idle ~0 °                      0.23V ±0.05

Throttle fully ~90 °        > 3.27V

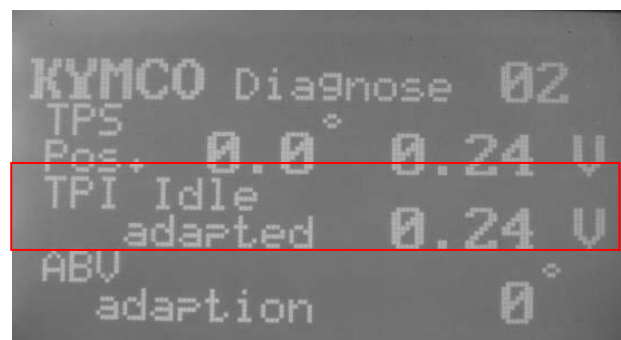

## **5. FUEL INJECTION SYSTEM**

Agility Carry / Delivery 50i

### **ETS (Engine Temperature Sensor)**

Connect the meter (+) probe to the V/G wire and the meter (-) probe to the G/L wire to measure the voltage

**Standard :  $5 \pm 0.25$  V**

Measure the resistance of the WTS

**Standard (25 °C) : 10--12k $\Omega$**



### **INJECTOR**

Measure the resistance of the Injector

**Standard (20°C/68°F) : 10.6~15.9 $\Omega$**

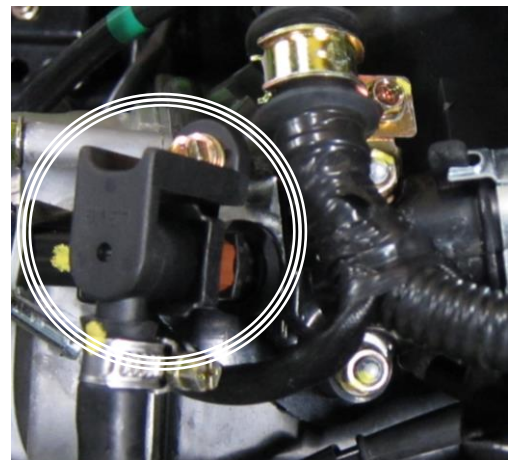

## 5. FUEL INJECTION SYSTEM

Agility Carry / Delivery 50i

### O2 SENSOR

Measure the resistance of the O2 sensor heater.  
(2 white wire pin)

Standard (20°C/68°F): 6.7 ~9.5Ω



Connect the PDA or KYMCO Fi diagnostic tool.  
Enter the Data Analyze  
Check Page 05  
Turn the ignition switch to the “ON” position.  
Starting engine till the O2 heater activation is ON.  
If data is incorrect, the O2 sensor is problem.



**ROLL SENSOR**

The engine should be stop when the vehicle incline over 65° for safety. When you place the vehicle back to normal position, you have to key-off and key-on the switch again, then it can be restarted.

**Standard:**

Normal: 0.4~1.4V

Fall down > 65° 3.7~4.4 V



Roll sensor

## **5. FUEL INJECTION SYSTEM**

**Agility Carry / Delivery 50i**

# Fi Diagnostic Tool

## Operation Instructions

### Part No. 3620A-LEB2-E00

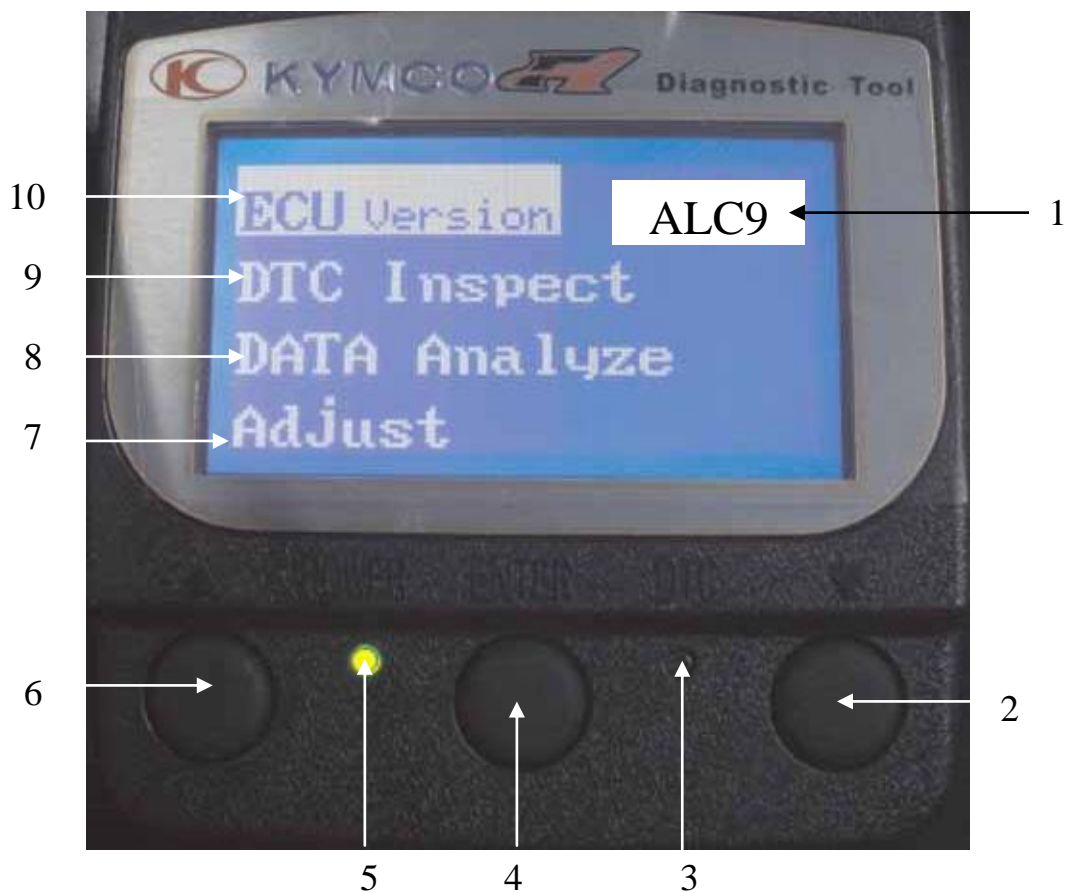

- |                                       |                |
|---------------------------------------|----------------|
| 1 Model No.                           | 8 DATA Analyze |
| 2 Down Button                         | 9 DTC Inspect  |
| 3 DTC indicator (Failure codes)       | 10 ECU Version |
| 4 Enter or Exit                       |                |
| 5 Power indicator                     |                |
| 6 UP Button                           |                |
| 7 Adjust (TPI and ABV reset function) |                |



## DTC INSPECTION

Connect Fi diagnostic tool with the connector of harness wire located beside the Battery.



Press the "Enter" button

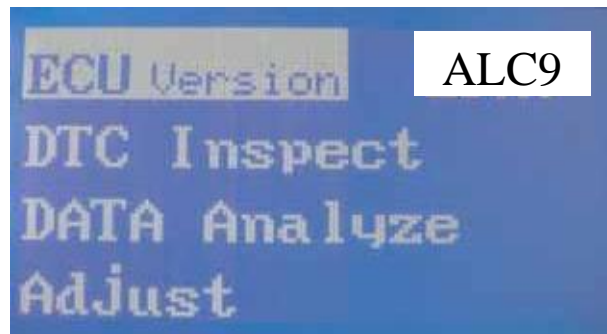

Check the software version

Press the "Enter" button and then turn to the first page.

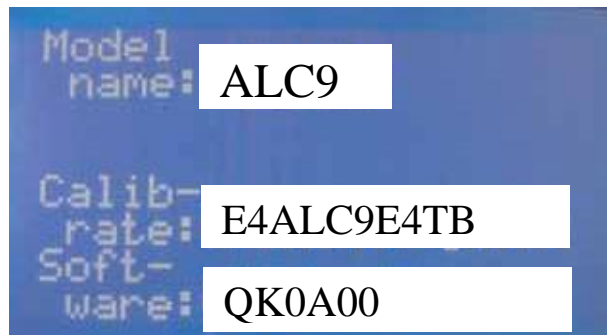

Press the "Down" button to enter the DTC Inspect.

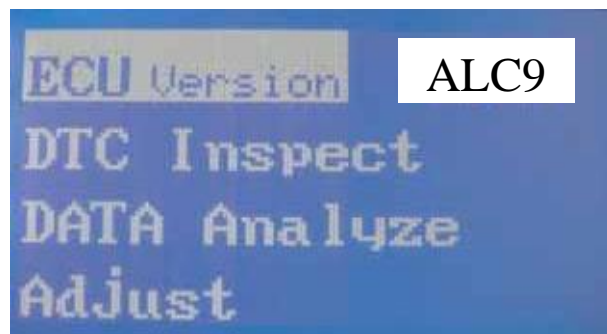

Press the "Enter" button to check the DTC number

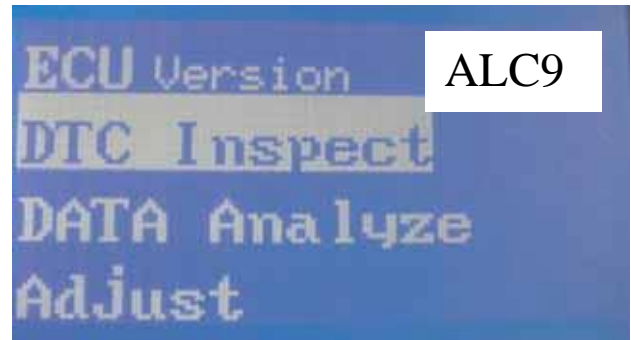

Press the "Enter" button

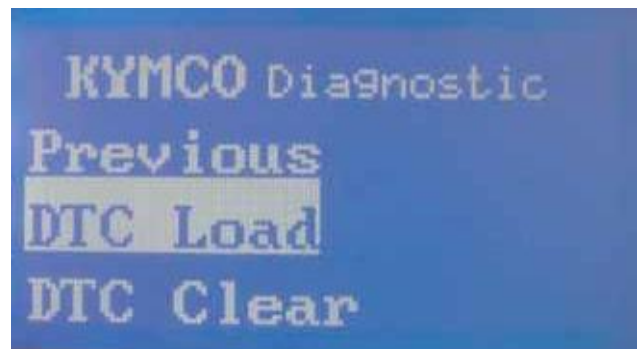

Press the "Enter" button

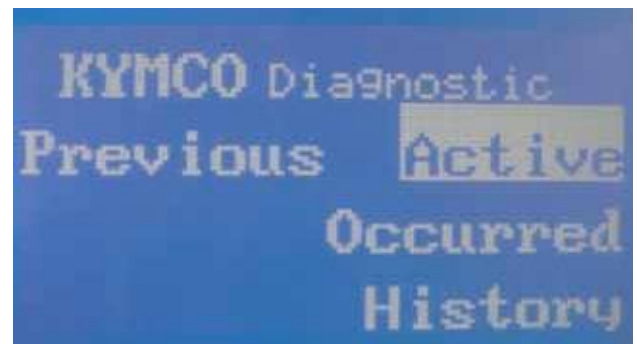

Display the DTC number of the DTC-List. Refer to DTC summary list.



Press the "Enter" button and then turn to the previous page

Press the "UP" button

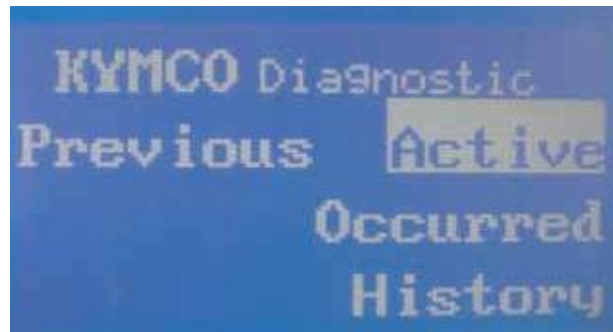

Press the "Enter" button and then turn to the previous page.

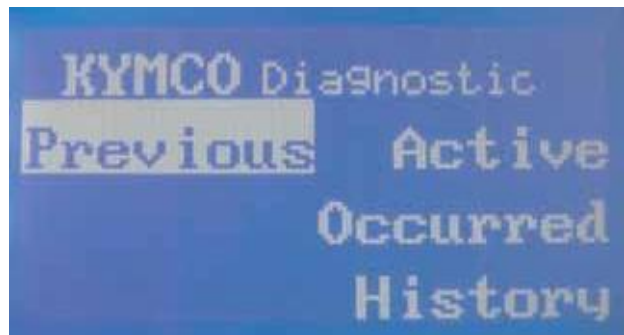

Press the "UP" button

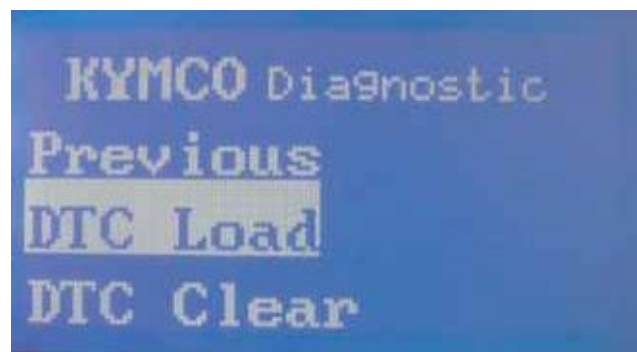

Press the "Enter" button and then turn to the first page.

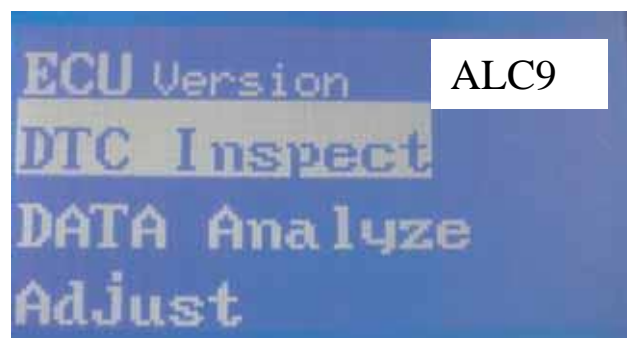

## DTC CLEAR PROCEDURE

Choose "Load DTC"

Press the "Down" button

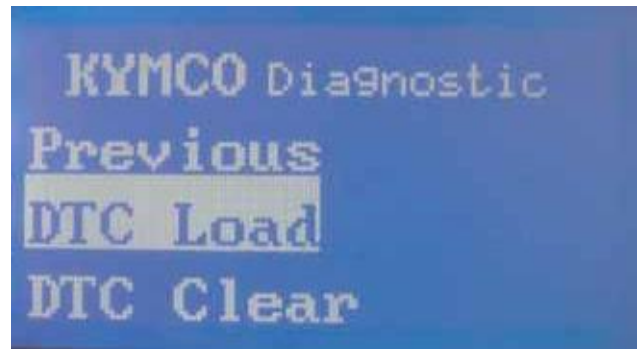

Press the "Enter" button

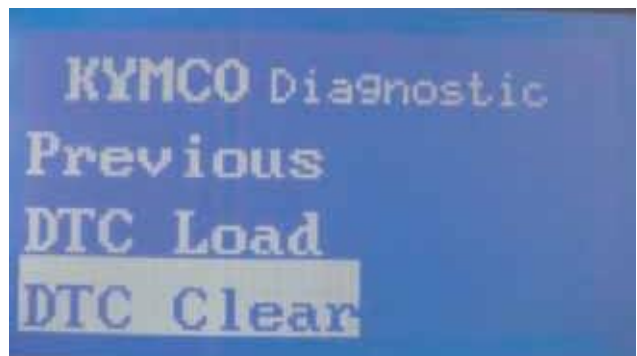

The DTC indicator is lighting at that time.



Clearing DTC until the DTC indicator is off.

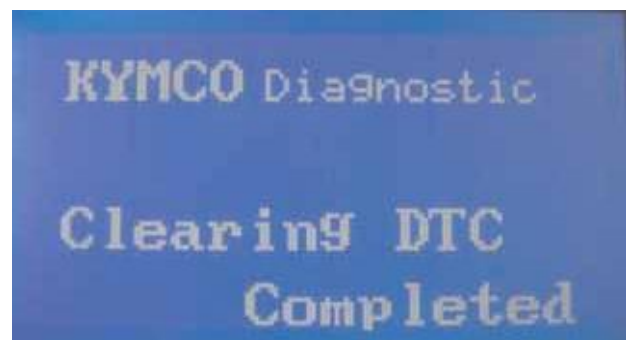

## DATA ANALYSIS

Choose "Data Analyze"

Press the "Enter" button to enter page 01.

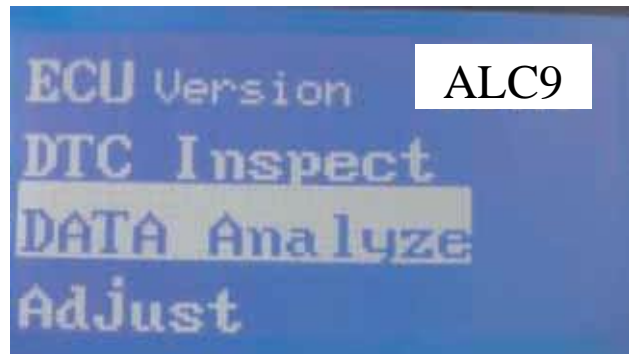

The figure includes the engine speed, idle speed and the battery voltage.

Refer to standard specification.

Press the "Down" button to enter page 02.



The figure includes TPS position, TPI idle adapted voltage and TPI WOT adapted (Throttle grip fully opened).

Refer to standard specification.

Press the "Down" button to enter page 03.

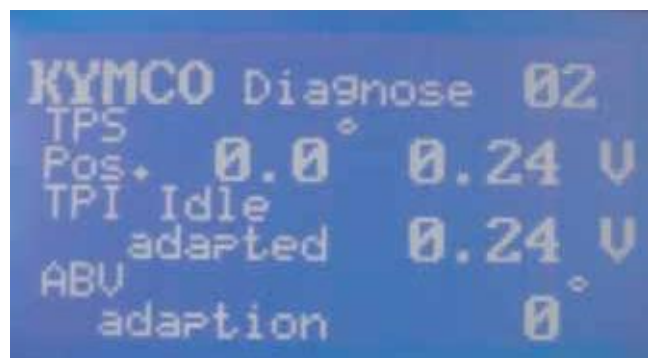

The figure includes engine working temperature, atmosphere pressure and Manifold pressure.

Refer to standard specifications on page 18-9.

Press the "Down" button to enter page 04.





## 5. FUEL INJECTION SYSTEM

The figure includes fuel injector interval, ignition advance angle and ABV angle. Refer to standard specification. Press the "Down" button to enter page 05.

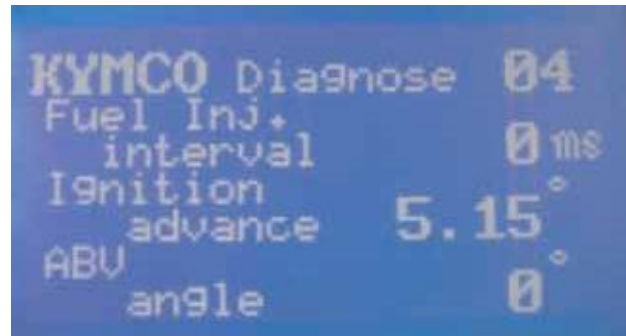

The figure includes O2 sensor voltage, O2 heater working condition and O2 correction.

Refer to standard specification.

Press the "Down" button to enter page 06.



The figure includes rollover voltage.

Refer to standard specification.

Press the "Down" button to enter page 07.



The figure includes ECU counter hours.

Press the "UP" button to the first page.

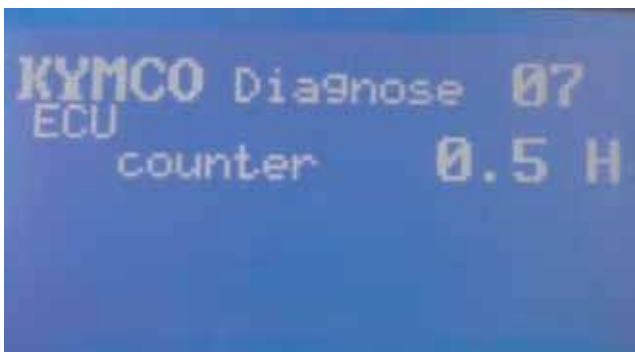

## ADJUST

Need to process the TPI/ABV reset after replacing a new ECU or clean Throttle Body. To make ECU set up and set up initially

Choose "Adjust"

Press the "Enter" button to TPI/ABV Reset

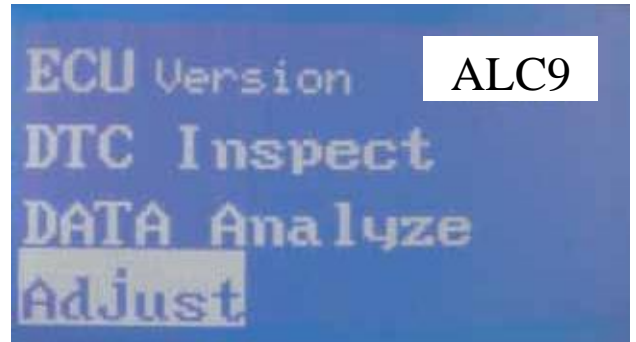

Press the "Enter" button

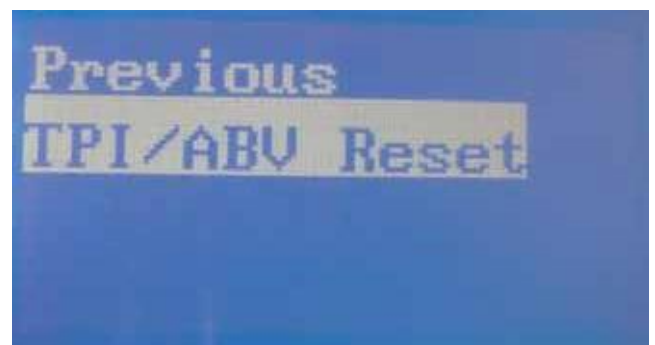

Please turn the ignition switch to the "OFF" position and then switch ON.

TPI/ABV reset is completed.

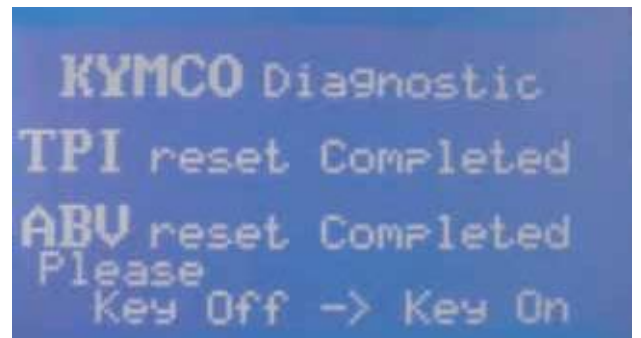

# 5. FUEL INJECTION SYSTEM

## DIAGNOSTIC REPORT --- AAF1/ALC9 45km/h

Reason of repair: <input type="checkbox"/> Maintenance <input type="checkbox"/> Breakdown			
Item	Data	Reference	Memo
ECU Version	ECU No		
	Hardware Ver		
	Software Ver	QK0A00	
	Calibration Ver	E4AAF1E4AA	
	Model Name	AAF1	
DTC	Active		
	Occurred		
	History		
(Cool Engine) Engine Stop	Air Temp.(°C)	environ.temp ± 2 °C	
	Engine Temp.(Cooling)	environ.temp ± 2 °C	
	Atom. Pressure (Kpa.)	101.3 ± 3 kPa	The ambient pressure drop about 12kpa at the altitude every 1000m raised
	Throttle Position (%)	Below0° / over 90°	
	Throttle Position (V)	0.23V ± 0.05 / >3.65±1V	IDLE/Throttle fully
	TPI Idle Mean (V)	0.23±0.05 />3.27 V	IDLE/Throttle fully
	Battery Volt (V)	>12 V	
	Idle Speed Set point (RPM)	---	
	ISCAdapMean (°)	---	
	Cut Out Switch Volt (V)	0.4 ~ 1.44 V (parking)	3.7 ~ 4.4 V(Over 65° )
	Accumulated Eng. Run Time (Hr)	---	
(Hot Engine) Before Repair	EngineSpeed IDLE(rpm)	2000 ± 100 rpm	
	MAPSample (kPa)	52 ~ 68 kpa	
	Injection duration (ms)	1.9 ~ 3 ms/2-3.3ms cold	
	Ign. Advance (°)	4 ~ 17 BTDC	
	Ign.Dwell duration (ms)	----	
	Air Temp.(°C)	environ.temp ±2 °C	
	Engine Temp. (°C)	>110°C	
	O <sup>2</sup> sensor voltage (V)	0 ~ 1 V	
	O <sup>2</sup> sensor heater (Yes/no)	YES	
	O <sup>2</sup> sensor correct	±15%	
	IDLE CO(%)	0.4 ~ 2 %	Engine warm up to 80~90 °C
	ABVAngDurMech (°)	< 140 °	>140 ° The scooter with exchange engine oil and clean throtly body >180 ° The scooter must clean throtly body
	(Hot Engine) After Repair	EngineSpeed IDLE(rpm)	2000 ± 100 rpm
MAPSample (kPa)		52 ~ 68 kpa	
Injection duration (ms)		1.9 ~ 3 ms/2-3.3ms cold	
Ign. Advance (°)		4 ~ 17 BTDC	
Ign.Dwell duration (ms)		1.8~2.5 ms	Battery Volt (V) 14V-2.5~2.6ms, 12V-2.9~3.1ms
Air Temp.(°C)		environ.temp ±2 °C	
Engine Temp. (°C)		>95 °C/> 70 °C winter	
O <sup>2</sup> sensor voltage (V)		0 ~ 1 V	
O <sup>2</sup> sensor heater (Yes/no)		YES	
O <sup>2</sup> sensor correct		±20	
IDLE CO(%)		0.4 ~ 2 %	Engine warm up to 80~90 °C
ABVAngDurMech (°)		< 140 °	>140 ° The scooter with exchange engine oil and clean throtly body >180 ° The scooter must clean throtly body
Repair description		Repair Process	



# 5. FUEL INJECTION SYSTEM

## DIAGNOSTIC REPORT --- AAF1/ALC9 25km/h

Reason of repair: <input type="checkbox"/> Maintenance <input type="checkbox"/> Breakdown			
Item	Data	Reference	Memo
ECU Version	ECU No		
	Hardware Ver		
	Software Ver	QK0A00	
	Calibration Ver	E4AAF125AA	
	Model Name	AAF1	
DTC	Active		
	Occurred		
	History		
(Cool Engine) Engine Stop	Air Temp.(°C)	environ.temp ± 2 °C	
	Engine Temp.(Cooling)	environ.temp ± 2 °C	
	Atom. Pressure (Kpa.)	101.3 ± 3 kPa	The ambient pressure drop about 12kpa at the altitude every 1000m raised
	Throttle Position (%)	Below0° / over 90°	
	Throttle Position (V)	0.23V ± 0.05 / >3.65±1V	IDLE/Throttle fully
	TPI Idle Mean (V)	0.23±0.05 />3.27 V	IDLE/Throttle fully
	Battery Volt (V)	>12 V	
	Idle Speed Set point (RPM)	---	
	ISCAdapMean (°)	---	
	Cut Out Switch Volt (V)	0.4 ~ 1.44 V (parking)	3.7 ~ 4.4 V(Over 65° )
	Accumulated Eng. Run Time (Hr)	---	
(Hot Engine) Before Repair	EngineSpeed IDLE(rpm)	2000 ± 100 rpm	
	MAPSample (kPa)	52 ~ 68 kpa	
	Injection duration (ms)	1.9 ~ 3 ms/2-3.3ms cold	
	Ign. Advance (°)	4 ~ 17 BTDC	
	Ign.Dwell duration (ms)	----	
	Air Temp.(°C)	environ.temp ±2 °C	
	Engine Temp. (°C)	>110°C	
	O <sup>2</sup> sensor voltage (V)	0 ~ 1 V	
	O <sup>2</sup> sensor heater (Yes/no)	YES	
	O <sup>2</sup> sensor correct	±15%	
	IDLE CO(%) )	0.4 ~ 2 %	Engine warm up to 80~90 °C
	ABVAngDurMech (°)	< 140 °	>140 ° The scooter with exchange engine oil and clean throtly body >180 ° The scooter must clean throtly body
	(Hot Engine) After Repair	EngineSpeed IDLE(rpm)	2000 ± 100 rpm
MAPSample (kPa)		52 ~ 68 kpa	
Injection duration (ms)		1.9 ~ 3 ms/2-3.3ms cold	
Ign. Advance (°)		4 ~ 17 BTDC	
Ign.Dwell duration (ms)		1.8~2.5 ms	Battery Volt (V) 14V-2.5~2.6ms, 12V-2.9~3.1ms
Air Temp.(°C)		environ.temp ±2 °C	
Engine Temp. (°C)		>95 °C/> 70 °C winter	
O <sup>2</sup> sensor voltage (V)		0 ~ 1 V	
O <sup>2</sup> sensor heater (Yes/no)		YES	
O <sup>2</sup> sensor correct		±20	
IDLE CO(%) )		0.4 ~ 2 %	Engine warm up to 80~90 °C
ABVAngDurMech (°)		< 140 °	>140 ° The scooter with exchange engine oil and clean throtly body >180 ° The scooter must clean throtly body
Repair description		Repair Process	

**ENGINE REMOVAL/INSTALLATION**

SERVICE INFORMATION ..... 6-2  
ENGINE REMOVAL..... 6-3  
ENGINE INSTALLATION..... 6-6

# 6. ENGINE REMOVAL/INSTALLATION



Agility Carry / Delivery 50i

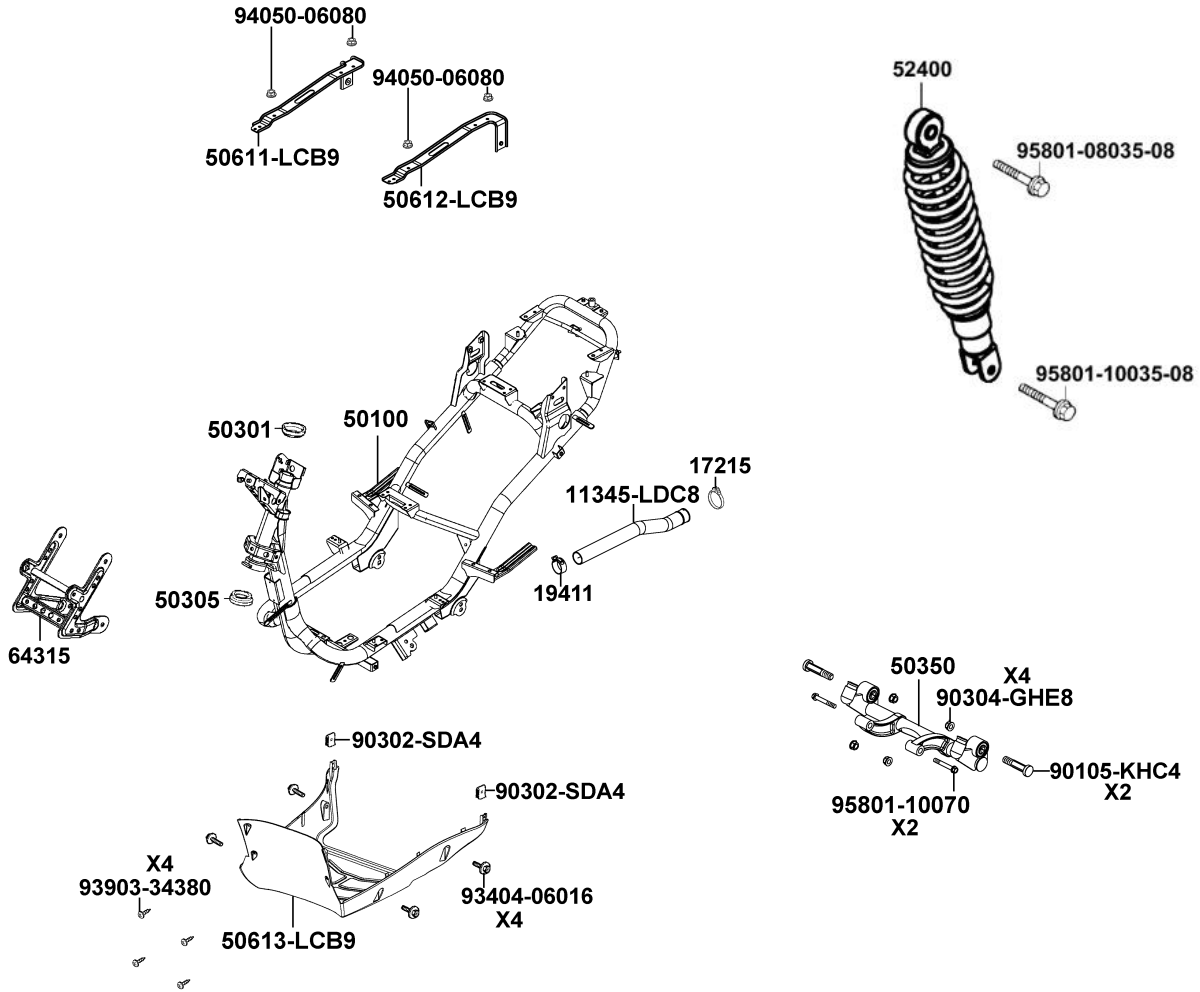

## SERVICE INFORMATION

### GENERAL INSTRUCTIONS

- A jack or other adjustable support is required to support and maneuver the engine. Be careful not to damage the motorcycle body, cables and wires during engine removal.
- Use towels to protect the motorcycle body during engine removal.
- Drain the coolant before removing the engine.
- After the engine is installed, fill the cooling system with coolant and be sure to bleed air. Start the engine to check for coolant leaks.
- Before removing the engine, the rear brake caliper must be removed first. Be careful not to bend or twist the brake fluid tube.

### SPECIFICATIONS

Engine oil capacity: 0.9 Liter

### TORQUE VALUES

Rear shock absorber upper mount bolt	40 N-m
Rear shock absorber lower mount bolt	40 N-m
Rear axle nut	120 N-n
Engine hanger bolt (frame side)	50 N-m
Engine hanger bolt (ENG. side)	50 N-m
Rear caliper holder bolt	27 N-m
Exhaust muffler pipe nut	20 N-m
Exhaust muffler bracket bolt (attached to RR Fork)	35 N-m
Rear fork bolt (attached to ENG case)	32 N-m

### ENGINE REMOVAL

Remove the frame body cover(2-4/5).  
Disconnect the battery negative cable.  
Disconnect the engine negative cable.  
Disconnect the A.C. Generator wire connector.  
Disconnect the starter motor cable from the starter relay.

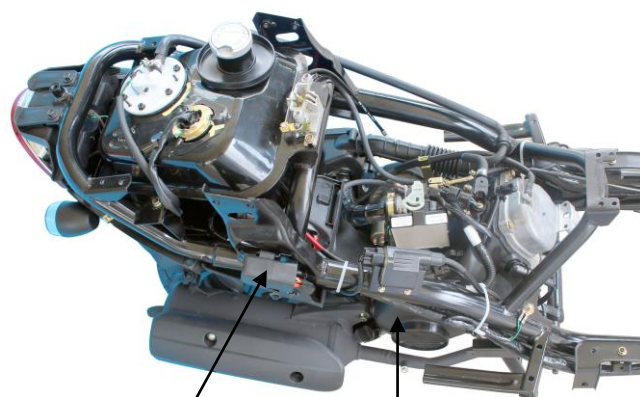

Starter Relay    A.C.G wire connector

Remove the spark plug cap.  
Remove the ignition coil's wire.  
Remove the O<sub>2</sub> sensor wire.

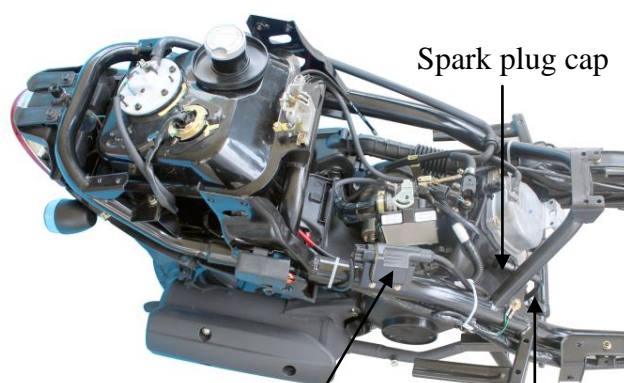

Spark plug cap  
Ignition coil    O<sub>2</sub> sensor

Disconnect the ECU connector  
Disconnect the engine temperature sensor connector.  
Remove the injector's wire.  
Remove the throttle cable.  
Remove the vacuum tube.  
Remove the fuel tube attaching to injector.

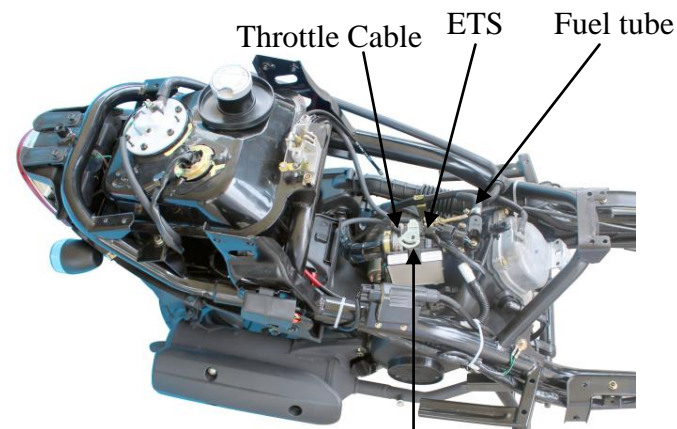

Throttle Cable    ETS    Fuel tube  
ECU connector

There are two Anti-modification Bolts attaching to the throttle body. If you to remove the throttle body or ECU, you need special tools as below.



Anti-modification Bolts

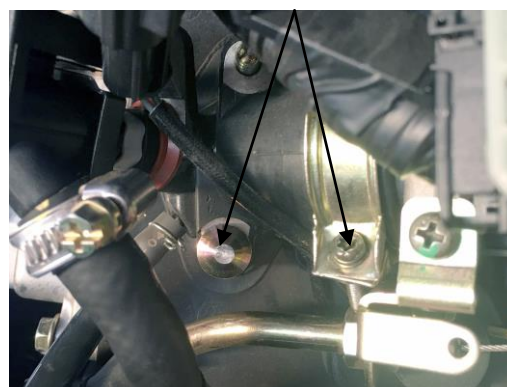

## 6. ENGINE REMOVAL/INSTALLATION

- Remove the air cleaner
- Remove the exhaust muffler(2-6)

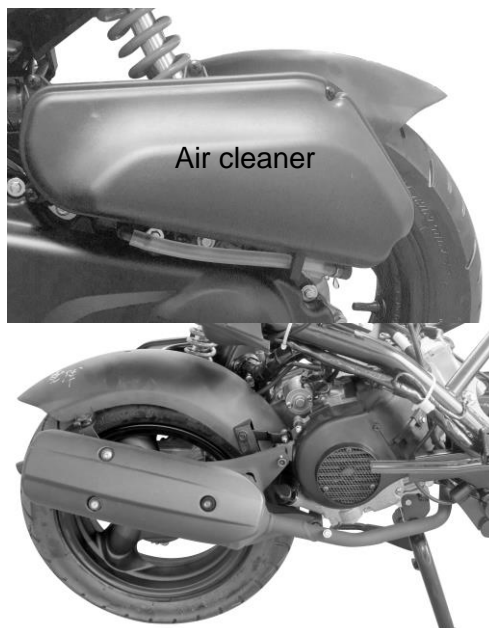

- Remove the rear brake caliper.
- Remove one bolt attaching to rear brake hose clamps.

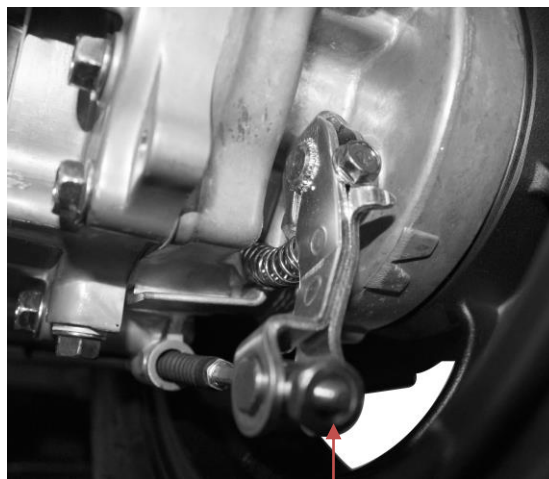

NUT

- Remove the rear shock absorbers mounting bolts.

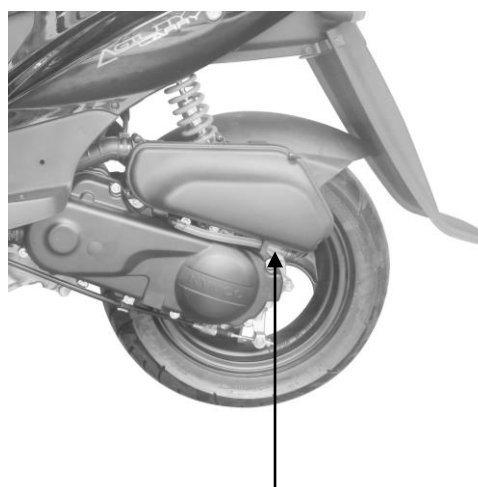

Rear Shock Absorber Bolt

Remove the engine mounting bolt and pull out the engine with the engine hanger bracket backward.

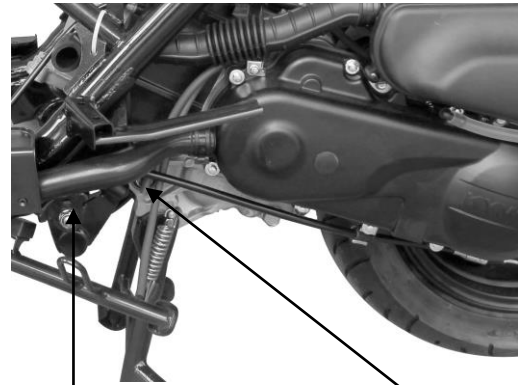

Engine Hanger  
Bracket Bolt

Engine Mounting Bolt

### **ENGINE HANGER BRACKET REMOVAL**

Remove the engine hanger bracket bolt and nut.  
Remove the engine.  
Inspect the engine hanger bushings and stopper rubbers for wear or damage.

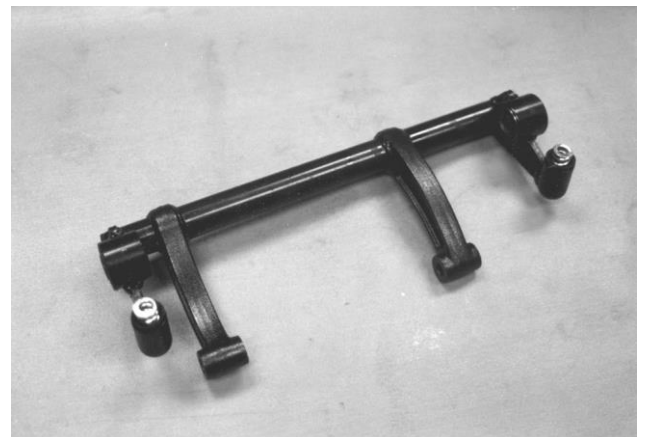

### ENGINE HANGER BRACKET

#### INSTALLATION

Install the engine hanger bracket to the engine.  
Install and tighten the engine hanger bracket bolts.

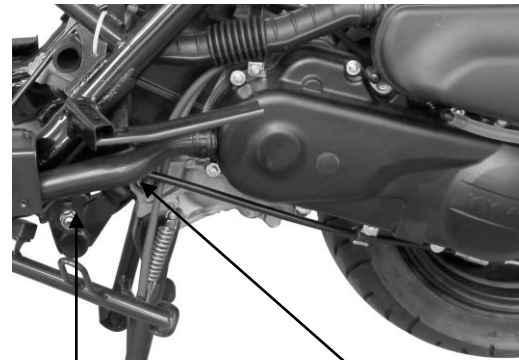

Engine Hanger  
Bracket Bolt

Engine Mounting Bolt

### ENGINE INSTALLATION

Install the engine and tighten the engine mounting bolts.

**Torque:** 5.0kg-m

Tighten the rear shock absorbers mounting bolts.

**Torque:** Up side 4.0kg-m

Down side 2.5kg-m

Install the removed parts in the reverse order of removal.



\*

**Tire pressure should be checked when tires are cold.**

After installation, inspect and adjust the following:

Throttle grip free play (⇒3-3)



**6. ENGINE REMOVAL/INSTALLATION**



Agility Carry / Delivery 50i

---

# 7. CYLINDER HEAD/VALVES

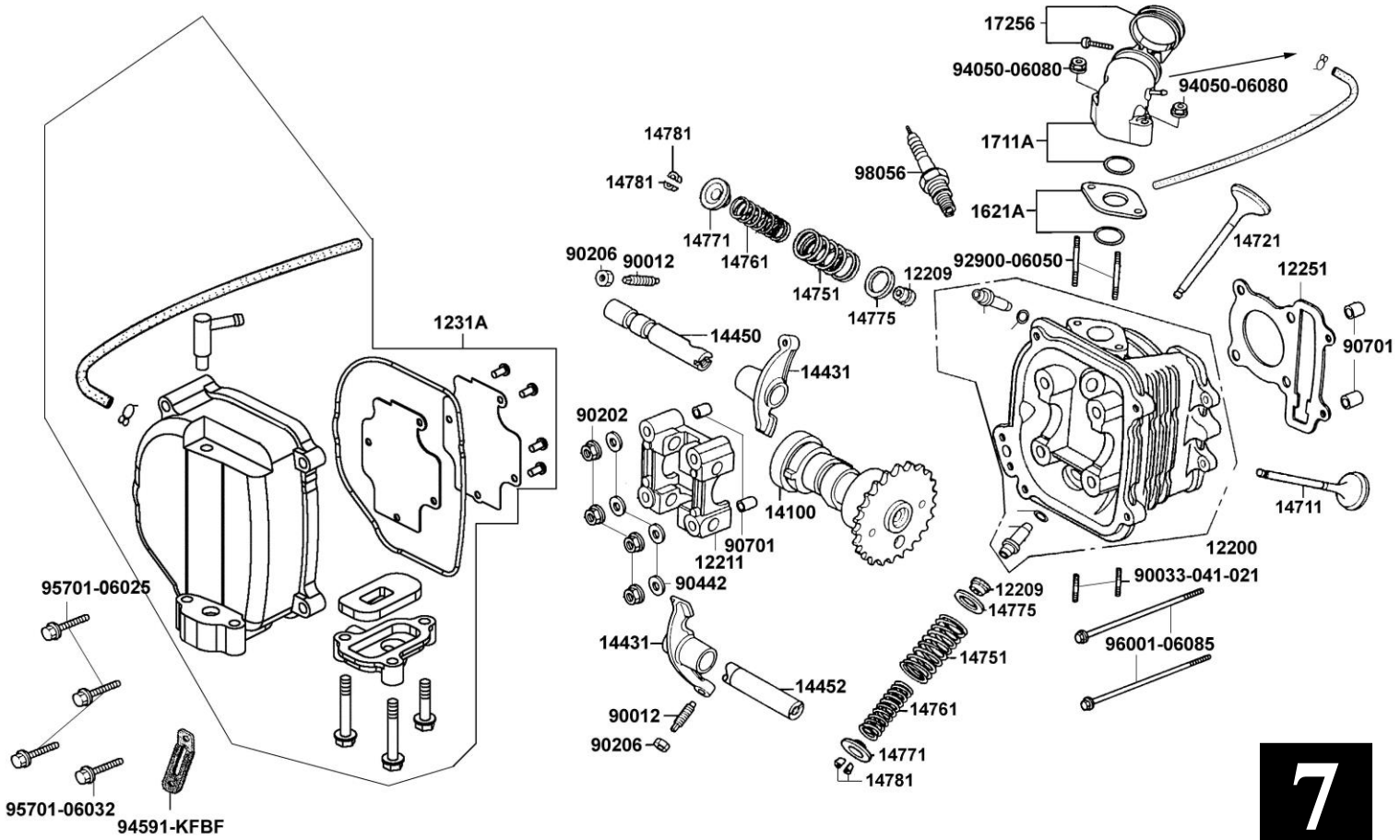

## 7. CYLINDER HEAD/VALVES

SERVICE INFORMATION.....	7-1	CYLINDER HEAD DISASSEMBLY .....	7-7
TROUBLESHOOTING .....	7-2	CYLINDER HEAD ASSEMBLY .....	7-8
CAMSHAFT REMOVAL.....	7-3	CYLINDER HEAD INSTALLATION.....	7-8
CYLINDER HEAD REMOVAL .....	7-5	CAMSHAFT INSTALLATION .....	7-9

### SERVICE INFORMATION

#### GENERAL INSTRUCTIONS

- The cylinder head can be serviced with the engine installed in the frame.
- When assembling, apply molybdenum disulfide grease or engine oil to the valve guide movable parts, valve arm and camshaft sliding surfaces for initial lubrication.
- The camshaft is lubricated by engine oil through the cylinder head engine oil passages. Clean and unclog the oil passages before assembling the cylinder head.
- After disassembly, clean the removed parts and dry them with compressed air before inspection.
- After removal, mark and arrange the removed parts in order. When assembling, install them in the reverse order of removal.

#### SPECIFICATIONS

Item		Standard (mm)	Service Limit (mm)
Valve clearance (cold)	IN	0.04	—
	EX	0.04	—
Cylinder head compression		15 ± 2kg/cm <sup>2</sup>	—
Cylinder head warpage		—	0.05
Camshaft cam height	IN	25.706	25.306
	EX	25.564	25.164
Valve rocker arm I.D.	IN	10.000-10.015	10.10
	EX	10.000-10.015	10.10
Valve rocker arm shaft O.D.	IN	9.972-9.987	9.91
	EX	9.972-9.987	9.91
Valve seat width	IN	1.0	1.8
	EX	1.0	1.8
Valve stem O.D.	IN	4.975-4.990	4.9
	EX	4.955-4.970	4.9
Valve guide I.D.	IN	5.000-5.012	5.03
	EX	5.000-5.012	5.03
Valve stem-to-guide clearance	IN	0.010-0.037	0.08
	EX	0.030-0.057	0.1
Valve spring free length		35.25	29.1

## 7. CYLINDER HEAD/VALVES

---

### TORQUE VALUES

Cylinder head nut	1.8~2.2kgf-m	Apply engine oil to threads
Valve clearance adjusting nut	0.7~1.1kgf-m	Apply engine oil to threads

### SPECIAL TOOLS

Valve spring compressor

### TROUBLESHOOTING

- The poor cylinder head operation can be diagnosed by a compression test or by tracing engine top-end noises.

#### Poor performance at idle speed

- Compression too low

#### Compression too low

- Incorrect valve clearance adjustment
- Burned or bent valves
- Incorrect valve timing
- Broken valve spring
- Poor valve and seat contact
- Leaking cylinder head gasket
- Warped or cracked cylinder head
- Poorly installed spark plug

#### Compression too high

- Excessive carbon build-up in combustion chamber

#### White smoke from exhaust muffler

- Worn valve stem or valve guide
- Damaged valve stem seal

#### Abnormal noise

- Incorrect valve clearance adjustment
- Sticking valve or broken valve spring
- Damaged or worn camshaft
- Worn cam chain guide
- Worn camshaft and rocker arm

## 7. CYLINDER HEAD/VALVES

### CAMSHAFT REMOVAL

Remove the center cover. (⇒2-3)  
Remove the frame center.  
Remove the four cylinder head cover bolts to remove the cylinder head cover.

Cylinder Head Cover

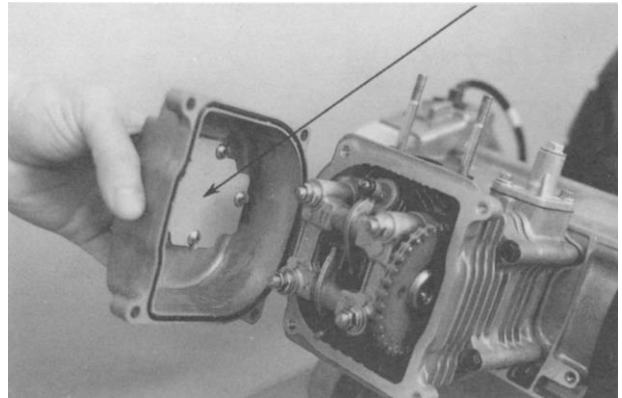

Remove the cam chain tensioner sealing bolt and spring.  
Remove the two bolts attaching the cam chain tensioner and the tensioner.

Sealing Bolt

Bolts

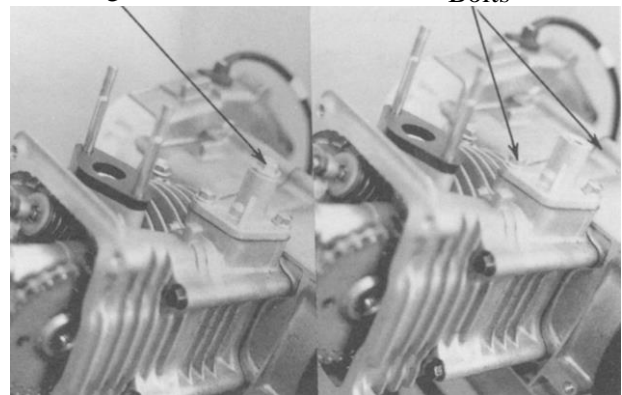

Turn the flywheel counterclockwise so that the "T" mark on the flywheel aligns with the index mark on the crankcase to bring the round hole on the camshaft gear facing up to the top dead center on the compression stroke.

Camshaft Gear

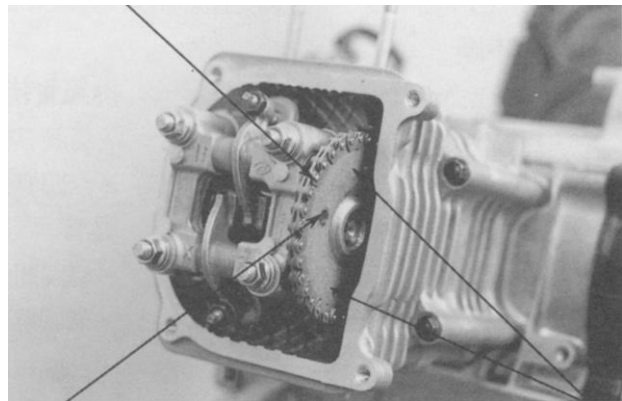

Round Hole

Punch Marks

Remove the two cylinder head bolts.  
Remove the four cylinder head nuts and washers.  
Remove the camshaft holder.

\* Diagonally loosen the cylinder head nuts in 2 or 3 times.

Washer

Nut

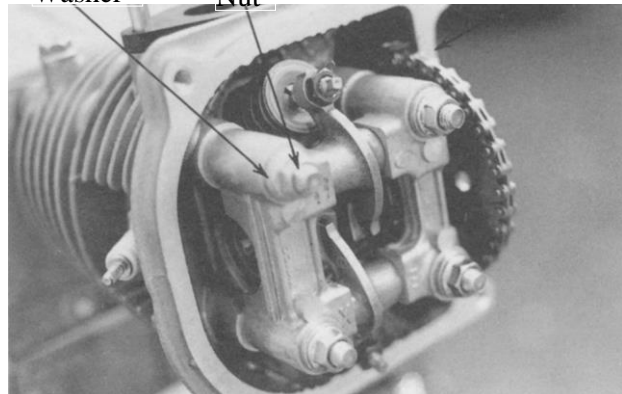

## 7. CYLINDER HEAD/VALVES

Remove the camshaft holder and dowel pins.

Camshaft Holder

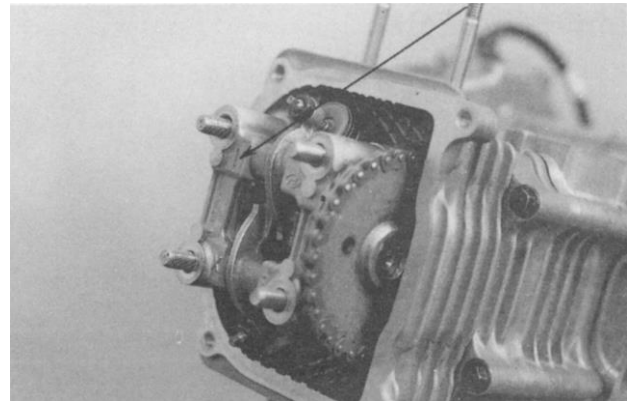

Remove the camshaft gear from the cam chain and remove the camshaft.

Camshaft

Dowel Pins

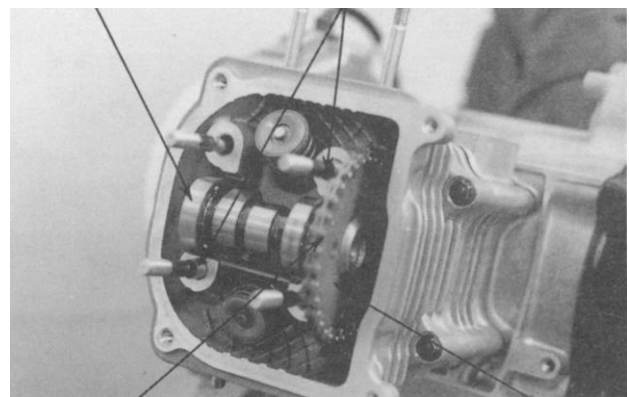

Cam Chain

Camshaft Gear

### CAMSHAFT INSPECTION

Check each cam lobe for wear or damage.  
Measure the cam lobe height.

#### Service Limits:

IN : 25.361mm replace if below

EX: 25.162mm replace if below

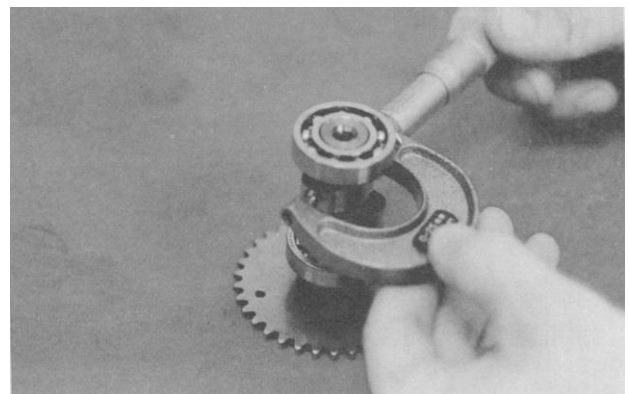

Check each camshaft bearing for play or damage. Replace the camshaft assembly with a new one if the bearings are noisy or have excessive play.

Camshaft Bearings

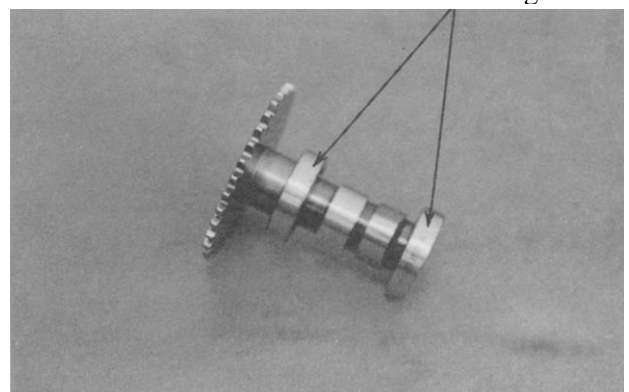

## 7. CYLINDER HEAD/VALVES

### CAMSHAFT HOLDER DISASSEMBLY

Take out the valve rocker arm shafts using a 5mm bolt.  
Remove the valve rocker arms.

Rocker Arm Shaft

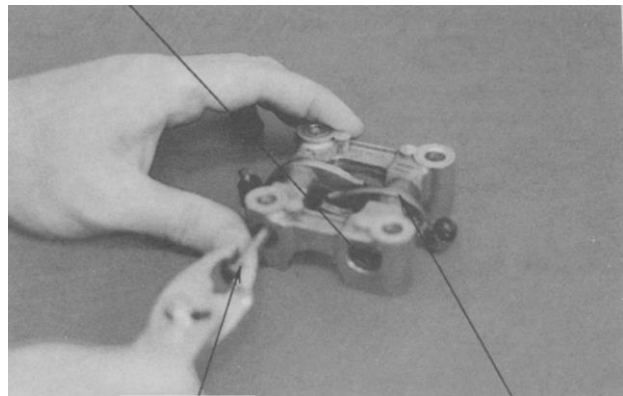

5mm Bolt

Rocker Arm

### CAMSHAFT HOLDER INSPECTION

Inspect the camshaft holder, valve rocker arms and rocker arm shafts for wear or damage.

\* If the valve rocker arm contact surface is worn, check each cam lobe for wear or damage.

Camshaft Holder

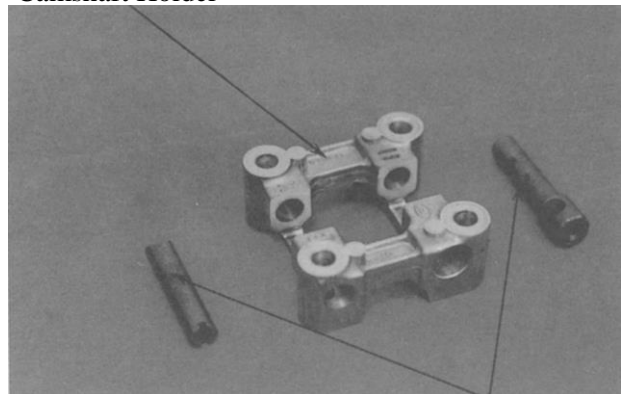

Rocker Arm Shafts

Measure the I.D. of each valve rocker arm.

**Service Limits:** IN:10.10mm replace if over  
EX:10.10mm replace if over

Measure each rocker arm shaft O.D.

**Service Limits:** IN: 9.91mm replace if over  
EX: 9.91mm replace if over

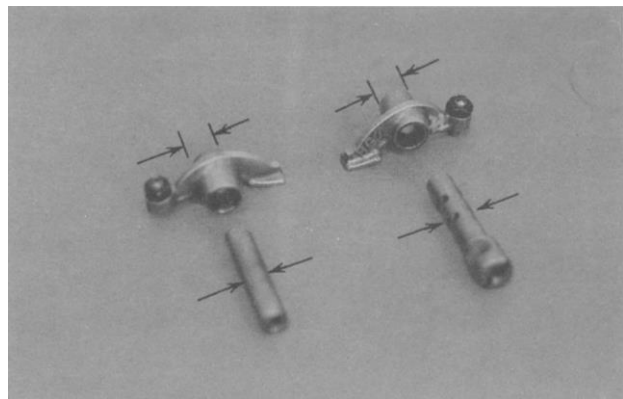

### CYLINDER HEAD REMOVAL

Remove the camshaft. (⇒7-3)  
Remove the carburetor. (⇒5-5)  
Remove the exhaust muffler. (⇒2-5)  
Remove the carburetor intake manifold.

Intake Manifold



## 7. CYLINDER HEAD/VALVES

Remove the cooling fan cover. (⇒14-6)  
Remove the engine cover bolts and screws.  
Separate the engine cover joint claws.

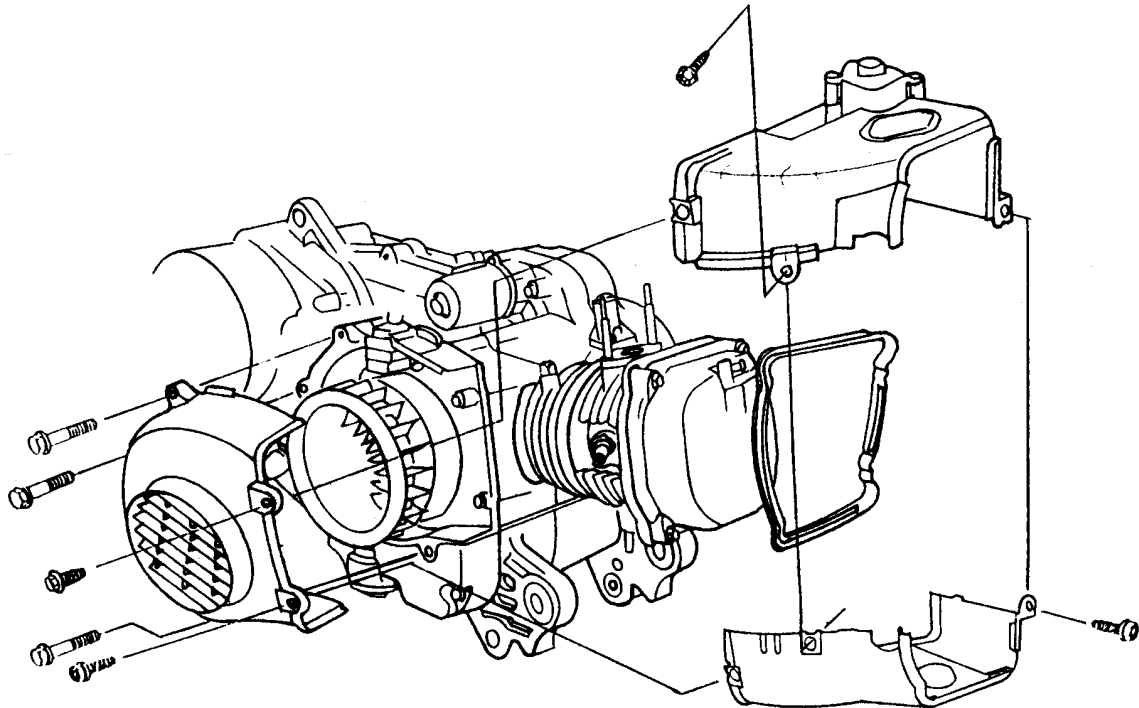

Remove the cylinder head.

Cylinder Head

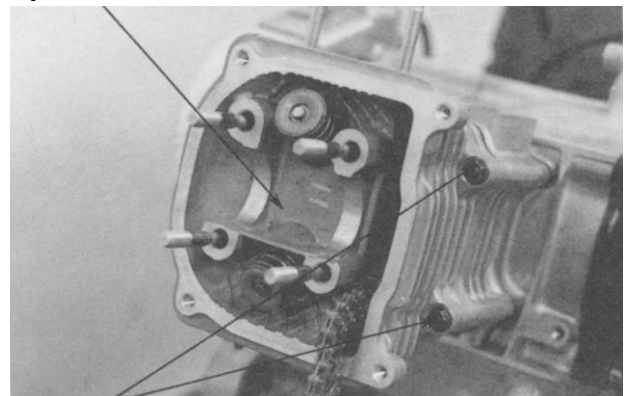

Bolts

Remove the dowel pins and cylinder head gasket.  
Remove the cam chain guide.

Dowel Pins

Cylinder Head Gasket

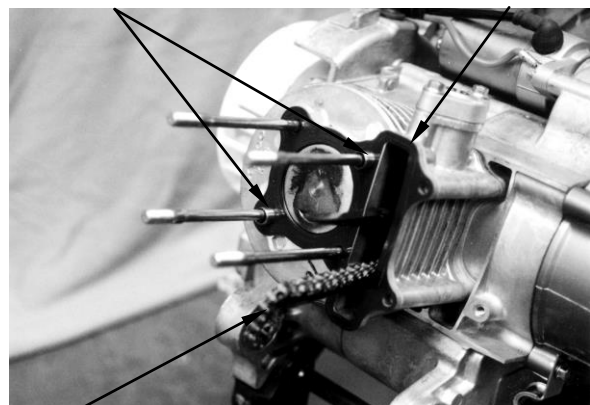

Cam Chain Guide



## 7. CYLINDER HEAD/VALVES

### CYLINDER HEAD DISASSEMBLY

Remove the valve spring cotters, retainers, springs, spring seats and valve stem seals using a valve spring compressor.

- \* Be sure to compress the valve springs with a valve spring compressor.
- \* Mark all disassembled parts to ensure correct reassembly.

**Special**

Valve Spring Compressor

Valve Spring Compressor Attachment

Valve Spring Compressor

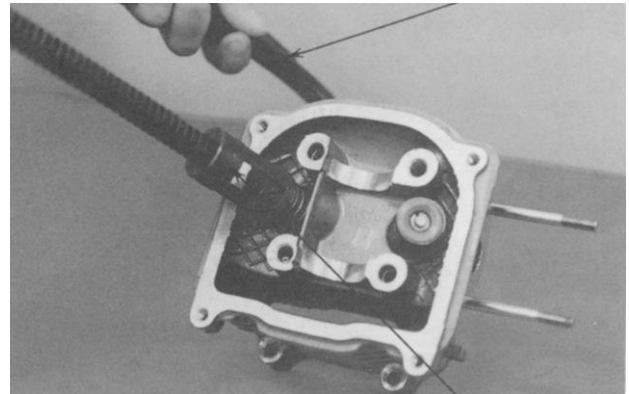

Valve Spring Compressor Attachment

Remove carbon deposits from the combustion chamber.

Clean off any gasket material from the cylinder head mating surface.

- \* Be careful not to damage the cylinder head mating surface.

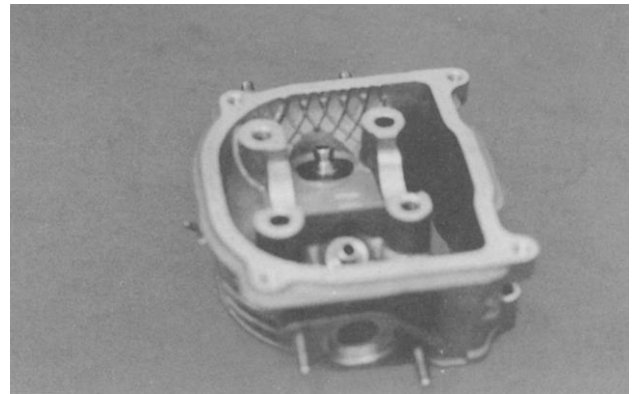

### INSPECTION

#### CYLINDER HEAD

Check the spark plug hole and valve areas for cracks.

Check the cylinder head for warpage with a straight edge and feeler gauge.

**Service Limit:** 0.05mm repair or replace if over

#### VALVE SPRING FREE LENGTH

Measure the free length of the springs.

**Service Limits:** 29.1mm replace if below

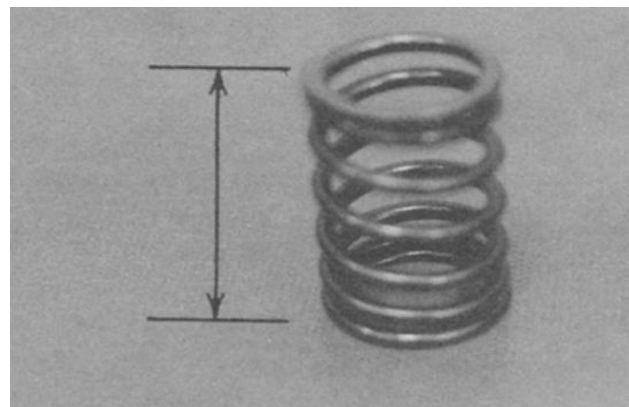

## 7. CYLINDER HEAD/VALVES

### VALVE/ VALVE GUIDE

Inspect each valve for bending, burning, scratches or abnormal stem wear.

Check valve movement in the guide.

Measure each valve stem O.D.

**Service Limits:** IN : 4.9mm replace if below

EX: 4.9mm replace if below

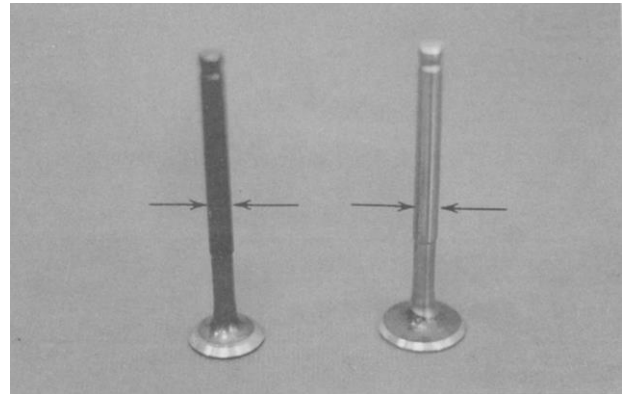

Valve Spring Compressor

### CYLINDER HEAD ASSEMBLY

- \* When assembling, a valve spring compressor must be used.
- Install the cotters with the pointed ends facing down from the upper side of the cylinder head.

**Special**

Valve Spring Compressor

Valve Spring Compressor Attachment

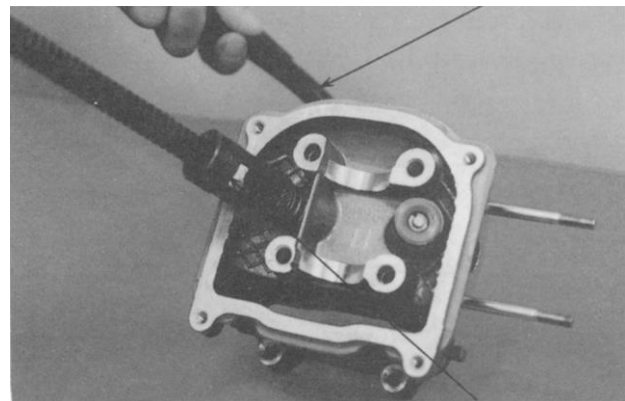

Valve Spring Compressor Attachment

Tap the valve stems gently with a plastic hammer for 2~3 times to firmly seat the cotters.

- \* Be careful not to damage the valves.

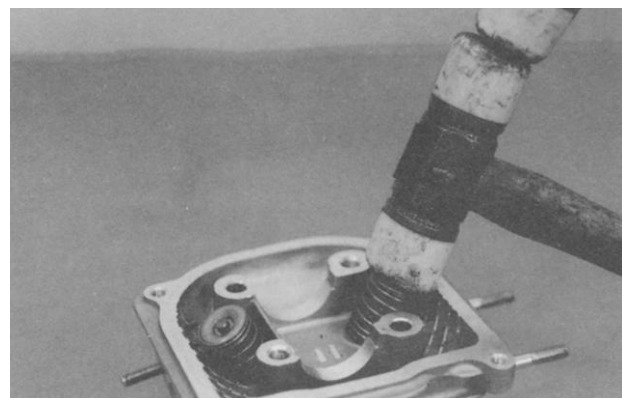

### CYLINDER HEAD INSTALLATION

Install the dowel pins and a new cylinder head gasket.

Install the cam chain guide.

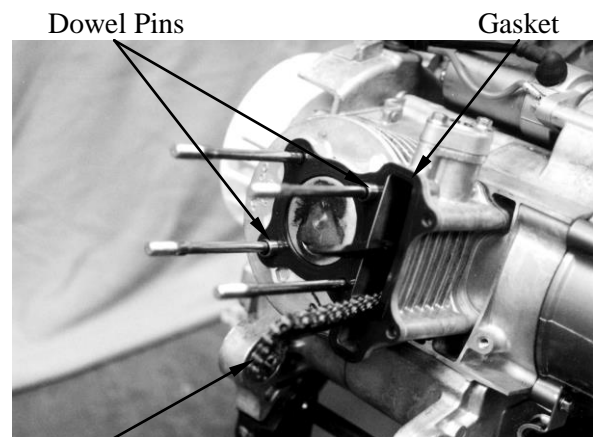

Cam Chain Guide

## 7. CYLINDER HEAD/VALVES

Install the cylinder head.

Cylinder Head

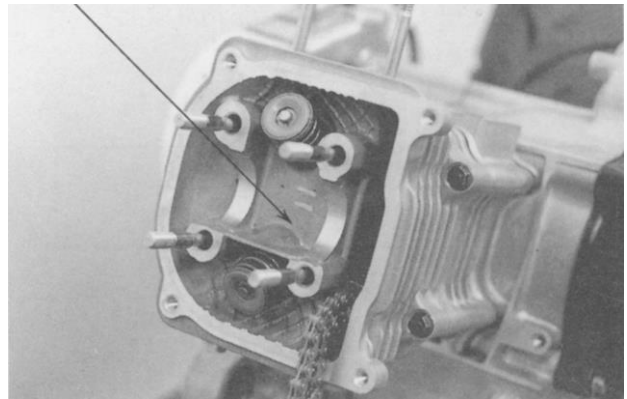

### CAMSHAFT HOLDER ASSEMBLY

First assemble the camshaft holder.  
Install the intake and exhaust valve rocker arms and rocker arm shafts.

- \* • When installing the rocker arm shaft, align the shaft front end with the bolt hole of the camshaft holder.

Camshaft Holder

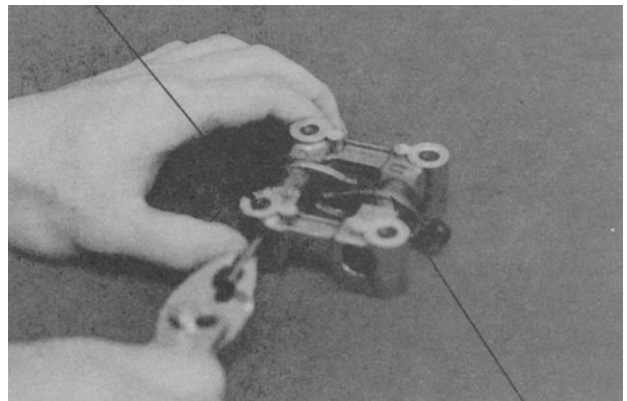

### CAMSHAFT INSTALLATION

Turn the flywheel so that the “T” mark on the flywheel aligns with the index mark on the crankcase.

Keep the round hole on the camshaft gear facing up and align the punch marks on the camshaft gear with the cylinder head surface (Position the intake and exhaust cam lobes down.) and install the camshaft onto the cylinder head.

Install the cam chain over the camshaft gear.

Valve Rocker Arm  
Camshaft Gear

Cam Chain

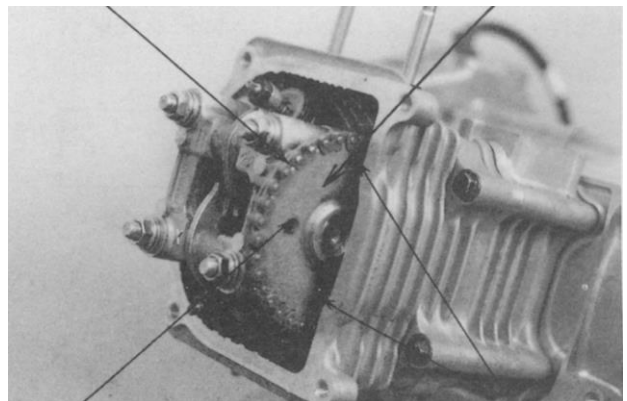

Round Hole

Punch Marks

Dowel Pins

Install the dowel pins.

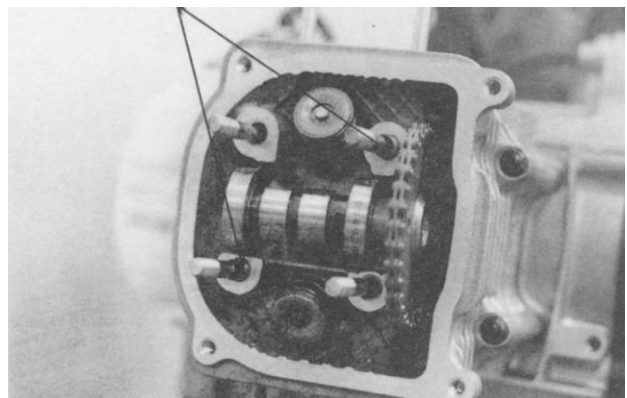

## 7. CYLINDER HEAD/VALVES

Install the camshaft holder, washers and nuts on the cylinder head.

Tighten the four cylinder head nuts and two bolts.

**Torque:** Cylinder head nut: 1.8~2.2kgf-m

- \* • Apply engine oil to the threads of the cylinder head nuts.
- Diagonally tighten the cylinder head nuts in 2~3 times.

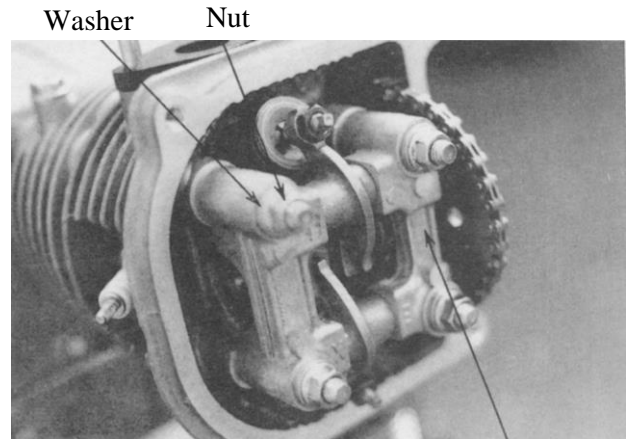

Washer Nut

Camshaft Holder

### CAM CHAIN TENSIONER INSTALLATION

First install a new cam chain tensioner gasket.

Install the tensioner using the two bolts.

Install the tensioner spring.

Install the O-ring and sealing bolt.

- \* When installing the tensioner, release the lock pawl and push the push rod all the way in.

**Torque:** 0.45~0.6kgf-m

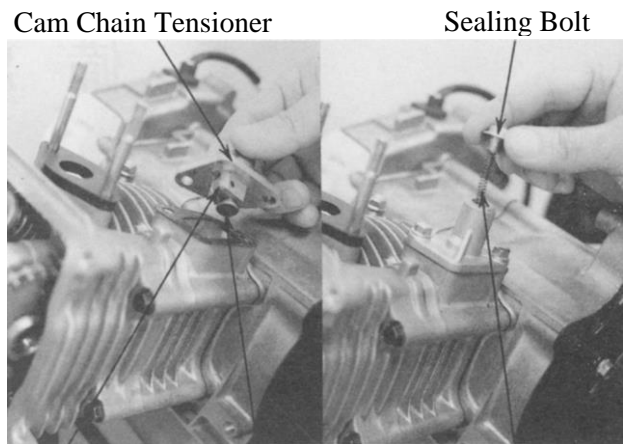

Cam Chain Tensioner

Sealing Bolt

Lock Pawl

Push Rod

Spring

Adjust the valve clearance. (⇒3-5)

Install a new cylinder head cover O-ring and install the cylinder head cover.

- \* Be sure to install the O-ring into the groove properly.

Install and tighten the cylinder head cover bolts.

**Torque:** 0.8~1.2kgf-m

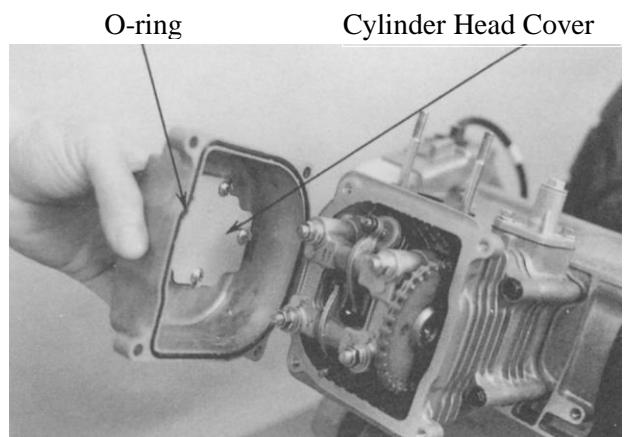

O-ring

Cylinder Head Cover

# 8. CYLINDER/PISTON

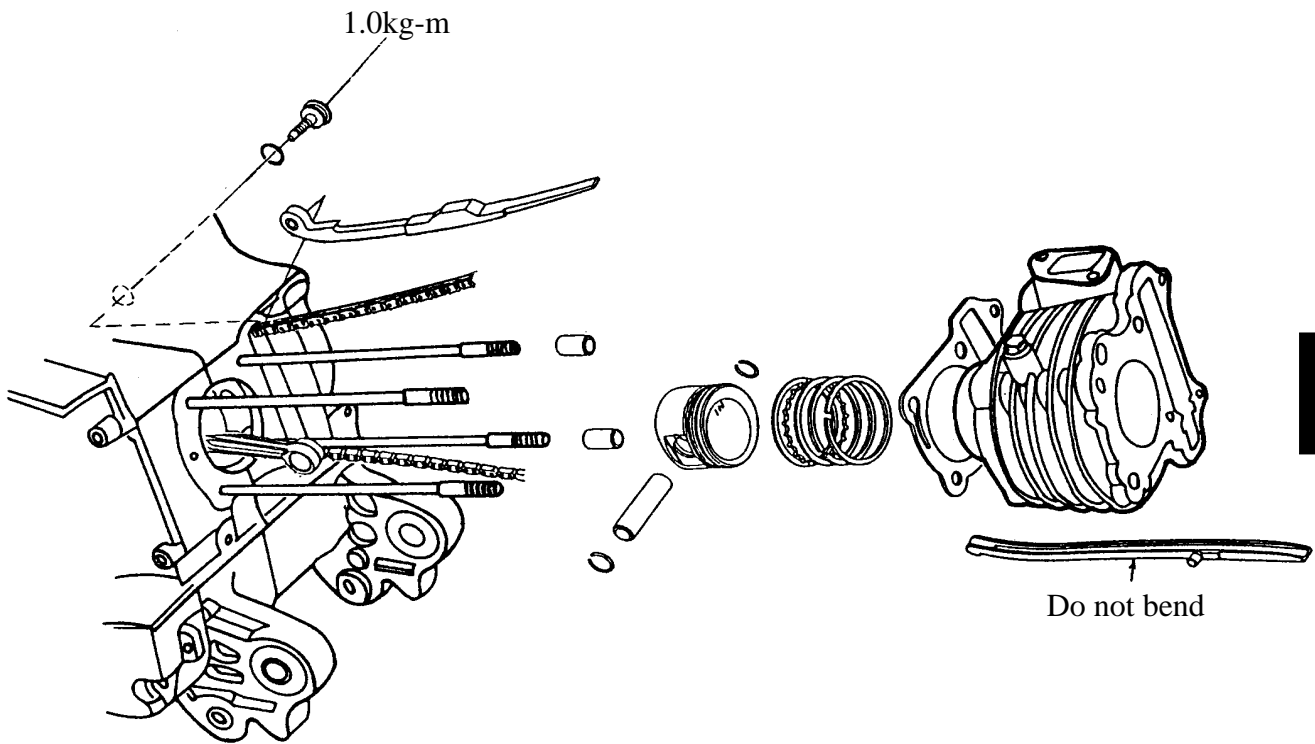

## 8. CYLINDER/PISTON

SERVICE INFORMATION.....8-1	PISTON REMOVAL.....8-2
TROUBLESHOOTING.....8-1	PISTON INSTALLATION.....8-6
CYLINDER REMOVAL.....8-2	CYLINDER INSTALLATION.....8-6

### SERVICE INFORMATION

#### GENERAL INSTRUCTIONS

- The cylinder and piston can be serviced with the engine installed in the frame.
- After disassembly, clean the removed parts and dry them with compressed air before inspection.

#### SPECIFICATIONS

Item		Standard (mm)	Service Limit (mm)	
Cylinder	I.D.	39.00-39.01	39.10	
	Warpage	—	0.05	
	Cylindricity	—	0.05	
	True roundness	—	0.05	
Piston, piston ring	Ring-to-groove clearance	Top	0.015-0.050	0.09
		Second	0.015-0.050	0.09
	Ring end gap	Top	0.08-0.20	0.45
		Second	0.05-0.20	0.45
		Oil side rail	0.20-0.70	—
	Piston O.D.		38.855-38.875	38.8
	Piston O.D. measuring		9mm from bottom of skirt	—
	Piston-to-cylinder clearance		0.010-0.040	0.1
Piston pin hole I.D.		13.002-13.008	13.004	
Piston pin O.D		12.994-13.000	12.96	
Piston-to-piston pin clearance		0.002-0.014	—	
Connecting rod small end I.D. bore		13.016-13.034	13.06	

### TROUBLESHOOTING

- When hard starting or poor performance at low speed occurs, check the crankcase breather for white smoke. If white smoke is found, it means that the piston rings are worn, stuck or broken.

#### Compression too low or uneven compression

- Worn, stuck or broken piston rings
- Worn or damaged cylinder and piston

#### Compression too high

- Excessive carbon build-up in combustion chamber or on piston head

#### Excessive smoke from exhaust muffler

- Worn or damaged piston rings
- Worn or damaged cylinder and piston

#### Abnormal noisy piston

- Worn cylinder, piston and piston rings
- Worn piston pin hole and piston pin

## 8. CYLINDER/PISTON

### CYLINDER REMOVAL

Remove the cylinder head. (⇒7-6)  
Remove the cam chain guide.  
Remove the cylinder.

Cylinder



Remove the cylinder gasket and dowel pins.  
Clean any gasket material from the cylinder surface.

Dowel Pins



Gasket

### PISTON REMOVAL

Remove the piston pin clip.

\* Place a clean shop towel in the crankcase to keep the piston pin clip from falling into the crankcase.

Press the piston pin out of the piston and remove the piston.

Piston Pin



Piston Rings

Piston

## 8. CYLINDER/PISTON

Inspect the piston, piston pin and piston rings.  
Remove the piston rings.

- \* Take care not to damage or break the piston rings during removal.

Clean carbon deposits from the piston ring grooves.

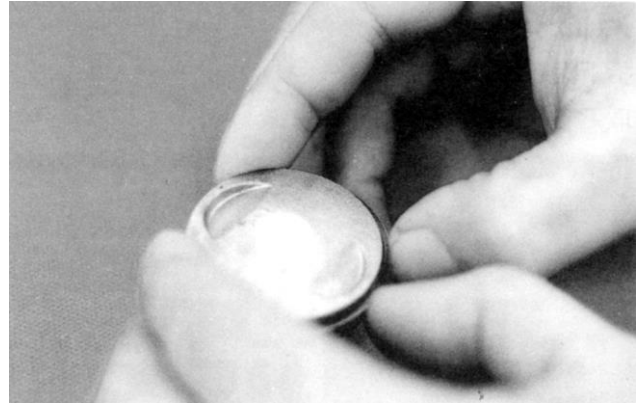

Install the piston rings onto the piston and measure the piston ring-to-groove clearance.

**Service Limits:** **Top:** 0.09mm replace if over  
**2nd:** 0.09mm replace if over



Remove the piston rings and insert each piston ring into the cylinder bottom.

- \* Use the piston head to push each piston ring into the cylinder.

Measure the piston ring end gap.

**Service Limit:** 0.45mm replace if over

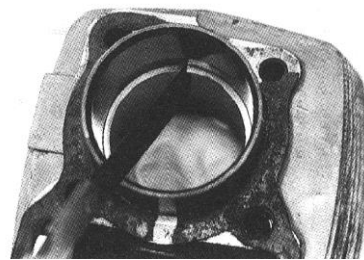

Measure the piston pin hole I.D.

**Service Limit:** 13.004mm replace if below

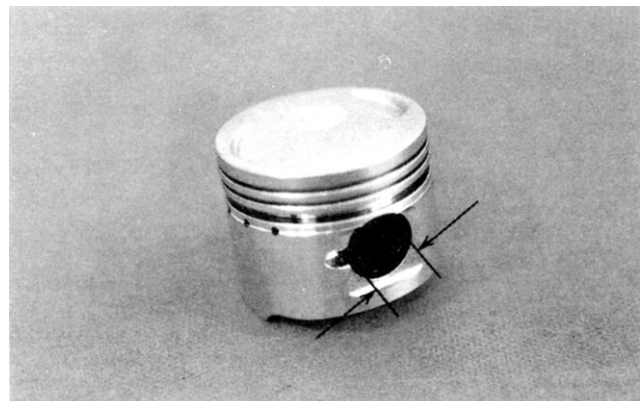



## 8. CYLINDER/PISTON

Measure the piston pin O.D.

**Service Limit:** 12.96mm replace if below

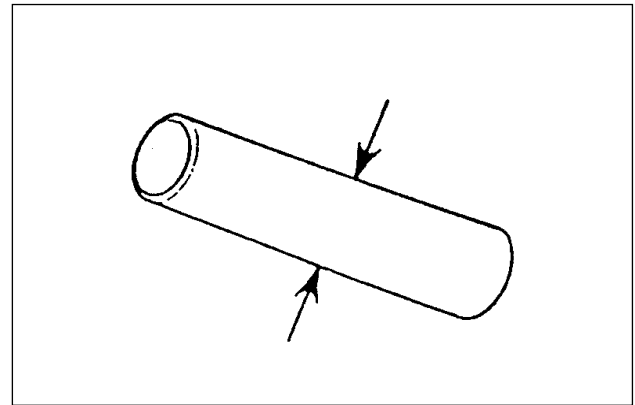

Measure the piston O.D.

\* Take measurement at 9mm from the bottom and 90° to the piston pin hole.

**Service Limit:** 38.9mm replace if below  
Measure the piston-to-piston pin clearance.

**Service Limit:** 0.02mm replace if over

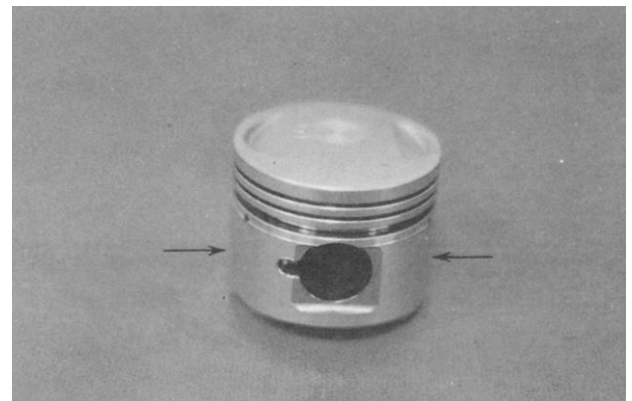

### CYLINDER INSPECTION

Inspect the cylinder bore for wear or damage. Measure the cylinder I.D. at three levels of top, middle and bottom at 90° to the piston pin (in both X and Y directions).

**Service Limit:** 39.10mm repair or replace if over

Measure the cylinder-to-piston clearance.

**Service Limit:** 0.1mm repair or replace if over

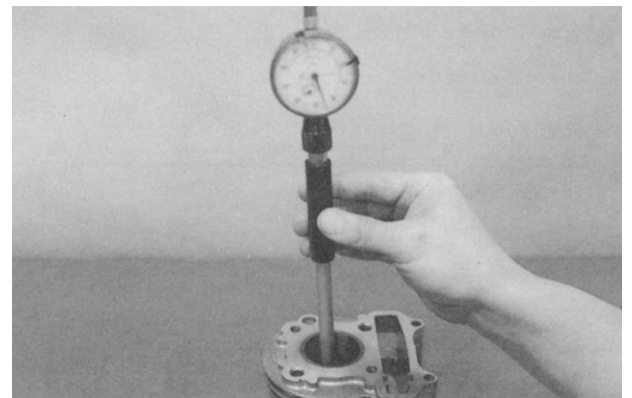

The true roundness is the difference between the values measured in X and Y directions. The cylindricity (difference between the values measured at the three levels) is subject to the maximum value calculated.

**Service Limits:**

**True Roundness:** 0.05mm repair or replace if over

**Cylindricity:** 0.05mm repair or replace if over

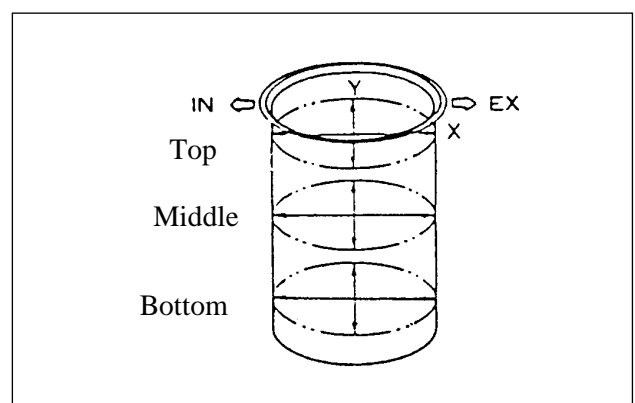

## 8. CYLINDER/PISTON

Inspect the top of the cylinder for warpage.

**Service Limit:** 0.05mm repair or replace if over

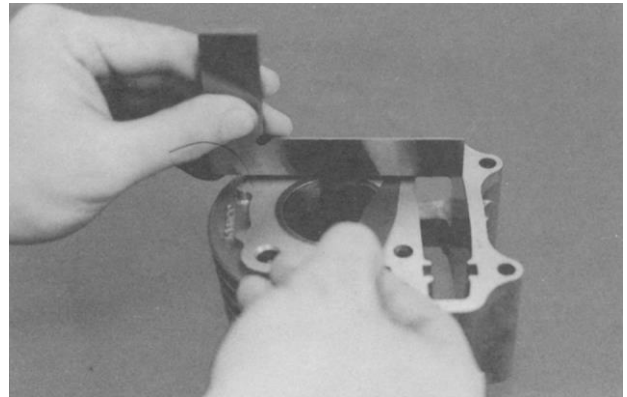

Measure the connecting rod small end I.D.

**Service Limit:** 13.06mm replace if over



### PISTON RING INSTALLATION

Install the piston rings onto the piston.  
Apply engine oil to each piston ring.

- \*
- Be careful not to damage or break the piston and piston rings.
  - All rings should be installed with the markings facing up.
  - After installing the rings, they should rotate freely without sticking.

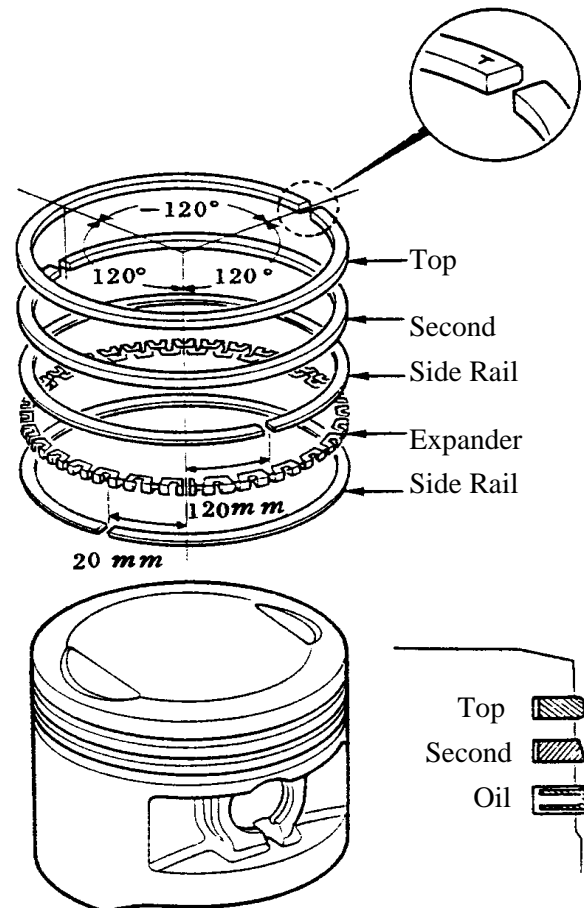

## 8. CYLINDER/PISTON

### PISTON INSTALLATION

Remove any gasket material from the crankcase surface.

- \* Be careful not to drop foreign matters into the crankcase.

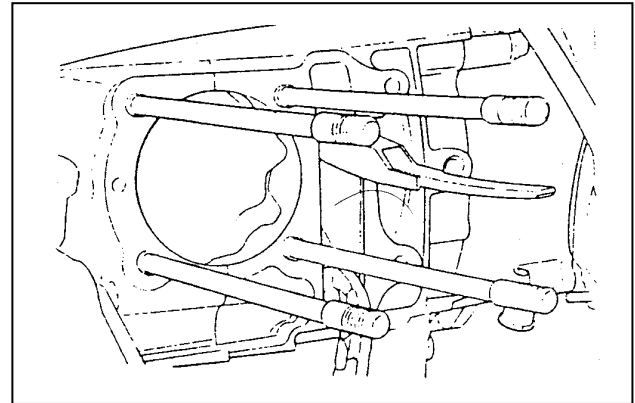

Install the piston, piston pin and a new piston pin clip.

- \*
  - Position the piston “IN” mark on the intake valve side.
  - Place a clean shop towel in the crankcase to keep the piston pin clip from falling into the crankcase.

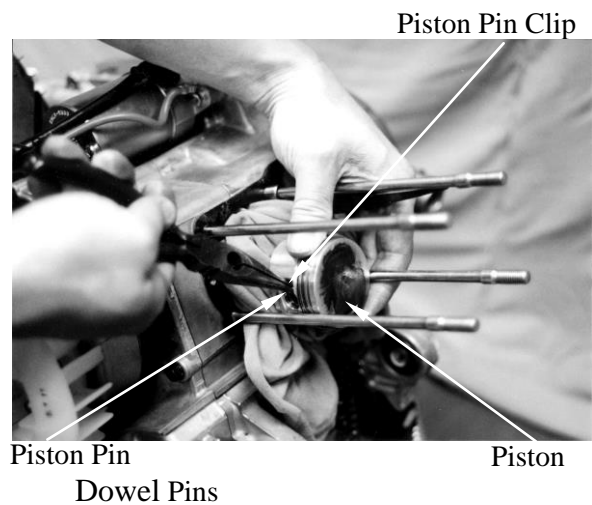

### CYLINDER INSTALLATION

Install the dowel pins and a new cylinder gasket on the crankcase.



Coat the cylinder bore, piston and piston rings with clean engine oil.  
Carefully lower the cylinder over the piston by compressing the piston rings.

- \*
  - Be careful not to damage or break the piston rings.
  - Do not align the ring end gaps with the intake/exhaust valve and piston pin.



## 8. CYLINDER/PISTON

Install the cam chain guide.

- \* Insert the tab on the cam chain guide into the cylinder groove.

Install the cylinder head. (⇒7-8)  
Loosely install the cylinder base bolts.

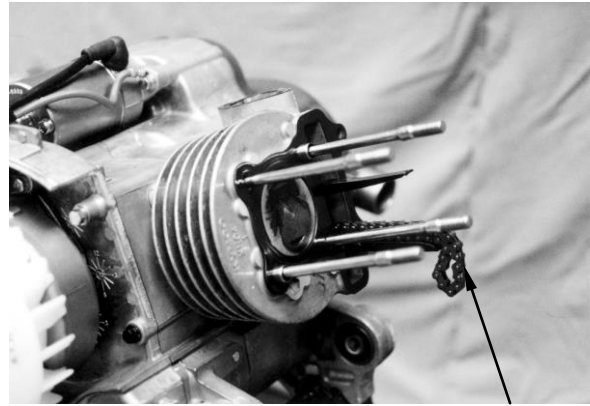

Cam Chain Guide

Tighten the cylinder base bolts.

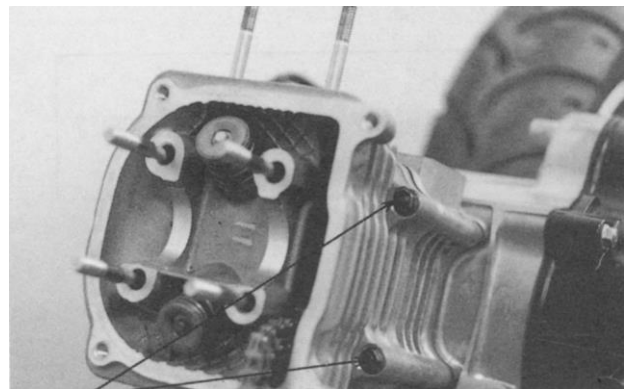

Cylinder Base Bolts

# 9. DRIVE AND DRIVEN PULLEYS

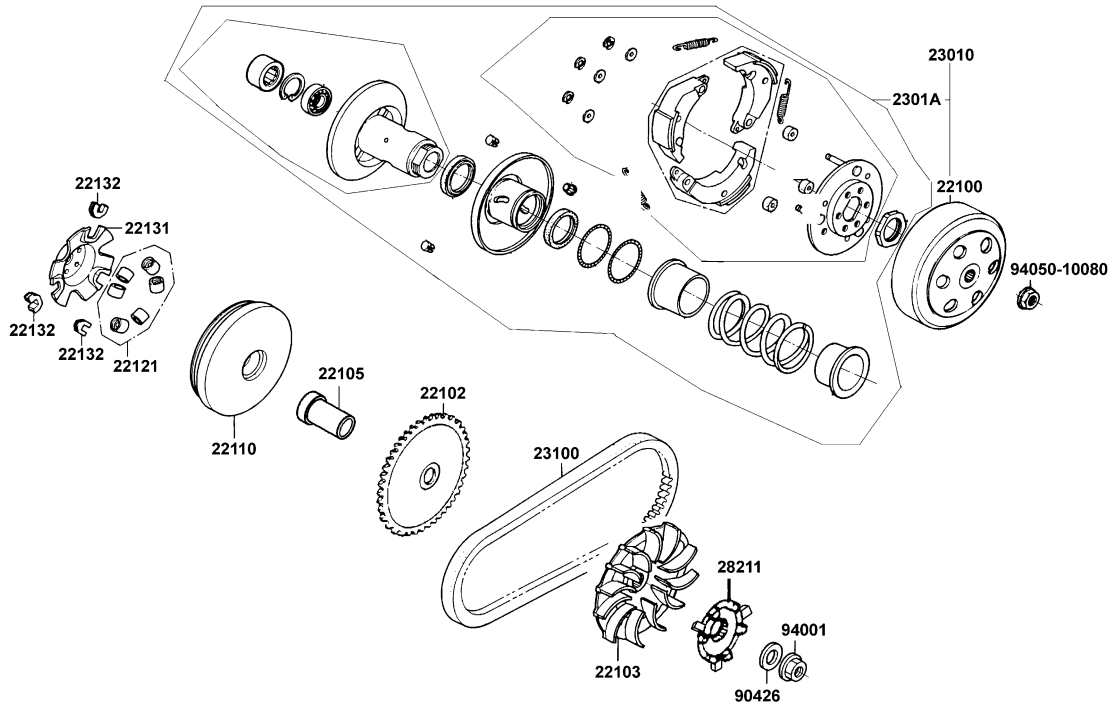
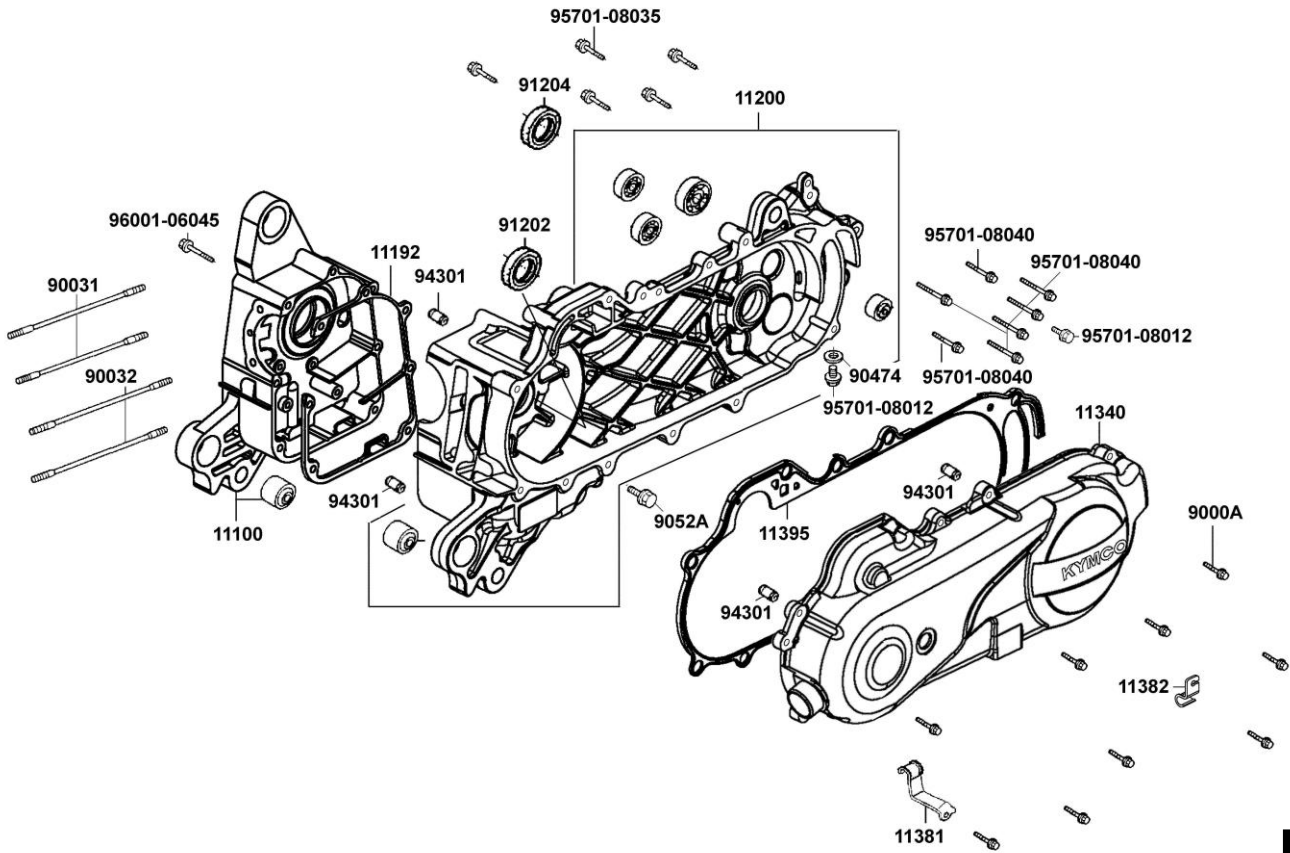

9

SERVICE INFORMATION.....9-1	DRIVE BELT.....9-3
TROUBLESHOOTING.....9-1	DRIVE PULLEY .....9-4
LEFT CRANKCASE COVER.....9-2	CLUTCH/DRIVEN PULLEY .....9-7

## SERVICE INFORMATION

### GENERAL INSTRUCTIONS

- The drive pulley, clutch and driven pulley can be serviced with the engine installed.
- Avoid getting grease and oil on the drive belt and pulley faces. Remove any oil or grease from them to minimize the slipping of drive belt and drive pulley.

### SPECIFICATIONS

Item	Standard (mm)	Service Limit (mm)
Movable drive face bushing I.D.	23.989~24.025	24.06
Drive face collar O.D.	23.960~23.974	23.94
Drive belt width	17.5	16.5
Clutch lining thickness	—	1.5
Clutch outer I.D.	107.0-107.2	107.5
Driven face spring free length	—	154.6
Driven face O.D.	33.965-33.485	33.94
Movable driven face I.D.	34.0-34.025	34.06
Weight roller O.D.	15.920~16.080	15.4

### TORQUE VALUES

Drive face nut	5.5~6.5kgf-m
Clutch outer nut	3.5~4.5kgf-m
Clutch drive plate nut	5.0-6.0kg-m

### SPECIAL TOOLS

Universal holder	Clutch spring compressor
------------------	--------------------------

### TROUBLESHOOTING

#### Engine starts but motorcycle won't move

- Worn drive belt
- Broken ramp plate
- Worn or damaged clutch lining
- Broken driven face spring

#### Engine stalls or motorcycle creeps

- Broken clutch weight spring

#### Lack of power

- Worn drive belt
- Weak driven face spring
- Worn weight roller
- Fouled drive face

## LEFT CRANKCASE COVER

### REMOVAL

Loosen the drive belt air tube band screw.  
Remove the 7 left crankcase cover bolts and two Anti-modification Bolts .  
Remove the seal gasket and dowel pins.  
Inspect the seal gasket for damage or deterioration.

\* Use specified genuine parts for replacement.



### LEFT CRANKCASE COVER INSTALLATION

First install the dowel pins.  
Install the seal rubber.

Install the left crankcase cover and the six left crankcase cover bolts and two Anti-modification Bolts .  
Connect the drive belt air tube and tighten the tube band screw.  
Install the rear brake cable clamp.

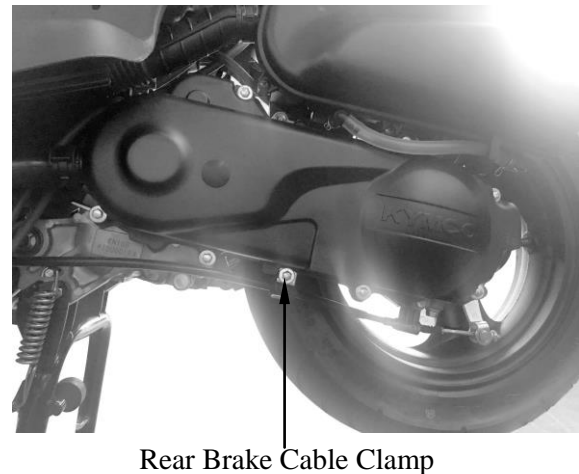
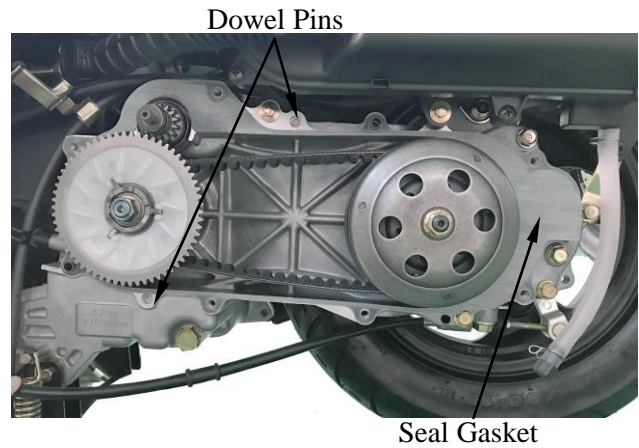
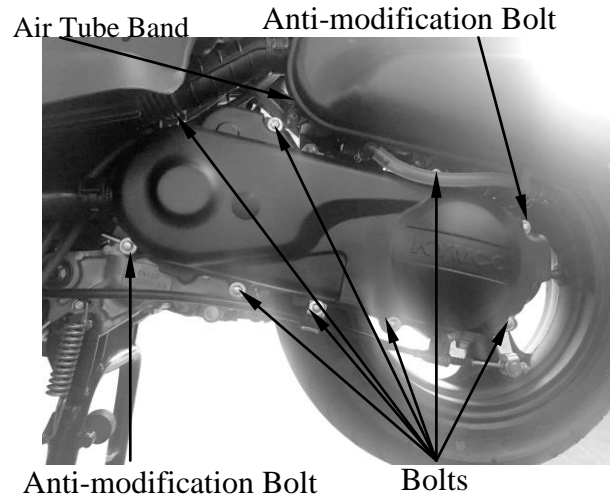

## 9. DRIVE AND DRIVEN PULLEYS

### DRIVE BELT

#### REMOVAL

Remove the left crankcase cover.

#### INSPECTION

Check the drive belt for cracks, separation or abnormal or excessive wear.

Measure the drive belt width.

**Service Limit:** 16.5mm

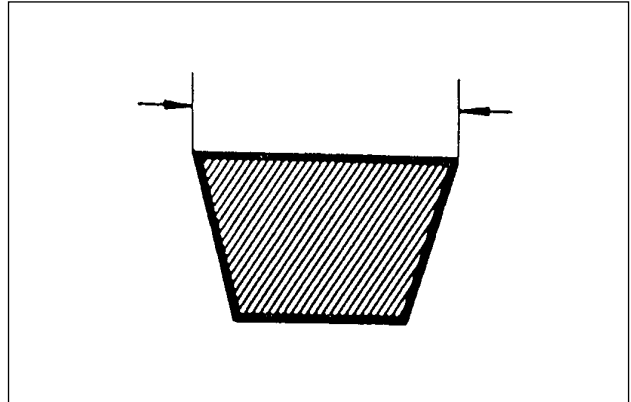

#### REPLACEMENT

Remove the eight left crankcase cover bolts and left crankcase cover. (⇒9-2)

Hold the clutch outer with an universal holder and remove the clutch outer nut.

**Special**

Universal Holder

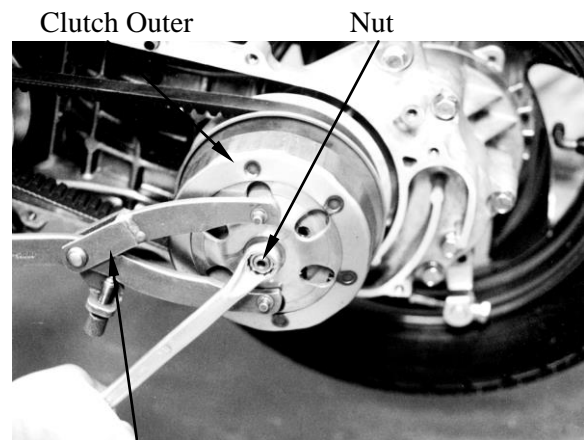

Universal Holder

Hold the drive pulley using a holder and remove the drive face nut, starting ratchet and washer.

Remove the drive pulley face.

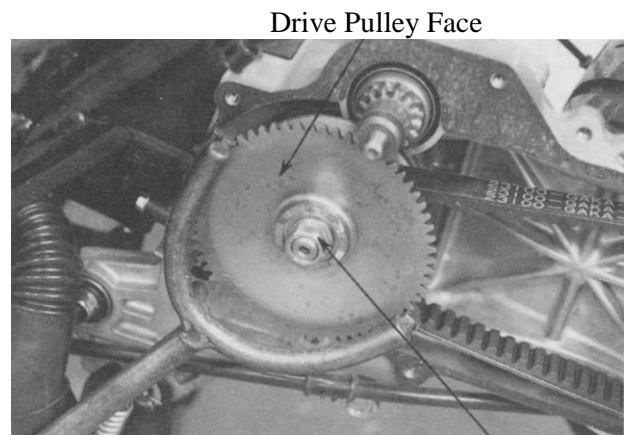

Drive Face Nut

Remove the drive belt from the clutch/driven pulley.

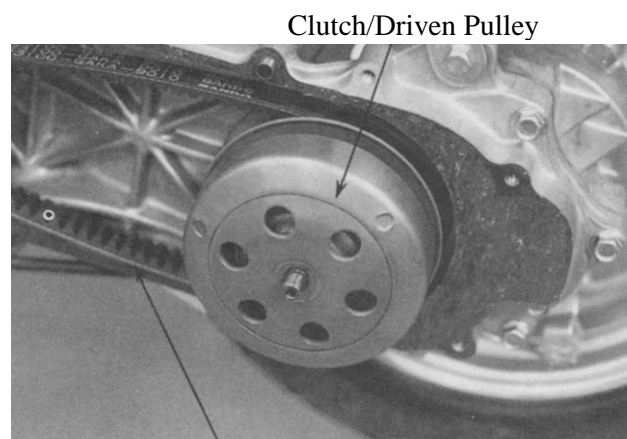

Clutch/Driven Pulley



# 9. DRIVE AND DRIVEN PULLEYS

## INSTALLATION

Turn the driven pulley clockwise to widen the drive belt groove and lay a new drive belt on the driven pulley.

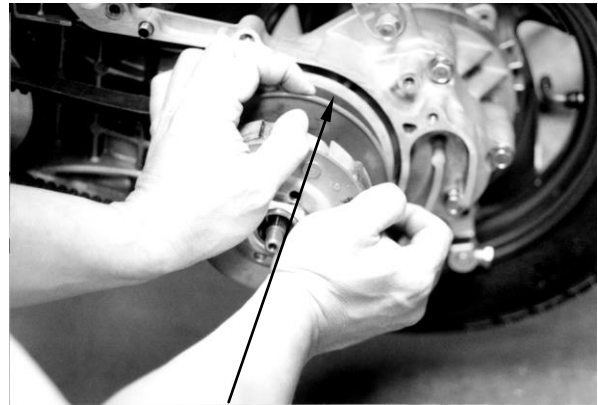

Drive Belt

Set the drive belt on the drive pulley face collar.  
Install the drive pulley face, starting ratchet washer. Install and tighten the drive face nut.

\* When installing, align the tooth space of the drive pulley face and starting ratchet with the crankshaft tooth and then tighten the nut.

Drive Face Nut Drive Pulley Face Drive Belt

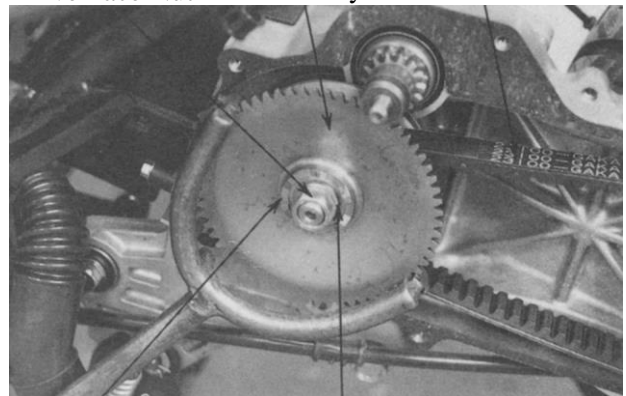

Starting Ratchet 10mmWasher

Drive Pulley Face Starting Ratchet

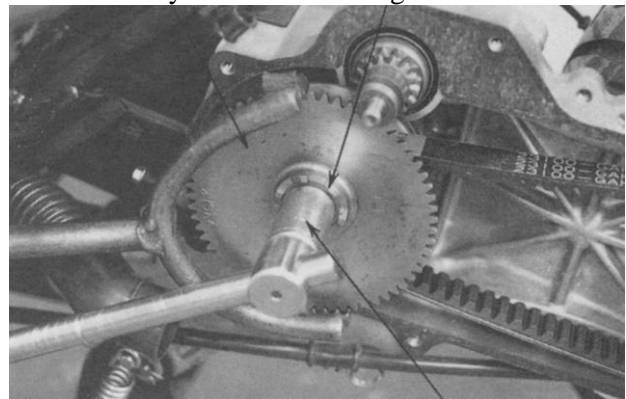

Drive Face Nut (10mm)

Movable Drive Face Assembly

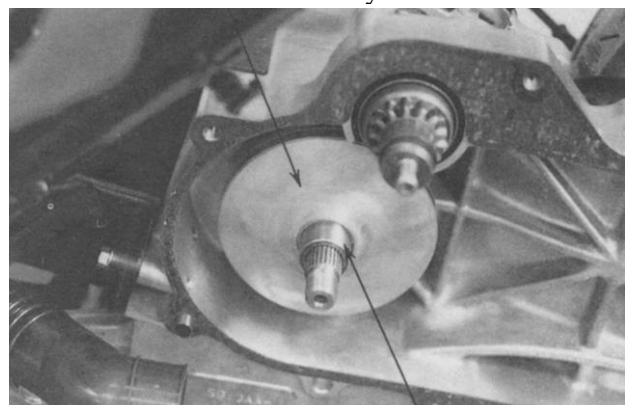

Drive Pulley Collar

## DRIVE PULLEY

### REMOVAL

Hold the drive pulley using a holder and remove the drive face nut, starting ratchet and washer.  
Remove the drive pulley face.

### DISASSEMBLY

Remove the movable drive face assembly and drive pulley collar from the crankshaft.

## 9. DRIVE AND DRIVEN PULLEYS

Remove the ramp plate.

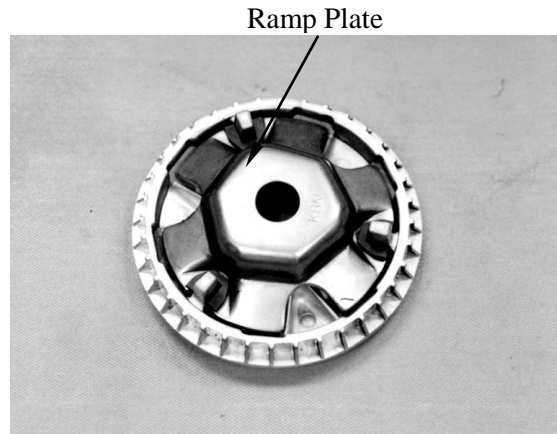

Remove the weight rollers.

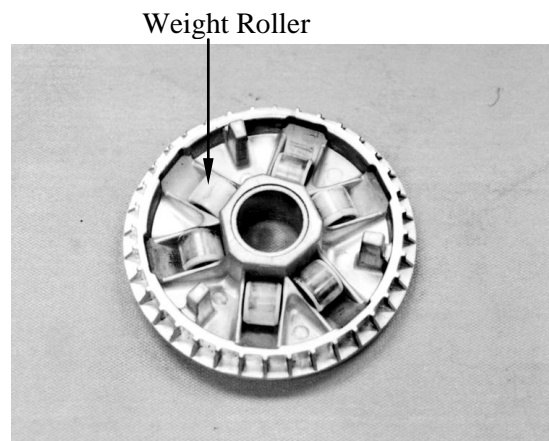

### INSPECTION

Check each weight roller for wear or damage.  
Measure each weight roller O.D.

**Service Limit:** 12.4mm replace if below

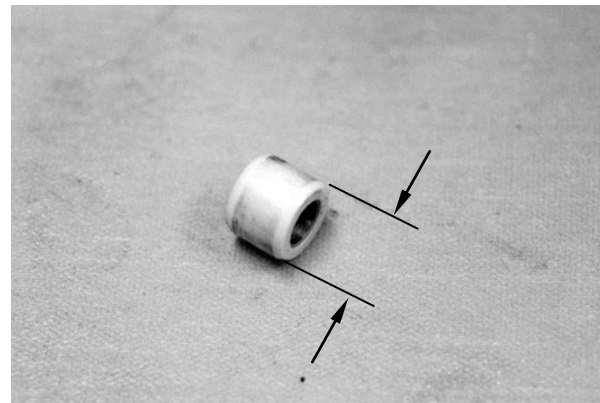

Check the drive pulley collar for wear or damage.  
Measure the O.D. of the drive pulley collar sliding surface.

**Service Limit:** 19.97mm replace if below

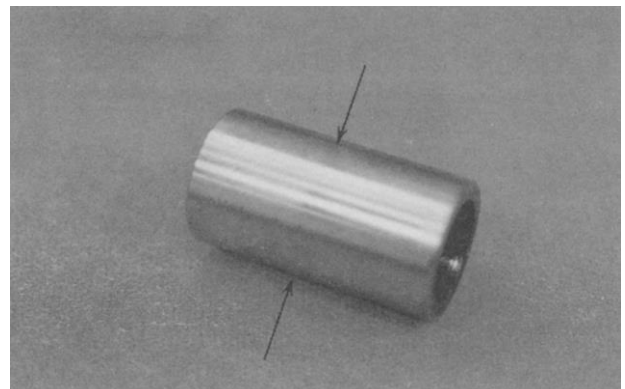

## 9. DRIVE AND DRIVEN PULLEYS

### INSTALLATION

Install the drive pulley collar and movable drive face onto the crankshaft.

Movable Drive Face

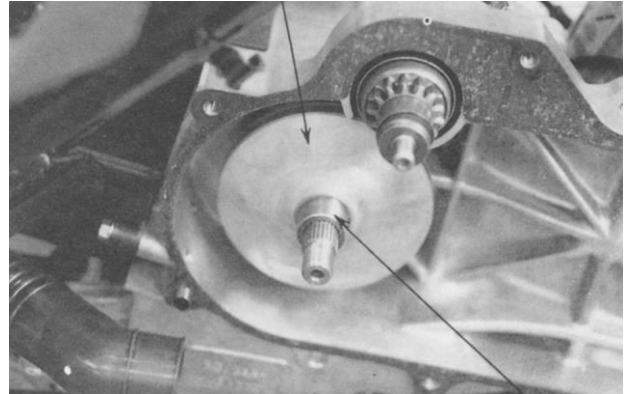

Drive Pulley Collar

Set the drive belt on the drive pulley collar. Install the drive pulley face and tighten the drive face nut. (⇒9-6)

**Torque:** 5.5~6.5kgf-m

\* Do not get oil or grease on the drive belt or pulley faces.

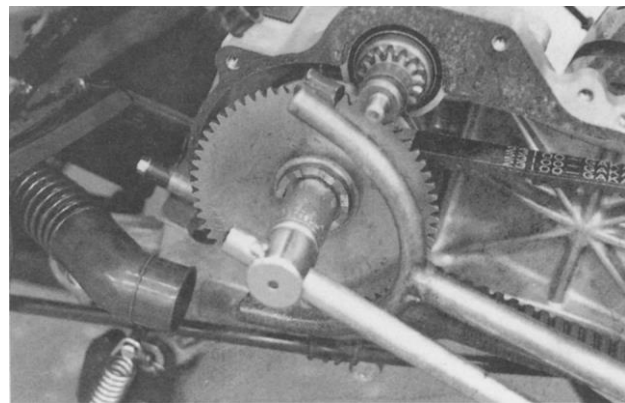

### STARTER PINION

#### REMOVAL

Remove the left crankcase cover.  
Remove the drive pulley.  
Remove the starter pinion holder.  
Remove the starter pinion.

#### INSPECTION

Inspect the starter pinion shaft forcing part for wear or damage.  
Inspect the starter pinion for smooth operation.  
Inspect the starter pinion and shaft for wear or damage.

#### INSTALLATION

Apply a small amount of grease to the starter pinion shaft and install it in the reverse order of removal.

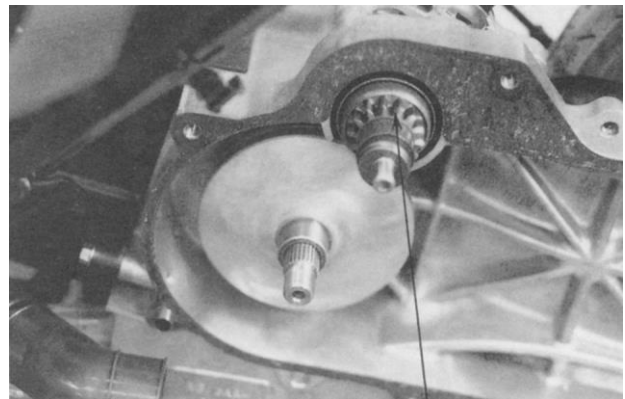

Starter Pinion  
Starter Pinion Shaft

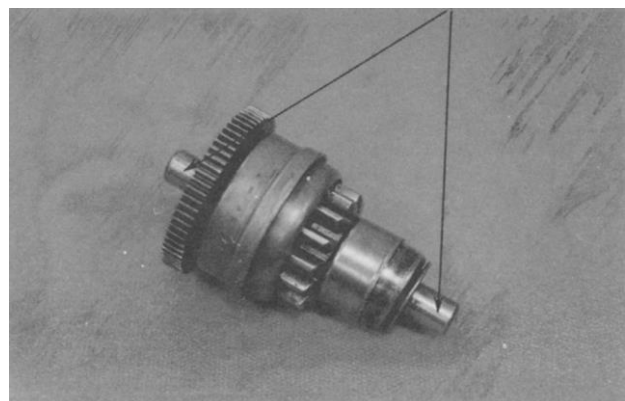

## CLUTCH/DRIVEN PULLEY

### REMOVAL

Remove the drive pulley. (⇒9-6)  
Hold the clutch outer with the universal holder and remove the clutch outer nut.  
Remove the clutch outer.

**Special**

Universal Holder

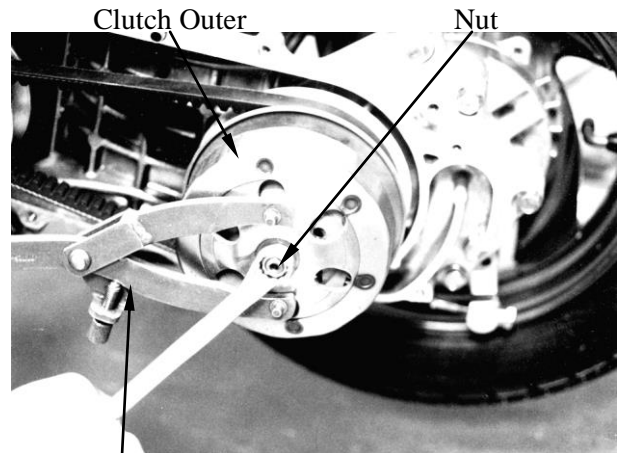

Universal Holder

Remove the clutch/driven pulley assembly  
Remove the drive belt from the clutch/driven pulley assembly.

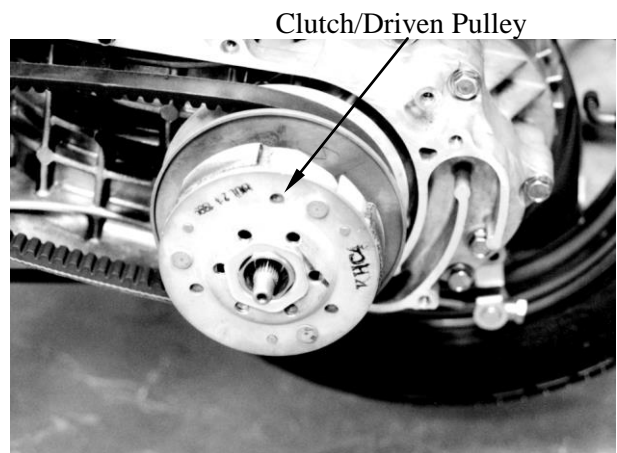

### DISASSEMBLY

Hold the clutch/driven pulley assembly with the clutch spring compressor.  
Set the clutch spring compressor in a vise and remove the 39mm clutch drive plate nut.  
Loosen the clutch spring compressor and disassemble the driven pulley assembly.

**Special**

Clutch Spring Compressor

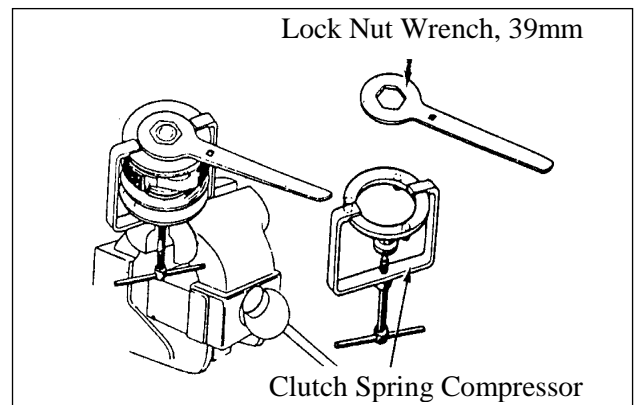

Remove the seal collar.

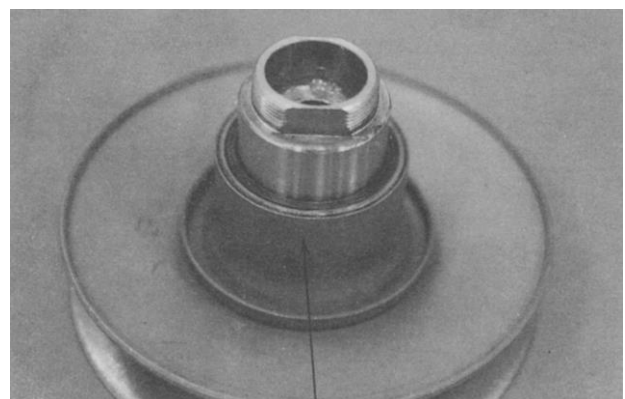

Seal Collar

## 9. DRIVE AND DRIVEN PULLEYS

Pull out the guide roller pins and guide rollers.  
Remove the movable driven face from the driven face.  
Remove the O-rings and oil seal from the movable driven face.

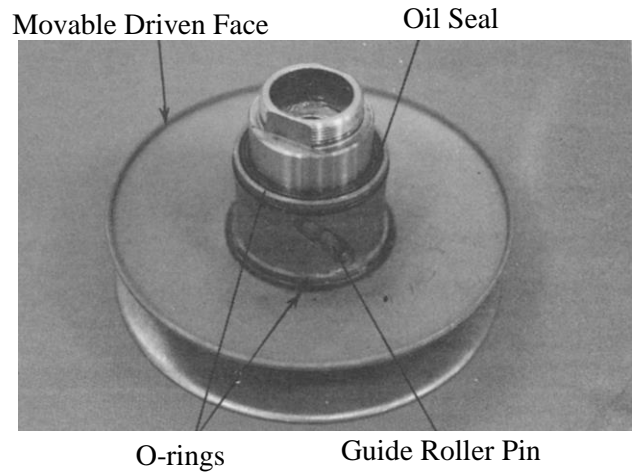

### INSPECTION

Inspect the clutch outer for wear or damage.  
Measure the clutch outer I.D.

**Service Limit:** 107.5mm replace if over

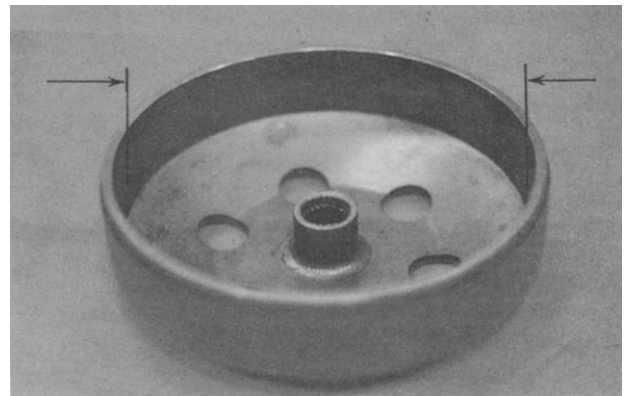

Check the clutch shoes for wear or damage.  
Measure the clutch lining thickness.

**Service Limit:** 2.0mm replace if below

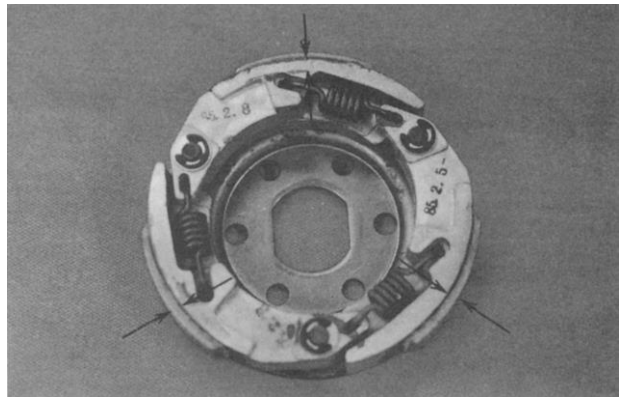

Measure the driven face spring free length.

**Service Limit:** 92.8mm replace if below

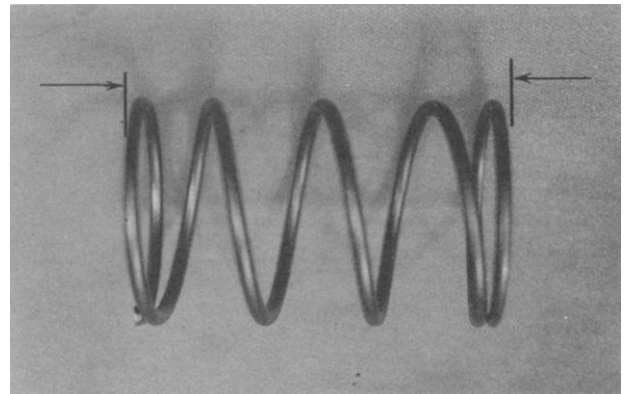

## 9. DRIVE AND DRIVEN PULLEYS

Check the driven face for wear or damage.  
Measure the driven face O.D.

**Service Limit:** 33.94mm replace if below

Check the movable driven face for wear or damage.

Measure the movable driven face I.D.

**Service Limit:** 34.06mm replace if over

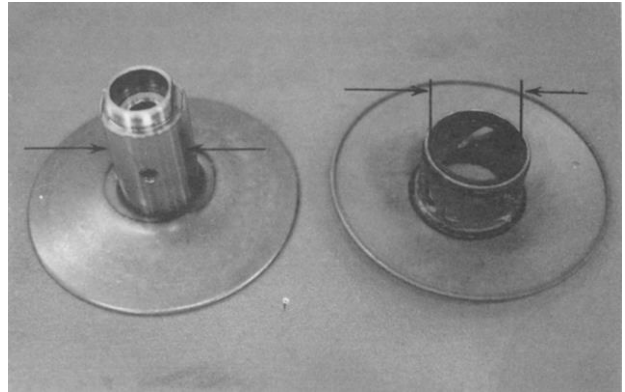

### DRIVEN PULLEY FACE BEARING REPLACEMENT

Drive the inner needle bearing out of the driven pulley face.

Discard the removed bearing and replace with a new one.

Inner Bearing

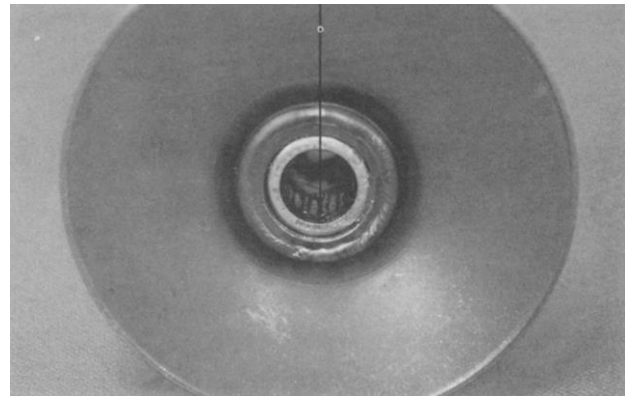

Remove the snap ring and drive the outer bearing out of the driven face.

Snap Ring

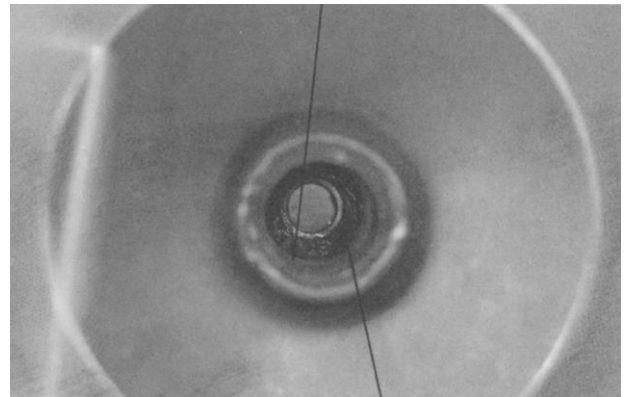

Outer Bearing  
Bearing Remover

Apply grease to the outer bearing.  
Drive a new outer bearing into the driven face with the sealed end facing up.  
Seat the snap ring in its groove.

\* Pack all bearing cavities with 5.0~5.6g grease.  
Specified grease: Heat resistance 230°C



## 9. DRIVE AND DRIVEN PULLEYS

Press a new needle bearing into the driven face.

### ASSEMBLY

Install the movable driven face onto the driven face.  
Install the O-rings, guide rollers and guide roller pins.  
Install the a new oil seal.

Install the seal collar.

Set the driven pulley assembly, driven face spring and clutch assembly onto the clutch spring compressor.  
Compress the clutch spring compressor and install the 39mm drive plate nut.  
Set the clutch spring compressor in a vise and tighten the drive plate nut to the specified torque.

**Torque:** 5.0~6.0kgf-m

**Special**

Clutch Spring Compressor

Driver Handle

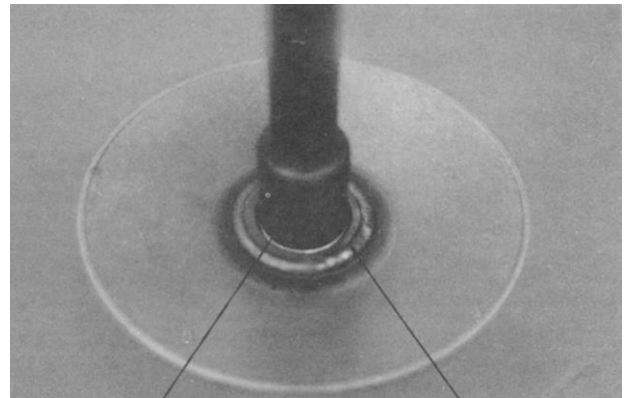

Outer Driver, 24x26mm      Pilot, 17mm  
Movable Driven Face      Oil Seal

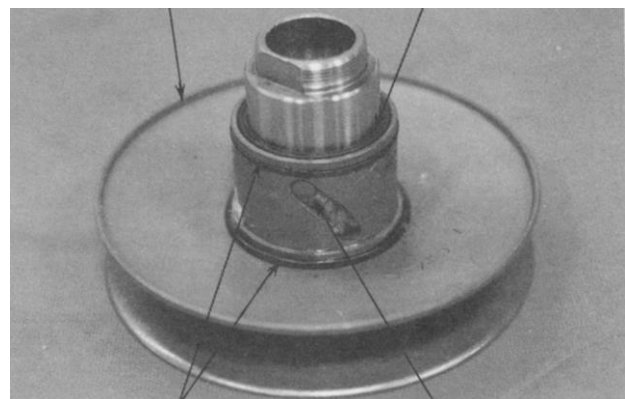

O-rings      Guide Roller Pin

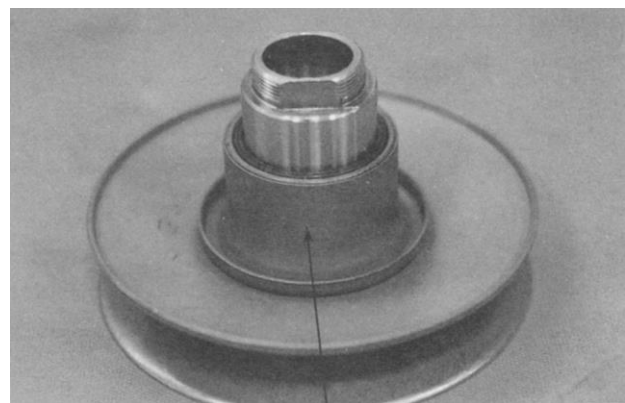

Seal Collar  
Lock Nut Wrench, 39mm

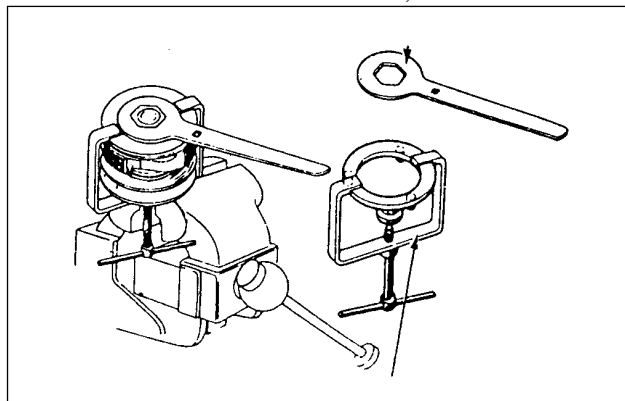

Clutch Spring Compressor



## 9. DRIVE AND DRIVEN PULLEYS

### INSTALLATION

Lay the drive belt on the driven pulley and install the clutch/driven pulley onto the drive shaft.

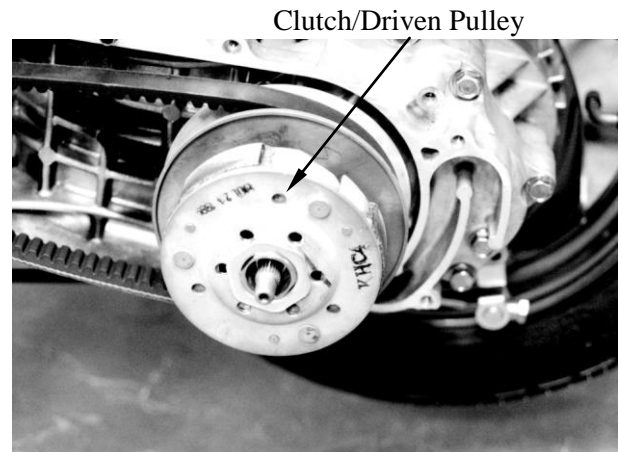

Install the clutch outer.  
Hold the clutch outer with the universal holder.  
Install and tighten the 10mm clutch outer nut.  
**Torque:** 3.5~4.5kgf-m  
Install the left crankcase cover. (⇒9-4)

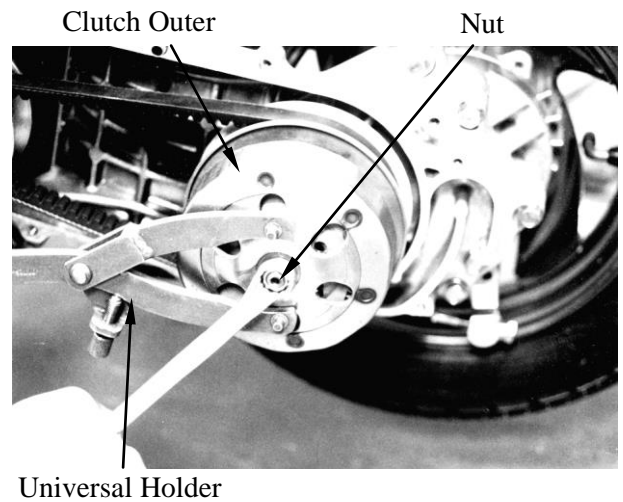



# 10. FINAL REDUCTION

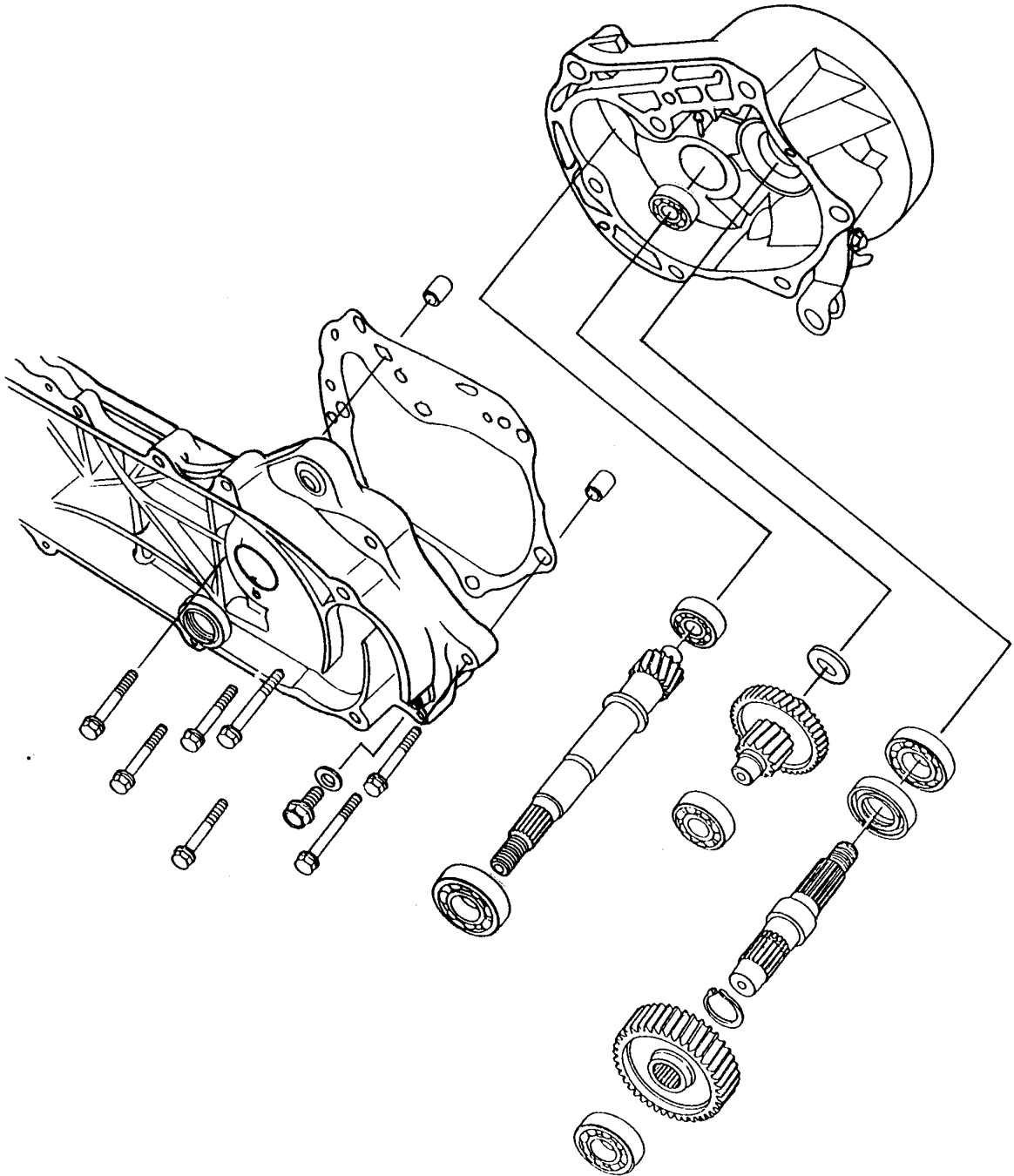

**10**

# 10. FINAL REDUCTION

---

SERVICE INFORMATION .....	10-1	FINAL REDUCTION INSPECTION .....	10-2
TROUBLESHOOTING .....	10-1	BEARING REPLACEMENT .....	10-3
FINAL REDUCTION DISASSEMBLY ....	10-2	FINAL REDUCTION ASSEMBLY .....	10-4

## SERVICE INFORMATION

### SPECIFICATIONS

Specified Oil: GEAR OIL SAE 90#

Oil Capacity:           At disassembly : 0.18 liter  
                                  At change           : 0.15 liter

### SPECIAL TOOLS

Bearing puller, 10,12,15,18mm

## TROUBLESHOOTING

### Engine starts but motorcycle won't move

- Damaged transmission
- Seized or burnt transmission
- Faulty drive belt
- Faulty clutch

### Abnormal noise

- Worn, seized or chipped gears
- Worn bearing

### Oil leaks

- Oil level too high
- Worn or damaged oil seal

## 10. FINAL REDUCTION

### FINAL REDUCTION DISASSEMBLY

- Remove the rear brake cable. (⇒13-3)
- Remove the rear wheel. (⇒13-2)
- Remove the left crankcase cover. (⇒9-2)
- Remove the clutch/driven pulley. (⇒9-10)
- Drain the transmission gear oil into a clean container.
- Remove the transmission case cover attaching bolts.
- Remove the transmission case cover.
- Remove the gasket and dowel pins.

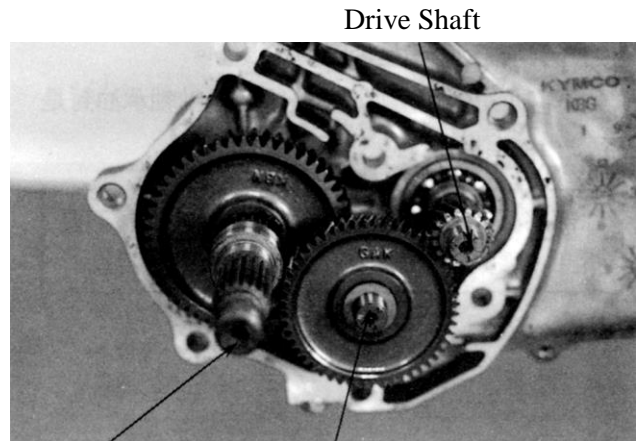

Remove the final gear and countershaft.

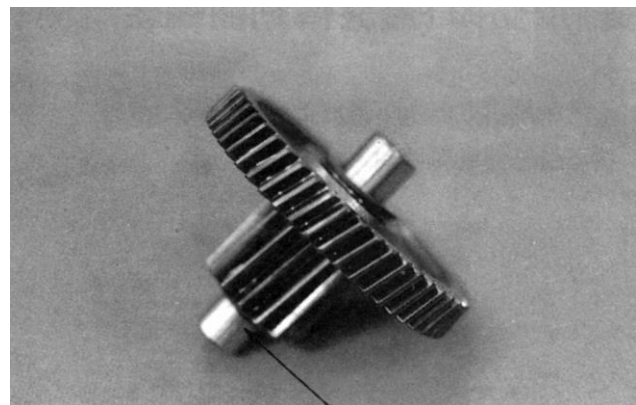

### FINAL REDUCTION INSPECTION

Inspect the countershaft and gear for wear or damage.

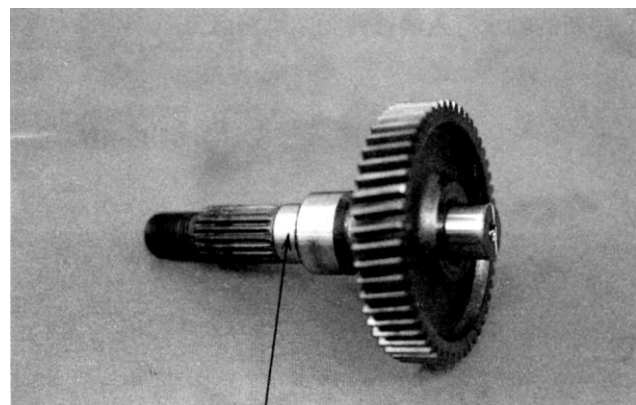

Inspect the final gear and final shaft for wear, damage or seizure.

Check the left crankcase bearings for excessive play and inspect the oil seal for wear or damage.



# 10. FINAL REDUCTION

Inspect the drive shaft and gear for wear or damage.  
 Check the transmission case cover bearings for excessive play and inspect the final shaft bearing oil seal for wear or damage.

\* Do not remove the transmission case cover except for necessary part replacement. When replacing the drive shaft, also replace the bearing and

## BEARING REPLACEMENT (TRANSMISSION CASE COVER)

Remove the transmission case cover bearings using a bearing puller.  
 Remove the final shaft oil seal.

**Special**

Bearing Puller

Drive new bearings into the transmission case cover.

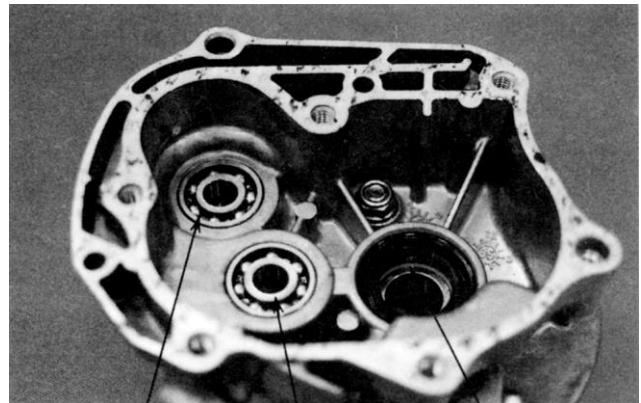

Countershaft Bearing Drive Shaft Bearing Oil Seal  
 Final Shaft Bearing

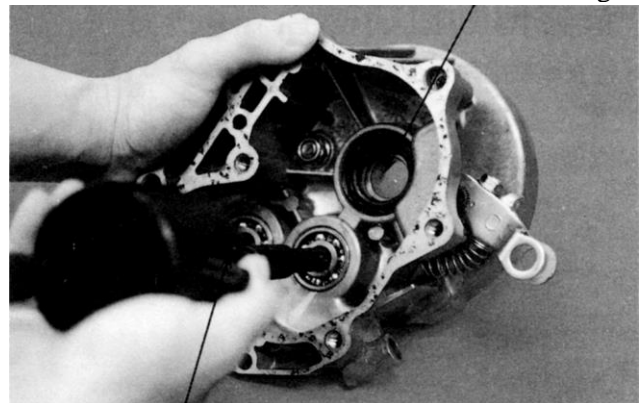

Bearing Puller



Outer Driver, 32x35mm

Drive Shaft Bearing

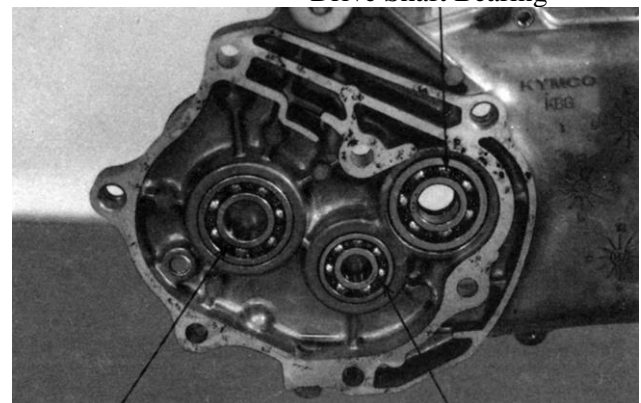

Final Shaft Bearing

Countershaft Bearing

## 10. FINAL REDUCTION

### BEARING REPLACEMENT (LEFT CRANKCASE)

Remove the drive shaft.  
Remove the drive shaft oil seal.  
Remove the left crankcase bearings using a bearing puller.

**Special**

Bearing Puller

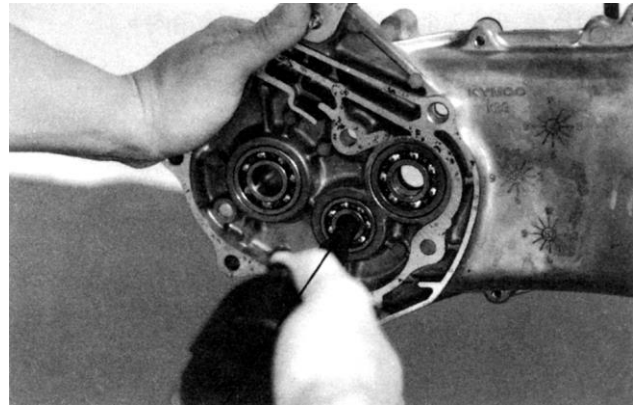

Bearing Puller, 12mm

Drive new bearings into the left crankcase.  
Install a new drive shaft oil seal.

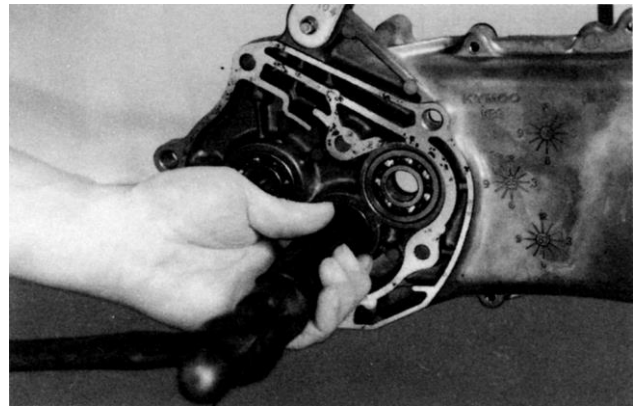

Pilot

### FINAL REDUCTION ASSEMBLY

Install the drive shaft into the left crankcase.

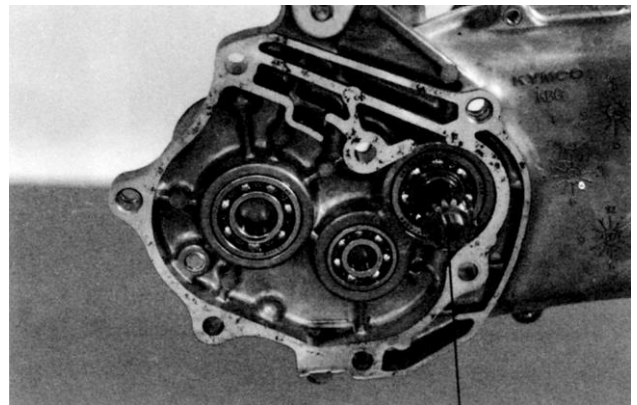

Drive Shaft

Install the final gear and final shaft into the left crankcase.

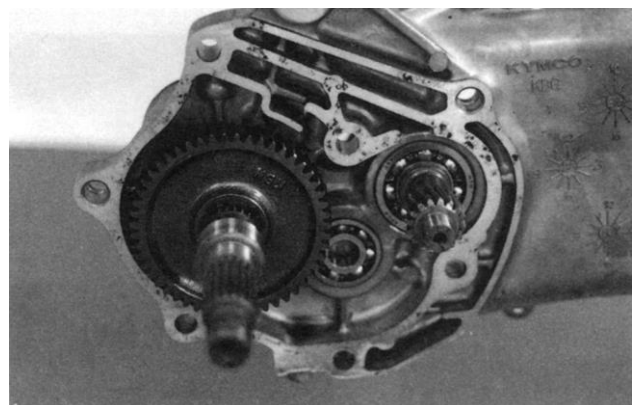

# 10. FINAL REDUCTION

Install the countershaft and gear into the left crankcase.  
 Install the resin washer onto the countershaft.  
 Install the dowel pins and a new gasket.

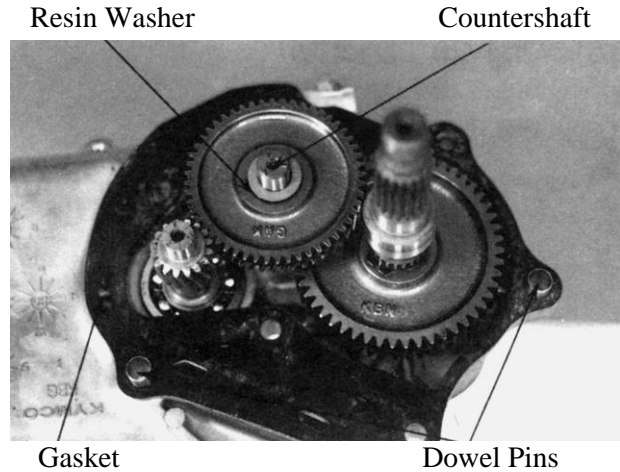

Install the transmission case cover.

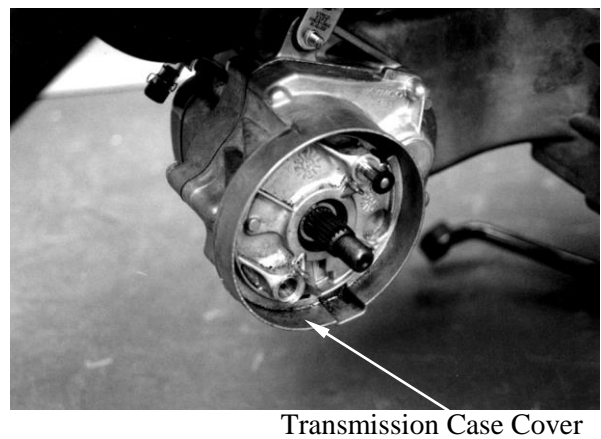

Install and tighten the transmission case cover bolts.  
 Install the clutch/driven pulley. (⇒9-13)

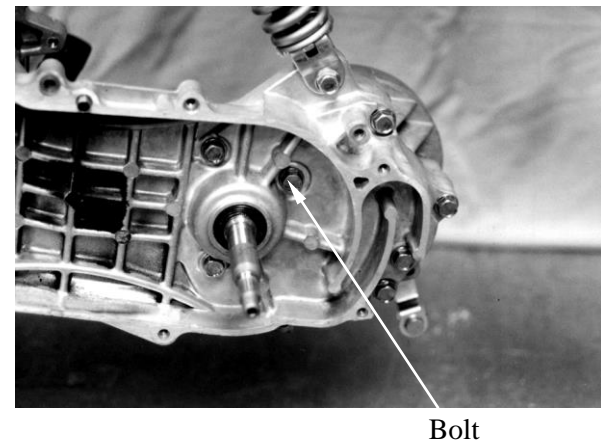

After installation, fill the transmission case with the specified oil. (⇒3-7)

- \* 
  - Place the motorcycle on its main stand on level ground.
  - Check the oil sealing washer for wear or damage.

**Specified Gear Oil:** SAE90#

**Oil Capacity:**

At disassembly : 0.18 liter

At change : 0.15 liter

Install and tighten the oil check bolt.

**Torque:** 0.8~1.2kgf-m

Start the engine and check for oil leaks.  
 Check the oil level from the oil check bolt hole and add the specified oil to the proper level if the oil level is low.

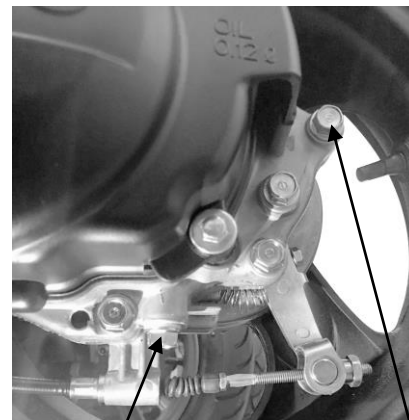

# 10. FINAL REDUCTION

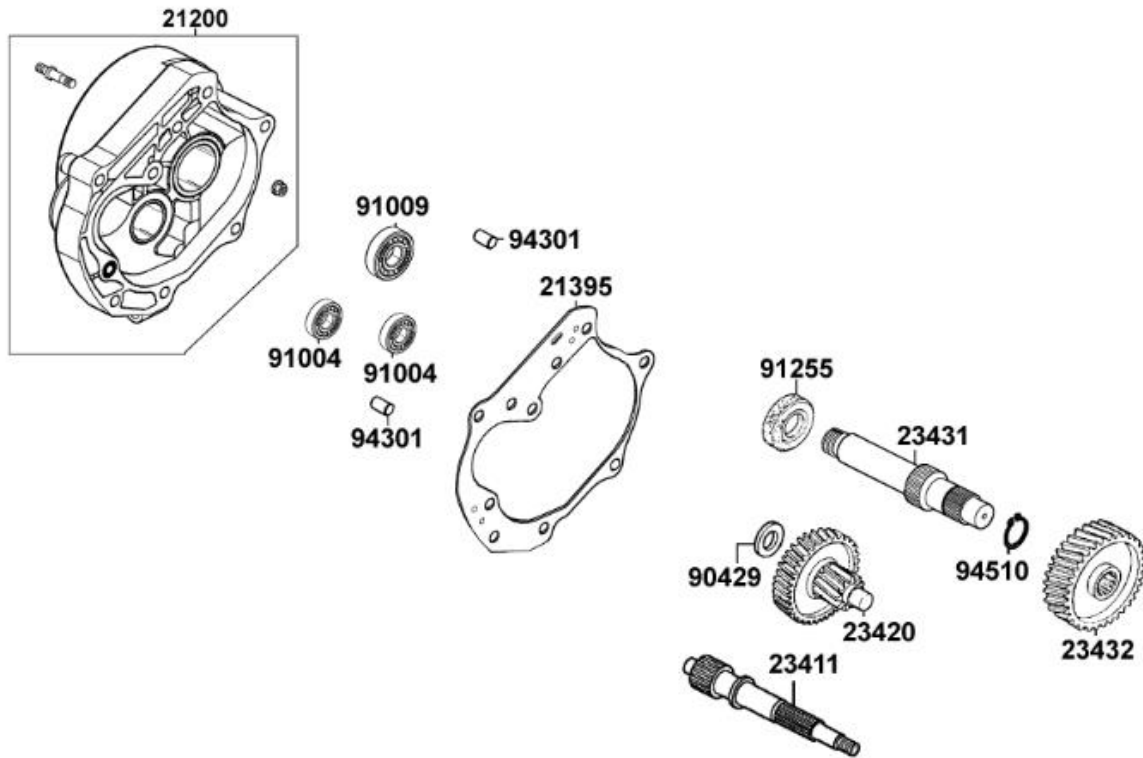

10

# 10. FINAL REDUCTION

---

SERVICE INFORMATION .....10-1	FINAL REDUCTION INSPECTION ..... 10-2
TROUBLESHOOTING.....10-1	BEARING REPLACEMENT ..... 10-3
FINAL REDUCTION DISASSEMBLY ....10-2	FINAL REDUCTION ASSEMBLY ..... 10-4

## SERVICE INFORMATION

### SPECIFICATIONS

Specified Oil: GEAR OIL SAE 90#

Oil Capacity:           At disassembly : 0.18 liter  
                                  At change           : 0.15 liter

### SPECIAL TOOLS

Bearing puller, 10,12,15,18mm

## TROUBLESHOOTING

### Engine starts but motorcycle won't move

- Damaged transmission
- Seized or burnt transmission
- Faulty drive belt
- Faulty clutch

### Abnormal noise

- Worn, seized or chipped gears
- Worn bearing

### Oil leaks

- Oil level too high
- Worn or damaged oil seal



## 10. FINAL REDUCTION

### FINAL REDUCTION DISASSEMBLY

- Remove the rear brake cable. (⇒13-3)
- Remove the rear wheel. (⇒13-2)
- Remove the left crankcase cover. (⇒9-2)
- Remove the clutch/driven pulley. (⇒9-10)
- Drain the transmission gear oil into a clean container.
- Remove the transmission case cover attaching bolts.
- Remove the transmission case cover.
- Remove the gasket and dowel pins.

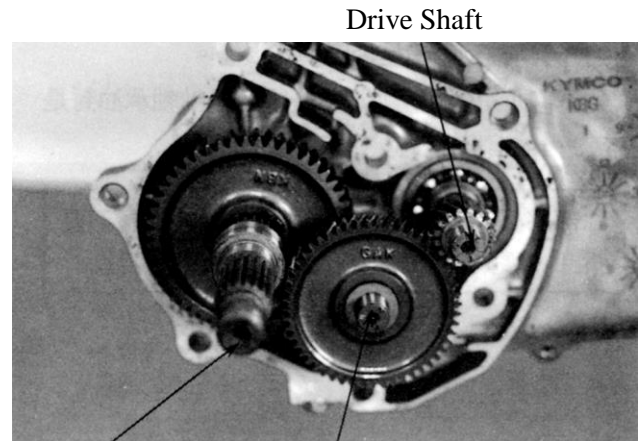

Remove the final gear and countershaft.

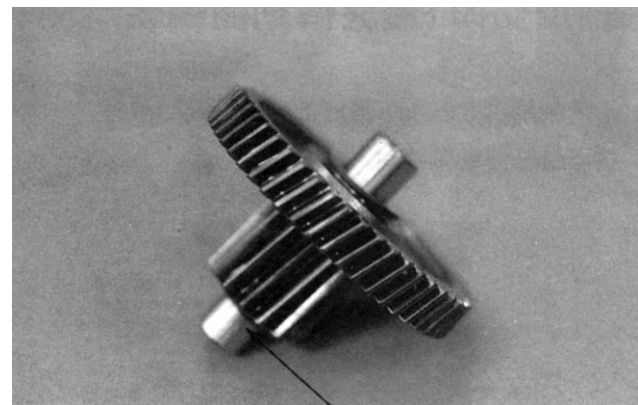

### FINAL REDUCTION INSPECTION

Inspect the countershaft and gear for wear or damage.

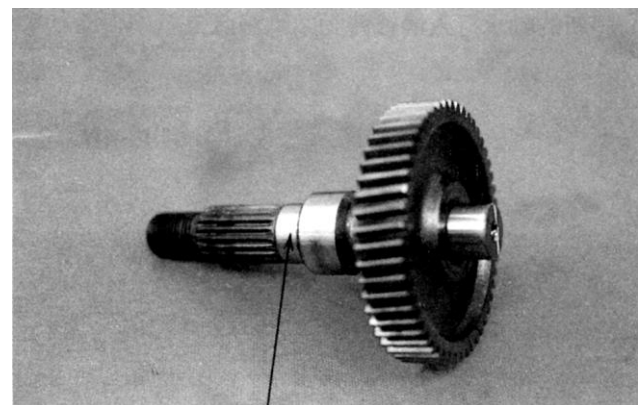

Inspect the final gear and final shaft for wear, damage or seizure.

Check the left crankcase bearings for excessive play and inspect the oil seal for wear or damage.



# 10. FINAL REDUCTION

Inspect the drive shaft and gear for wear or damage.  
 Check the transmission case cover bearings for excessive play and inspect the final shaft bearing oil seal for wear or damage.

\* Do not remove the transmission case cover except for necessary part replacement. When replacing the drive shaft, also replace the bearing and

## BEARING REPLACEMENT (TRANSMISSION CASE COVER)

Remove the transmission case cover bearings using a bearing puller.  
 Remove the final shaft oil seal.

**Special**

Bearing Puller

Drive new bearings into the transmission case cover.

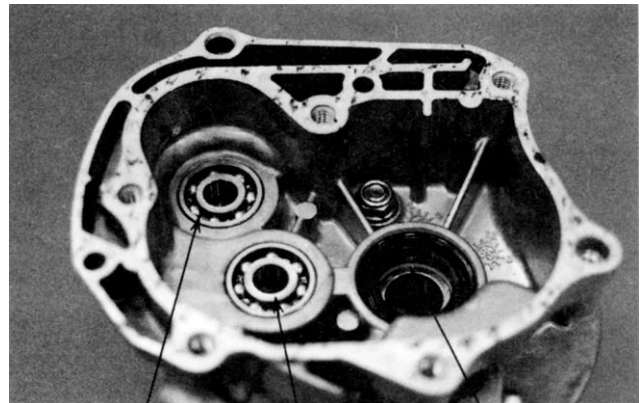

Countershaft Bearing Drive Shaft Bearing Oil Seal  
 Final Shaft Bearing

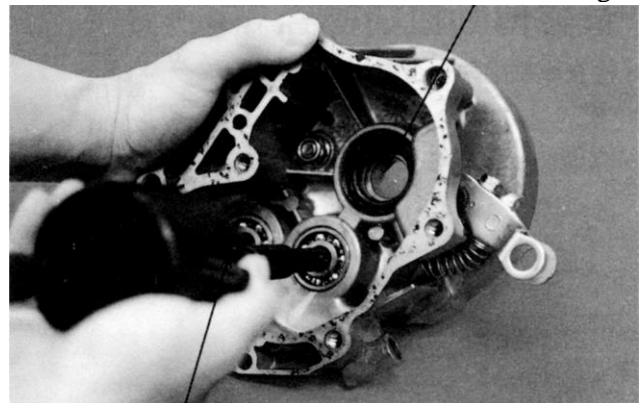

Bearing Puller



Outer Driver, 32x35mm

Drive Shaft Bearing

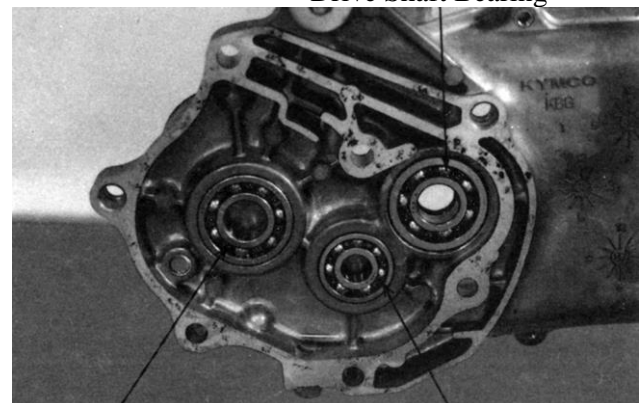

Final Shaft Bearing

Countershaft Bearing

## 10. FINAL REDUCTION

### BEARING REPLACEMENT (LEFT CRANKCASE)

Remove the drive shaft.  
Remove the drive shaft oil seal.  
Remove the left crankcase bearings using a bearing puller.

**Special**

Bearing Puller

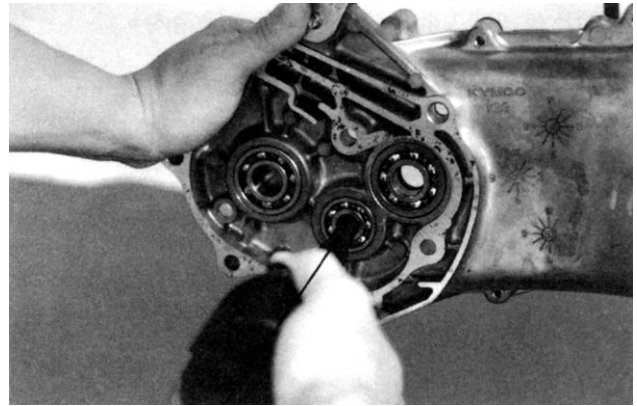

Bearing Puller, 12mm

Drive new bearings into the left crankcase.  
Install a new drive shaft oil seal.

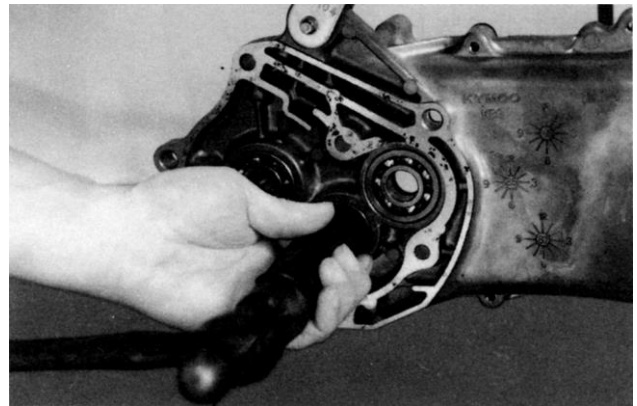

Pilot

### FINAL REDUCTION ASSEMBLY

Install the drive shaft into the left crankcase.

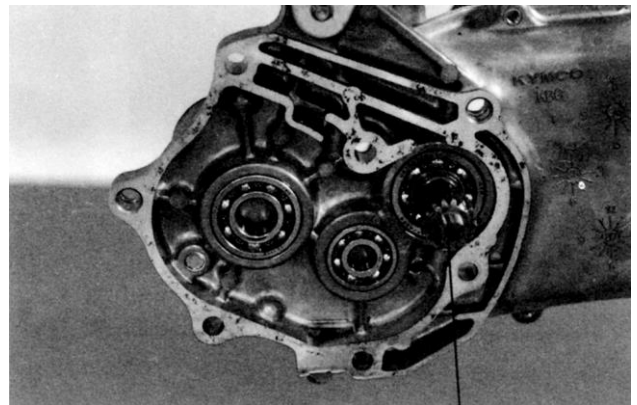

Drive Shaft

Install the final gear and final shaft into the left crankcase.

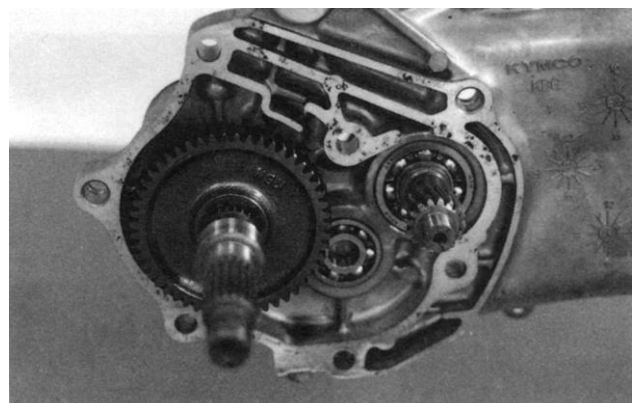

# 10. FINAL REDUCTION

Install the countershaft and gear into the left crankcase.  
 Install the resin washer onto the countershaft.  
 Install the dowel pins and a new gasket.

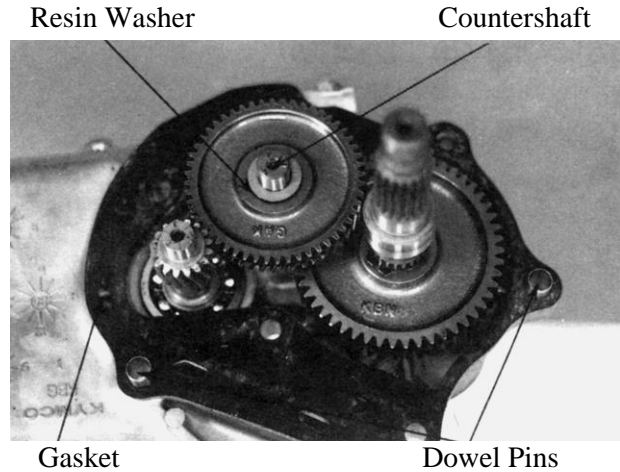

Install the transmission case cover.

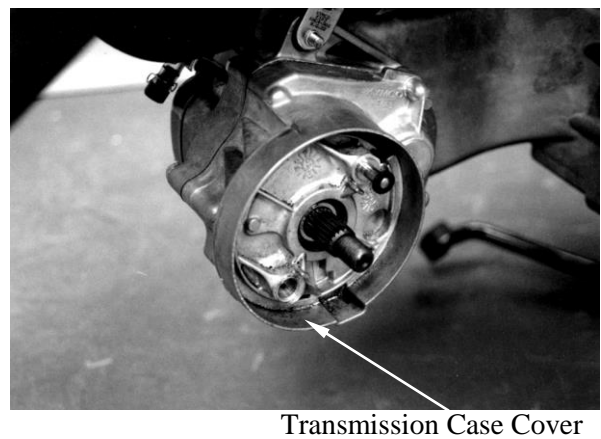

Install and tighten the transmission case cover bolts.  
 Install the clutch/driven pulley. (⇒9-13)

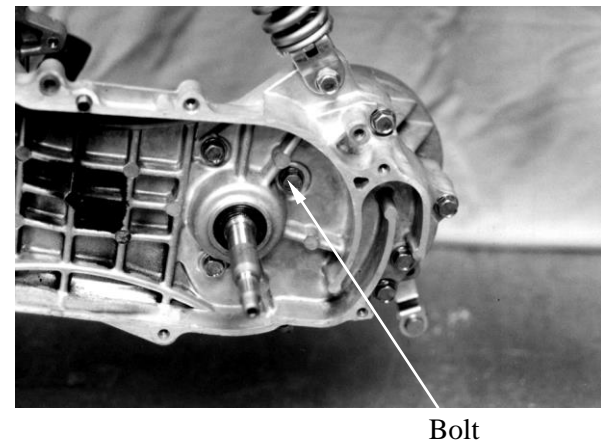

After installation, fill the transmission case with the specified oil. (⇒3-7)

- \***
- Place the motorcycle on its main stand on level ground.
  - Check the oil sealing washer for wear or damage.

**Specified Gear Oil:** SAE90#

**Oil Capacity:**

At disassembly : 0.18 liter

At change : 0.15 liter

Install and tighten the oil check bolt.

**Torque:** 0.8~1.2kgf-m

Start the engine and check for oil leaks.  
 Check the oil level from the oil check bolt hole and add the specified oil to the proper level if the oil level is low.

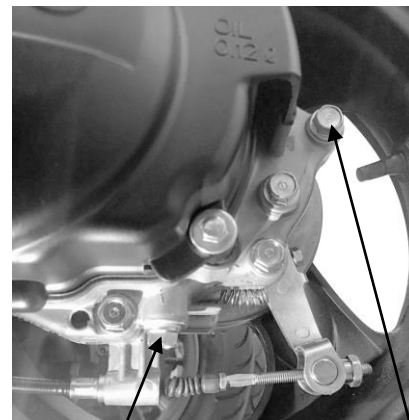

# 11. CRANKCASE/CRANKSHAFT

Agility Carry / Delivery 50i

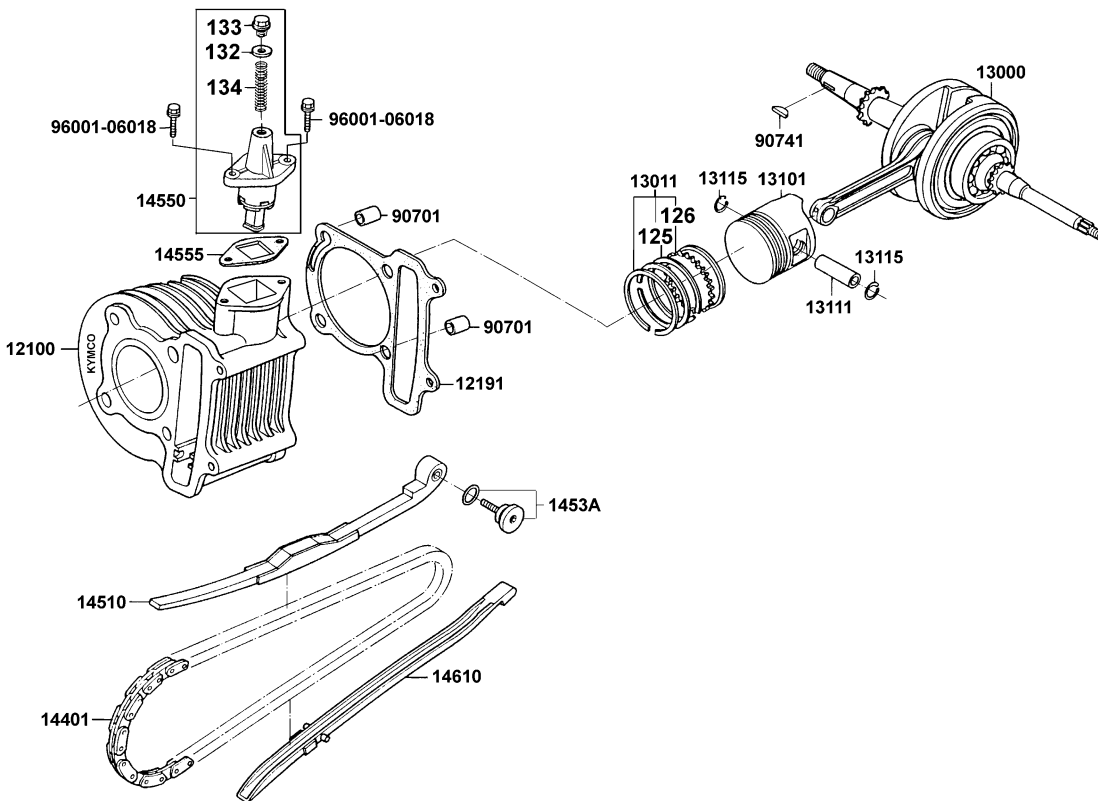
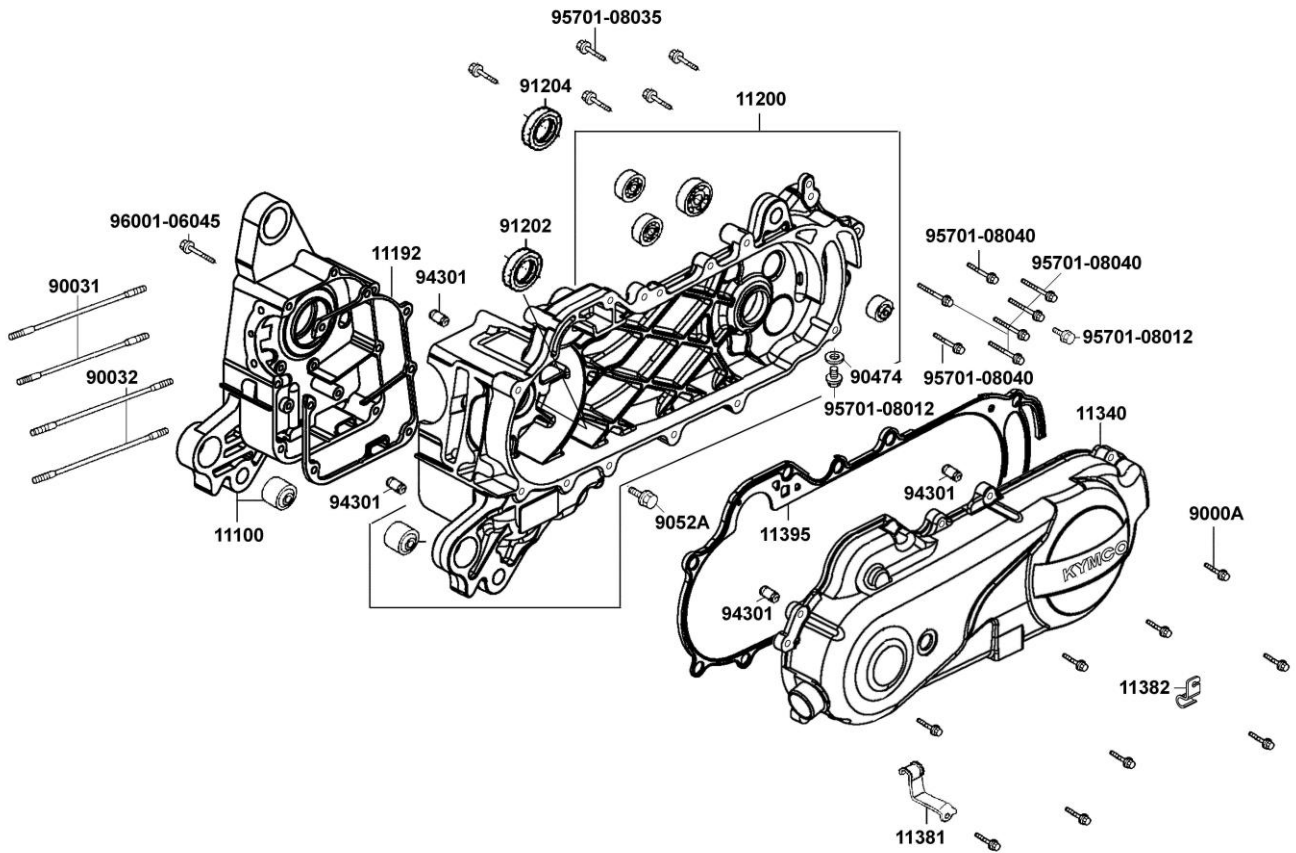

11

# 11. CRANKCASE/CRANKSHAFT

SERVICE INFORMATION.....	11-1	CRANKSHAFT.....	11-3
TROUBLESHOOTING .....	11-1	CRANKCASE ASSEMBLY.....	11-4
CRANKCASE SEPARATION .....	11-2		

## SERVICE INFORMATION

### GENERAL INSTRUCTIONS

- This section covers crankcase separation to service the crankshaft. The engine must be removed for this operation.
- The following parts must be removed before separating the crankcase.
  - Cylinder head (⇒Section 7)
  - Cylinder/piston (⇒Section 8)
  - Drive and driven pulleys (⇒Section 9)
  - A.C. generator (⇒Section 14)
  - Carburetor/air cleaner (⇒Section 5)
  - Rear wheel/rear shock absorber (⇒Section 13)
  - Starter motor (⇒Section 16)
  - Oil pump (⇒Section 4)

### SPECIFICATIONS

	Item	Standard (mm)	Service Limit (mm)
Crankshaft	Connecting rod big end side clearance	0.10~0.35	0.55
	Connecting rod big end radial clearance	0-0.008	0.05
	Runout	—	0.10

### TORQUE VALUES

Crankcase bolt	0.8~1.2kgf-m
Cam chain tensioner slipper bolt	0.8~1.2kgf-m

## TROUBLESHOOTING

### Excessive engine noise

- Excessive bearing play
- Excessive crankpin bearing play

# 11. CRANKCASE/CRANKSHAFT

## CRANKCASE SEPARATION

Remove the cam chain tensioner slipper bolt and cam chain tensioner slipper.

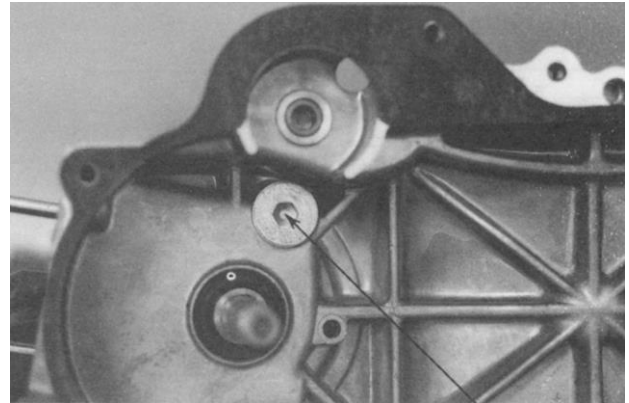

Cam Chain Tensioner Slipper Bolt

Remove the crankcase attaching bolt.  
Separate the left and right crankcase halves.

- \*
- Do not damage the crankcase gasket surface.
  - Never use a driver to pry the crankcase mating surfaces apart.

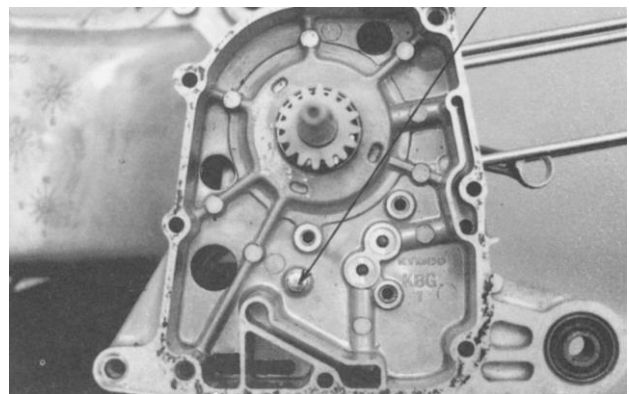

Crankcase Bolt

Remove the gasket and dowel pins.

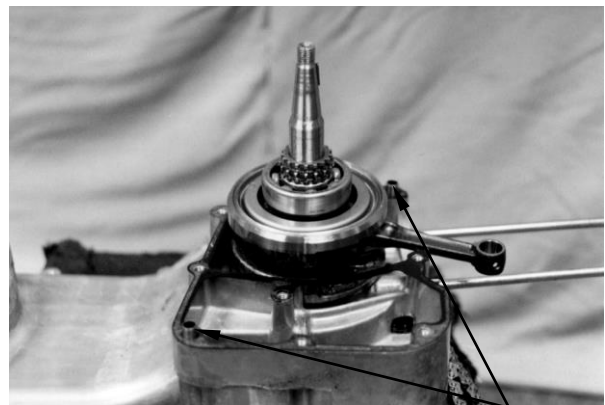

Dowel Pins

Remove the crankshaft from the left crankcase.  
Remove the cam chain.

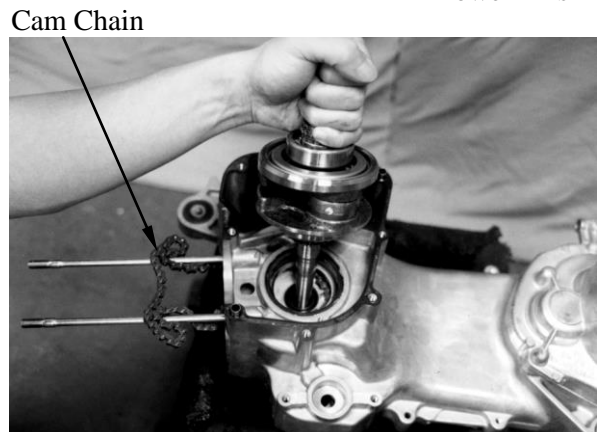

Cam Chain

# 11. CRANKCASE/CRANKSHAFT

Clean off all gasket material from the crankcase mating surfaces.

\* Avoid damaging the crankcase mating surfaces.

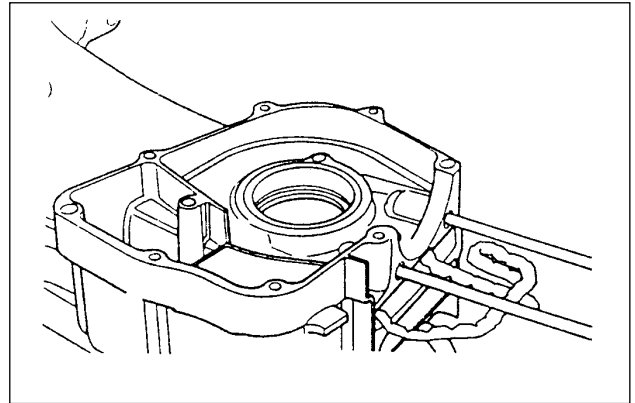

Remove the oil seal from the left crankcase.

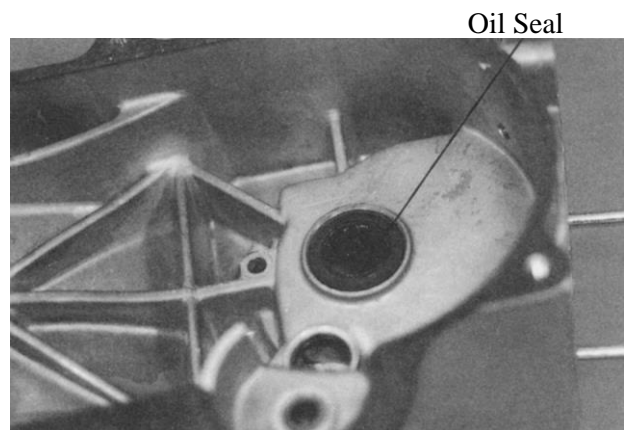

Remove the oil seal from the right crankcase.

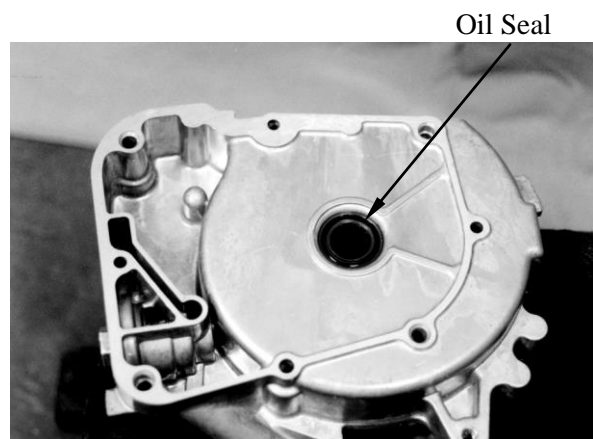

## CRANKSHAFT

Measure the connecting rod big end side clearance.

**Service Limit:** 0.55mm replace if over

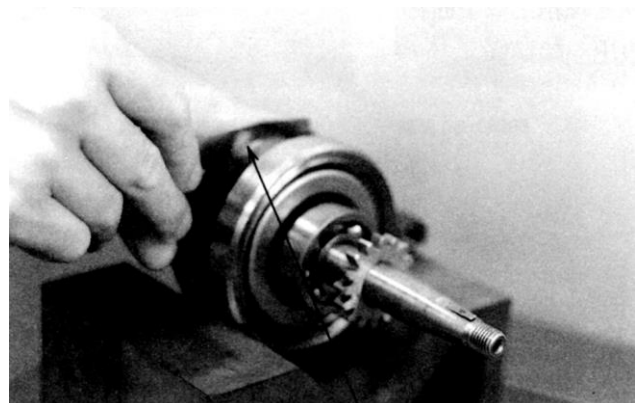

Connecting Rod Big End



# 11. CRANKCASE/CRANKSHAFT

Measure the connecting rod big end radial clearance at two points at right angles to the shaft.

**Service Limit:** 0.05mm replace if over

Measuring Location

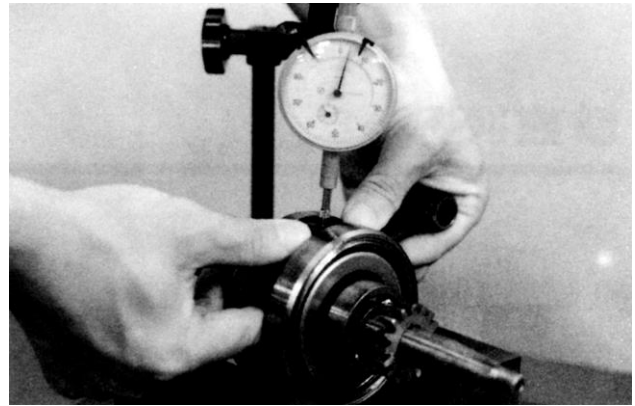

Measure the crankshaft runout.

**Service Limit:** 0.10mm replace if over

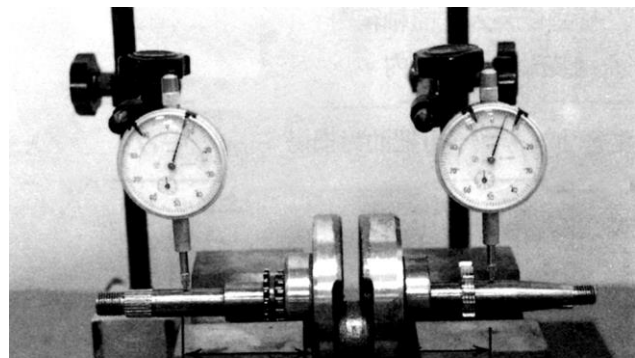

Turn the crankshaft bearings and check for excessive play.  
If they do not turn smoothly, quietly or if they fit loosely in the crankshaft, replace the crankshaft as a set.

Crankshaft Bearings

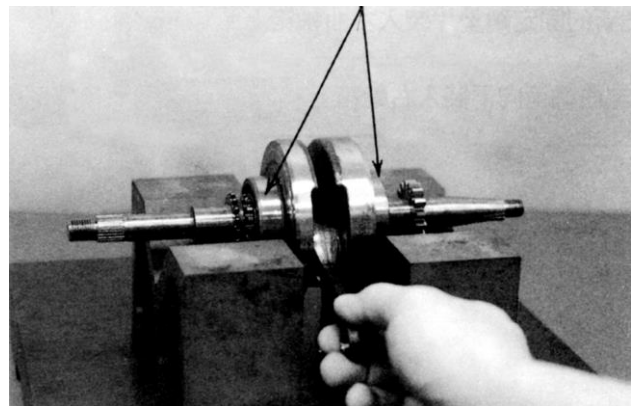

## CRANKCASE ASSEMBLY

Install new oil seals into the right and left crankcase .

Driver Handle A

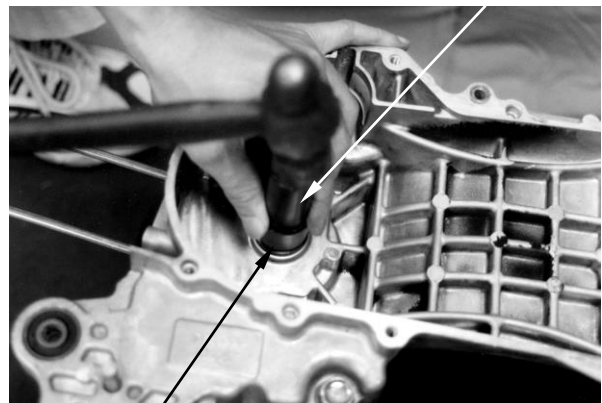

Outer Driver

# 11. CRANKCASE/CRANKSHAFT

Install the cam chain into the left crankcase.  
Install the crankshaft into the left crankcase.

\* When installing the cam chain, be careful not to damage the oil seal.



Gasket

Install the dowel pins and a new gasket onto the left crankcase.

\* Place the right crankcase over the crankshaft and onto the left crankcase.



Dowel Pins  
Crankcase Bolt

Tighten the crankcase attaching bolt.

**Torque:** 0.8~1.2kgf-m

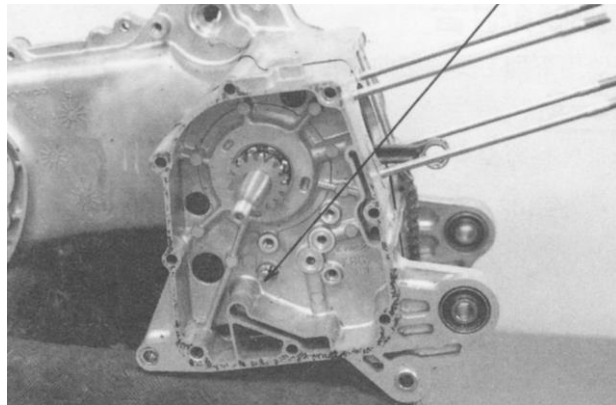

Install the cam chain tensioner slipper.  
Install a new O-ring onto the cam chain tensioner slipper bolt.  
Apply engine oil to the O-ring and tighten the bolt.

**Torque:** 0.8~1.2kgf-m

\* Be sure to install the O-ring into the groove.

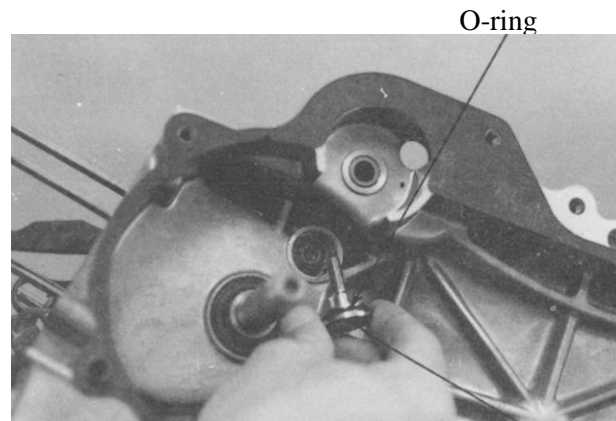

Cam Chain Tensioner Slipper Bolt

# 12. FRONT WHEEL/FRONT BRAKE/ FRONT SUSPENSION



Agility Carry / Delivery 50i

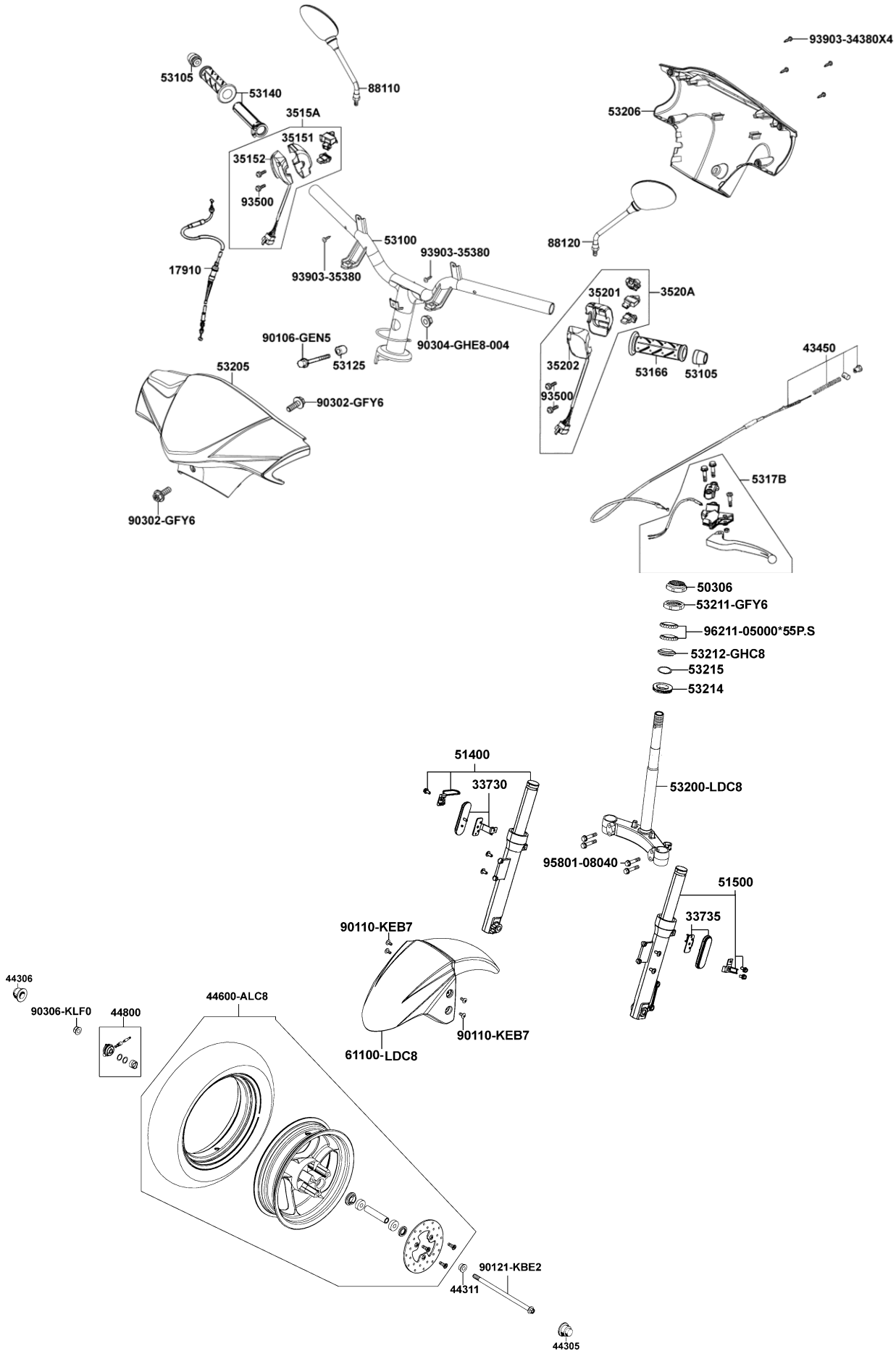

12

# 12. FRONT WHEEL/FRONT BRAKE/ FRONT SUSPENSION

SERVICE INFORMATION .....	12-1	FRONT BRAKE.....	12- 7
TROUBLESHOOTING .....	12-2	FRONT SHOCK ABSORBER.....	12-18
STEERING HANDLEBAR.....	12-3	FRONT FORK.....	12-21
FRONT WHEEL.....	12-4		

## SERVICE INFORMATION

### GENERAL INSTRUCTIONS

- Remove the motorcycle frame covers before removing the front wheel. Jack the motorcycle front wheel off the ground and be careful to prevent the motorcycle from falling down.
- During servicing, keep oil or grease off the brake drum and brake linings.

### SPECIFICATIONS

Item		Standard (mm)	Service Limit (mm)
Axle shaft runout		—	0.2
Front wheel rim runout	Radial	—	2.0
	Axial	—	2.0
Front brake drum I.D		110(SG20AB)	111(SG20AB)
Front brake lining thickness		4.0(SG20AB)	2.0(SG20AB)
Front shock absorber spring free length		210.9	206.4

### TORQUE VALUES

Handlebar bolt	4.5~5.5kgf-m
Steering stem lock nut	6.0~8.0kgf-m
Steering top cone race	0.5~1.3kgf-m
Front shock absorber bolt	3.0kgf-m
Front axle nut	5.0~7.0kgf-m
Brake arm bolt	0.8~1.2kgf-m

### SPECIAL TOOLS

Long socket wrench,32mm 8angle

## TROUBLESHOOTING

### Hard steering (heavy)

- Excessively tightened steering stem top cone race
- Broken steering balls
- Insufficient tire pressure

### Steers to one side or does not track straight

- Uneven front shock absorbers
- Bent front fork
- Bent front axle or uneven tire

### Poor brake performance

- Incorrectly adjusted brake
- Worn brake linings
- Contaminated brake lining surface
- Worn brake shoes at cam contacting area
- Worn brake drum
- Poorly connected brake arm

### Front wheel wobbling

- Bent rim
- Excessive wheel bearing play
- Bent spoke plate
- Faulty tire
- Improperly tightened axle nut

### Soft front shock absorber

- Weak shock springs
- Insufficient damper oil

### Front shock absorber noise

- Slider bending
- Loose fork fasteners
- Lack of lubrication

## 12. FRONT WHEEL/FRONT BRAKE/ FRONT SUSPENSION

### STEERING HANDLEBAR

#### REMOVAL

Remove the handlebar front and rear covers.  
(⇒2-2)  
Remove the two bolts attaching each of the front and rear brake levers.  
Remove the front and rear brake levers.



Bolts  
Screws  
Bolts  
Throttle Pipe

Remove the two throttle holder screws and throttle holder.  
Disconnect the throttle cable from the throttle pipe and then remove the throttle pipe from the handlebar.

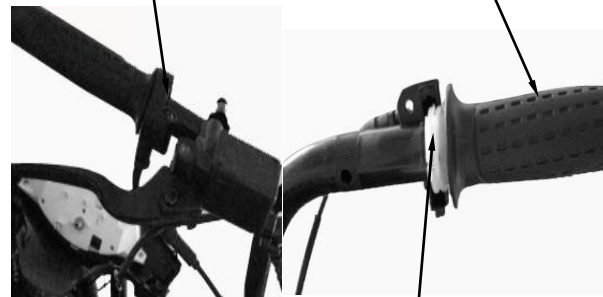

Throttle Cable

Remove the handlebar lock nut and bolt to remove the handlebar.



Nut  
Bolt  
Bolt Orifice

#### INSTALLATION

Install the handlebar onto the steering stem by aligning the tab on the handlebar with the bolt orifice on the steering stem.  
Install and tighten the handlebar bolt and lock nut.  
**Torque:** 4.5 ~ 5.5kgf-m

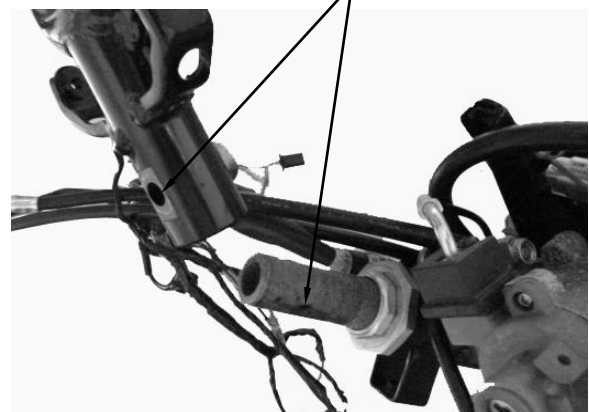

## 12. FRONT WHEEL/FRONT BRAKE/ FRONT SUSPENSION



Agility Carry / Delivery 50i

Apply grease to the tip of the throttle pipe.  
Install the throttle pipe and connect the throttle cable.

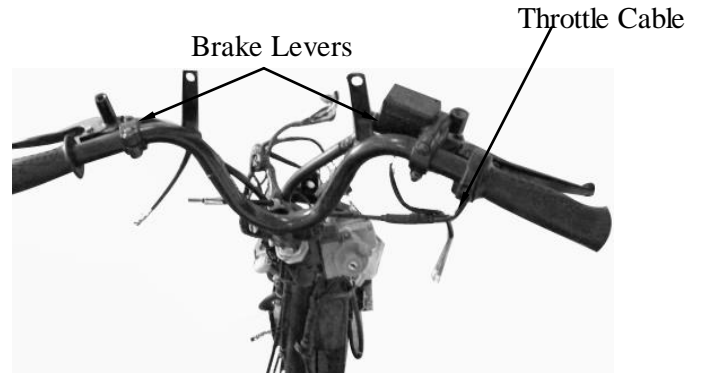

Install the front and rear brake levers in the reverse order of removal.

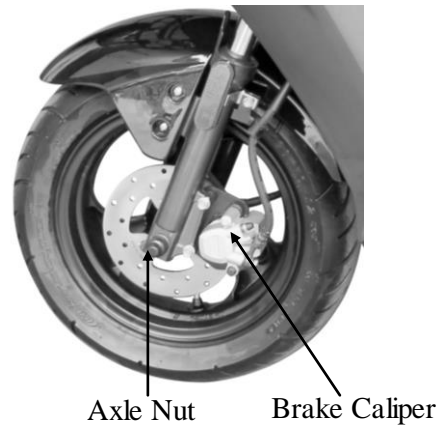

### FRONT WHEEL REMOVAL

Remove the speedometer cable set screw and disconnect the speedometer cable.  
Remove the front brake caliper.  
Remove the front axle nut and pull out the axle.  
Remove the front wheel.



### INSPECTION

#### AXLE RUNOUT

Set the axle in V blocks and measure the runout using a dial gauge.  
The actual runout is  $\frac{1}{2}$  of the total indicator reading.

**Service Limit:** 0.2mm replace if over

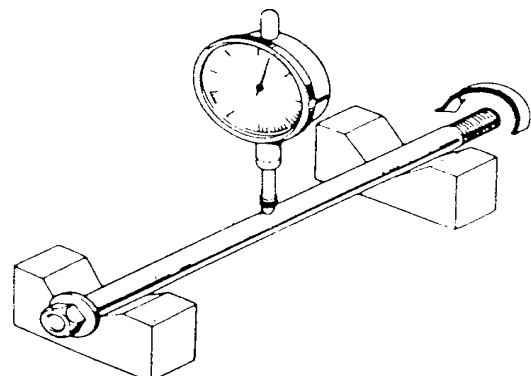

## 12. FRONT WHEEL/FRONT BRAKE/ FRONT SUSPENSION

### WHEEL RIM

Check the wheel rim runout.

#### Service Limits:

**Radial:** 2.0mm replace if over

**Axial:** 2.0mm replace if over

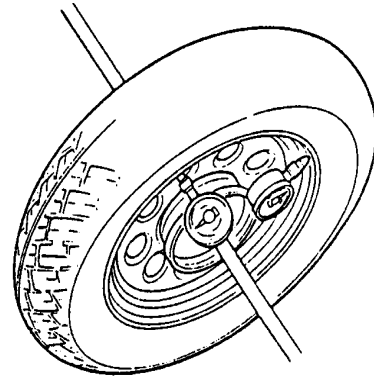

Turn the wheel bearings and replace the bearings if they are noisy or have excessive play.

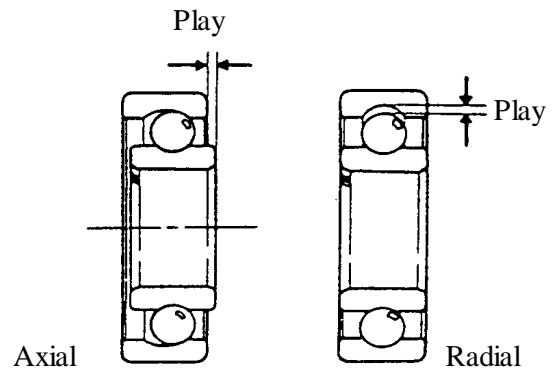

### DISASSEMBLY

Remove the dust seal.

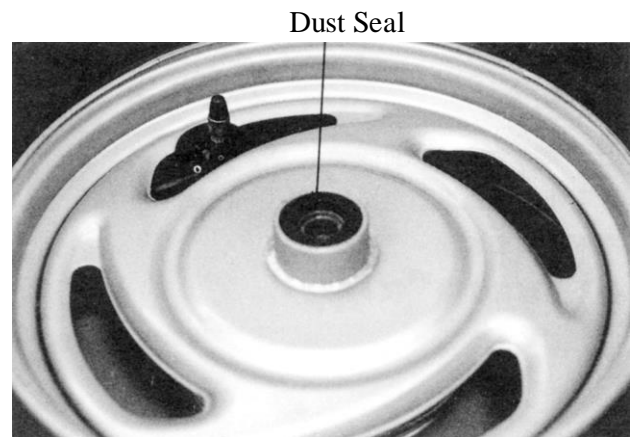



# 12. FRONT WHEEL/FRONT BRAKE/ FRONT SUSPENSION

Remove the front wheel bearings and distance collar.

**Special**

Bearing Puller

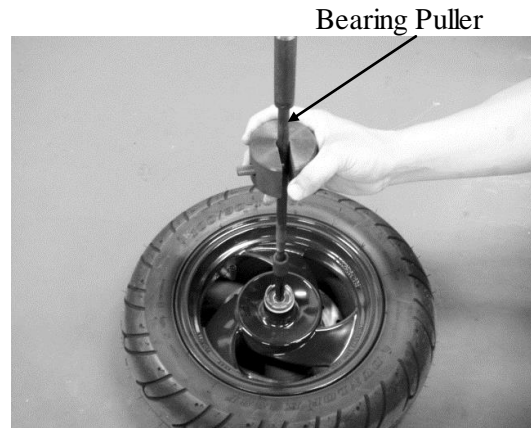

## ASSEMBLY

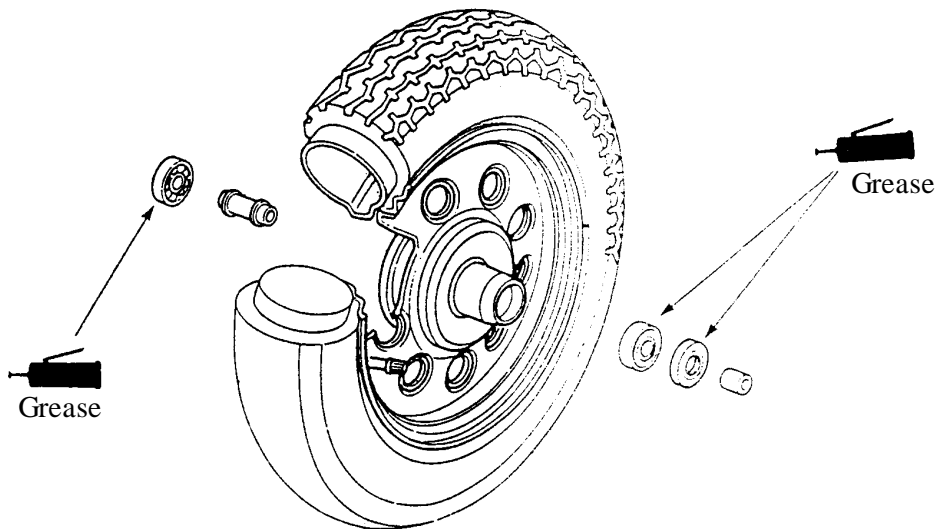

Pack all bearing cavities with grease.  
Drive in the left bearing.  
Install the distance collar.  
Drive in the right bearing.

\* Drive in the bearing squarely with the sealed end facing out.

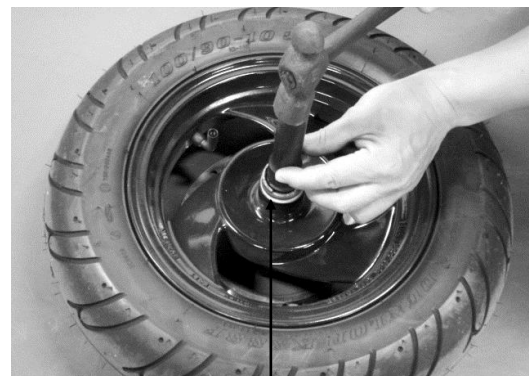

Outer Driver Pilot

## 12. FRONT WHEEL/FRONT BRAKE/ FRONT SUSPENSION

Apply grease to a new dust seal lip and install the dust seal.  
Install the side collar.

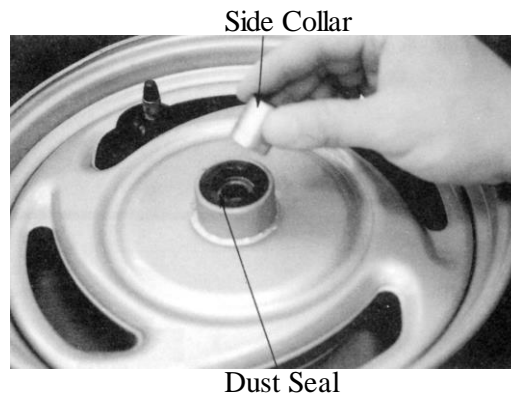

### INSTALLATION

Apply grease to the brake panel dust seal lip.  
Apply grease to the speedometer gear engaging and sliding parts.  
Install the brake panel by aligning the speedometer retaining pawls with the hub cutouts.

\* If not aligned, the retaining pawl will be deformed when the axle nut is tightened.  
After installing the axle, turn the wheel to make sure that the speedometer drive shaft rotates freely.

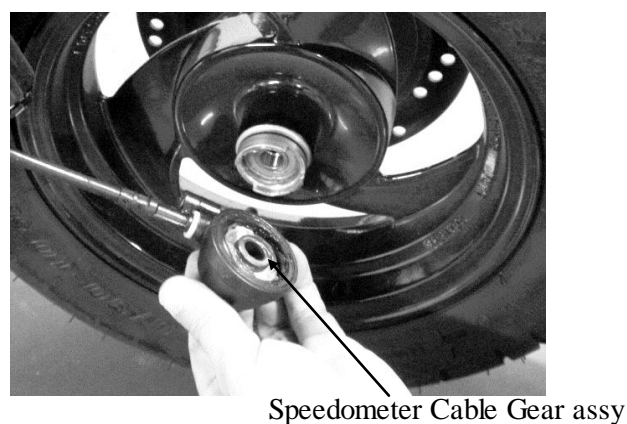

Apply a thin coat of grease to the axle shaft.  
Install the front wheel by aligning the brake panel groove with the front fork tab.  
Insert the axle shaft.  
Install and tighten the axle nut.

**Torque:** 5.0~7.0kg-m

Install the front brake cable and rotate the front tire to check the speedometer if be performed.

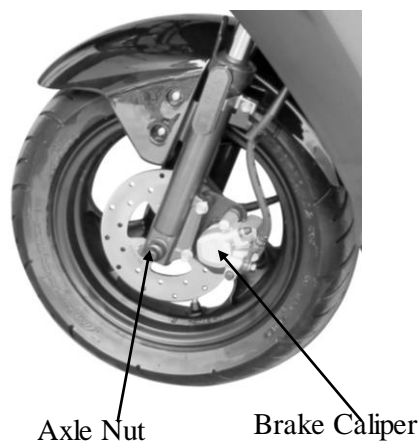

Connect the speedometer cable.



# 12. FRONT WHEEL/FRONT BRAKE/ FRONT SUSPENSION

## HYDRAULIC BRAKE (FRONT BRAKE)

### Brake Fluid Replacement/Air Bleeding

Check the brake fluid level on level ground.

**\***

- When operating the brake lever, the brake reservoir cap must be tightened securely to avoid spill of brake fluid.
- When servicing the brake system, use shop towels to cover plastic parts and coated surfaces to avoid damage caused by spill of brake fluid.

Upper Limit

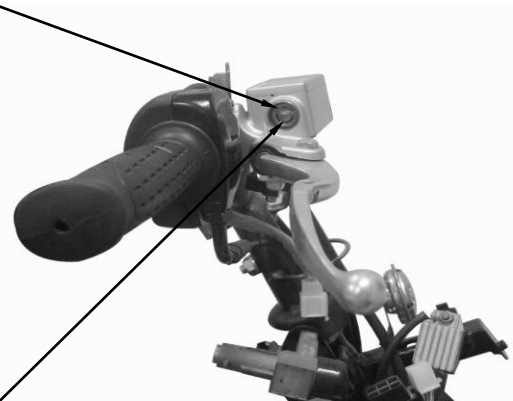

Lower Limit

### Brake Fluid Bleeding

In order to avoid spill of brake fluid, connect a transparent hose to the bleed valve.

#### Warning

Brake fluid spilled on brake pads or brake disk will reduce the braking effect. Clean the brake pads and brake disk with a high quality brake degreaser.

Fully apply the brake lever and then loosen the brake caliper bleed valve to drain the brake fluid until there is no air bubbles in the brake fluid. Then, tighten the bleed valve. Repeat these steps until the brake system is free of air.

To avoid leakage of brake fluid, connect a hose to the bleed valve.

### Brake Fluid Refilling

Add DOT-4 brake fluid to the brake reservoir.

**\***

- When bleeding, be careful not to allow air in the brake reservoir flowing into the brake system.
- When using a brake bleeder, follow the manufacturer's instructions.
- Never use dirty or unspecified brake fluid or mix different brake fluids because it will damage the brake system.

Make sure to bleed air from the brake system.

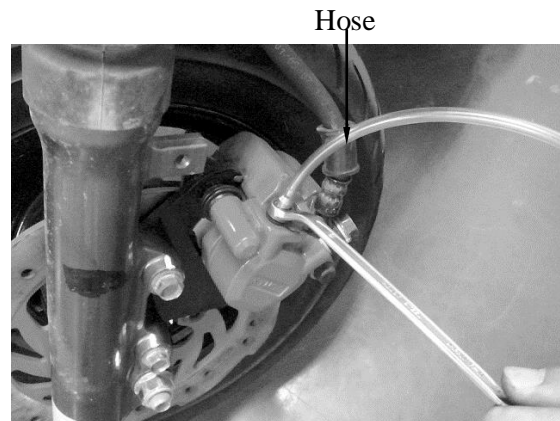
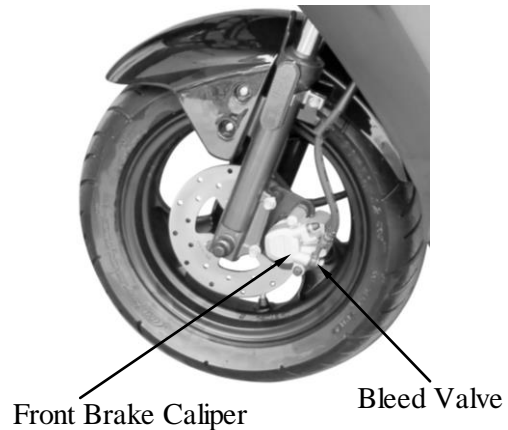

## 12. FRONT WHEEL/FRONT BRAKE/ FRONT SUSPENSION

### Brake Pad/Disk Replacement

- \* The brake pads must be replaced as a set to ensure the balance of the brake disk.

Remove the two bolts attaching the brake caliper.  
Remove the brake caliper.

Remove the brake pad pins to remove the brake pads.

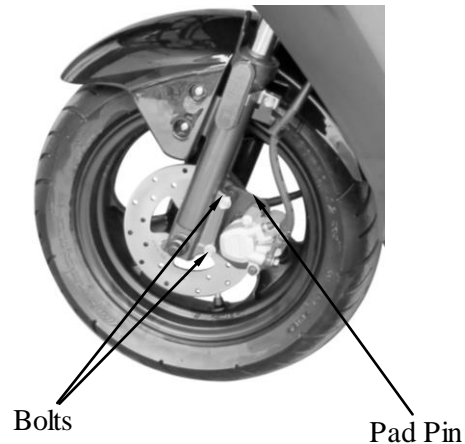

Install the brake pads in the reverse order of removal.  
Tighten the brake pad pin bolts.  
**Torque:** 1.5~2.0kgf-m

- \*
  - Keep grease or oil off the brake pads to avoid brake failure.
  - Do not reuse the brake pad pin bolts that have been removed.

Brake Pads

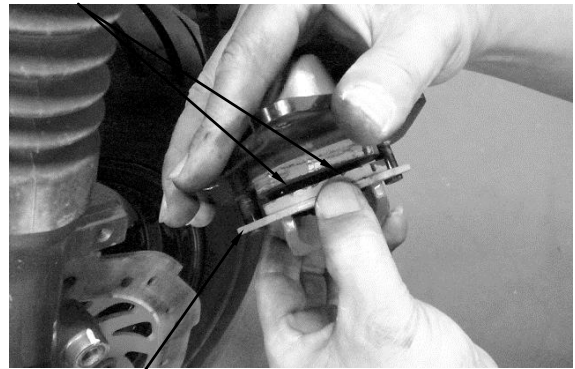

Front Brake Caliper

### Brake Disk

Measure the brake disk thickness.

**Service Limit:** 3.0mm

Measure the brake disk runout.

**Service Limit:** 0.3mm



## 12. FRONT WHEEL/FRONT BRAKE/ FRONT SUSPENSION

### BRAKE MASTER CYLINDER

#### Removal

First drain the brake fluid from the hydraulic brake system.

\*

- When servicing the brake system, use shop towels to cover rubber and plastic parts and coated surfaces to avoid being contaminated by brake fluid.
- When removing the brake fluid pipe bolt, be sure to plug the pipe to avoid brake fluid leakage.

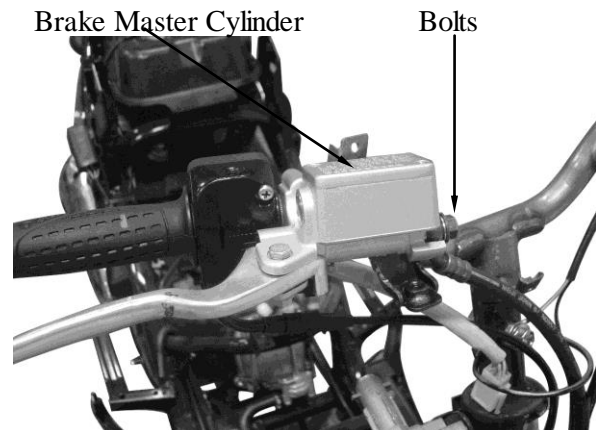

#### Disassembly

Remove the piston rubber cover and snap ring from the brake master cylinder.

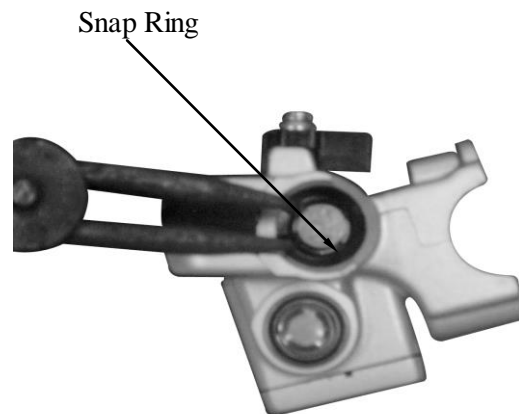

Remove the washer, main piston and spring from the brake master cylinder.  
Clean the inside of the master cylinder and brake reservoir with brake fluid.

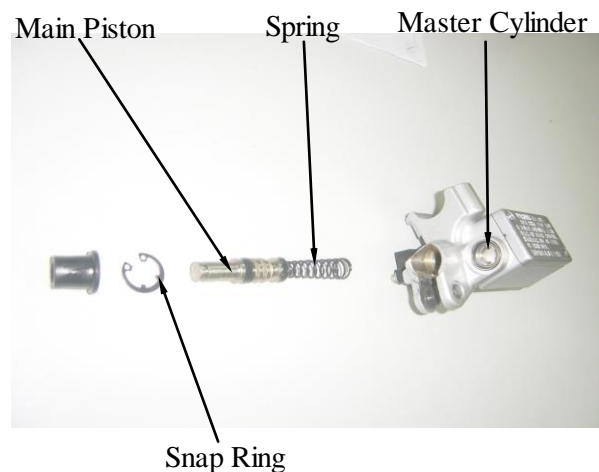

## 12. FRONT WHEEL/FRONT BRAKE/ FRONT SUSPENSION

### Inspection

Measure the brake master cylinder I.D.

**Service Limit:** 12.75mm

Inspect the master cylinder for scratch or crack.

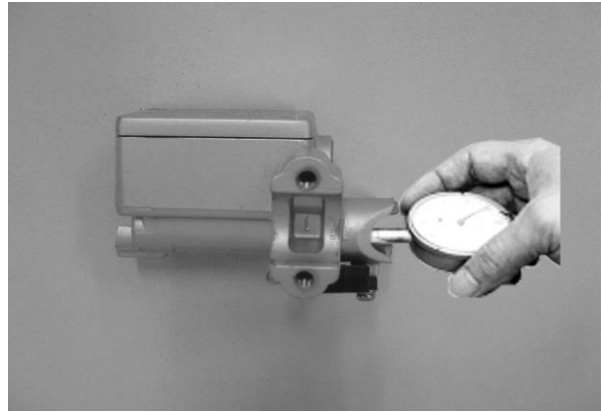

Measure the brake master cylinder piston O.D.

**Service Limit:** 12.6mm

Before assembly, inspect the 1st and 2nd rubber cups for wear.



### Assembly

Before assembly, apply brake fluid to all removed parts.

Install the spring together with the 1st rubber cup.

\*

- During assembly, the main piston and spring must be installed as a unit without exchange.
- When assembling the piston, soak the cups in brake fluid for a while.
- Install the cups with the cup lips facing the correct direction.



Install the main piston, spring and snap ring.

Install the rubber cover.

Install the brake lever.

## 12. FRONT WHEEL/FRONT BRAKE/ FRONT SUSPENSION

**KYMCO**  
Agility Carry / Delivery 50i

### Disassembly

Remove the brake caliper seat from the brake caliper.

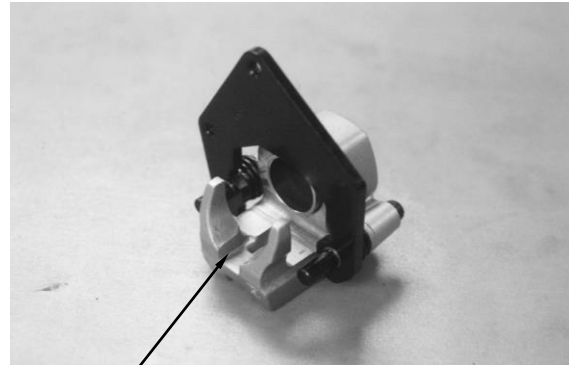

Brake Caliper Seat

Remove the piston from the brake caliper.  
If necessary, use compressed air to squeeze out the piston through the brake fluid inlet opening and place a shop towel under the caliper to avoid contamination caused by the removed piston.  
Check the piston cylinder for scratch or wear and replace if necessary.

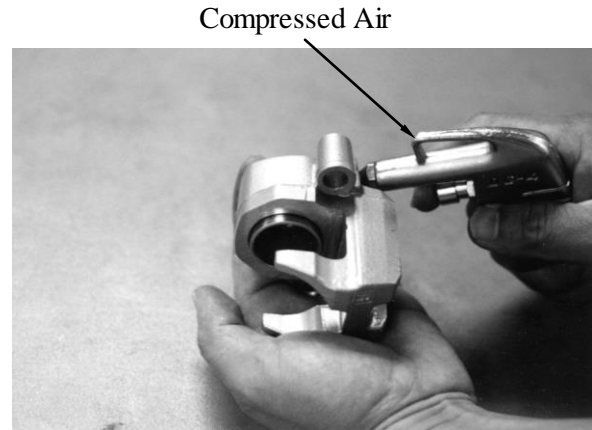

Compressed Air

Push the piston oil seal outward to remove it.  
Clean the oil seal groove with brake fluid.

\*

Be careful not to damage the piston surface.



Piston Oil Seal

## 12. FRONT WHEEL/FRONT BRAKE/ FRONT SUSPENSION

Place the brake master cylinder on the handlebar and install the holder with “up” mark facing up. Be sure to align the punch mark with the holder joint.

First tighten the upper bolt and then tighten the lower bolt.

**Torque:** 3.0~4.0kgf-m

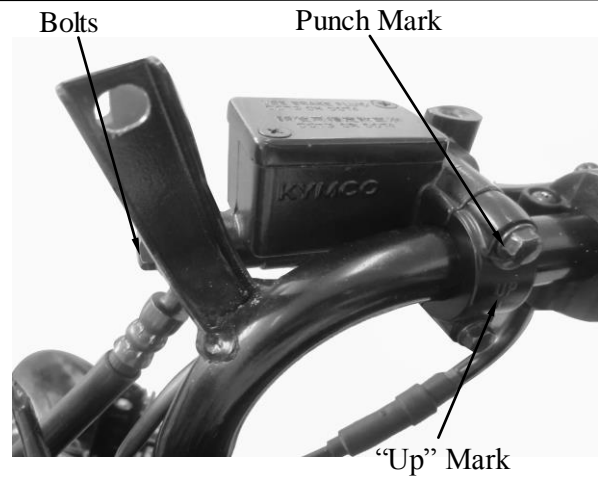

Install the brake fluid pipe with the attaching bolt and two sealing washers.

Install the handlebar covers. (⇒12-3)

Fill the brake reservoir with recommended brake fluid to the upper limit and bleed air according to the method stated in 12-10.

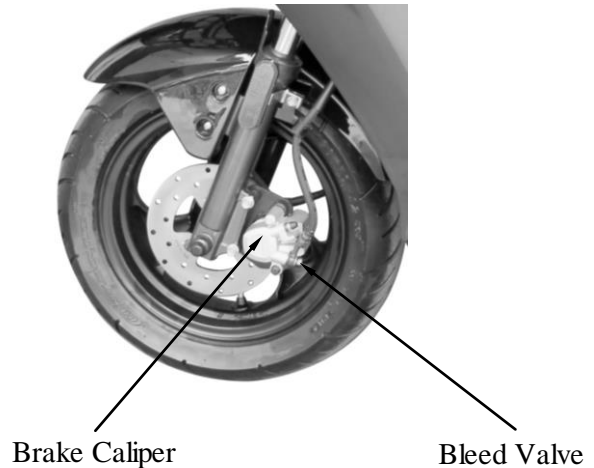

### **BRAKE CALIPER (FRONT)**

#### **Removal**

Remove the brake caliper.

Place a clean container under the brake caliper and disconnect the brake fluid pipe from the caliper.

**\***

Do not spill brake fluid on any coated surfaces.

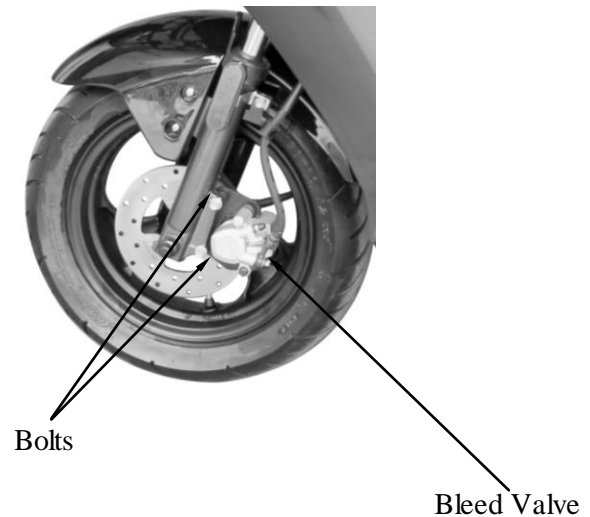



## 12. FRONT WHEEL/FRONT BRAKE/ FRONT SUSPENSION

Check the piston for scratch or wear.  
Measure the piston O.D. with a micrometer.  
**Service Limit:** 26.3mm



Check the caliper cylinder for scratch or wear  
and measure the cylinder bore.  
**Service Limit:** 26.45mm



### Assembly

Clean all removed parts.  
Apply silicon grease to the piston and oil seal.  
Lubricate the brake caliper cylinder inside wall  
with brake fluid.  
Install the brake caliper piston with grooved side  
facing out.

\* Install the piston with its outer end 3~5mm  
protruding beyond the brake caliper.

Wipe off excessive brake fluid with a clean shop  
towel. Apply silicon grease to the brake caliper  
seat pin and caliper inside.  
Install the brake caliper seat.

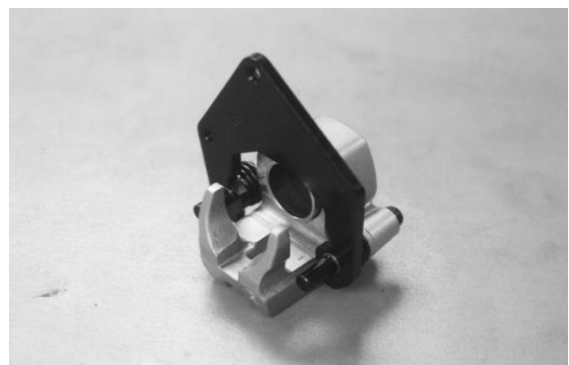

## 12. FRONT WHEEL/FRONT BRAKE/ FRONT SUSPENSION

### Installation

Install the brake caliper and tighten the two bolts.

**Torque:** 2.9~3.5kg-m

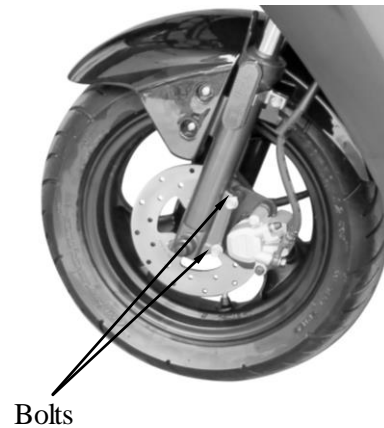

Connect the brake fluid pipe to the brake caliper and tighten the fluid pipe bolt.

**Torque:** 2.5~3.5kg-m

Fill the brake reservoir with recommended brake fluid and bleed air from the brake system. (⇒12-10)



## 12. FRONT WHEEL/FRONT BRAKE/ FRONT SUSPENSION

### FRONT SHOCK ABSORBER

#### REMOVAL

Remove the front wheel. (⇒12-4)  
Remove the front lower cover. (⇒2-2)  
Remove the front inner fender.  
Remove the front shock absorber upper mount bolts.  
Loosen the lower mount bolts to remove the front shock absorbers.

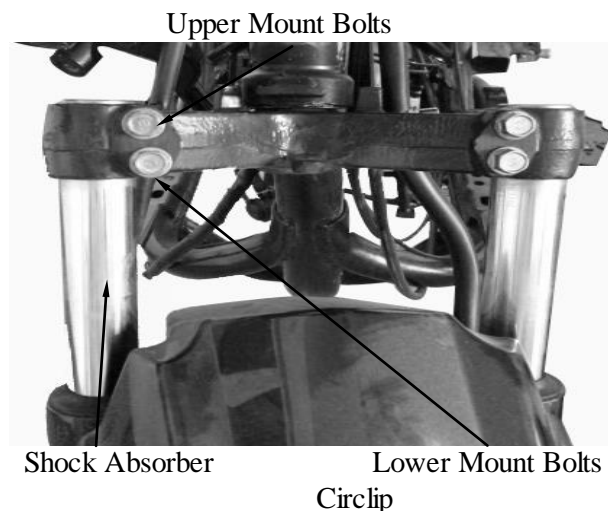

#### DISASSEMBLY

Remove the dust boot.  
Remove the circlip.

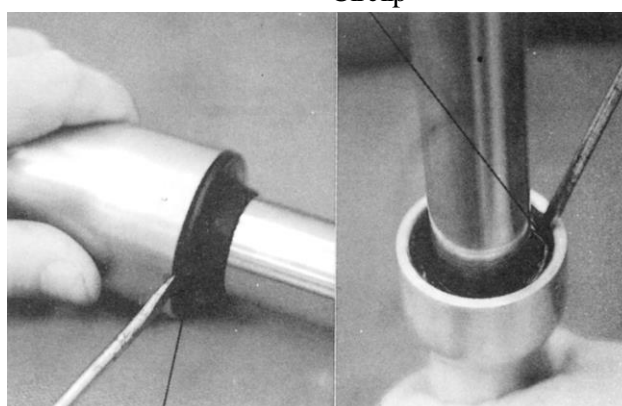

Set the front shock absorber in a vise.  
Remove the damper rod, hex bolt and copper washer.  
Pull out the front shock absorber tube.

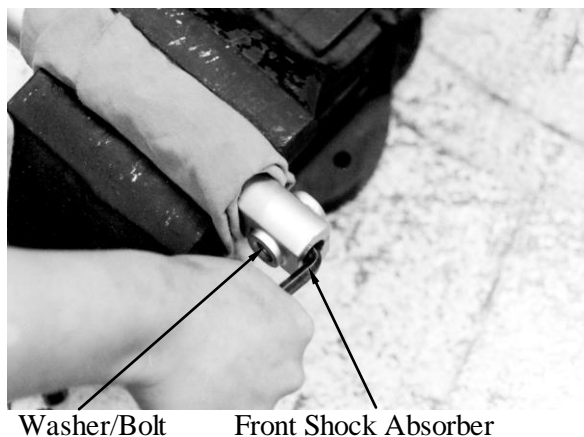

Set the front shock absorber tube in a vise.  
Remove the top nut, shock spring, damper, and damper spring from the front shock absorber tube.

- \* • When holding the shock absorber tube, place a shop towel to protect it and do not apply too much force.

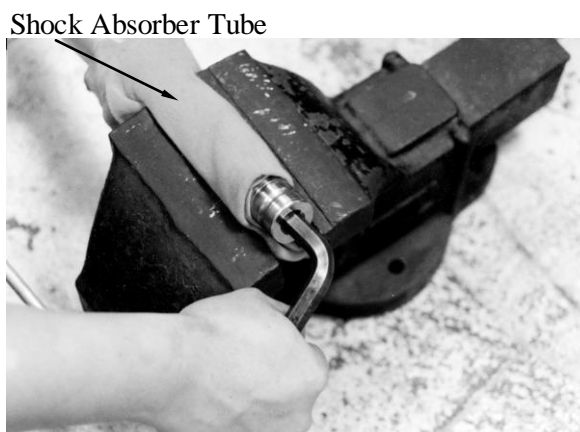

# 12. FRONT WHEEL/FRONT BRAKE/ FRONT SUSPENSION

Measure the front shock absorber spring free length.

**Service Limits:** Right : 206.4mm  
Left : 206.4mm

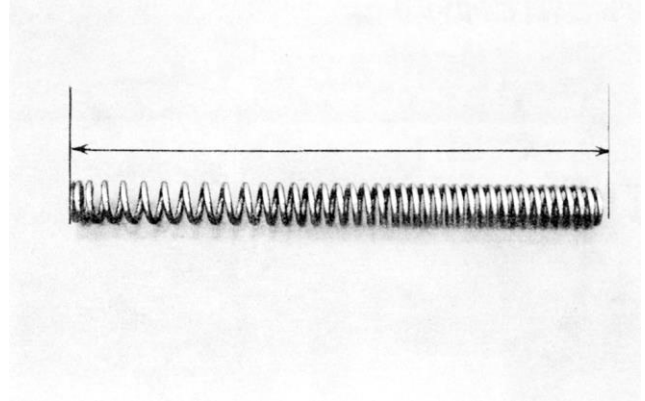

## ASSEMBLY

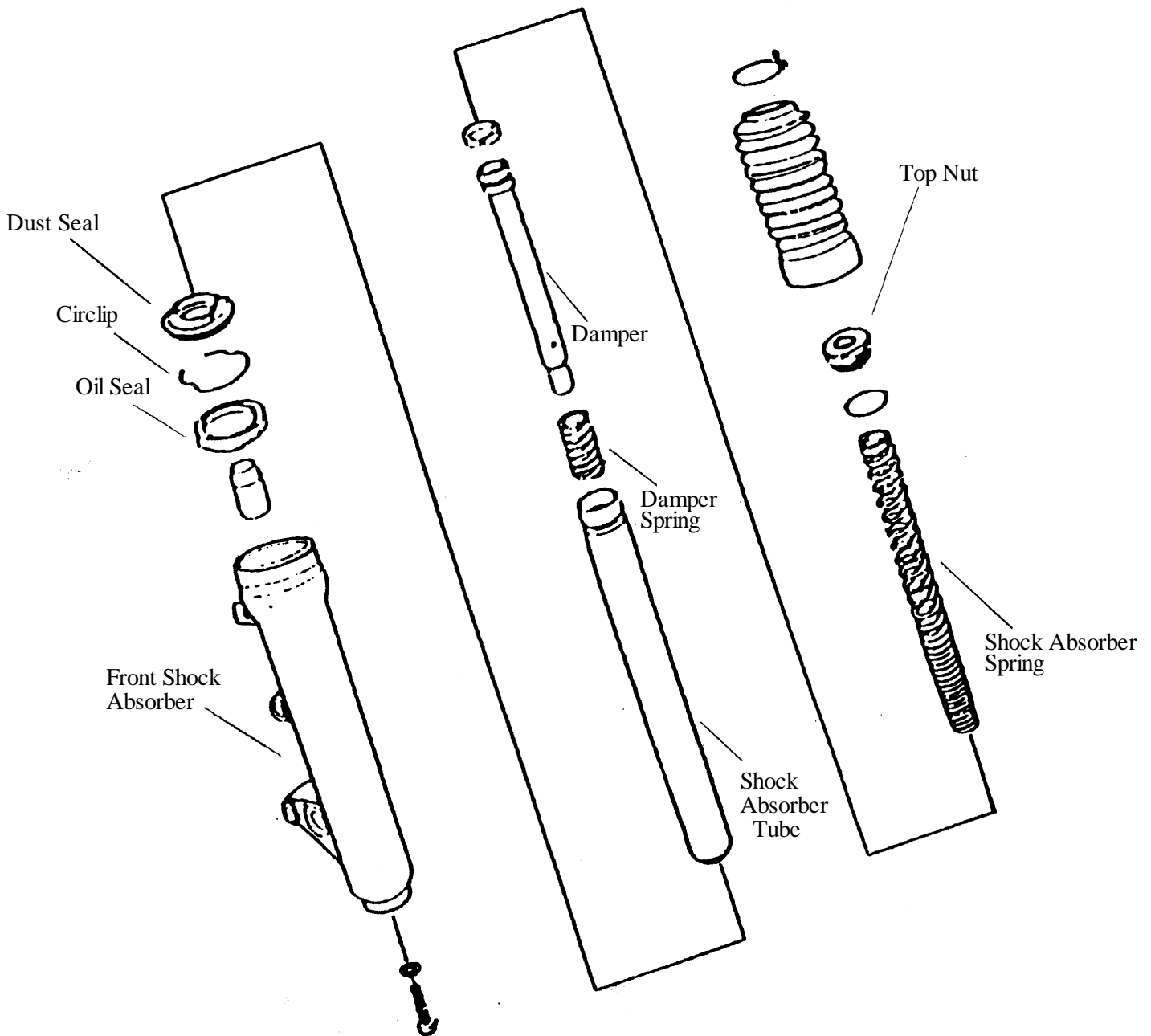

## 12. FRONT WHEEL/FRONT BRAKE/ FRONT SUSPENSION

Install the damper spring onto the damper rod and then install them into the front shock absorber tube.

Install the shock absorber spring onto the front shock absorber tube and tighten the top nut.

\* Install the front shock absorber spring with the closely wound coils facing down.



Shock Absorber Tube  
Circlip

Set the front shock absorber in a vise. Insert the shock absorber tube into the shock absorber and tighten the hex bolt. (Apply locking agent to the washer and install it together with the hex bolt.)

**Torque:** 3.0kgf-m

Add engine oil into the front shock absorber.

**Specified Oil:** SS#8

**Oil Capacity:** 38±1cc

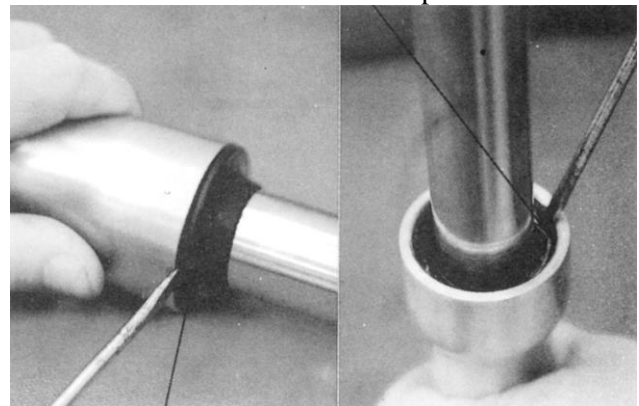

Dust Boot

Install the circlip.  
Install the dust boot.

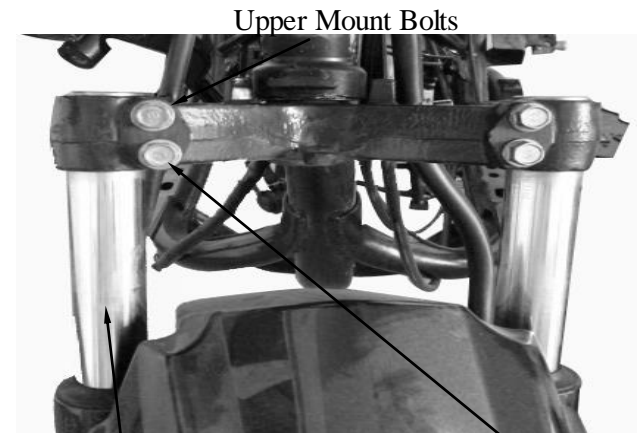

Upper Mount Bolts  
Front Shock Absorber      Lower Mount Bolts

### INSTALLATION

Install the front shock absorbers onto the steering stem.

Install and tighten the front shock absorber upper mount bolts.

Tighten the lower mount bolts.

\* Align the upper mount bolt hole with the groove on the front fork.

Install the front wheel. (⇒12-7)

# 12. FRONT WHEEL/FRONT BRAKE/ FRONT SUSPENSION

## FRONT FORK

### REMOVAL

Remove the steering handlebar. (⇒12-3)  
Remove the front wheel. (⇒12-4)  
Disconnect the speedometer cable.  
Remove the steering stem lock nut using long socket wrench.

**Special**

Long Socket Wrench, 32mm 8Angle

Remove the top cone race and remove the steering stem.

\*

- Be careful not to lose the steel balls (26 on top race and 29 on bottom race).

Inspect the ball races and cone races for wear or damage and replace if necessary.

### BOTTOM CONE RACE REPLACEMENT

Remove the bottom cone race using a chisel.

\*

- Be careful not to damage the steering stem and front fork.

Drive a new bottom cone race into place with a proper driver.

### BALL RACE REPLACEMENT

Drive out the top and bottom ball races.

Long Socket Wrench

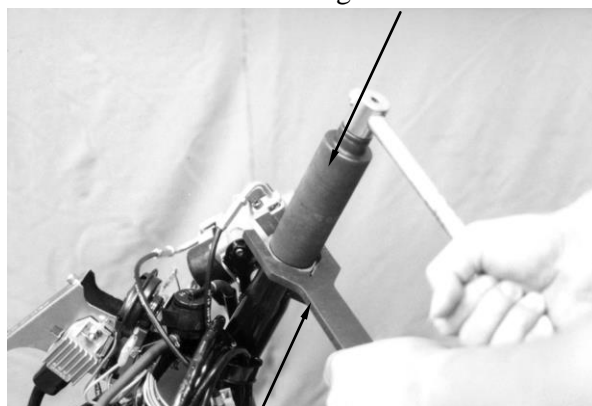

Lock Nut Wrench



Top Cone Race

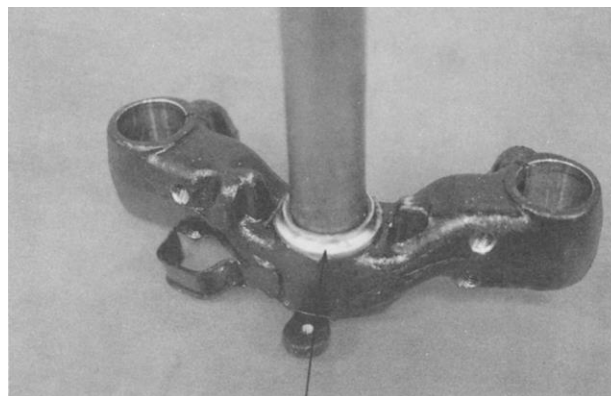

Bottom Cone Race

Ball Race Remover



## 12. FRONT WHEEL/FRONT BRAKE/ FRONT SUSPENSION

Drive new top and bottom ball races into the steering head using the outer driver.

- \* Be sure to completely drive in the ball races.

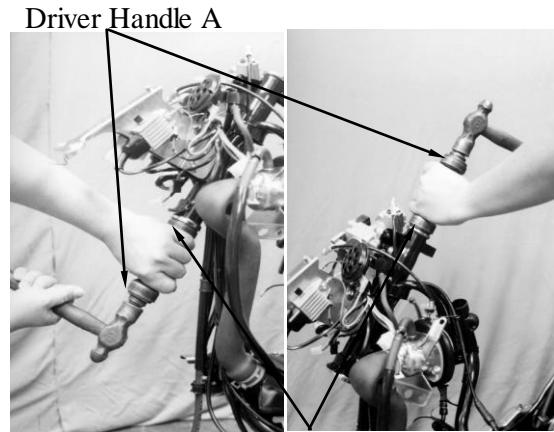

Outer Driver, 37x40mm

### INSTALLATION

Apply grease to the top and bottom ball races and install 26 steel balls on the top ball race and 29 steel balls on the bottom ball race. Apply grease to the ball races and install the front fork.



Steel Balls

Apply grease to the top cone race and install it. Tighten the top cone race and then turn the steering stem right and left several times to make steel balls contact each other closely.

- \* Check that the steering stem rotates freely without vertical play.



Long Socket Wrench

Install the steering stem lock nut and tighten it while holding the top cone race.

**Torque:** 6.0~8.0kgf-m

Install the front wheel. (⇒12-7)

Install the steering handlebar. (⇒12-3)

Install the speedometer cable. (⇒12-7)

**Special**

Long Socket Wrench, 32mm 8Angle

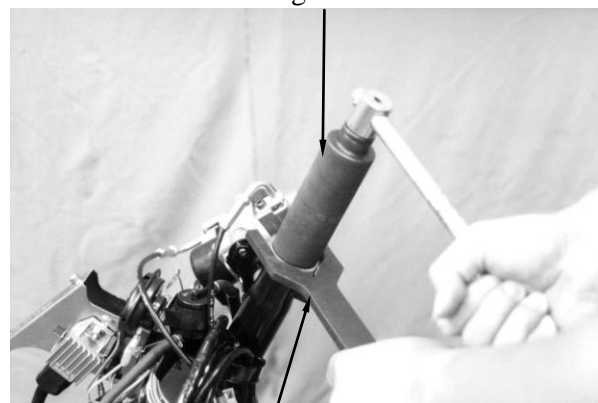

Lock Nut Wrench

# 13. REAR WHEEL/REAR BRAKE/ REAR SUSPENSION

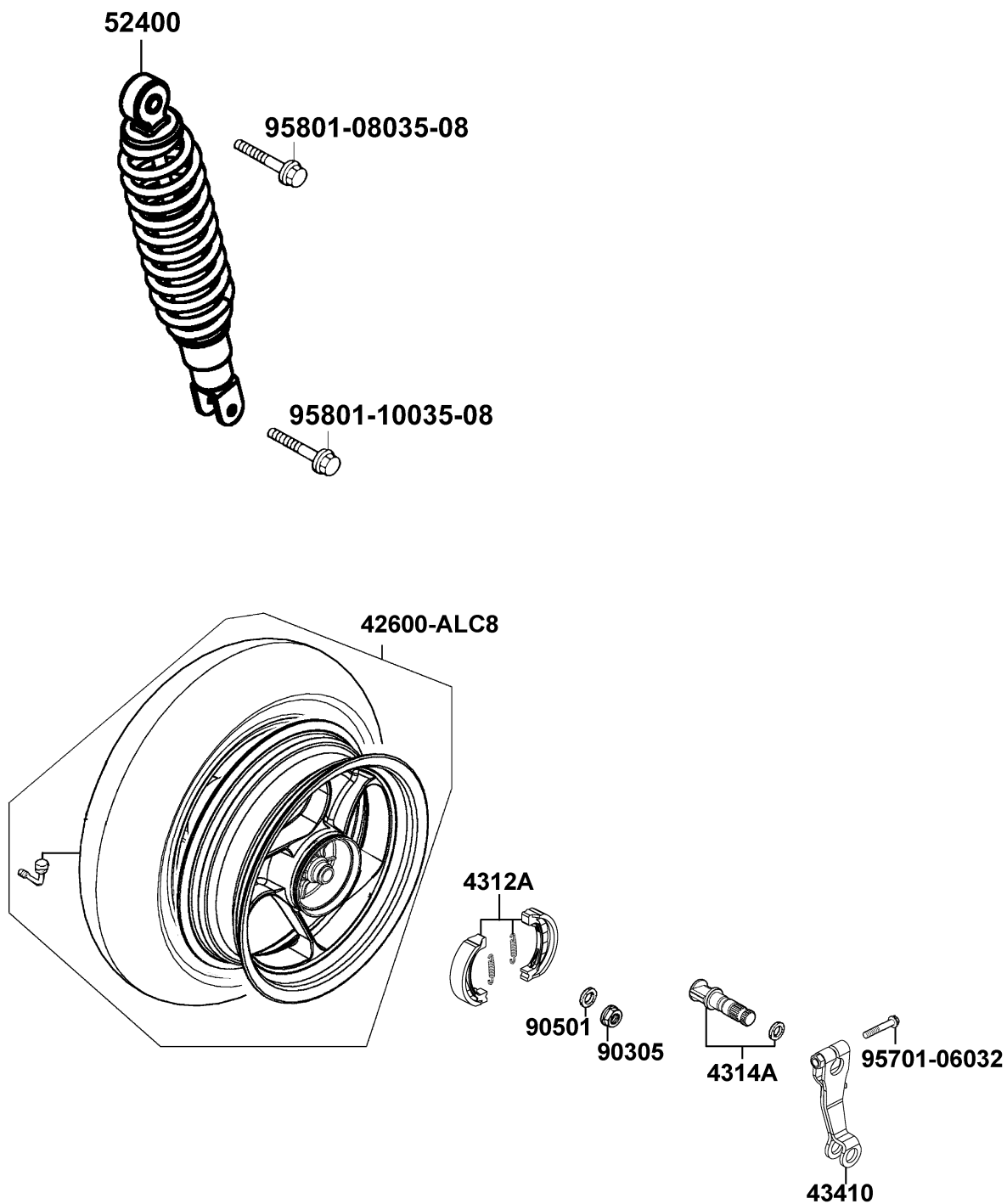



# 13. REAR WHEEL/REAR BRAKE/ REAR SUSPENSION

SERVICE INFORMATION .....	13-1	REAR BRAKE.....	13-3
TROUBLESHOOTING .....	13-1	REAR SHOCK ABSORBER.....	13-4
REAR WHEEL .....	13-2		

## SERVICE INFORMATION

### GENERAL INSTRUCTIONS

- During servicing, keep oil or grease off the brake drum and brake linings.

### SPECIFICATIONS

Item		Standard (mm)	Service Limit (mm)
Rear wheel	Rim runout	Radial	—
		Axial	—
	Rear brake drum I.D		110
Rear brake lining thickness		4.0	2.0
Rear shock absorber spring free length		227	220

### TORQUE VALUES

Rear axle nut	11~13kgf-m
Rear shock absorber upper mount bolt	3.5~4.5kgf-m
Rear shock absorber lower mount bolt	2.4~3.0kgf-m
Exhaust muffler joint lock nut	1.0~1.4kgf-m
Exhaust muffler lock bolt	3.0~3.6kgf-m

### Special Tool

Cushion Assemble & Disassemble Tool

## TROUBLESHOOTING

### Rear wheel wobbling

- Bent rim
- Faulty tire
- Axle not tightened properly

### Soft rear shock absorber

- Weak shock absorber spring
- Faulty damper

### Poor brake performance

- Brake not adjusted properly
- Worn brake linings
- Worn brake shoes at cam contacting area
- Worn brake cam
- Worn brake drum

# 13. REAR WHEEL/REAR BRAKE/ REAR SUSPENSION

## REAR WHEEL

### REMOVAL

Remove the exhaust muffler. (⇒2-5)  
Remove the rear axle nut.  
Remove the rear wheel.

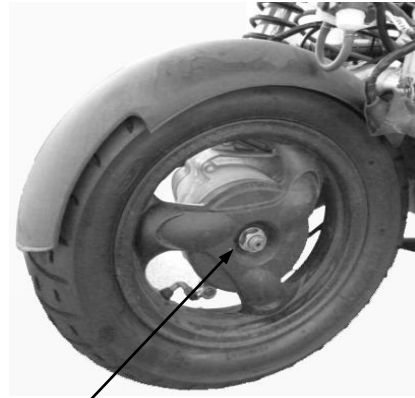

Rear Axle Nut

### INSPECTION

Measure the rear wheel rim runout.

#### Service Limits:

**Radial:** 2.0mm replace if over

**Axial:** 2.0mm replace if over

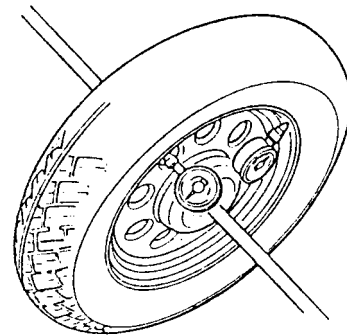

Inspect the rear brake drum.

Measure the rear brake drum I.D.

**Service Limits:** 130mm replace if over

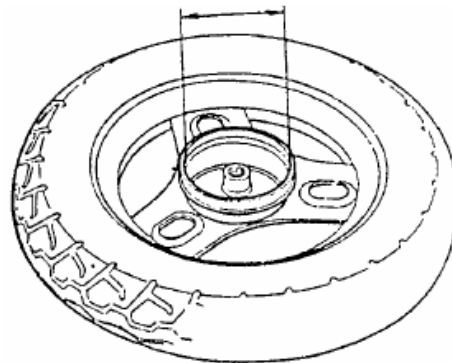

### INSTALLATION

Install the rear wheel in the reverse order of removal.

Tighten the rear axle nut.

**Torque:** 11.0-13.0kgf-m

Install the exhaust muffler.

**Torque:**

Exhaust muffler joint lock nut: 1.0~1.4kgf-m

Exhaust muffler lock bolt: 3.0~3.6kgf-m

\* First install and tighten the exhaust muffler joint lock nuts and then the exhaust muffler lock bolts.



# 13. REAR WHEEL/REAR BRAKE/ REAR SUSPENSION

## REAR BRAKE

### BRAKE LINING INSPECTION

Measure the brake lining thickness.

**Service Limit:** 2.0mm replace if below

\* Keep oil or grease off the brake linings.

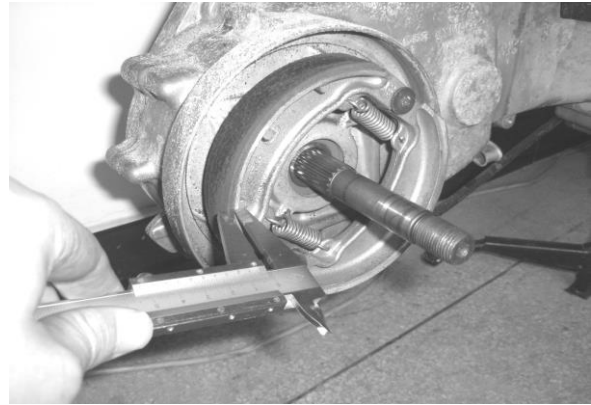

### REAR BRAKE DISASSEMBLY

Remove the rear brake adjusting nut and disconnect the rear brake cable.  
Remove the rear brake shoes.

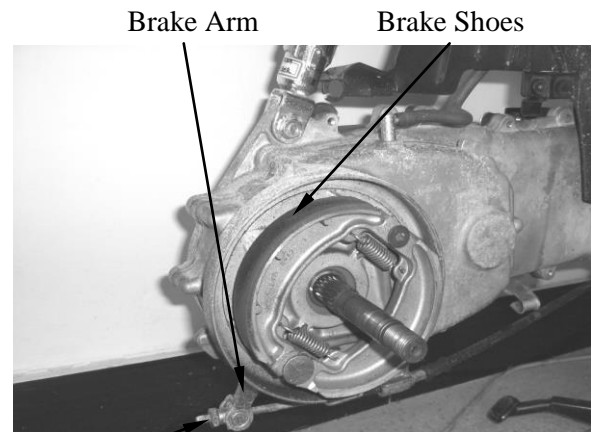

Remove the brake arm bolt to remove the brake arm.  
Remove the brake cam.

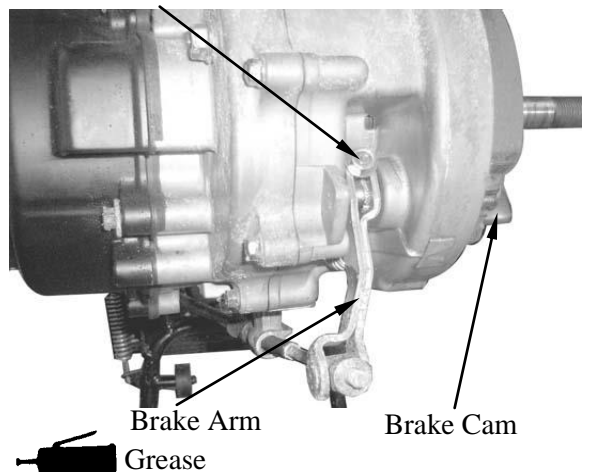

### REAR BRAKE ASSEMBLY

Apply grease to the anchor pin.  
Apply grease to the brake cam and install it.  
Install the brake shoes.

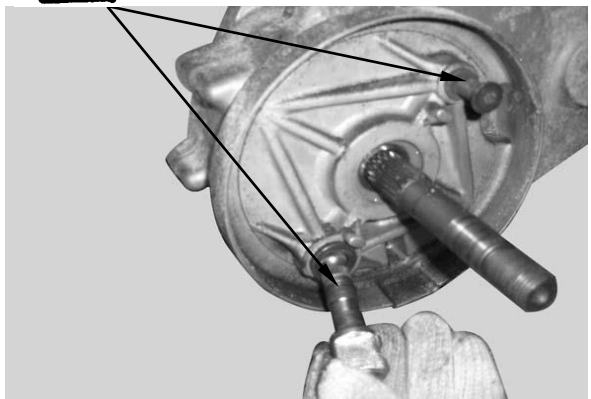

# 13. REAR WHEEL/REAR BRAKE/ REAR SUSPENSION

Apply a small amount of engine oil to the felt seal and install it to the brake cam.  
Install the brake arm.

\* Align the wide groove on the wear indicator plate with the wide tooth of the brake cam.

Install and tighten the brake arm bolt.

\* Align the scribed line on the brake arm with the punch mark on the brake cam.

Install the brake arm return spring.  
Install the brake arm pin.  
Connect the brake cable and install the adjusting nut.  
Install the rear wheel. (⇒13-2)  
Adjust the rear brake lever free play. (⇒3-8)

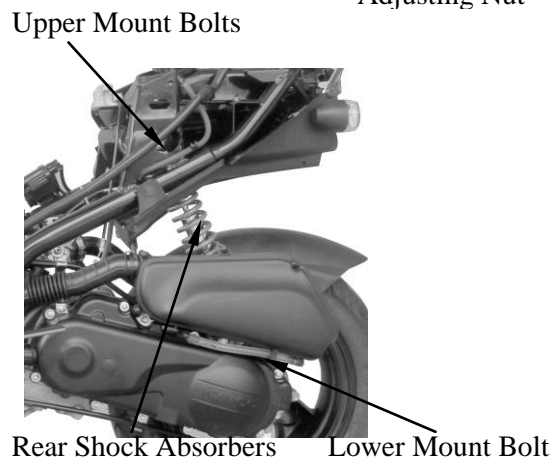
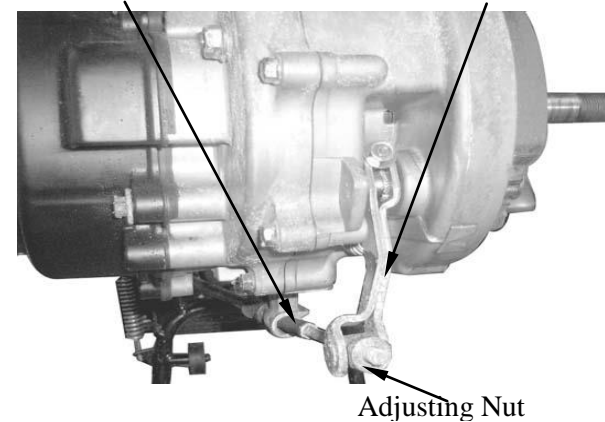
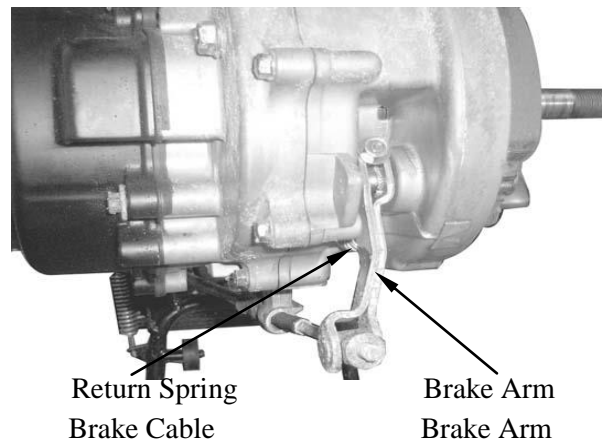

## LEFT REAR SHOCK ABSORBER REMOVAL

Remove the frame body cover. (⇒2-3)  
Remove the air cleaner case. (⇒5-19)

Remove the rear shock absorber upper and lower mount bolts.  
Remove the rear shock absorber.

## DISASSEMBLY

Install the rear shock absorber compressor as the figure shown.

\* Install the rear shock absorber lower joint into the rear shock absorber compressor.

Compress the rear shock absorber spring.

**Special**

Cushion Assemble & Disassemble Tool

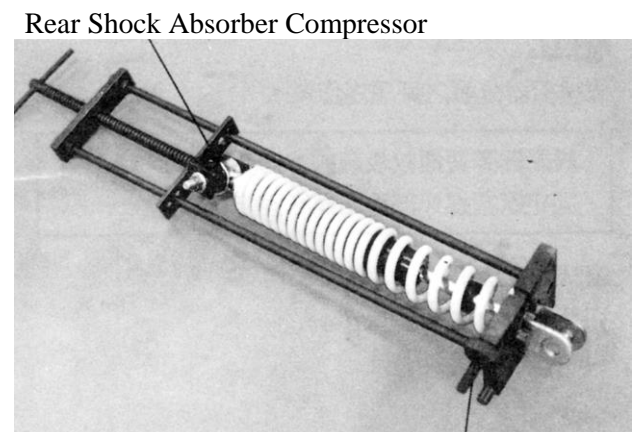

Cushion Assemble & Disassemble Tool

# 13. REAR WHEEL/REAR BRAKE/ REAR SUSPENSION

## INSPECTION

Inspect the damper rod for bending or damage.  
Inspect the damper for oil leaks.  
Inspect the damper rubber for deterioration or damage.

Measure the rear shock absorber spring free length.

**Service Limit:** 210mm replace if over

## ASSEMBLY

Assemble the rear shock absorbers in the reverse order of disassembly.

- \* Install the shock absorber spring with loosely wound coils facing down.
- \* Apply locking agent to the lock nut threads and tighten the lock nut.

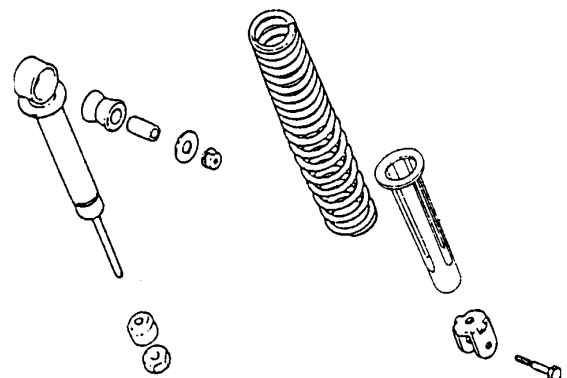
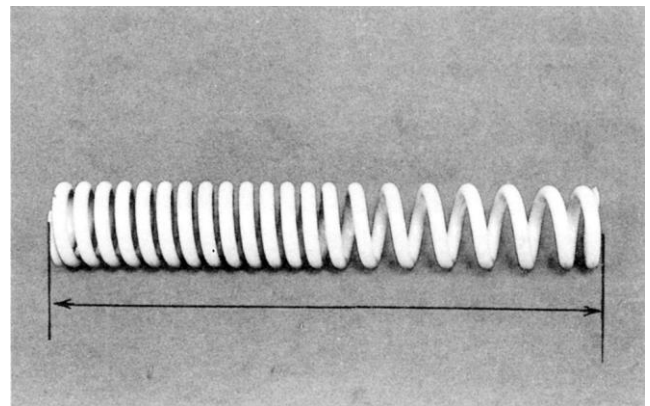
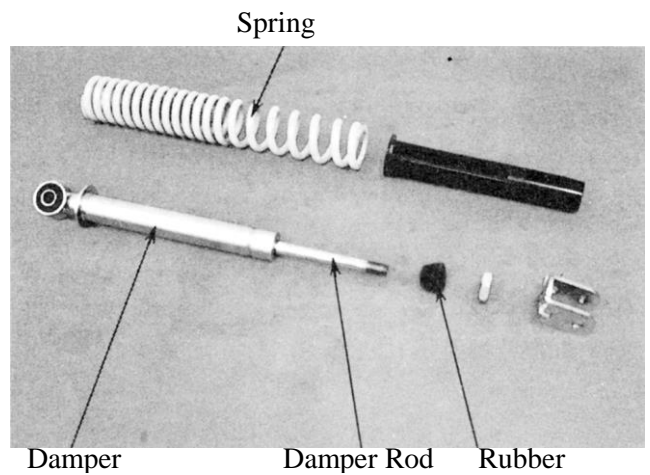
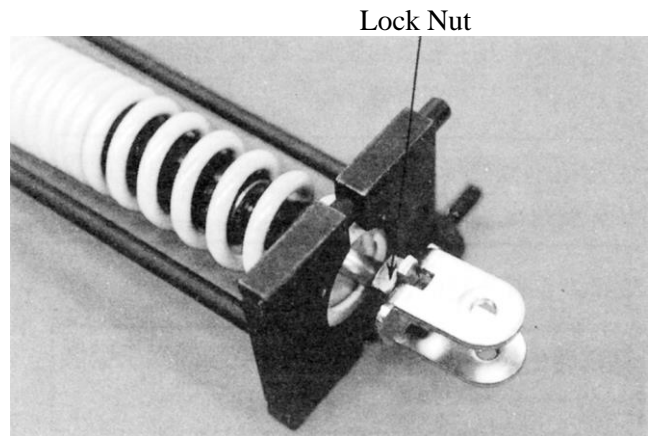

# 13. REAR WHEEL/REAR BRAKE/ REAR SUSPENSION

## INSTALLATION

Install the rear shock absorber.  
Install the rear shock absorber upper mount bolt and then the lower mount bolt.  
Tighten the bolts.

### Torque:

Upper Mount Bolt: 3.5~4.5kgf-m

Lower Mount Bolt: 2.4~3.0kgf-m

Install the air cleaner case. (⇒5-15)

Install the frame body cover. (⇒2-3)

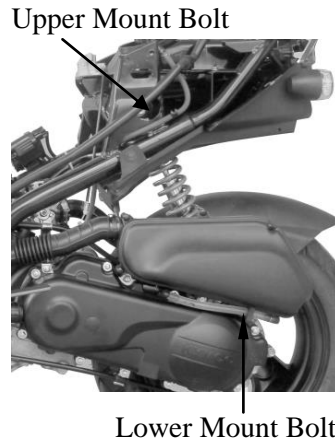

# 14. BATTERY/CHARGING SYSTEM/ A.C. GENERATOR

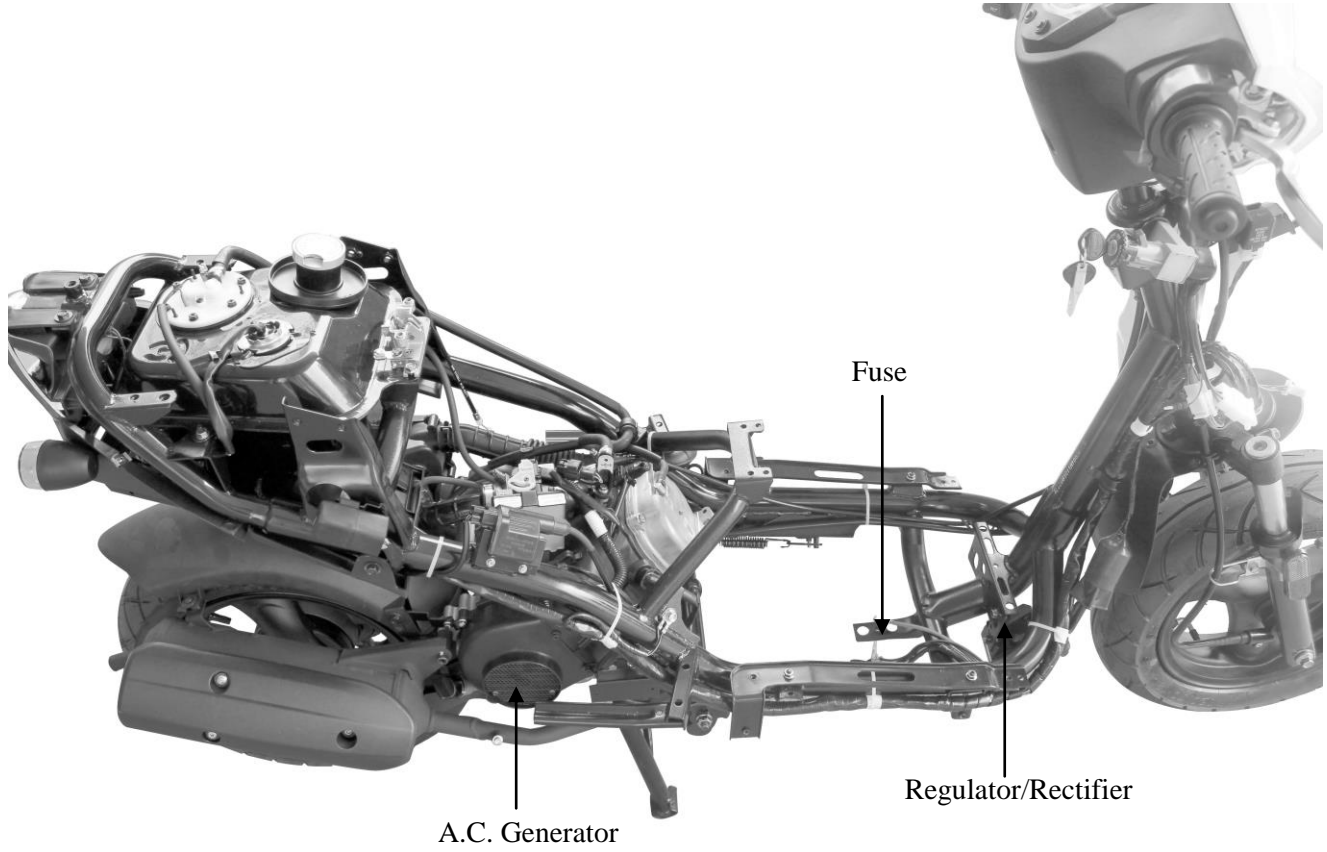

# 14. BATTERY/CHARGING SYSTEM/ A.C. GENERATOR

SERVICE INFORMATION.....	14-1	A.C. GENERATOR CHARGING COIL....	14-6
TROUBLESHOOTING .....	14-2	A.C. GENERATOR REMOVAL .....	14-6
BATTERY.....	14-3	A.C. GENERATOR INATALLATION....	14-8
CHARGING SYSTEM .....	14-4		
REGULATOR/RECTIFIER.....	14-5		

## SERVICE INFORMATION

### GENERAL INSTRUCTIONS

\* The battery electrolyte (sulfuric acid) is poisonous and may seriously damage the skin and eyes. Avoid contact with skin, eyes, or clothing. In case of contact, flush with water and get prompt medical attention

- The battery can be charged and discharged repeatedly. If a discharged battery is not used for a long time, its service life will be shortened. Generally, the capacity of a battery will decrease after it is used for 2~3 years. A capacity-decreased battery will resume its voltage after it is recharged but its voltage decreases suddenly and then increases when a load is added.
- When a battery is overcharged, some symptoms can be found. If there is a short circuit inside the battery, no voltage is produced on the battery terminals. If the rectifier won't operate, the voltage will become too high and shorten the battery service life.
- If a battery is not used for a long time, it will discharge by itself and should be recharged every 3 months.
- A new battery filled with electrolyte will generate voltage within a certain time and it should be recharged when the capacity is insufficient. Recharging a new battery will prolong its service life.
- Inspect the charging system according to the sequence specified in the Troubleshooting.
- Do not disconnect and soon reconnect the power of any electrical equipment because the electronic parts in the regulator/rectifier will be damaged. Turn off the ignition switch before operation.
- It is not necessary to check the MF battery electrolyte or fill with distilled water.
- Check the load of the whole charging system.
- Do not quick charge the battery. Quick charging should only be done in an emergency.
- Remove the battery from the motorcycle for charging.
- When replacing the battery, do not use a traditional battery.
- When charging, check the voltage with an electric tester.

### SPECIFICATIONS

Item		Standard	
Battery	Capacity	12V6AH	
	Voltage (20°C)	Fully charged	12.8V
		Insufficient charged	< 12V
	Charging current	0.6A * 5~10H	



# 14. BATTERY/CHARGING SYSTEM/ A.C. GENERATOR

---

## TORQUE VALUES

Pulser coil bolt	0.45~0.6kgf-m
Stator bolt	0.8~1.2kgf-m
Flywheel nut	3.5~4.5kgf-m
Cooling fan bolt	0.8~1.2kgf-m

## SPECIAL TOOLS

Universal holder  
Flywheel puller

## TESTING INSTRUMENTS

Kowa electric tester  
Sanwa electric tester

## TROUBLESHOOTING

### No power

- Dead battery
- Disconnected battery cable
- Fuse burned out
- Faulty ignition switch

### Low power

- Weak battery
- Loose battery connection
- Charging system failure
- Faulty regulator/rectifier

### Intermittent power

- Loose battery cable connection
- Loose charging system connection
- Loose connection or short circuit in lighting system

### Charging system failure

- Loose, broken or shorted wire or connector
- Faulty regulator/rectifier
- Faulty A.C. generator

# 14. BATTERY/CHARGING SYSTEM/ A.C. GENERATOR

## BATTERY

### REMOVAL

Remove the battery cover screws on the floor board.

Open the battery cover and remove the battery by removing the bolt and band.

First disconnect the battery negative (-) cable

When disconnecting the battery positive (+) cable, do not touch the frame with tool; otherwise it will cause short circuit and sparks to fire the fuel.

and then the positive (+) cable.

The installation sequence is the reverse of removal.

First connect the positive (+) cable and the negative (-) cable to avoid short circuit.

### BATTERY VOLTAGE (OPEN CIRCUIT VOLTAGE) INSPECTION

Remove the floor board.

Open the battery cover and disconnect the battery cables.

Measure the voltage between the battery terminals.

Fully charged : 13.1V

Undercharged: 12.3V max.

\* Battery charging inspection must be performed with a voltmeter.

### CHARGING

Connect the charger positive (+) cable to the battery positive (+) terminal.

Connect the charger negative (-) cable to the battery negative (-) terminal.

- Keep flames and sparks away from a charging battery.
- Turn power ON/OFF at the charger, not at the battery terminals to prevent sparks near the battery to avoid explosion.
- Charge the battery according to the current specified on the battery.

- \* Quick charging should only be done in an emergency.
- Measure the voltage 30 minutes after the battery is charged.

Charging current: Standard : 0.4A  
Quick : 4A

Charging time : Standard : 5~10 hours  
Quick : 30 minutes

After charging: Open circuit voltage: 12.8V min.

Note: The battery temperature should not exceed 45°C during charging.

Battery Cover



battery



negative (-) cable

positive (+) cable

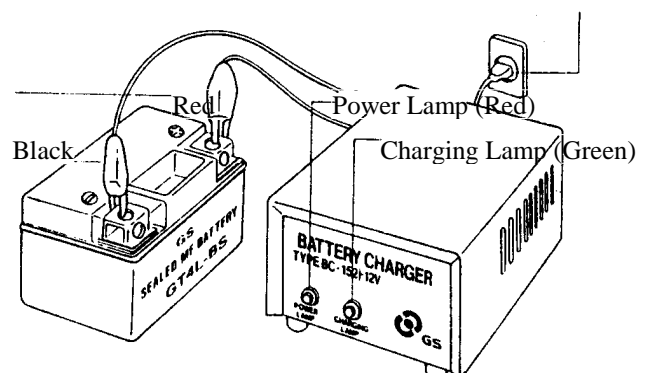
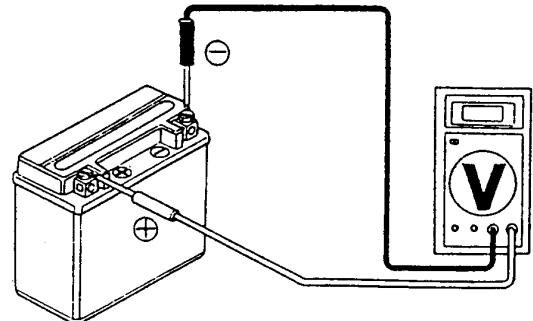

# 14. BATTERY/CHARGING SYSTEM/ A.C. GENERATOR

## CHARGING SYSTEM

### SHORT CIRCUIT TEST

Disconnect the ground wire from the battery and connect an ammeter across the battery negative (-) terminal and the ground wire. Turn the ignition switch OFF and check for short circuit.

\* Connect the electric tester positive (+) terminal to ground wire and the tester negative (-) terminal to the battery negative (-) terminal.

If any abnormality is found, check the ignition switch and wire harness for short circuit .

### CURRENT TEST

This inspection must be performed with an electric tester when the battery is fully charged.

Warm up the engine for inspection.

Connect the electric tester across the battery terminals. Disconnect the fuse and connect an ammeter between the fuse terminals.

Attach a tachometer to the engine.

Start the engine and gradually increase the engine speed to measure the limit voltage and current.

**Limit Voltage/Current:** 13.5-14.5V/0.5A  
max. (5000rpm max.)

If the limit voltage is not within the specified range, check the regulator/rectifier. (⇒14-5)

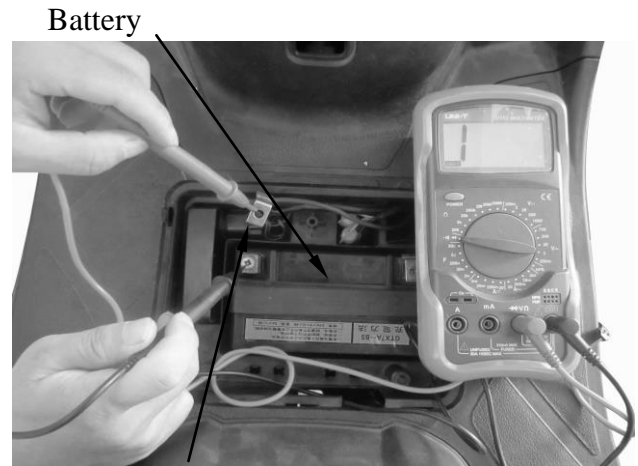

Terminal

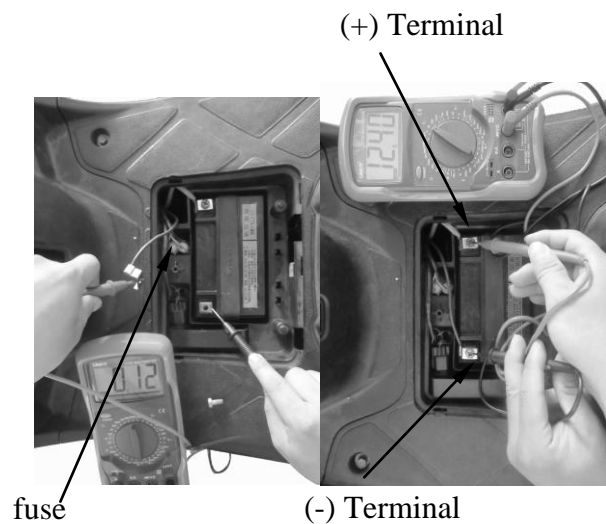

# 14. BATTERY/CHARGING SYSTEM/ A.C. GENERATOR

## REGULATOR/RECTIFIER WIRE HARNESS INSPECTION

Remove the luggage box

Disconnect the regulator/rectifier connectors.

Check the connectors for loose contacts of corroded terminals.

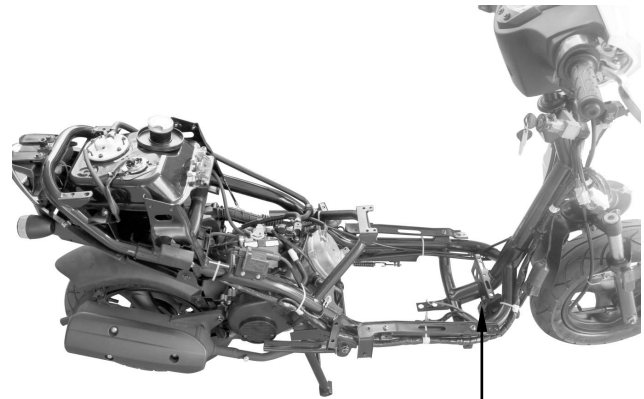

Regulator/Rectifier

## BATTERY WIRE

Measure the voltage between the Red/White wire terminal and ground.

There should be battery voltage at all times.

## GROUND WIRE

Check the continuity between the Green wire terminal and ground.

There should be continuity at all times.

# 14. BATTERY/CHARGING SYSTEM/ A.C. GENERATOR

## A.C. GENERATOR CHARGING COIL

\* The inspection of A.C. generator charging coil can be made with the engine installed.

### A.C. GENERATOR INSPECTION

This test can be made without removing the star from the engine. Disconnect the yellow wire from the auto-bystarter.

Remove the met-in box.

Disconnect the A.C. generator connector.

Check the continuity between the yellow wires and ground.

There should be continuity between the yellow wires and on continuity between each yellow wire and ground.

#### Resistance:

Yellow~Yellow	1~2.5 Ω
---------------	---------



Charging Coil Wire

## A.C. GENERATOR REMOVAL

Remove the right side cover. (⇒2-4)

Remove the four bolts attaching the cooling fan cover to remove the fan cover.

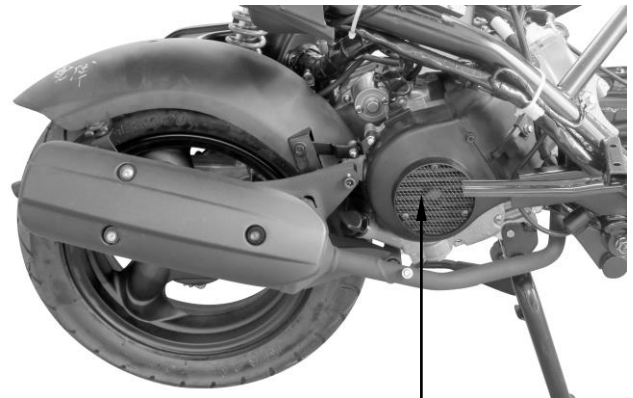

Fan Cover

# 14. BATTERY/CHARGING SYSTEM/ A.C. GENERATOR

Remove the cooling fan by removing the four cooling fan attaching bolts.

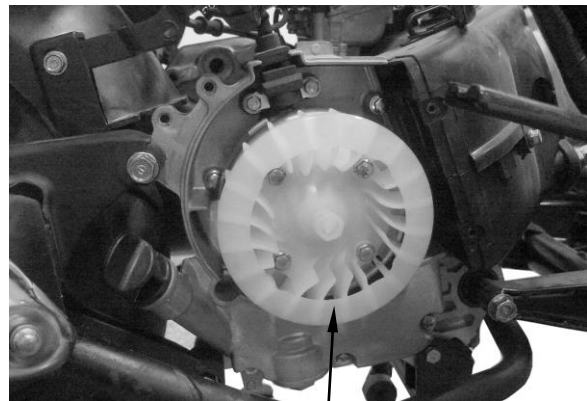

Cooling Fan

Hold the flywheel with an universal holder.  
Remove the flywheel nut.

**Special**

Universal Holder

Universal Holder

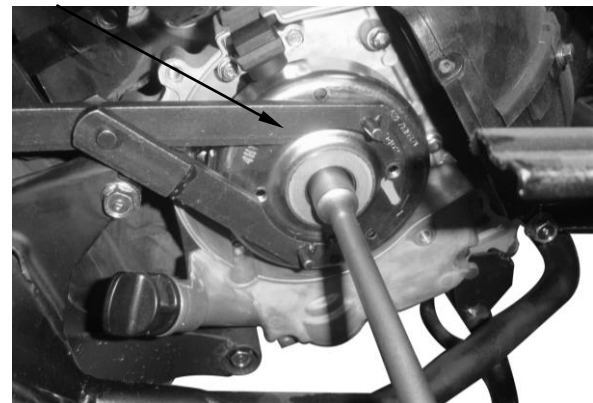

Remove the A.C. generator flywheel using  
the flywheel puller.  
Remove the woodruff key.

**Special**

Flywheel Puller

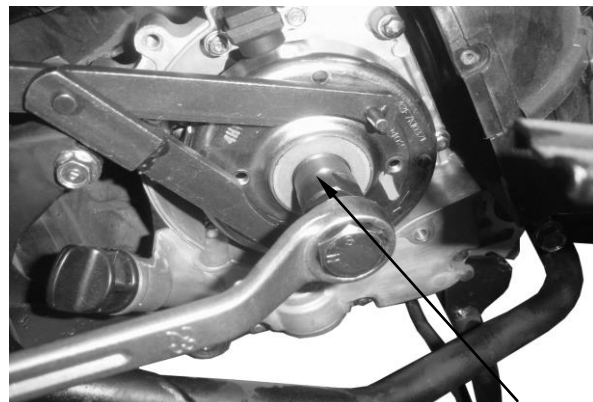

Flywheel Puller

Remove the A.C. generator wire connector.

A.C. Generator Wire Connector

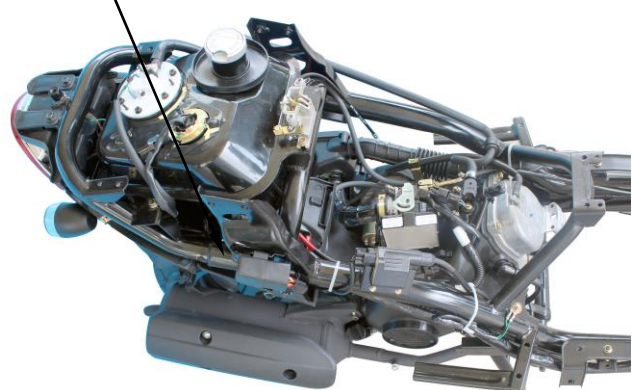

# 14. BATTERY/CHARGING SYSTEM/ A.C. GENERATOR

Remove the A.C. generator wire set plate.  
Remove the pulser coil bolts.  
Remove the A.C. generator wire rubber sleeve and pulser coil from the right crankcase.  
Remove the two bolts and A.C. generator stator.

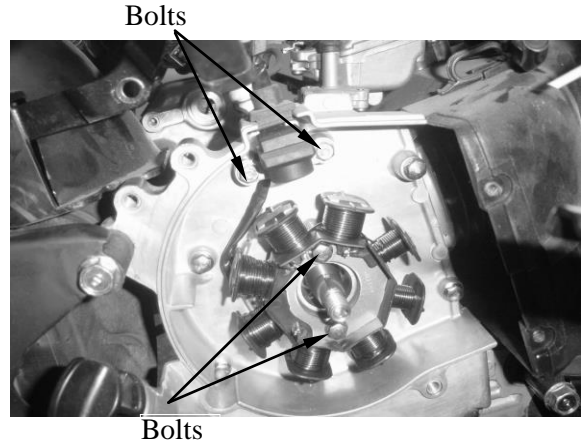

## A.C. GENERATOR INSTALLATION

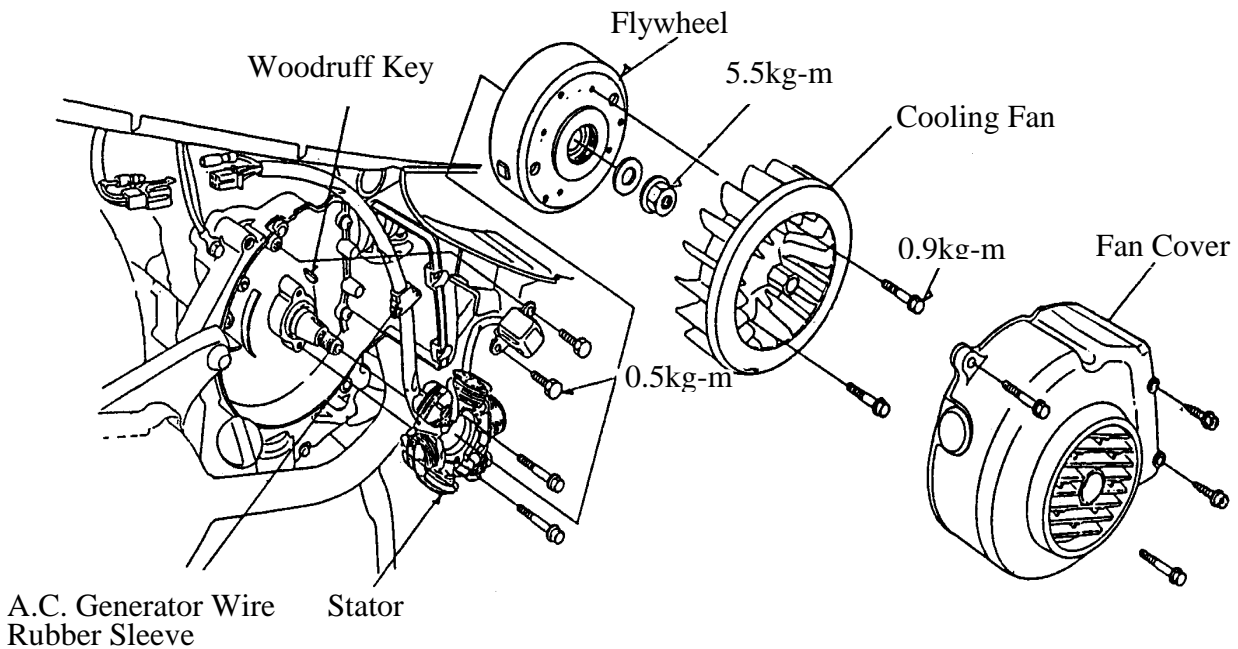

Install the A.C. generator stator and pulser coil onto the right crankcase.  
Tighten the stator and pulser coil bolts.

**Torques: Pulser Coil** : 0.45~0.6kgf-m  
**Stator** : 0.8~1.2kgf-m

Install the A.C. generator wire rubber sleeve and A.C. generator wire set plate.

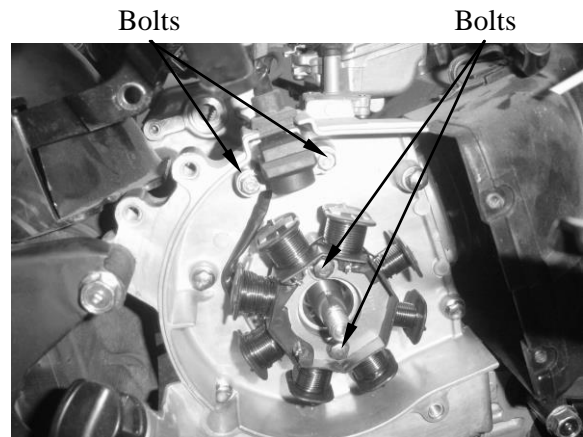



# 14. BATTERY/CHARGING SYSTEM/ A.C. GENERATOR

Clean the taper hole in the flywheel off any burrs and dirt.  
Install the woodruff key in the crankshaft keyway.

A.C. Generator Wire Connector

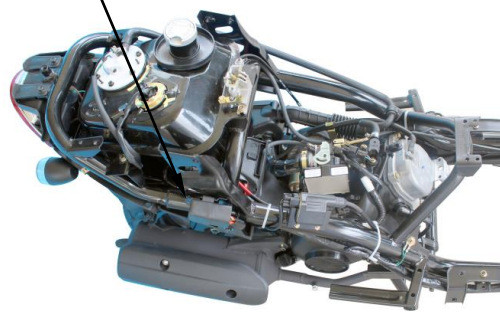

Install the flywheel onto the crankshaft with the flywheel hole aligned with the crankshaft woodruff key.

\* The inside of the flywheel is magnetic. Make sure that there is no bolt or nut before installation.

Woodruff Key

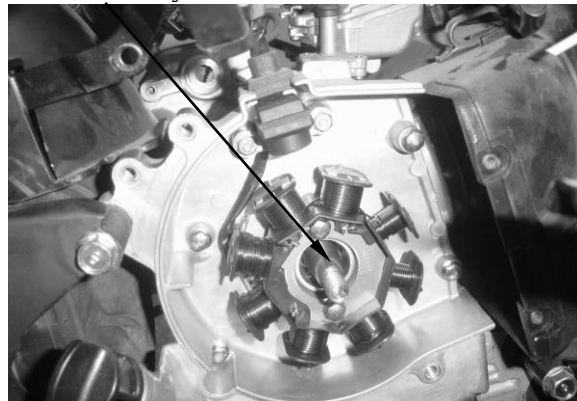

Hold the flywheel with the universal holder and tighten the flywheel nut.

**Torque:** 3.5~4.5kgf-m

Universal Holder

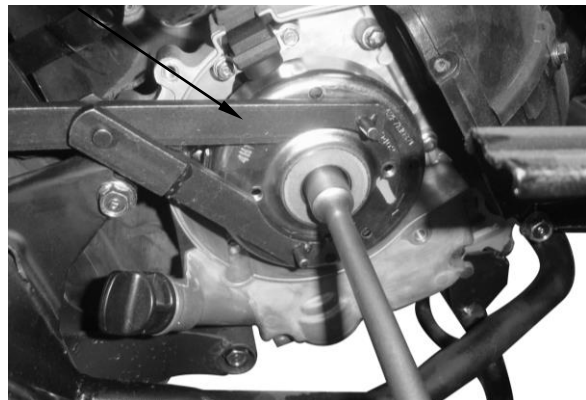

Special

Universal Holder

Install the cooling fan.

**Torque:** 0.8~1.2kgf-m

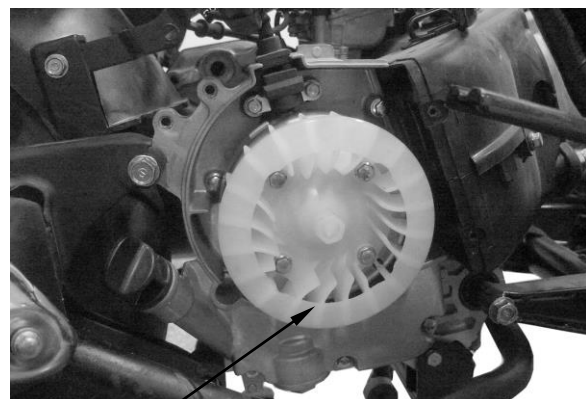

Cooling Fan



## 14. BATTERY/CHARGING SYSTEM/ A.C. GENERATOR

---

 **KYMCO**  
Agility Carry / Delivery 50i

Install the fan cover.  
Install the right side cover. (⇒2-4)

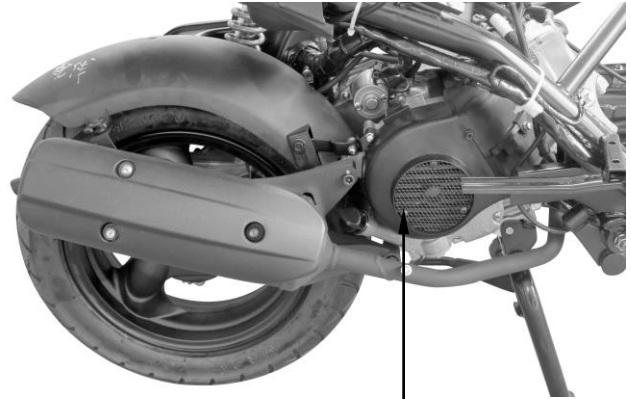

Fan Cover

# 15. IGNITION SYSTEM

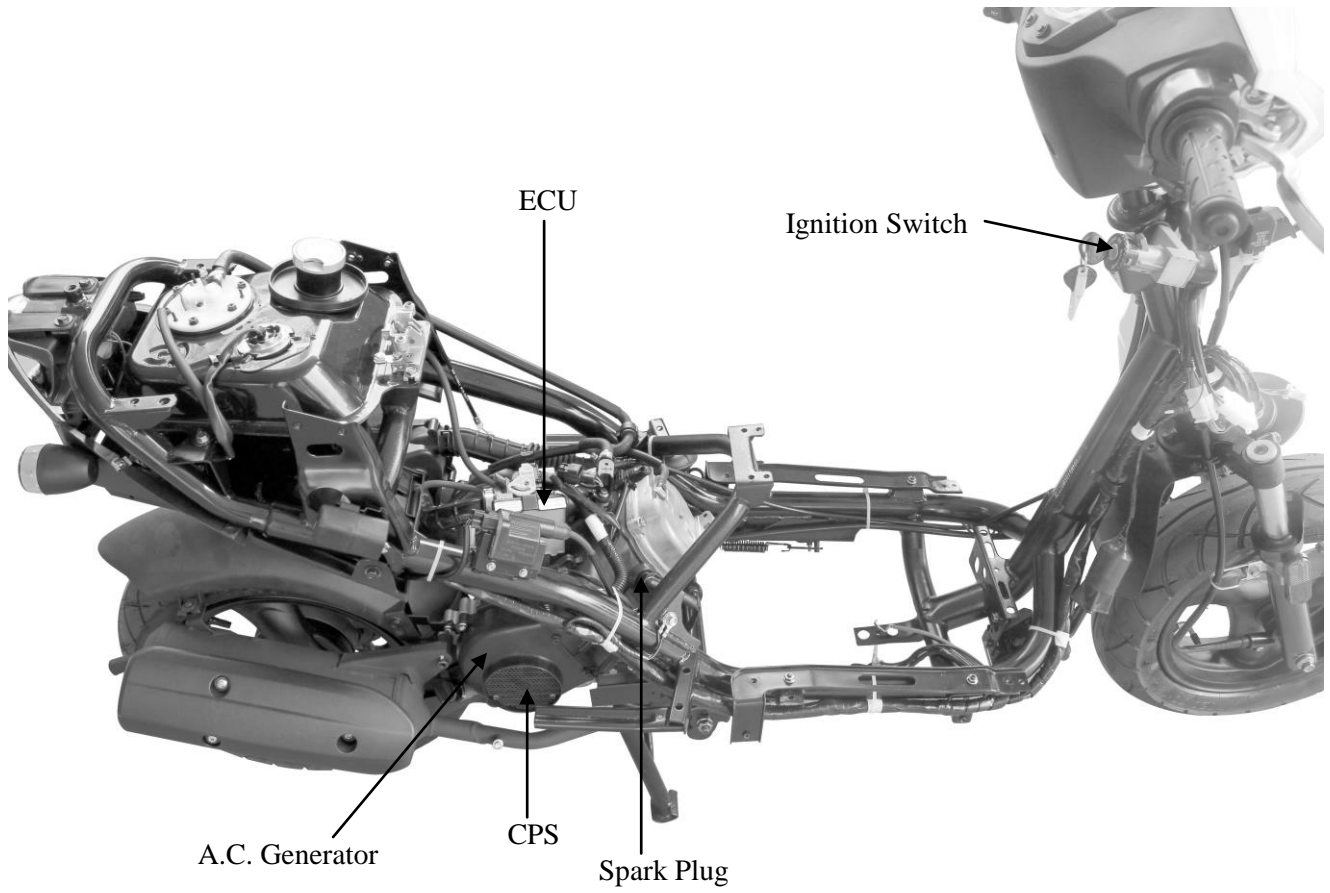

# 15. IGNITION SYSTEM

## SERVICE INFORMATION

### GENERAL INSTRUCTIONS

- Some electrical components may be damaged if terminals or connectors are connected or disconnected while the ignition switch is “ON” and current is present.
- When servicing the ignition system, always follow the steps in the troubleshooting on page 17-2.
- The ignition timing cannot be adjusted since the ignition control module is already adjusted in factory.
- The ignition control module or ECU maybe damaged if dropped or the connector is disconnected when the key is “ ON ” , the excessive voltage may damage the ignition control module or ECU. Always turn off the ignition switch before servicing.
- A faulty ignition system is often related to poor connections. Check those connections before proceeding.
- Make sure the battery is adequately charged. Using the starter motor with weak battery results in a slower engine cranking speed as well as no spark at the spark plug.
- Use a spark plug of the correct heat range. Using spark plug with an incorrect heat range can damage the engine.

### SPECIFICATIONS

Item		Standard
Spark plug	Standard type	NGK CR6HSA
Spark plug gap		0.6 ~ 0.7 mm
Inductive Ignition Coil	Primary coil	0.55~0.75Ω
Throttle Position Sensor Input Volt		5V±0.1
Fuel Pump		2.0Ω
Fuel Injector		10.6Ω~15.9Ω
Engine Temperature Sensor		10kΩ~12kΩ(25℃)
Oxygen Sensor ( engine warming condition )		6.7 ~ 9.5Ω
Crank Position Sensor		96~144Ω
Angle Detect Sensor		0.4V~1.44V(normal) 3.7V~4.4V (fall down)

## TROUBLESHOOTING

### No peak voltage

- Short circuit in engine stop switch or ignition switch wire.
- Faulty engine stop switch or ignition switch.
- Loose or poorly connected ignition control module connectors.
- Open circuit or poor connection in ground wire of the ignition control module.
- Faulty crank position sensor.
- Faulty ignition control module.

### Peak voltage is normal, but no spark jumps at the plug

- Faulty spark plug or leaking ignition coil secondary current.
- Faulty ignition coil.

# 15. IGNITION SYSTEM

## IGNITION COIL

### REMOVAL

Remove the met-in box. (⇒2-3)  
 Remove the spark plug cap.  
 Disconnect the ignition coil wires and remove the ignition coil bolt and ignition coil.

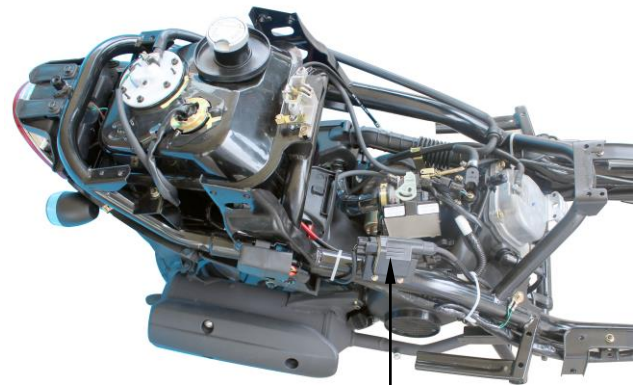

Ignition Coil

## SPARK PLUG

Spark plug inspection and adjustment

## IGNITION COIL CONTINUITY TEST

Inspect the continuity of the ignition coil, primary coil.

\* This is a general test. Accurate ignition coil test must be performed with an ignition unit tester.

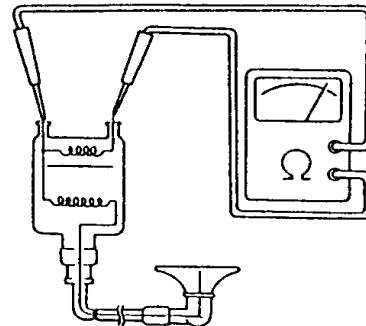

Measure the ignition coil resistances at 20°C.

Primary coil	0.55~0.75 Ω
--------------	-------------

# 15. IGNITION SYSTEM

## A .C. GENERATOR INSPECTION

### CRANK POSITION SENSOR INSPECTION

\* This test is performed with the stator installed in the engine.

Remove the seat and met-in box.  
 Disconnect the Crank Position Sensor Wire Coupler.  
 Measure the resistance between the blue/white and green/white wire terminals.

Blue/Yellow~Green/White	96~144Ω
-------------------------	---------

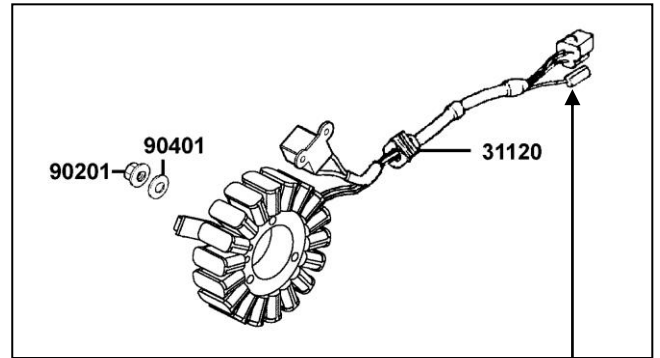

Crank Position Sensor Wire Coupler

## ANGLE DETECT SENSOR

### INSPECTION

Support the scooter level surface.  
 Put the side stand up and engine stop switch is at "RUN".  
 Turn the ignition switch to "OFF".  
 Remove the screws, washers and tilt switch.

\* Do not disconnect the tilt switch connector during inspection. The capacity of battery must be fully charged.

Place the tilt switch vertical as shown at the ignition switch "ON". Measure the voltage as below.

Terminal	Standard
Violet/Red (+) -Violet/Green (-)	5 V (ECU voltage)
Black/White (+) -Violet/Green (-)	0.4 ~ 1.44 V less

Incline the tilt switch 65±10 degrees to the left or right at the ignition switch "ON". Measure the voltage as below.

Terminal	Standard
Violet/Red (+) -Violet/Green(-)	5 V (ECU voltage)
Black/White (+) -Violet/Green (-)	3.7 ~ 4.4 V

If repeat this test, first turn the ignition switch to "OFF", then turn the ignition switch to "ON".

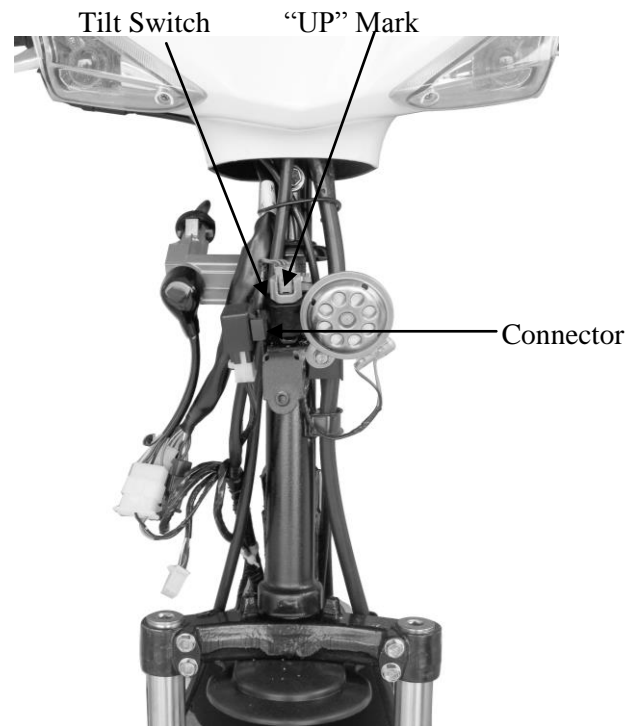

# 16. STARTING SYSTEM

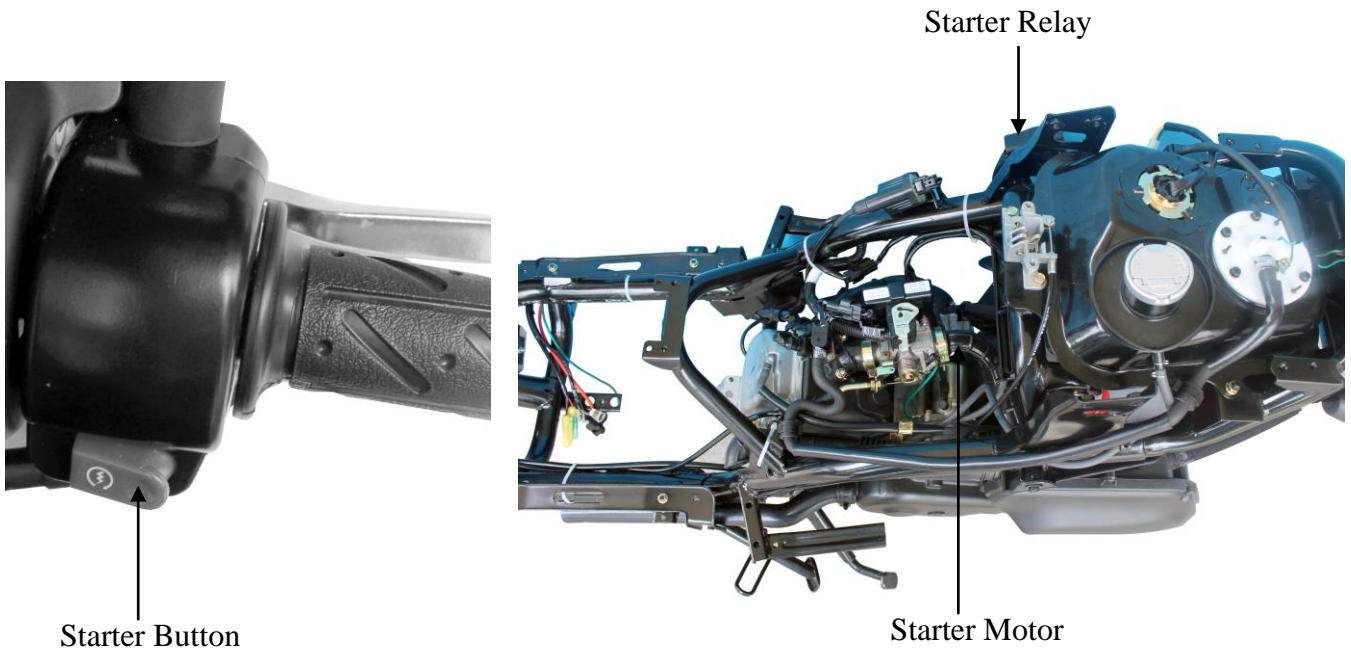

Starter Button

Starter Motor

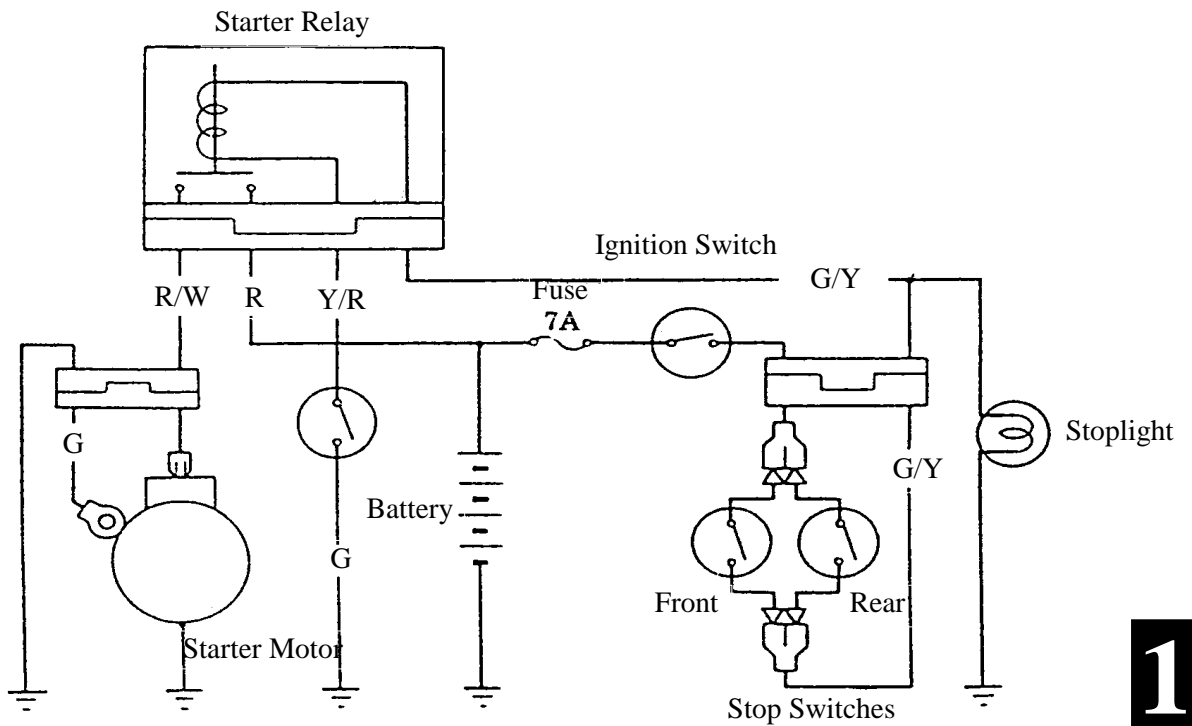

# 16. STARTING SYSTEM

SERVICE INFORMATION .....	16-1	STARTER MOTOR .....	16-2
TROUBLESHOOTING.....	16-1	STARTER RELAY.....	16-4

## SERVICE INFORMATION

### GENERAL INSTRUCTIONS

- The removal of starter motor can be accomplished with the engine installed.

### SPECIFICATIONS

Item	Standard (mm)	Service Limit (mm)
Starter motor brush length	12.5	8.5

## TROUBLESHOOTING

### Starter motor won't turn

- Fuse burned out
- Weak battery
- Faulty ignition switch
- Faulty starter clutch
- Faulty front or rear stop switch
- Faulty starter relay
- Poorly connected, broken or shorted wire
- Faulty starter motor

### Lack of power

- Weak battery
- Loose wire or connection
- Foreign matter stuck in starter motor or gear

### Starter motor rotates but engine does not start

- Faulty starter clutch
- Starter motor rotates reversely
- Weak battery

# 16. STARTING SYSTEM

## STARTER MOTOR

### REMOVAL

\* Before removing the starter motor, turn the ignition switch OFF and remove the battery ground. Then, turn on the ignition switch and push the starter button to see if the starter motor operates properly.

Remove the motor from the box.  
 Remove the starter motor cable.  
 Remove the two starter motor mounting bolts and the motor.

Remove the waterproof rubber jacket and disconnect the starter motor cable connector.

### DISASSEMBLY

Remove the two starter motor case screws, front cover, motor case and other parts.

### INSPECTION

Inspect the removed parts for wear, damage or discoloration and replace if necessary. Clean the commutator if there is metal powder between the segments.

Check for continuity between pairs of the commutator segments and there should be continuity. Also, make a continuity check between individual commutator segments and the armature shaft. There should be no continuity.

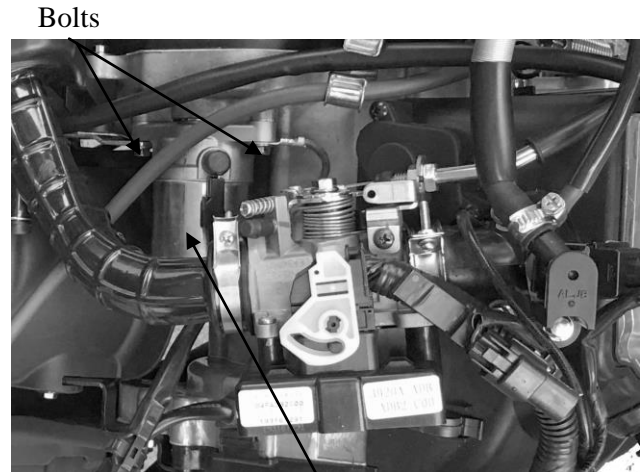

Bolts

Starter Motor Cable

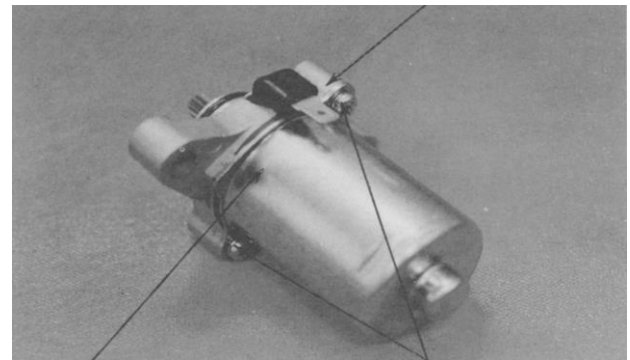

Front Cover

Motor Case

Case Screws  
Commutator

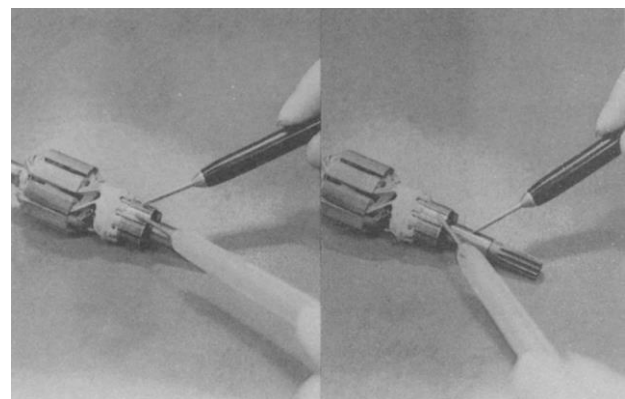
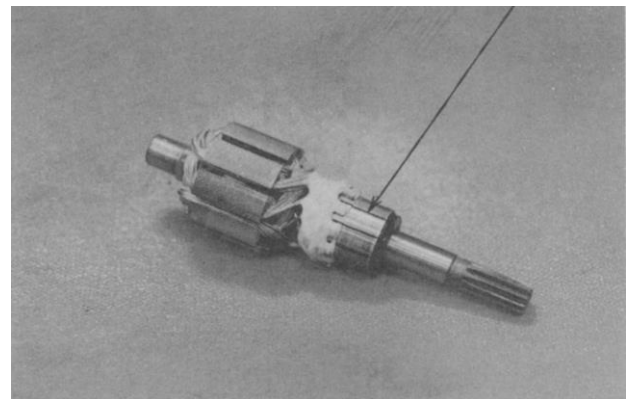



## 16. STARTING SYSTEM

### STARTER MOTOR CASE CONTINUITY CHECK

Check to confirm that there is no continuity between the starter motor wire terminal and the motor front cover.

Also check for the continuity between the wire terminal and each brush and there should be continuity.

Replace if necessary.

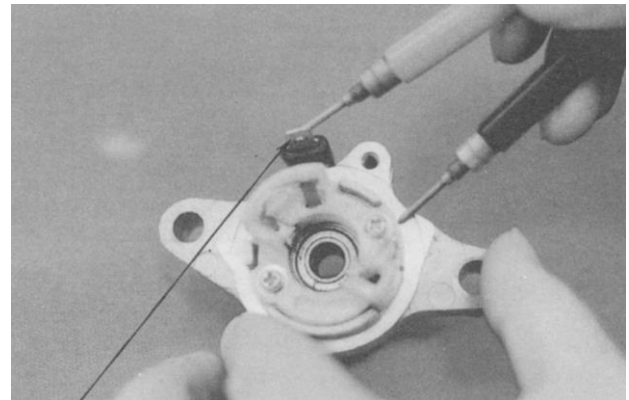

Wire Terminal

Measure the length of the brushes.

**Service Limit:** 8.5mm replace if below

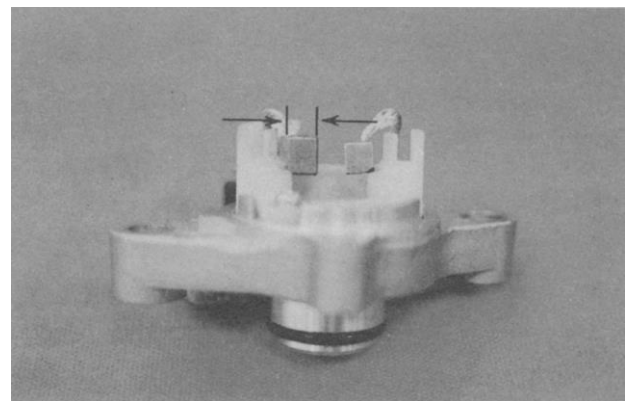

Check for continuity between the brushes. If there is continuity, replace with new ones.

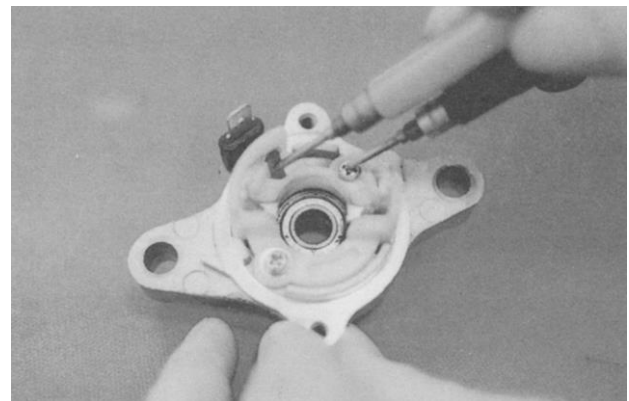

Check if the needle bearing in the front cover turns freely and has no excessive play.

Replace if necessary.

Check the dust seal for wear or damage.

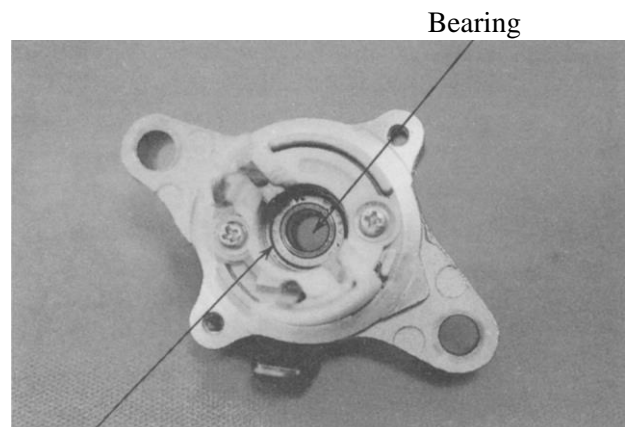

Dust Seal

# 16. STARTING SYSTEM

## ASSEMBLY

Apply grease to the dust seal in the front cover.  
 Install the brushes onto the brush holders.  
 Apply a thin coat of grease to the two ends of the armature shaft.  
 Insert the commutator into the front cover.

- \* 
 • Be careful not to damage the brush and armature shaft mating surfaces.
- When installing the commutator, the armature shaft should not damage the dust seal lip.

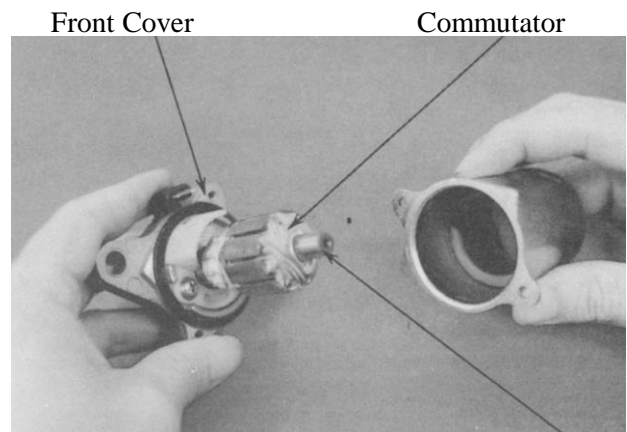

Install a new O-ring to the front cover.  
 Install the starter motor case, aligning the tab on the motor case with the tab on the front cover.  
 Tighten the starter motor case screws.

- \* 
 When assembling the front cover and motor case, slightly press down the armature shaft to assemble them.

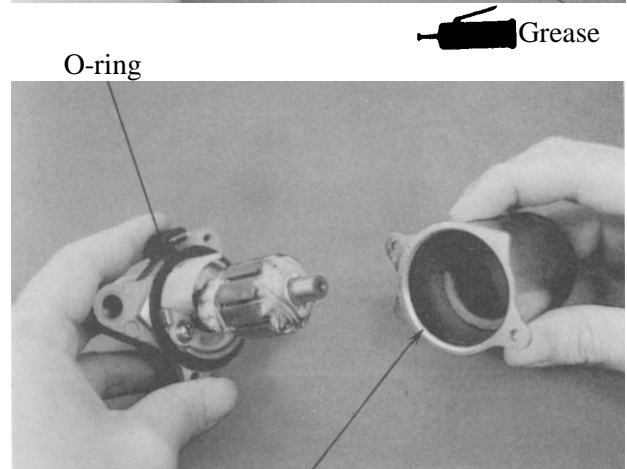

## STARTER RELAY

### INSPECTION

Remove the met-in box.  
 Remove the battery cover.  
 Remove the frame body cover. (⇒2-2)  
 Turn the ignition switch ON and the starter relay is normal if you hear a click when the starter button is depressed.  
 If there is no click sound:

- Inspect the starter relay voltage
- Inspect the starter relay ground circuit
- Inspect the starter relay operation



Starter Relay

### STARTER RELAY VOLTAGE

#### INSPECTION

Place the motorcycle on its main stand.  
 Measure the voltage between the starter relay connector green/yellow wire (-) and engine ground.  
 Turn the ignition switch ON and the battery voltage should be normal when the brake lever is fully applied.  
 If the battery has no voltage, inspect the stop switch continuity and cable.

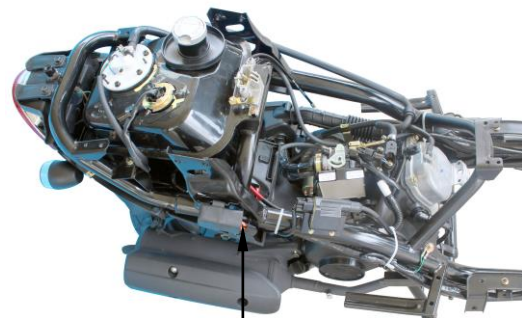

Green/Yellow /Red Wire

- \* 
 Turn to the DCV position for the voltage meter, then inspect the starter relay.

# 16. STARTING SYSTEM

## STARTER RELAY TEST

Remove the battery cover.  
 Disconnect the 4P connector from the starter relay and remove the starter relay.

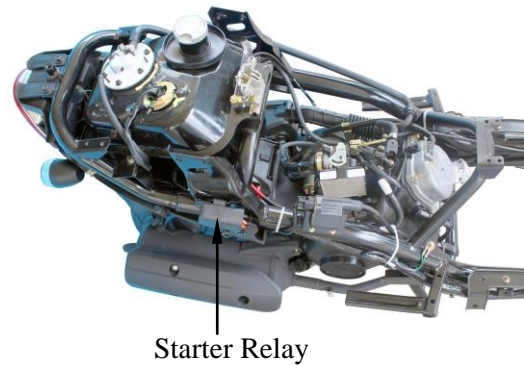

Starter Relay

Connect the starter relay (D) terminal to the 12V battery positive (+) terminal and the relay (C) terminal to the battery negative (-) terminal. Check for continuity between the starter relay (A) and (B) terminals. The relay is normal if there is continuity.

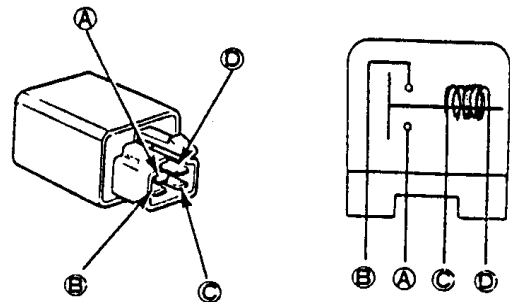

## STARTER MOTOR INSTALLATION

Apply engine oil to the starter motor O-ring and install the starter motor.  
 Tighten the two mounting bolts.  
 Connect the starter motor cable connector.

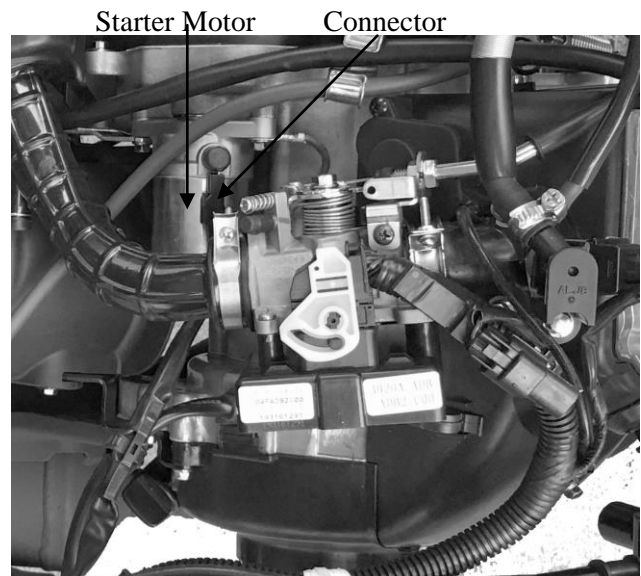

<b>SERVICE INFORMATION</b> .....	<b>17-0</b>	<b>IGNITION SWITCH</b> .....	<b>17-3</b>
<b>TROUBLESHOOTING</b> .....	<b>17-0</b>	<b>STOP SWITCHES/HORN</b> .....	<b>17-4</b>
<b>FUEL UNIT</b> .....	<b>17-1</b>	<b>INSTRUMENTS</b> .....	<b>17-4</b>
<b>HANDLEBAR SWITCHES</b> .....	<b>17-2</b>	<b>HEADLIGHT/LIGHTS</b> .....	<b>17-5</b>

### SERVICE INFORMATION

#### GENERAL INSTRUCTIONS

- An electric tester is needed to measure or test the electric equipment.
- Be sure to use fuses and bulbs of the same specifications to avoid damage of electrical equipment.
- After installation of each switch, a continuity check must be performed. A continuity check can usually be made without removing the part from the motorcycle.

### TROUBLE SHOOTING

#### Lights do not come on when ignition switch is “ON”

- Burned bulb
- Faulty switch
- Broken wire
- Fuse burned out
- Weak battery
- Poorly connected or shorted wire
- Faulty winker

#### Light dims

- Faulty ignition coil
- Wire or switch resistance too high
- Faulty regulator/rectifier

#### Headlight does not change when dimmer switch is turn to Hi or Lo

- Faulty or burned bulb
- Faulty dimmer switch

#### Fuel gauge pointer does not register correctly

- Disconnected wire or connector
- Broken wire
- Faulty float
- Faulty fuel unit
- Faulty instrument

#### Fuel gauge pointer fluctuates or swings

- Loose wire connection
- Faulty fuel unit
- Faulty instrument

### FUEL UNIT

\* No Smoking!

#### REMOVAL

Remove the met-in box. (⇒2-3)  
 Remove the frame right side cover. (⇒2-4)  
 Disconnect the fuel unit wire connector.  
 Turn the fuel unit retainer counterclockwise to remove it.

\* Do not damage the fuel unit wire.

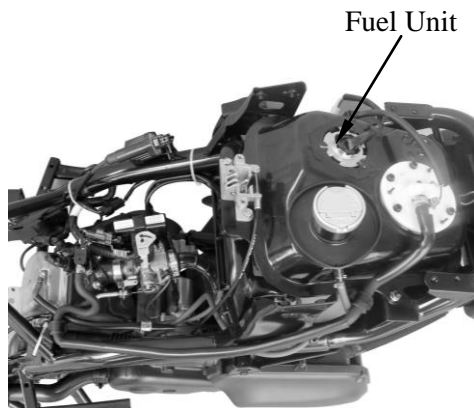

Remove the fuel unit.

\* Be careful not to bend or damage the fuel unit float arm.

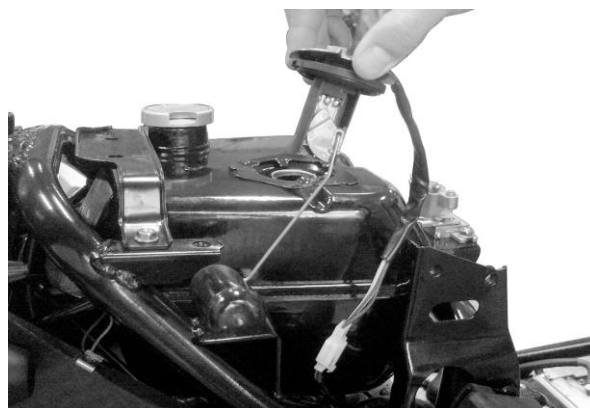

#### INSTALLATION

The installation sequence is the reverse of removal.

\* 

- Align the groove on the fuel unit with the tab on the fuel tank.
- Align the arrow on the retainer with the arrow on the fuel tank.
- Turn the retainer clockwise to secure it.

#### INSPECTION

Remove the fuel unit.  
 Measure the resistance between the fuel unit wire terminals with the float at upper and lower positions.

Wire Terminals	Upper	Lower
G~Y/W	30Ω	686Ω
G~L/W	566Ω	153Ω
Y/W~L/W	599Ω	599Ω

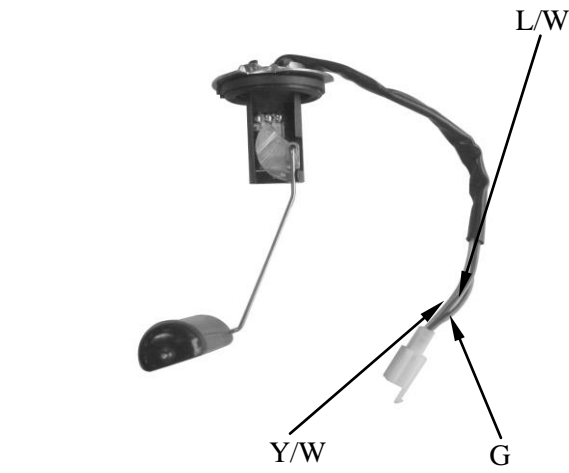

#### FUEL GAUGE INSPECTION

Connect the fuel unit wire connector and turn the ignition switch "ON".

\* Before performing the following test, operate the turn signals to determine that the battery circuit is normal.

Check the fuel gauge needle for correct indication by moving the fuel unit float up and down.

Float Position	Needle Position
Upper	F
Lower	E



## HANDLEBAR SWITCHES

### INSPECTION

Remove the handlebar front cover. (⇒2-2)  
 Disconnect the handlebar switch couplers and check for continuity between wire terminals.  
 If there is any abnormality found, check each switch

### STARTER SWITCH

Color	Yellow/Red	Green
FREE		
PUSH	○	○

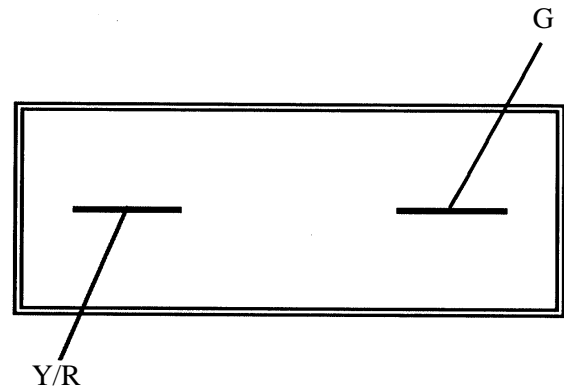

### DIMMER SWITCH

Color	White	Blue/White	Blue
☰	○	○	
☷		○	○

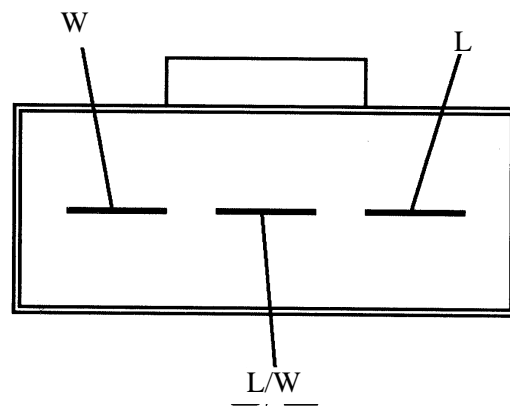

### TURN SIGNAL SWITCH

Color	Gray	Light Blue	Orange
R	○	○	
N			
L	○		○

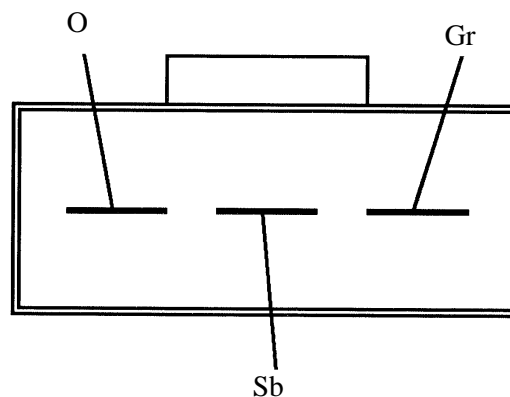



### HORN SWITCH

Color	Light Green	Black
FREE		
PUSH		

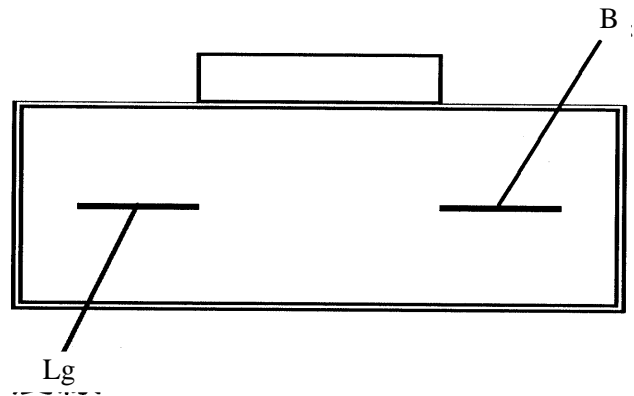

### SWITCH REPLACEMENT

Remove the front covers. (⇒2-2)  
 Remove the handlebar front cover. (⇒2-2)  
 The installation sequence is the reverse of removal.

### IGNITION SWITCH

#### INSPECTION

Remove the front covers. (⇒2-2)  
 Disconnect the ignition switch wire coupler.  
 Check for continuity between the wire terminals.

Color	Black	Red	Blue/ Yellow	Green
OFF				
ON				
LOCK				

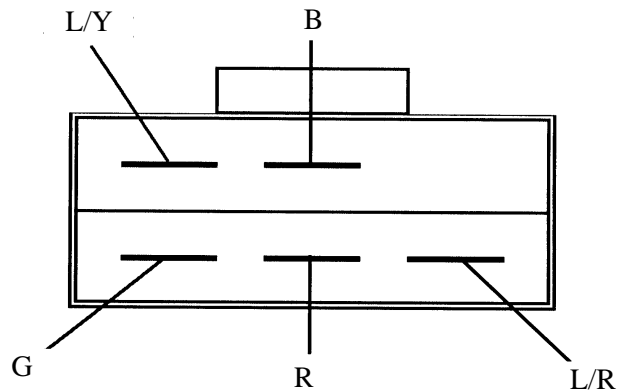

### IGNITION SWITCH REPLACEMENT

Remove the front covers. (⇒2-2)  
 Disconnect the ignition switch wire coupler.  
 Remove the two mounting bolts to remove the ignition switch decorative ring and holder.  
 Remove the two screws to remove the ignition switch from the ignition switch holder for replacement.  
 The installation sequence is the reverse of removal.



Bolts

## HORN

### INSPECTION

Remove the front covers. (⇒2-2)  
Disconnect the horn wire coupler.  
The horn is normal if it sounds when a 12V battery is connected across the horn wire terminals.

### REPLACEMENT

Disconnect the horn wire coupler.  
Remove the two bolts attaching the horn.  
Remove the horn.  
The installation sequence is the reverse of removal.

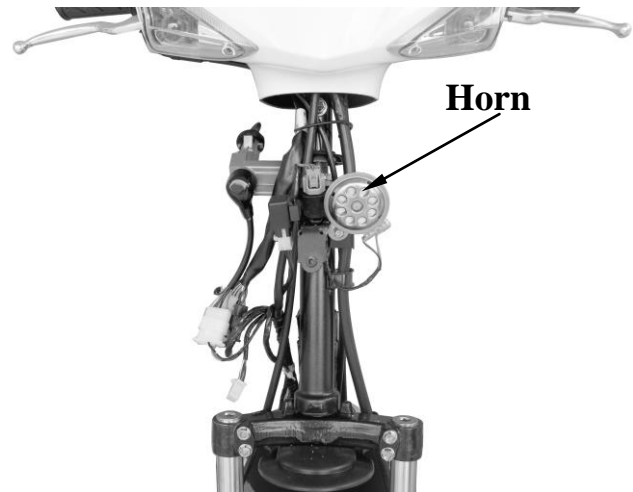

## INSTRUMENTS

Remove the handlebar front cover. (⇒2-2)  
Remove the handlebar rear cover. (⇒2-2)  
Disconnect the handlebar switch couplers.  
Remove the three screws to remove the instruments.  
Install a new horn in the reverse order of removal.

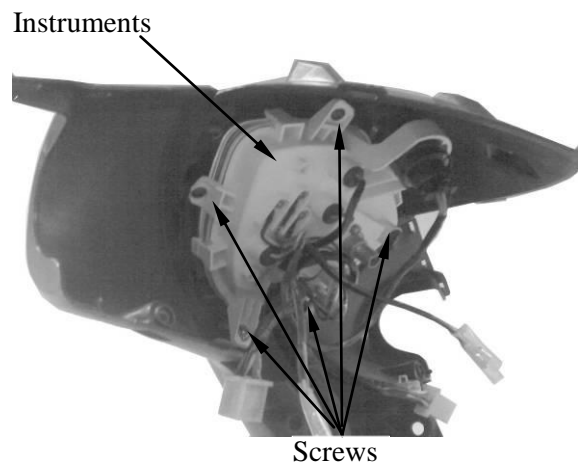



### HEADLIGHT

#### REMOVAL

Remove the screw on the front of the front cover.  
 Remove the 4 screws on the back of the front cover.  
 Remove the front cover.  
 The installation sequence is the reverse of removal.

- \*
- Align the tab on the headlight with the groove on the handlebar cover.
  - After installation, adjust the headlight beam. (⇒3-9)

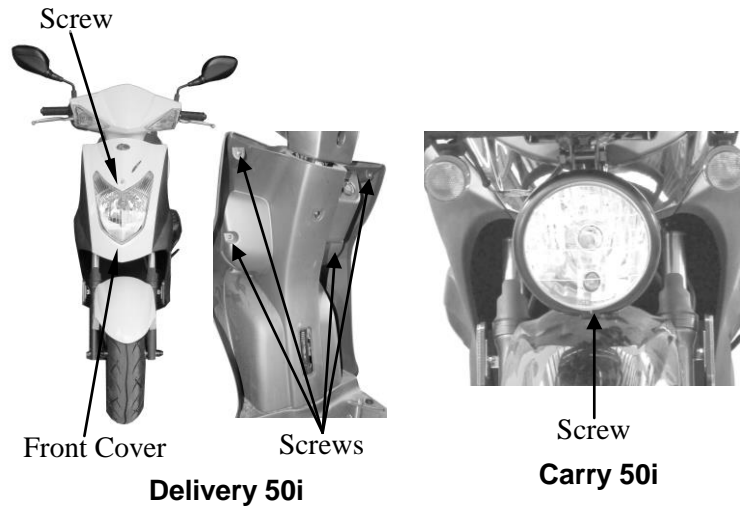

#### BULB REPLACEMENT

Remove the headlight bulb Coupler. (⇒2-2)  
 Remove the headlight replace with new bulbs.  
 The installation sequence is the reverse of removal.

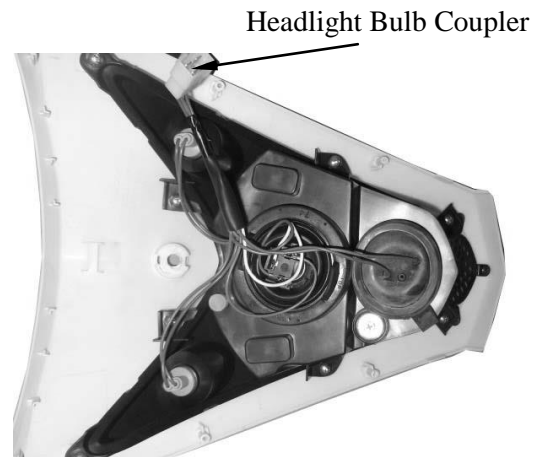

#### TAILLIGHT/STOPLIGHT/REAR TURN SIGNAL LIGHT/LICENSE LIGHT

Remove the rear protector molding and remove the two nuts attaching the rear light shell.  
 The installation sequence is the reverse of removal.

