

3. INSPECTION/ADJUSTMENT

3

INSPECTION/ADJUSTMENT

SERVICE INFORMATION-----	3- 1
MAINTENANCE SCHEDULE-----	3- 2
FUEL LINE/FUEL FILTER-----	3- 3
THROTTLE OPERATION-----	3- 3
ENGINE OIL -----	3- 4
AIR CLEANER -----	3- 5
SPARK PLUG-----	3- 5
VALVE CLEARANCE -----	3- 6
CARBURETOR IDLE SPEED -----	3- 6
IGNITION TIMING-----	3- 7
CYLINDER COMPRESSION -----	3- 7
FINAL REDUCTION GEAR OIL -----	3- 8
DRIVE BELT -----	3- 8
HEADLIGHT AIM -----	3- 9
CLUTCH SHOE WEAR-----	3- 9
COOLING SYSTEM-----	3- 9
BRAKE SYSTEM -----	3-10
NUTS/BOLTS/FASTENERS -----	3-11
WHEELS/TIRES -----	3-11
STEERING HANDLEBAR -----	3-11
SUSPENSION-----	3-11

3. INSPECTION/ADJUSTMENT

SERVICE INFORMATION

GENERAL

 WARNING
--

- Before running the engine, make sure that the working area is well-ventilated. Never run the engine in a closed area. The exhaust contains poisonous carbon monoxide gas which may cause death to people.
- Gasoline is extremely flammable and is explosive under some conditions. The working area must be well-ventilated and do not smoke or allow flames or sparks near the working area or fuel storage area.

SPECIFICATIONS

ENGINE

Throttle grip free play : 2~6mm
 Spark plug : NGK: DPR7EA9
 Spark plug gap : 0.9mm
 Valve clearance : IN: 0.1mm EX: 0.1mm
 Idle speed : 1600rpm

Engine oil capacity:	Cylinder compression : 15±2kg/cm ²
At disassembly : 1.1 liter	Ignition timing : BTDC 10°±3°/1500rpm
At change : 0.9 liter	Coolant capacity : 1165cc
Gear oil capacity :	Radiator capacity : 825cc
At disassembly : 0.20 liter	Reserve tank capacity : 340cc
At change : 0.18 liter	

CHASSIS

Front/rear brake free play: 20~30mm

TIRE

	1 Rider	2 Riders
Front	1.75kg/cm ²	1.75kg/cm ²
Rear	2.00kg/cm ²	2.25kg/cm ²

TIRE SPECIFICATION:

Front : 120/70-12 56J
 Rear : 130/70-12 59J

TORQUE VALUES

Front axle nut : 14.8~68.6N-m
 Rear axle nut : 107.8~127.4N-m

3. INSPECTION/ADJUSTMENT

MAINTENANCE SCHEDULE

Perform the periodic maintenance at each scheduled maintenance period.

I: Inspect, and Clean, Adjust, Lubricate or Replace if necessary.

A: Adjust C: Clean R: Replace T: Tighten

Item	Frequency	Whichever comes first ⇔ ↓	Regular Service Mileage (km)					
			1000	2000	4000	6000	8000	10000
Engine oil			R New motorcycle 300km	R	R	R	R	R
Engine oil filter screen					C		C	
Fuel filter screen								R
Gear oil	Note 3		R New motorcycle 300km		R			R
Valve clearance				A	A		A	
Carburetor					I		I	
Air Cleaner	Note 2,3		I		R			R
Spark plug			Clean at every 3000km and replace if necessary					
Brake system			I	I	I	I	I	I
Drive belt							I	
Suspension					I		I	
Nut, bolt, fastener							I	
Tire					I		I	
Steering head bearing			I			I	I	
Brake fluid			Perform pre-ride inspection daily					
Radiator coolant			Replace every year or at every 10000km (R)					
Radiator core						I		I
Radiator cap						I		I
Brake lever					I			I
Brake shoe wear					I			I
Shock absorber					I			I

- In the interest of safety, we recommend these items be serviced only by an authorized KYMCO motorcycle dealer.

Note: 1. For higher odometer readings, repeat at the frequency interval established here.

2. Service more frequently when riding in dusty or rainy areas.

3. Service more frequently when riding in rain or at full throttle.

3. INSPECTION/ADJUSTMENT

FUEL LINE/FUEL FILTER

Remove the center cover.

Check the fuel lines and replace any parts which show signs of deterioration, damage or leakage.

Check for dirty or clogged fuel filter and replace with a new one if it is clogged.

- * • Do not smoke or allow flames or sparks in your working area.

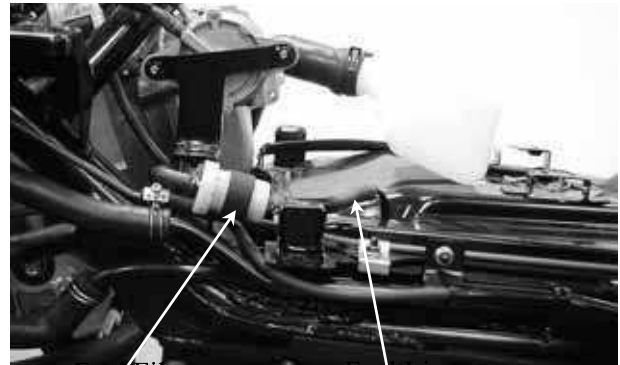

Fuel Filter

Fuel Line

THROTTLE OPERATION

Check the throttle grip for smooth movement. Measure the throttle grip free play.

Free Play: 2~6mm



Major adjustment of the throttle grip free play is made with the adjusting nut at the carburetor side. Adjust by loosening the lock nut and turning the adjusting nut.

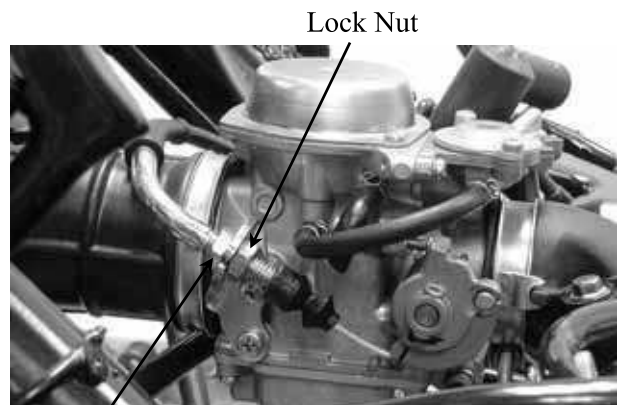

Lock Nut

Adjusting Nut

Minor adjustment is made with the adjusting nut at the throttle grip side.

Slide the rubber cover out and adjust by loosening the lock nut and turning the adjusting nut.



Lock Nut

Adjusting Nut

3. INSPECTION/ADJUSTMENT

ENGINE OIL

OIL LEVEL INSPECTION

Stop the engine and support the motorcycle upright on level ground.
 Wait for 2~3 minutes and check the oil level with the dipstick. Do not screw in the dipstick when making this check.

Oil Dipstick



OIL CHANGE

- * • Drain the oil while the engine is warm.

Remove the oil drain bolt to drain the engine oil.
 Install the aluminum washer and tighten the oil drain bolt.

Torque: 14.7N-m

- * • Replace the aluminum washer with a new one if it is deformed or damaged.

Pour the recommended oil through the oil filler hole.

Oil Capacity:

At disassembly: 1.1 liter

At change: 0.9 liter

Recommended Oil:

SAE: 15W40#

API: SG/CD

Start the engine and check for oil leaks.
 Stop the engine and recheck the oil level.

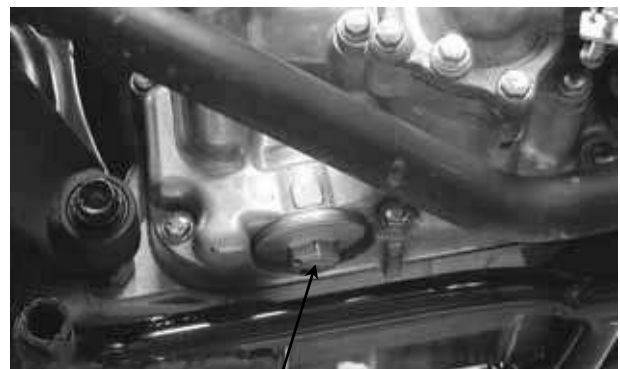

Oil Filter Screen Cap

OIL FILTER SCREEN INSPECTION

Drain the engine oil.
 Remove the oil filter screen and spring.
 Clean the oil filter screen.
 Install the oil filter screen, spring, and filter screen cap.
 Fill the engine with recommended engine oil.

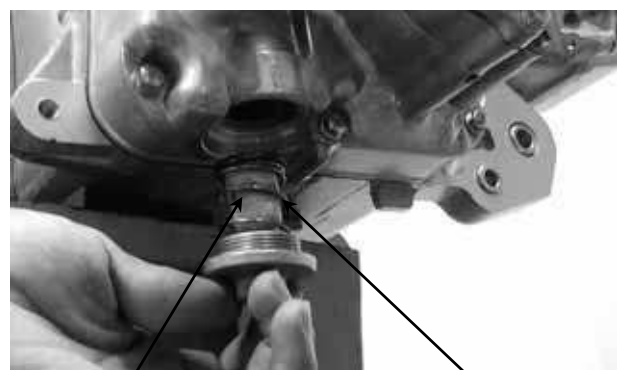

Oil Filter Screen

Spring

3. INSPECTION/ADJUSTMENT

AIR CLEANER

Remove the seven air cleaner case cover screws and the cover.

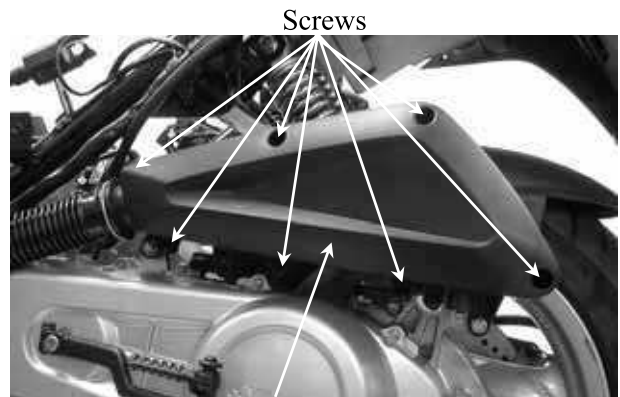

Air Cleaner Case Cover

Remove the air cleaner element. Check the element and replace it if it is excessively dirty or damaged.



Air Cleaner Element

CHANGE INTERVAL

More frequent replacement is required when riding in unusually dusty or rainy areas.

- *
 - The air cleaner element has a viscous type paper element. Do not clean it with compressed air.
 - Be sure to install the air cleaner element and cover securely.

SPARK PLUG

Remove the frame center cover. Remove the spark plug cap and spark plug. Check the spark plug for wear and fouling deposits. Clean any fouling deposits with a spark plug cleaner or a wire brush.



Spark Plug

Specified Spark Plug: NGK: DP7EA9

Measure the spark plug gap.

Spark Plug Gap: 0.9mm

- *
 - When installing, first screw in the spark plug by hand and then tighten it with a spark plug wrench.

Torque: 7.8~9.8N-m

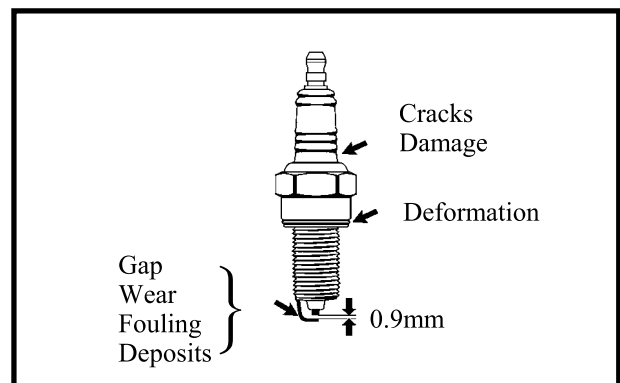

3. INSPECTION/ADJUSTMENT

VALVE CLEARANCE

- * Inspect and adjust valve clearance while the engine is cold (below 35°C).

Remove the cylinder head cover.

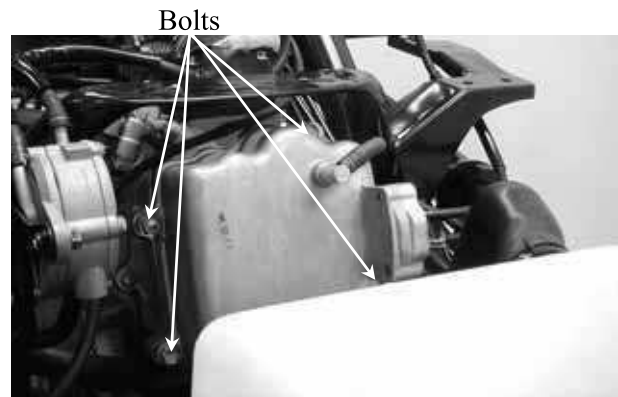

Cylinder Head Cover

Turn the A.C. generator flywheel to the top dead center (TDC) on the compression stroke so that the "T" mark on the flywheel aligns with the index mark on the left crankcase cover.

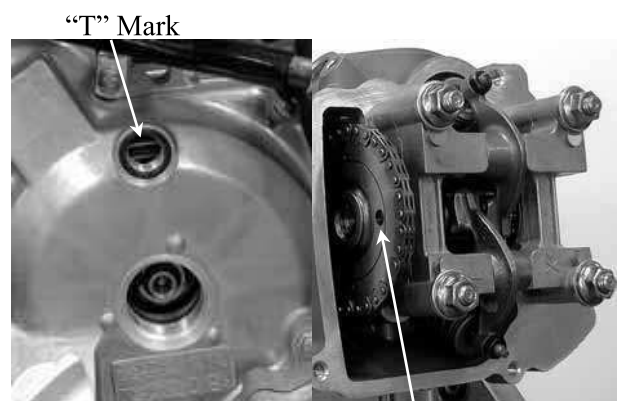

Top Dead Center

Inspect and adjust valve clearance.

Valve Clearance: IN: 0.1mm
EX: 0.1mm

Loosen the lock nut and adjust by turning the adjusting nut

Special

Valve Wrench

- * Check the valve clearance again after the lock nut is tightened.



Feeler Gauge

Valve Wrench

CARBURETOR IDLE SPEED

- * The engine must be warm for accurate idle speed inspection and adjustment.

Lift up the seat and remove the inspection cover.

Warm up the engine before this operation. Start the engine and connect a tachometer. Turn the throttle stop screw to obtain the specified idle speed.

Idle Speed: 1600rpm

When the engine misses or run erratic, adjust the pilot screw.



Throttle Stop Screw

Pilot Screw

3. INSPECTION/ADJUSTMENT

IGNITION TIMING

- *
 - The CDI unit is not adjustable.
 - If the ignition timing is incorrect, check the ignition system,

Remove the timing hole cap.



Check the ignition timing with a timing light. When the engine is running at the specified idle speed, the ignition timing is correct if the "F" mark on the flywheel aligns with the index mark on the crankcase cover. Also use a timing light to check the advance. Raise the engine speed to 4,000rpm. The index mark should be between the advance marks.

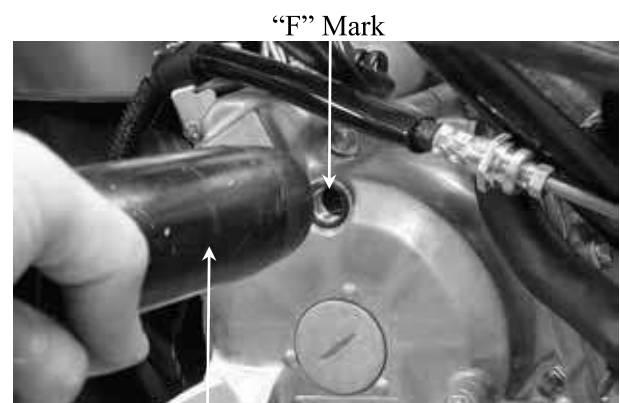

Timing Light

CYLINDER COMPRESSION

Warm up the engine before compression test. Remove the center cover and spark plug cap. Remove the spark plug . Insert a compression gauge. Open the throttle valve fully and push the starter button to test the compression.

Compression: $15 \pm 2 \text{kg/cm}^2$

If the compression is low, check for the following:

- Leaky valves
- Valve clearance too small
- Leaking cylinder head gasket
- Worn pistons
- Worn piston/cylinder

If the compression is high, it indicates that carbon deposits have accumulated on the combustion chamber and the piston head.



Compression Gauge

3. INSPECTION/ADJUSTMENT

FINAL REDUCTION GEAR OIL

- * • Place the motorcycle on its main stand on level ground.

Stop the engine and remove the oil check bolt.

The oil level shall be at the oil check bolt hole.

If the oil level is low, add the recommended oil SAE90# to the proper level.

Install the oil check bolt.

- * • Make sure that the sealing washer is in good condition.

OIL CHANGE

Remove the oil check bolt.

Remove the oil drain bolt and drain the oil thoroughly.

Install the oil drain bolt.

Torque: 9.8N-m

- * • Make sure that the sealing washer is in good condition.

Fill the final reduction with the recommended oil SAE90#.

Gear Oil Capacity:

At disassembly : 200cc

At change : 180cc

Reinstall the oil check bolt and check for oil leaks.

DRIVE BELT

Remove the left crankcase cover.

Inspect the drive belt for cracks or excessive wear.

Replace the drive belt with a new one if necessary and in accordance with the Maintenance Schedule.

Oil Check Bolt Hole/Oil Filler

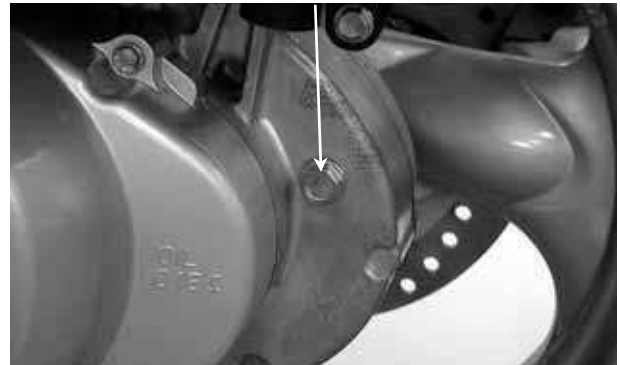

Oil Drain Bolt/Sealing Washer

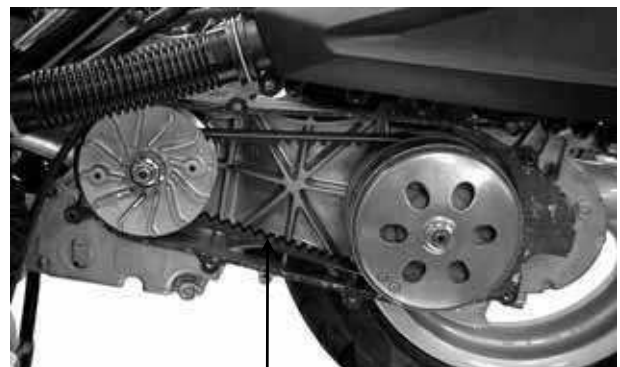

Drive Belt

3. INSPECTION/ADJUSTMENT

HEADLIGHT AIM

Turn the ignition switch ON.
Turn on the headlight switch.
Adjust the headlight aim by turning the headlight aim adjusting bolt.



Headlight Aim Adjusting Bolt

CLUTCH SHOE WEAR

Start the engine and check the clutch operation by increasing the engine speed gradually.
If the motorcycle tends to creep, or the engine stalls, check the clutch shoes for wear and replace if necessary.



COOLING SYSTEM

COOLANT LEVEL INSPECTION

Place the motorcycle on its main stand on level ground.
Check the coolant level of the reserve tank and the level should be between the upper and lower level lines.

If necessary, fill the reserve tank with recommended coolant to the "F" level line.
Recommended Coolant: SIGMA Coolant
(Standard Concentration 30%)

- * The coolant level does not change no matter the engine is warm or cold. Fill to the "F" (upper) line.

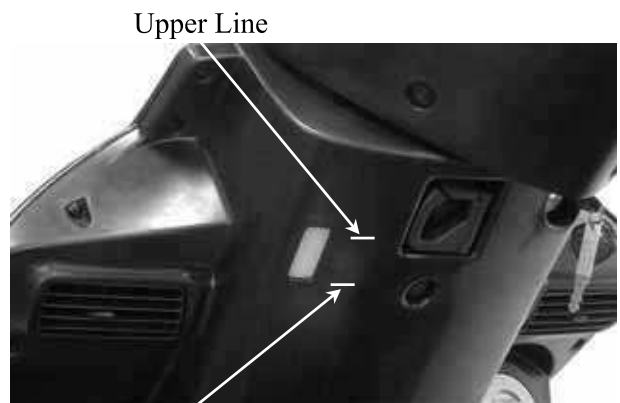

Lower Line

COOLANT REPLACEMENT

- * Perform this operation when the engine is cold.

Remove the front cover.
Remove the radiator cap.
Remove the drain bolt to drain the coolant and tilt the motorcycle to the right and the coolant will drain more easily.
Drain the coolant in the reserve tank.
Reinstall the drain bolt.
Fill the radiator with the specified coolant.

- * The coolant freezing point should be 5 °C lower than the temperature of the riding area.



Reserve Tank

3. INSPECTION/ADJUSTMENT

Coolant capacity : 1165cc

Radiator capacity : 825cc

Reserve tank capacity :340cc

Start the engine and check if there is no bubbles in the coolant and the coolant level is stable. Reinstall the radiator cap.

If there are bubbles in the coolant, bleed air from the system.

Fill the reserve tank with the recommended coolant up to the upper line.

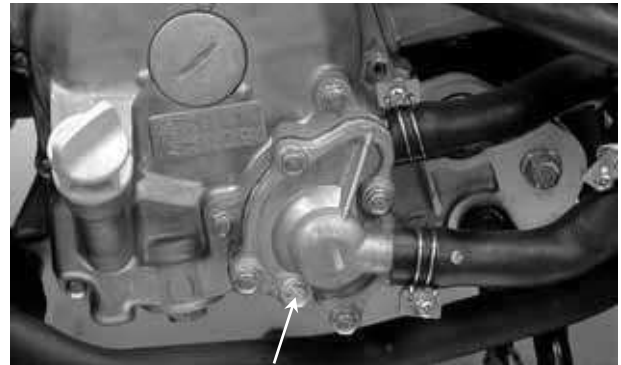

Drain Bolt

BRAKE SYSTEM

BRAKE LEVER

Measure the front and rear brake lever free plays.



BRAKE FLUID

Turn the steering handlebar upright and check if the front/rear brake fluid level is at the upper limit. If the brake fluid is insufficient, fill to the upper limit.

Specified Brake Fluid: DOT-3

- * • The brake fluid level will decrease if the brake pads are worn.

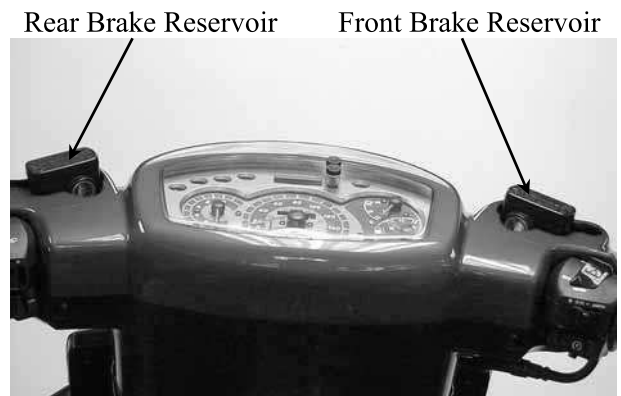

Rear Brake Reservoir

Front Brake Reservoir

BRAKE DISK/BRAKE PAD

Check the brake disk surface for scratches, unevenness or abnormal wear.

Check if the brake disk runout is within the specified service limit.

Check if the brake pad wear exceeds the wear indicator line.

- * • Keep grease or oil off the brake disk to avoid brake failure.



Brake Disk

Wear Indicator Line

3. INSPECTION/ADJUSTMENT

NUTS/BOLTS/FASTENERS

Check all important chassis nuts and bolts for looseness.

Tighten them to their specified torque values if any looseness is found.

WHEELS/TIRES

Check the tires for cuts, imbedded nails or other damages.

Check the tire pressure.

- * • Tire pressure should be checked when tires are cold.

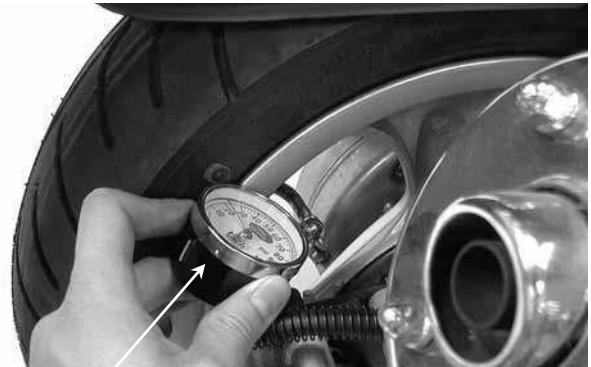

Pressure Gauge

Tire Pressure

	1 Rider	2 Riders
Front	1.75kg/cm ²	1.75kg/cm ²
Rear	2.00kg/cm ²	2.25kg/cm ²

STEERING HANDLEBAR

Raise the front wheel off the ground and check that the steering handlebar rotates freely.

If the handlebar moves unevenly, binds, or has vertical movement, adjust the steering head bearing.



SUSPENSION

Check the action of the front/rear shock absorbers by compressing them several times. Check the entire shock absorber assembly for oil leaks, looseness or damage.

Jack the rear wheel off the ground and move the rear wheel sideways with force to see if the engine hanger bushings are worn.

Replace the engine hanger bushings if there is any looseness.



4. LUBRICATION SYSTEM

LUBRICATION SYSTEM

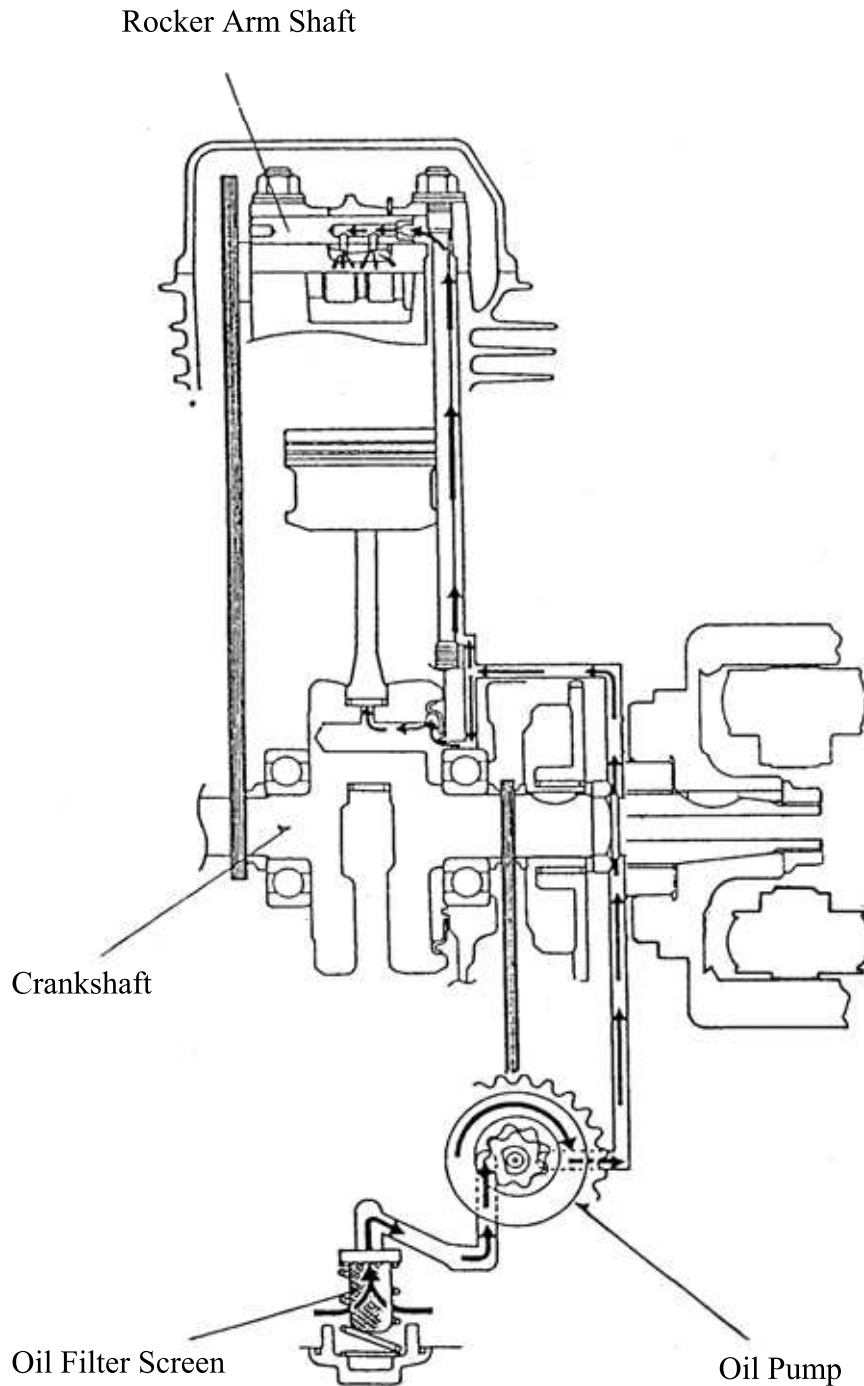

4. LUBRICATION SYSTEM

SERVICE INFORMATION

GENERAL INSTRUCTIONS

- The maintenance of lubrication system can be performed with the engine installed in the frame.
- Drain the coolant before starting any operations.
- Use care when removing and installing the oil pump not to allow dust and foreign matters to enter the engine and oil line.
- Do not attempt to disassemble the oil pump. The oil pump must be replaced as a set when it reaches its service limit.
- After the oil pump is installed, check each part for oil leaks.

SPECIFICATIONS

OIL PUMP

	Standard (mm)	Service Limit (mm)
Inner rotor-to-outer rotor clearance	0.15	0.20
Outer rotor-to-pump body clearance	0.15~0.20	0.25
Rotor end-to-pump body clearance	0.04~0.09	0.12

ENGINE OIL

Engine Oil Capacity	At disassembly: 1.1 liter At change: 0.9 liter
Recommended Oil	SAE15W40# API: SG/CD

TROUBLESHOOTING

Oil level too low

- Natural oil consumption
- Oil leaks
- Worn piston rings
- Worn valve guide
- Worn valve guide seal

Poor lubrication pressure

- Oil level too low
- Clogged oil filter or oil passage
- Faulty oil pump

Oil contamination

- Oil not changed often enough
- Faulty cylinder head gasket
- Loose cylinder head bolts

4. LUBRICATION SYSTEM

ENGINE OIL/OIL FILTER

- * • Place the motorcycle upright on level ground for engine oil level check.
- Run the engine for 2~3 minutes and check the oil level after the engine is stopped for 2~3 minutes.

Remove the oil dipstick and check the oil level with the oil dipstick.
If the level is near the lower level, fill to the upper level with the recommended engine oil.

OIL CHANGE

- * • The engine oil will drain more easily while the engine is warm.

Remove the oil drain bolt located at the left side of the engine to drain the engine oil.
After the oil has been completely drained, install the aluminum washer and tighten the oil drain bolt.

Torque: 14.7N-m

Pour the recommended oil through the oil filler hole.

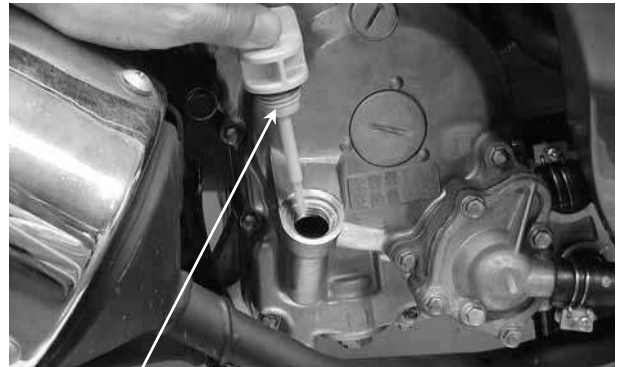

Oil Dipstick



Oil Drain Bolt

OIL FILTER SCREEN

Drain the engine oil.

Remove the oil filter screen cap.

Remove the oil filter screen and spring.

Check the oil filter screen for clogging or damage and replace if necessary. Check the filter screen O-ring for damage and replace if necessary.

Install the oil filter screen, spring, O-ring and filter screen cap.

Torque: 14.7N-m

Recommended Oil: SAE15W40# API: SG/CD

Oil Capacity:

At disassembly: 1.1 liter

At change: 0.9 liter

Start the engine and check for oil leaks.

Start the engine and let it idle for few minutes, then recheck the oil level.



Oil Filter Screen Cap

4. LUBRICATION SYSTEM

OIL PUMP REMOVAL

First drain the coolant.
Remove the right crankcase cover. (⇒10-3)
Remove the A.C. generator starter driven gear. (⇒10-4)
Remove the attaching bolt and oil separator cover.

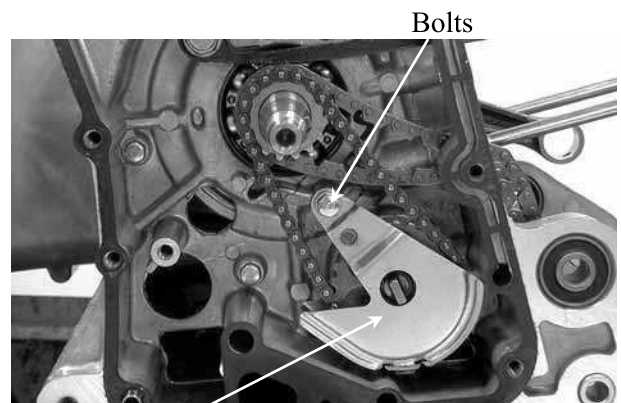

Pry the circlip off and remove the oil pump driven gear, then remove the oil pump drive chain.

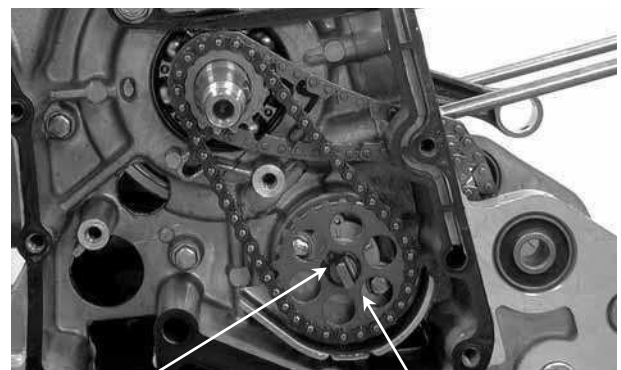

Remove the two oil separator bolts to remove the oil pump.

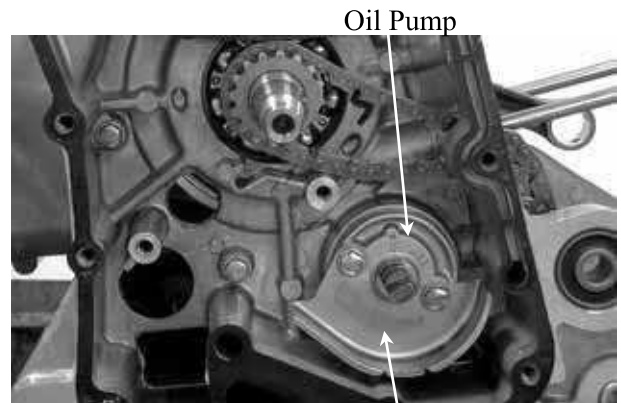

OIL PUMP DISASSEMBLY

Remove the screw and disassemble the oil pump as shown.



4. LUBRICATION SYSTEM

OIL PUMP INSPECTION

Measure the pump body-to-outer rotor clearance.

Service Limit: 0.25mm replace if over

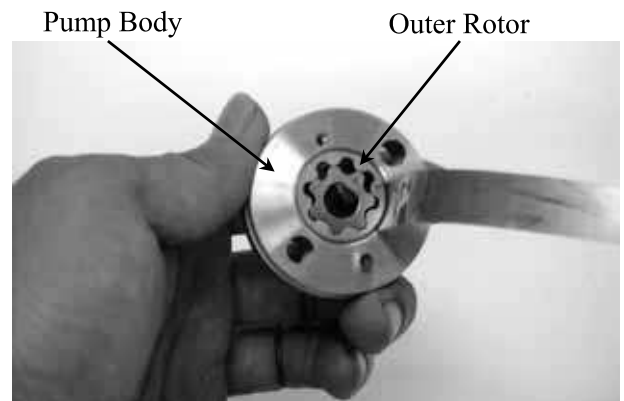

Measure the inner rotor-to-outer rotor clearance.

Service Limit: 0.20mm replace if over

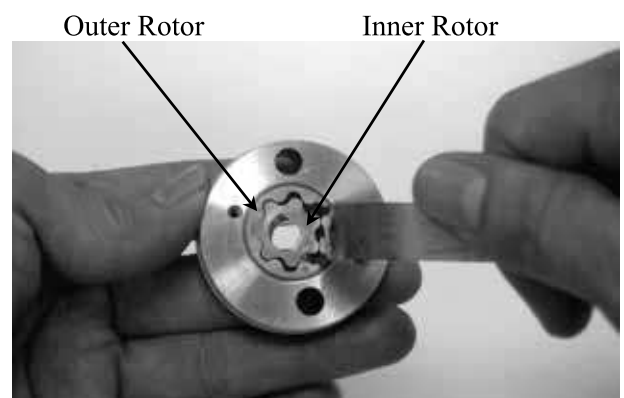

Measure the rotor end-to-pump body clearance.

Service Limit: 0.12mm replace if over

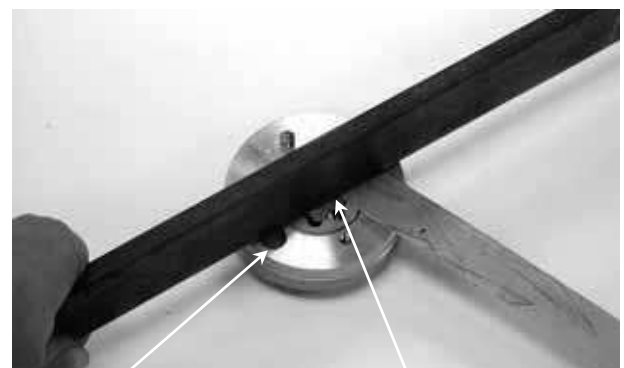

OIL PUMP ASSEMBLY

Install the outer rotor, inner rotor and pump shaft into the pump body.

* Insert the pump shaft by aligning the flat on the shaft with the flat in the inner rotor. Install the dowel pin.

There is one mark on the surface of the inner rotor and outer rotor.

The mark is upside.

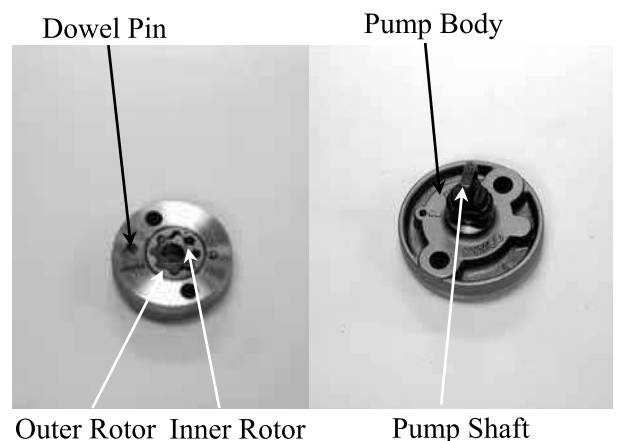

4. LUBRICATION SYSTEM

Install the pump cover by aligning the hole in the cover with the dowel pin.
Tighten the screw to secure the pump cover.
Make sure that the pump shaft rotates freely without binding.

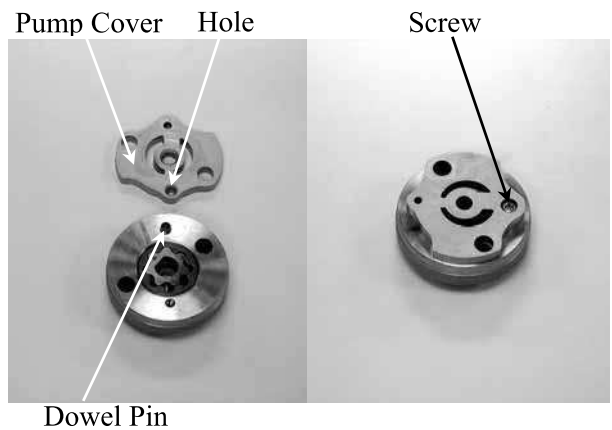

OIL PUMP INSTALLATION

Install the oil pump and oil separator and tighten the two bolts.
Make sure that the pump shaft rotates freely.
The arrow of oil pump is upside.

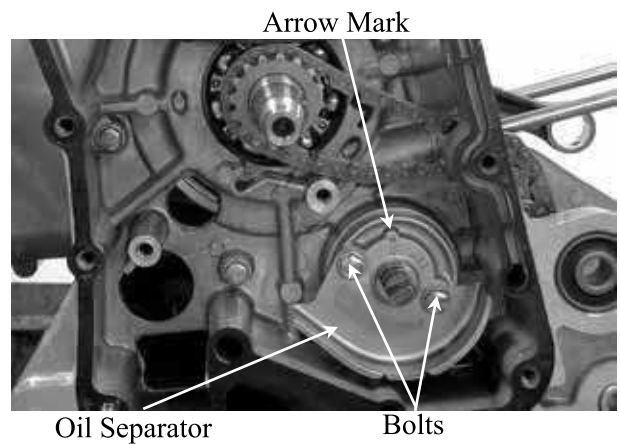

Install the pump drive chain and driven gear, then set the circlip securely on the pump shaft.

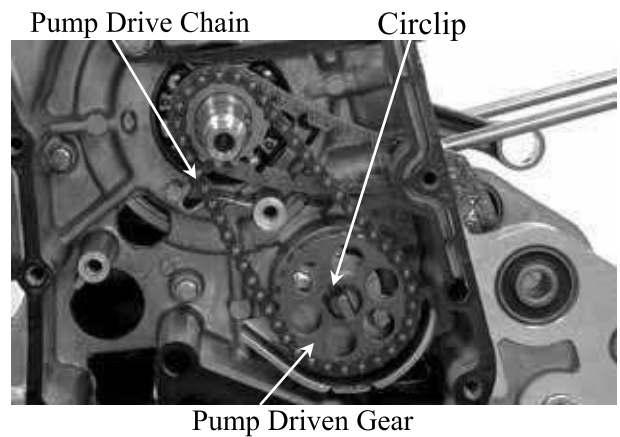

Install the oil separator cover properly.

* Fit the tab of the separator cover into the slit in the separator.

Install the A.C. generator starter driven gear. (⇒10-5)

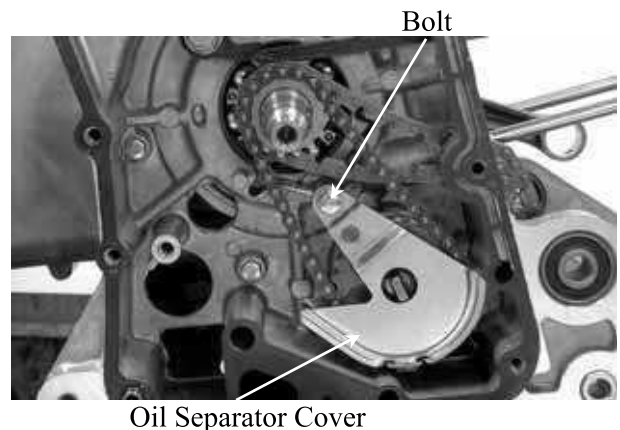

5. ENGINE REMOVAL/INSTALLATION



ENGINE REMOVAL/INSTALLATION

SCHEMATIC DRAWING	5-1
SERVICE INFORMATION.....	5-2
ENGINE REMOVAL	5-3
ENGINE INSTALLATION	5-5

5. ENGINE REMOVAL/INSTALLATION

SCHEMATIC DRAWING

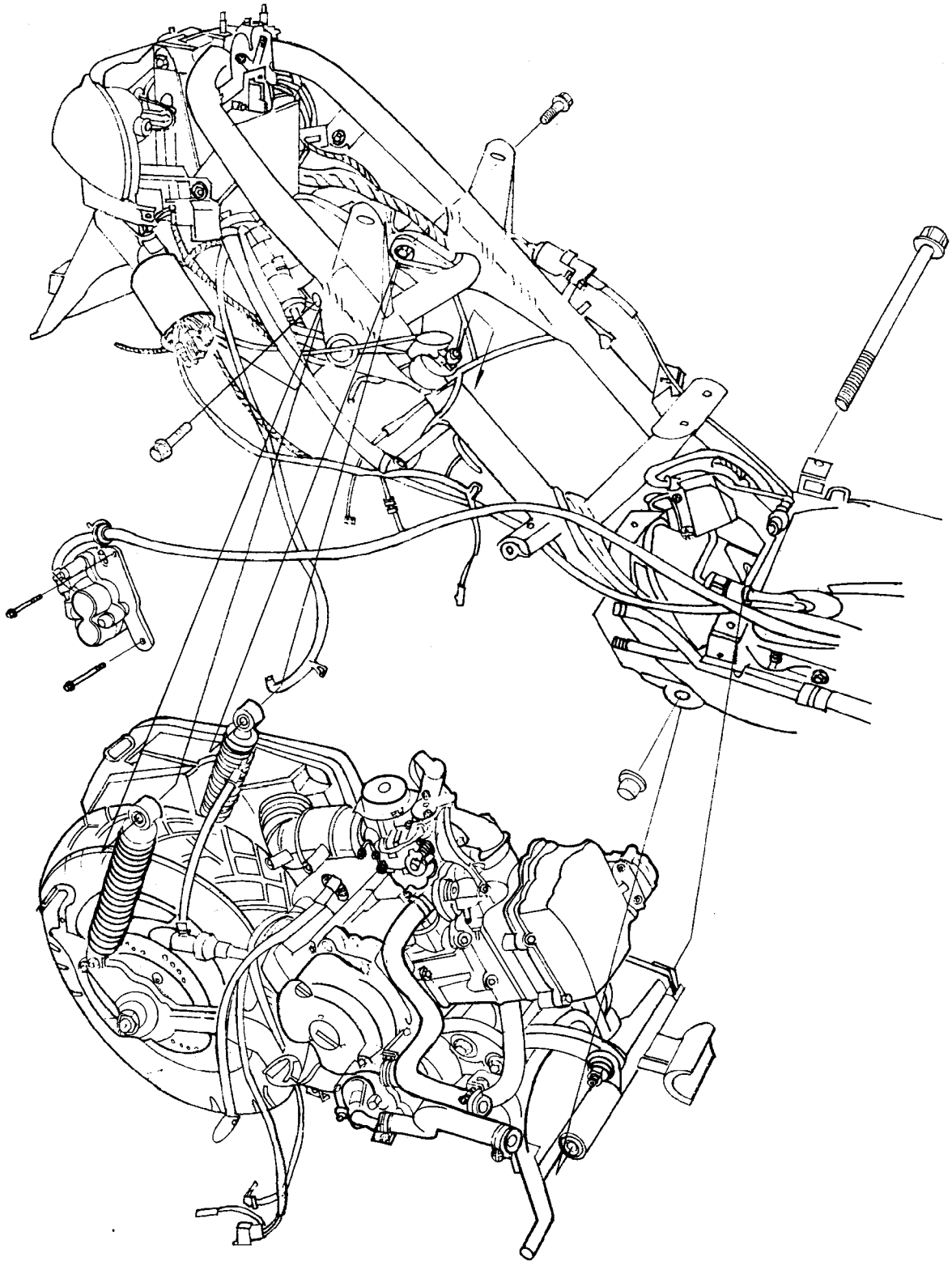

5. ENGINE REMOVAL/INSTALLATION

SERVICE INFORMATION

GENERAL INSTRUCTIONS

- A floor jack or other adjustable support is required to support and maneuver the engine. Be careful not to damage the motorcycle body, cables and wires during engine removal.
- Use shop towels to protect the motorcycle body during engine removal.
- Drain the coolant before removing the engine.
- After the engine is installed, fill the cooling system with coolant and be sure to bleed air from the water jacket. Start the engine to check for coolant leaks.
- Before removing the engine, the rear brake caliper must be removed first. Be careful not to bend or twist the brake fluid tube.

SPECIFICATIONS

Engine dry weight: 30kg

Engine oil capacity: at disassembly: 1.1 liter

Coolant capacity:

Total capacity : 1165cc

Radiator capacity : 825cc

Reserve tank capacity : 340cc

TORQUE VALUES

Engine mounting bolt 49N-m

Rear shock absorber upper mount bolt 39.2N-m

5. ENGINE REMOVAL/INSTALLATION

ENGINE REMOVAL

Disconnect the battery negative cable.
 Remove the frame body cover. (⇒2-3)
 Disconnect the engine negative cable.
 Disconnect all of the A.C. generator, auto
 bystarter, spark plug, thermosensor wire
 couplers and connectors.
 Disconnect the engine fuel tube.
 Drain the coolant. (⇒3-9)
 Disconnect the water hose.

Disconnect the starter motor wire that goes
 to the starter relay.

Disconnect the fuel tube and vacuum tube
 that go to the carburetor from the fuel pump.
 Disconnect the vacuum tube from the air
 cut-off valve (ACV).
 Disconnect the throttle cable from the
 carburetor.

Remove the brake fluid tube bolt of the rear
 brake caliper.
 Remove the rear brake caliper bolt and the
 rear brake caliper.

Wire Connectors



Rear Brake Caliper

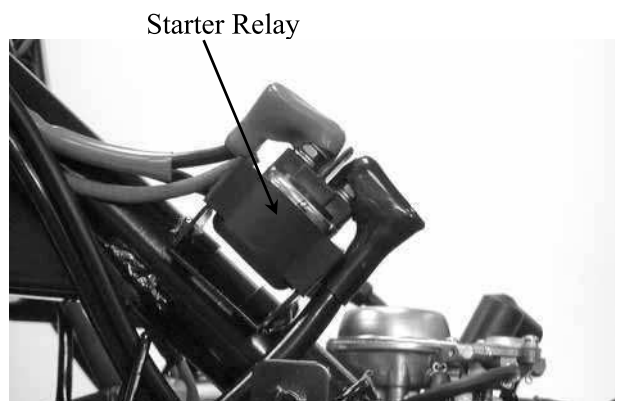

Starter Relay

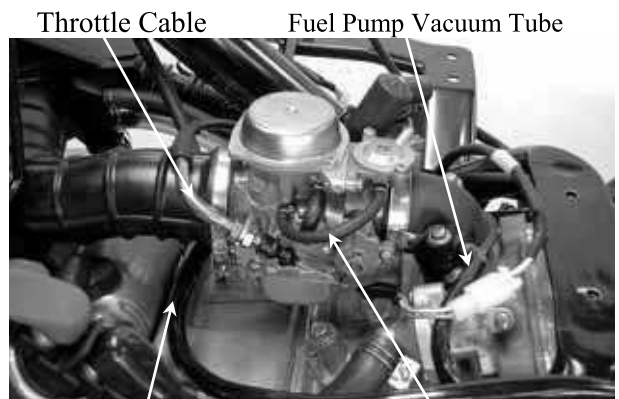

Throttle Cable

Fuel Pump Vacuum Tube

Fuel Tube

ACV Vacuum Tube

Brake Fluid Tube



Rear Brake Caliper

5. ENGINE REMOVAL/INSTALLATION

Remove the right/left rear shock absorber upper mount bolts.

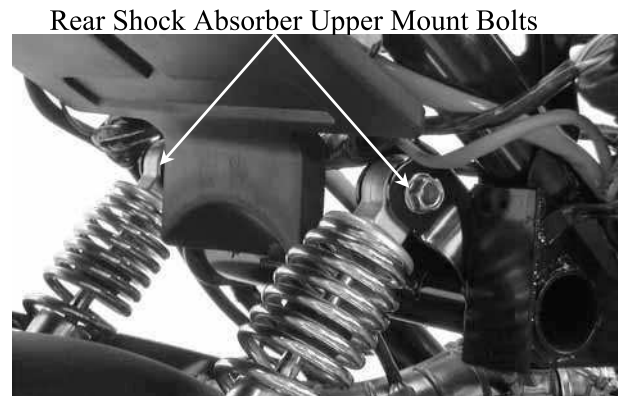

Remove the two engine mounting bolts and pull out the engine with the engine hanger backward.

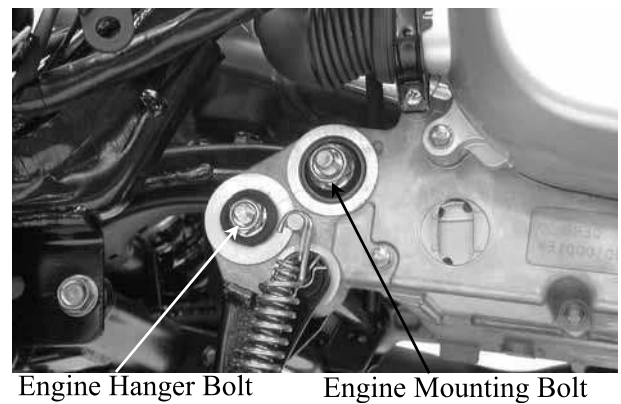

ENGINE HANGER REMOVAL

Remove the engine hanger bolts to remove the engine hanger.

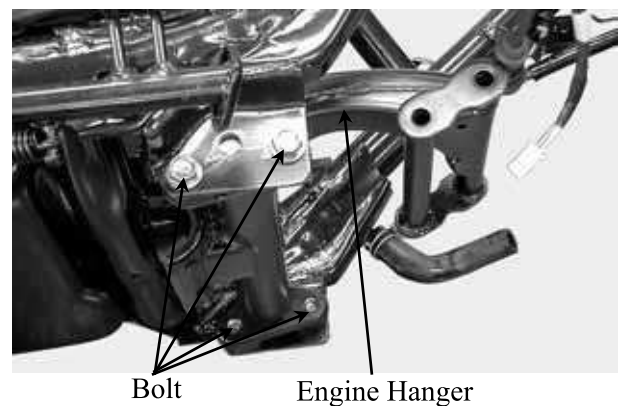

Inspect the engine hanger bushings and stopper rubber for wear or damage.

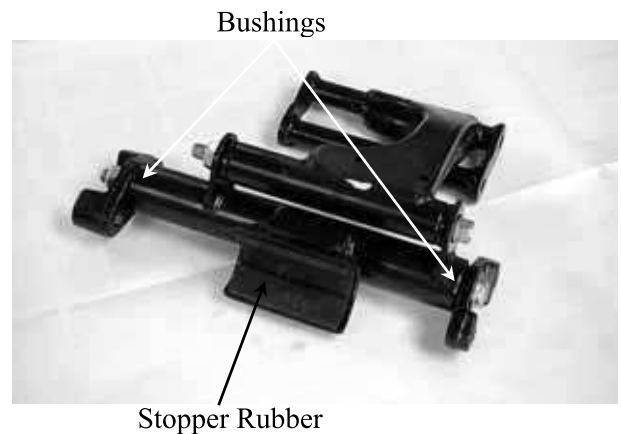

5. ENGINE REMOVAL/INSTALLATION

ENGINE INSTALLATION

Install the engine in the reverse order of removal.

Tighten the engine mounting bolts.

Torque: 49N-m

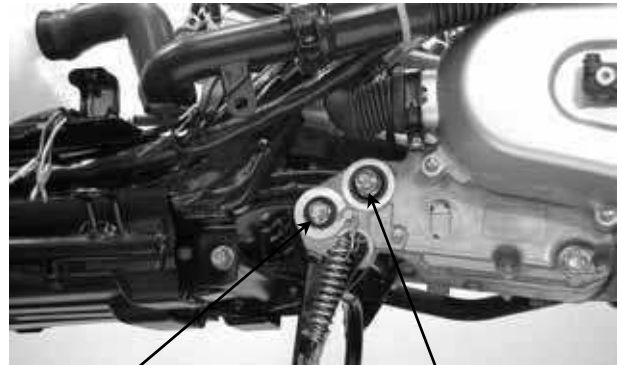

Engine Hanger Bolt Engine Mounting Bolt

Tighten the rear shock absorber upper mount bolts.

Torque: 39.2N-m

After installation, inspect and adjust the following:

- Throttle grip free play (\Rightarrow 3-3)
- Fill the rear brake reservoir with brake fluid and bleed air from the rear brake.
- Fill the cooling system with coolant and start the engine to bleed air from the system.



Rear Shock Absorber Upper Mount Bolts

6. CYLINDER HEAD/VALVES

SCHEMATIC DRAWING

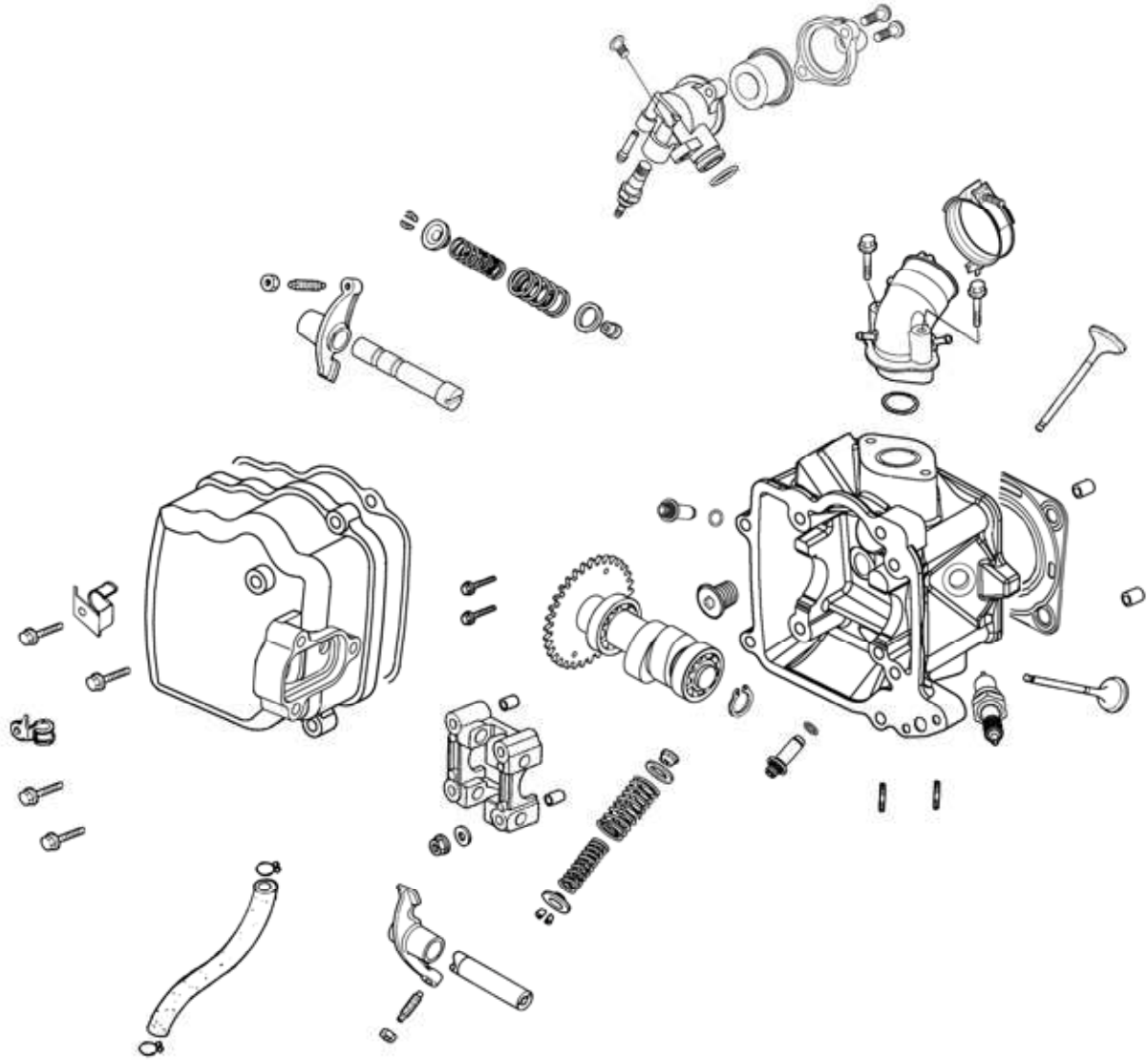

6. CYLINDER HEAD/VALVES

SERVICE INFORMATION

GENERAL INSTRUCTIONS

- The cylinder head can be serviced with the engine installed in the frame. Coolant in the radiator and water jacket must be drained first.
- When assembling, apply molybdenum disulfide grease or engine oil to the valve guide movable parts and valve arm sliding surfaces for initial lubrication.
- The valve rocker arms are lubricated by engine oil through the cylinder head engine oil passages. Clean and unclog the oil passages before assembling the cylinder head.
- After disassembly, clean the removed parts and dry them with compressed air before inspection.
- After removal, mark and arrange the removed parts in order. When assembling, install them in the reverse order of removal.

SPECIFICATIONS		Standard (mm)		Service Limit (mm)	
		SH30CA	SH25CA	SH30CA	SH25CA
Valve clearance (cold)	IN	0.10	0.10	—	—
	EX	0.10	0.10	—	—
Cylinder head compression pressure		15kg/cm ²	15kg/cm ²	—	—
Cylinder head warpage		—	—	0.05	0.05
Camshaft cam height	IN	30.8763	30.8763	30.75	30.75
	EX	30.4081	30.4081	30.26	30.26
Valve rocker arm I.D.	IN	10.00~10.018	10.00~10.018	10.10	10.10
	EX	10.00~10.018	10.00~10.018	10.10	10.10
Valve rocker arm shaft O.D.	IN	9.972~9.987	9.972~9.987	9.9	9.9
	EX	9.972~9.987	9.972~9.987	9.9	9.9
Valve seat width	IN	1.2	1.2	1.8	1.8
	EX	1.2	1.2	1.8	1.8
Valve stem O.D.	IN	4.990~4.975	4.990~4.975	4.925	4.925
	EX	4.970~4.955	4.970~4.955	4.915	4.915
Valve guide I.D.	IN	5.00~5.012	5.00~5.012	5.03	5.03
	EX	5.00~5.012	5.00~5.012	5.03	5.03
Valve stem-to-guide clearance	IN	0.010~0.037	0.010~0.037	0.08	0.08
	EX	0.030~0.057	0.030~0.057	0.10	0.10

TORQUE VALUES

Cylinder head cap nut	19.6N-m	Apply engine oil to threads
Valve clearance adjusting nut	8.8N-m	Apply engine oil to threads
Cylinder head cover bolt	7.8~11.8N-m	

SPECIAL TOOLS

Valve spring compressor	
Valve seat cutter, 24.5mm	45° IN-EX
Valve seat cutter, 25mm	Plane cutter 37.5° EX
Valve seat cutter, 22mm	Plane cutter 37.5° EX
Valve seat cutter, 26mm	Plane cutter 63.5° IN/EX
Cutter clip	
Valve guide driver	
Valve guide reamer	

6. CYLINDER HEAD/VALVES

TROUBLESHOOTING

- The poor cylinder head operation can be diagnosed by a compression test or by tracing engine top-end noises.

Poor performance at idle speed

- Compression too low

Compression too low

- Incorrect valve clearance adjustment
- Burned or bent valves
- Incorrect valve timing
- Broken valve spring
- Poor valve and seat contact
- Leaking cylinder head gasket
- Warped or cracked cylinder head
- Poorly installed spark plug

Compression too high

- Excessive carbon build-up in combustion chamber

White smoke from exhaust muffler

- Worn valve stem or valve guide
- Damaged valve stem oil seal

Abnormal noise

- Incorrect valve clearance adjustment
- Sticking valve or broken valve spring
- Damaged or worn camshaft
- Worn cam chain tensioner
- Worn camshaft and rocker arm

6. CYLINDER HEAD/VALVES

CYLINDER HEAD COVER REMOVAL

Remove the center cover. (⇒2-3)
 Remove the met-in box. (⇒2-3)
 Remove the cylinder head cover four bolts and then remove the cylinder head cover.

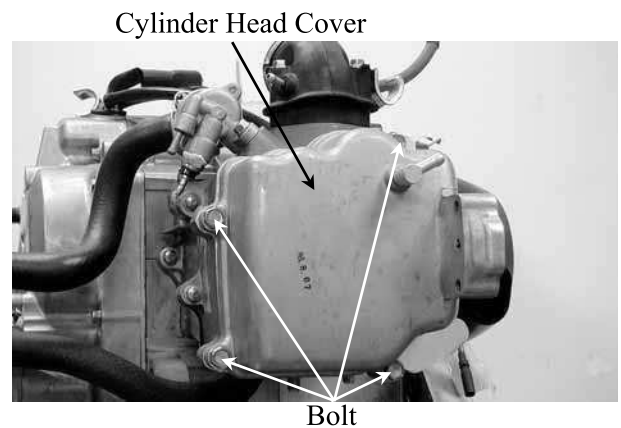

CAMSHAFT REMOVAL

Turn the A.C. generator flywheel so that the "T" mark on the flywheel aligns with the index mark on the crankcase.
 Hold the round hole on the camshaft gear facing up and the location is the top dead center on the compression stroke.
 Remove the two bolts attaching cam chain tensioner and the tensioner.

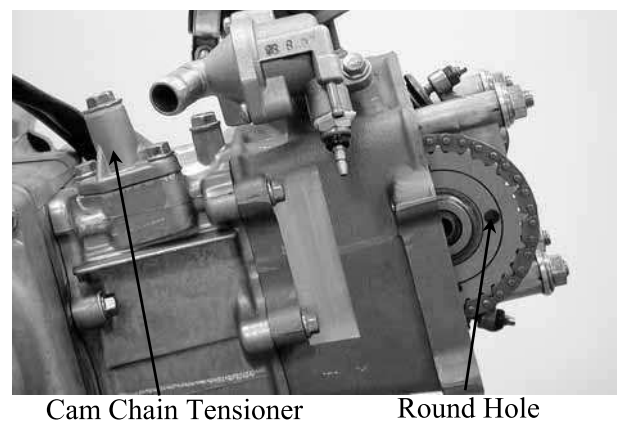

First remove the two bolts between the cylinder head and cylinder.
 Then, remove the four cap nuts attaching the cylinder head.

* •Diagonally loosen the cylinder head cap nuts in 2 or 3 times.

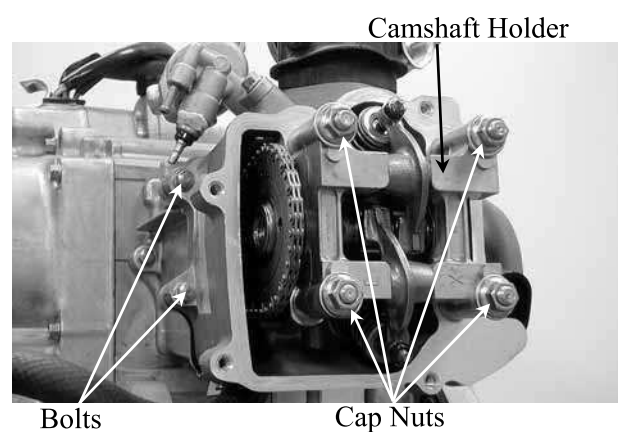

Remove the camshaft holder and dowel pins.

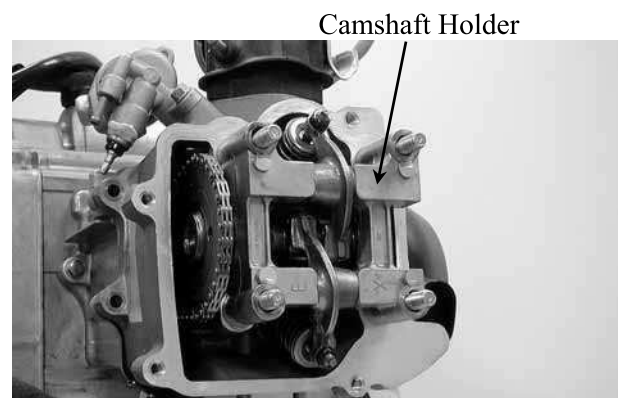

6. CYLINDER HEAD/VALVES

Remove the camshaft gear from the cam chain to remove the camshaft.

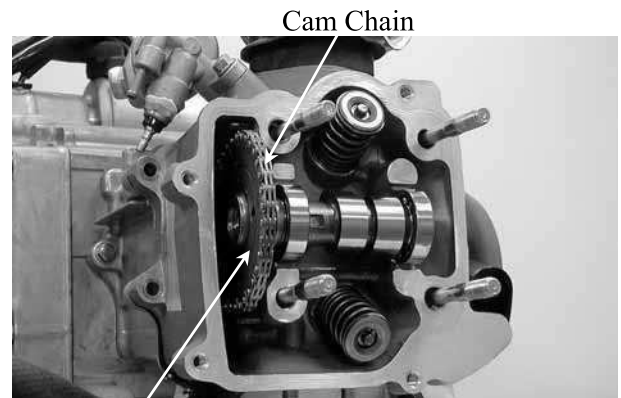

Camshaft Gear

CAMSHAFT INSPECTION

Check each cam lobe for wear or damage. Measure the cam lobe height.

Service Limits:

SH30CA	IN: 30.75mm replace if below
SH25CA	EX:30.26mm replace if below



Check each camshaft bearing for play or damage. Replace the camshaft assembly with a new one if the bearings are noisy or have excessive play.

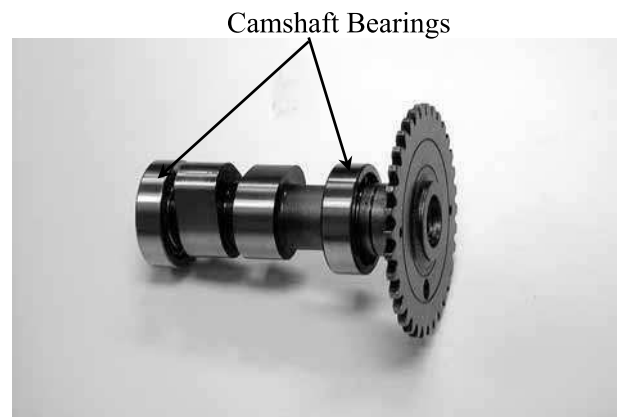

Camshaft Bearings

CAMSHAFT HOLDER DISASSEMBLY

Take out the valve rocker arm shafts using a 6mm bolt.
Remove the valve rocker arms.

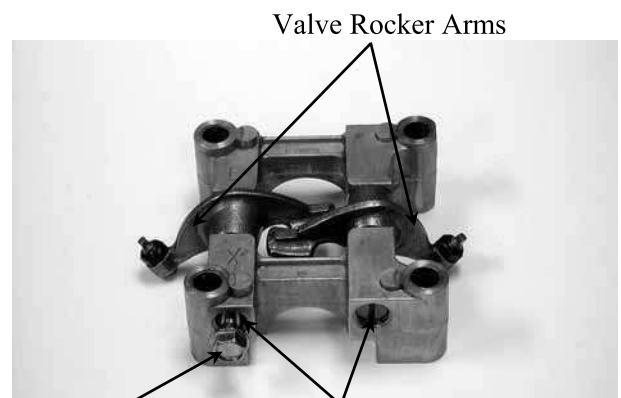

6mm Bolt

Rocker Arm Shafts

6. CYLINDER HEAD/VALVES

CAMSHAFT HOLDER INSPECTION

Inspect the camshaft holder, valve rocker arms and rocker arm shafts for wear or damage.

* If the valve rocker arm contact surface is worn, check each cam lobe for wear or damage.

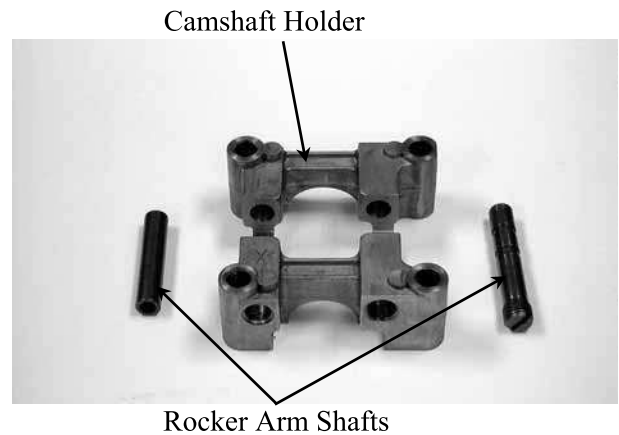

Measure the I.D. of each valve rocker arm.

Service Limits: IN: 10.10mm replace if over
EX: 10.10mm replace if over

Measure each rocker arm shaft O.D.

Service Limits: IN: 9.90mm replace if below
EX: 9.90mm replace if below



CYLINDER HEAD REMOVAL

First drain the coolant from the radiator and water jacket, then remove the thermostat water hose.

Remove the camshaft. (⇒6-4)

Remove the carburetor and intake manifold.

Remove the bolt attaching the thermostat housing and the thermostat housing.

Remove the cylinder head.

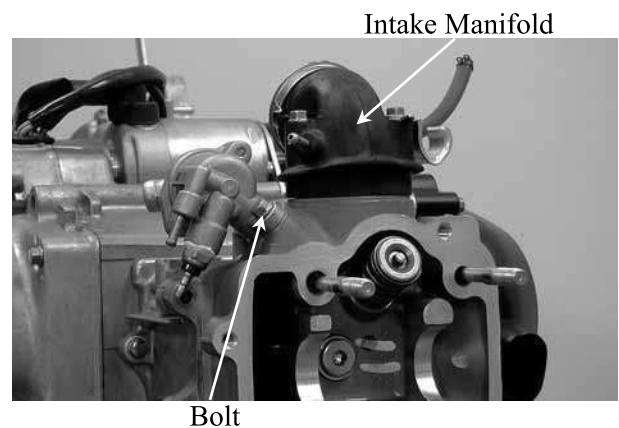

Remove the dowel pins and cylinder head gasket.

Remove the cam chain guide.

Remove all gasket material from the cylinder head mating surface.

* Be careful not to drop any gasket material into the engine.

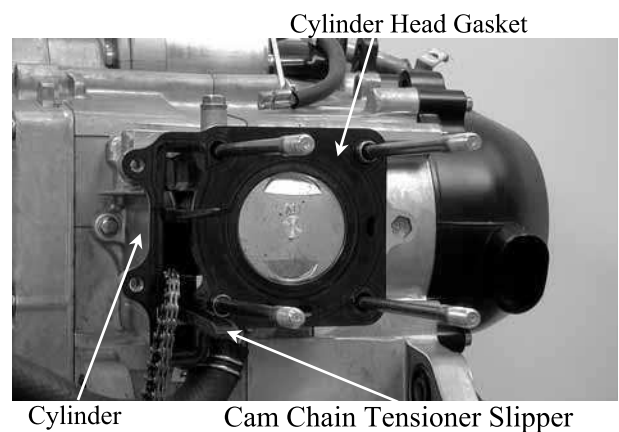

6. CYLINDER HEAD/VALVES

CYLINDER HEAD DISASSEMBLY

Remove the valve spring cotters, retainers, springs, spring seats and valve stem seals using a valve spring compressor.

- * Be sure to compress the valve springs with a valve spring compressor.
- * Mark all disassembled parts to ensure correct reassembly.

Remove carbon deposits from the exhaust port and combustion chamber.

- * Be careful not to damage the cylinder head mating surface.

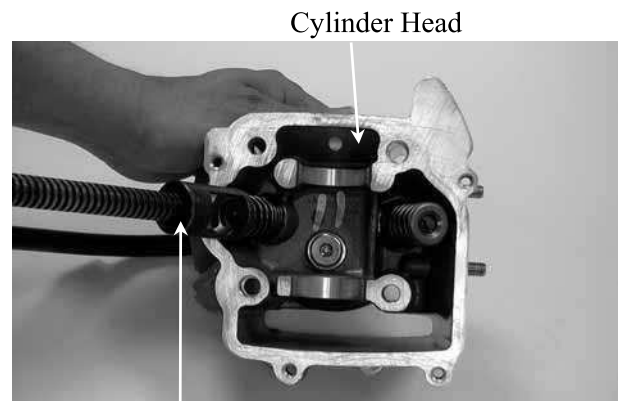

Valve Spring Compressor



Exhaust Port

6. CYLINDER HEAD/VALVES

INSPECTION

CYLINDER HEAD

Check the spark plug hole and valve areas for cracks.

Check the cylinder head for warpage with a straight edge and feeler gauge.

Service Limit: 0.05mm repair or replace if over

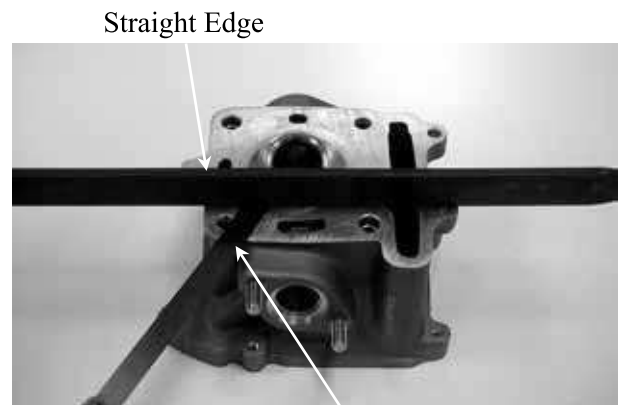

Feeler Gauge

VALVE SPRING FREE LENGTH

Measure the free length of the inner and outer valve springs.

Service Limits:

Inner (IN, EX) : 29.3mm replace if below

Outer (IN, EX): 32.0mm replace if below

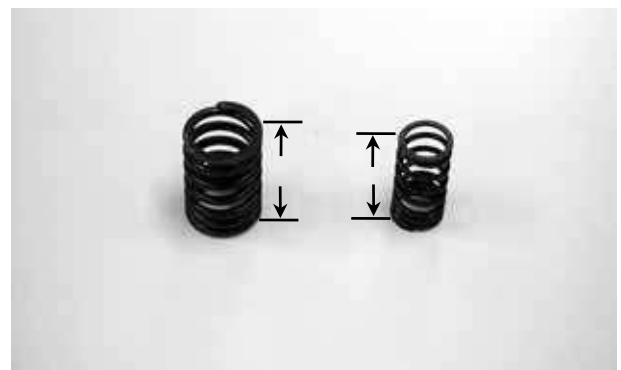

VALVE /VALVE GUIDE

Inspect each valve for bending, burning, scratches or abnormal stem wear.

Check valve movement in the guide.

Measure each valve stem O.D.

Service Limits: IN: 4.925mm replace if below
EX: 4.915mm replace if below

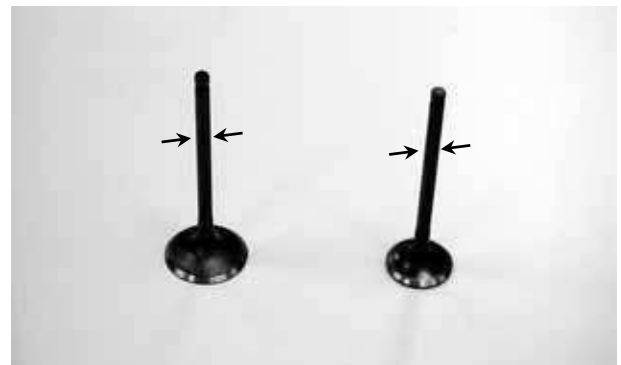

CYLINDER HEAD ASSEMBLY

Install the valve spring seats and stem seals.

Lubricate each valve stem with engine oil and insert the valves into the valve guides.

Be sure to install new valve stem seals.

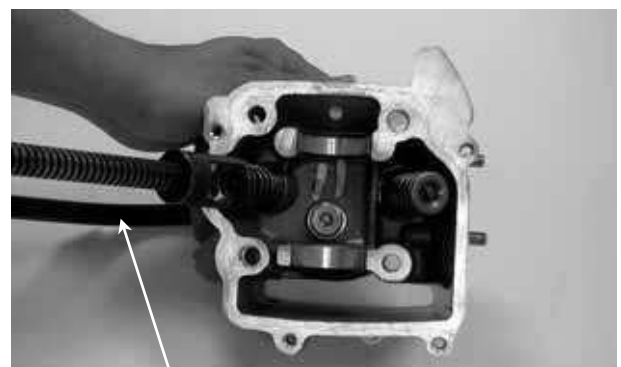

Valve Spring Compressor

6. CYLINDER HEAD/VALVES

Tap the valve stems gently with a plastic hammer to firmly seat the cotters.

* Be careful not to damage the valves.



Cylinder Head

CYLINDER HEAD INSTALLATION

Install the cam chain guide.
Install the dowel pins and a new cylinder head gasket.

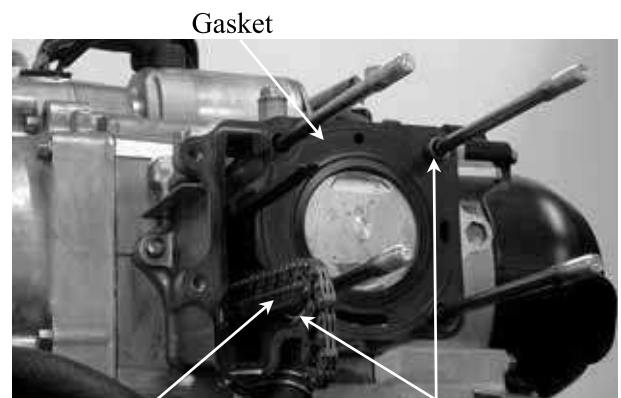

Cam Chain Guide

Dowel Pins

Install the cylinder head and take out the cam chain



Cam Chain

Assemble the camshaft holder.
First install the intake and exhaust valve rocker arms; then install the rocker arm shafts.

- *
- Install the exhaust valve rocker arm shaft on the “EX” side of the camshaft holder and the exhaust rocker arm shaft is shorter.
 - Clean the intake valve rocker arm shaft off any grease before installation.
 - Align the cutout on the exhaust valve rocker arm shaft with the bolt of the camshaft holder.

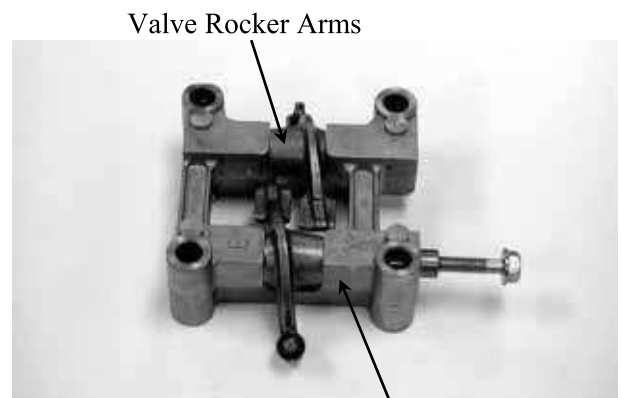

Valve Rocker Arms

Camshaft Holder

6. CYLINDER HEAD/VALVES

CAMSHAFT INSTALLATION

Turn the A.C. generator flywheel so that the "T" mark on the flywheel aligns with the index mark on the crankcase.

Keep the round hole on the camshaft gear facing up and align the punch marks on the camshaft gear with the cylinder head surface (Position the intake and exhaust cam lobes down.) and install the cam chain over the camshaft gear.

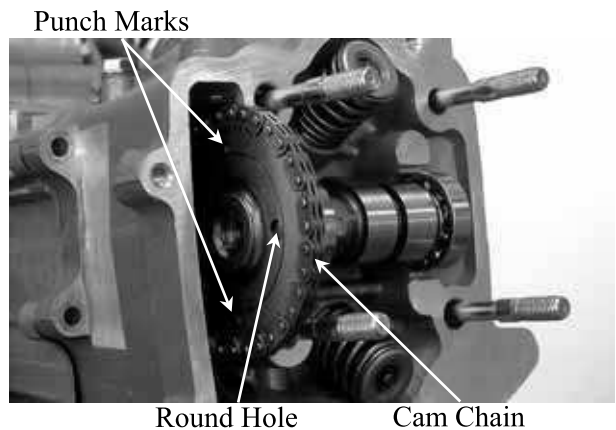

Install the dowel pins.

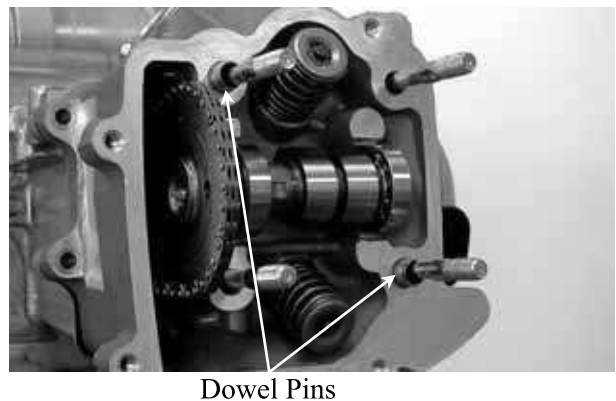

Install the camshaft holder, washers and nuts on the cylinder head.

Tighten the four cylinder head nuts and the two bolts between the cylinder head and cylinder.

Torque: Cylinder head cap nut: 19.6N-m
Cylinder & cylinder head bolt: 7.8 ~ 11.8N-m

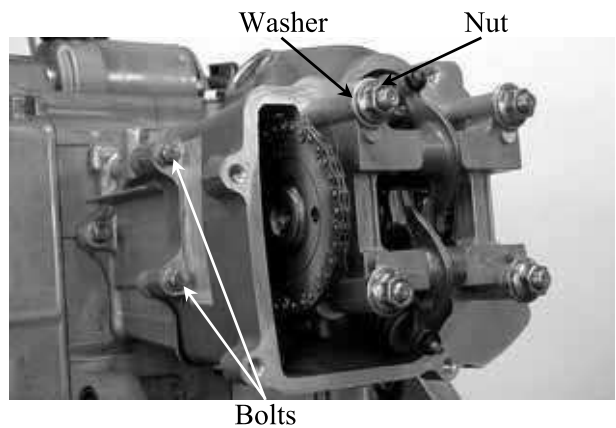

- *
- Apply engine oil to the threads of the cylinder head cap nuts.
 - Diagonally tighten the cylinder head cap nuts in 2~3 times.
 - First tighten the cylinder head cap nuts and then tighten the bolts between the cylinder and cylinder head to avoid cracks.

6. CYLINDER HEAD/VALVES

Install a new cam chain tensioner gasket.
Release the lock pawl and push the push rod all the way in.

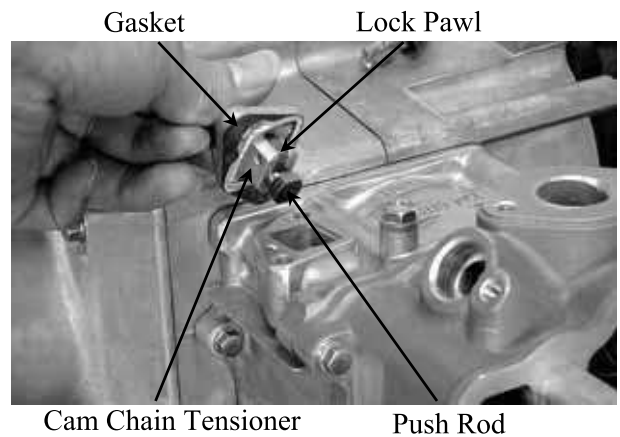

Install the cam chain tensioner and tighten the two bolts.
Install the tensioner spring and tighten the sealing bolt.
Torque: 2.9~5.8N-m

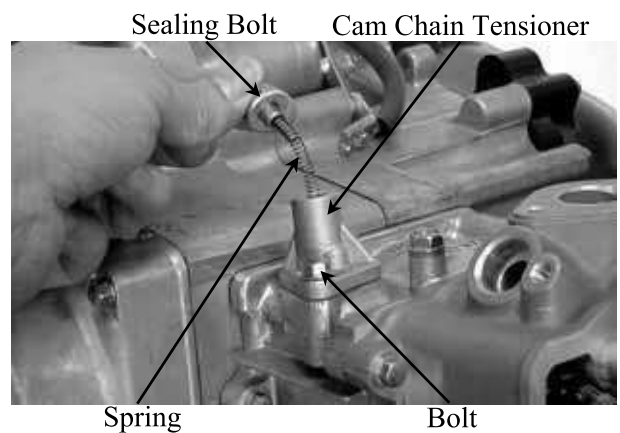

CYLINDER HEAD COVER INSTALLATION

Adjust the valve clearance. (⇒3-6)
Install a new cylinder head cover O-ring and install the cylinder head cover.

* Be sure to install the O-ring into the groove properly.

Install and tighten the cylinder head cover bolts.

Torque: 7.8~11.8N-m

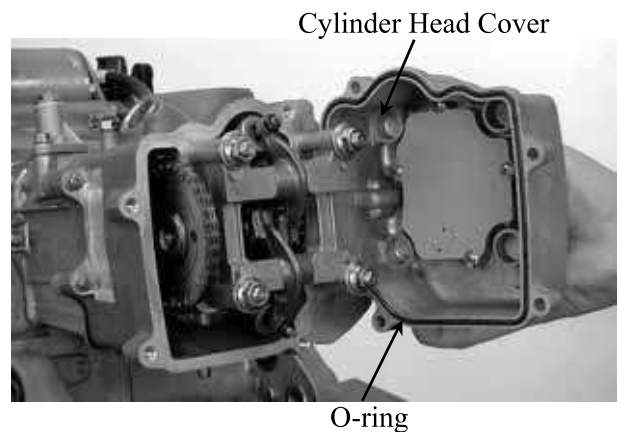

7. CYLINDER/PISTON



CYLINDER/PISTON



SCHEMATIC DRAWING -----	7-1
SERVICE INFORMATION-----	7-2
TROUBLESHOOTING-----	7-2
CYLINDER REMOVAL -----	7-3
PISTON REMOVAL -----	7-3
PISTON INSTALLATION-----	7-7
CYLINDER INSTALLATION -----	7-7

7. CYLINDER/PISTON

SCHEMATIC DRAWING

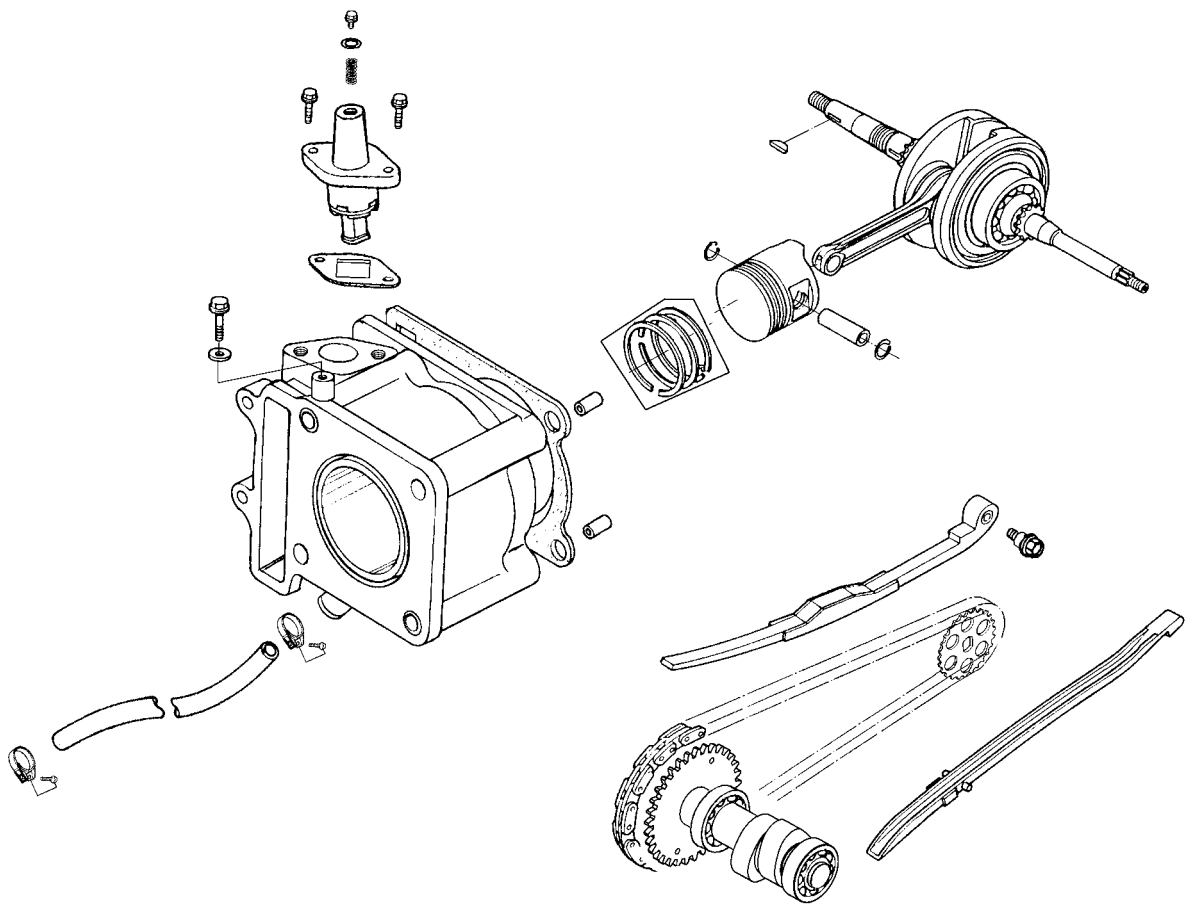

7. CYLINDER/PISTON

SERVICE INFORMATION

GENERAL INSTRUCTIONS

- The cylinder and piston can be serviced with the engine installed in the frame.
- When installing the cylinder, use a new cylinder gasket and make sure that the dowel pins are correctly installed.
- After disassembly, clean the removed parts and dry them with compressed air before inspection.

SPECIFICATIONS

Item			Standard (mm)		Service Limit (mm)	
			SH30CA	SH25CA	SH30CA	SH25CA
Cylinder	I.D.		57.405~57.415	52.400~52.410	57.50	52.50
	Warpage		0.01	0.01	0.05	0.05
	Cylindricity		0.01	0.01	0.05	0.05
	True roundness		0.01	0.01	0.05	0.05
Piston, piston ring	Ring-to-groove clearance	top	0.015~0.050	0.015~0.050	0.09	0.09
		Second	0.015~0.050	0.015~0.050	0.09	0.09
	Ring end gap	top	0.15~0.30	0.15~0.30	0.50	0.50
		Second	0.15~0.30	0.15~0.30	0.50	0.50
		Oil side rail	0.2~0.9	0.2~0.9	—	—
	Piston O.D.		57.375~57.395	52.370~52.390	57.30	52.30
	Piston O.D. measuring position		9mm from bottom of skirt	9mm from bottom of skirt	9mm from bottom of skirt	9mm from bottom of skirt
	Piston-to-cylinder clearance		0.010~0.040	0.010~0.040	0.01	0.01
Piston pin hole I.D.		15.002~15.008	15.002~15.008	15.04	15.04	
Piston pin O.D			14.994~15.000	14.994~15.000	14.96	14.96
Piston-to-piston pin clearance			0.002~0.014	0.002~0.014	0.02	0.02
Connecting rod small end I.D. bore			15.016~15.034	15.016~15.034	15.06	15.06

TROUBLESHOOTING

- When hard starting or poor performance at low speed occurs, check the crankcase breather for white smoke. If white smoke is found, it means that the piston rings are worn, stuck or broken.

Compression too low or uneven compression

- Worn or damaged cylinder and piston rings
- Worn, stuck or broken piston rings

Compression too high

- Excessive carbon build-up in combustion chamber or on piston head

Excessive smoke from exhaust muffler

- Worn or damaged piston rings
- Worn or damaged cylinder and piston

Abnormal noisy piston

- Worn cylinder, piston and piston rings
- Worn piston pin hole and piston pin
- Incorrectly installed piston

7. CYLINDER/PISTON

CYLINDER REMOVAL

Remove the cylinder head. (⇒6-7)
 Remove the water hose from the cylinder.
 Remove the cylinder base bolt.

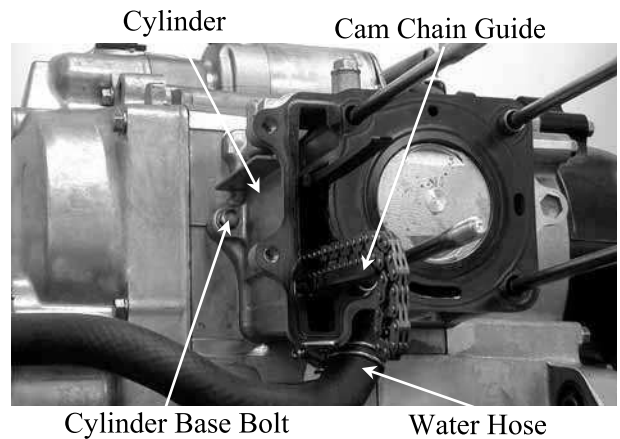

Remove the cam chain guide.
 Remove the cylinder.

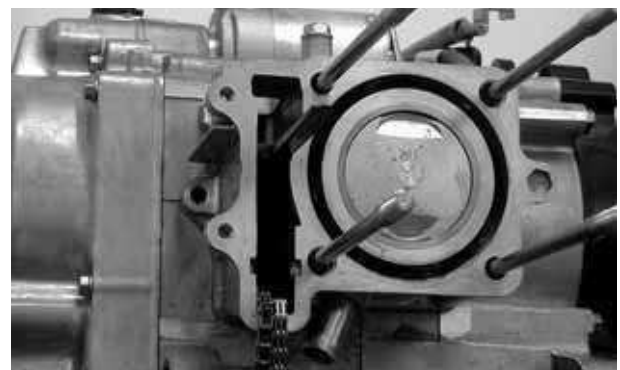

Remove the cylinder gasket and dowel pins.
 Clean any gasket material from the cylinder surface.

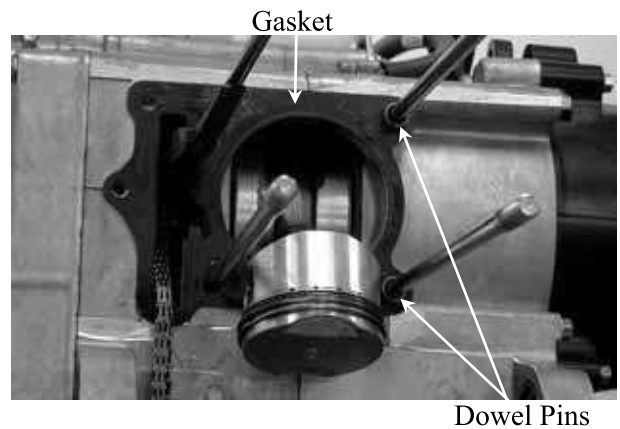

PISTON REMOVAL

Remove the piston pin clip.
 Press the piston pin out of the piston.

* Place a clean shop towel in the crankcase to keep the piston pin clip from falling into the crankcase.

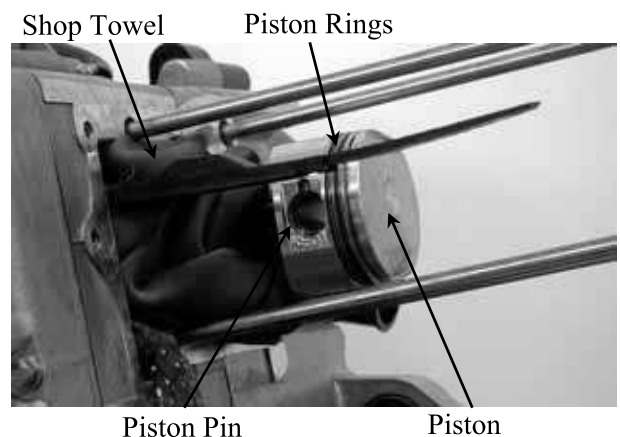

7. CYLINDER/PISTON

Inspect the piston, piston pin and piston rings.
Remove the piston rings.

- * • Take care not to damage or break the piston rings during removal.

Clean carbon deposits from the piston ring grooves.



Install the piston rings onto the piston and measure the piston ring-to-groove clearance.

Service Limits:

Top: 0.09mm replace if over

2nd: 0.09mm replace if over



Remove the piston rings and insert each piston ring into the cylinder bottom.

- * • Use the piston head to push each piston ring into the cylinder.

Measure the piston ring end gap.

Service Limit: 0.5mm replace if over



Measure the piston pin hole I.D.

Service Limit: 15.04mm replace if over



7. CYLINDER/PISTON

Measure the piston pin O.D.

Service Limit: 14.96mm replace if below



Measure the piston O.D.

- *

• Take measurement at 9mm from the bottom and 90° to the piston pin hole.

Service Limit: 57.90mm replace if below

SH30CA	57.30mm replace if below
SH25CA	52.30mm replace if below

Measure the piston-to-piston pin clearance.

Service Limit: 0.02mm replace if over



CYLINDER INSPECTION

Inspect the cylinder bore for wear or damage. Measure the cylinder I.D. at three levels of top, middle and bottom at 90° to the piston pin (in both X and Y directions).

Service Limit: 58.10mm repair or replace if below

SH30CA	57.50mm repair or replace if over
SH25CA	52.50mm repair or replace if over

Measure the cylinder-to-piston clearance.

Service Limit: 0.1mm repair or replace if over

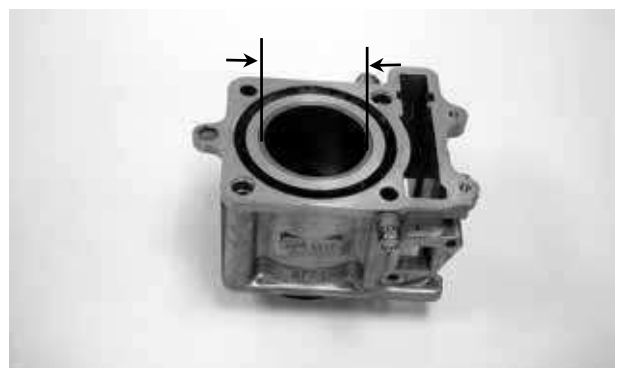

The true roundness is the difference between the values measured in X and Y directions. The cylindricity (difference between the values measured at the three levels) is subject to the maximum value calculated.

Service Limits:

True Roundness: 0.05mm repair or replace if over

Cylindricity: 0.05mm repair or replace if over

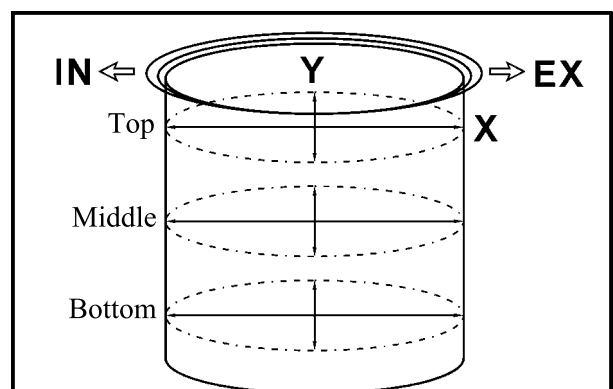

7. CYLINDER/PISTON

Inspect the top of the cylinder for warpage.
Service Limit: 0.05mm repair or replace if over

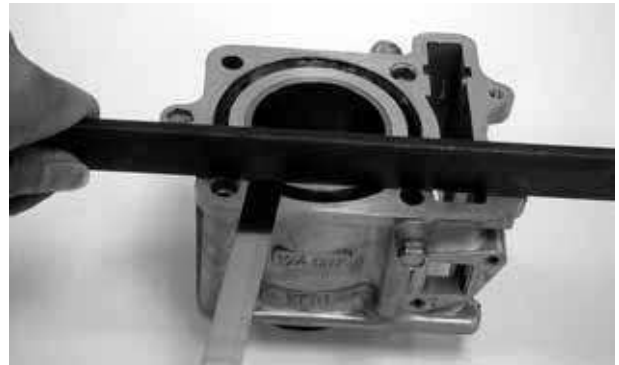

Measure the connecting rod small end I.D.
Service Limit: 15.06mm replace if over



PISTON RING INSTALLATION

Install the piston rings onto the piston.
 Apply engine oil to each piston ring.

- *
- Be careful not to damage the piston and piston rings during assembly.
 - All rings should be installed with the markings facing up.
 - After installing the rings, they should rotate freely without sticking.
 - Stagger the ring end gaps as the figure shown.

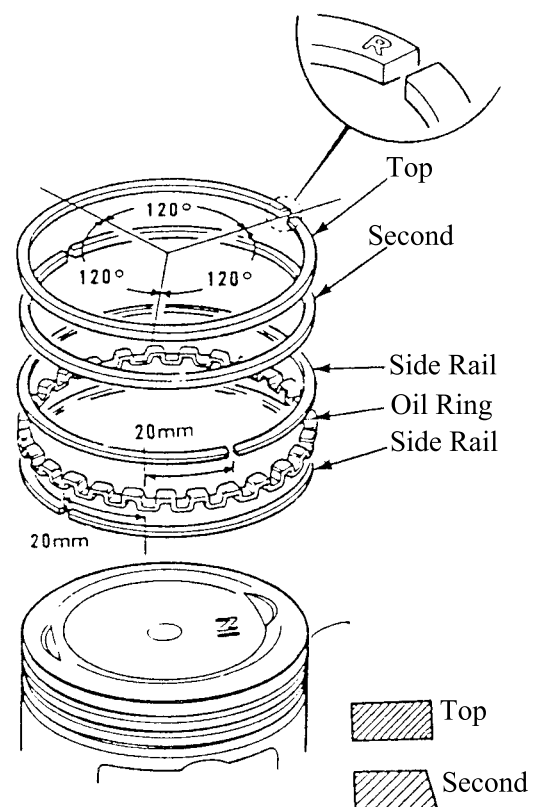

7. CYLINDER/PISTON

PISTON INSTALLATION

Remove any gasket material from the crankcase surface.

- *
 • Be careful not to drop foreign matters into the crankcase.



Install the piston, piston pin and a new piston pin clip.

- *
 • Position the piston "IN" mark on the intake valve side.
 • Place a clean shop towel in the crankcase to keep the piston pin clip from falling into the crankcase.

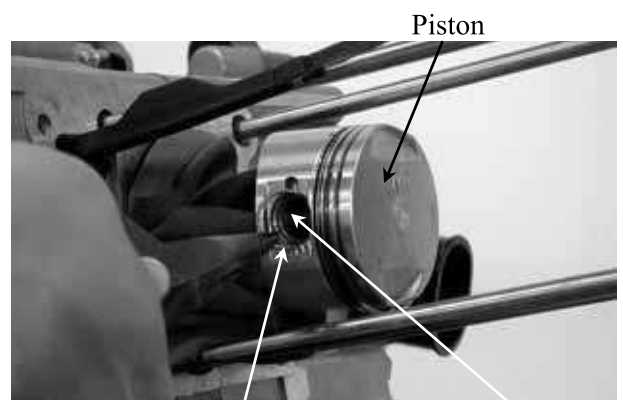

Piston Pin Clip

Piston Pin

CYLINDER INSTALLATION

Install the dowel pins and a new cylinder gasket on the crankcase.

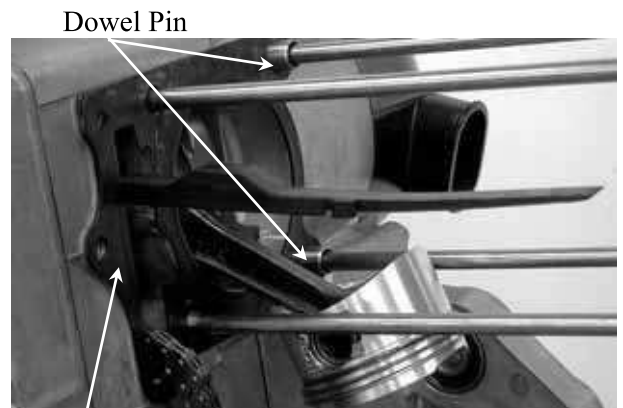

Gasket

Coat the cylinder bore, piston and piston rings with clean engine oil. Carefully lower the cylinder over the piston by compressing the piston rings.

- *
 • Be careful not to damage or break the piston rings.
 • The piston ring end gaps should not be parallel with or at 90° to the piston pin.

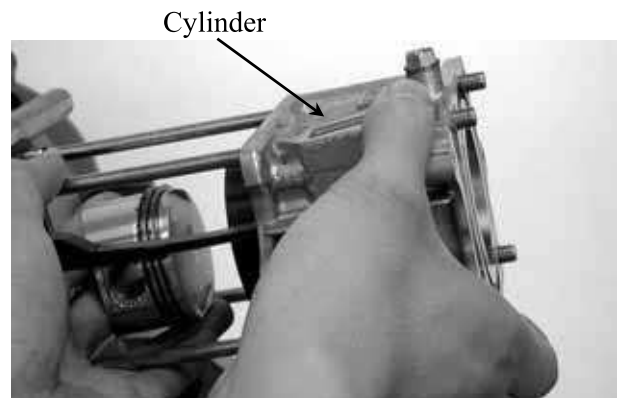

Cylinder

7. CYLINDER/PISTON

Tighten the cylinder base bolt.

Cylinder Base Bolt

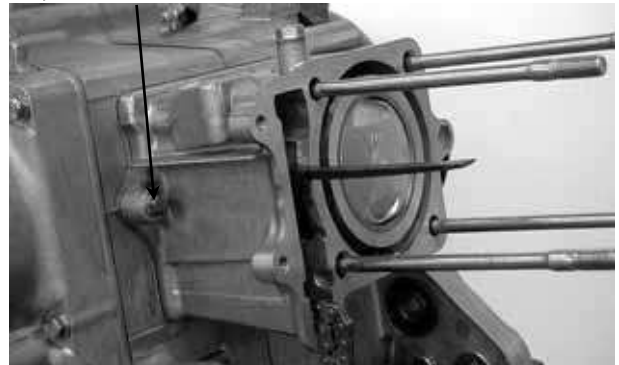

Install the cam chain guide.

- * • Insert the tab on the cam chain guide into the cylinder groove.

Connect the water hose to the cylinder.
Install the cylinder head. (⇒6-9)
Tighten the cylinder base bolt.

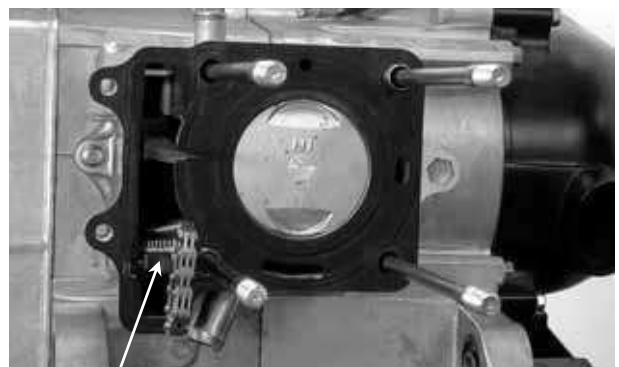

Cam Chain Guide



**DRIVE AND DRIVEN PULLEYS/
KICK STARTER**



SCHEMATIC DRAWING -----	8- 1
SERVICE INFORMATION-----	8- 2
TROUBLESHOOTING-----	8- 2
LEFT CRANKCASE COVER -----	8- 3
DRIVE PULLEY -----	8- 4
CLUTCH/DRIVEN PULLEY-----	8- 8
KICK STARTER -----	8-15

8. DRIVE AND DRIVEN PULLEYS/ KICK STARTER

SCHEMATIC DRAWING

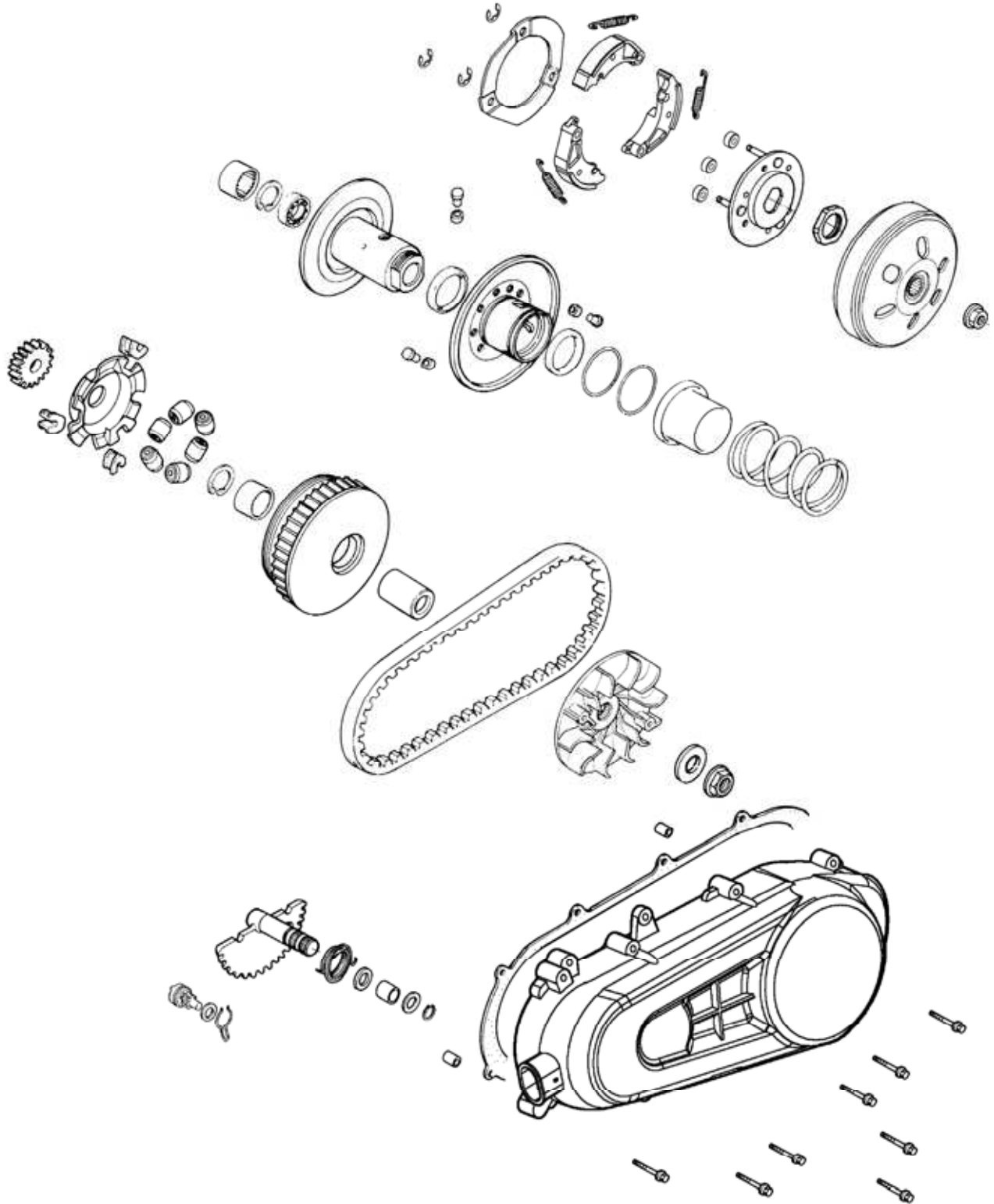

8. DRIVE AND DRIVEN PULLEYS/ KICK STARTER

SERVICE INFORMATION

GENERAL INSTRUCTIONS

- The drive pulley, clutch and driven pulley can be serviced with the engine installed.
- Avoid getting grease and oil on the drive belt and pulley faces. Remove any oil or grease from them to minimize the slipping of drive belt and drive pulley.

SPECIFICATIONS

Item	Standard (mm)	Service Limit (mm)
Movable drive face bushing I.D.	33.000~33.025	33.06
Drive face collar O.D.	32.006~32.009	31.90
Drive belt width	19.0	17.5
Clutch lining thickness	3.963~4.037	2.0
Clutch outer I.D.	130.0~130.2	130.5
Driven face spring free length	88.3	83.2
Driven face O.D.	33.965~33.985	33.94
Movable driven face I.D.	34.00~34.025	34.06
Weight roller O.D.	16.99~17.00	16.00

TORQUE VALUES

Drive face nut	49.0~58.8N-m
Clutch outer nut	49.0~58.8N-m
Clutch drive plate nut	49.0~58.8N-m

SPECIAL TOOLS

Universal holder	Clutch spring compressor
Bearing driver	Lock nut wrench, 39mm
	Kick starter spring remover

TROUBLESHOOTING

Engine starts but motorcycle won't move

- Worn drive belt
- Broken ramp plate
- Worn or damaged clutch lining
- Broken driven face spring

Engine stalls or motorcycle creeps

- Broken clutch weight spring

Lack of power

- Worn drive belt
- Weak driven face spring
- Worn weight roller
- Faulty driven face

8. DRIVE AND DRIVEN PULLEYS/ KICK STARTER

LEFT CRANKCASE COVER

REMOVAL

Loosen the drive belt air tube band screw.

Air Tube Band

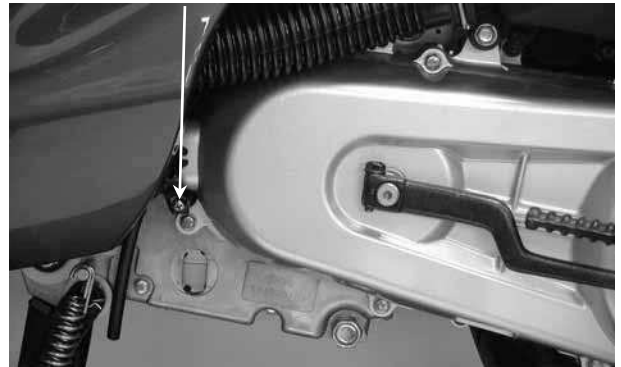

Remove the left crankcase cover bolts and left crankcase cover.
Remove the seal rubber and dowel pins.

Bolts



Kick Lever

Left Crankcase Cover

INSTALLATION

Install the dowel pins and the seal rubber.

Dowel Pins

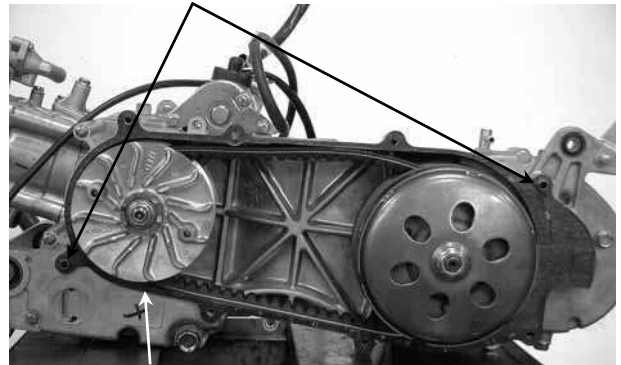

Seal Rubber

Install the left crankcase cover.

- * Do not pull out the kick starter spindle. Press in the kick starter spindle when installing the left crankcase cover.

Install the cable clamp to the specified location. Install and tighten the left crankcase cover bolts.

Left Crankcase Cover

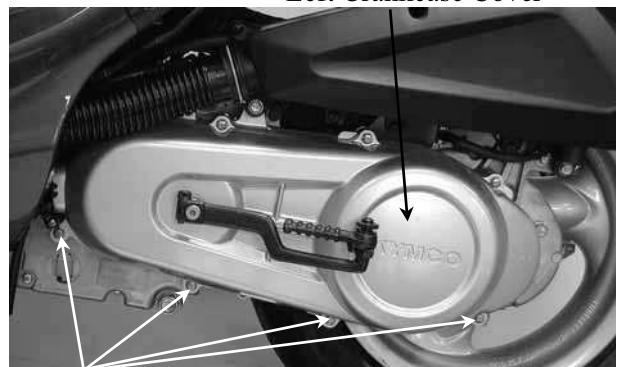

Bolts

8. DRIVE AND DRIVEN PULLEYS/ KICK STARTER

Install the drive belt air tube and tighten the tube band screw.



Tube Band Screw

DRIVE PULLEY

REMOVAL

Remove the left crankcase cover.
Hold the drive pulley using an universal holder and remove the drive face nut and washer.
Remove the drive pulley face.

Special

Universal Holder

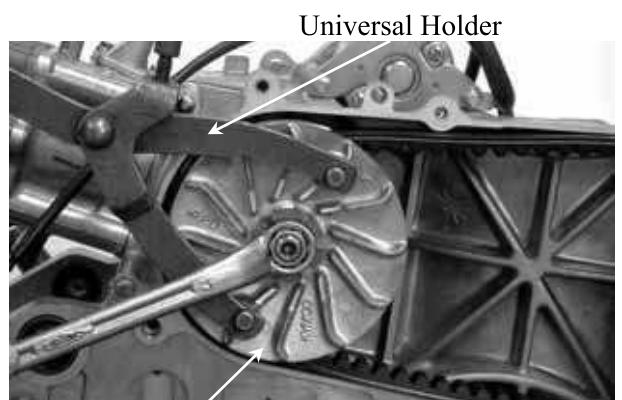

Universal Holder

Drive Pulley Face

Remove the drive belt from the movable drive face.

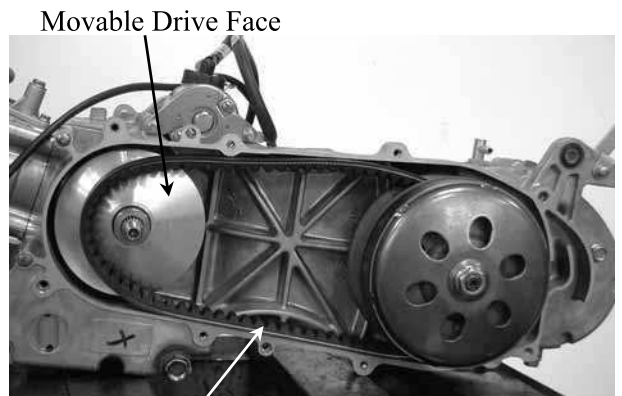

Movable Drive Face

Drive Belt

INSPECTION

Check the drive belt for cracks, separation or abnormal or excessive wear.
Measure the drive belt width.

Service Limit: 17.5mm replace if below

- * Use specified genuine parts for replacement.

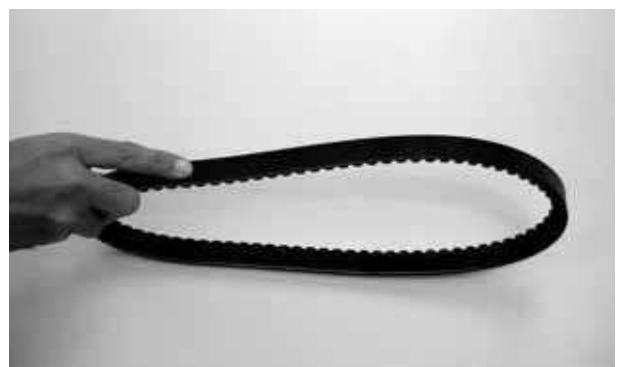

8. DRIVE AND DRIVEN PULLEYS/ KICK STARTER

Remove the movable drive face assembly.
Remove the drive pulley collar.

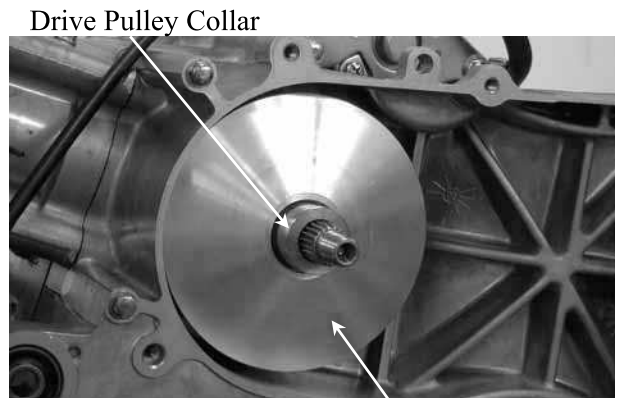

Movable Drive Face Assembly

DISASSEMBLY

Remove the ramp plate.



Remove the weight rollers.

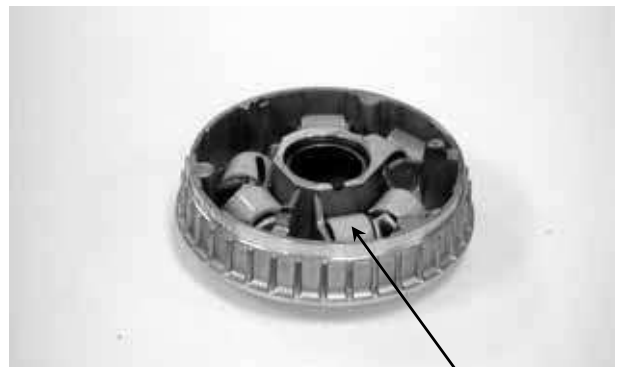

Weight Roller

INSPECTION

Check each weight roller for wear or damage.
Measure each weight roller O.D.

Service Limit: 16.00mm replace if below

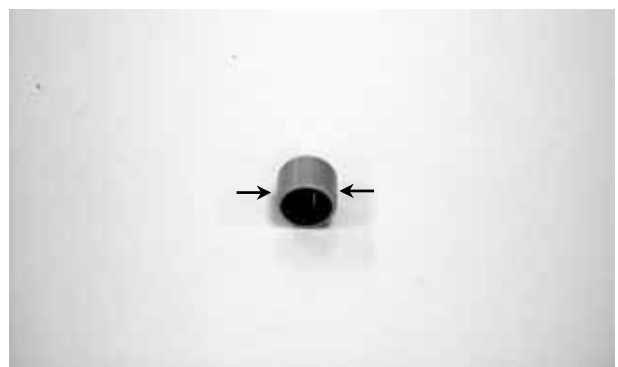

8. DRIVE AND DRIVEN PULLEYS/ KICK STARTER

Measure the movable drive face bushing assembly I.D.

Service Limit: 27.20mm replace if over



Check the drive pulley collar for wear or damage.
Measure the O.D. of the drive pulley collar sliding surface.

Service Limit: 26.90mm replace if below

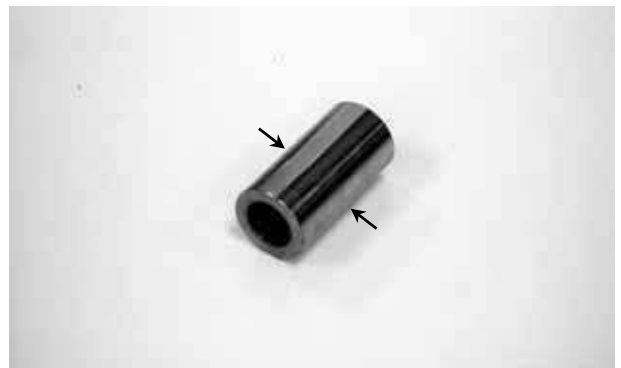

ASSEMBLY

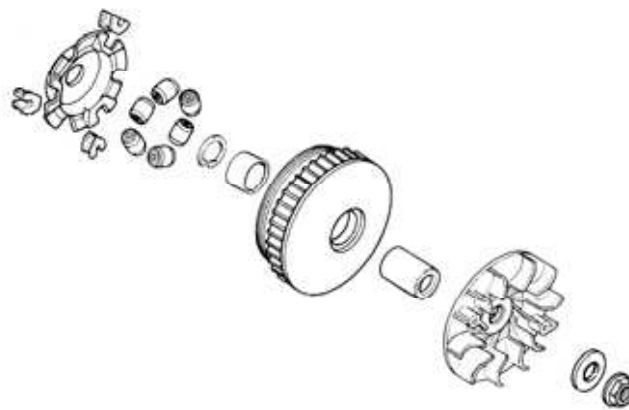

Install the weight rollers into the movable drive face.

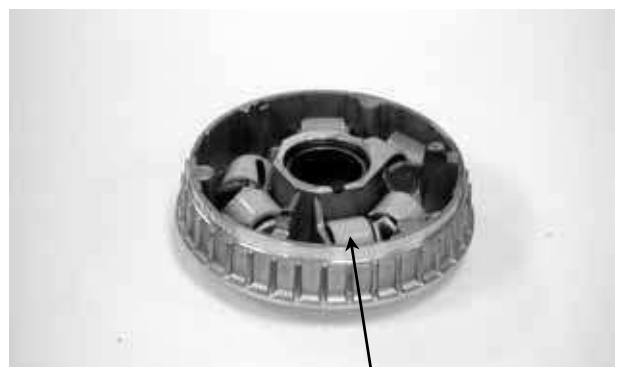

Weight Roller

8. DRIVE AND DRIVEN PULLEYS/ KICK STARTER

Install the ramp plate.



Insert the drive pulley collar into the movable drive face.



INSTALLATION

Install the movable drive face onto the crankshaft.

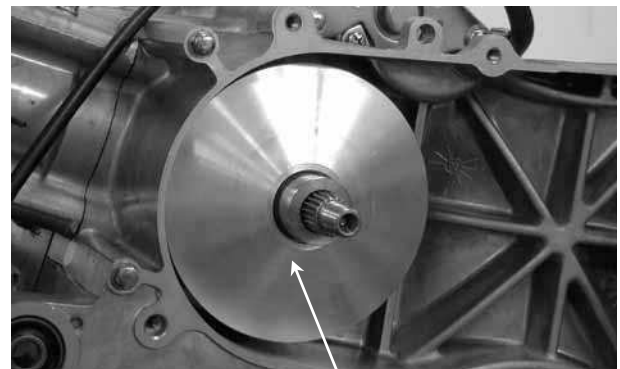

Lay the drive belt on the driven pulley.
Set the drive belt on the drive pulley collar.

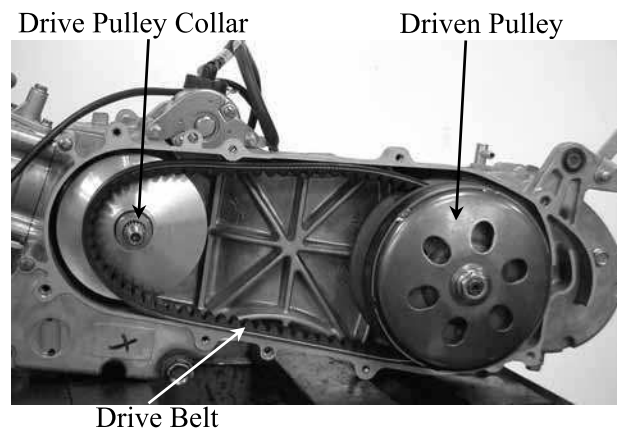

8. DRIVE AND DRIVEN PULLEYS/ KICK STARTER

Install the drive pulley face, washer and drive face nut.

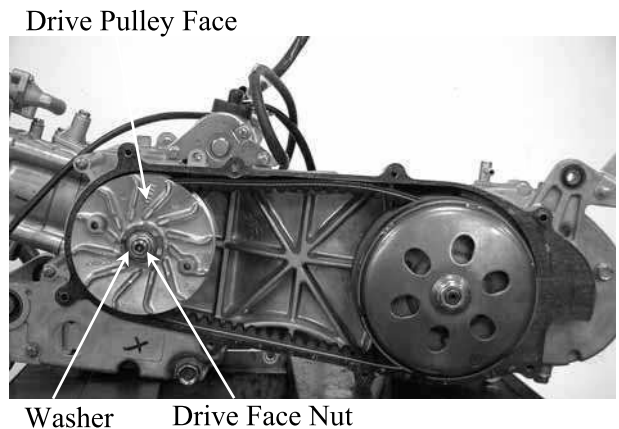

Hold the drive pulley with the universal holder and tighten the drive face nut.

Torque: 49.0~58.5N-m

Special

Universal Holder

- * Do not get oil or grease on the drive belt or drive pulley faces.

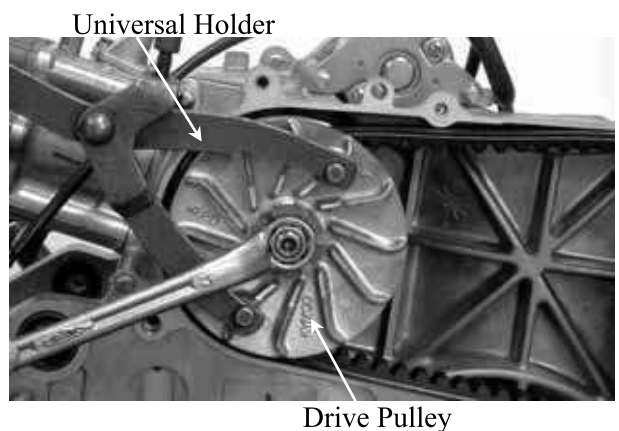

CLUTCH/DRIVEN PULLEY

Remove the left crankcase cover. (⇒8-3)
Remove the drive pulley and drive belt. (⇒8-4)

Hold the clutch outer with the universal holder and remove the clutch outer nut.

Special

Universal Holder

Remove the clutch outer.

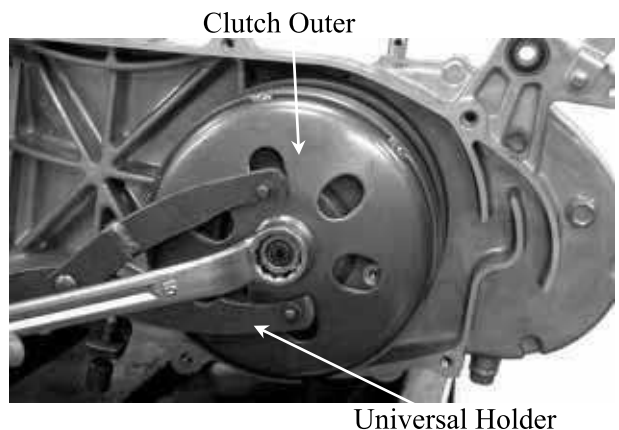

INSPECTION

Inspect the clutch outer for wear or damage.
Measure the clutch outer I.D.

Service Limit: 130.5mm replace if over



8. DRIVE AND DRIVEN PULLEYS/ KICK STARTER

Check the clutch shoes for wear or damage.
Measure the clutch lining thickness.

Service Limit: 2.0mm replace if below



CLUTCH/DRIVEN PULLEY DISASSEMBLY

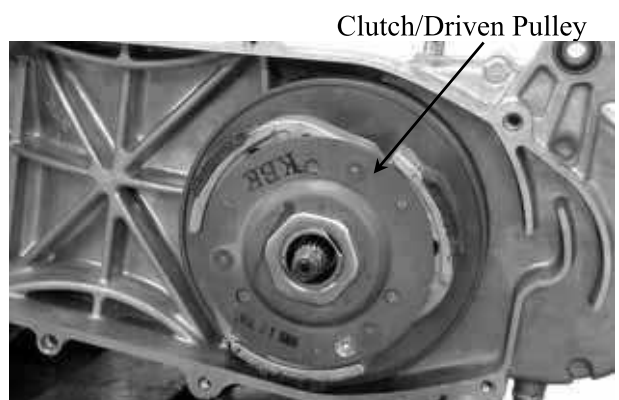

Hold the clutch/driven pulley assembly with
the clutch spring compressor.

- * Be sure to use a clutch spring compressor to avoid spring damage.

Special

Clutch Spring Compressor

Set the tool in a vise and remove the clutch
drive plate nut.

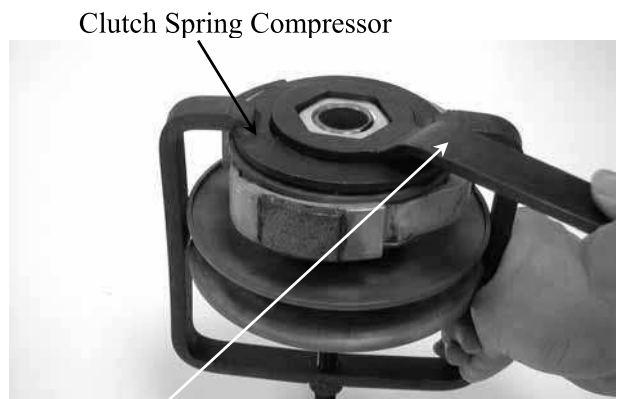

Lock Nut Wrench

Special

Lock Nut Wrench, 39mm

Loosen the clutch spring compressor and
disassemble the clutch/driven pulley
assembly.

Remove the seal collar.



8. DRIVE AND DRIVEN PULLEYS/ KICK STARTER

Pull out the guide roller pins and guide rollers.
Remove the movable driven face from the
driven face.

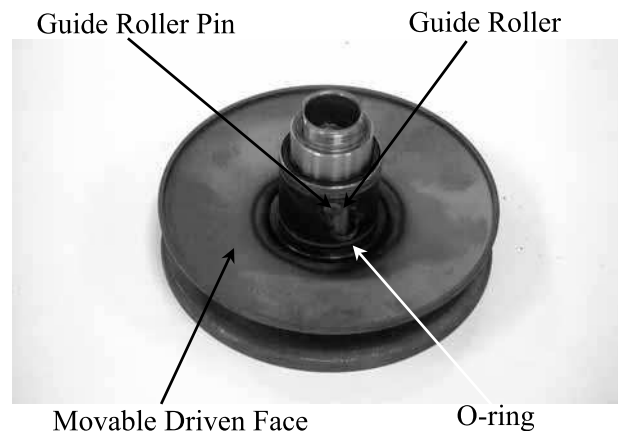

Remove the oil seal from the movable driven
face.



INSPECTION

Measure the driven face spring free length.
Service Limit: 83.2mm replace if below

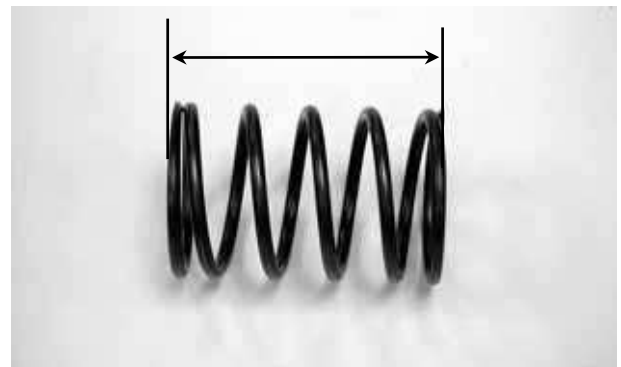

Check the driven face assembly for wear or
damage.
Measure the driven face O.D.
Service Limit: 33.94mm replace if below



8. DRIVE AND DRIVEN PULLEYS/ KICK STARTER

Check the movable driven face for wear or damage.

Measure the movable driven face I.D.

Service Limit: 34.06mm replace if over

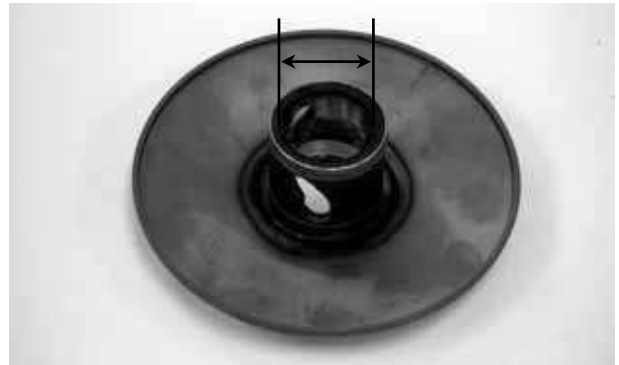

DRIVEN PULLEY FACE BEARING REPLACEMENT

Check the bearings for play and replace them if they have excessive play.

Drive the inner needle bearing out of the driven pulley face.

- * Discard the removed bearing and replace with a new one.

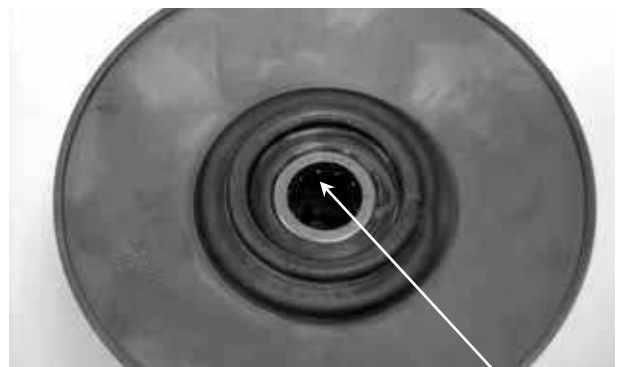

Inner Bearing

Remove the snap ring and drive the outer bearing out of the driven face.

- * Discard the removed bearing and replace with a new one.

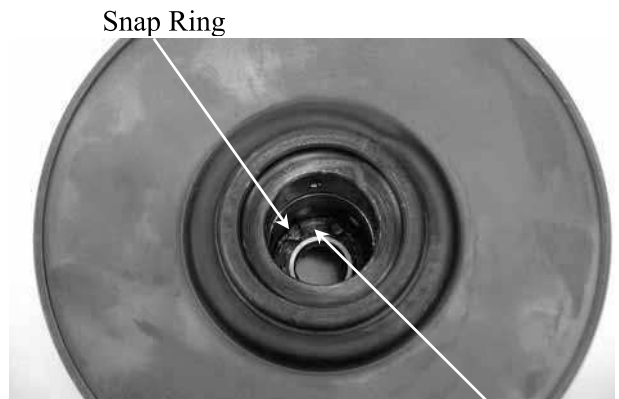

Outer Bearing

Apply grease to the outer bearing.
Drive a new outer bearing into the driven face with the sealed end facing up.

Special

Bearing Driver

Seat the snap ring in its groove.
Apply grease to the driven face bore areas.

- * Pack all bearing cavities with 9~9.5g grease.

8. DRIVE AND DRIVEN PULLEYS/ KICK STARTER

Press a new needle bearing into the driven face.

Special

Bearing Driver

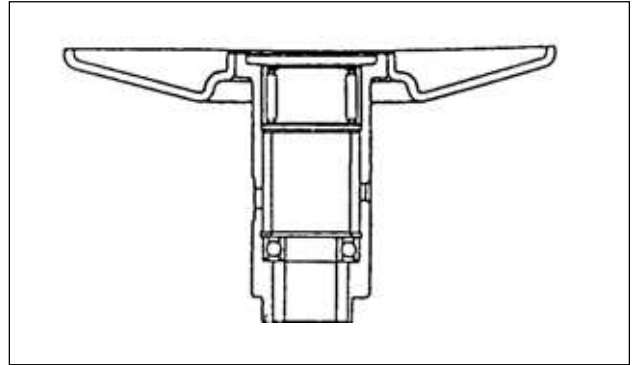

CLUTCH DISASSEMBLY

Remove the circlips and retainer plate to disassemble the clutch.

- * • Keep grease off the clutch linings.

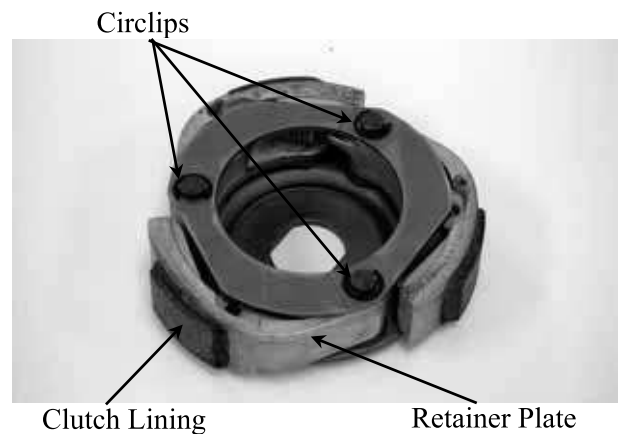

8. DRIVE AND DRIVEN PULLEYS/ KICK STARTER

CLUTCH ASSEMBLY

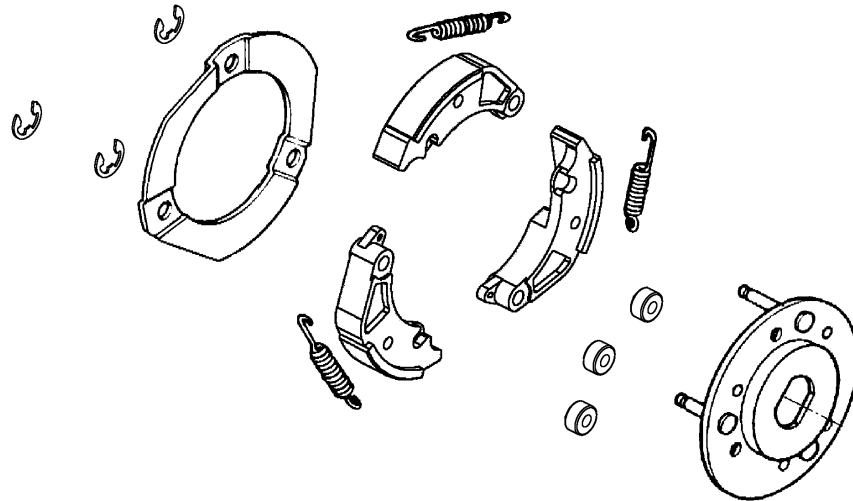

Install the damper rubbers on the drive plate pins.
Install the clutch weights/shoes and clutch springs onto the drive plate.
Install the retainer plate and secure with the circlips.

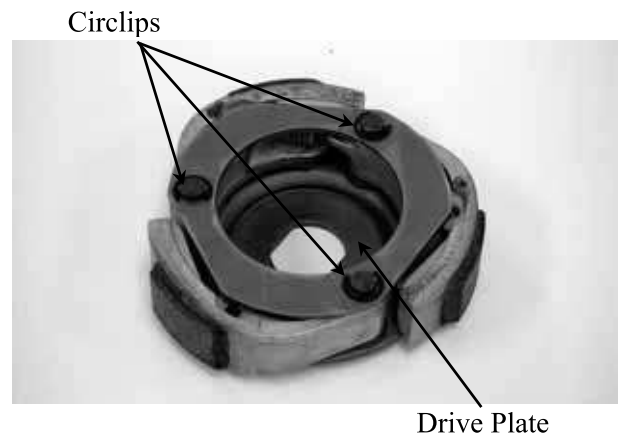

CLUTCH/DRIVEN PULLEY ASSEMBLY

Clean the pulley faces and remove any grease from them.
Apply grease to the O-rings and install them onto the moveable driven face.



8. DRIVE AND DRIVEN PULLEYS/ KICK STARTER

Install the movable driven face onto the driven face.
Apply grease to the guide rollers and guide roller pins and then install them into the holes of the driven face.

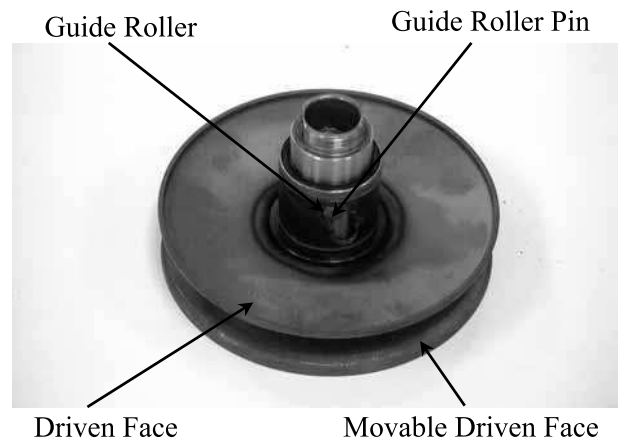

Install the seal collar.
Remove any excessive grease.

- * Be sure to clean the driven face off any grease.



Set the driven pulley assembly, driven face spring and clutch assembly onto the clutch spring compressor.

- * Align the flat surface of the driven face with the flat on the clutch drive plate.

Compress the tool and install the drive plate nut.

Set the tool in a vise and tighten the drive plate nut to the specified torque.

Torque: 49.0~58.8N-m

- * Be sure to use a clutch spring compressor to avoid spring damage.



Special

Clutch Spring Compressor
Outer Driver, 32x35mm

INSTALLATION

Install the clutch/driven pulley onto the drive shaft.

- * Keep grease off the drive shaft.



8. DRIVE AND DRIVEN PULLEYS/ KICK STARTER

Install the clutch outer.
Hold the clutch outer with the universal holder.
Install and tighten the clutch outer nut.
Torque: 49.0~58.8kg-m

Special

Universal Holder

Install the drive belt. (⇒8-7)
Install the left crankcase cover. (⇒8-3)

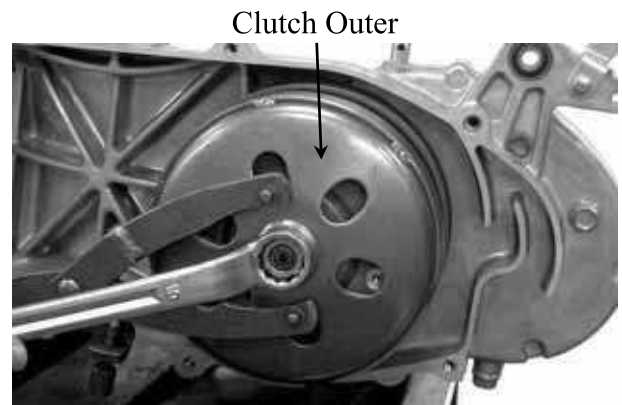

KICK STARTER

REMOVAL

Remove the left crankcase cover. (⇒8-3)
Remove the seal rubber and dowel pins.
Remove the kick lever.
Remove the circlip and washer from the kick starter spindle.



Kick Starter Spindle

Gently turn the kick starter spindle to remove the starter driven gear together with the friction spring.

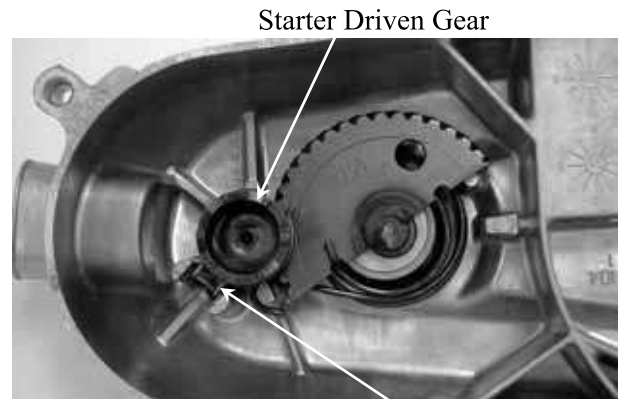

Friction Spring

Remove the kick starter spindle and return spring from the left crankcase cover.
Remove the kick starter spindle bushing.

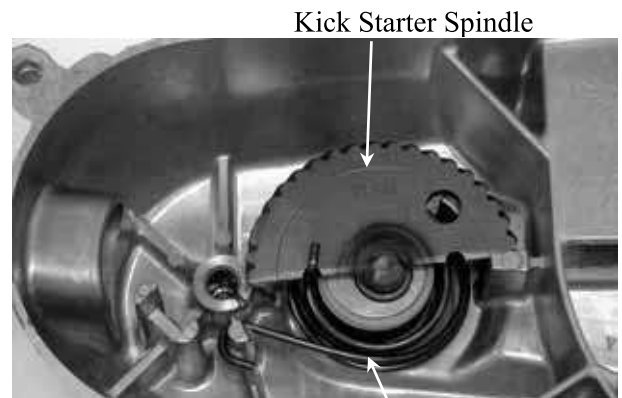

Return Spring

8. DRIVE AND DRIVEN PULLEYS/ KICK STARTER

INSPECTION

Inspect the kick starter spindle and gear for wear or damage.
Inspect the return spring for weakness or damage.
Inspect the kick starter spindle bushings for wear or damage.

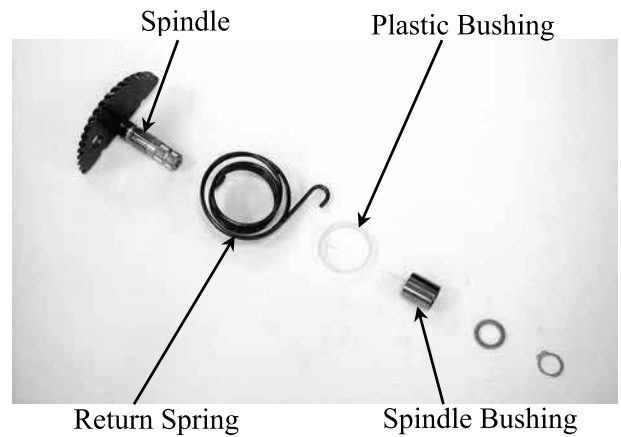

Inspect the starter driven gear for wear or damage.
Inspect the friction spring for wear or damage.

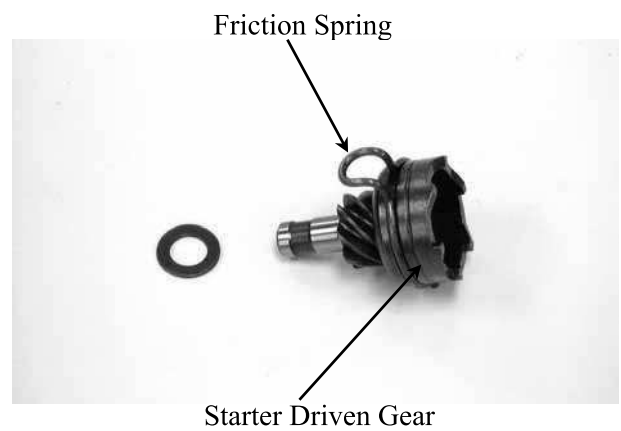

Inspect the kick starter spindle and starter driven gear forcing parts for wear or damage.

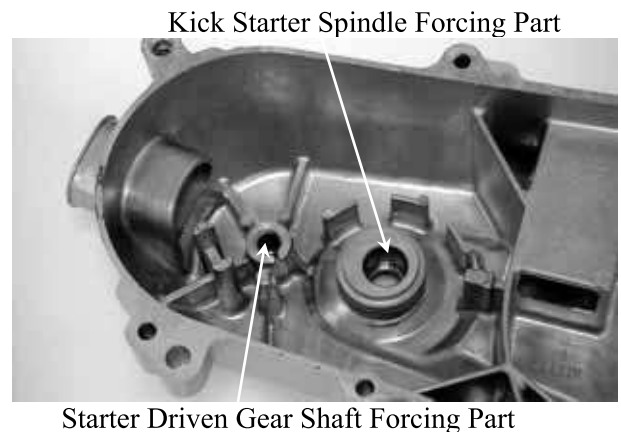

INSTALLATION

Install the kick starter spindle bushings and return spring onto the left crankcase cover.

* When installing the return spring, use a screw driver to press the inward and outward return spring hooks into their original positions respectively.

Install the starter driven gear and friction spring as the figure shown.

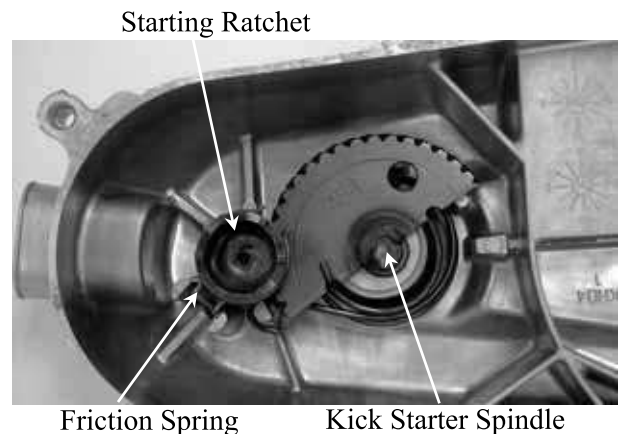

8. DRIVE AND DRIVEN PULLEYS/ KICK STARTER

Install the kick lever.
Install the left crankcase cover and tighten the cover bolts diagonally.
Connect the drive belt air tube and tighten the band screw.



Left Crankcase Cover

9. FINAL REDUCTION

FINAL REDUCTION

SCHEMATIC DRAWING -----	9-1
SERVICE INFORMATION-----	9-2
TROUBLESHOOTING-----	9-2
FINAL REDUCTION DISASSEMBLY -----	9-3
FINAL REDUCTION INSPECTION-----	9-3
FINAL REDUCTION ASSEMBLY -----	9-6



9. FINAL REDUCTION

SCHEMATIC DRAWING

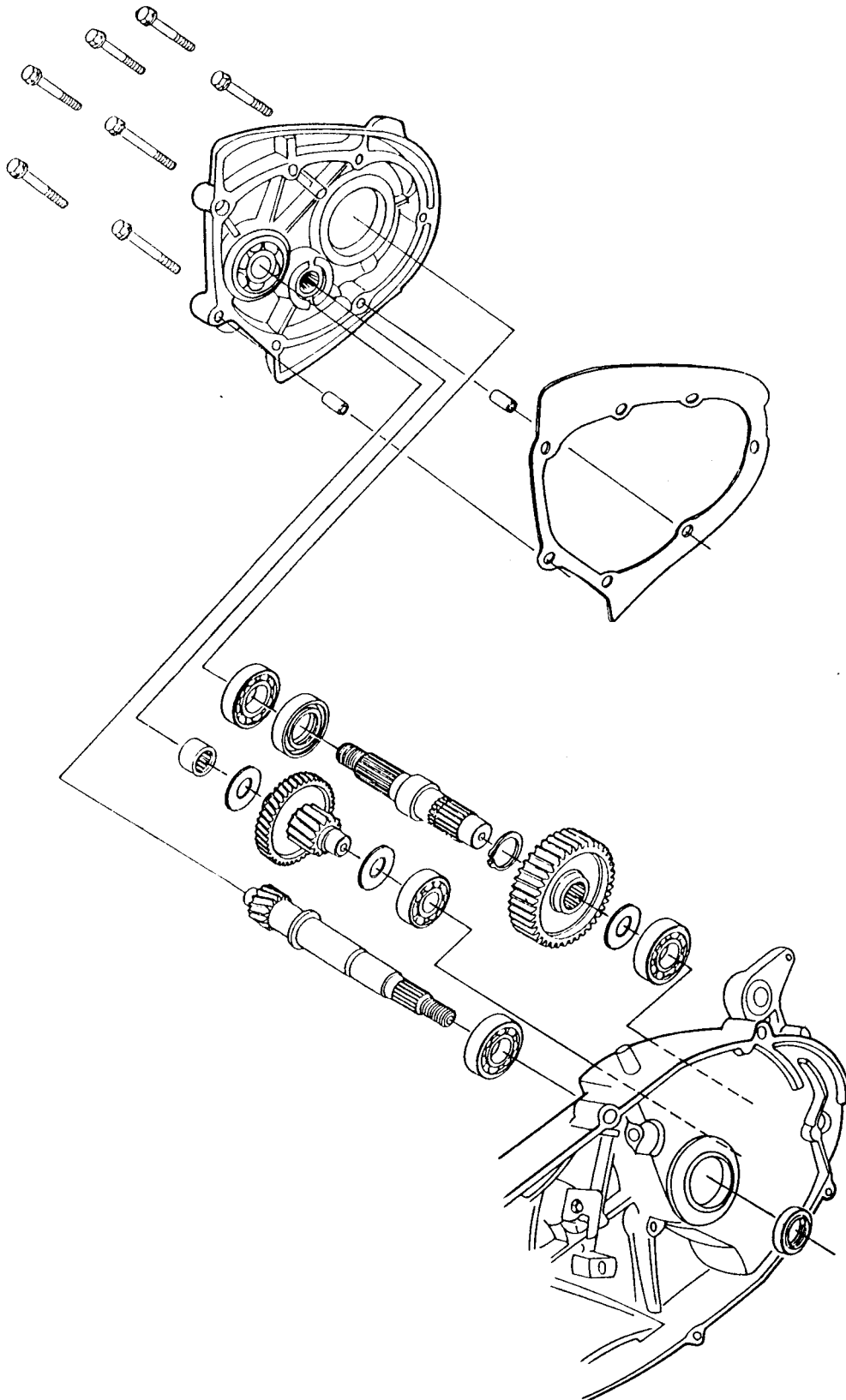

9. FINAL REDUCTION

SERVICE INFORMATION

GENERAL INSTRUCTIONS

- The servicing operations of this section can be made with the engine installed.
- When replacing the drive shaft, use a special tool to hold the bearing inner race for this operation.

SPECIFICATIONS

Specified Oil: SAE 90#

Oil Capacity:

At disassembly : 0.2 liter

At change : 0.195 liter

TORQUE VALUES

Transmission case cover bolt 25.5~31.4N-m

Oil check bolt 9.8~14.7N-m

SPECIAL TOOLS

Bearing remover, 12mm

Bearing remover, 15mm

Pilot, 12mm

Pilot, 15mm

TROUBLESHOOTING

Engine starts but motorcycle won't move

- Damaged transmission
- Seized or burnt transmission

Abnormal noise

- Worn, seized or chipped gears
- Worn bearing

Oil leaks

- Oil level too high
- Worn or damaged oil seal

9. FINAL REDUCTION

FINAL REDUCTION DISASSEMBLY

Remove the exhaust muffler. (⇒2-6)
 Remove the rear brake caliper. (⇒15-3)
 Remove the right rear shock absorber.
 (⇒15-5)
 Remove the rear fork. (⇒15-4)
 Remove the rear wheel. (⇒15-4)
 Remove the left crankcase cover. (⇒8-3)
 Remove the clutch/driven pulleys. (⇒8-4)
 Drain the transmission gear oil into a clean container.
 Remove the transmission case cover attaching bolts.

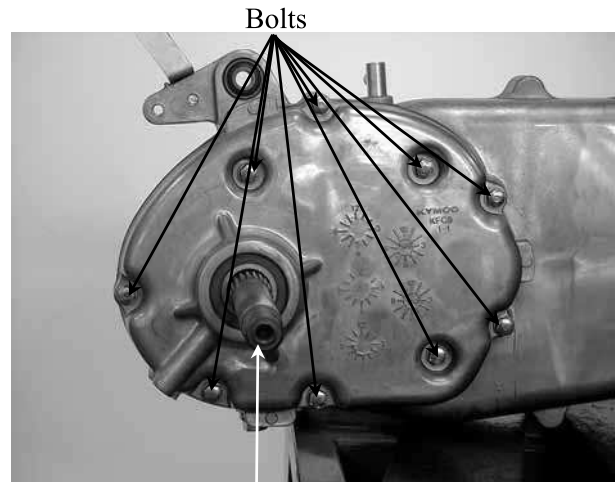

Final Shaft

Remove the transmission case cover.
 Remove the gasket and dowel pins.
 Remove the final gear and countershaft.

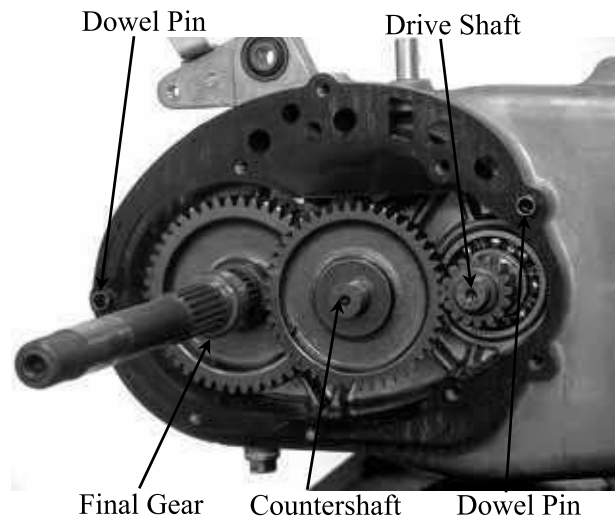

FINAL REDUCTION INSPECTION

Inspect the countershaft and gear for wear or damage.

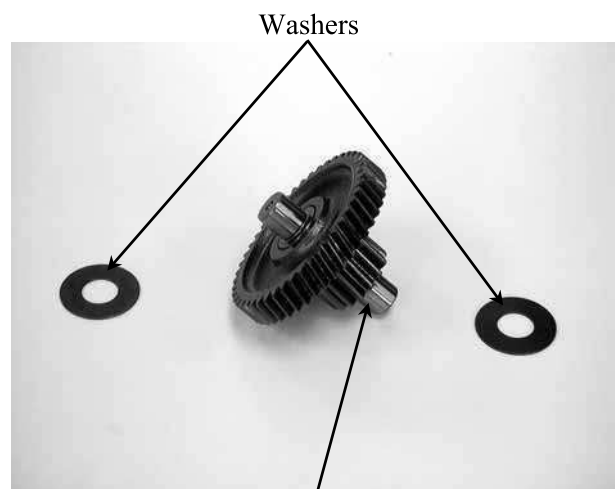

Countershaft

9. FINAL REDUCTION

Inspect the final gear and final shaft for wear, damage or seizure.



Check the left crankcase bearings for excessive play and inspect the oil seal for wear or damage.

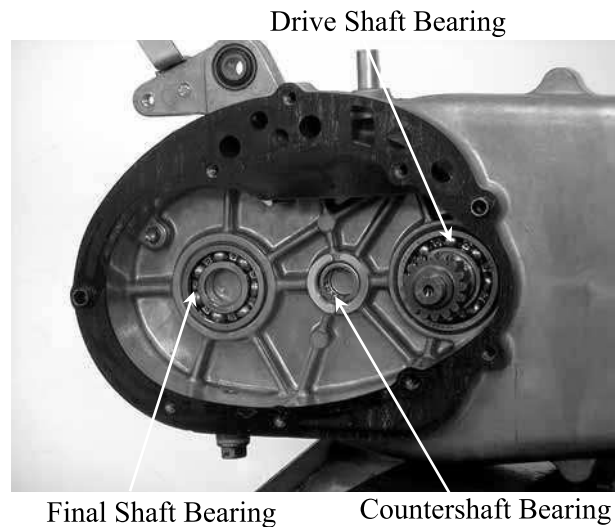

Inspect the drive shaft and gear for wear or damage.
Check the transmission case cover bearings for excessive play and inspect the final shaft bearing oil seal for wear or damage.

* Do not remove the transmission case cover except for necessary part replacement. When replacing the drive shaft, also replace the bearing and oil seal.

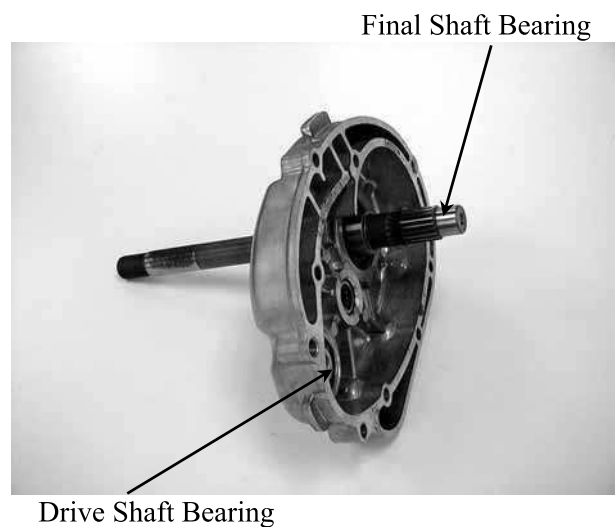

9. FINAL REDUCTION

BEARING REPLACEMENT (TRANSMISSION CASE COVER)

Remove the transmission case cover bearings using the bearing remover.
Remove the final shaft oil seal.

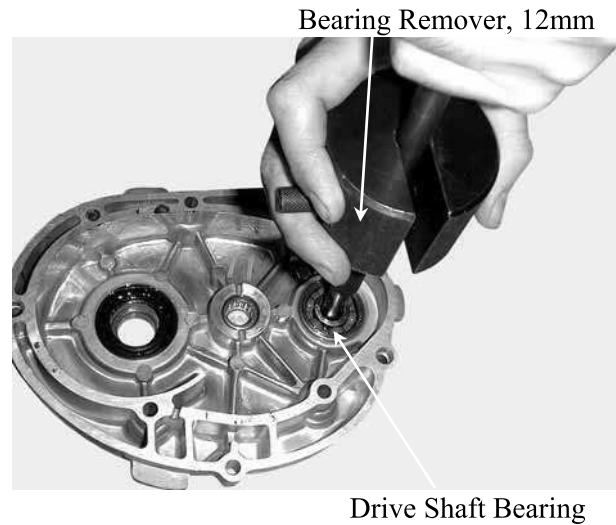

Drive new bearings into the transmission case cover.

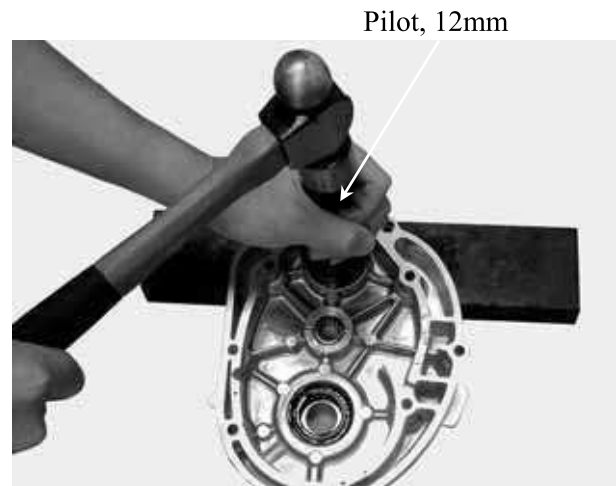

BEARING REPLACEMENT (LEFT CRANKCASE COVER)

Remove the drive shaft.
Remove the drive shaft oil seal.
Remove the left crankcase bearings using the bearing remover.



9. FINAL REDUCTION

Drive new bearings into the left crankcase.
Install a new drive shaft oil seal.



Pilot, 15mm

FINAL REDUCTION ASSEMBLY

Install the drive shaft into the left crankcase.

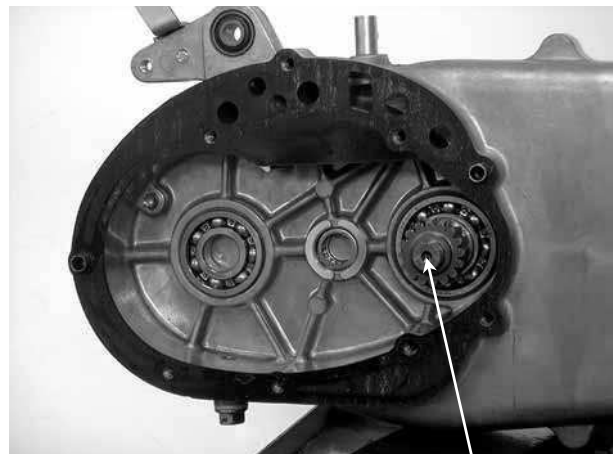

Drive Shaft

Install the final gear and final shaft into the left crankcase.

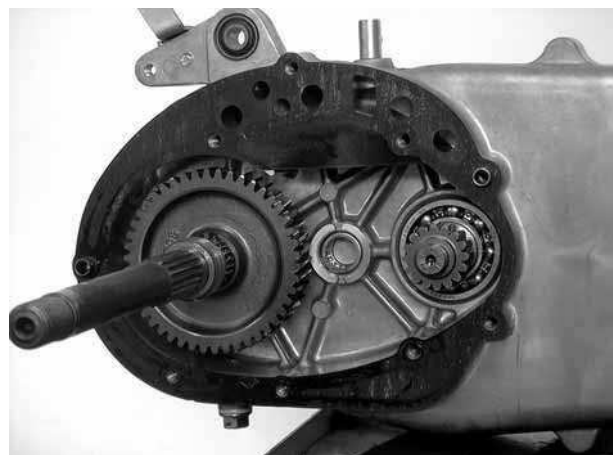

9. FINAL REDUCTION

Install the countershaft and gear into the left crankcase.
Install the resin washer onto the countershaft.
Install the dowel pins and a new gasket.

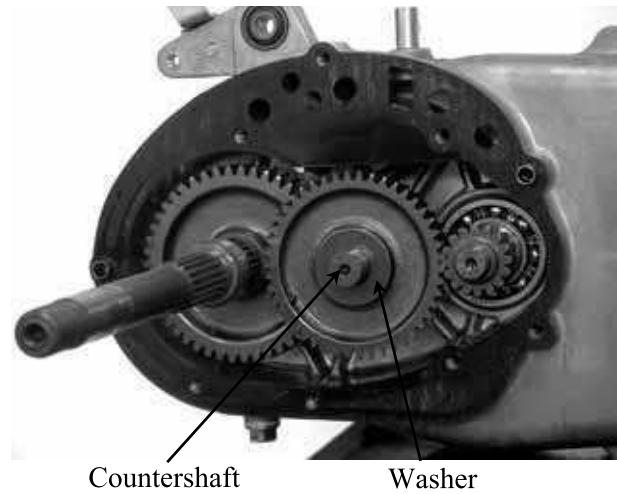

Install the transmission case cover.

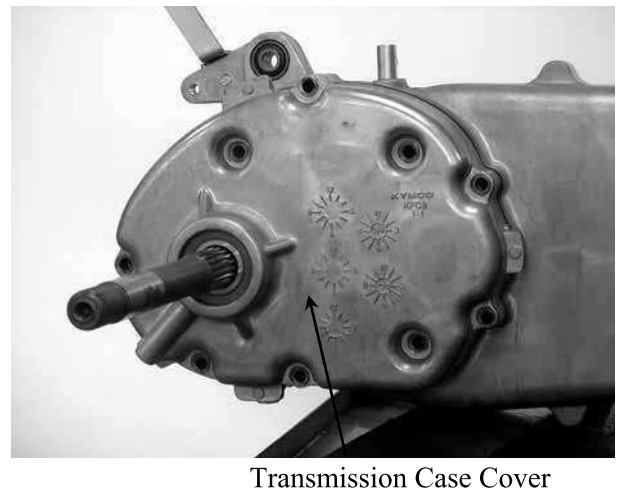

Install and tighten the transmission case cover bolts.
Install the clutch/driven pulley.
Install other removed parts in the reverse order of removal.

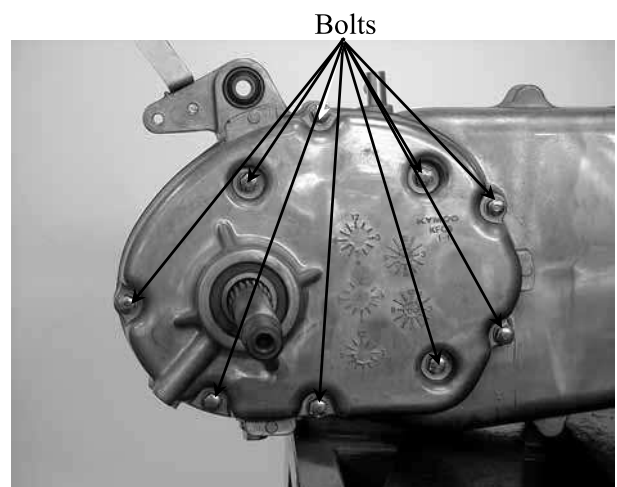

9. FINAL REDUCTION

After installation, fill the transmission case with the specified oil.

*

- Place the motorcycle on its main stand on level ground.
- Check the oil sealing washer for wear or damage.

Specified Gear Oil: SAE90#

Oil Capacity:

At disassembly : 0.2 liter

At change : 0.18 liter

Install and tighten the oil check bolt.

Torque: 9.8~14.7N-m

Start the engine and check for oil leaks.

Check the oil level from the oil check bolt hole and add the specified oil to the proper level if the oil level is low.

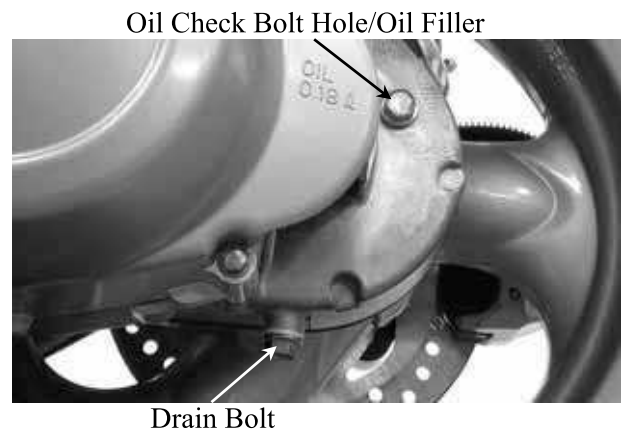

10. A.C. GENERATOR/STARTER CLUTCH

A.C. GENERATOR/STARTER CLUTCH

SCHEMATIC DRAWING -----	10-1
SERVICE INFORMATION-----	10-2
TROUBLESHOOTING-----	10-2
RIGHT CRANKCASE COVER REMOVAL -----	10-3
STATOR REMOVAL-----	10-3
FLYWHEEL REMOVAL -----	10-3
STARTER CLUTCH-----	10-4
FLYWHEEL INSTALLATION -----	10-5
STATOR INSTALLATION-----	10-6
RIGHT CRANKCASE COVER INSTALLATION -----	10-6

10. A.C. GENERATOR/STARTER CLUTCH

SCHEMATIC DRAWING

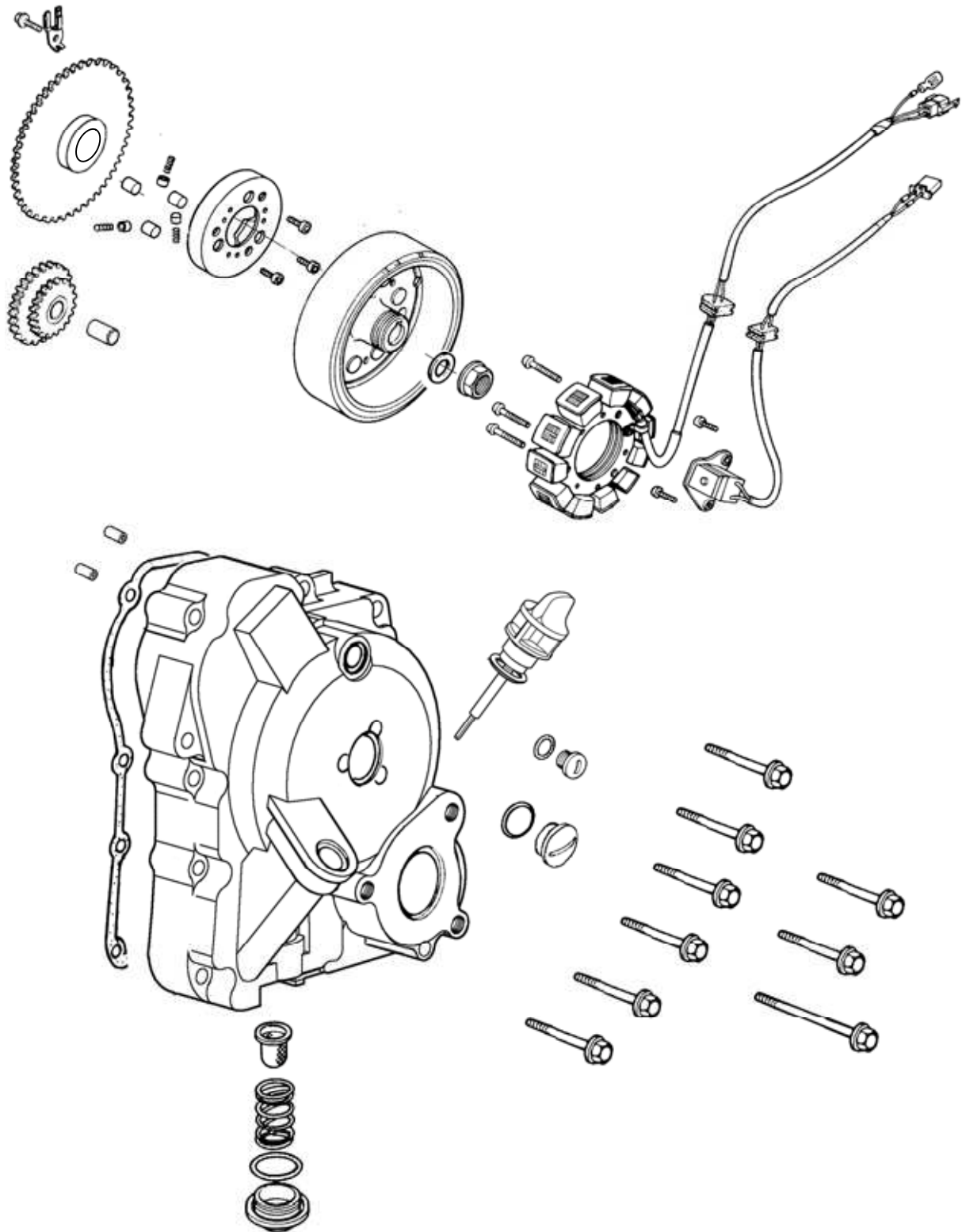

10. A.C. GENERATOR/STARTER CLUTCH

SERVICE INFORMATION

GENERAL INSTRUCTIONS

- All servicing operations and inspections in this section can be made with the engine installed.
- Drain the coolant before removing the right crankcase cover.
- Be careful not to drain the coolant when the engine temperature is high. (Perform this operation when the engine is cold.)
- Drain the coolant into a clean container.
- Drain the engine oil into a clean container before removing the right crankcase cover.
- When the right crankcase cover is installed, fill with the recommended engine oil and coolant. Then, bleed air from the water jacket.
- Refer to page 18-4 for A.C. generator inspection.

SPECIFICATIONS

Engine oil: SAE15W/40#
API-SG/CD

Oil capacity at change: 0.8 liter

Coolant: distilled water + coolant concentrate

Coolant capacity: 1165cc

SPECIAL TOOLS

Flywheel puller

Flywheel holder

SPECIFICATIONS

Item	Standard (mm)	Service Limit (mm)
Starter driven gear I.D.	20.025 ~ 20.045	20.15mm
Starter driven gear O.D.	42.175 ~ 42.200	41.0mm

TORQUE VALUES

Flywheel nut : 34.3 ~ 44.1N-m

TROUBLESHOOTING

Refer to page 1-27 for A.C. generator troubleshooting.

Starter motor rotates but engine does not start

- Faulty starter clutch
- Starter motor rotates reversely
- Weak battery

10. A.C. GENERATOR/STARTER CLUTCH

RIGHT CRANKCASE COVER REMOVAL

Disconnect the water hoses from the right crankcase cover.
Remove the nine bolts attaching the right crankcase cover and the cover.

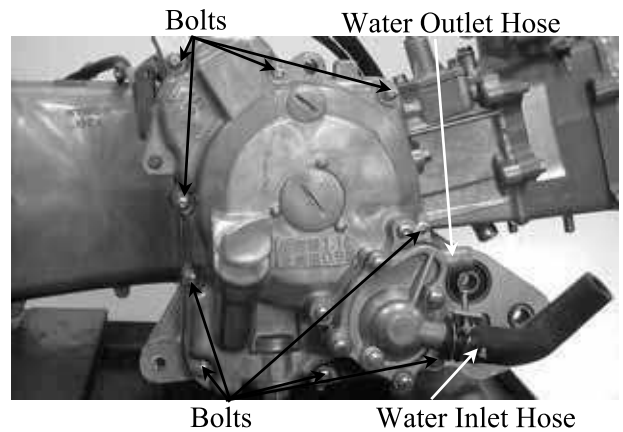

STATOR REMOVAL

Remove the two pulser coil attaching screws and the pulser coil.
Remove the three A.C. generator stator bolts and the stator.

* When removing the pulser coil and stator, be careful not to damage them to avoid shorted or broken wire.

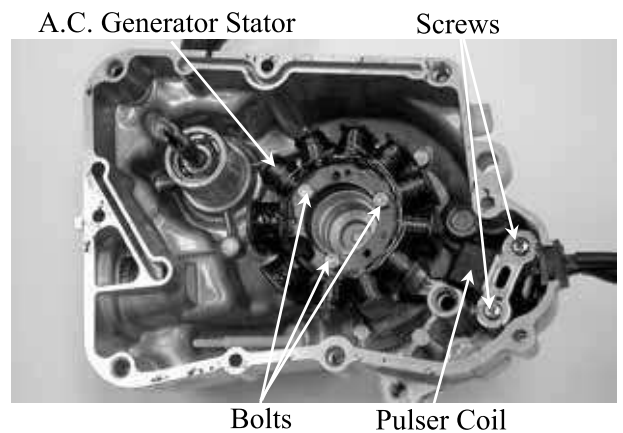

FLYWHEEL REMOVAL

Hold the flywheel with a flywheel holder and remove the flywheel nut.

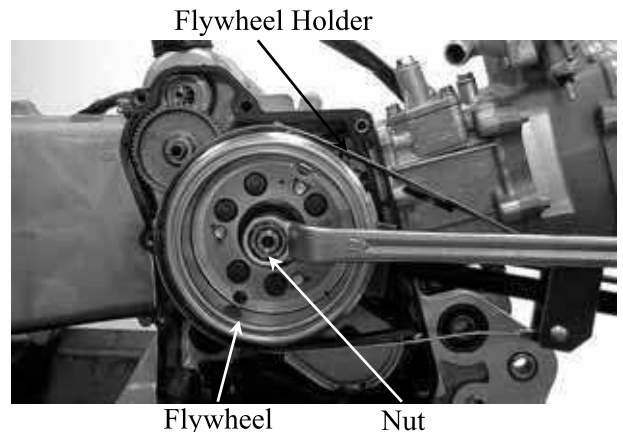

Remove the flywheel with a flywheel puller.



10. A.C. GENERATOR/STARTER CLUTCH

STARTER CLUTCH

REMOVAL

Remove the starter idle gear and shaft.

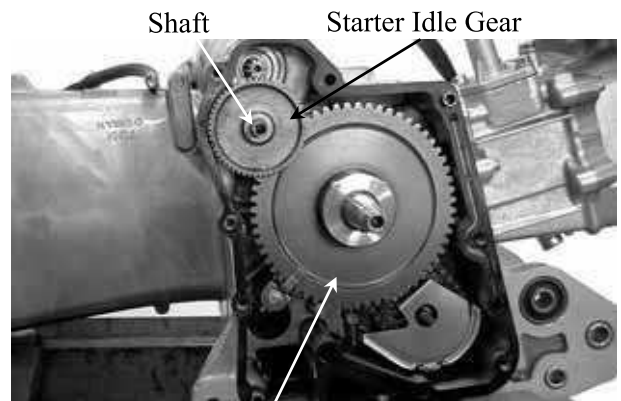

Starter Driven Gear

Remove the starter driven gear.



Starter Driven Gear

INSPECTION

Inspect the starter driven gear for wear or damage.

Measure the starter driven gear I.D. and O.D.

Service Limits:

I.D. : 20.15mm replace if over

O.D. : 41.00mm replace if below

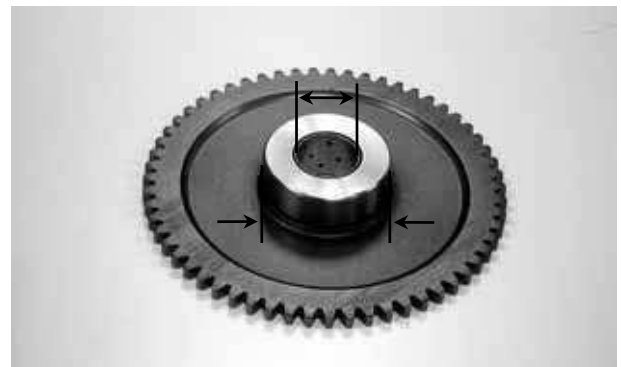

Starter Driven Gear

Inspect the starter idle gear and shaft for wear or damage.

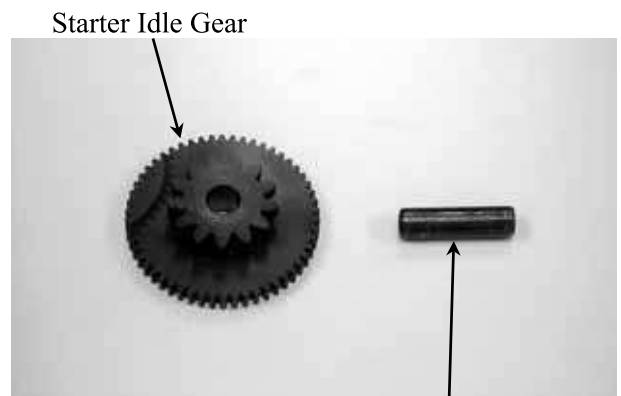

Starter Idle Gear

Shaft

10. A.C. GENERATOR/STARTER CLUTCH

Remove the starter one-way clutch rollers, plungers and springs.
 Inspect each roller and plunger for wear or damage and check for broken or weak spring.

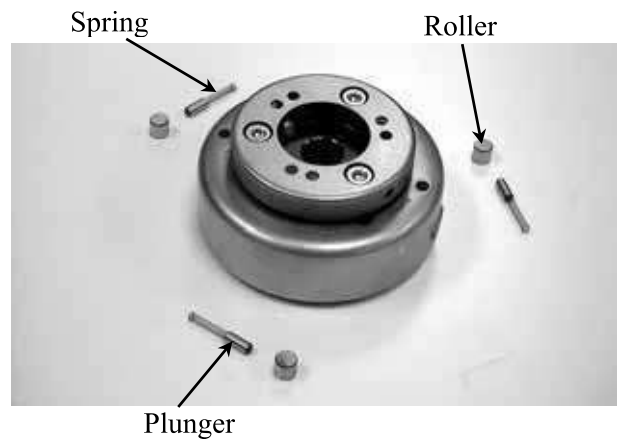

INSTALLATION

Install the starter driven gear onto the crankshaft.
 Install the starter idle gear and shaft.

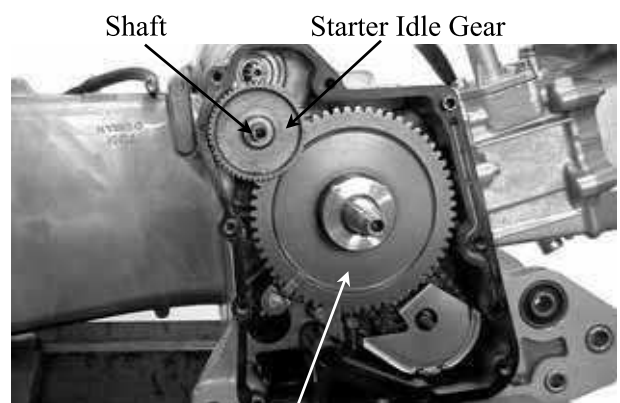

Starter Driven Gear

FLYWHEEL INSTALLATION

Install the flywheel onto the crankshaft by aligning the key on the crankshaft with the groove in the flywheel.

- * Before installation, check and make sure that the inside of the flywheel is not contaminated.

Hold the flywheel with the flywheel holder and tighten the flywheel nut.

Torque: 34.3~39.2N-m

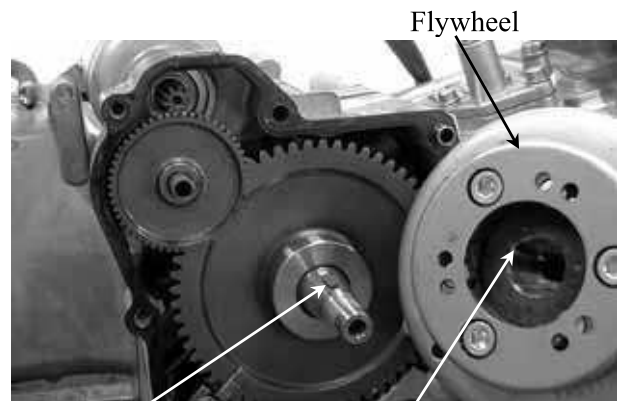

Key

Groove

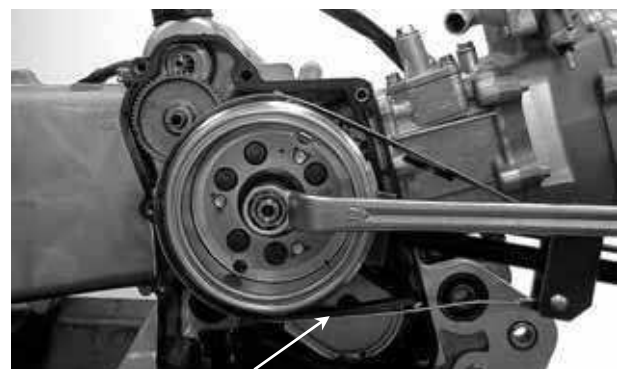

Flywheel Holder

10. A.C. GENERATOR/STARTER CLUTCH

STATOR INSTALLATION

Install the A.C. generator stator on the right crankcase cover and secure it with the three bolts.

Install the pulser coil on the right crankcase cover and secure it with the two screws.

Install the wire grommet in the groove in the right crankcase cover securely.

* Be sure to route the stator wire under the pulser coil.

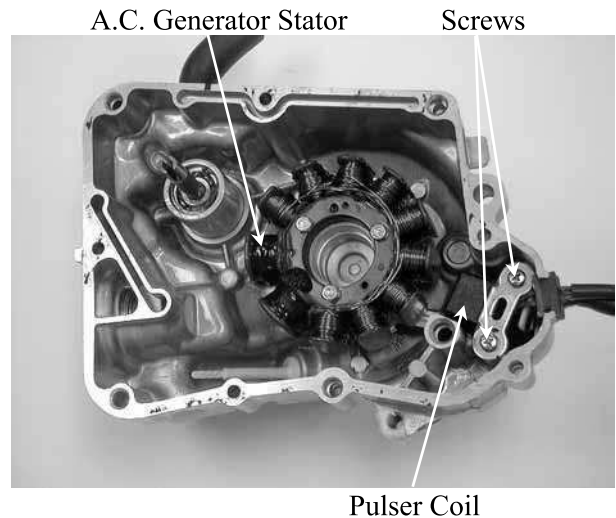

RIGHT CRANKCASE COVER INSTALLATION

Install the two dowel pins and a new gasket.

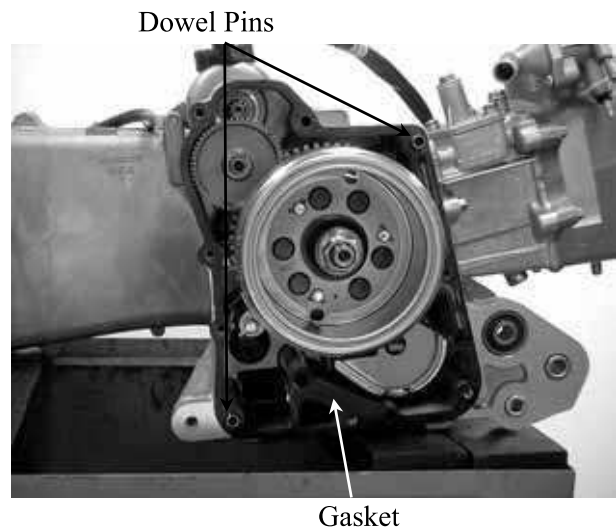

Install the right crankcase cover over the crankcase, aligning the water pump shaft groove with the oil pump shaft.

Tighten the nine right crankcase cover bolts. Connect the water hoses to the right crankcase cover.

Add the recommended engine oil. (⇒4-3)

Fill the cooling system with the specified coolant. (⇒3-9)

* Be sure to bleed air from the water jacket after filling the coolant.

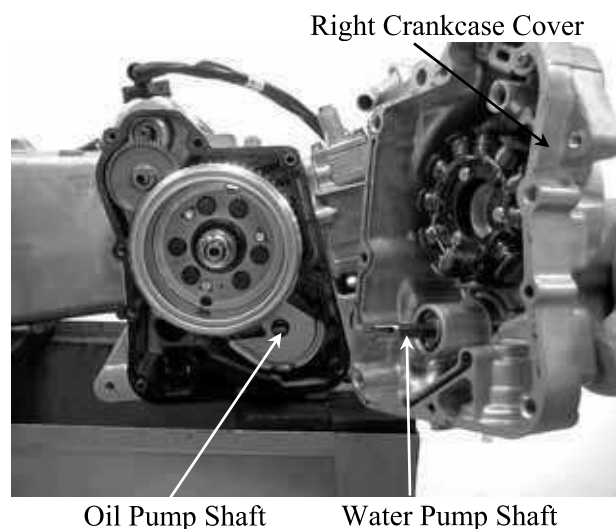

11. CRANKCASE/CRANKSHAFT

CRANKCASE/CRANKSHAFT

SCHEMATIC DRAWING -----	11-1
SERVICE INFORMATION-----	11-2
TROUBLESHOOTING-----	11-2
CRANKCASE SEPARATION -----	11-3
CRANKSHAFT -----	11-4
CRANKCASE ASSEMBLY -----	11-5

11. CRANKCASE/CRANKSHAFT

SCHEMATIC DRAWING

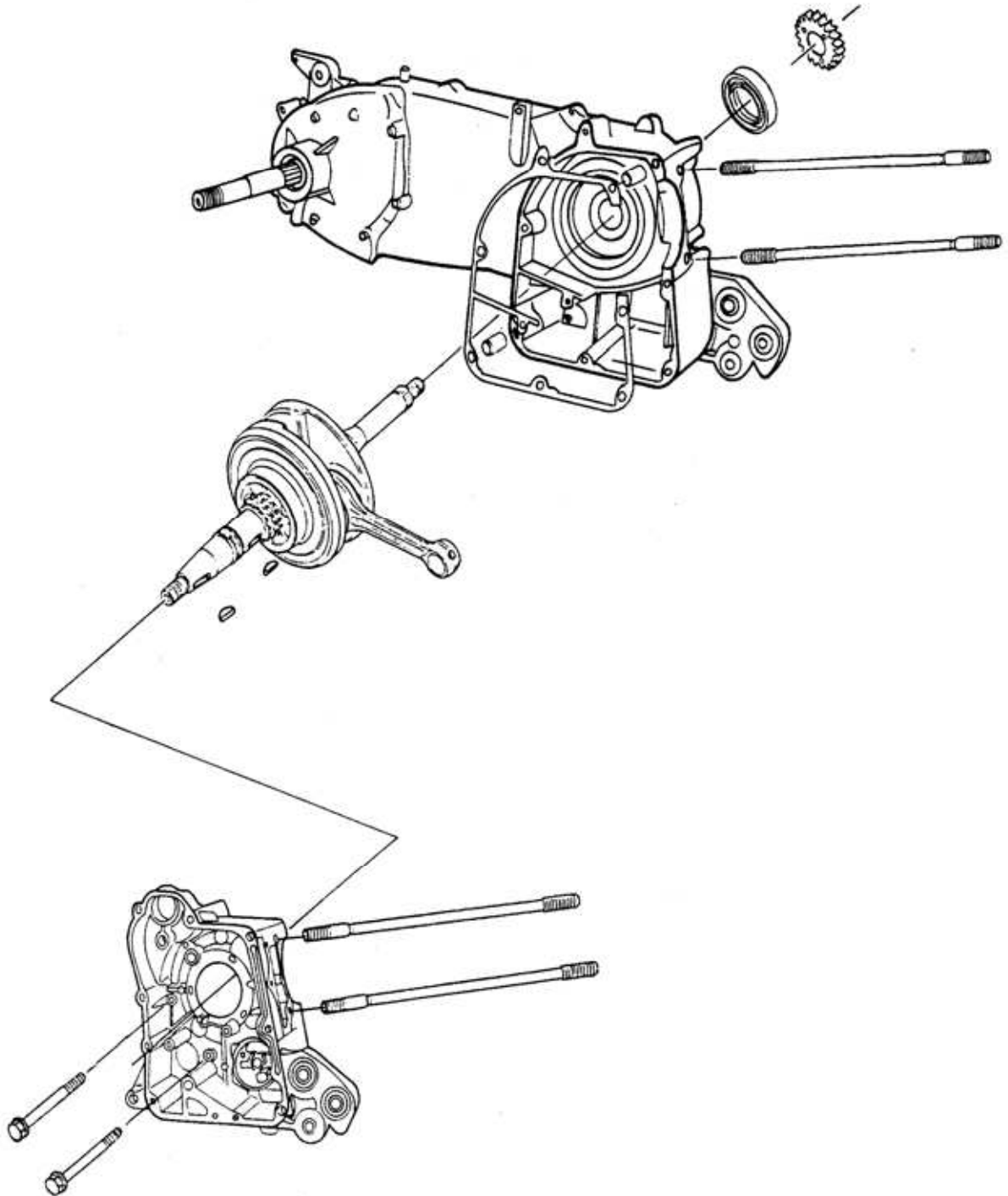

11. CRANKCASE/CRANKSHAFT

SERVICE INFORMATION

GENERAL INSTRUCTIONS

- This section covers crankcase separation to service the crankshaft. The engine must be removed for this operation.
- When separating the crankcase, never use a driver to pry the crankcase mating surfaces apart forcibly to prevent damaging the mating surfaces.
- When installing the crankcase, do not use an iron hammer to tap it.
- The following parts must be removed before separating the crankcase.
 - Cylinder head (⇒6-4)
 - Cylinder/piston (⇒7-3)
 - Right crankcase cover/drive and driven pulley (⇒8-3)
 - A.C. generator/starter clutch (⇒10-3)
 - Rear wheel/rear shock absorber (⇒15-4)
 - Starter motor (⇒19-3)
 - Oil pump (⇒4-4)

SPECIFICATIONS

	Item	Standard (mm)	Service Limit (mm)
Crankshaft	Connecting rod big end side clearance	0.15~0.35	0.6
	Connecting rod big end radial clearance	0.~0.008	0.05
	Runout	—	0.10

TORQUE VALUES

Crankcase bolt	7.8~10.8N-m
Cam chain tensioner slipper bolt	7.8~11.8N-m

SPECIAL TOOL

Gear remover

TROUBLESHOOTING

Excessive engine noise

- Excessive bearing play
- Excessive crankpin bearing play
- Worn piston pin and piston pin hole

11. CRANKCASE/CRANKSHAFT

CRANKCASE SEPARATION

Remove the cam chain tensioner slipper bolt.
 Remove the cam chain tensioner slipper and cam chain.
 Remove the two right crankcase attaching bolts.

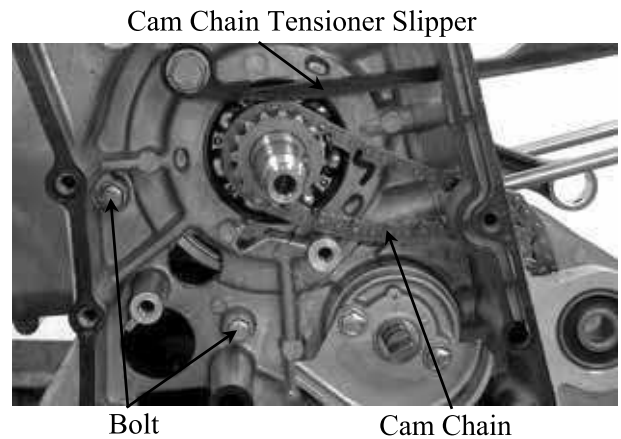

Remove the five left crankcase bolts.

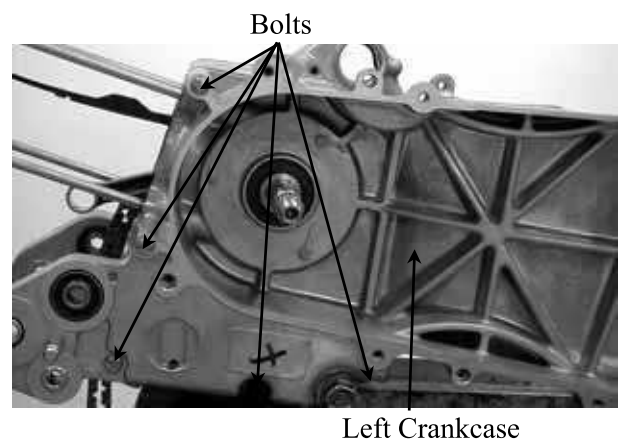

Place the crankcase with the left crankcase down and remove the right crankcase from the left crankcase.

* • Never use a driver to pry the crankcase mating surfaces apart.

Remove the gasket and dowel pins.

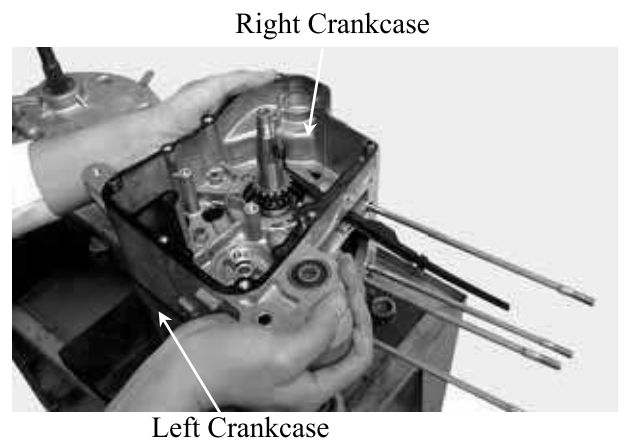

Remove the crankshaft from the left crankcase.

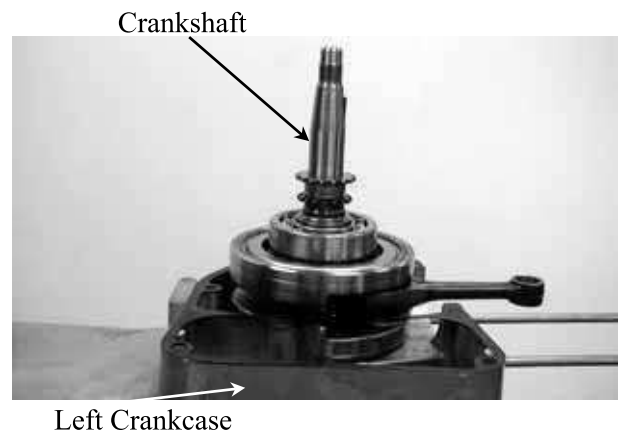

11. CRANKCASE/CRANKSHAFT

Remove the oil seal from the left crankcase.

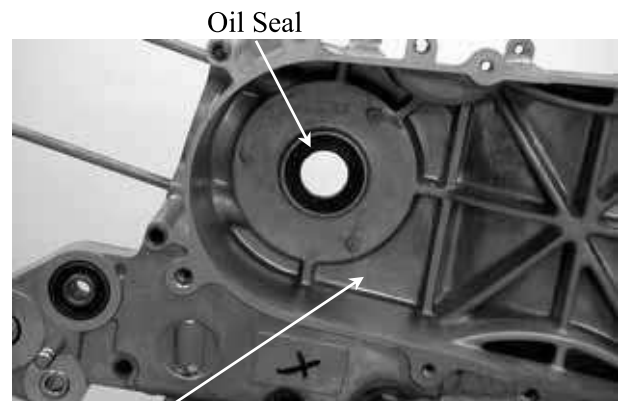

Left Crankcase

CRANKSHAFT INSPECTION

Measure the connecting rod big end side clearance.

Service Limit: 0.6mm replace if over



Measure the connecting rod small end I.D.

Service Limit: 15.06mm replace if over



11. CRANKCASE/CRANKSHAFT

Measure the crankshaft runout.

Service Limit: 0.10mm replace if over



Measure the crankshaft bearing play.

Service Limits:

Axial : 0.20mm replace if over

Radial: 0.05mm replace if over

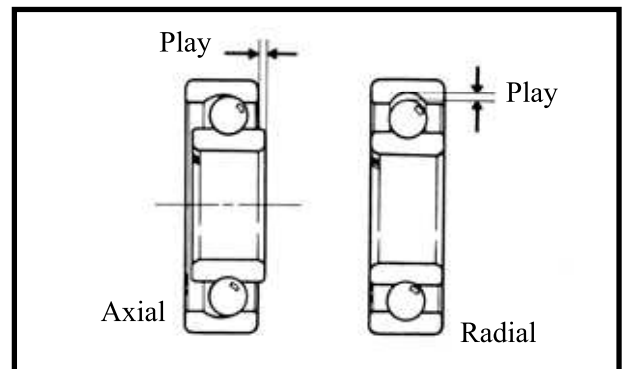

CRANKCASE ASSEMBLY

Clean off all gasket material from the crankcase mating surfaces.

- * Avoid damaging the crankcase mating surfaces.



Install a new oil seal into the left crankcase.

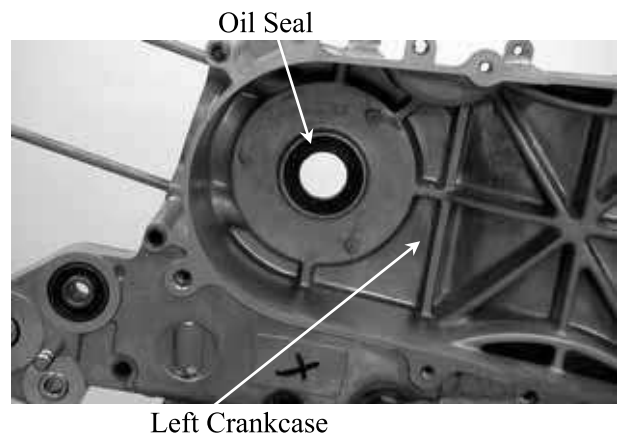

11. CRANKCASE/CRANKSHAFT

Place the left crankcase down and install the crankshaft into the left crankcase.

- *
 - Avoid damaging the oil seal.
 - Apply grease to the lip of the oil seal.



Install the two dowel pins and a new gasket.



Place the right crankcase over the crankshaft and onto the left crankcase.

- *
 - Install the right crankcase squarely and do not tap it with an iron or plastic hammer.

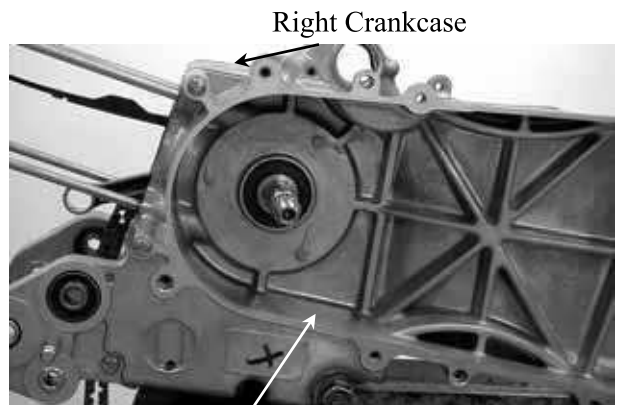

Install and tighten the right and left crankcase attaching bolts.

Torque: 7.8~10.8N-m

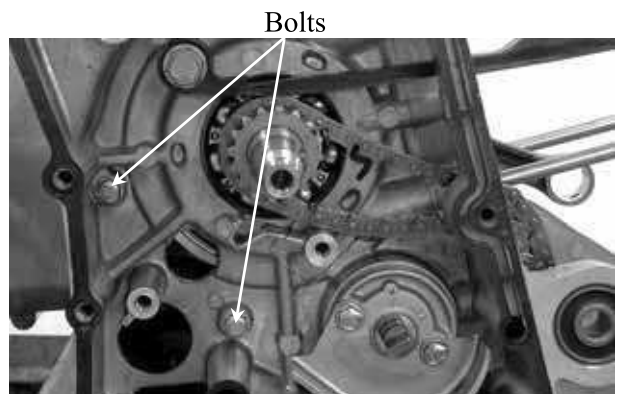

11. CRANKCASE/CRANKSHAFT

Install the cam chain.
Install the cam chain tensioner slipper.
Install and tighten the cam chain tensioner slipper bolt.

Torque: 7.8~11.8N-m

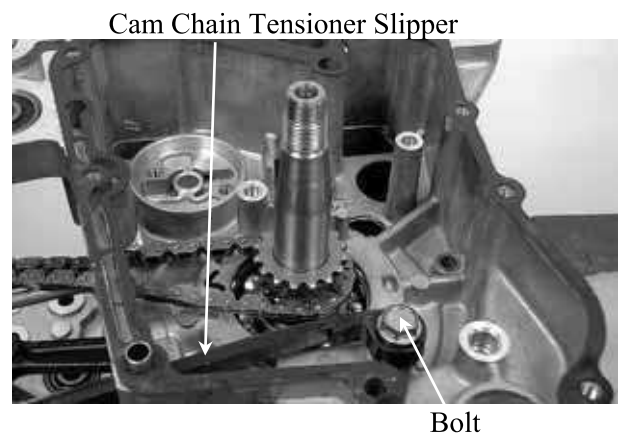

12. COOLING SYSTEM

COOLING SYSTEM

SCHEMATIC DRAWING -----	12- 1
SERVICE INFORMATION-----	12- 2
TROUBLESHOOTING-----	12- 2
COOLING SYSTEM TESTING-----	12- 4
RADIATOR -----	12- 4
WATER PUMP -----	12-10
THERMOSENSOR-----	12-16
THERMOSTAT-----	12-17

12. COOLING SYSTEM

SCHEMATIC DRAWING

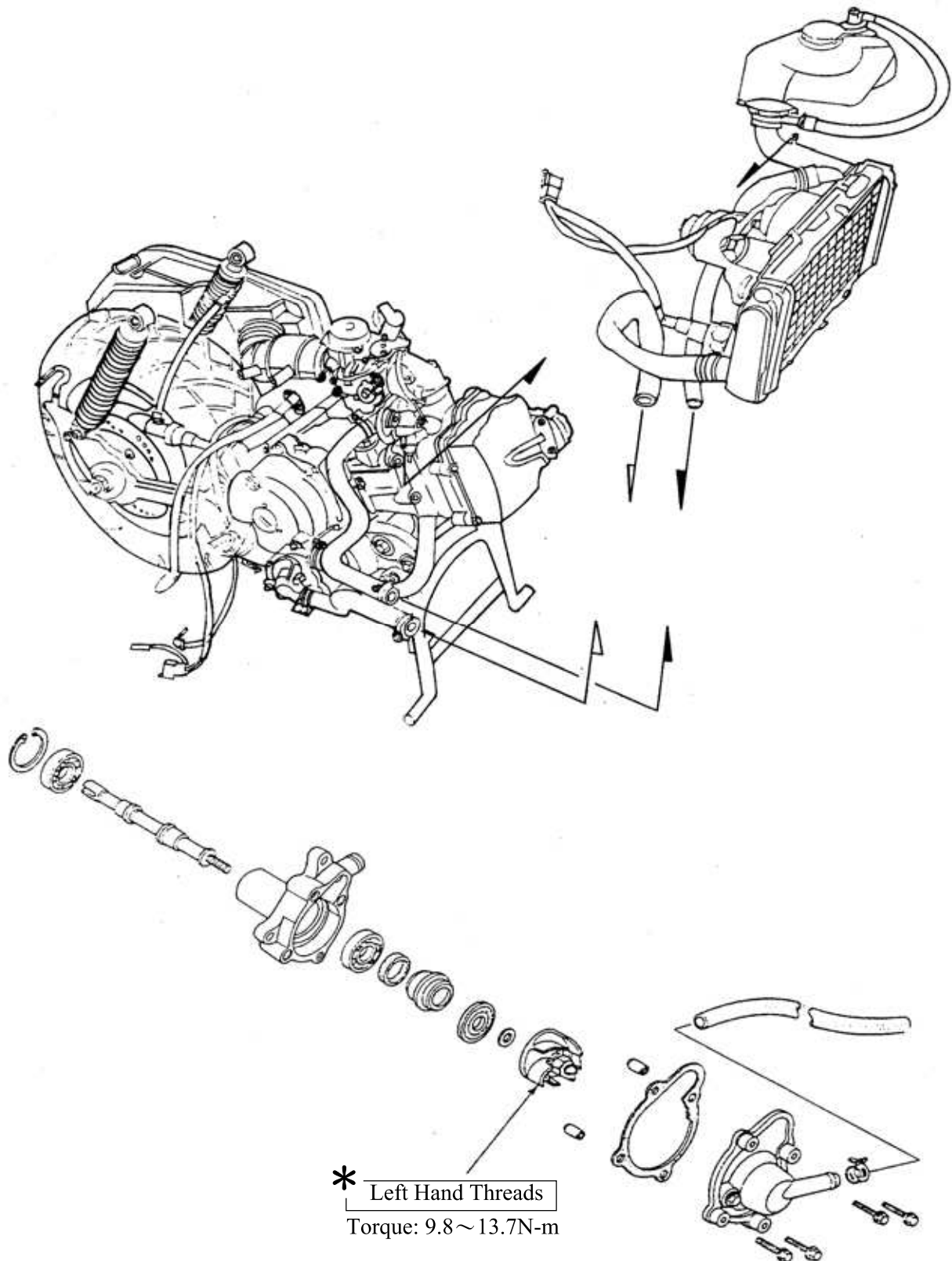

12. COOLING SYSTEM

SERVICE INFORMATION

GENERAL INSTRUCTIONS

- The water pump must be serviced after removing the engine. Other cooling system service can be done with the engine installed in the frame.
- The engine must be cool before servicing the cooling system.
When the coolant temperature is over 100°C, never remove the radiator cap to release the pressure because the boiling coolant may cause danger.
- Avoid spilling coolant on painted surfaces because the coolant will corrode the painted surfaces. Wash off any spilled coolant with fresh water as soon as possible.
- After servicing the system, check for leaks with a cooling system tester.

SPECIAL TOOL

Mechanical seal driver

TORQUE VALUES

Water pump impeller	9.8~13.7N-m
Water pump cover bolt	7.8~11.8N-m

TROUBLESHOOTING

Engine temperature too high

- Faulty temperature gauge or thermosensor
- Faulty radiator cap
- Faulty thermostat
- Insufficient coolant
- Passages blocked in hoses or water jacket
- Clogged radiator fins
- Passages blocked in radiator
- Faulty water pump

Temperature gauge pointer does not register the correct coolant temperature

- Faulty temperature gauge or thermosensor
- Faulty thermostat

Coolant leaks

- Faulty pump mechanical (water) seal
- Deteriorated O-rings
- Damaged or deteriorated water hoses

12. COOLING SYSTEM

SPECIFICATIONS

Radiator cap relief pressure		0.9±0.15kg/cm ²	
Thermostat temperature	Begins to open	80±2°C	
	Full-open	90°C	
	Valve lift	3.5~4.5mm	
Coolant capacity		Total system 1165cc	Radiator: 825cc Reserve tank: 340cc

COOLANT GRAVITY

Temp. °C Coolant concentration	0	5	10	15	20	25	30	35	40	45	50
5%	1.009	1.009	1.008	1.008	1.007	1.006	1.005	1.003	1.001	0.009	0.997
10%	1.018	1.107	1.017	1.016	1.015	1.014	0.013	1.011	1.009	1.007	1.005
15%	1.028	1.027	1.026	1.025	1.024	1.022	1.020	1.018	1.016	1.014	1.012
20%	1.036	1.035	1.034	1.033	1.031	1.029	1.027	1.025	1.023	1.021	1.019
25%	1.045	1.044	1.043	1.042	1.040	1.038	1.036	1.034	1.031	1.028	1.025
30%	1.053	1.051	1.051	1.049	1.047	1.045	1.043	1.041	1.038	1.035	1.032
35%	1.063	1.062	1.060	1.058	1.056	1.054	1.052	1.049	1.046	1.043	1.040
40%	1.072	1.070	1.068	1.066	1.064	1.062	1.059	1.056	1.053	1.050	1.047
45%	1.080	1.078	1.076	1.074	1.072	1.069	1.056	1.063	1.062	1.057	1.054
50%	1.086	1.084	1.082	1.080	1.077	1.074	1.071	1.068	1.065	1.062	1.059
55%	1.095	1.093	1.091	1.088	1.085	1.082	1.079	1.076	1.073	1.070	1.067
60%	1.100	1.098	1.095	1.092	1.089	1.086	1.083	1.080	1.077	1.074	1.071

COOLANT MIXTURE (WITH ANTI-RUST AND ANTI-FREEZING EFFECTS)

Freezing Point	Mixing Rate	KYMCO SIGMA Coolant Concentrate	Distilled Water
-9°C	20%		
-15°C	30%	360cc	825cc
-25°C	40%		
-37°C	50%		
-44.5°C	55%		

Cautions for Using Coolant:

- Use coolant of specified mixing rate. (The mixing rate of 360cc KYMCO SIGMA coolant concentrate + 825cc distilled water is 30%.)
- Do not mix coolant concentrate of different brands.
- Do not drink the coolant which is poisonous.
- The freezing point of coolant mixture shall be 5°C lower than the freezing point of the riding area.

12. COOLING SYSTEM

COOLING SYSTEM TESTING

RADIATOR CAP INSPECTION

Install the radiator cap onto the radiator tester and apply specified pressure to it. It must hold specified pressure for at least six seconds.

- * Apply water to the cap sealing surface before testing.

Radiator Cap Relief Pressure:

$0.9 \pm 0.15 \text{ kg/cm}^2$

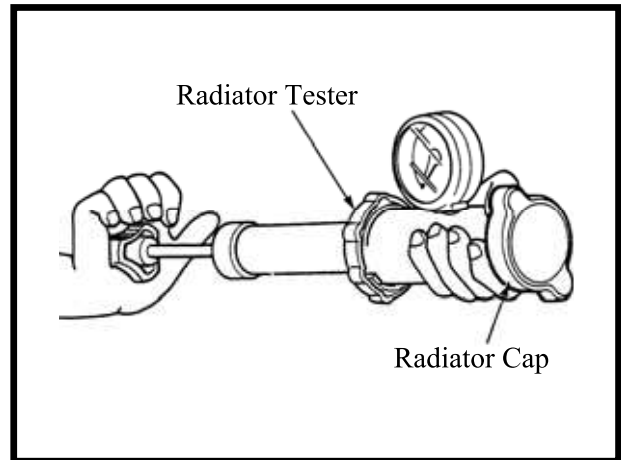

Install the radiator tester onto the radiator and apply specified pressure to it. It must hold specified pressure for at least six seconds.

Check the water hoses and connectors for leaks.

- * The test pressure should not exceed 1.05 kg/cm^2 . Excessive pressure can damage the radiator and its hose

RADIATOR

RADIATOR INSPECTION

Remove the front upper cover. (⇒2-5)

Remove the front lower cover. (⇒2-5)



12. COOLING SYSTEM

Inspect the radiator soldered joints and seams for leaks.

Blow dirt out from between core fins with compressed air. If insects, etc., are clogging the radiator, wash them off. Carefully straighten any bent fins.

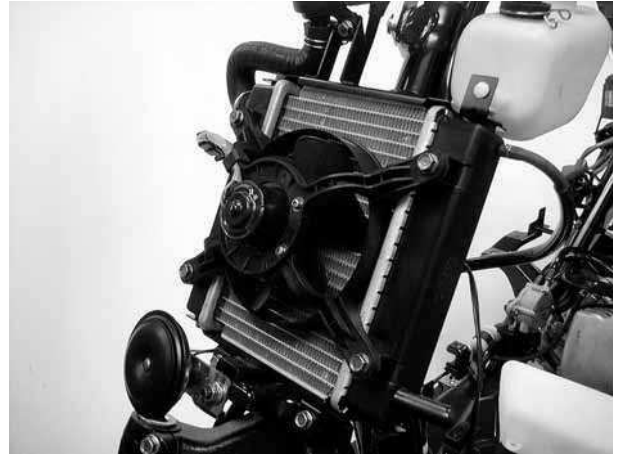

RADIATOR REMOVAL

Drain the coolant. (⇒3-9)

Disconnect the air vent tube from the radiator filler.

Remove the overflow tube clamp and disconnect the overflow tube.



Loosen the hose band and disconnect the upper hose and lower hose from the radiator.

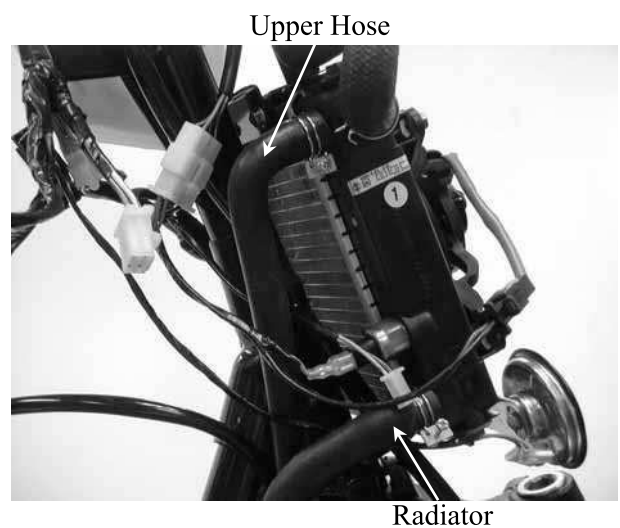

12. COOLING SYSTEM

Disconnect the thermostatic switch wire coupler.
Disconnect the fan motor wire coupler.

Thermostatic Switch Wire Thermostatic Switch



Fan Motor Wire Coupler

Remove the two bolts and two nuts on the radiator.

Radiator



Nuts

Bolts

RADIATOR DISASSEMBLY

Remove the four bolts and then remove the fan/shroud from the radiator.

Fan/Shroud

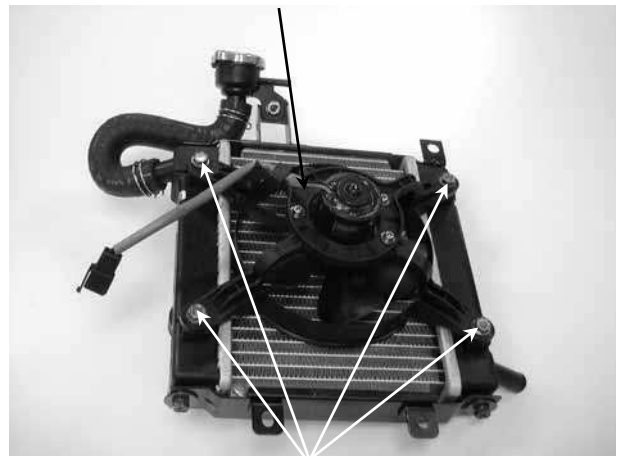

Bolts

12. COOLING SYSTEM

Check fan motor by battery.

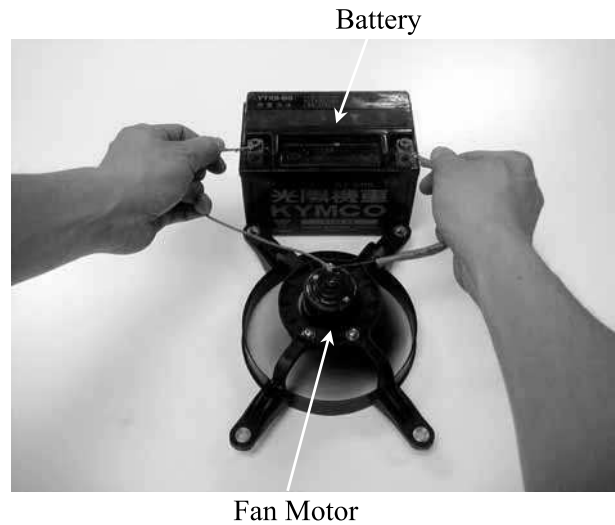

CHECK THERMOSTATIC SWITCH

When coolant temperature lower than $85\sim 90^{\circ}\text{C}$ the thermostatic switch OFF.
When coolant temperature over $85\sim 90^{\circ}\text{C}$ the thermostatic switch ON.

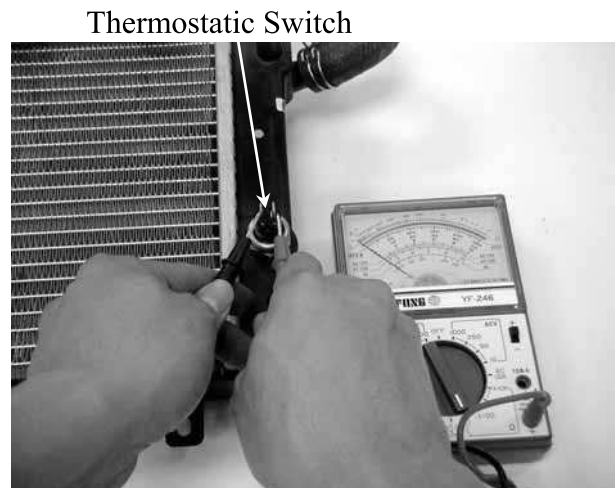

Install the fan shroud on the radiator with the four bolts.

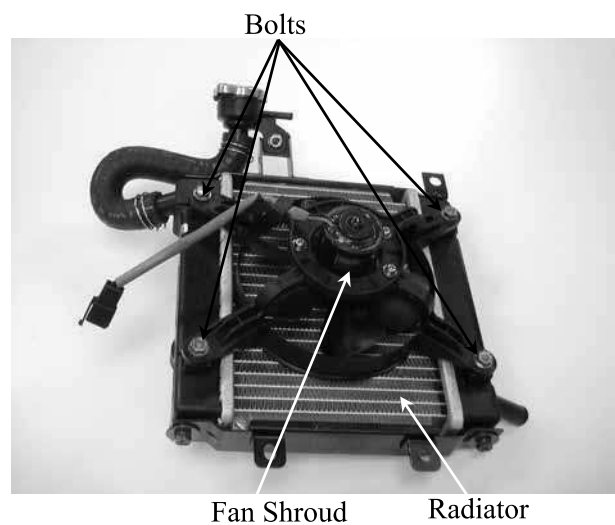

12. COOLING SYSTEM

RADIATOR INSTALLATION

Install the radiator on the radiator bracket with the two bolts and two nuts.

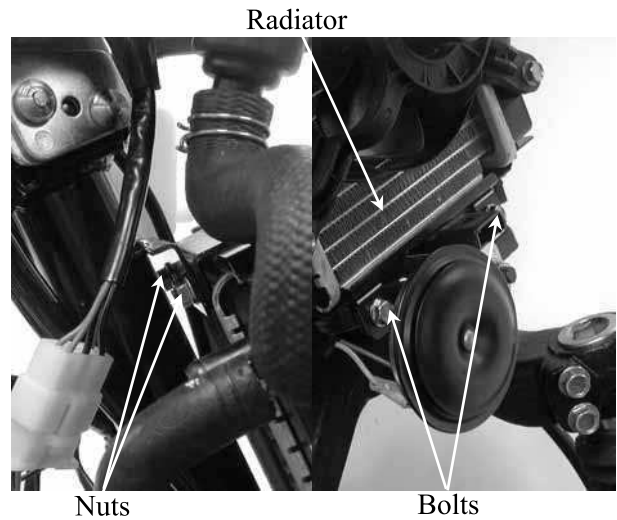

Connect the upper and lower hoses and secure them with hose bands. Connect the thermostatic switch wire and fan motor wire couplers.

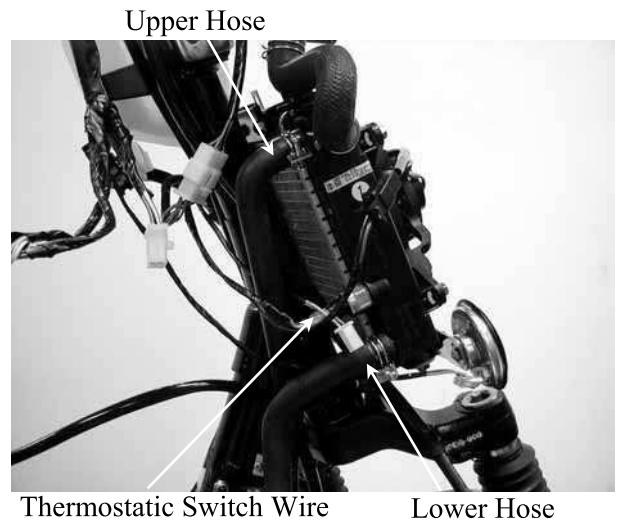

Connect the overflow tube and secure with the tube clamp. Connect the vent tube to the radiator filler. Fill the radiator with coolant. (⇒3-9) After installation, check for coolant leaks.



12. COOLING SYSTEM

Install the front upper cover.



WATER PUMP

MECHANICAL SEAL (WATER SEAL) INSPECTION

Inspect the telltale hole for signs of mechanical seal coolant leakage. If the mechanical seal is leaking, remove the right crankcase cover and replace the mechanical seal.

Right Crankcase Cover

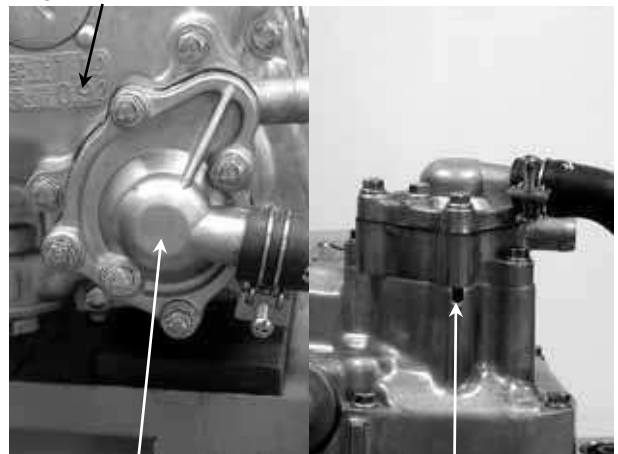

Water Pump

Telltale Hole

WATER PUMP/IMPELLER REMOVAL

Remove the coolant inlet hose and outlet hose.

Outlet Hose

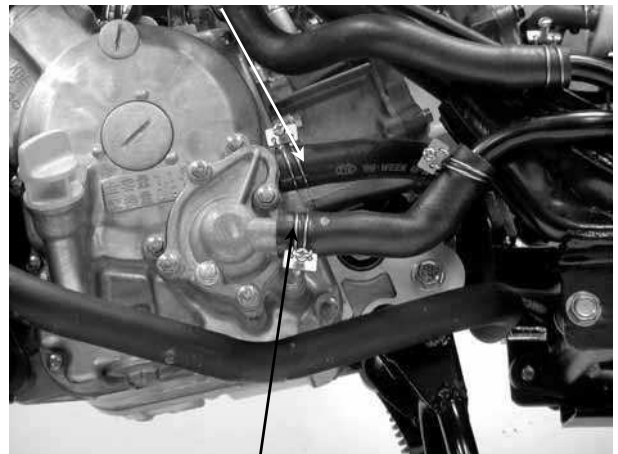

Inlet Hose

12. COOLING SYSTEM

Remove the four bolts and the water pump cover, gasket and 2 dowel pins.

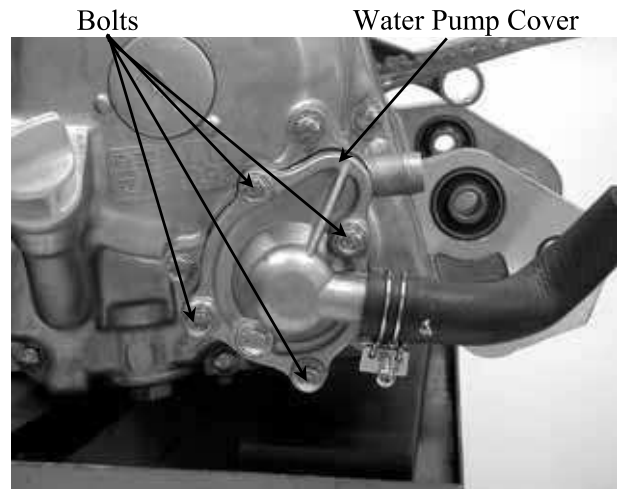

Remove the water pump impeller.

* The impeller has left hand threads.



Inspect the mechanical (water) seal and seal washer for wear or damage.

* The mechanical seal and seal washer must be replaced as a set.

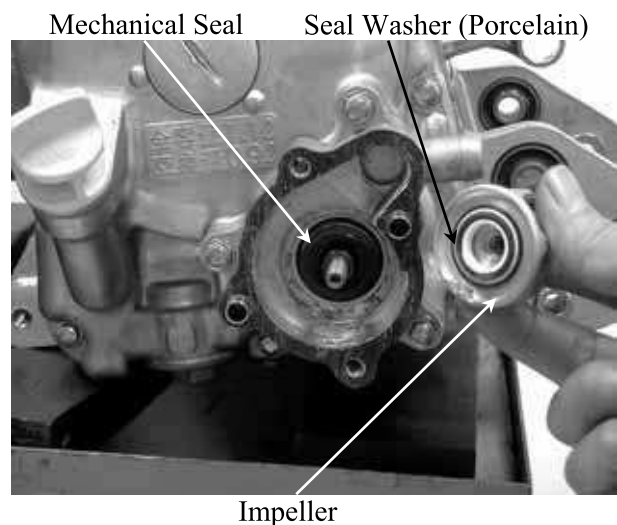

12. COOLING SYSTEM

WATER PUMP SHAFT REMOVAL

Disconnect the water hose from the right crankcase cover.

Remove the 3 bolts attaching the water pump assembly.

Remove the water pump assembly, gasket and dowel pins.

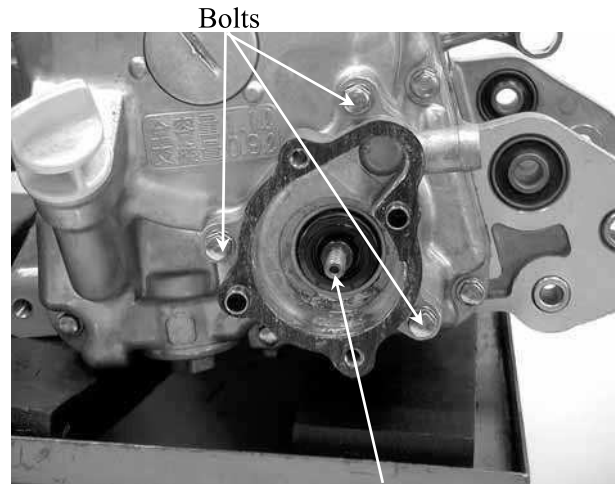

Water Pump Assembly

Remove the water pump bearing snap ring from the water pump assembly.
Remove the water pump shaft and shaft inner bearing.

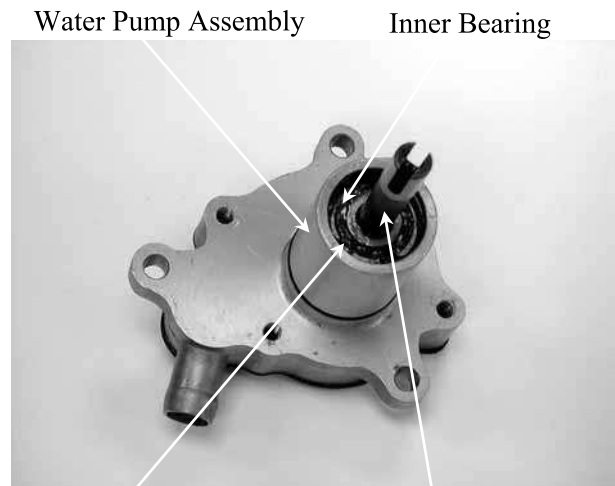

Snap Ring

Water Pump Shaft

Remove the water pump shaft outer bearing.

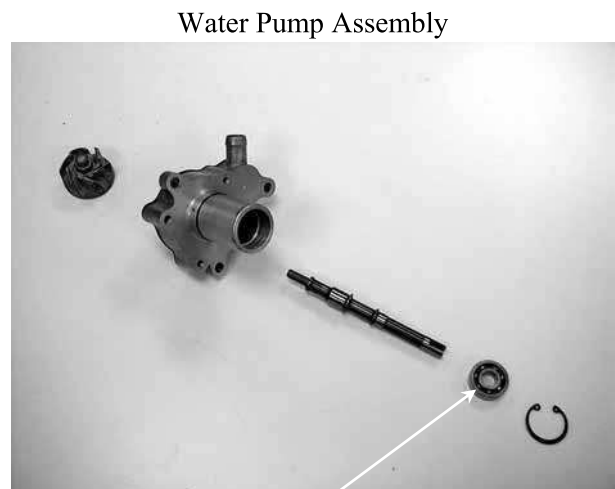

Inner Bearing

12. COOLING SYSTEM

MECHANICAL SEAL REPLACEMENT

Drive the mechanical seal out of the water pump assembly from the inside.

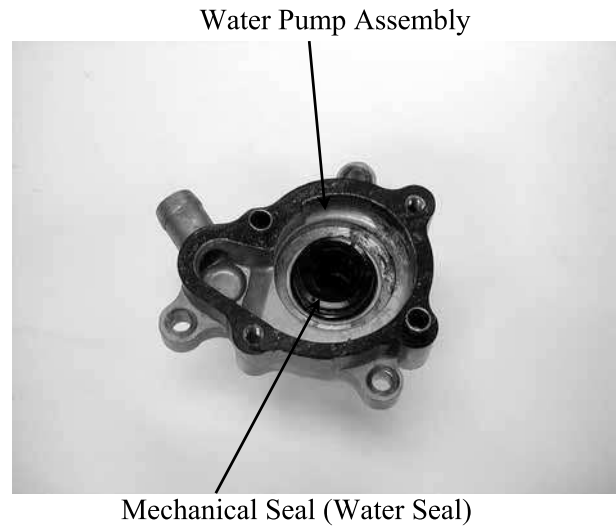

Drive in a new mechanical seal using a mechanical seal driver.

* Apply sealant to the right crankcase cover fitting surface of a new mechanical seal and then drive in the mechanical seal.

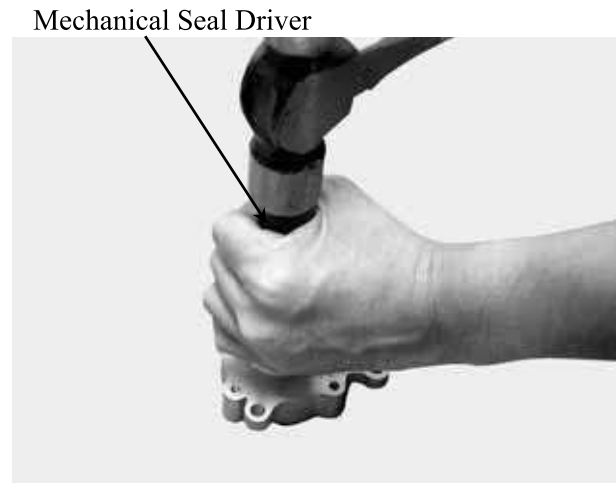

WATER PUMP SHAFT INSTALLATION

Drive a new water pump shaft outer bearing into the water pump assembly from the inside.

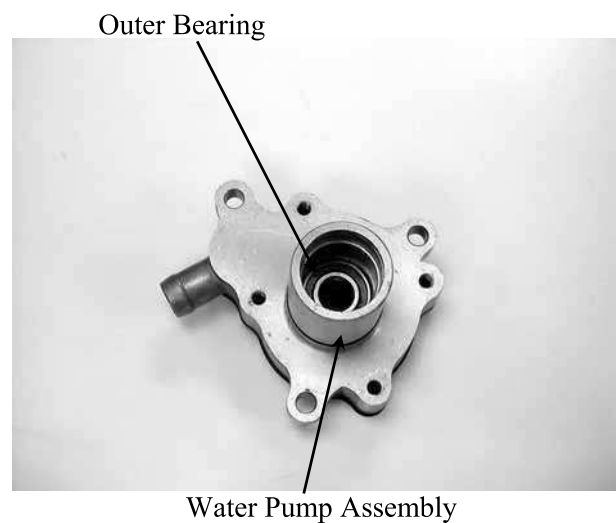

12. COOLING SYSTEM

Install the water pump shaft and shaft inner bearing into the water pump assembly. Install the snap ring to secure the inner bearing properly.

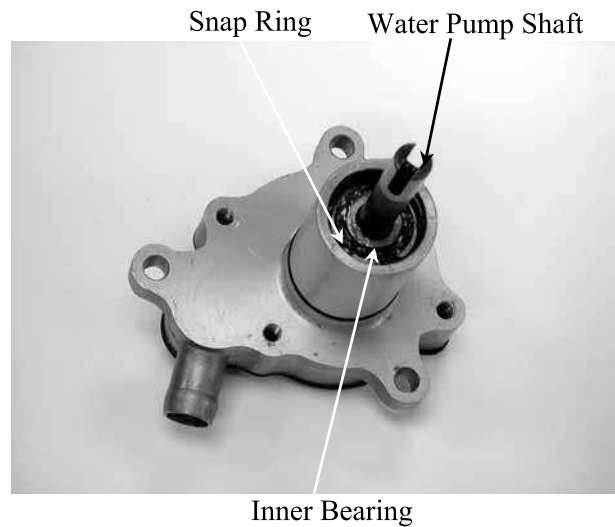

Install the dowel pins and a new gasket and then install the water pump assembly to the right crankcase cover. Tighten the 3 bolts to secure the water pump assembly.

* When installing the water pump assembly, aligning the groove on the water pump shaft with the tab on the oil pump shaft.

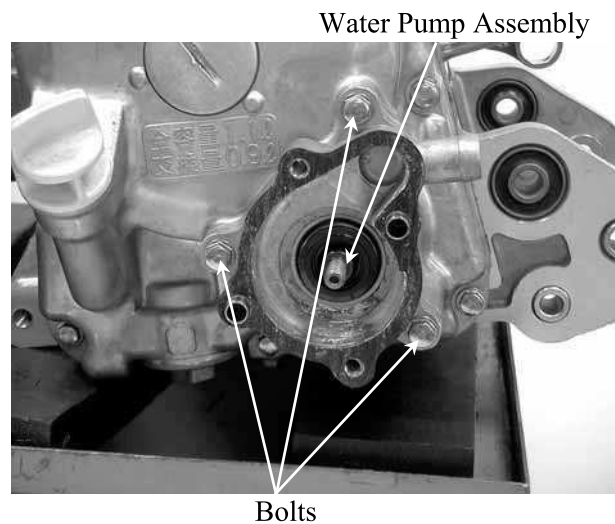

WATER PUMP/IMPELLER INSTALLATION

When the mechanical seal is replaced, a new seal washer must be installed to the impeller.

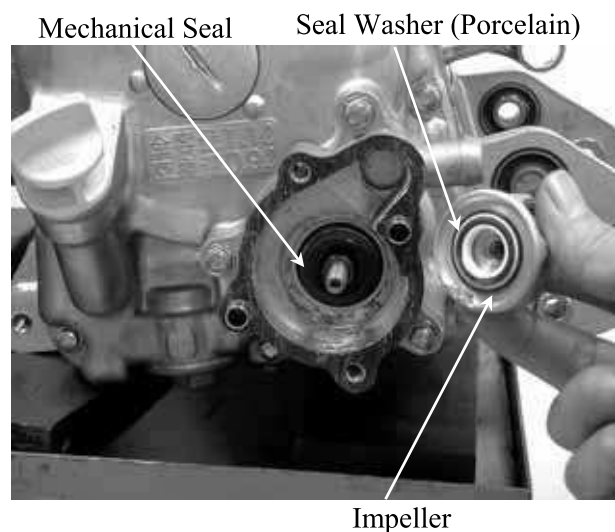

12. COOLING SYSTEM

Install the impeller onto the water pump shaft.

Torque: 9.8~13.7N-m

* The impeller has left hand threads.

Impeller (Left Hand Threads)

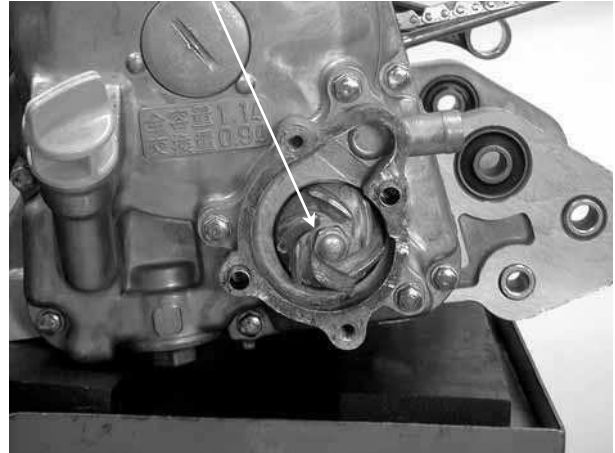

Install the two dowel pins and a new gasket.

Dowel Pins

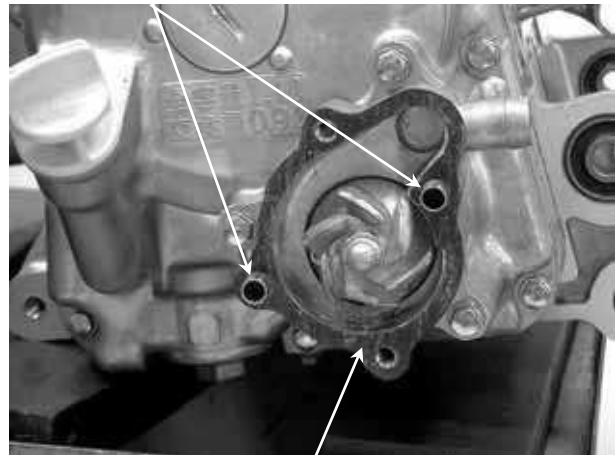

Gasket

Install the water pump cover and tighten the 4 bolts.

Torque: 7.8~11.8N-m

Water Pump Cover

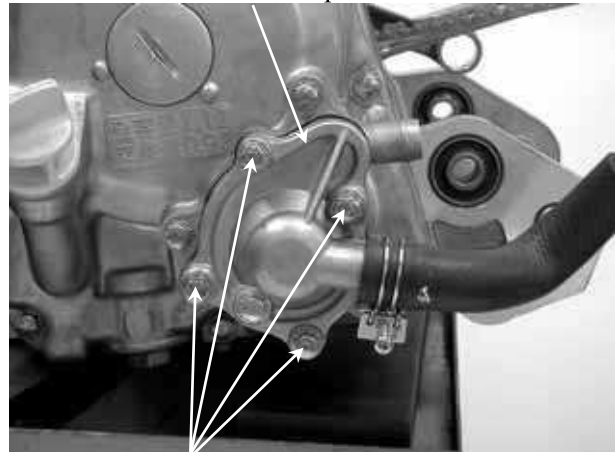

Bolt

12. COOLING SYSTEM

THERMOSENSOR

THERMOSENSOR REMOVAL

- Remove the seat, met-in box and center cover.
- Drain the coolant.
- Disconnect the thermosensor wire.
- Remove the thermosensor.

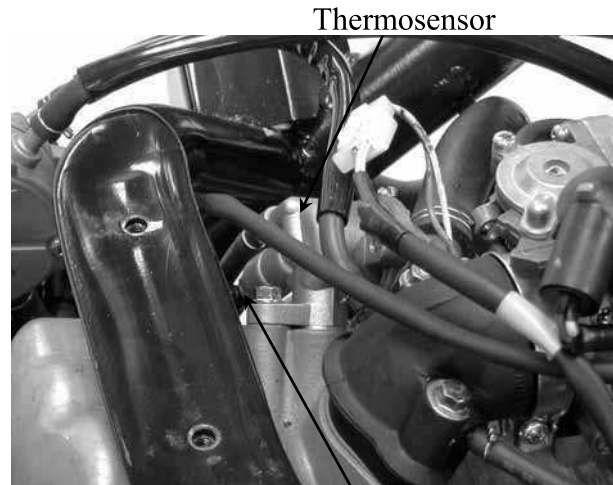

Thermosensor

Thermosensor Wire

THERMOSENSOR INSPECTION

Suspend the thermosensor in a pan of water over a burner and measure the resistance through the sensor as the water heats up.

Temperature(°C)	50	80	100	120
Resistance(Ω)	154	52	27	16

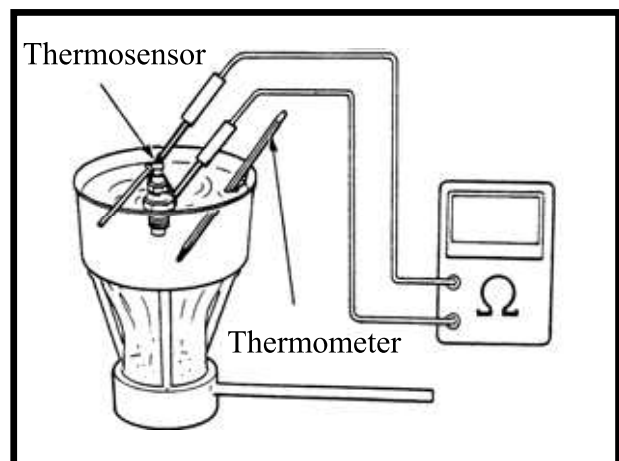

THERMOSENSOR INSTALLATION

- Apply 3-BOND No. 1212 sealant or equivalent to the thermosensor threads and install it into the thermostat housing.
- Connect the thermosensor wire.
- Fill the radiator with coolant. (⇒3-9)
- Install the center cover, met-in box and seat. (⇒2-3)

* Be sure to bleed air from the cooling system.



Thermosensor Wire

Thermosensor

12. COOLING SYSTEM

THERMOSTAT

THERMOSTAT REMOVAL

- Remove the seat, met-in box and center cover.
- Drain the coolant.
- Disconnect the thermosensor wire from the thermosensor.
- Disconnect the water hose from the thermostat housing.
- Disconnect the air vent tube from the thermostat housing.
- Remove the mounting bolt and the thermostat housing from the cylinder head.

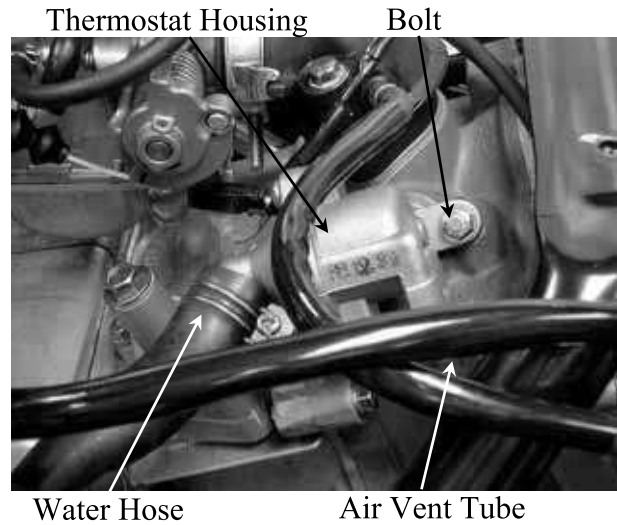

Remove the two bolts and separate the thermostat housing halves.

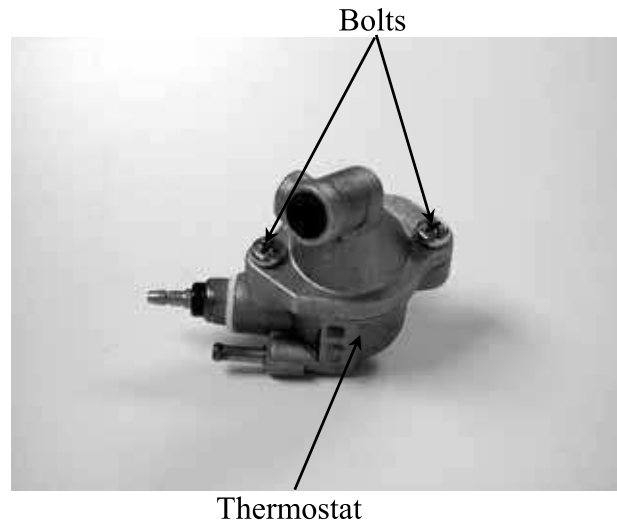

Remove the thermostat from the thermostat housing.

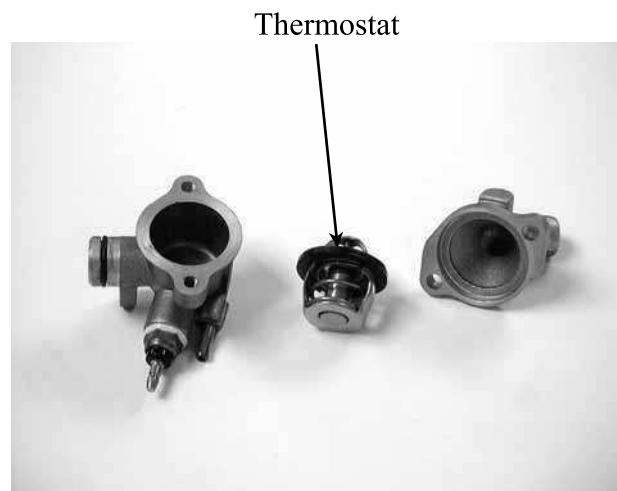

12. COOLING SYSTEM

THERMOSTAT INSPECTION

Suspend the thermostat in a pan of water over a burner and gradually raise the water temperature to check its operation.

Technical Data

Begins to open	80±2°C
Full-open	90°C
Valve lift	3.5~4.5mm

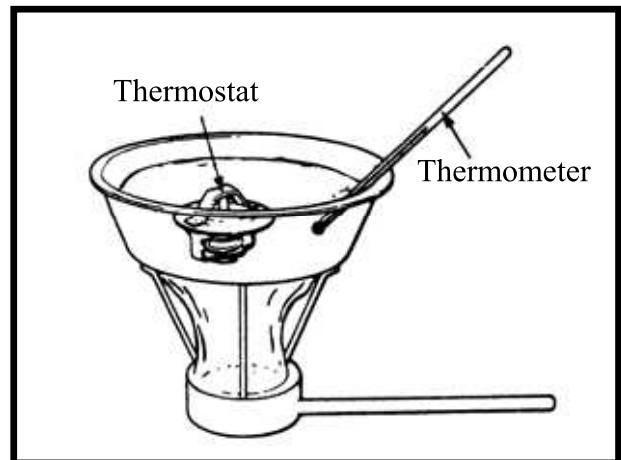

- * Do not let the thermostat touch the pan as it will give a false reading.
- * Replace the thermostat if the valve stays open at room temperature.
- * Test the thermostat after it is opened for about 5 minutes and holds the temperature at 70°C.

THERMOSTAT INSTALLATION

The installation sequence is the reverse of removal.

- * Replace the O-ring with a new one and apply grease to it.

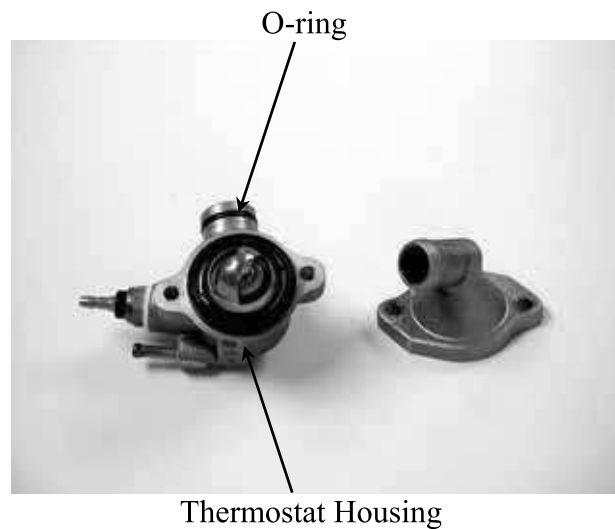

Fill the cooling system with the specified coolant. (⇒3-9)



13. FUEL SYSTEM/CARBURETOR/ FUEL PUMP/ FUEL TANK

FUEL SYSTEM

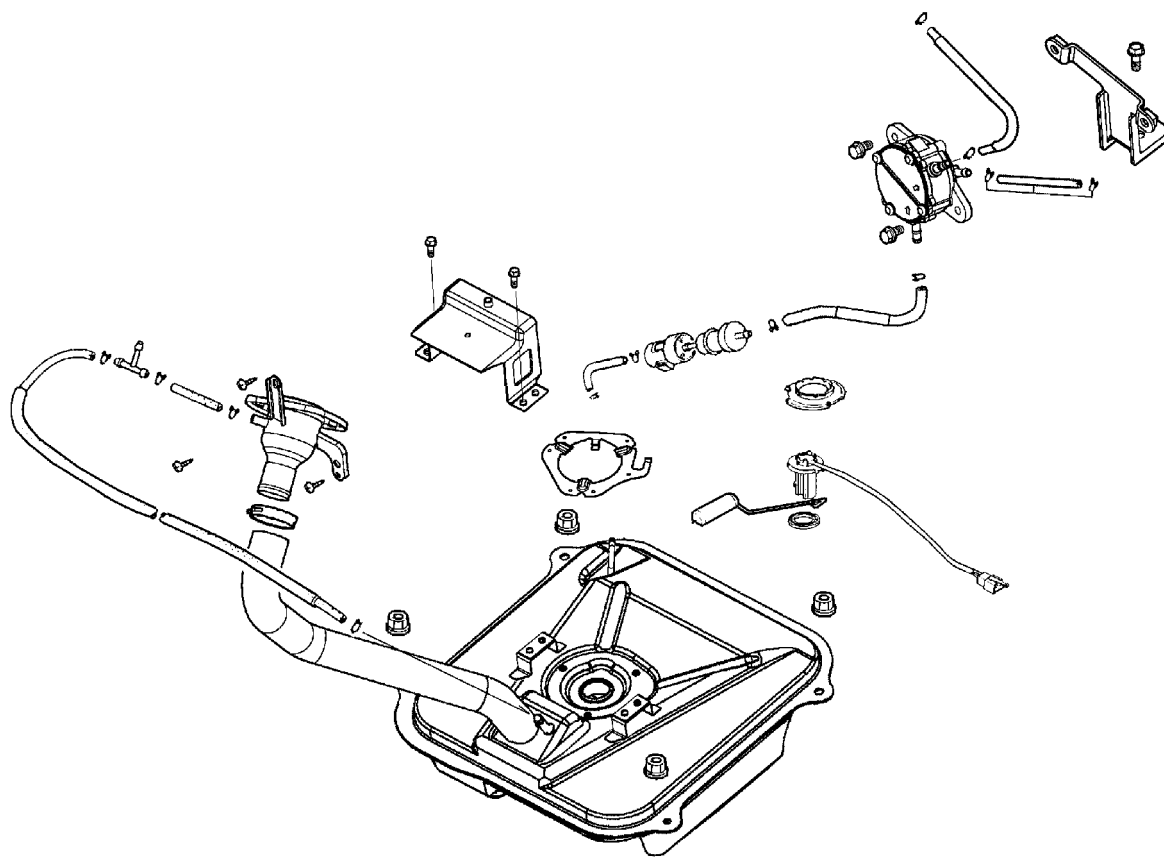

SCHEMATIC DRAWING

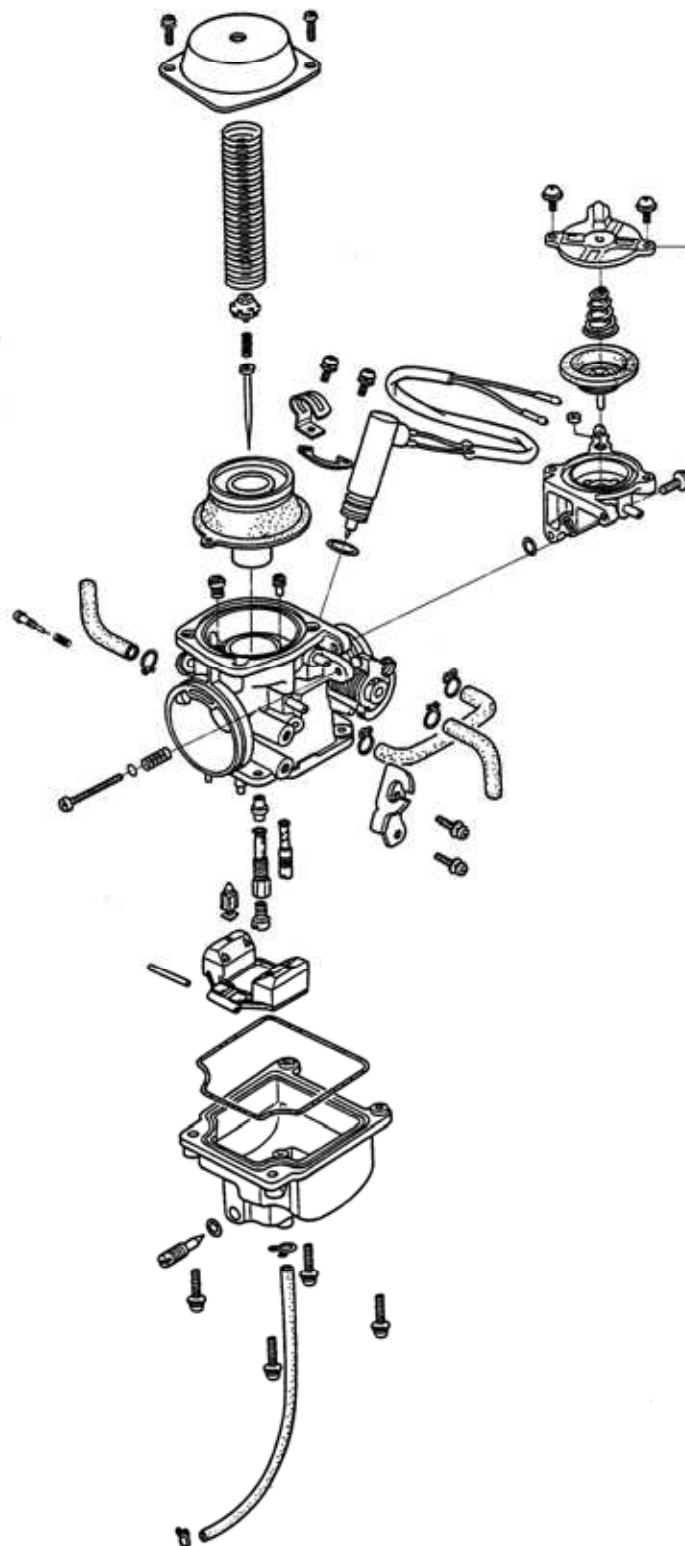

OPERATION OF CARBURETOR JETS

1. LOW SPEED

- ※ Air — [Venturi (slightly opened throttle valve)] — Air Bleed Holes → Mixture.....
- Low Speed Air Inlet
- ※ Fuel in Float Chamber → Slow Jet
- Low Speed Small Jet Holes

2. MIDDLE SPEED

- ※ Air — [Venturi (halfway opened throttle valve)] — Air Bleed Holes → Mixture.....
- High Speed Air Jet
- ※ Fuel in Float Chamber → Main Jet
- Main Jet (The slow jet also works.)

Low & Middle Speed Supplementary Device:

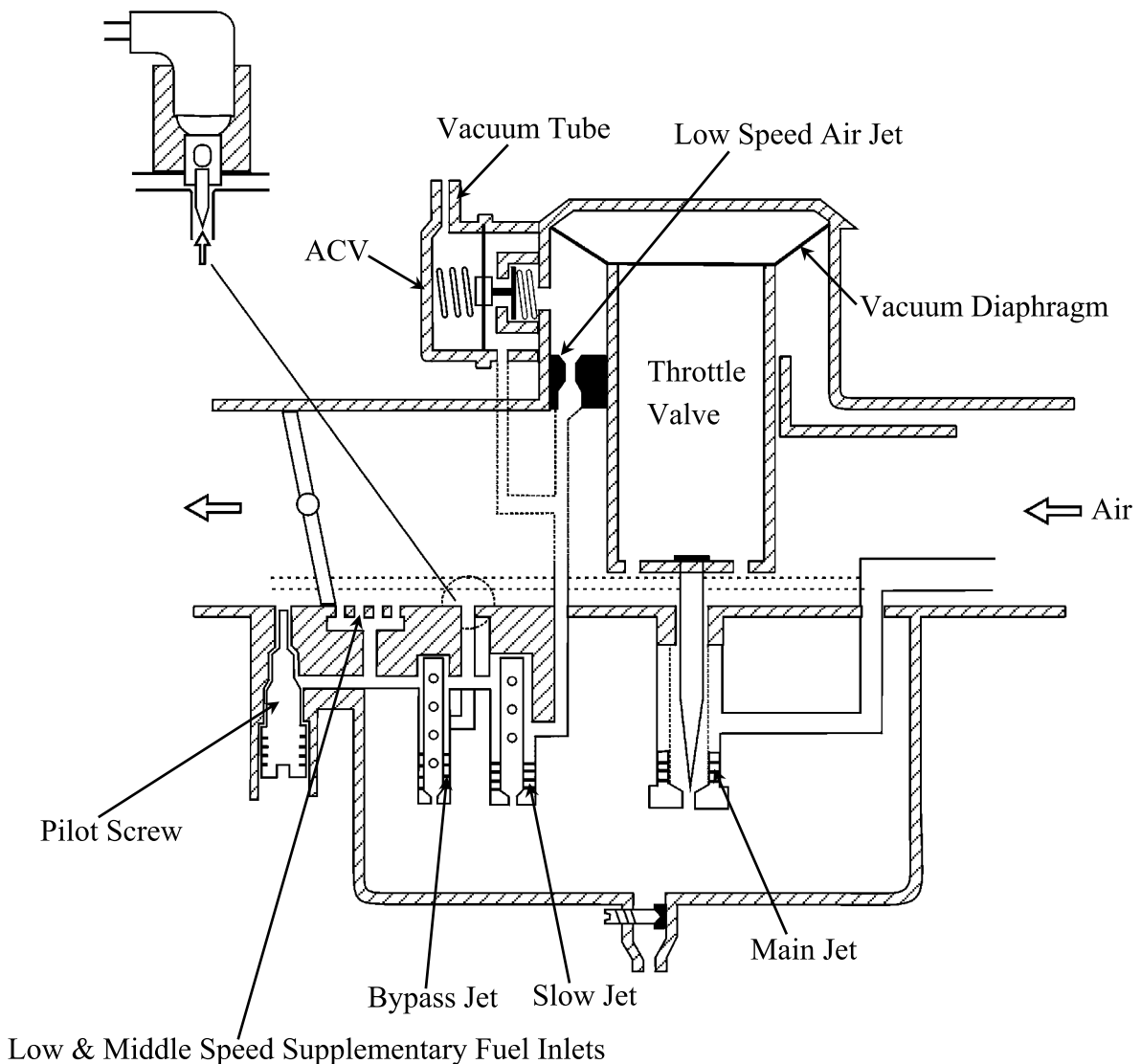

FUEL PUMP

CONSTRUCTION:

The fuel pump adopted for this model is a vacuum-type fuel pump which utilizes the positive and negative pulsating pressures produced by the engine crankcase to control the oil pump diaphragms and deliver fuel from the fuel tank to the carburetor through the suction valve and outlet valve.

FUEL PUMP CONSTRUCTION

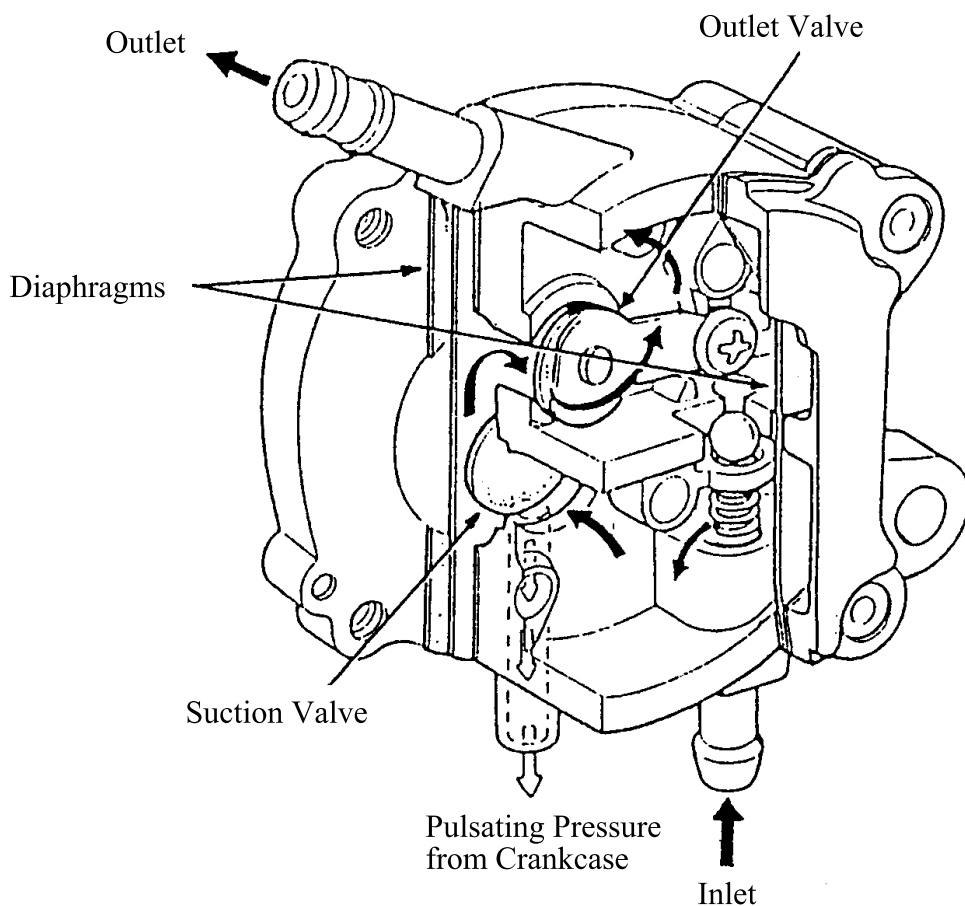

SERVICE INFORMATION

GENERAL INSTRUCTIONS

- When working with gasoline, keep away from sparks and flames.
- Note the locations of O-rings when disassembling and replace them with new ones during assembly.
- Before float chamber disassembly, drain the residual gasoline from the float chamber.
- Do not try to disassemble the auto bystarter.
- When assembling the vacuum chamber and air cut-off valve, be careful not to damage the diaphragms.
- All cables, fuel lines and wires must be routed and secured at correct locations.
- When removing the fuel tank, keep sparks and flames away from the working area.
- When removing the fuel tank, the remaining fuel in the tank must be lower than $\frac{1}{2}$ of the fuel tank capacity to avoid gasoline overflowing.
- Fuel tank capacity: 10.5 liters

SPECIFICATIONS

	125cc	150cc
Venturi dia. (mm)	VE26	VE26
Identification number	VE060A	VE061A
Float level (mm)	18.5	18.5
Pilot screw opening	1 3/4	1 3/4
Main jet	100#	100#
Slow jet	35#	35#
Idle speed	1600	1600
Fuel pump output	17L/Hr/7000rpm	17L/Hr/7000rpm

SPECIAL TOOLS

Float level gauge

Fuel unit remover

TROUBLESHOOTING

Engine does not start

- No fuel in tank
- Restricted fuel line
- Too much fuel getting to cylinder
- Clogged air cleaner
- Contaminated fuel
- Faulty fuel pump

Engine idles roughly, stalls or runs poorly

- Incorrect idle speed
- Rich mixture
- Lean mixture
- Clogged air cleaner
- Intake air leak
- Contaminated fuel
- Faulty air-cut off valve
- Damaged vacuum tube and connectors
- Damaged carburetor insulator

Throttle does not open fully, so engine stalls

- Damaged vacuum piston diaphragm
- Clogged diaphragm hole

Lean mixture

- Clogged fuel jets
- Clogged fuel tank cap breather hole
- Clogged fuel filter
- Bent, kinked or restricted fuel line
- Faulty float valve
- Float level too low
- Faulty fuel pump or insufficient output

Rich mixture

- Auto bystarter valve opens excessively
- Faulty float valve
- Float level too high
- Clogged air jets
- Auto bystarter valve set plate installed in the wrong groove
- Clogged air cleaner

Engine is hard to start

- No fuel in tank
- Restricted fuel line
- Clogged fuel strainer
- Faulty fuel pump
- Broken or clogged vacuum tube
- Faulty or clogged charcoal canister

Lean mixture

- Clogged charcoal canister
- Bent, kinked or restricted fuel line
- Clogged fuel strainer
- Float level too low

CARBURETOR REMOVAL

Remove the seat, met-in box and center cover.
Disconnect the fuel tube and vacuum tube at the carburetor.
Disconnect the auto bystarter wire.

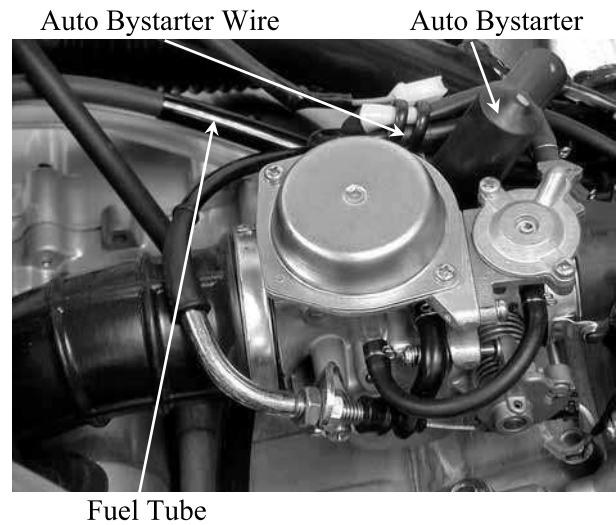

Loosen the throttle cable adjusting nut and lock nut, and disconnect the throttle cable from the carburetor.
Loosen the air cleaner connecting tube band and carburetor intake manifold band and then remove the carburetor.



VACUUM CHAMBER DISASSEMBLY

Loosen the drain screw and drain the fuel from the float chamber.

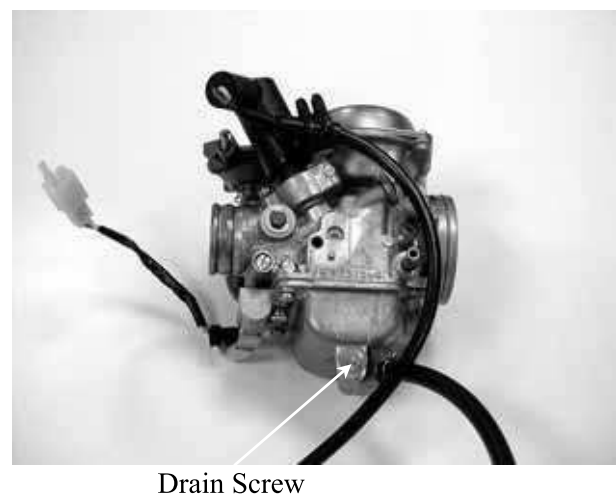

13. FUEL SYSTEM/CARBURETOR/ FUEL PUMP/ FUEL TANK

Remove the two vacuum chamber cover screws and the cover.

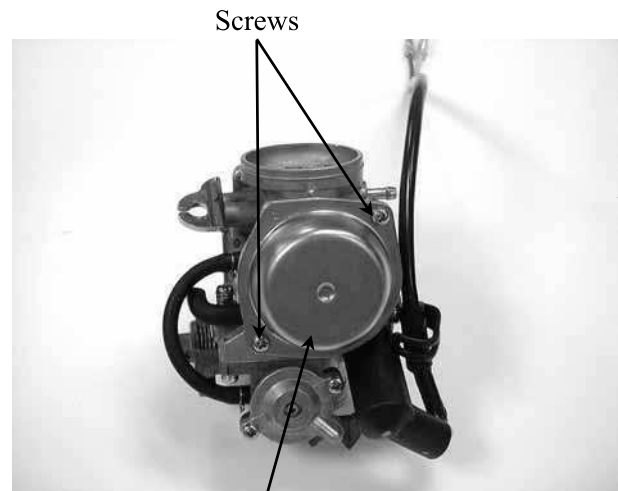

Vacuum Chamber Cover

Remove the compression spring and vacuum piston.

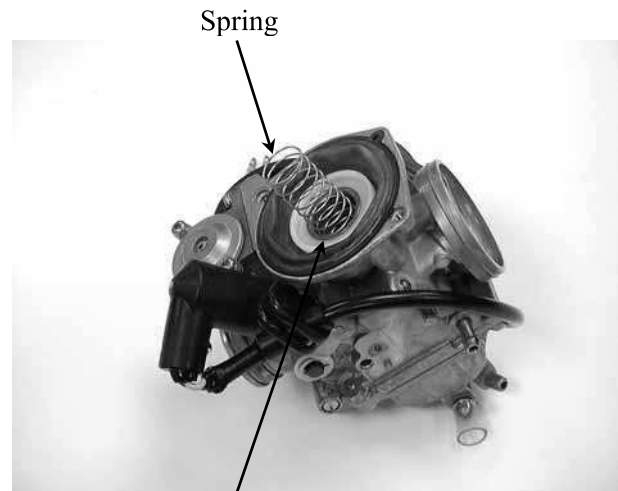

Vacuum Piston

Remove the needle holder, spring and jet needle from the piston.

- * Be careful not to damage the vacuum piston diaphragm.

VACUUM PISTON INSPECTION

Inspect the vacuum piston and jet needle for wear or damage.
Inspect the diaphragm for deterioration and tears.

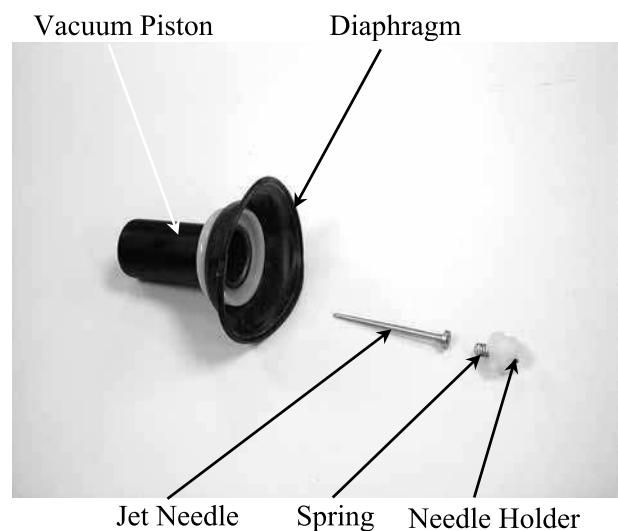

FLOAT CHAMBER DISASSEMBLY

Remove the four float chamber screws and the float chamber.

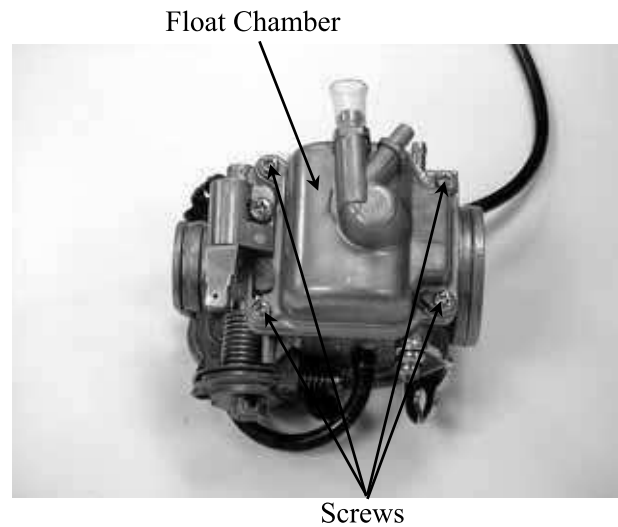

Remove the float pin, float and float valve.

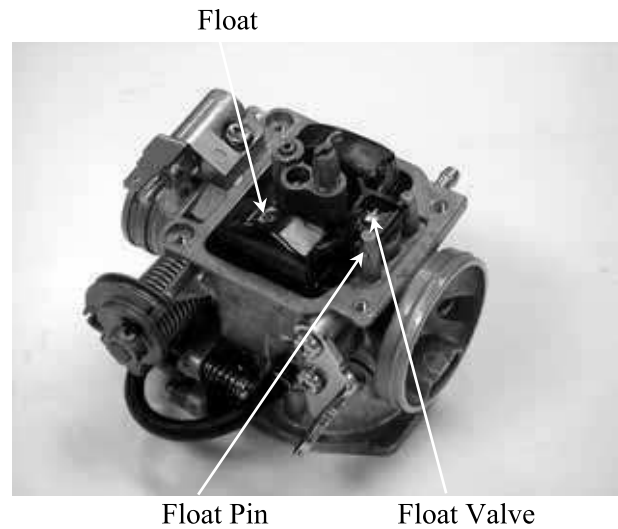

FLOAT VALVE INSPECTION

Inspect the float valve seat contact area for wear.

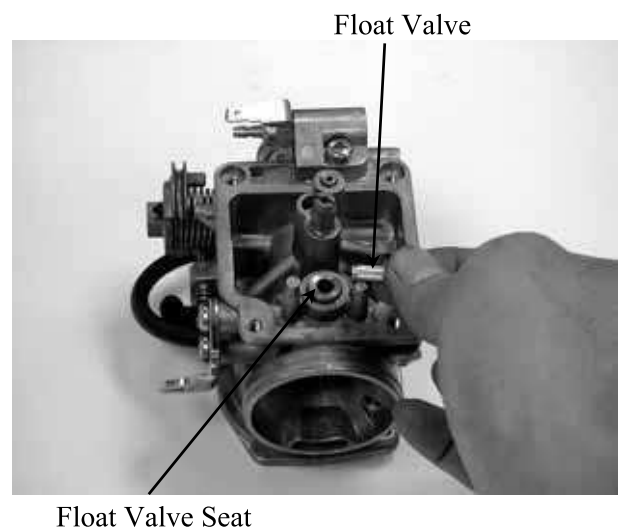

JETS/SCREWS REMOVAL

- * Before removing the pilot screw, turn the pilot screw clockwise until it seats lightly and record the rotating turns. Do not force the pilot screw against its seat to avoid seat damage.



Pilot Screw (P.S.)

Remove the main jet, needle jet holder and needle jet.
Remove the slow jet.



Slow Jet

Clean the removed the main jet, needle jet holder, needle jet and slow jet with detergent oil.

- * Be sure to use clean detergent oil.

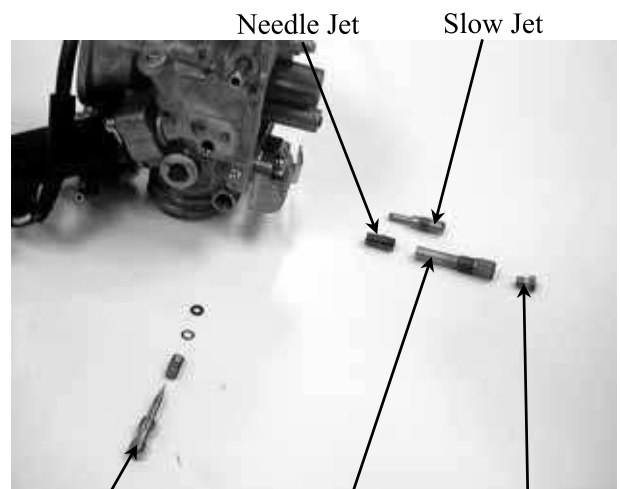

Pilot Screw

Needle Jet Holder

Main Jet

AUTO BYSTARTER INSPECTION /REMOVAL

AUTO BYSTARTER INSPECTION

Measure the resistance between the auto bystarter wire terminals.

Resistance: 10Ω (10 minutes minimum after stopping the engine)

If the reading is not within the limit, replace the auto bystarter with a new one.

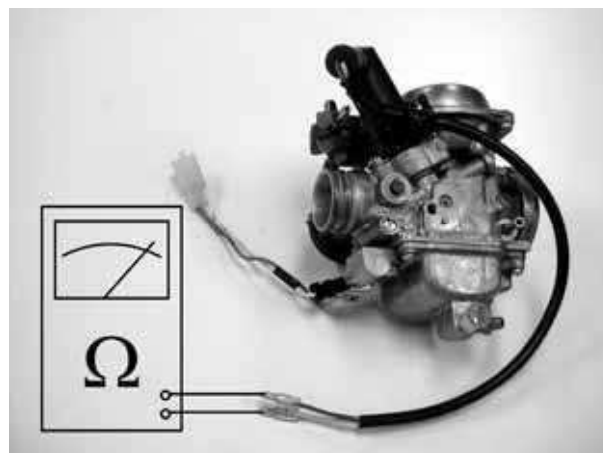

Connect a hose to the fuel enriching circuit of the carburetor. Connect the auto bystarter yellow wire to the positive (+) terminal of a battery and green wire to the negative (-) terminal. Wait 5 minutes and blow the hose with mouth. If the passage is blocked, the auto bystarter is normal. Disconnect the auto bystarter from the battery. Wait 30 minutes and blow the hose with mouth.. If air can be blown into the hose, the auto bystarter is normal.

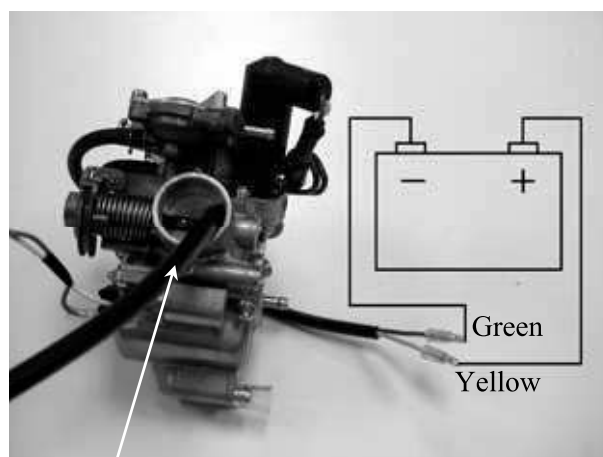

Hose

AUTO BYSTARTER REMOVAL

Remove the two set plate screws and set plate and then remove the auto bystarter from the carburetor body.

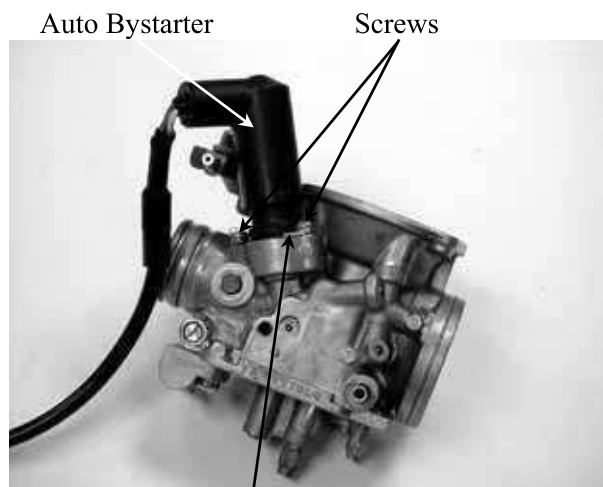

Set Plate

AUTO BYSTARTER INSPECTION

Check the auto bystarter valve and needle for nicks, wear or damage.
If any faulty part is found, replace the auto bystarter with a new one.

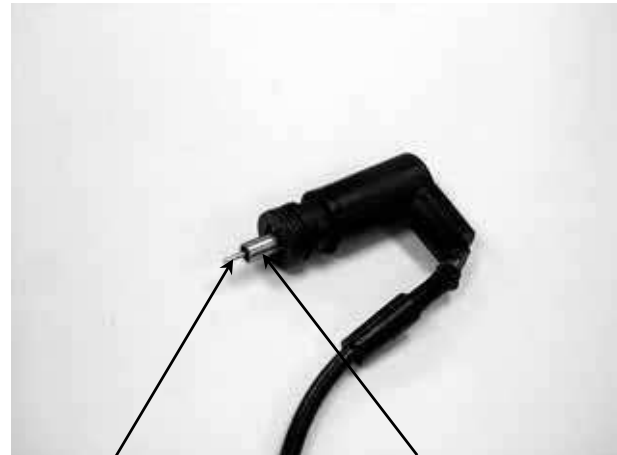

Bystarter Needle

Bystarter Valve

AIR CUT-OFF VALVE (A.C.V.)

A.C.V. REMOVAL

Remove the two screws and the air cut-off valve cover.

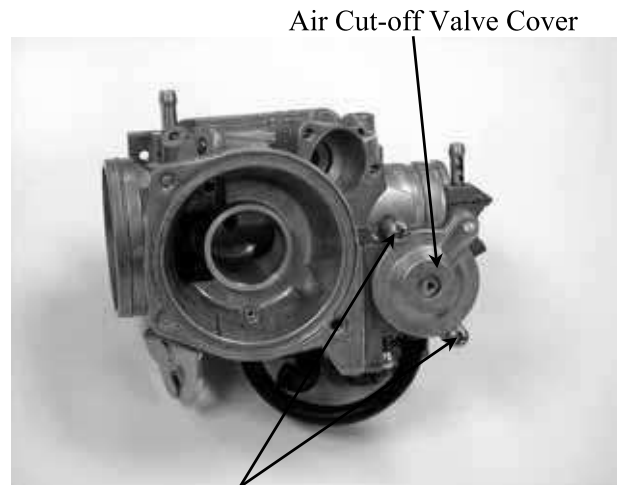

Air Cut-off Valve Cover

Screws

Remove the spring, diaphragm and O-rings.
Inspect the diaphragm and spring for wear or damage.

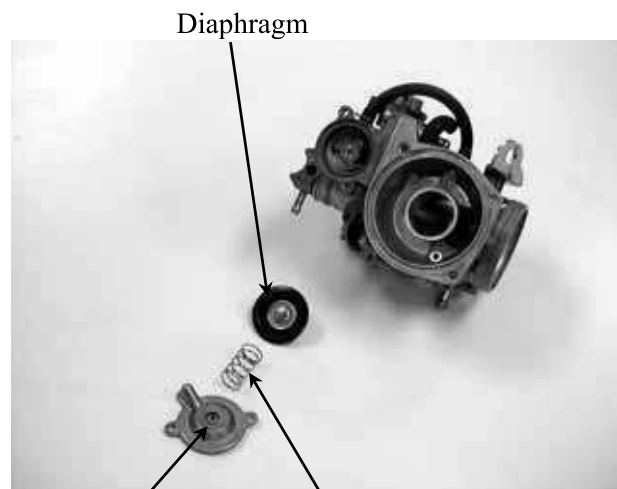

Diaphragm

Cover

Spring

13. FUEL SYSTEM/CARBURETOR/ FUEL PUMP/ FUEL TANK

Disconnect the hose at the valve seat.
Remove the two screws and the air cut-off
valve body.

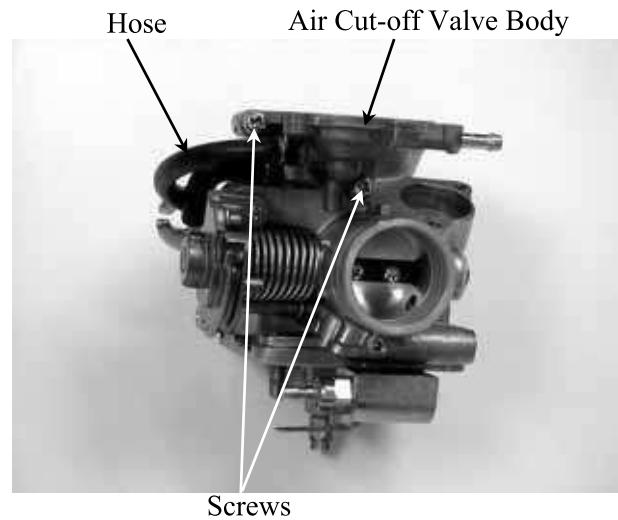

CARBURETOR BODY CLEANING

Blow compressed air through all passages of
the carburetor body.

- * • Make sure that no fuel jet is clogged.

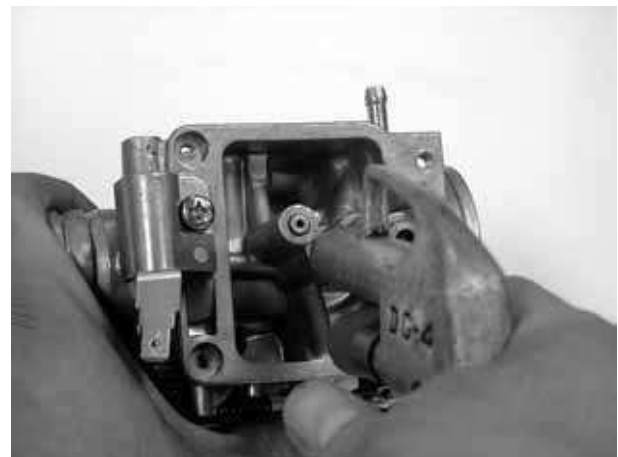

A.C.V. ASSEMBLY

Install the O-ring onto the air-cut-off valve
body and then install the valve body to the
carburetor with the two screws.

- * • Install the O-ring with the flat face
toward the valve body side.

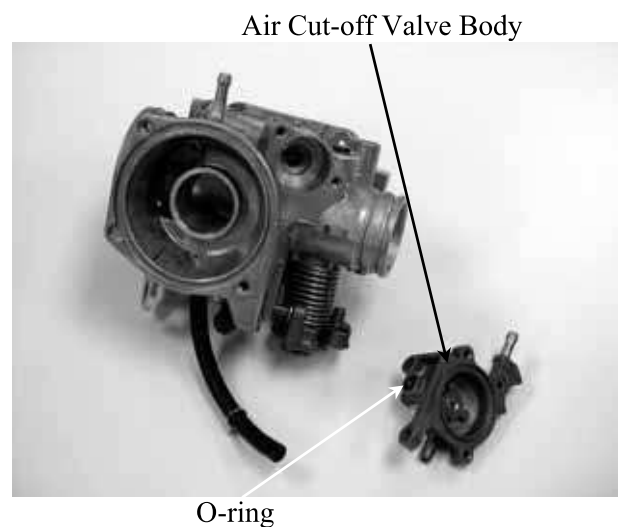

13. FUEL SYSTEM/CARBURETOR/ FUEL PUMP/ FUEL TANK

Install the O-ring onto the air-cut-off valve body securely.

- * **Install the O-ring with the flat face toward the valve body side.**

Install the diaphragm, spring, and cover.

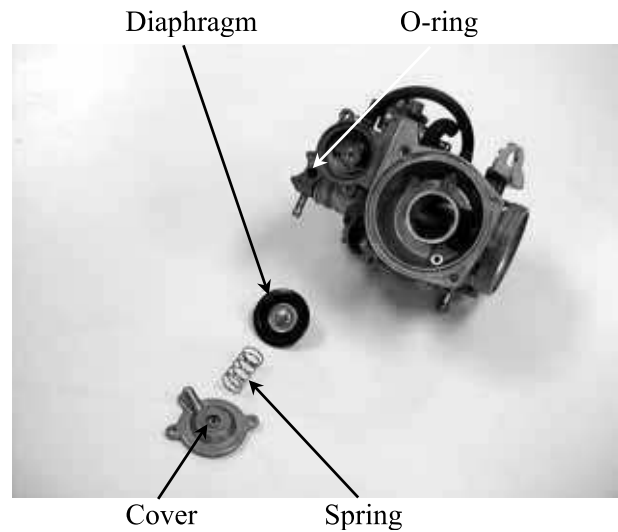

Install and tighten the two screws attaching the air cut-off valve cover.
Connect the hose.



AUTO BYSTARTER INSTALLATION

Install the auto bystarter and set plate.
Install and tighten the two screws.

- * **Insert the auto bystarter into the carburetor body until it bottoms and position the set plate into the upper groove in the bystarter.**
- Install the set plate with its round face facing down.**

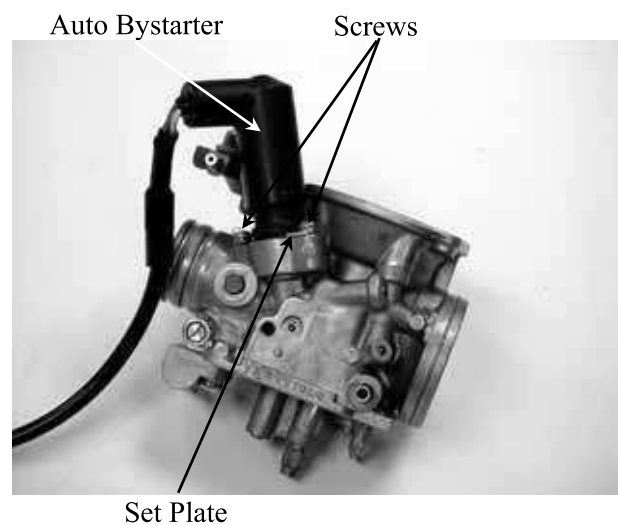

FLOAT CHAMBER ASSEMBLY

Install the main jet.
Install the slow jet.

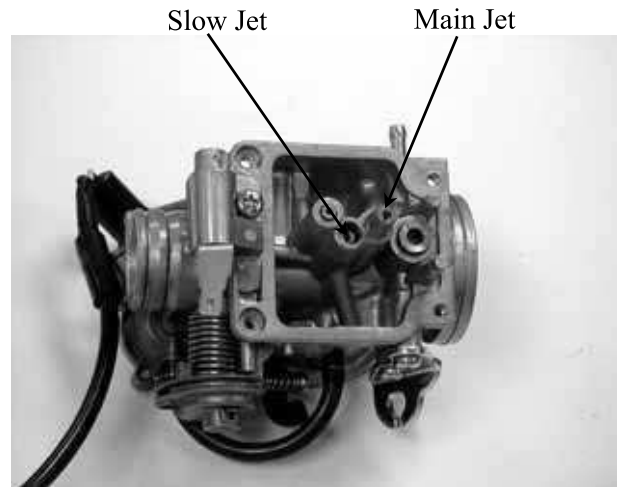

Install the pilot screw.

- * Be sure to record the rotating turns when it is removed.



Pilot Screw

Install the float valve, float and float pin.

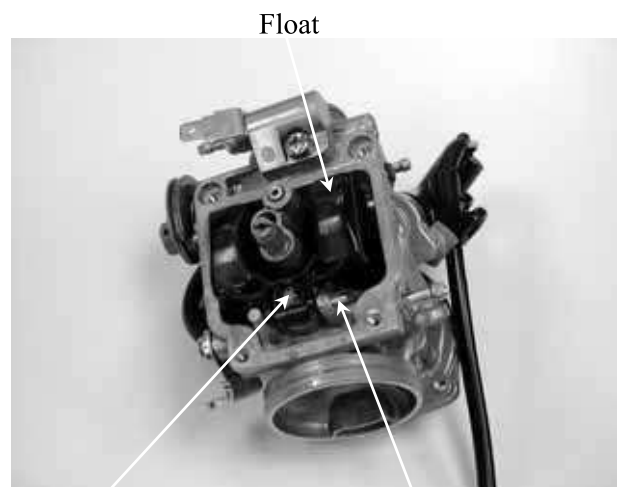

Float Valve

Float Pin

FLOAT LEVEL INSPECTION

Measure the float level at the location of the main jet (just contacting the float valve).

Float Level: 18.5±1.0mm

Replace the float if the level is incorrect. Check the operation of the float and then reinstall the float chamber.

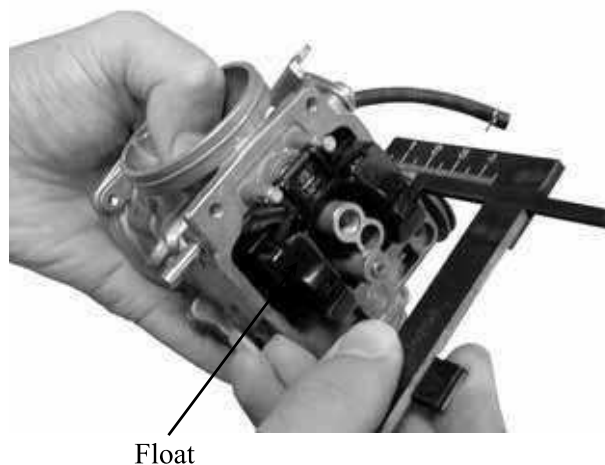

VACUUM CHAMBER ASSEMBLY

First install the jet needle and spring into the vacuum chamber and then install the needle holder.

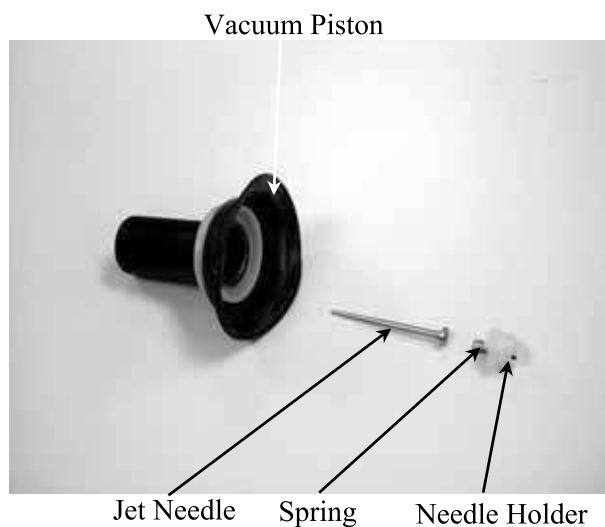

Install the vacuum piston into the carburetor body.

- * Align the hole in the diaphragm with the hole in the carburetor body.

Install the spring.
Install the vacuum chamber cover and tighten it with the two screws.

- * Be careful not to let the diaphragm slip.
- * If the diaphragm cannot be positioned correctly because of expansion, dry the diaphragm before installation.

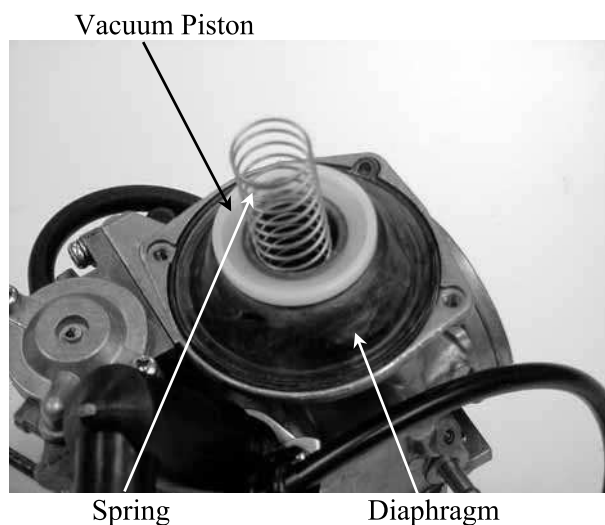

Check the heater with battery.

If the heater is getting hot, means the heater without problem, otherwise the heater has to be changed.



Heater

CARBURETOR INSTALLATION

Tighten the drain screw.

Install the carburetor onto the intake manifold and tighten the band.

Install the air cleaner connecting tube and tighten the band.

Connect the throttle cable to the carburetor.

- *
 - After connecting the throttle cable, adjust the throttle grip free play to 2~6mm.



Throttle Cable

Intake Manifold Band

Air Cleaner Connecting
Tube Band

Connect the auto bystarter wire.

Connect the fuel tube and vacuum tube to the carburetor.

Perform the following inspections and adjustments:

- Throttle grip free play (⇒3-3)
- Idle speed (⇒3-6)

Install the seat, met-in box and frame center cover.

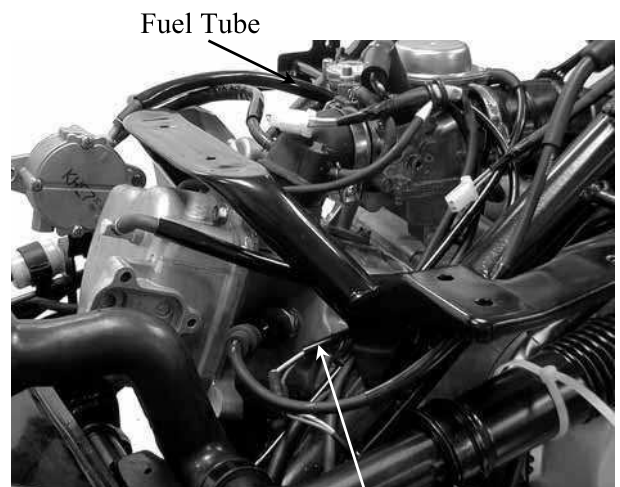

Fuel Tube

Auto Bystarter Wire

13. FUEL SYSTEM/CARBURETOR/ FUEL PUMP/ FUEL TANK

FUEL PUMP REMOVAL

Remove the frame center cover.
Disconnect the fuel pump inlet, outlet and vacuum tubes.
Remove the two fuel pump attaching bolts and the fuel pump.

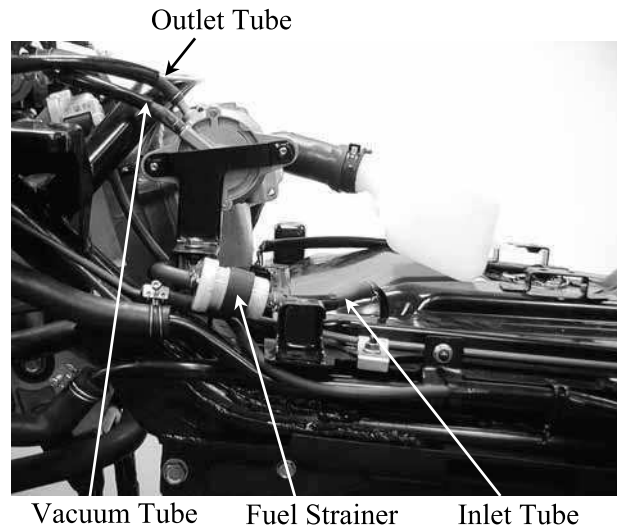

FUEL PUMP DISASSEMBLY

Remove the four fuel pump body screws.

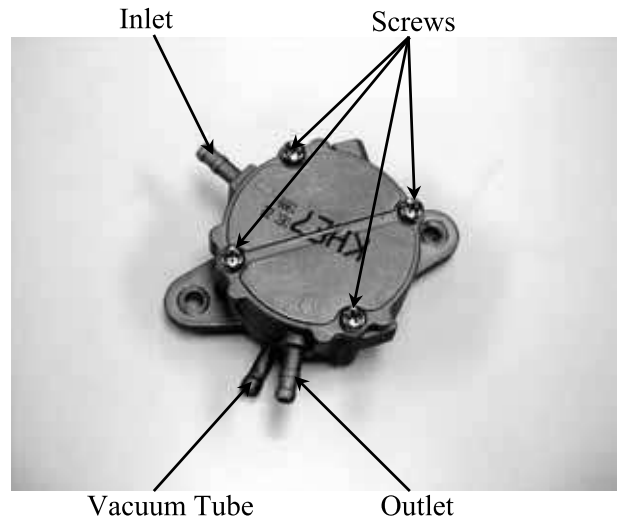

Disassemble the fuel pump.

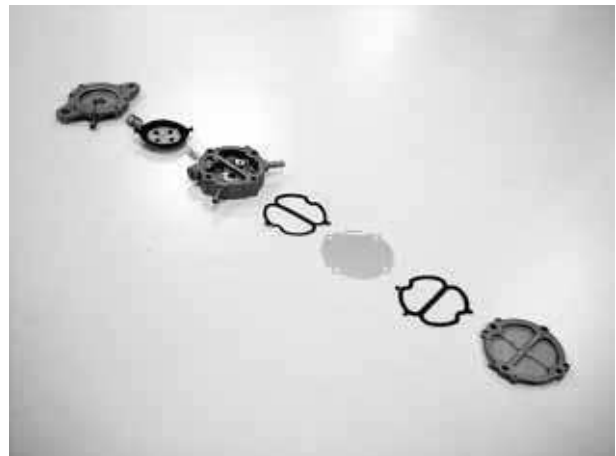

FUEL PUMP INSPECTION

Inspect the fuel pump diaphragms A and B for damage.
Inspect each gasket for damage.

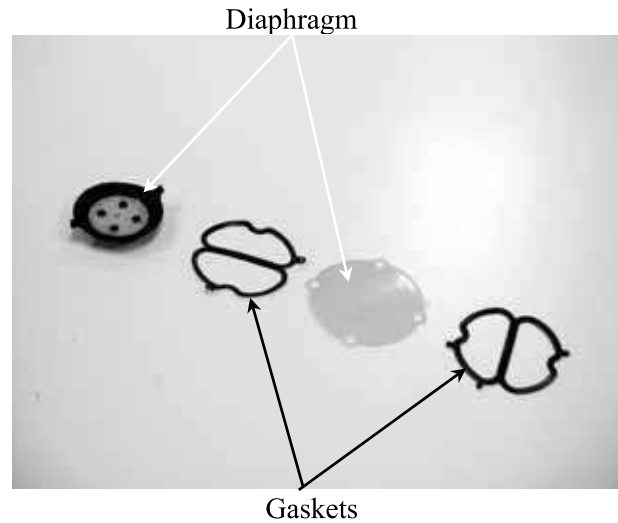

Inspect the suction valve, outlet valve and relief valve in the fuel pump body for damage, cracks or foreign matters.

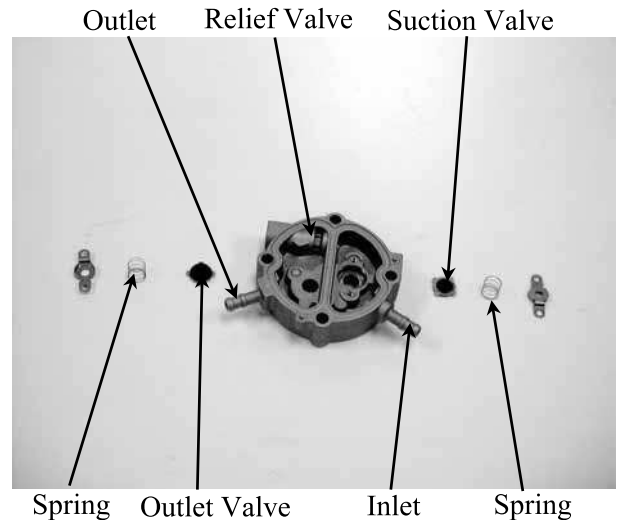

FUEL PUMP ASSEMBLY

Assemble the fuel pump in the reverse order of disassembly.

- * During assembly, be sure to install the gaskets and diaphragms properly to avoid damage.
- * Do not allow any foreign matter to enter the fuel pump during assembly.

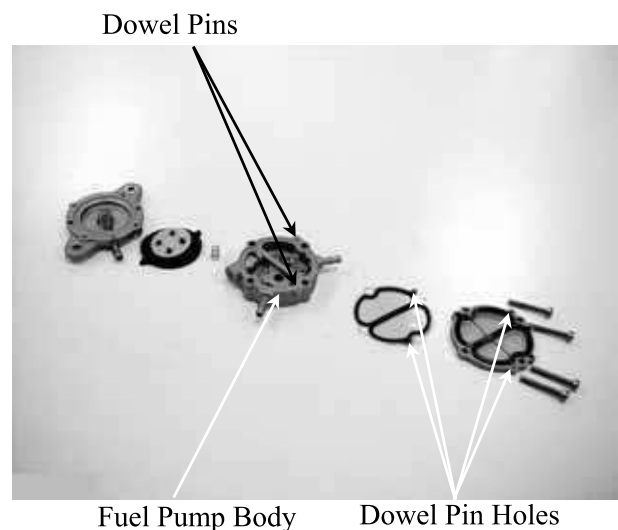

13. FUEL SYSTEM/CARBURETOR/ FUEL PUMP/ FUEL TANK

FUEL PUMP INSTALLATION

Install the fuel pump and secure it with the two bolts.
Connect the fuel pump inlet, outlet and vacuum tubes.
Install the seat, met-in box and frame center cover.

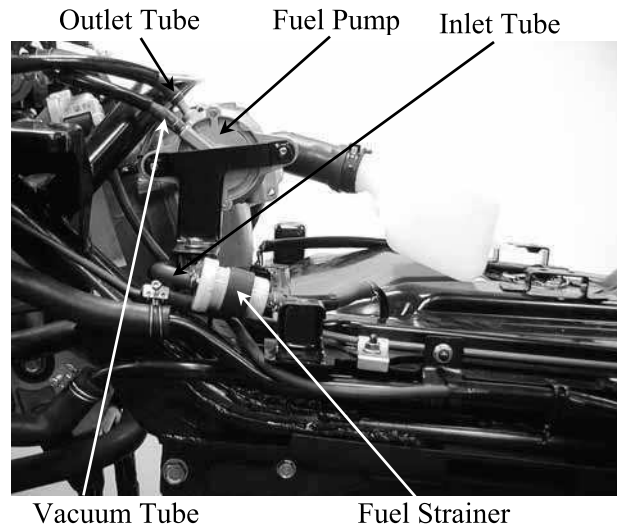

Measure the fuel pump output.
Start the engine and disconnect the fuel outlet tube and place a clean container under the tube to check the fuel output.

Output: 40cc/1500rpm/10 seconds .

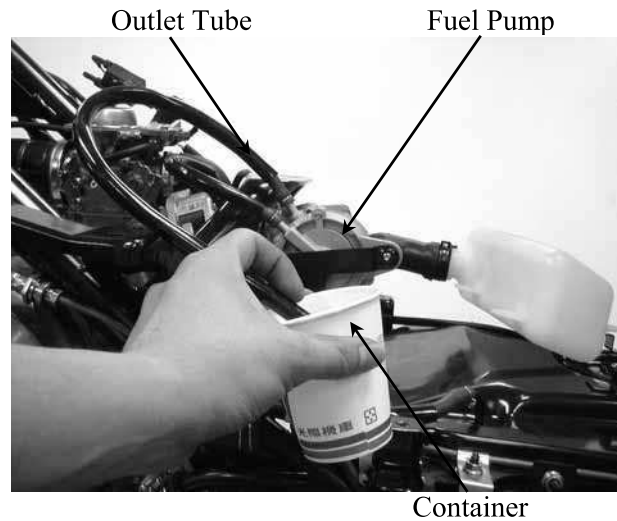

FUEL TANK REMOVAL

Remove the floor board. (⇒2-4)
Remove the leg shield . (⇒2-5)
Disconnect the fuel unit wire connector.
Remove the fuel tube between the fuel tank and the fuel filler.
Disconnect the fuel vapor tube.
Remove the fuel tank.

The installation sequence is the reverse of removal.

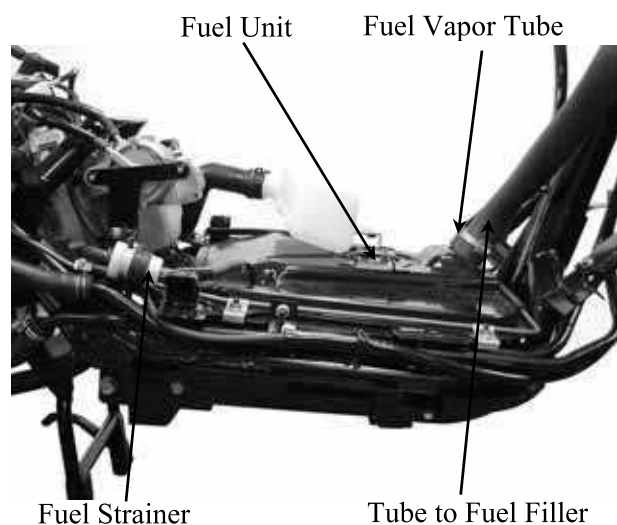

FUEL STRAINER REMOVAL

Remove the fuel strainer from the fuel tank.

INSPECTION

Inspect if the fuel strainer is clogged and clean it with compressed air.

- * When removing the fuel strainer, do not allow flames or sparks near the working area and drain the residual gasoline into a container.



INSTALLATION

Install the fuel strainer with its arrow mark toward the fuel pump.



Arrow Mark

Fuel Strainer

STEERING HANDLEBAR/FRONT WHEEL/FRONT BRAKE/FRONT SHOCK ABSORBER/FRONT FORK

SCHEMATIC DRAWING -----	14- 1
SERVICE INFORMATION-----	14- 2
TROUBLESHOOTING-----	14- 3
STEERING HANDLEBAR -----	14- 4
FRONT WHEEL -----	14- 5
FRONT BRAKE -----	14- 8
FRONT SHOCK ABSORBER-----	14-14
FRONT FORK -----	14-17

SCHEMATIC DRAWING

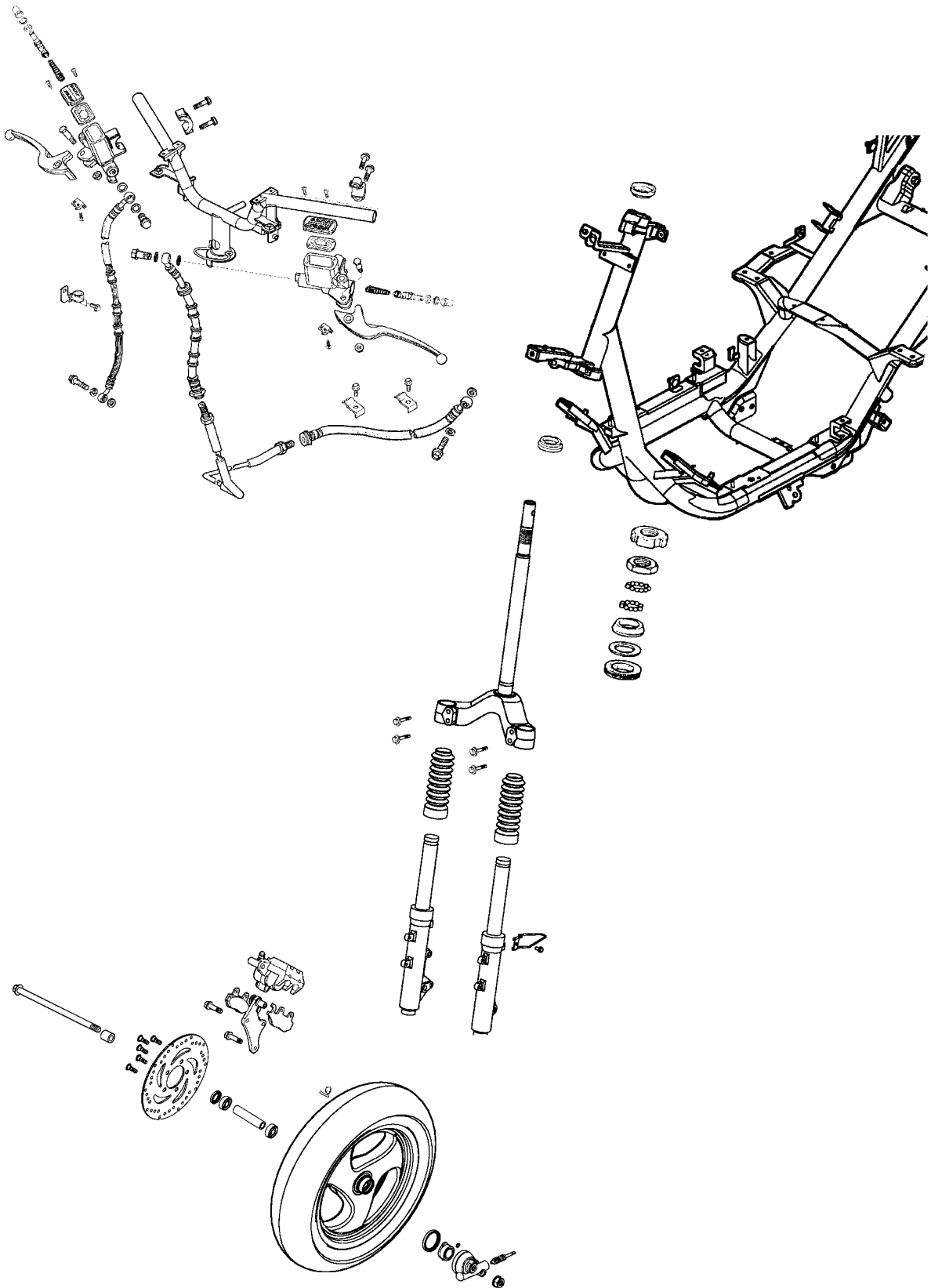

SERVICE INFORMATION

GENERAL INSTRUCTIONS

- Remove the motorcycle frame covers before removing the front wheel, steering handlebar, front shock absorber and front fork. Jack the motorcycle front wheel off the ground and be careful to prevent the motorcycle from falling down.
- During servicing, keep oil or grease off the brake pads and brake disk.

SPECIFICATIONS

Item	Standard (mm)	Service Limit (mm)
Axle shaft runout	—	0.2
Front wheel rim runout	Radial	2.0
	Axial	2.0
Front shock absorber spring free length	240.6	233
Brake disk thickness	3.8~4.2	3.0
Brake disk runout	—	0.30
Brake master cylinder I.D.	12.70~12.74	12.75
Brake master cylinder piston O.D.	12.65~12.68	12.64
Brake caliper piston O.D.	25.33~25.36	25.30
Brake caliper cylinder I.D.	25.40~25.45	25.45

TORQUE VALUES

Steering stem lock nut	78.4~117.6N-m
Steering top cone race	4.9~12.7N-m
Front shock absorber bolt	19.8~24.5N-m
Front axle nut	44.1~49N-m
Brake caliper bolt	24.5N~34.3N-m

SPECIAL TOOLS

- Lock nut wrench
- Front shock absorber compressor
- Ball race remover
- Driver handle
- Outer driver, 37x40mm
- Pilot, 12mm
- Bearing remover
- Bearing remover head, 12mm

TROUBLESHOOTING

Hard steering (heavy)

- Excessively tightened steering stem top cone race
- Broken steering balls
- Insufficient tire pressure

Steers to one side or does not track straight

- Uneven front shock absorbers
- Bent front fork
- Bent front axle or uneven tire

Poor brake performance

- Worn brake pads
- Contaminated brake pad surface
- Deformed brake disk
- Air in brake system
- Deteriorated brake fluid
- Worn brake master cylinder piston oil seal
- Clogged brake fluid line
- Unevenly worn brake caliper

Front wheel wobbling

- Bent rim
- Loose front axle
- Bent spoke plate
- Faulty tire
- Improperly tightened axle nut

Soft front shock absorber

- Weak shock springs
- Insufficient damper oil

Front shock absorber noise

- Slider bending
- Loose fork fasteners
- Lack of lubrication

STEERING HANDLEBAR

REMOVAL

- Remove the handlebar front and rear covers. (⇒2-6)
- Remove the front and rear brake master cylinder attaching bolts.
- Remove the front upper cover. (⇒2-5)
- Remove the front lower cover. (⇒2-5)
- Remove the floor board. (⇒2-4)
- Remove the leg shield. (⇒2-5)

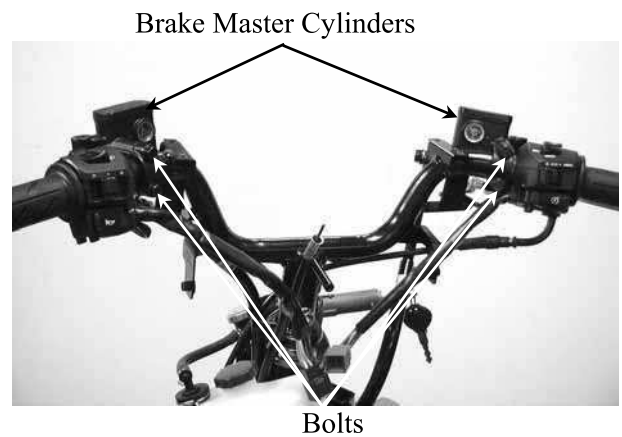

- Remove the four screws attaching the right and left handlebar switches.
- Disconnect the throttle cable from the throttle grip and remove the throttle grip from the handlebar.

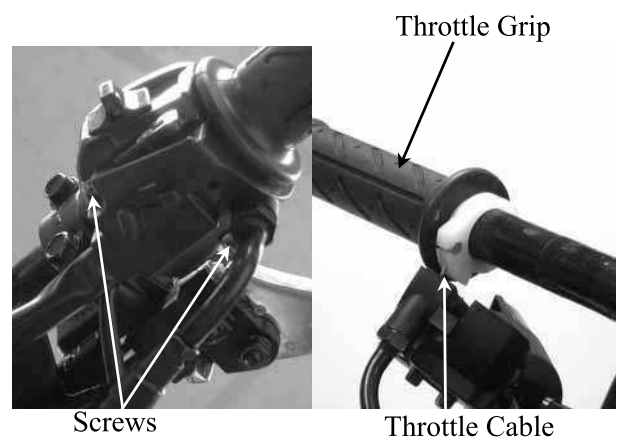

- Remove the handlebar lock nut and take out the bolt.
- Remove the handlebar.

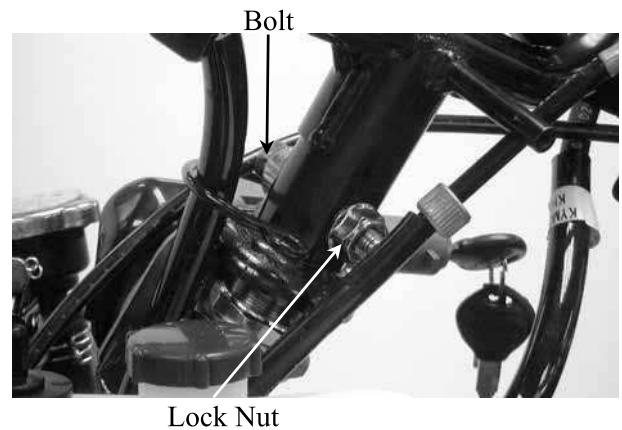

INSTALLATION

- Install the handlebar onto the steering stem and install the handlebar collar, lock nut and bolt.
- Tighten the bolt to the specified torque.
- Torque:** 39.2~49N-m

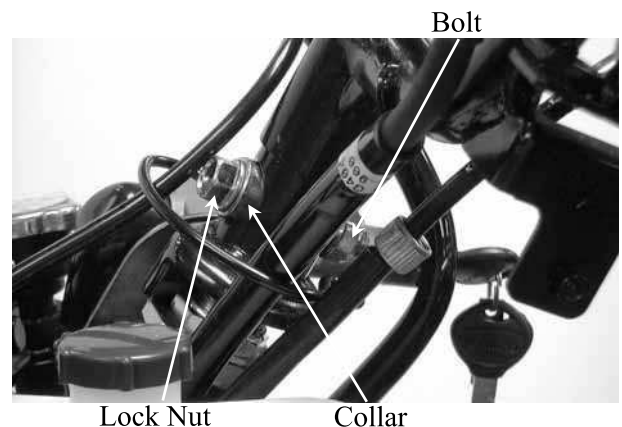

14. STEERING HANDLEBAR/FRONT WHEEL/FRONT BRAKE/FRONT SHOCK ABSORBER/FRONT FORK Bet & Win 125/150

Lubricate the throttle grip front end with grease and then install the throttle grip. Connect the throttle cable to the throttle grip. Install the right and left handlebar switches and tighten the screws.

- * Adjust the throttle grip free play to the specified range of 2~6mm.

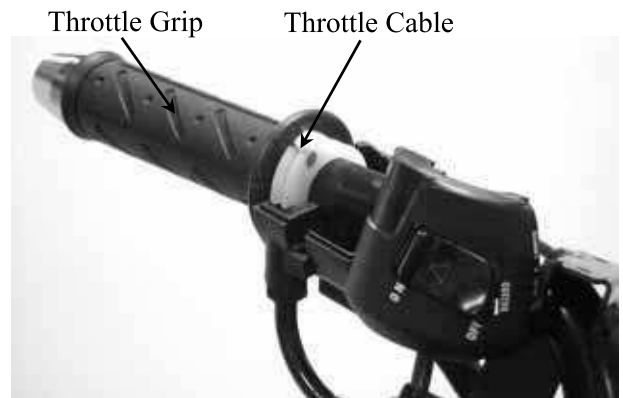

Install the front and rear brake master cylinders.

- * Install the brake master cylinders by aligning the index marks.

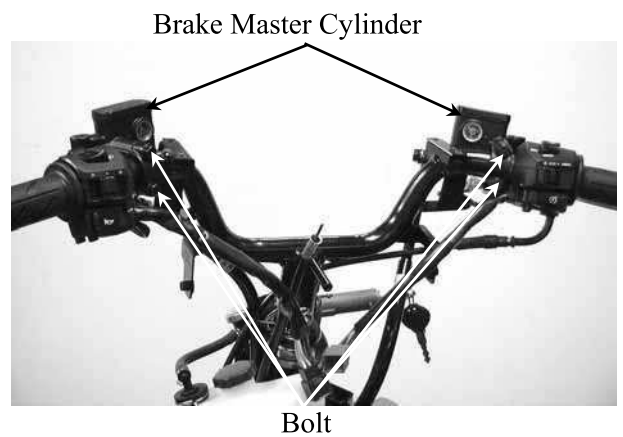

FRONT WHEEL

REMOVAL

Jack the motorcycle front wheel off the ground. Remove the front axle nut to pull out the axle. Remove the front wheel and the speedometer gear unit.

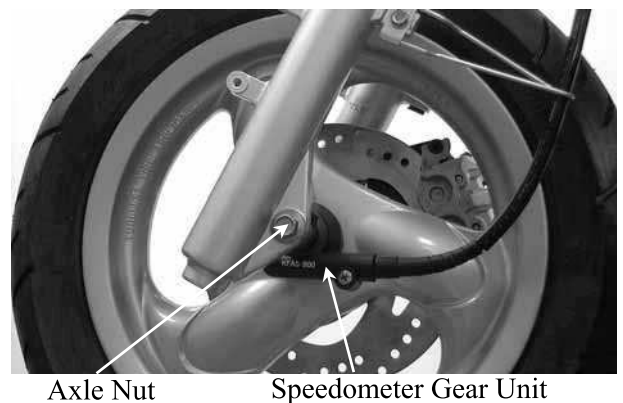

INSPECTION

AXLE RUNOUT

Set the axle in V blocks and measure the runout using a dial gauge. The actual runout is $\frac{1}{2}$ of the total indicator reading.

Service Limit: 0.2mm replace if over

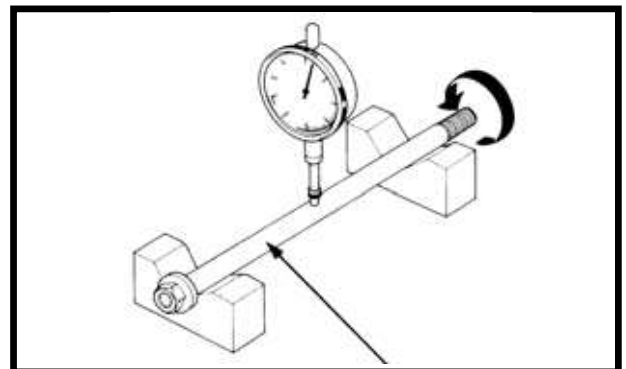

WHEEL RIM

Check the wheel rim runout.

Service Limits:

Radial: 2.0mm replace if over

Axial: 2.0mm replace if over

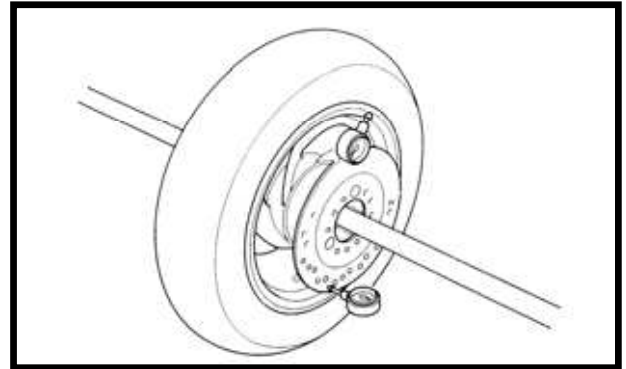

FRONT WHEEL BEARING

Remove the side collar and dust seal.



Turn the inner race of each bearing with your finger to see if they turn smoothly and quietly. Also check if the outer race fits tightly in the hub.

Replace the bearings if the races do not turn smoothly, quietly, or if they fit loosely in the hub.

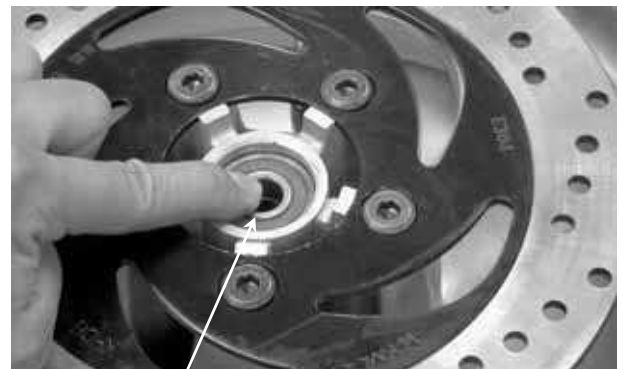

Wheel Bearing

BEARING REPLACEMENT

Remove the front wheel bearings and distance collar.

Special Tools

Bearing Remover

Bearing Remover Head, 12mm



14. STEERING HANDLEBAR/FRONT WHEEL/FRONT BRAKE/FRONT SHOCK ABSORBER/FRONT FORK



Bet & Win 125/150

Pack all bearing cavities with grease.
 Drive in the left bearing.
 Install the distance collar.
 Drive in the right bearing.

- * Do not allow the bearings to tilt while driving them in.
- * Drive in the bearing squarely with the sealed end facing out.

Special Tools

Outer driver
 Driver handle



Outer Driver

INSTALLATION

Apply grease to the speedometer gear unit.
 Install the speedometer gear unit by aligning its retaining pawl with the hub cutout.

- * If not aligned, the retaining pawl will be deformed when the axle nut is tightened.
- * After installing the axle, turn the wheel to make sure that the speedometer drive shaft rotates freely.

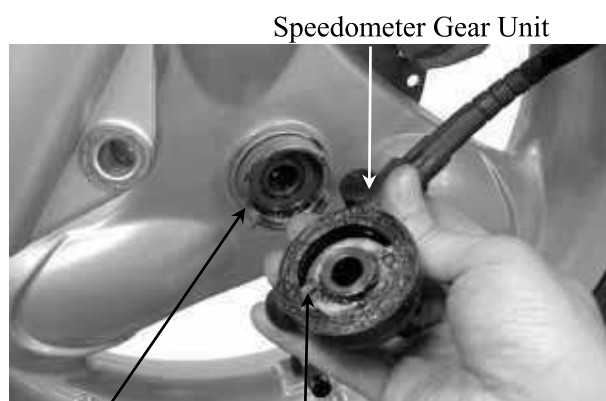

Hub Cutout

Pawl

Install the front wheel by aligning the speedometer gear unit groove with the front shock absorber tab.
 Insert the axle and tighten the axle nut.

- * When installing the front wheel, position the brake disk between the two brake pads.

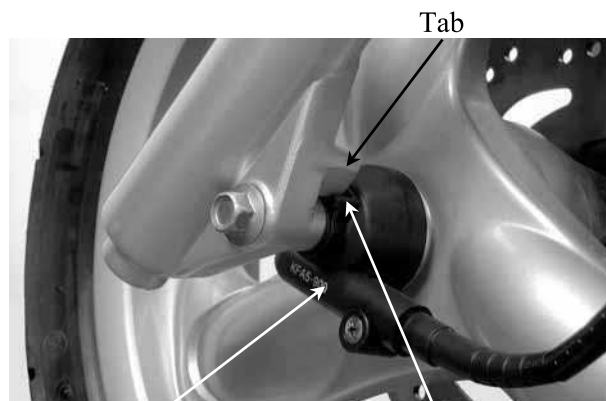

Speedometer Gear Unit

Groove

Torque: 44.1 ~ 49N-m

FRONT BRAKE

BRAKE MASTER CYLINDER

REMOVAL

- Remove the handlebar covers. (⇒2-6)
- First drain the brake fluid from the hydraulic brake system.
- Disconnect the front stop switch wire connector.
- Remove the brake fluid tube bolt.
- Remove the two bolts attaching the brake master cylinder
- Remove the brake master cylinder.

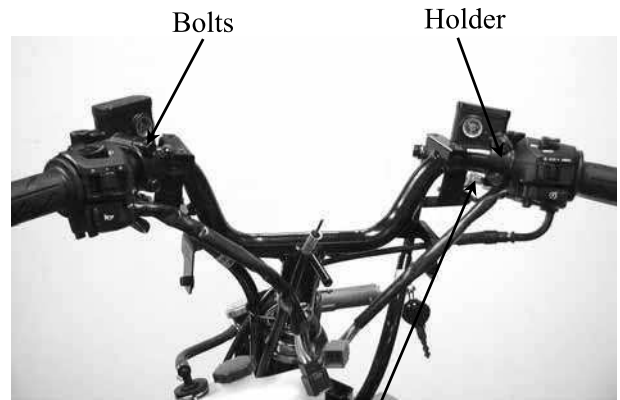

Stop Switch Wire Connector

- *
 - When servicing the brake system, use shop towels to cover rubber and plastic parts and coated surfaces to avoid being contaminated by brake fluid.
 - When removing the brake fluid tube bolt, be sure to plug the tube end to avoid brake fluid leakage.

DISASSEMBLY

- Remove the brake lever bolt and the brake lever.
- Remove the piston rubber cover and snap ring from the brake master cylinder.

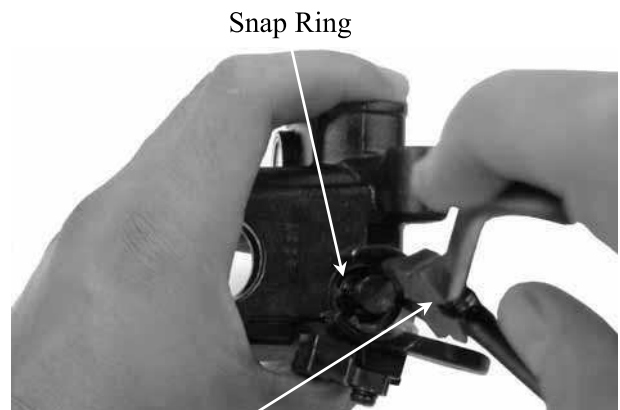

Snap Ring Pliers (Close)

- Remove the washer, main piston and spring from the brake master cylinder.
- Clean the inside of the master cylinder and brake reservoir with brake fluid.

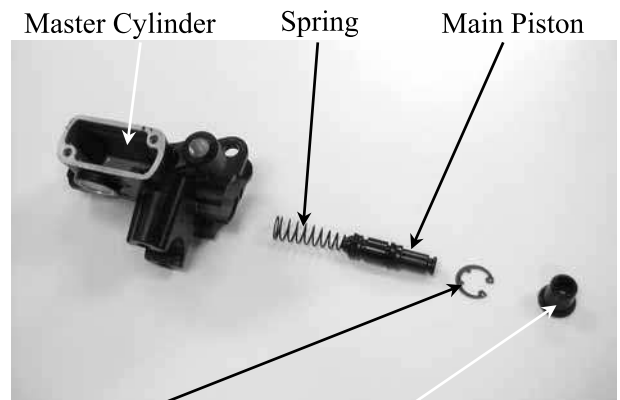

Snap Ring

Rubber Cover

INSPECTION

Measure the brake master cylinder I.D.
Inspect the master cylinder for scratches or cracks.

Service Limit: 12.75mm

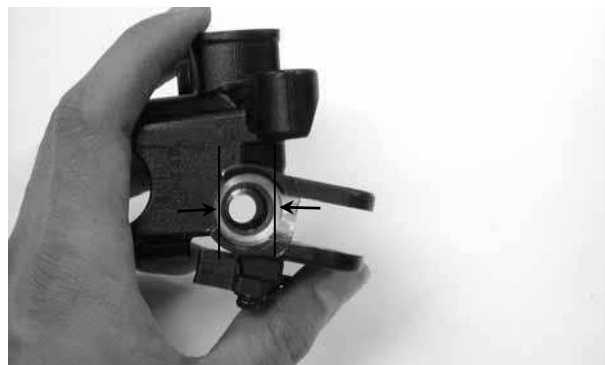

Measure the brake master cylinder piston O.D.

Service Limit: 12.645mm

Before assembly, inspect the 1st and 2nd rubber cups for wear.



ASSEMBLY

Before assembly, apply brake fluid to all removed parts.
Install the spring together with the 1st rubber cup.

- ***
- During assembly, the main piston and spring must be installed as a unit without exchange.
 - When assembling the piston, soak the cups in brake fluid for a while.
 - Install the cups with the cup lips facing the correct direction.

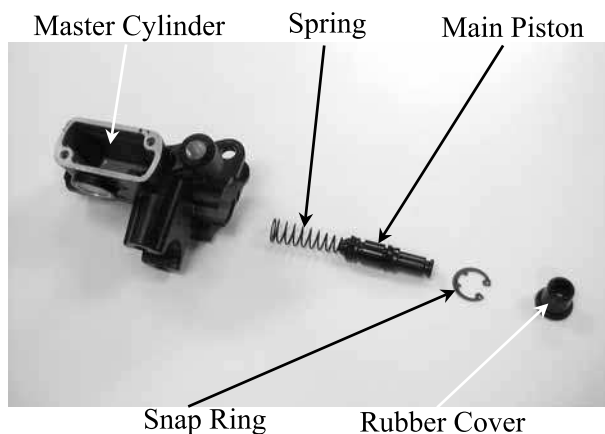

Install the main piston, spring and snap ring.
Install the rubber cover.
Install the brake lever.
Place the brake master cylinder on the handlebar and install the holder with the “up” mark facing up. Also align the punch mark with the holder joint seam.
First tighten the upper bolt and then tighten the lower bolt.

Torque: 9.8~13.7N-m

Install the brake fluid tube with the attaching bolt and two sealing washers.

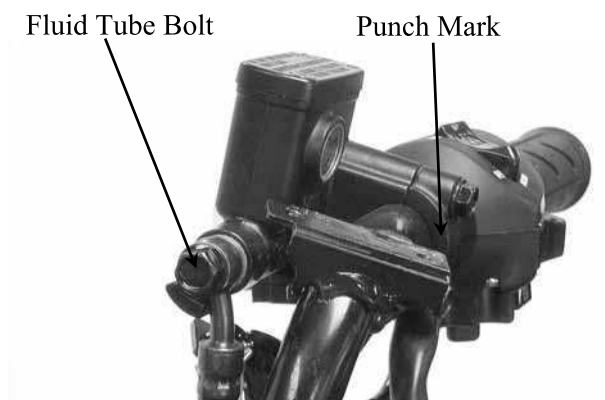

Connect the front stop switch wire connector.
Install the handlebar covers. (⇒2-6)



Stop Switch Wire Connector

BRAKE FLUID REFILLING

Keep the handlebar upright and remove the brake reservoir cover and diaphragm.
Add DOT-3 brake fluid to the brake reservoir.

- *
 - When bleeding, be careful not to allow air in the brake reservoir flowing into the brake system.
 - When using a brake bleeder, follow the manufacturer's instructions.
 - Never use dirty or unspecified brake fluid or mix different brake fluids because it will damage the brake system.



BRAKE FLUID BLEEDING

Keep the handlebar upright and remove the brake reservoir cover and diaphragm. Add the specified brake fluid to the upper limit.

- *
 - Do not allow dust or water to enter the brake system during refilling.
 - When servicing the brake system, use shop towels to cover plastic parts and coated surfaces to avoid damage caused by splash of brake fluid.



In order to avoid spilling brake fluid, connect a transparent hose to the bleed valve.

Warning

Brake fluid spilled on brake pads or brake disk will reduce the braking effect. Clean the brake pads and brake disk with a high quality brake degreaser.

Fully apply the brake lever and then loosen the brake caliper bleed valve to drain the brake fluid until there is no air bubbles in the brake fluid. Then, tighten the bleed valve. Repeat these steps until the brake system is free of air.



Bleed Valve

BRAKE CALIPER

REMOVAL

First drain the brake fluid from the hydraulic brake system.
Remove the brake fluid tube bolt.
Remove the two bolts attaching the brake caliper.
Remove the brake caliper.

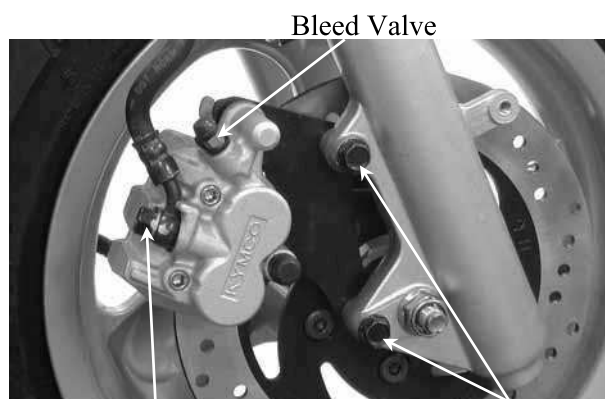

Fluid Tube Bolt

Bolts

DISASSEMBLY

Remove the two brake pads dowel pins from the brake caliper.
Remove the brake pads.

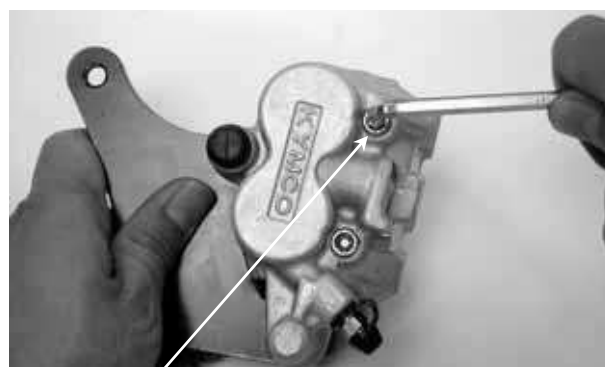

Dowel Pin

Remove the piston from the brake caliper.
If necessary, use compressed air to squeeze out the piston through the brake fluid inlet opening and place a shop towel under the caliper to avoid contamination caused by the removed piston.
Check the piston cylinder for scratches or wear and replace if necessary.



Compressed Air

Push the piston oil seal outward to remove it.
Clean the oil seal groove with brake fluid.

* Be careful not to damage the piston surface.



Piston Oil Seal

Check the piston for scratches or wear.
Measure the piston O.D. with a micrometer gauge.

Service Limit: 25.30mm

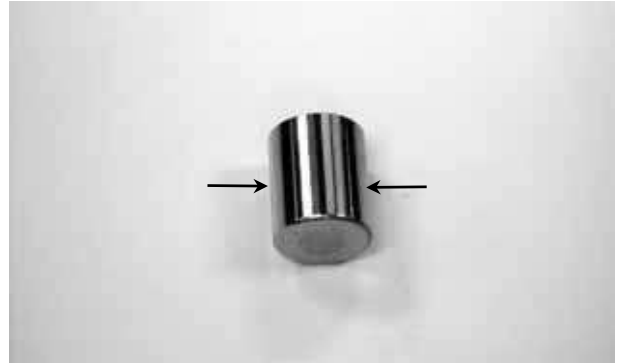

Check the caliper cylinder for scratches or wear and measure the cylinder bore.

Service Limit: 25.45mm

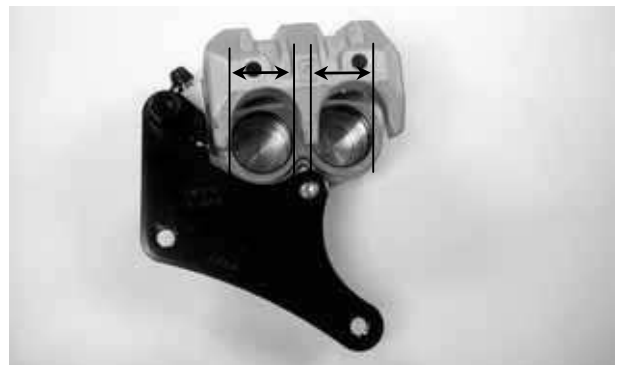

ASSEMBLY

Clean all removed parts.
Apply silicon grease to the piston and oil seal.
Lubricate the brake caliper cylinder inside wall with brake fluid.
Install the brake caliper piston with grooved side facing out.

* Install the piston with its outer end protruding 3 ~ 5mm beyond the brake caliper.

Wipe off excessive brake fluid with a clean shop towel. Apply silicon grease to the brake caliper seat pin and caliper inside.
Install the brake caliper seat.

INSTALLATION

Install the brake caliper to the shock absorber and tighten the two bolts.

Torque: 24.5 ~ 34.3N-m

* When installing the brake caliper, be sure to position the brake disk between the two brake pads.



Brake Caliper

14. STEERING HANDLEBAR/FRONT WHEEL/FRONT BRAKE/FRONT SHOCK ABSORBER/FRONT FORK **Bet & Win 125/150**

Connect the brake fluid tube to the brake caliper and tighten the fluid tube bolt.

Torque: 24.5 ~ 34.3N-m

Fill the brake reservoir with the specified brake fluid and bleed air from the brake system. (⇒14-10)

* When installing the brake fluid tube, be sure to install the two sealing washers.

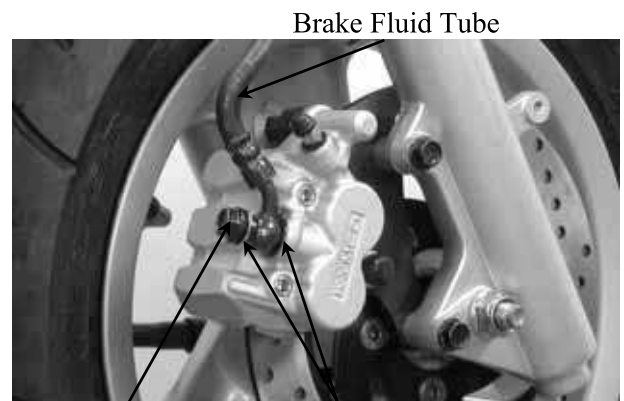

Fluid Tube Bolt

Washers

FRONT SHOCK ABSORBER

REMOVAL

Remove the front upper cover. (⇒2-5)
 Remove the front lower cover. (⇒2-5)
 Remove the front wheel. (⇒14-5)
 Remove the front brake caliper. (⇒14-11)
 Remove the front shock absorber upper mount bolts.
 Loosen the lower mount bolts to remove the front shock absorbers.

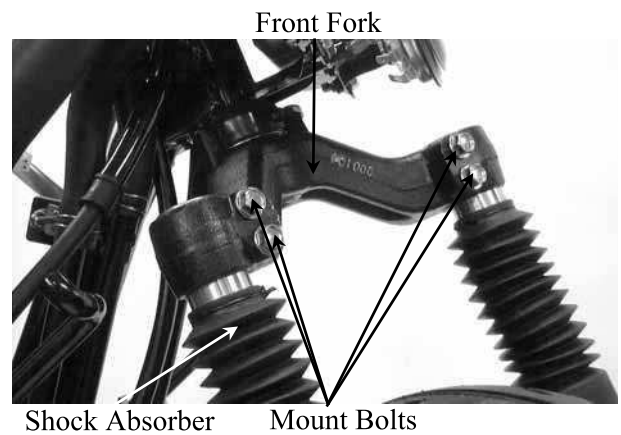

DISASSEMBLY

Remove the dust boot.
 Remove the dust seal.
 Remove the circlip.

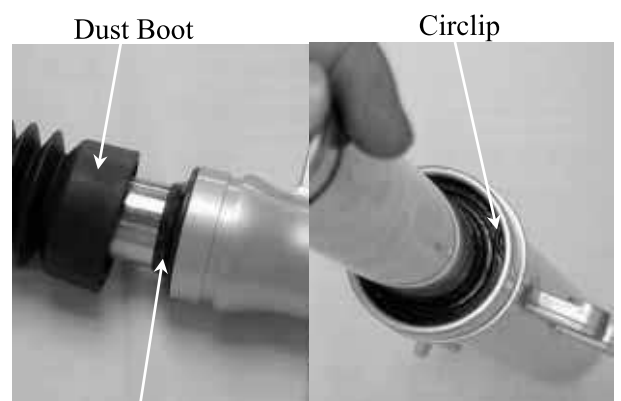

Set the front shock absorber in a vise.
 Remove the damper rod hex bolt and copper washer.
 Pull out the front shock absorber tube.

* After the hex bolt is removed, place a container under the front shock absorber to drain the engine oil from it.

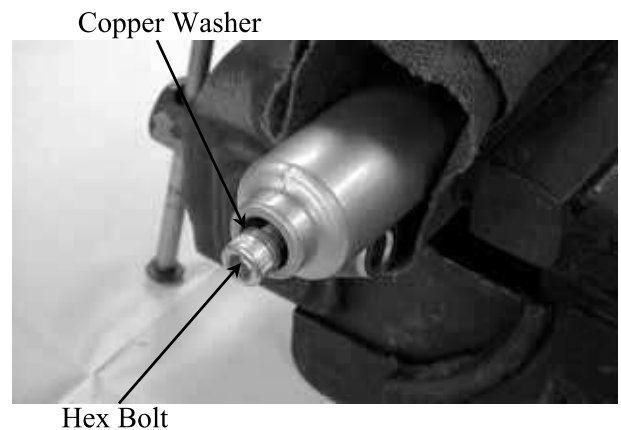

Set the front shock absorber tube in a vise.
 Remove the lock nut on the front shock absorber tube.
 Take out the shock absorber spring and damper rod.

* When holding the shock absorber tube, place a shop towel to protect it and do not apply too much force.

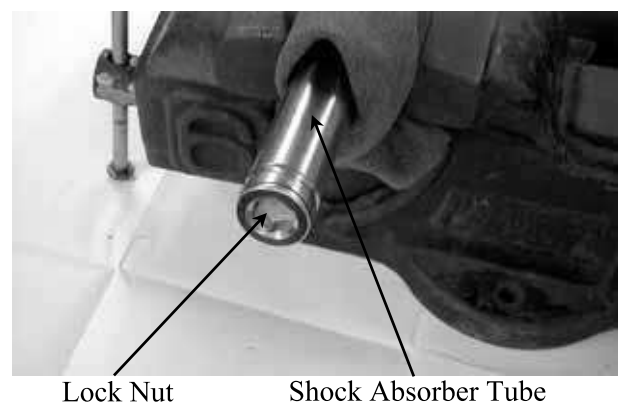

14. STEERING HANDLEBAR/FRONT WHEEL/FRONT BRAKE/FRONT SHOCK ABSORBER/FRONT FORK Bet & Win 125/150

INSPECTION

Inspect the following items and replace if necessary.

- Front shock absorber tube bending, damage or wear
- Weak front shock absorber spring
- Damper and damper rod bending
- Oil seal damage or wear

Shock Absorber Tube

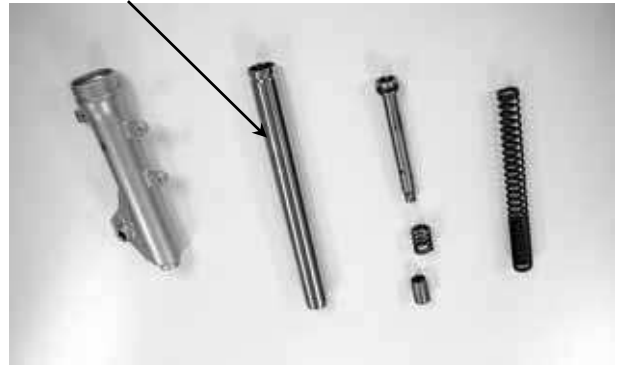

Measure the front shock absorber spring free length.

Service Limit: 233mm replace if below

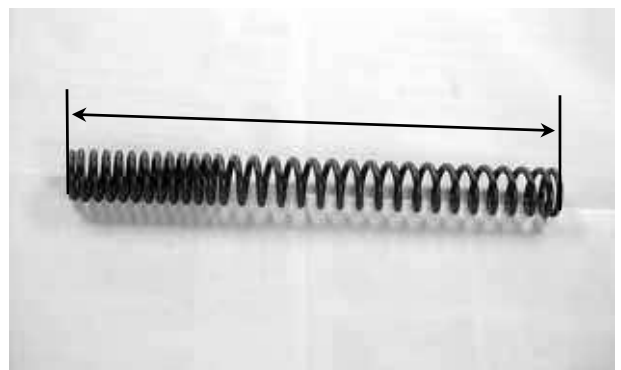

ASSEMBLY

Install the damper spring onto the damper rod and then install them into the front shock absorber tube.

Install the shock absorber spring onto the front shock absorber tube.

Set the front shock absorber tube in a vise and then tighten the lock nut.

* When holding the shock absorber tube, place a shop towel to protect it and do apply too much force .



Set the front shock absorber in a vise. Insert the shock absorber tube into the shock absorber and then install the copper washer and tighten the damper rod hex bolt.

* Apply locking agent to the washer and hex bolt and install them together.



Add engine oil into the front shock absorber.

Torque: 4.9~29.4N-m

Specified Oil: SS#8

Hex Bolt Copper Washer

Oil Capacity: 81cc

Install the oil seal

Install the circlip.

Install the dusts seal and dust boot.

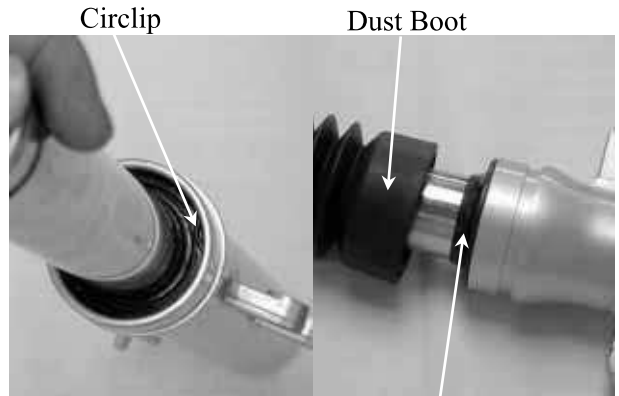

Dust Seal

INSTALLATION

Install the front shock absorbers onto the front fork.

Install and tighten the front shock absorber upper mount bolts.

Tighten the lower mount bolts.

* Align the upper mount bolt hole with the groove on the front fork.

Install the front wheel. (⇒14-7)

FRONT FORK

REMOVAL

- Remove the handlebar covers. (⇒2-6)
- Remove the steering handlebar. (⇒14-4)
- Remove the front upper cover. (⇒2-5)
- Remove the front lower cover. (⇒2-5)
- Remove the front inner fender. (⇒2-6)
- Remove the front wheel. (⇒14-5)
- Remove the front brake caliper. (⇒14-11)
- Hold the steering stem top cone race and remove the steering stem lock nut.
- Remove the top cone race and remove the front fork.

* Be careful not to lose the steel balls (26 on top race and 19 on bottom race).

Inspect the ball races, cone races and steel balls for wear or damage. Replace if necessary.

BOTTOM CONE RACE REPLACEMENT

Remove the bottom cone race using a chisel.

Drive a new bottom cone race into place with a proper driver.

* Be careful not to damage the steering stem and front fork.

BALL RACE REPLACEMENT

Drive out the ball races.

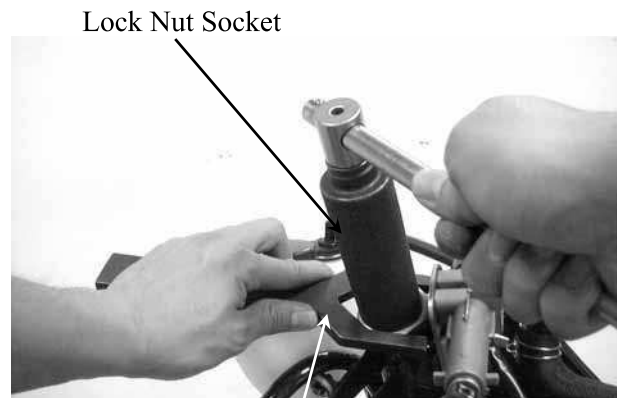

Lock Nut Wrench



Top Cone Race



Bottom Cone Race



Ball Race Remover

Drive in new ball races.

* Be sure to drive the ball races into place completely.



INSTALLATION

Apply grease to the top and bottom ball races and install 26 steel balls on the top ball race and 19 steel balls on the bottom ball race. Then, install the front fork.

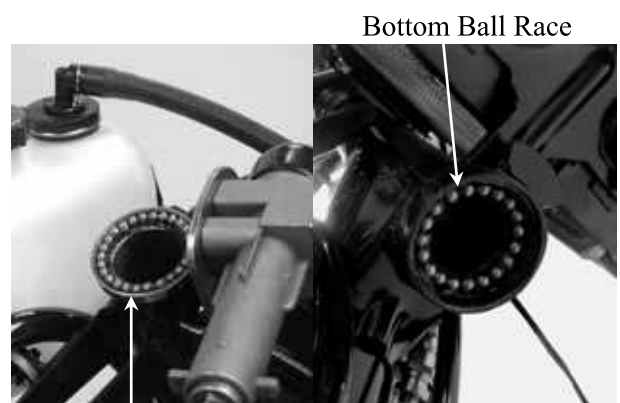

Top Ball Race

Apply grease to the top cone race and install it.

Tighten the top cone race and then turn the steering stem right and left several times to make steel balls contact each other closely.

* Check that the steering stem rotates freely without vertical play.



Install the steering stem lock nut and tighten it while holding the top cone race.

Torque: 78.4~117.6N-m

- Install the front wheel. (⇒14-7)
- Install the front brake caliper. (⇒14-12)
- Install the front inner fender. (⇒2-6)
- Install the throttle grip and the right and left handlebar switches. (⇒14-5)
- Install the right and left brake master cylinders. (⇒14-5)

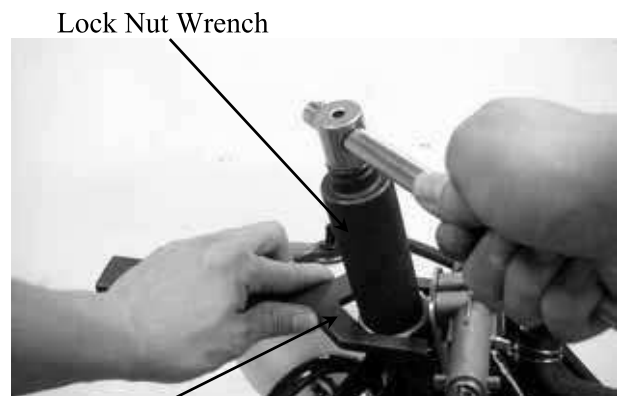

Lock Nut Wrench

15. REAR BRAKE/REAR FORK/REAR WHEEL/REAR SHOCK ABSORBER

REAR BRAKE/REAR FORK/REAR WHEEL/ REAR SHOCK ABSORBER

SCHEMATIC DRAWING -----	15-1
SERVICE INFORMATION-----	15-2
TROUBLESHOOTING-----	15-2
REAR BRAKE -----	15-3
REAR FORK -----	15-4
REAR WHEEL-----	15-4
REAR SHOCK ABSORBER -----	15-5

15. REAR BRAKE/REAR FORK/REAR WHEEL/REAR SHOCK ABSORBER

SCHEMATIC DRAWING

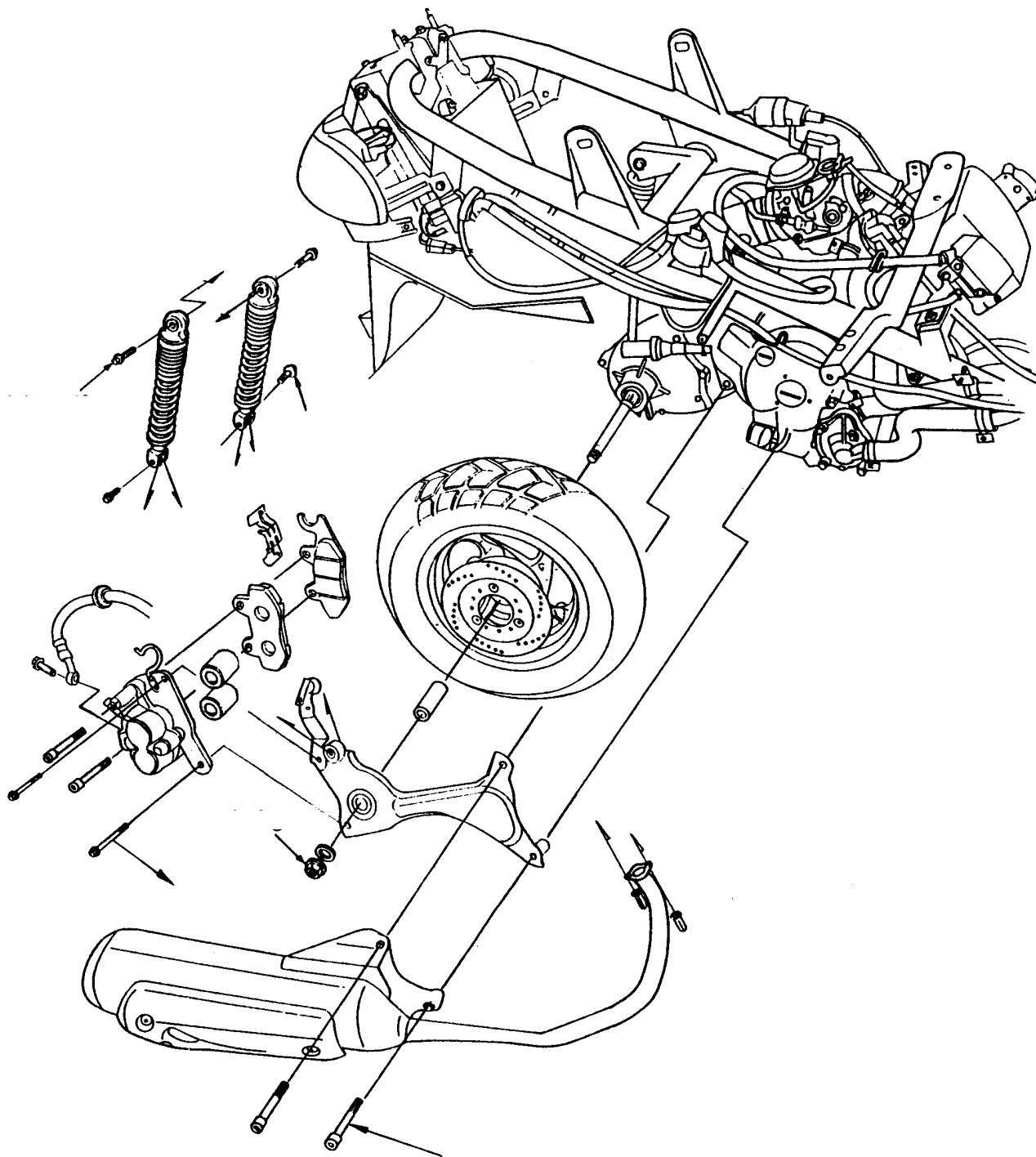

15. REAR BRAKE/REAR FORK/REAR WHEEL/REAR SHOCK ABSORBER

SERVICE INFORMATION

GENERAL INSTRUCTIONS

- When performing the services stated in this section, the engine and exhaust muffler must be cold to avoid scalding.
- During servicing, keep oil or grease off the brake pads and brake disk.

SPECIFICATIONS

Item	Standard (mm)	Service Limit (mm)
Rear wheel rim runout	—	2.0
Rear shock absorber spring free length	232.9	226
Rear brake disk thickness	3.5~3.8	3.0
Rear brake disk runout	—	0.30
Rear brake master cylinder I.D.	12.700~12.743	12.755
Rear brake master cylinder piston O.D.	12.657~12.684	12.645
Rear brake caliper cylinder I.D.	25.400~25.45	25.45
Rear brake caliper piston O.D.	25.335~25.368	25.30

TORQUE VALUES

Exhaust muffler lock bolt	29.4~39.2N-m
Rear axle nut	78.4~98N-m
Rear shock absorber lower mount bolt	19.6~29.4N-m
Rear shock absorber upper mount bolt	39.2N-m
Rear damper lock nut	14.7~24.5N-m (apply locking agent)
Rear brake caliper bolt	19.6~29.4N-m

SPECIAL TOOLS

- Rear shock absorber remover
- Shock absorber spring compressor

TROUBLESHOOTING

Rear wheel wobbling

- Bent rim
- Faulty tire
- Axle not tightened properly

Soft rear shock absorber

- Weak shock absorber spring
- Damper oil leaks

Rear wheel noise

- Worn rear wheel axle bearings
- Worn rear fork bearings
- Deformed rear fork

Poor brake performance

- Air in brake system
- Deteriorated brake fluid
- Contaminated brake pad surface
- Worn brake pads
- Clogged brake fluid line
- Deformed brake disk
- Unevenly worn brake caliper

15. REAR BRAKE/REAR FORK/REAR WHEEL/REAR SHOCK ABSORBER

REAR BRAKE

REAR BRAKE CALIPER REMOVAL

First remove the exhaust muffler. (⇒2-6)
Remove the rear brake fluid tube bolt and disconnect the brake fluid tube.
Remove the two bolts attaching the rear brake caliper.
Remove the rear brake caliper.

* When removing the brake fluid tube, use shop towels to cover plastic parts and coated surfaces to avoid damage.

INSPECTION

Inspect the brake pads and brake disk.
Visually check the brake pad thickness and it should not exceed the wear indicator mark.
Measure the brake disk thickness.

Service Limit: 3.0mm replace if below

DISASSEMBLY

Disassemble the rear brake caliper. (⇒14-11)
Inspect and assemble the rear brake caliper . (⇒14-12)

Note: The rear brake caliper and front brake caliper have the same specification.

INSTALLATION

Install the brake caliper to the rear fork and tighten the two bolts.

Torque: 24.5~34.3N-m

Connect the brake fluid tube to the brake caliper and tighten the fluid tube bolt.
Fill the brake reservoir with the specified brake fluid and bleed air from the brake system. (⇒14-10)

* When installing the brake fluid tube, be sure to install the two copper sealing washers.

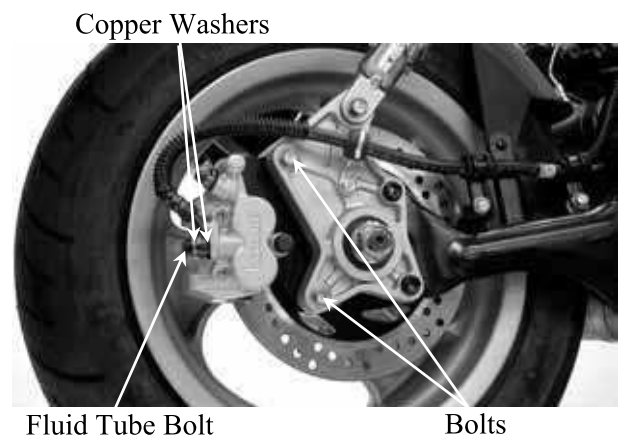
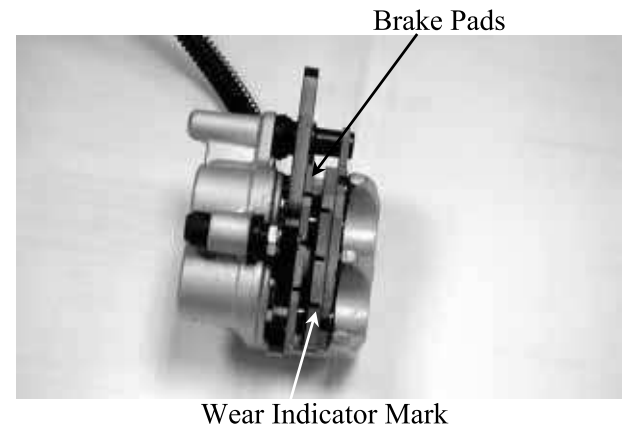
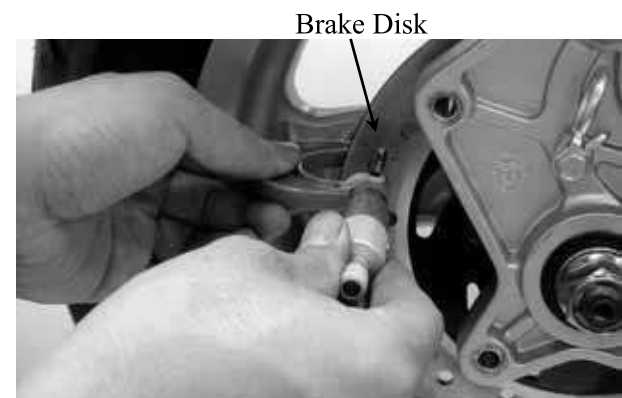
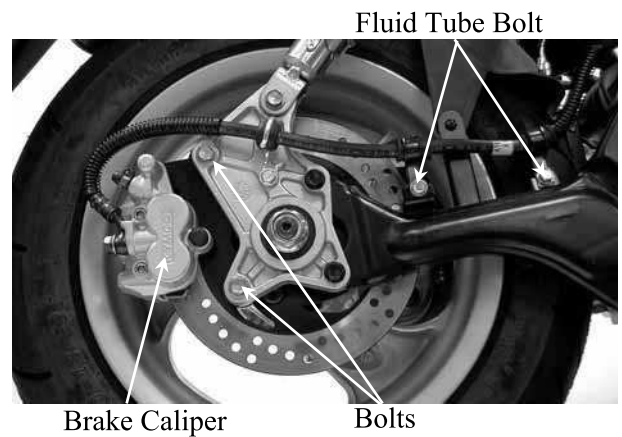

15. REAR BRAKE/REAR FORK/REAR WHEEL/REAR SHOCK ABSORBER

REAR FORK

REMOVAL

Remove the exhaust muffler. (⇒2-6)
Remove the rear brake caliper. (⇒15-3)
Remove the right rear shock absorber lower mount bolt.
Remove the rear axle nut and remove the collar.
Remove the rear fork.
The installation sequence is the reverse of removal.

Turn the inner race of each bearing with your finger to see if they turn smoothly and quietly.

Also check if the outer race fits tightly in the hub.

Replace the bearings if the races do not turn smoothly, quietly, or if they fit loosely in the hub.

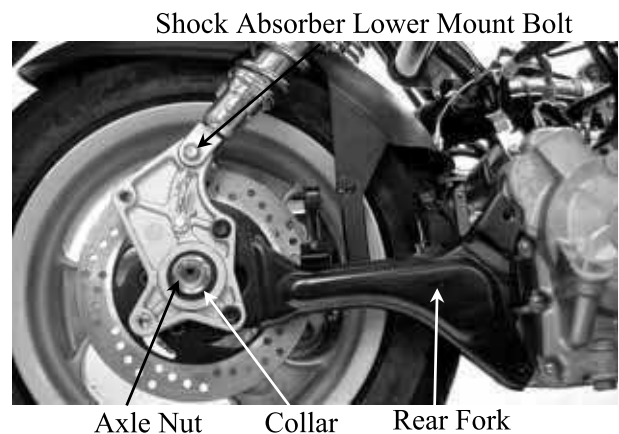

REAR WHEEL

REMOVAL

Remove the exhaust muffler. (⇒2-6)
Remove the rear brake caliper. (⇒15-3)
Remove the rear fork.
Remove the rear axle collar.
Remove the rear wheel.

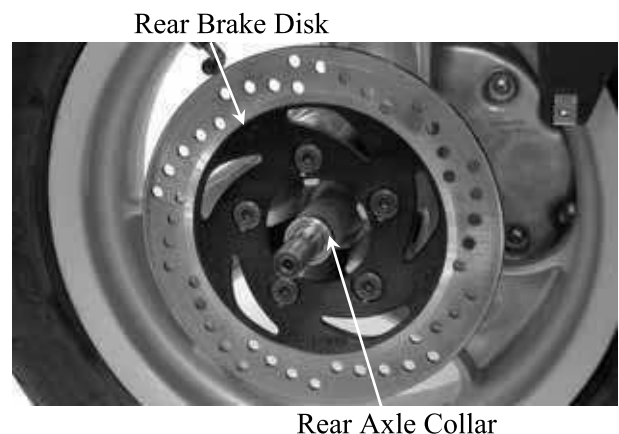

INSPECTION

Measure the rear wheel rim runout.

Service Limits:

Radial: 2.0mm replace if over

Axial: 2.0mm replace if over

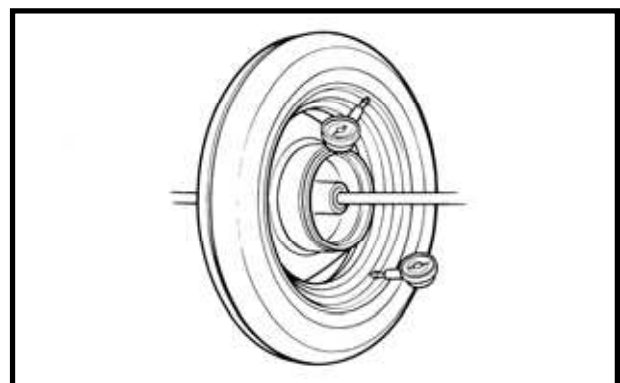

15. REAR BRAKE/REAR FORK/REAR WHEEL/REAR SHOCK ABSORBER

INSTALLATION

The installation sequence is the reverse of removal.

Torque:

- Rear shock absorber lower mount bolt: 19.6~29.4N-m
- Rear axle nut: 78.4~98N-m

Shock Absorber Lower Mount Bolt

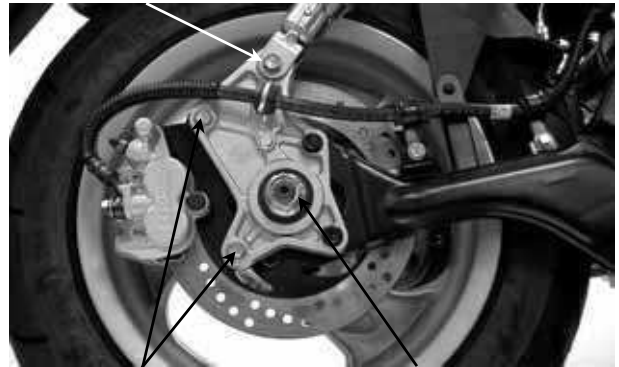

Brake Caliper Bolts

Axle Nut

ADJUSTABLE REAR CUSHION

To suit scooter behaviour to load condition rear cushion could be adjusted in spring preload.

It is possible to adjust rear cushion in three positions:

- A position "soft"
- B position "medium"
- C position "hard"

When you adjust rear cushion, the spring preload of rear cushions must be the same.

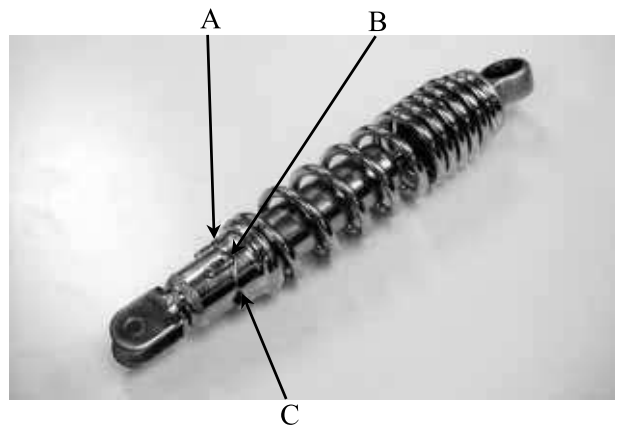

Upper Mount Bolts

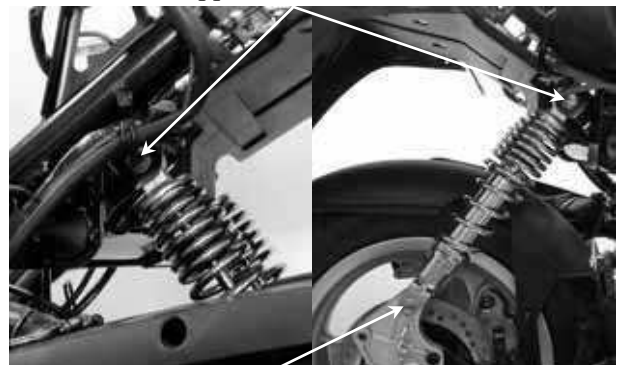

Lower Mount Bolts

REAR SHOCK ABSORBER

REMOVAL

- Remove the rear carrier and hand rail. (⇒2-3)
- Remove the met-in box. (⇒2-3)
- Remove the two air cleaner bolts.
- Remove the rear shock absorber upper mount bolt.
- Remove the right/left rear shock absorber upper and lower mount bolts.
- Remove the right and left rear shock absorbers.

DISASSEMBLY

Disassemble the right and left rear shock absorbers using the rear shock absorber remover.

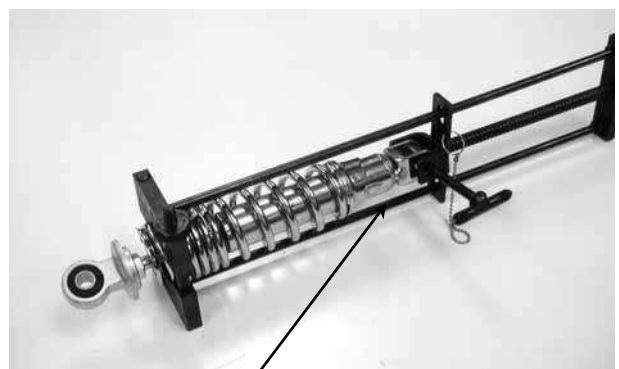

Rear Shock Absorber Remover

15. REAR BRAKE/REAR FORK/REAR WHEEL/REAR SHOCK ABSORBER

INSPECTION

Inspect the damper rod for bending or damage.
Inspect the damper for oil leaks.
Inspect the damper rubber for deterioration or damage.

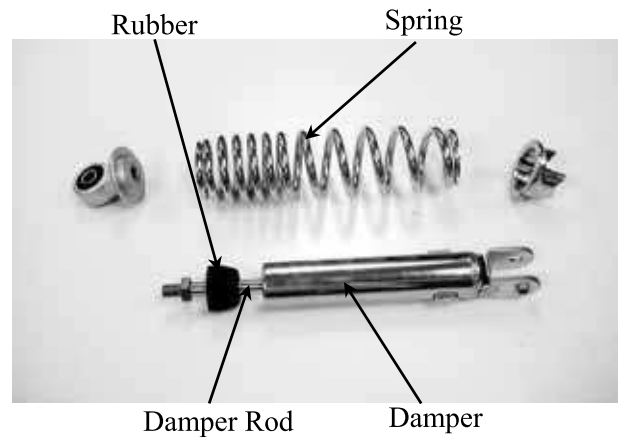

Measure the front shock absorber spring free length.

Service Limit:

Right: 226mm

Left : 226mm

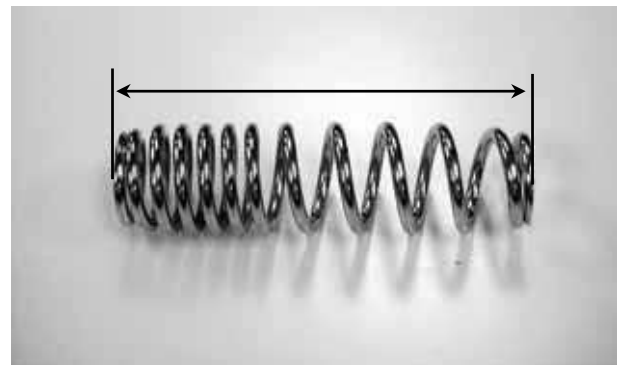

ASSEMBLY

Assemble the rear shock absorbers in the reverse order of disassembly.



INSTALLATION

Install the rear shock absorbers in the reverse order of removal.

Torque:

Upper Mount Bolt: 39.2N-m

Lower Mount Bolt: 19.6~29.4N-m

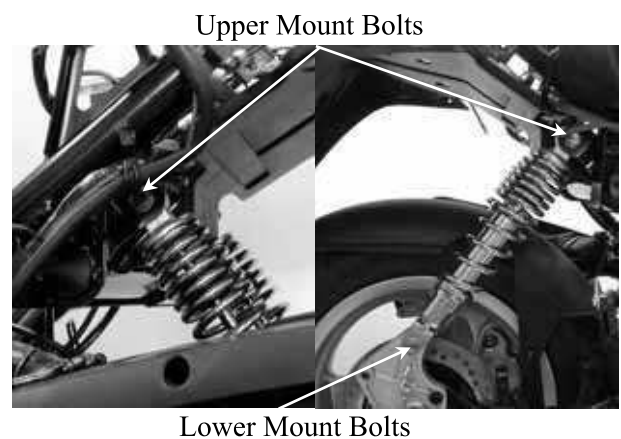

16. BATTERY/CHARGING SYSTEM

16

BATTERY/CHARGING SYSTEM

CHARGING SYSTEM LAYOUT -----	16-1
SERVICE INFORMATION-----	16-2
TROUBLESHOOTING-----	16-3
BATTERY -----	16-4
CHARGING SYSTEM -----	16-5
A.C. GENERATOR INSPECTION -----	16-5
REGULATOR/RECTIFIER INSPECTION-----	16-6
CHARGING INDICATOR INSPECTION-----	16-7

16. BATTERY/CHARGING SYSTEM

CHARGING SYSTEM LAYOUT

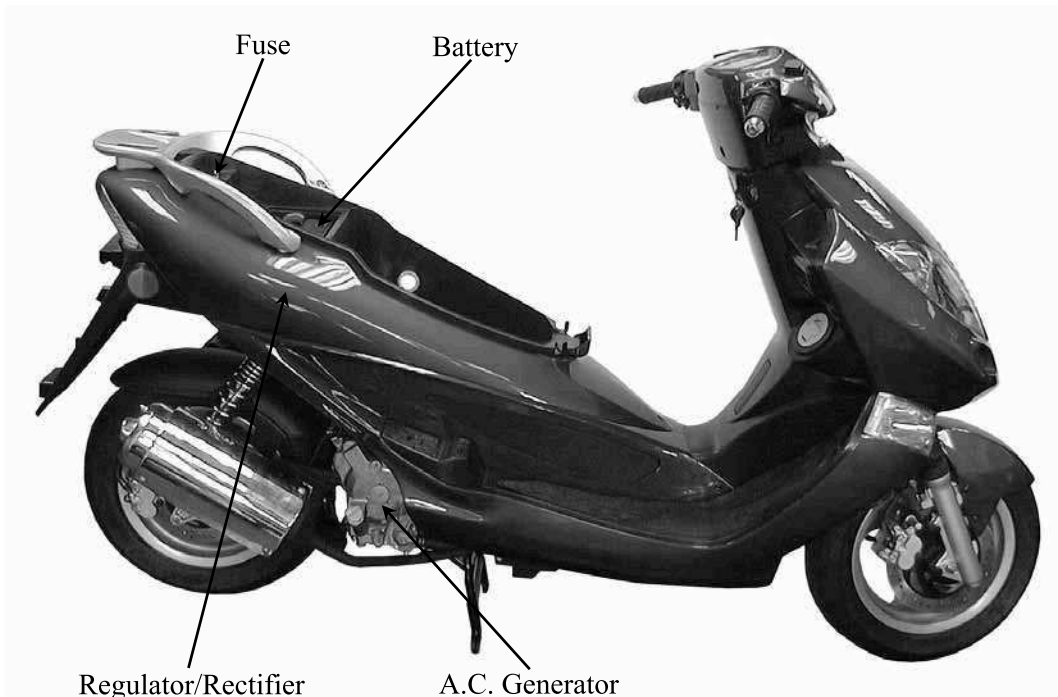

CHARGING CIRCUIT

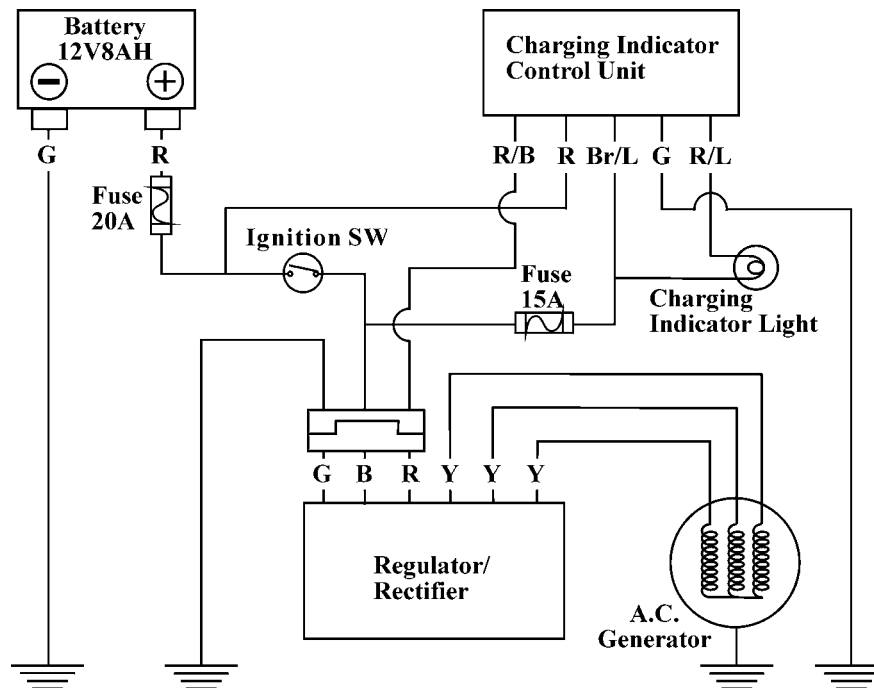

SERVICE INFORMATION

GENERAL INSTRUCTIONS

The battery electrolyte (sulfuric acid) is poisonous and may seriously damage the skin and eyes. Avoid contact with skin, eyes, or clothing. In case of contact, flush with water and get prompt medical attention

- The battery can be charged and discharged repeatedly. If a discharged battery is not used for a long time, its service life will be shortened. Generally, the capacity of a battery will decrease after it is used for 2~3 years. A capacity-decreased battery will resume its voltage after it is recharged but its voltage decreases suddenly and then increases when a load is added.
- When a battery is overcharged, some symptoms can be found. If there is a short circuit inside the battery, no voltage is produced on the battery terminals. If the rectifier won't operate, the voltage will become too high and shorten the battery service life.
- If a battery is not used for a long time, it will discharge by itself and should be recharged every 3 months.
- A new battery filled with electrolyte will generate voltage within a certain time and it should be recharged when the capacity is insufficient. Recharging a new battery will prolong its service life.
- Inspect the charging system according to the sequence specified in the Troubleshooting.
- Do not disconnect and soon reconnect the power of any electrical equipment because the electronic parts in the regulator/rectifier will be damaged. Turn off the ignition switch before operation.
- It is not necessary to check the MF battery electrolyte or fill with distilled water.
- Check the load of the whole charging system.
- Do not quick charge the battery. Quick charging should only be done in an emergency.
- Remove the battery from the motorcycle for charging.
- When replacing the battery, do not use a traditional battery.
- When charging, check the voltage with an electric tester.

SPECIFICATIONS

Item		Standard	
Battery	Capacity		12V8AH
	Voltage (20°C)	Fully charged	13.2V
		Undercharged	12.3V
	Charging current		STD: 0.9A Quick: 4.0A
	Charging time		STD: 5-10hr Quick: 30min
A.C. Generator	Capacity		160W/500rpm
	Charging coil resistance (20°C)		Yellow~Yellow 0.6~1.6Ω
	Charging rpm		1300rpm max (14V)
	Charging performance		8A min/5000rpm
Regulator/Rectifier	Limit voltage		14.5±0.5V

TESTING INSTRUMENTS

Ammeter
Electric tester
Tachometer

TORQUE VALUES

Pulser coil bolt 4.9N-m
Coil lock bolt 8.8N-m
Flywheel nut 34.3~44.1N-m

16. BATTERY/CHARGING SYSTEM

SPECIAL TOOLS

Universal holder

Flywheel puller

TROUBLESHOOTING

No power

- Dead battery
- Disconnected battery cable
- Fuse burned out
- Faulty ignition switch

Low power

- Weak battery
- Loose battery connection
- Charging system failure
- Faulty regulator/rectifier

Intermittent power

- Loose battery cable connection
- Loose charging system connection
- Loose connection or short circuit in ignition system

Charging system failure

- Loose, broken or shorted wire or connector
- Faulty regulator/rectifier
- Faulty A.C. generator

16. BATTERY/CHARGING SYSTEM

BATTERY

Remove the seat and met-in box. (⇒2-3)
 Remove the battery cover screw and the battery cover.
 Remove the battery.
 First disconnect the battery negative (-) cable and then the positive (+) cable.

When disconnecting the battery positive (+) cable, do not touch the frame with tool; otherwise it will cause short circuit and sparks to fire the fuel.

The installation sequence is the reverse of removal.

First connect the positive (+) cable and then negative (-) cable to avoid short circuit.

BATTERY VOLTAGE INSPECTION (OPEN CIRCUIT VOLTAGE)

Disconnect the battery cables.
 Measure the voltage between the battery terminals.

Fully charged : 13.2V
 Undercharged : 12.3V max.

* Battery charging inspection must be performed with a voltmeter.

CHARGING

Connect the charger positive (+) cable to the battery positive (+) terminal.
 Connect the charger negative (-) cable to the battery negative (-) terminal.

- Keep flames and sparks away from a charging battery.
- Turn power ON/OFF at the charger, not at the battery terminals to prevent sparks near the battery.
- Charge the battery according to the current specified on the battery.
- During quick charging, the battery temperature should not exceed 45°C.

*

- Quick charging should only be done in an emergency.
- Measure the voltage 30 minutes after the battery is charged.

Charging current: Standard : 0.9A
 Quick : 4A
 Charging time : Standard : 5~10 hours
 Quick : 30 minutes
 After charging: Open circuit voltage: 12.8V min.

Battery Cover Screw



16. BATTERY/CHARGING SYSTEM

CHARGING SYSTEM

CURRENT TEST

- * Use a fully charged battery (12.8V min.) to check the charging system.

Warm up the engine before taking readings. Connect an electric tester across the battery terminals.

Disconnect the red wire from the fuse terminal and connect an ammeter between the red wire lead and the fuse terminal.

Attach a tachometer to the engine.

Start the engine and gradually increase the engine speed to measure the limit voltage and current.

Limit Voltage/Current: 14~15V/0.5A max. (5000rpm max.)

If the limit voltage is not within the specified range, check the regulator/rectifier.



Red Wire



PERFORMANCE TEST

Engine Speed	2500rpm	5000rpm
Charging Current	6A min.	8A min.

- * When measuring the charging current, disconnect the black wire from the regulator/rectifier wire coupler.

If the readings do not meet the specified values, check the regulator/rectifier.

A.C. GENERATOR INSPECTION

- * This test can be made without removing the stator from the engine. Disconnect the yellow wire from the auto bystarter.

Remove the frame center cover.

Disconnect the A.C. generator connector.

Check the continuity between the yellow wires and ground.

There should be continuity between the yellow wires and no continuity between each yellow wire and ground.

Resistance:

Yellow~Yellow	0.6~1.6Ω
---------------	----------

A.C. Generator Connector



16. BATTERY/CHARGING SYSTEM

A.C. GENERATOR REMOVAL

A.C. generator removal (⇒10-3)

A.C. generator installation (⇒10-6)

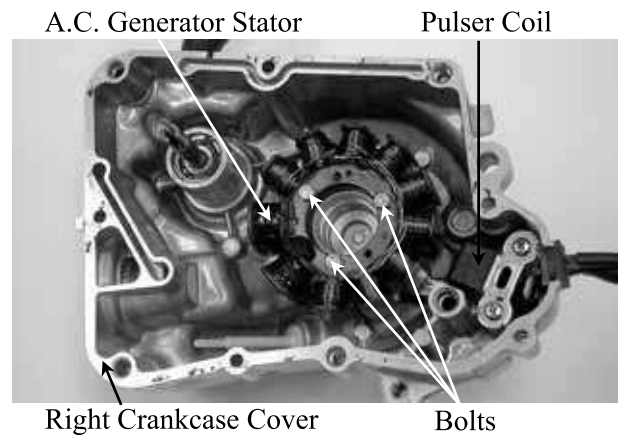

REGULATOR/RECTIFIER

INSPECTION

Remove the frame front cover. (⇒2-5)

Remove the regulator/rectifier wire coupler. Check the continuity between the wire terminals.

Normal Direction: Continuity

	(+) Probe	(-) Probe
I	Yellow	Green
II	Red/Black	Yellow

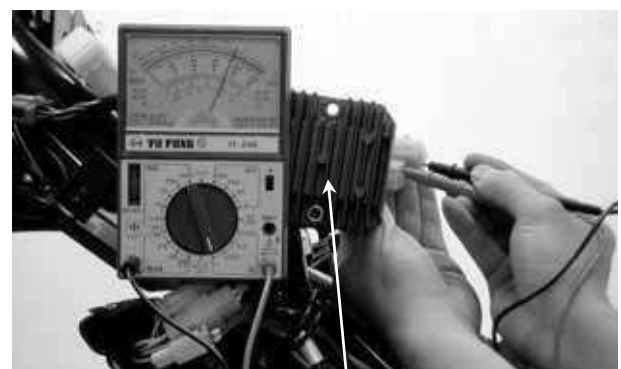

Regulator/Rectifier

Reverse Direction: No Continuity

	(+) Probe	(-) Probe
I	Green	Yellow
II	Yellow	Red/Black

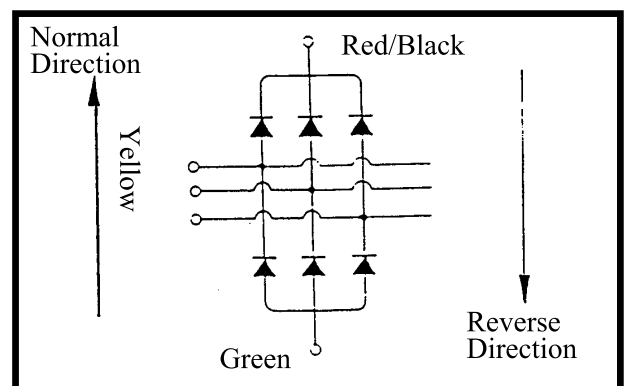

VOLTAGE REGULATION TEST

Connect a voltmeter across the battery terminals.

Start the engine and gradually increase the engine speed.

The battery terminal voltage should be within 14.0~15.0V.

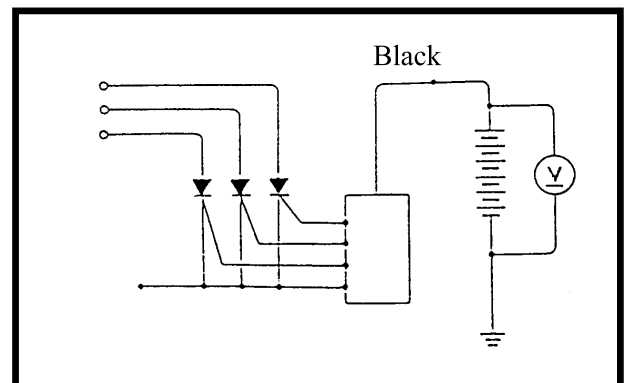

16. BATTERY/CHARGING SYSTEM

CHARGING INDICATOR INSPECTION

Use Sanwa electric tester for testing.
Take readings in $XK\Omega$ range.

Unit: $K\Omega$

Probe (+) Probe (-)	Red/Black	Red	Brown/Blue	Red/Blue	Green
Red/Black		4~5 Ω	45~55	35~55	20~40
Red	∞		∞	∞	∞
Brown/Blue	20~40	30~45		20~30	15~25
Red/Blue	∞	∞	∞		∞
Green	2~20	5~30	15~25	4~8	

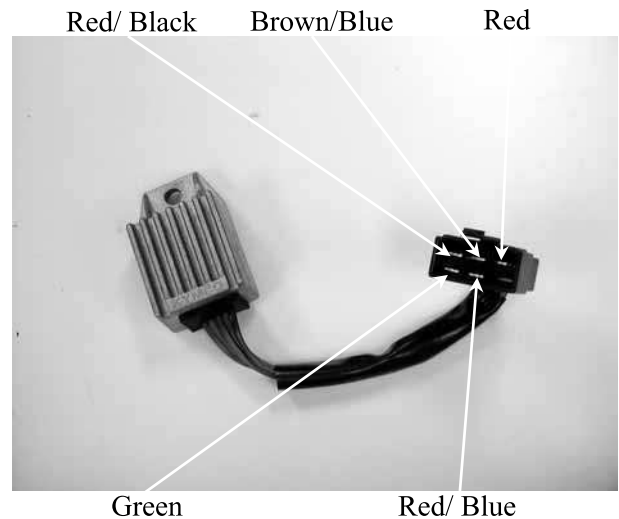

Charging indicator inspection :

1. Turn on the ignition switch. The Charging lamp should be lighten.
2. Start the engine. The Charging lamp should be went out.
3. Inspect the output voltage of Charging indicator :
 - ~ Disconnect the battery (+) cable.
 - ~ Use the voltmeter.
 - ~ Connect the voltage (+) cable to the red wire of charging indicator.
 - ~ Connect the voltage (-) cable to the ground.
 - ~ Start the engine. Open the throttle valve to keep at 8000 rpm.
 - ~ Standard output voltage is 12~14V.

17. IGNITION SYSTEM

17

IGNITION SYSTEM

IGNITION SYSTEM LAYOUT-----	17-1
SERVICE INFORMATION-----	17-2
TROUBLESHOOTING-----	17-2
SPARK PLUG-----	17-3
IGNITION COIL INSPECTION -----	17-3
A.C. GENERATOR INSPECTION -----	17-4
CDI UNIT RESISTANCE INSPECTION-----	17-5

17. IGNITION SYSTEM

IGNITION SYSTEM LAYOUT

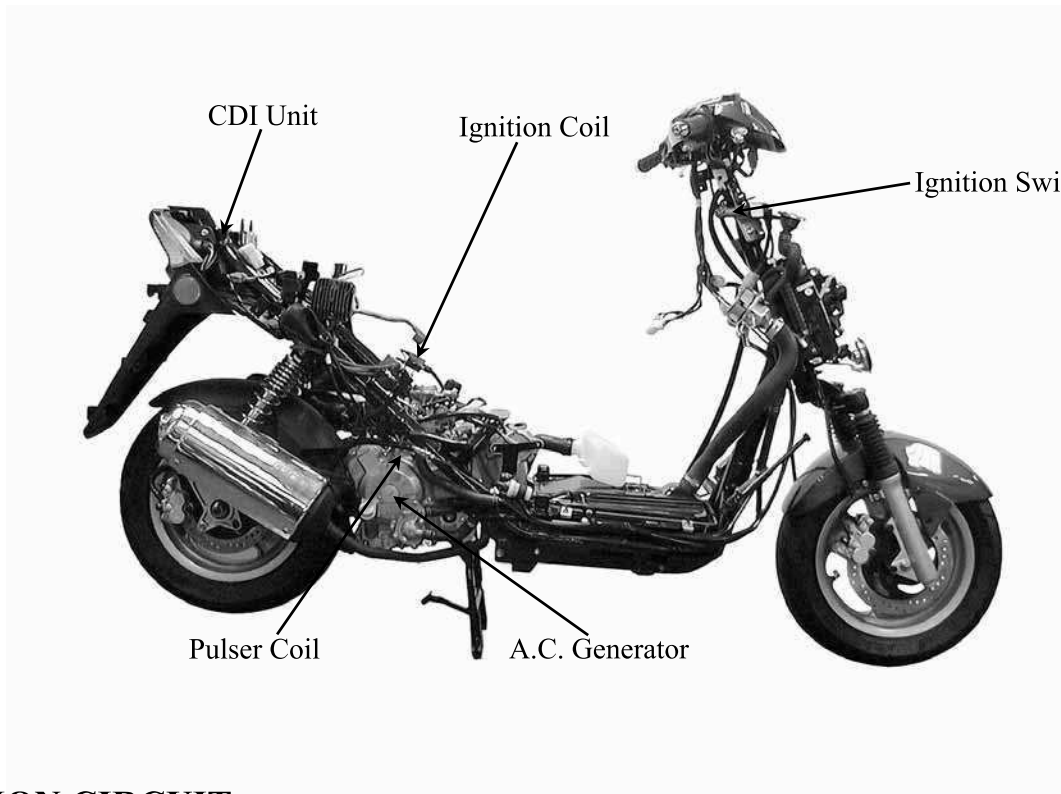

IGNITION CIRCUIT

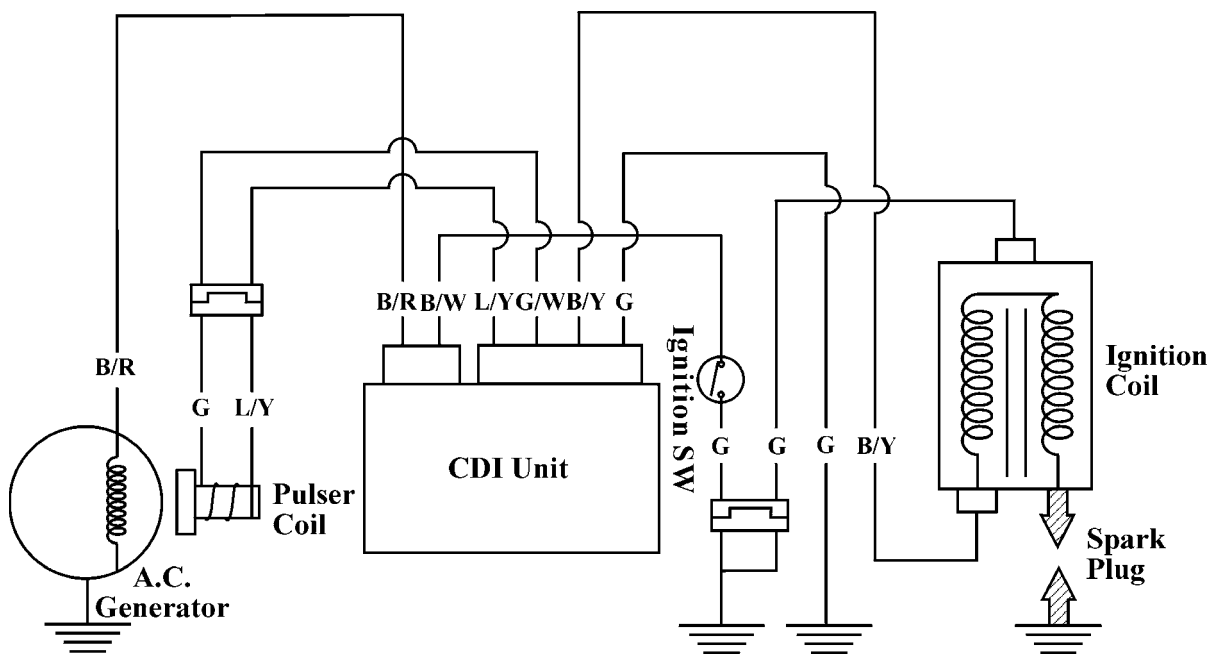

17. IGNITION SYSTEM

SERVICE INFORMATION

GENERAL INSTRUCTIONS

- Check the ignition system according to the sequence specified in the Troubleshooting. (⇒1-28)
- The ignition system adopts CDI unit and the ignition timing cannot be adjusted.
- If the timing is incorrect, inspect the CDI unit and A.C. generator and replace any faulty parts.
Inspect the CDI unit with a CDI tester
- Loose connector and poor wire connection are the main causes of faulty ignition system. Check each connector before operation.
- Use of spark plug with improper heat range is the main cause of poor engine performance.
- The inspections in this section are focused on maximum voltage. The inspection of ignition coil resistance is also described in this section.
- Inspect the ignition switch according to the continuity table specified in page 20-3.
- Inspect the spark plug referring to Section 3.
- Remove the A.C. generator and pulser coil referring to Section 10.

SPECIFICATIONS

Item		Standard	
Spark plug	Standard type	NGK DP7EA9	
	Hot type	NGK DP6EA9	
	Cold type	NGK DP8EA9	
Spark plug gap		0.8~1.0mm	
Ignition timing	“F” mark	BTDC 10° ±1°	
	Full advance	BTDC 27°	
Ignition coil resistance (20°C)	Primary coil		0.16~1Ω
	Secondary coil	without plug cap	3.6~4.6KΩ
		with plug cap	7.6~9.6KΩ
Pulser coil resistance (20°C)		50~170Ω	
Exciter coil resistance (20°C)		50~350Ω	
Ignition coil primary side max. voltage		244V	
Pulser coil max. voltage		10.5V	
Exciter coil max. voltage		244V	

TESTING INSTRUMENT

Electric tester

TROUBLESHOOTING

No spark at plug

- Faulty spark plug
- Poorly connected, broken or shorted wire
- Faulty ignition switch
- Faulty ignition coil
- Faulty CDI unit
- Faulty A.C. generator

Engine starts but turns poorly

- Ignition primary circuit
 - Faulty ignition coil
 - Poorly connected wire or connector
 - Poorly contacted ignition switch
- Ignition secondary circuit
 - Faulty ignition coil
 - Faulty spark plug
 - Faulty high-tension wire
 - Poorly insulated plug cap
- Improper ignition timing
 - Faulty A.C. generator
 - Stator not installed properly
 - Faulty CDI unit

17. IGNITION SYSTEM

SPARK PLUG

For spark plug inspection and adjustment, refer to page 3-5.

IGNITION COIL INSPECTION

Remove the seat and met-in box. (⇒2-3)
Remove the ignition coil



IGNITION COIL CONTINUITY TEST

Inspect the continuity of the ignition coil, primary coil and secondary coil.

* This is a general test. Accurate ignition coil test must be performed with a CDI tester.

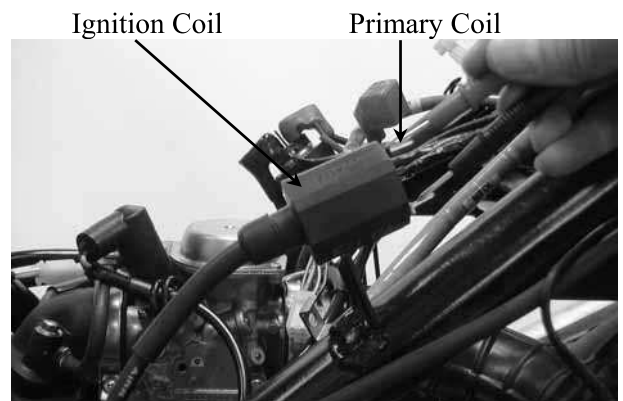

Measure the ignition coil resistances at 20°C.
SECONDARY COIL WITH PLUG CAP

Primary coil	0.16~1Ω
Secondary coil without plug cap	3.4~4.6KΩ
Secondary coil with plug cap	7.6~9.6KΩ

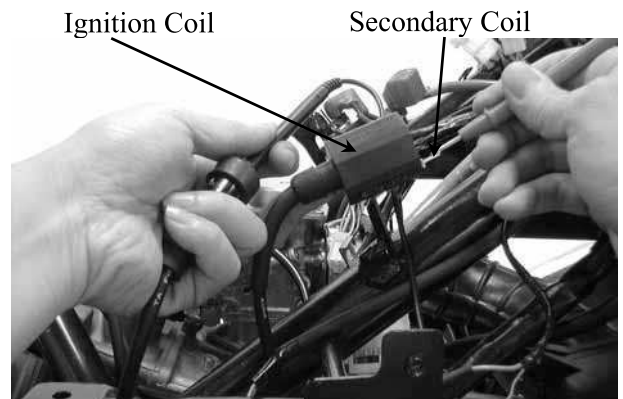

SECONDARY COIL WITHOUT PLUG CAP



17. IGNITION SYSTEM

A .C. GENERATOR INSPECTION

EXCITER COIL/PULSER COIL INSPECTION

* This test is performed with the stator installed in the engine.

Remove the frame right cover. (⇒2-4)
 Disconnect the A.C. generator connector.
 Measure the exciter coil resistance between the black/red wire terminal and ground.

Black/red ~ Ground	50 ~ 250Ω
--------------------	-----------

* Measure the resistance in the XΩ range.

For A.C. generator removal/installation, refer to pages 10-3 and 10-6.
 Disconnect the pulser coil wire coupler.
 Measure the pulser coil resistance between the blue/white and green/white wire terminals.

Blue/white ~ Green/white	50 ~ 170Ω
--------------------------	-----------

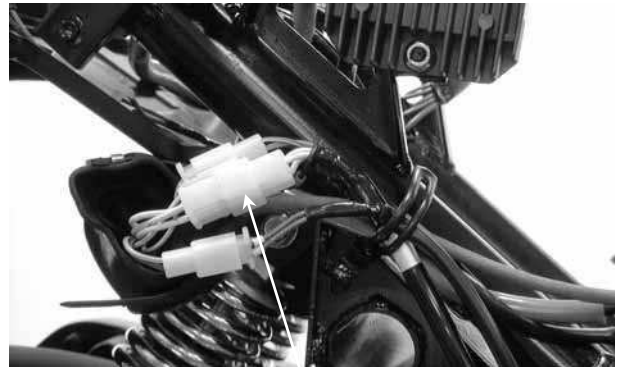

A.C. Generator Connector



Pulser Coil Wire Coupler

17. IGNITION SYSTEM

CDI UNIT

RESISTANCE INSPECTION

Measure the resistance between the terminals. Replace the CDI unit if the readings are not within the specifications in the table below.

- *
- Due to the semiconductor in circuit, it is necessary to use a specified tester for accurate testing. Use of an improper tester in an improper range may give false readings.
 - Use a Sanwa Electric Tester (07308-0020000) or Kowa Electric Tester (TH-5H).
 - In this table, "Needle swings then returns" indicates that there is a charging current applied to a condenser. The needle will then remain at "∞" unless the condenser is discharged.

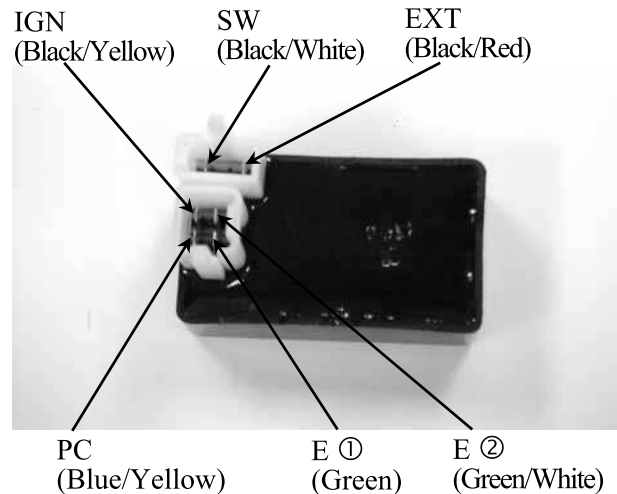

Use the x KΩ range for the Sanwa Tester.
Use the x 100Ω range for the Kowa Tester.

Unit: KΩ

(+)Probe (-)Probe	SW (Black/White)	EXT (Black/Red)	PC (Blue/Yellow)	E ① ② (Green • Green/White)	IGN (Black/Yellow)
SW (Black/White)		∞	∞	∞	∞
EXT (Black/Red)	1-10		Needle swings then returns	Needle swings then returns	∞
PC (Blue/Yellow)	5-50	30-100		20-80	∞
E ① ② (Green • Green/White)	5-20	1-10	5-40		∞
IGN (Black/Yellow)	∞	∞	∞	∞	

18. STARTING SYSTEM

18

STARTING SYSTEM

STARTING SYSTEM LAYOUT -----	18-1
SERVICE INFORMATION-----	18-2
TROUBLESHOOTING-----	18-2
STARTER MOTOR -----	18-3
STARTER CLUTCH INSPECTION-----	18-5
STARTER RELAY INSPECTION-----	18-6

18. STARTING SYSTEM

STARTING SYSTEM LAYOUT

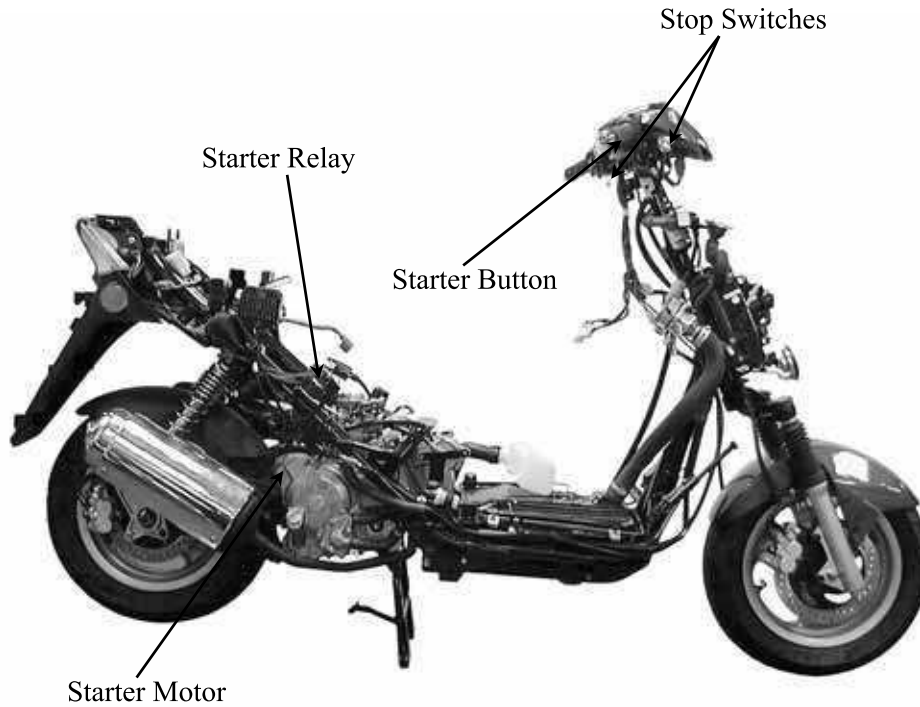

STARTING CIRCUIT

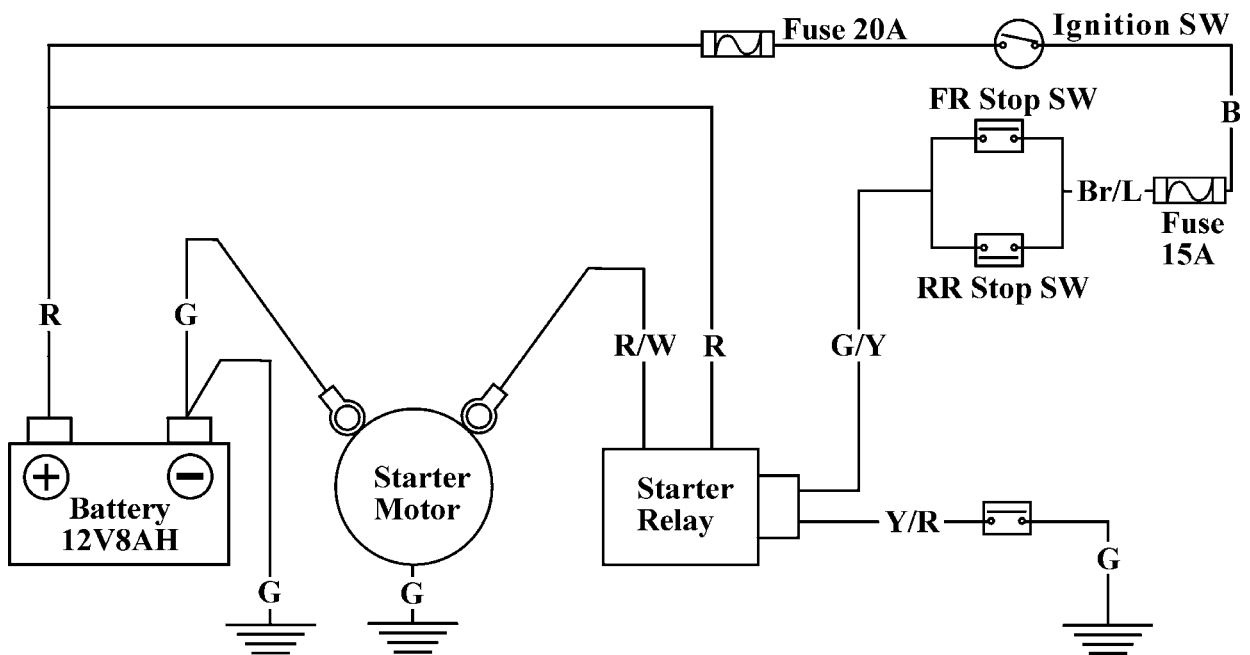

18. STARTING SYSTEM

SERVICE INFORMATION

GENERAL INSTRUCTIONS

- The removal of starter motor can be accomplished with the engine installed.
- For the starter clutch removal, refer to page 10-3.
- After the starter clutch is installed, be sure to add the engine oil and coolant and then bleed air from the cooling system.

SPECIFICATIONS

Item	Standard (mm)	Service Limit (mm)
Starter motor brush length	12.5mm	8.5mm

TORQUE VALUES

Starter motor mounting bolt	6.7~10.8N-m
Starter motor case screw	2.9~4.9N-m
Starter clutch bolt	9.8~13.7N-m

SPECIAL TOOLS

Flywheel holder
Flywheel puller

TROUBLESHOOTING

Starter motor won't turn

- Fuse burned out
- Weak battery
- Faulty ignition switch
- Faulty starter clutch
- Faulty front or rear stop switch
- Faulty starter relay
- Poorly connected, broken or shorted wire
- Faulty starter motor

Lack of power

- Weak battery
- Loose wire or connection
- Foreign matter stuck in starter motor or gear

Starter motor rotates but engine does not start

- Faulty starter pinion
- Starter motor rotates reversely
- Weak battery

18. STARTING SYSTEM

STARTER MOTOR

REMOVAL

- * Before removing the starter motor, turn the ignition switch OFF and remove the battery ground. Then, turn on the ignition switch and push the starter button to see if the starter motor operates properly.

Remove the seat, met-in box and frame center cover. (⇒2-3)

Remove the waterproof rubber jacket and disconnect the starter motor cable.

Remove the two starter motor mounting bolts and the motor.

DISASSEMBLY

Remove the two starter motor case screws, front cover, rear cover, motor case and other parts.

INSPECTION

Inspect the removed parts for wear, damage or discoloration. Replace if necessary. Clean the commutator if there is metal powder between the segments.

Check for continuity between pairs of the commutator segments and there should be continuity.

Also, make a continuity check between individual commutator segments and the armature shaft. There should be no continuity.



Starter Motor Cable

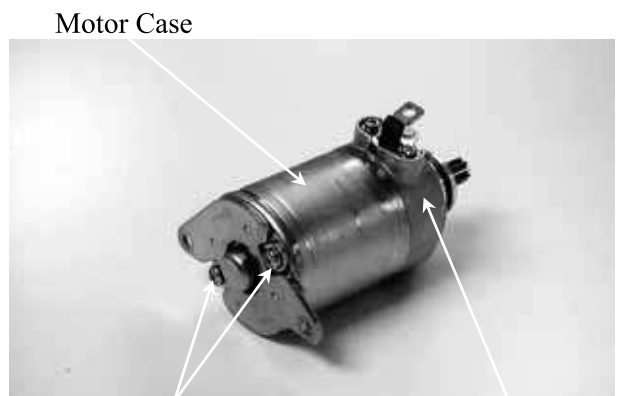

Motor Case

Case Screws

Front Cover



Commutator

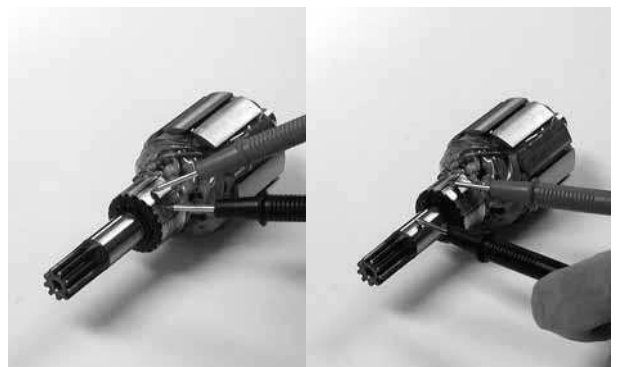

18. STARTING SYSTEM

STARTER MOTOR CASE CONTINUITY CHECK

Check to confirm that there is no continuity between the starter motor wire terminal and the motor front cover.

Also check for the continuity between the wire terminal and each brush.

Replace if necessary.



Wire Terminal

Measure the length of the brushes.

Service Limit: 8.5mm replace if below



Check for continuity between the brushes. If there is continuity, replace with new ones.



Check if the needle bearing in the front cover turns freely and has no excessive play.

Replace if necessary.

Check the dust seal for wear or damage.

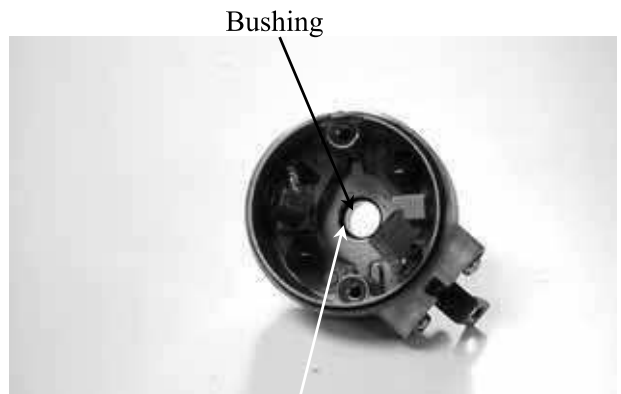

Dust Seal

18. STARTING SYSTEM

ASSEMBLY

Apply grease to the dust seal in the front cover.
Install the brushes onto the brush holders.
Apply a thin coat of grease to the two ends of the armature shaft.
Insert the commutator into the front cover.



Front Cover

Install a new O-ring to the front cover.
Install the starter motor case, aligning the tab on the motor case with the groove on the front cover.
Tighten the starter motor case screws.

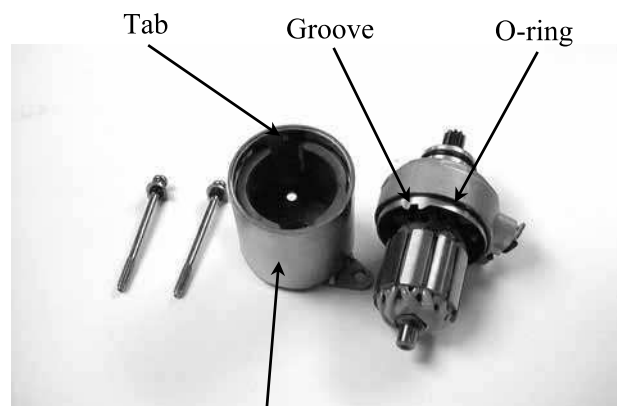

Motor Case

INSTALLATION

Connect the starter motor cable.
Check the O-ring for wear or damage and replace if necessary.
Apply grease to the O-ring and install it to the starter motor.
Tighten the two mounting bolts.

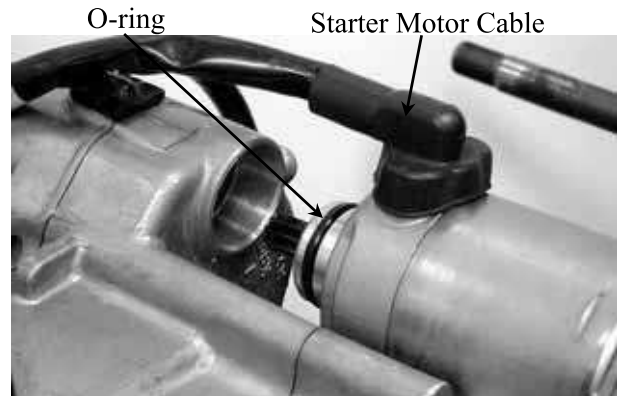

STARTER CLUTCH INSPECTION

Refer to pages 10-4 and 10-5 for the starter clutch removal, inspection and installation.



18. STARTING SYSTEM

STARTER RELAY INSPECTION

Disconnect the starter relay wire connector. Check for continuity between the yellow/red wire terminal and ground.

There should be continuity when the starter button is depressed.

If there is no continuity, check the starter button for continuity and inspect the wire.



Yellow/Red Wire

OPERATION TEST

Connect the electric tester to the starter relay larger terminals that connect to the battery positive cable and the starter motor cable.

Connect a fully charged battery across the starter relay yellow/red and green/yellow wire terminals.

Check for continuity between the starter relay large terminals. The relay is normal if there is continuity.

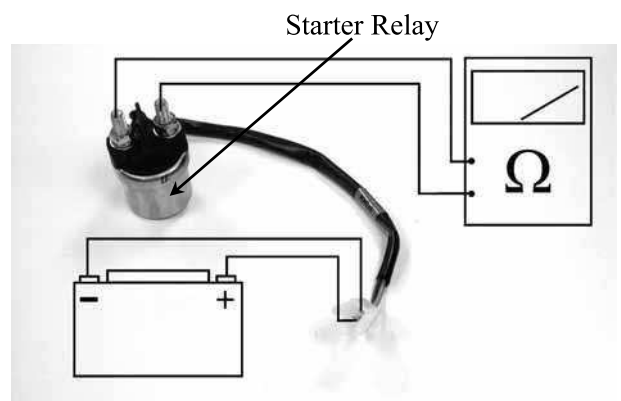

**SWITCHES/HORN/FUEL UNIT/THERMOSTATIC
SWITCH/TEMPERATURE GAUGE/ INSTRUMENTS/LIGHTS**

ELECTRICAL EQUIPMENT LAYOUT-----	19-1
SERVICE INFORMATION-----	19-2
TROUBLESHOOTING-----	19-2
SWITCHES-----	19-3
HORN INSPECTION -----	19-5
FUEL UNIT -----	19-5
THERMOSTATIC SWITCH -----	19-6
TEMPERATURE GAUGE-----	19-6
INSTRUMENTS-----	19-7
LIGHTS -----	19-8
HEATER WIRING DIAGRAM -----	19-9

ELECTRICAL EQUIPMENT LAYOUT

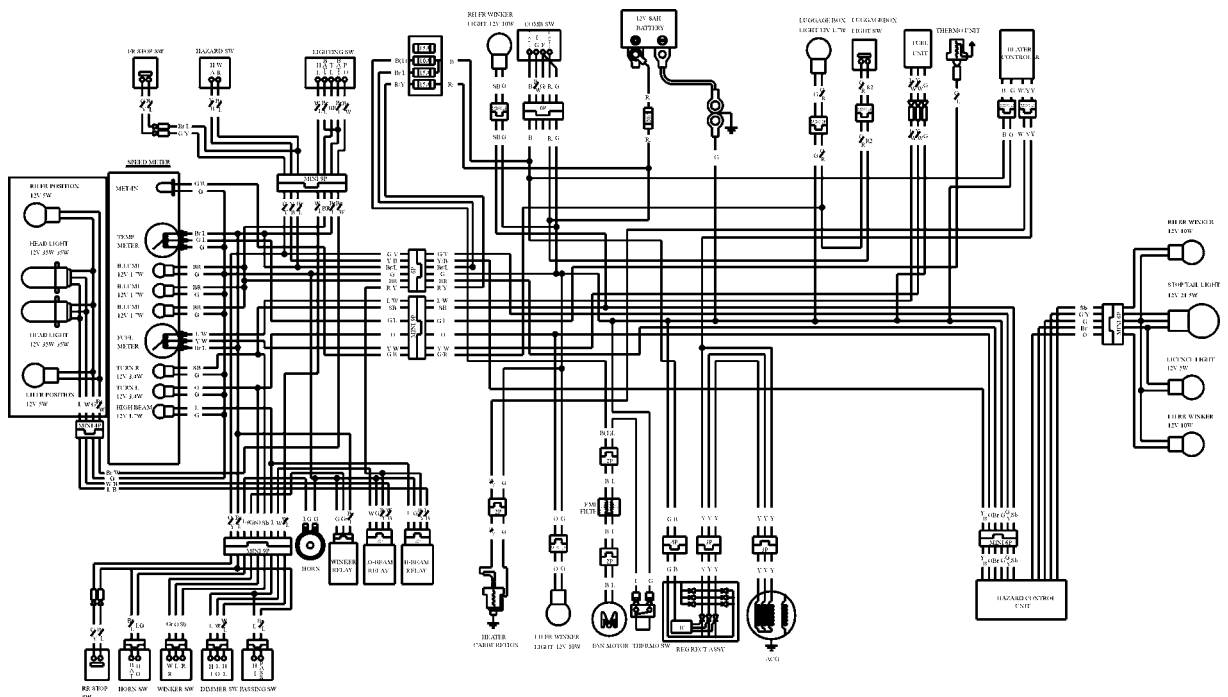
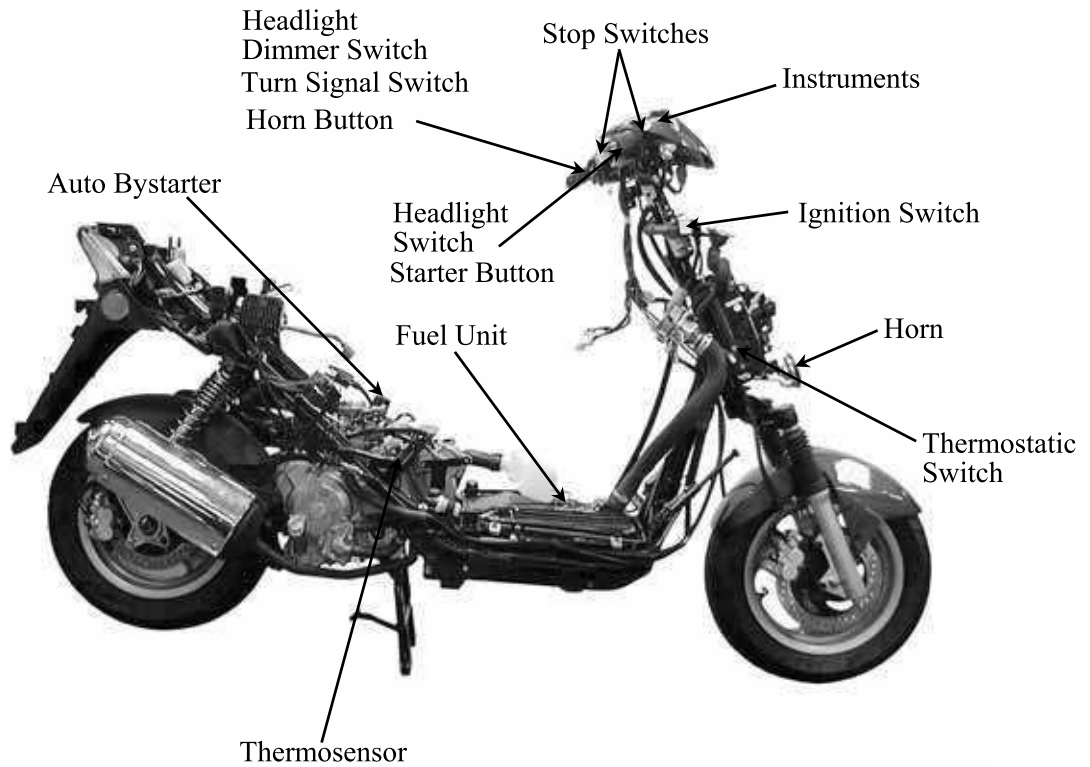

SERVICE INFORMATION

GENERAL INSTRUCTIONS

- After installation of each switch, a continuity check must be performed. A continuity check can usually be made without removing the part from the motorcycle.

TESTING INSTRUMENT

Electric tester

SPECIAL TOOL

Fuel unit wrench

TROUBLESHOOTING

Lights do not come on when ignition switch is "ON"

- Burned bulb
- Faulty switch
- Poorly connected, broken or shorted wire

Temperature gauge does not register correctly

- Faulty temperature gauge
- Faulty thermosensor
- Broken or shorted wire between temperature gauge and thermosensor

Fuel gauge pointer does not move or register correctly

- Faulty fuel gauge
- Faulty fuel unit
- Poorly connected wire between fuel gauge and fuel unit
- Fuse burned out

SPECIFICATIONS

Fuse	20A
Headlight bulb	12V 35W/35W
Turn signal light bulb	12V 10W
Stoplight/taillight	12V 21/5W
License plate light	12V 5W
Instrument light	12V 1.7W
Position light	12V 5W
Turn signal indicator light	12V 3.4W

SWITCHES

IGNITION SWITCH INSPECTION

Remove the frame front covers. (⇒2-5)
Disconnect the ignition switch wire couplers.
Check for continuity between the wire terminals.

Color Position	Red2	Black/Wh ite	Green	Black
PARK				
LOCK		○	○	
OFF		○	○	
ON	○			○

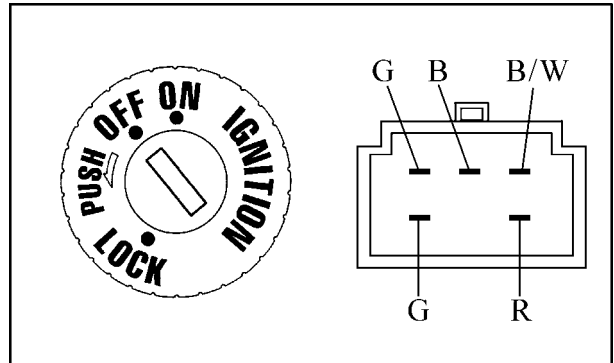

HEADLIGHT SWITCH INSPECTION

Remove the frame front covers. (⇒2-5)
Disconnect the headlight switch wire couplers.
Check for continuity between the wire terminals.

Color Position	White / Blue	Brown/ Blue	Brown
■			
P		○	○
H	○	○	○

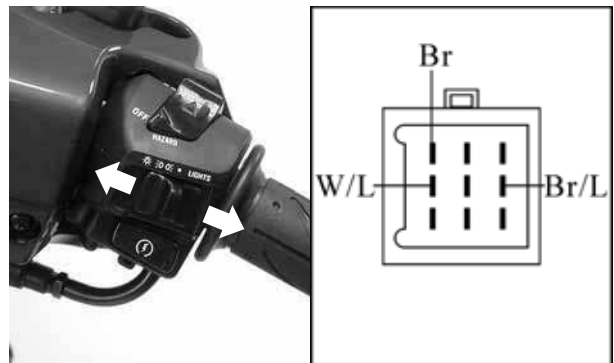

STARTER SWITCH INSPECTION

Remove the frame front covers. (⇒2-5)
Disconnect the starter switch wire couplers.
Depress the starter button and check for continuity between the wire terminals.

Color Position	Yellow/Red	Green
FREE		
PUSH	○	○

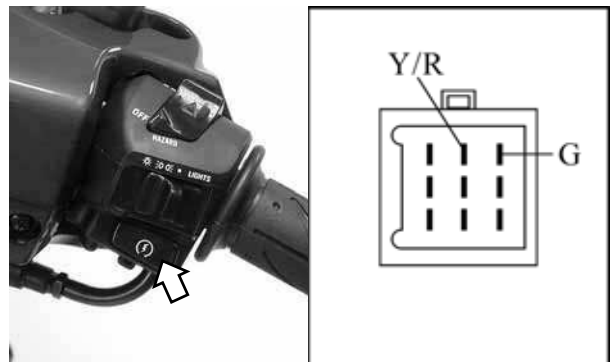

HAZARD SWITCH

Remove the front upper cover. (⇒2-5)
Disconnect the headlight switch wire couplers.
Check for continuity between the hazard switch wire terminals.

Color Position	Yellow/Black	Gray
OFF		
ON	○	○

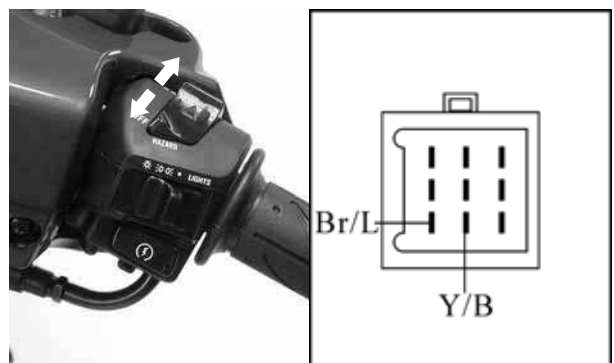

19. SWITCHES/HORN/FUEL UNIT/THERMOSTATIC SWITCH /TEMPERATURE GAUGE/INSTRUMENTS/LIGHTS

HORN BUTTON INSPECTION

Remove the frame front covers. (⇒2-5)
Disconnect the horn wire couplers.
Depress the horn button and check for continuity between the wire terminals.

Color Position	Light Green	Brown/Blue
FREE		
PUSH	○ — ○	○ — ○

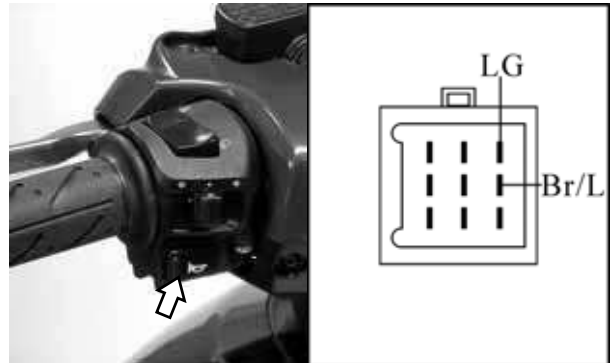

Horn Button

TURN SIGNAL SWITCH INSPECTION

Remove the frame front covers. (⇒2-5)
Disconnect the turn signal switch wire couplers and turn on the turn signal switch.
Check for continuity between the wire terminals.

Color Position	Light Blue/ White	Gray	Orange/ White
L		○ — ○	
N			
R	○ — ○	○ — ○	

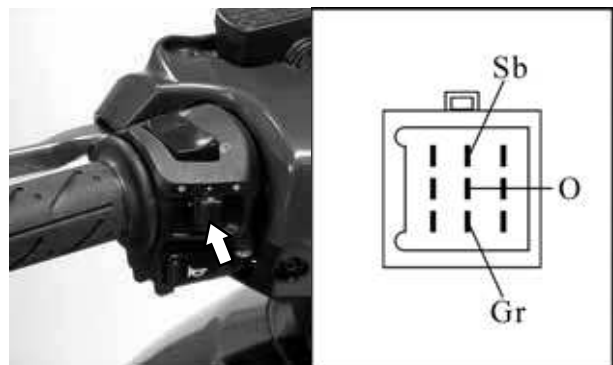

Turn Signal Switch

DIMMER SWITCH INSPECTION

Remove the frame front covers. (⇒2-5)
Disconnect the headlight dimmer switch wire couplers.
Turn on the dimmer switch and check for continuity between the wire terminals.

Color Position	White/ Blue	Blue	White	Brown/ Blue
LO	○ — ○		○ — ○	
HI	○ — ○	○ — ○		
PASSING		○ — ○		○ — ○

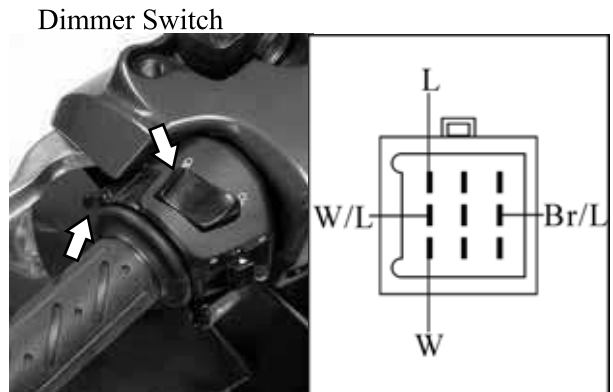

PASSING

STOP SWITCH INSPECTION

Remove the frame front covers. (⇒2-5)
Disconnect the front/rear stop switch wire couplers.
Check for continuity between the wire terminals when the front brake lever is applied.

Color Position	Brown/Blue	Green/Yellow
FREE		
APPLY	○ — ○	○ — ○

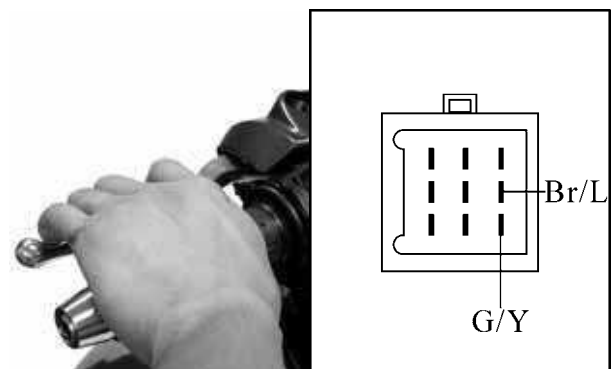

Stop Switch

HORN INSPECTION

Remove the front upper cover. (⇒2-5)
Disconnect the horn wire couplers.
The horn is normal if it sounds when a 12V battery is connected across the horn wire terminals.



Horn

FUEL UNIT

FUEL UNIT INSPECTION

Remove the fuel unit.
Disconnect the fuel unit wire connectors.
Measure the resistance between the fuel unit wire terminals with the float at upper and lower positions.

Wire Terminals	Upper	Lower
Y/W~G	33~45Ω	500~850Ω
L/W~G	400~700Ω	100~200Ω
Y/W~L/W	450~750Ω	450~750Ω

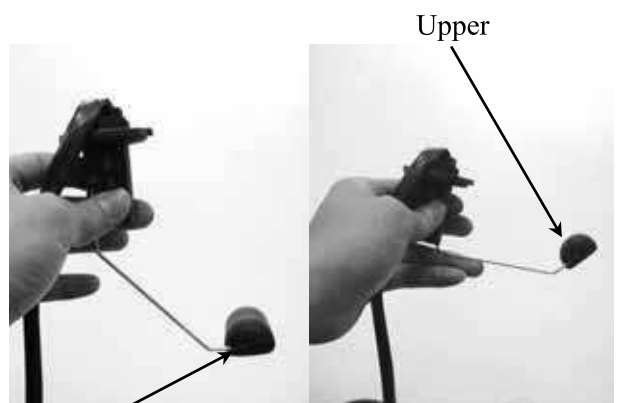

Lower

Upper

Fuel Unit

FUEL GAUGE INSPECTION

Connect the fuel unit wire connectors and turn the ignition switch "ON".

* Before performing the following test, operate the turn signals to determine that the battery circuit is normal.

Check the fuel gauge needle for correct indication by moving the fuel unit float up and down.

Float Position	Needle Position
Upper	"F" (Full)
Lower	"E" (Empty)

Wire Terminals	Needle Position
Y/W~G	From E to F
L/W~G	From F to E

The fuel gauge is normal if it operates as above indicated. If not, check for loosely tightened nuts, poorly connected terminals or shorted wires.



Upper

Fuel Gauge

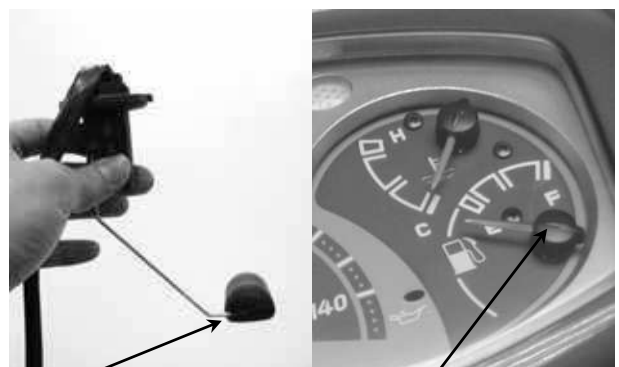

Lower

Needle moves from F to E.

THERMOSTATIC SWITCH

INSPECTION

Remove the front covers. (⇒2-5)
Start and run the engine to make the water temperature reaches $85^{\circ}\text{C} \sim 90^{\circ}\text{C}$ and check if the cooling fan motor operates. Lower the water temperature to 85°C and check if the fan motor stops.
If the fan motor does not start, disconnect the wires from the thermostatic switch and then connect a jumper wire between the wire harness and thermosensor wires (black and green wires).

Turn the ignition switch ON. The thermostatic switch is faulty if the cooling fan motor runs properly. If it does not start, check for voltage between the fan motor coupler wire terminals (black ~ green).
If there is no voltage, check for the following:

- Blown or faulty fuse
- Loose terminals or connectors
- Shorted wire in the wire harness

TEMPERATURE GAUGE

Disconnect the wire from the thermosensor and ground it to the engine.
Turn the ignition switch ON.
The temperature gauge needle should move all the way to "H".

* Do not leave the thermosensor wire grounded for longer than 5 seconds or the temperature gauge will be damaged.

HEATER CONTROLLER UNIT INSPECTION

1. Open ignition switch to check if the black wire of it is enough voltage.
2. Put the heater controller unit in refrigerator. Start engine after keeping the temperature under $10 \pm 4^{\circ}\text{C}$.
3. Check if the yellow wire of heater controller unit has output voltage.

Start engine and if the temperature of heater controller unit is under $10 \pm 4^{\circ}\text{C}$. Check if the white/blue wire of heater controller unit has output voltage. If it has not any voltage. It is damaged.

Thermostatic Switch



Wire



INSTRUMENTS

REMOVAL

Remove the front upper cover. (⇒2-5)
Disconnect the instrument wire couplers and connectors.
Disconnect the speedometer cable.

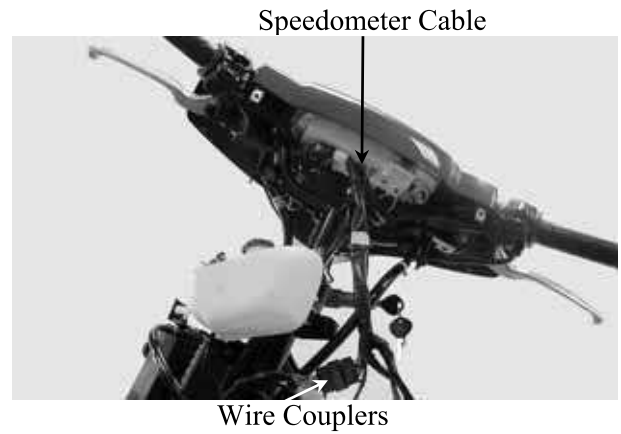

Remove the four instrument cover and leg shield screws.
Remove the instruments.

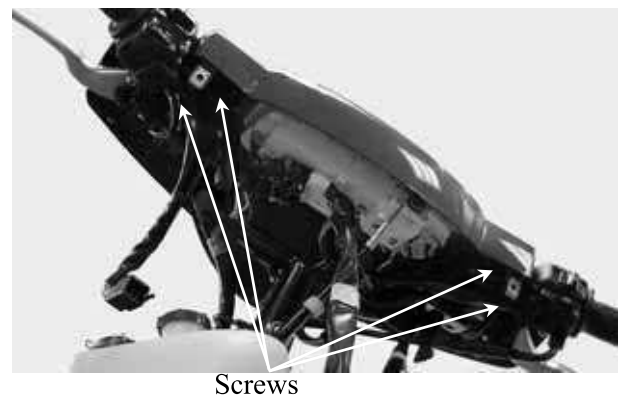

DISASSEMBLY/ASSEMBLY

Remove the three instrument holder nuts.
Remove the holder.
Remove the four screws to disassemble the instruments and instrument cover .
Assemble the instruments in the reverse order of disassembly.

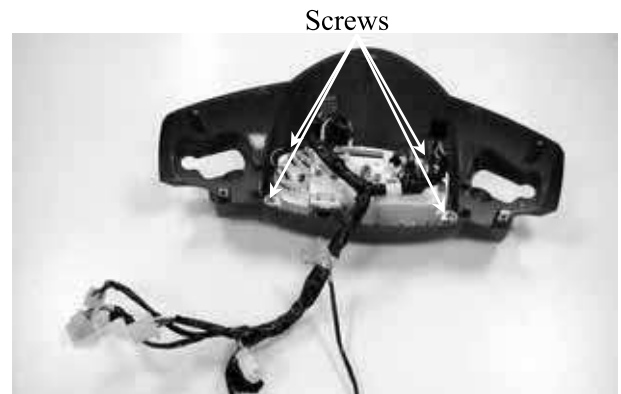

INSTALLATION

The installation sequence is the reverse of removal.

LIGHTS

HEADLIGHT BULB REPLACEMENT

Remove the front upper cover. (⇒2-5)
Disconnect the headlight and turn signal light wire couplers.
Remove the rubber boot from the bulb socket.
Remove the bulb socket and replace the bulb.
Install the bulb socket, aligning the bulb socket tab with the groove.
Install the rubber boot.
Install the front cover in the reverse order of removal.

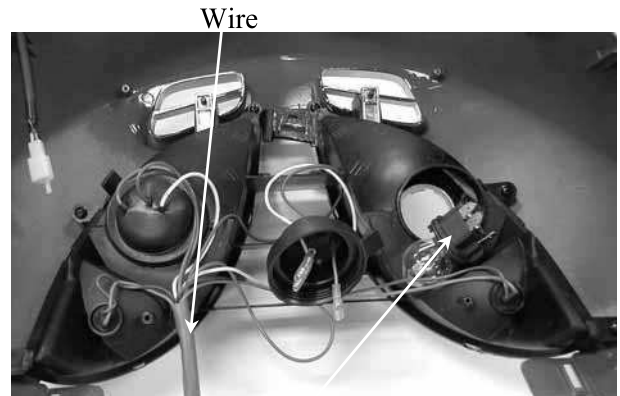

Wire
Bulb Socket
Wire

FRONT POSITION LIGHT BULB REPLACEMENT

Remove the front upper cover. (⇒2-5)
Disconnect the headlight and turn signal light wire couplers.
Remove the bulb sockets by turning them counterclockwise.
Remove the bulbs and replace them with new ones.

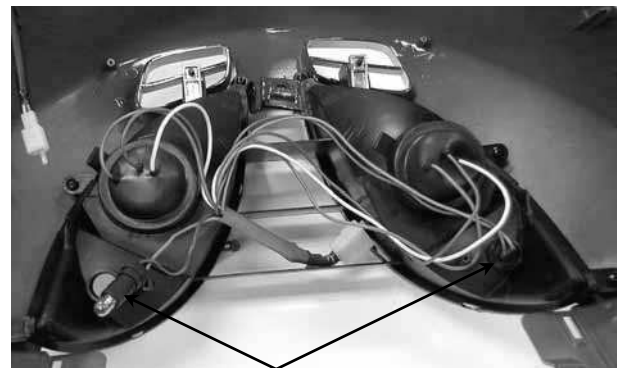

Front Position Light Bulb Sockets

FRONT TURN SIGNAL LIGHT BULB REPLACEMENT

Remove the one screw attaching the turn signal light shell.
Remove the turn signal fixer two screws.
Remove the bulb protector screw.
Remove the bulb and replace with a new one.

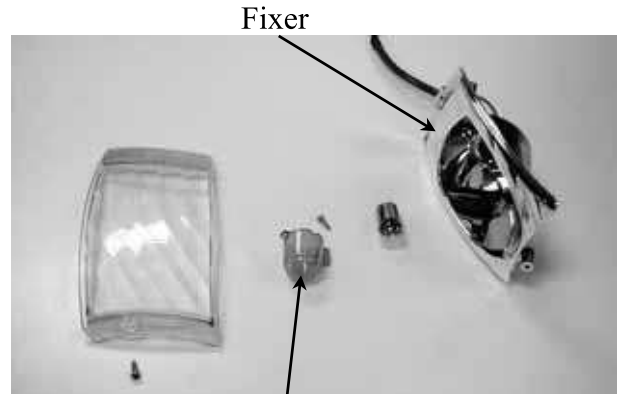

Protector

TAILLIGHT/REAR TURN SIGNAL LIGHT BULB REPLACEMENT

Remove the rear protective cover. (⇒2-3)
Remove the two screws attaching the rear light shell and remove the light shell.
Remove the bulbs and replace with new ones.
The installation sequence is the reverse of removal.

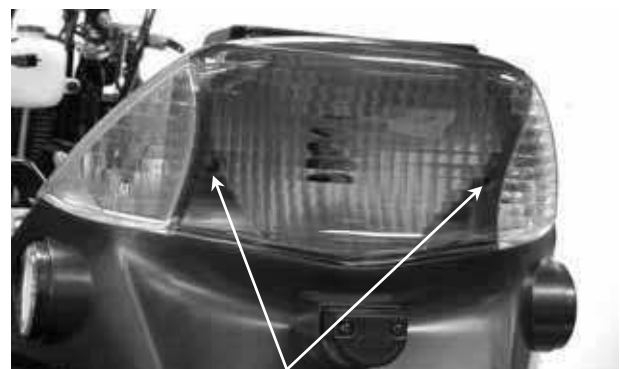

Screws

HEATER WIRING DIAGRAM

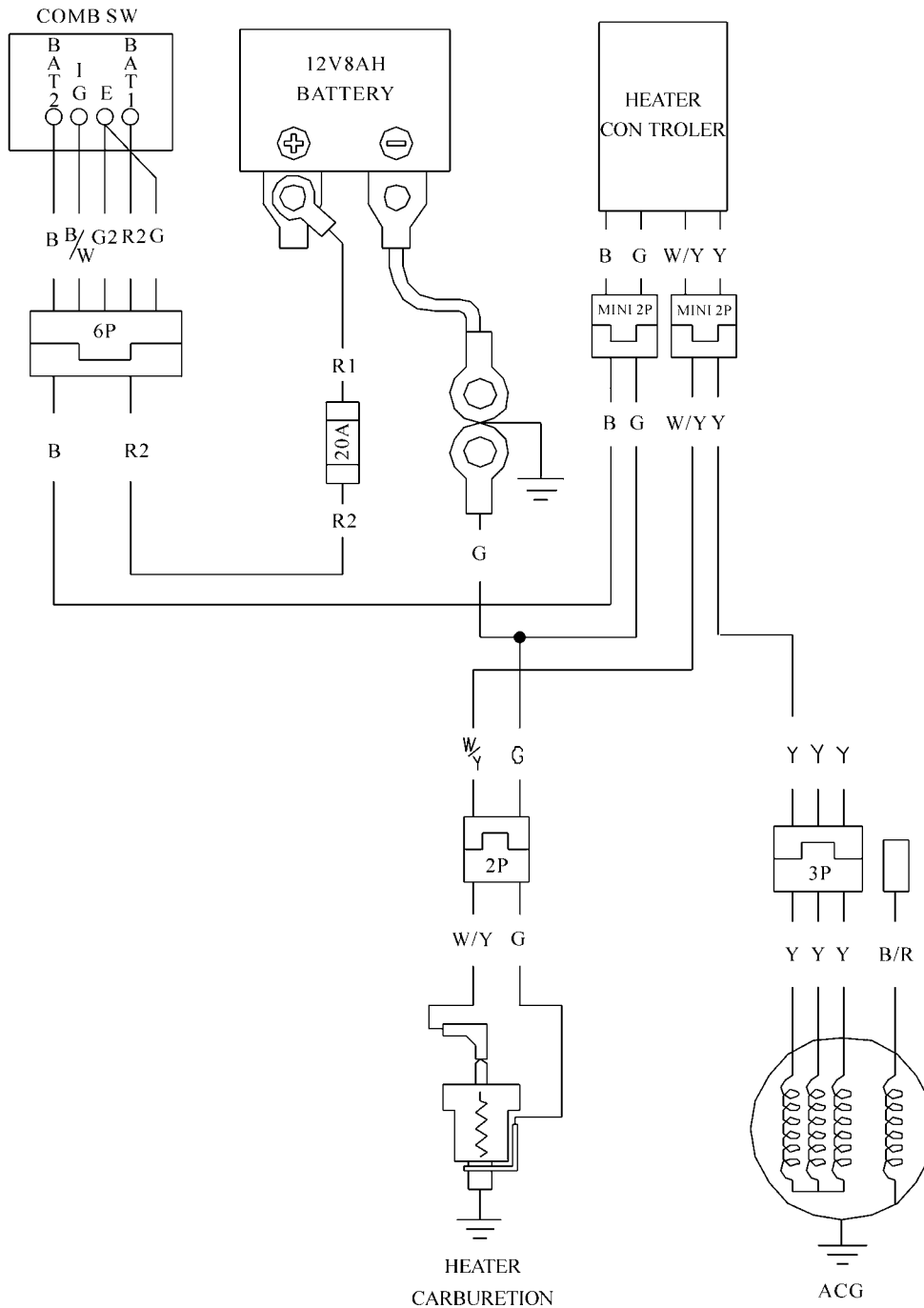

PREFACE

This Service Manual describes the technical features and servicing procedures for the KYMCO *Bet & Win 125/150*.

Section 1 contains the precautions for all operations stated in this manual. Read them carefully before any operation is started.

Section 2 is the removal/installation procedures for the frame covers which are subject to higher removal/installation frequency during maintenance and servicing operations.

Section 3 describes the inspection/adjustment procedures, safety rules and service information for each part, starting from periodic maintenance.

Sections 5 through 13 give instructions for disassembly, assembly and adjustment of engine parts. Section 14 is the removal/installation of chassis. Section 16 states the testing and measuring methods of electrical equipment.

Most sections start with an assembly or system illustration and troubleshooting for the section. The subsequent pages give detailed procedures for the section.

The information and contents included in this manual may be different from the motorcycle in case specifications are changed.

KWANG YANG MOTOR CO., LTD.
OVERSEAS SALES DEPARTMENT
OVERSEAS SERVICE SECTION

TABLE OF CONTENTS

ENGINE	GENERAL INFORMATION	1
	EXHAUST MUFFLER/FRAME COVERS	2
	INSPECTION/ADJUSTMENT	3
	LUBRICATION SYSTEM	4
	ENGINE REMOVAL/INSTALLATION	5
	CYLINDER HEAD/VALVES	6
	CYLINDER/PISTON	7
	DRIVE AND DRIVEN PULLEYS/KICK STARTER	8
	FINAL REDUCTION	9
	A.C. GENERATOR/STARTER CLUTCH	10
	CRANKCASE/CRANKSHAFT	11
	COOLING SYSTEM	12
	FUEL SYSTEM/CARBURETOR/FUEL PUMP FUEL TANK	13
CHASSIS	STEERING HANDLEBAR/FRONT WHEEL/FRONT BRAKE/FRONT SHOCK ABSORBER/FRONT FORK	14
	REAR BRAKE/REAR FORK/REAR WHEEL/REAR SHOCK ABSORBER	15
ELECTRICAL EQUIPMENT	BATTERY/CHARGING SYSTEM	16
	IGNITION SYSTEM	17
	STARTING SYSTEM	18
	SWITCHES/HORN/FUEL UNIT/ THERMOSTATIC SWITCH/TEMPERATURE GAUGE/INSTRUMENTS/ LIGHTS	19

1. GENERAL INFORMATION



GENERAL INFORMATION

ENGINE SERIAL NUMBER -----	1-1
SPECIFICATION-----	1-2
SERVICE PRECAUTIONS -----	1-4
TORQUE VALUES -----	1-8
TOOLS -----	1-9
LUBRICATION POINTS -----	1-10
CABLE & HARNESS ROUTING-----	1-12
WIRING DIAGRAM -----	1-17
TROUBLESHOOTING-----	1-18

1. GENERAL INFORMATION

SERIAL NUMBER

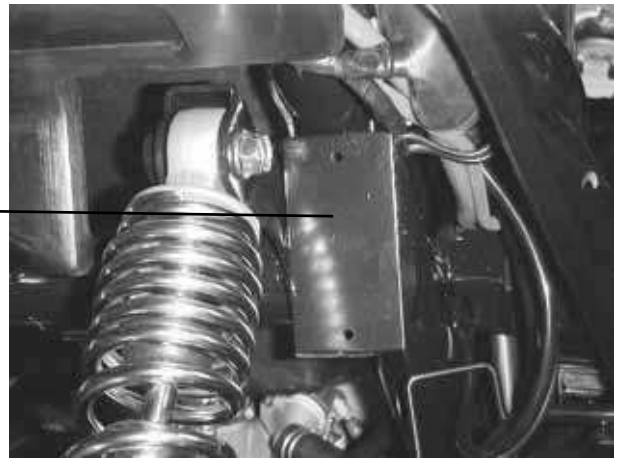
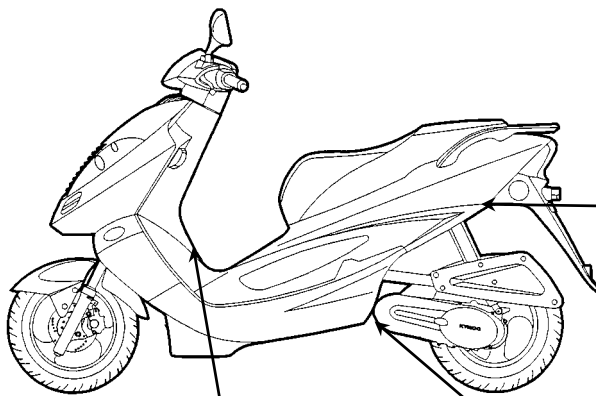

Vehicle Identification Serial Number



Location of Frame Serial Number



Location of Engine Serial Number

1. GENERAL INFORMATION

SPECIFICATIONS

Name & Model No.		SH25CA		
Motorcycle Name & Type				
Overall length		1940mm		
Overall width		750mm		
Overall height		1145mm		
Wheel base		1390mm		
Engine type		Water cooled 4-stroke, OHC engine		
Displacement		124cc		
Fuel Used		92# nonleaded gasoline		
Net weight (kg)	Front wheel	54		
	Rear wheel	75		
	Total	129		
Gross weight(kg)	Front wheel	58.5		
	Rear wheel	79.5		
	Total	138		
Tires	Front wheel	120/70-12 56J		
	Rear wheel	130/70-12 59J		
Ground clearance		155mm		
Performance	Braking distance (m)	30km/hr4.4m		
	Min. turning radius	2300mm		
Engine	Starting system		Starting motor & Kick starter	
	Type		Gasoline, 4-stroke	
	Cylinder arrangement		Single cylinder	
	Combustion chamber type		Semi-sphere	
	Valve arrangement		O.H.C.	
	Bore x stroke (mm)		52.4 x 57.8	
	Compression ratio		10.6:1	
	Compression pressure (kg/cm ² -rpm)		15	
	Max. output (kw/rpm)		8.4/8250	
	Max. torque (N.m/rpm)		9.9/6500	
	Port timing	Intake (1mm)	Open	BTDC 12°
			Close	ATDC 35°
		Exhaust (1mm)	Open	BDDC 28°
			Close	0°
	Valve clearance (cold)	Intake	0.1	
		Exhaust	0.1	
	Idle speed (rpm)		1500rpm	
	Lubrication System	Lubrication type		Forced pressure & wet sump
		Oil pump type		Inner/outer rotor type
		Oil filter type		Full-flow filtration
Oil capacity		1.1 liters		
Cooling Type		Water cooling		
Fuel System	Air cleaner type & No		Paper element, wet	
	Fuel capacity		10.6 liters	
	Carburetor	Type	VE	
		Piston dia.	22	
		Venturi dia.	26 equivalent	
Throttle type		Butterfly type		
Electrical Equipment	Ignition System	Type	CDI	
		Ignition timing	BTDC 10°±1°	
		Contact breaker	Non-contact point type	
		Spark plug	NGK DPR7EA-9	
	Spark plug gap	0.9mm		
Battery	Capacity	12V8AH		
Power Drive System	Clutch	Type	Dry multi-disc clutch	
		Transmission Gear	Non-stage transmission	
	Gear Reduction	Operation	Automatic centrifugal Type	
		Type	Two-stage reduction	
			Reduction ratio	1st
		2nd	8.82	
Moving Device	Front Axle	Caster angle		
		Connecting rod		
	Tire pressure (kg/cm ²)	Front	2.00	
		Rear	2.25	
Turning angle	Left	42.5°		
	Right	42.5°		
Brake system type		Front	Disk brake	
		Rear	Disk brake	
Damping Device	Suspension type	Front	Telescope	
		Rear	Double swing	
	Shock absorber type	Front	Telescope	
		Rear	Double swing	
Frame type		Under bone		

1. GENERAL INFORMATION

SPECIFICATIONS

Name & Model No.		SH30CA			
Motorcycle Name & Type					
Overall length		1940mm			
Overall width		750mm			
Overall height		1145mm			
Wheel base		1390mm			
Engine type		Water cooled 4-stroke, OHC engine			
Displacement		150cc			
Fuel Used		92# nonleaded gasoline			
Net weight (kg)	Front wheel	54			
	Rear wheel	75			
	Total	129			
Gross weight(kg)	Front wheel	58.5			
	Rear wheel	79.5			
	Total	138			
Tires	Front wheel	120/70-12 56J			
	Rear wheel	130/70-12 59J			
Ground clearance		155mm			
Performance	Braking distance (m)	30km/hr4.4m			
	Min. turning radius	2300mm			
Engine	Starting system		Starting motor & kick starter		
	Type		Gasoline, 4-stroke		
	Cylinder arrangement		Single cylinder		
	Combustion chamber type		Semi-sphere		
	Valve arrangement		O.H.C.		
	Bore x stroke (mm)		57.4 x 57.8		
	Compression ratio		10.6:1		
	Compression pressure (kg/cm ² -rpm)		15		
	Max. output (kw/rpm)		9.1/7500		
	Max. torque (N.m/rpm)		11.6/6500		
	Port timing	Intake (1mm)	Open	BTDC 12°	
			Close	ATDC 35°	
		Exhaust (1mm)	Open	BDDC 28°	
			Close	0°	
	Valve clearance (cold)		Intake	0.1	
			Exhaust	0.1	
	Idle speed (rpm)		1500rpm		
	Lubrication System	Lubrication type		Forced pressure & wet sump	
		Oil pump type		Inner/outer rotor type	
		Oil filter type		Full-flow filtration	
Oil capacity		1.1 liters			
Cooling Type		Water cooling			
Fuel System	Air cleaner type & No		Paper element, wet		
	Fuel capacity		10.6 liters		
	Carburetor	Type	VE		
		Piston dia.	22		
		Venturi dia.	26 equivalent		
Throttle type		Butterfly type			
Electrical Equipment	Ignition System	Type	CDI		
		Ignition timing	BTDC 10°±1°		
		Contact breaker	Non-contact point type		
		Spark plug		NGK DP7EA-9	
		Spark plug gap		0.9mm	
	Battery	Capacity	12V8AH		
Power Drive System	Clutch	Type	Dry multi-disc clutch		
		Transmission Gear	Type	Non-stage transmission	
	Operation		Automatic centrifugal Type		
	Reduction Gear		Type	Two-stage reduction	
		Reduction ratio	1st	2.8~1.0	
2nd	8.82				
Moving Device	Front Axle	Caster angle			
		Connecting rod			
	Tire pressure (kg/cm ²)	Front	2.00		
		Rear	2.25		
Turning angle	Left	42.5°			
	Right	42.5°			
Brake system type		Front	Disk brake		
		Rear	Disk brake		
Damping Device	Suspension type	Front	Telescope		
		Rear	Double swing		
	Shock absorber type	Front	Telescope		
		Rear	Double swing		
Frame type		Under bone			

1. GENERAL INFORMATION

SERVICE PRECAUTIONS

- Make sure to install new gaskets, O-rings, circlips, cotter pins, etc. when reassembling.

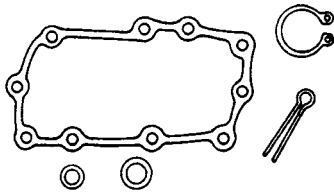

- When tightening bolts or nuts, begin with larger-diameter to smaller ones at several times, and tighten to the specified torque diagonally.

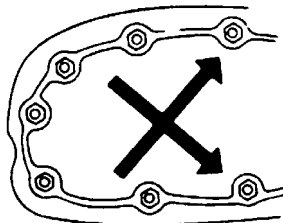

- Use genuine parts and lubricants.

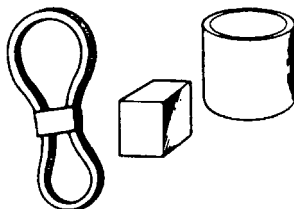

- When servicing the motorcycle, be sure to use special tools for removal and installation.



- After disassembly, clean removed parts. Lubricate sliding surfaces with engine oil before reassembly.

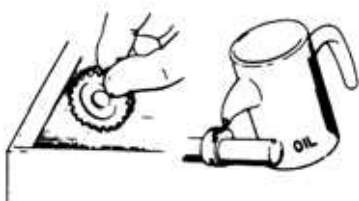

- Apply or add designated greases and lubricants to the specified lubrication points.

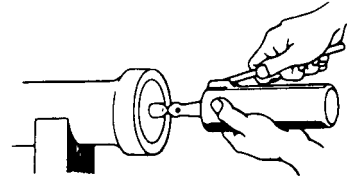

- After reassembly, check all parts for proper tightening and operation.



- When two persons work together, pay attention to the mutual working safety.



- Disconnect the battery negative (-) terminal before operation.
- When using a spanner or other tools, make sure not to damage the motorcycle surface.

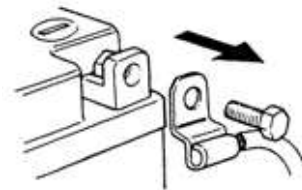

- After operation, check all connecting points, fasteners, and lines for proper connection and installation.
- When connecting the battery, the positive (+) terminal must be connected first.
- After connection, apply grease to the battery terminals.
- Terminal caps shall be installed securely.

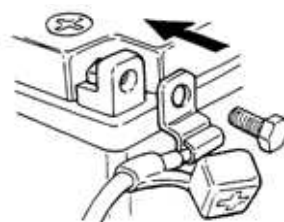

1. GENERAL INFORMATION

- If the fuse is burned out, find the cause and repair it. Replace it with a new one according to the specified capacity.

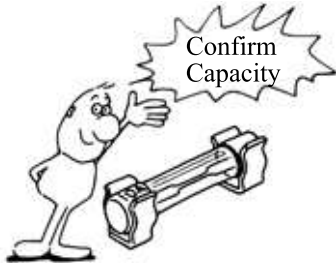

- After operation, terminal caps shall be installed securely.

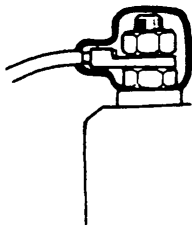

- When taking out the connector, the lock on the connector shall be released before operation.

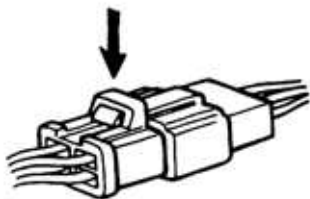

- Hold the connector body when connecting or disconnecting it.
- Do not pull the connector wire.



- Check if any connector terminal is bending, protruding or loose.

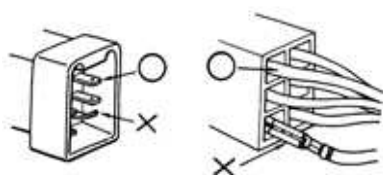

- The connector shall be inserted completely.
- If the double connector has a lock, lock it at the correct position.
- Check if there is any loose wire.

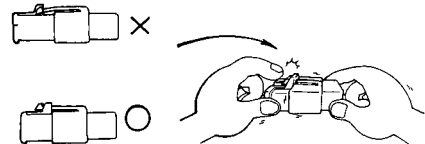

- Before connecting a terminal, check for damaged terminal cover or loose negative terminal.

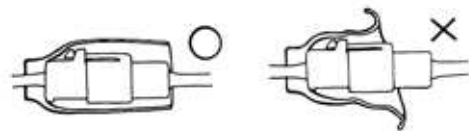

- Check the double connector cover for proper coverage and installation.

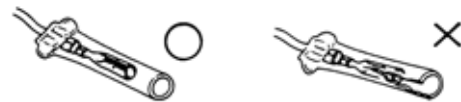

- Insert the terminal completely.
- Check the terminal cover for proper coverage.
- Do not make the terminal cover opening face up.



- Secure wire harnesses to the frame with their respective wire bands at the designated locations. Tighten the bands so that only the insulated surfaces contact the wire harnesses.

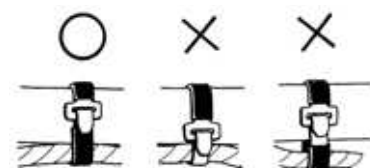

1. GENERAL INFORMATION

- After clamping, check each wire to make sure it is secure.

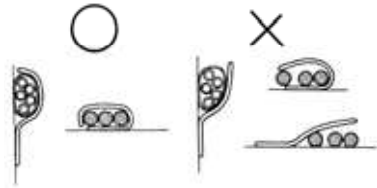

- Do not squeeze wires against the weld or its clamp.



- After clamping, check each harness to make sure that it is not interfering with any moving or sliding parts.

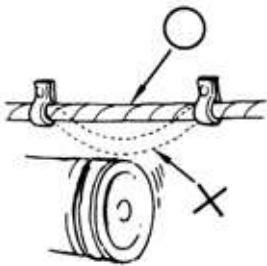

- When fixing the wire harnesses, do not make it contact the parts which will generate high heat.

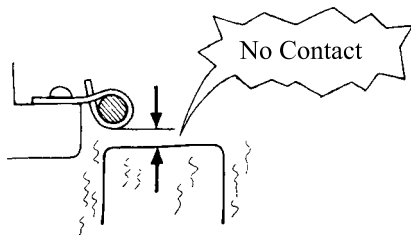

- Route wire harnesses to avoid sharp edges or corners. Avoid the projected ends of bolts and screws.

- Route wire harnesses passing through the side of bolts and screws. Avoid the projected ends of bolts and screws.

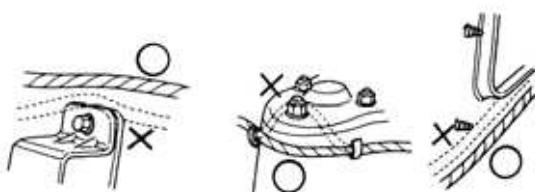

- Route harnesses so they are neither pulled tight nor have excessive slack.

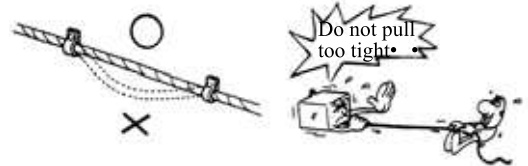

- Protect wires and harnesses with electrical tape or tube if they contact a sharp edge or corner.

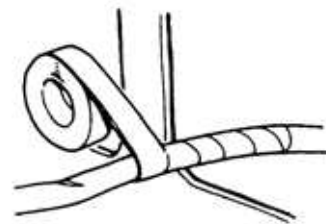

- When rubber protecting cover is used to protect the wire harnesses, it shall be installed securely.

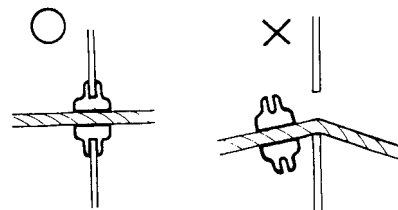

- Do not break the sheath of wire.
- If a wire or harness is with a broken sheath, repair by wrapping it with protective tape or replace it.

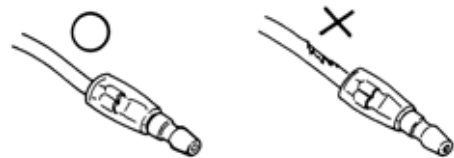

- When installing other parts, do not press or squeeze the wires.



1. GENERAL INFORMATION

- After routing, check that the wire harnesses are not twisted or kinked.

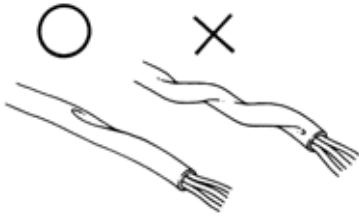

- Wire harnesses routed along with handlebar should not be pulled tight, have excessive slack or interfere with adjacent or surrounding parts in all steering positions.

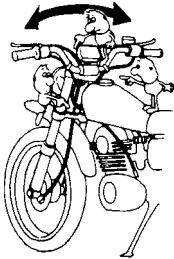

- When a testing device is used, make sure to understand the operating methods thoroughly and operate according to the operating instructions.

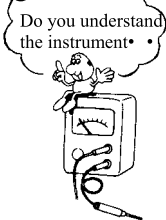

- Be careful not to drop any parts.



- When rust is found on a terminal, remove the rust with sand paper or equivalent before connecting.



- Symbols:

The following symbols represent the servicing methods and cautions included in this service manual.



Engine Oil

: Apply engine oil to the specified points. (Use designated engine oil for lubrication.)



Grease

: Apply grease for lubrication.



Gear Oil

: Transmission Gear Oil (90#)



Special

: Use special tool.



: Caution



: Warning

1. GENERAL INFORMATION

TORQUE VALUES

STANDARD TORQUE VALUES

Item	Torque (N-m)	Item	Torque (N-m)
5mm bolt, nut	4.9	5mm screw	3.9
6mm bolt, nut	9.8	6mm screw, SH bolt	8.8
8mm bolt, nut	21.6	6mm flange bolt, nut	11.8
10mm bolt, nut	34.3	8mm flange bolt, nut	26.5
12mm bolt, nut	53.9	10mm flange bolt, nut	39.2

Torque specifications listed below are for important fasteners.

ENGINE

Item	Q'ty	Thread dia.(mm)	Torque (N-m)	Remarks
Cylinder head bolt A	2	8	21.6	Double end bolt Double end bolt Apply oil to threads Left hand threads
Cylinder head bolt B	2	8	21.6	
Oil filter screen cap	1	30	14.7	
Exhaust muffler joint lock nut	2	8	8.8	
Cylinder head cap nut	4	8	21.6	
Valve adjusting lock nut	2	5	8.8	
Cam chain tensioner slipper bolt	1	6	8.8	
Oil bolt	1	12	12.7	
Clutch outer nut	1	12	53.9	
Clutch drive plate nut	1	12	53.9	
Flywheel nut	1	14	53.9	
Oil pump bolt	2	5	3.9	
Cylinder head cover bolt	4	6	11.8	
Spark plug	1	10	11.8	
Cam chain tensioner bolt	1	6	8.8	
Water pump impeller	1	8	13.7	

FRAME

Item	Q'ty	Thread dia.(mm)	Torque (N-m)	Remarks
Steering stem lock nut	1	10	44.1	U-nut
Front axle nut	1	12	58.8	U-nut
Rear axle nut	1	14	88.2	U-nut
Rear shock absorber upper bolt	2	10	29.4	
Rear shock absorber lower bolt	2	8	29.4	
Front shock absorber lock bolt	4	10	24.5	
Engine hanger bolt	1	12	53.9	

1. GENERAL INFORMATION

SPECIAL TOOLS

Tool Name	Tool No.	Remarks	Ref. Page
Valve guide driver		Valve guide removal/installation	
Valve guide reamer		Valve guide grinding	
Valve spring compressor		Valve removal	
Lock nut wrench, 39mm	E027	Clutch disassembly	
Bearing driver		Bearing removal	
Bearing remover, 12mm	E020	Bearing removal	
Remover shaft		Bearing removal	
Remover weight		Bearing removal	
Bearing remover, 15mm	E018	Bearing removal	
Bearing driver		Bearing removal	
Clutch spring compressor	E027	Clutch disassembly	
Ball race remover extension		Ball race removal	
Ball race remover		Ball race removal	
Spring compressor		Spring removal	
Mechanical seal driver	E014	Water pump mechanical seal removal/installation	
Kick starter spring remover		Kick starter spring removal	
Gear remover		Starter gear removal	
Valve adjuster	E012	Tapper adjustment	
Float level gauge		Carburetor fuel level check	
Valve seat cutter 45°		Valve seat refacing	
Valve seat cutter 32°		Valve seat refacing	
Valve seat cutter 60°		Valve seat refacing	
Cutter clip, 5mm			
Universal holder	E017	Holding clutch for removal	
Bearing driver (32x35mm)	E014	Bearing installation	
Pilot, 12mm	E014	Bearing installation	
Pilot, 15mm	E014	Bearing installation	
Pilot, 17mm	E014	Bearing installation	
Flywheel puller	E003	A.C. generator flywheel removal	
Rear shock absorber compressor	F004	Rear shock absorber disassembly	
Steering head bearing remover	F005	Steering head bearing removal	
Flywheel holder	E021	A.C. generator flywheel holding	
Reamer clip			
Fuel unit wrench		Fuel unit removal	

1. GENERAL INFORMATION

LUBRICATION POINTS

ENGINE

Lubrication Points	Lubricant
Valve guide/valve stem movable part Camshaft protruding surface Valve rocker arm friction surface Camshaft drive chain Cylinder lock bolt and nut Piston surroundings and piston ring grooves Piston pin surroundings Cylinder inside wall Connecting rod/piston pin hole Connecting rod big end Crankshaft Crankshaft one-way clutch movable part Oil pump drive chain Starter reduction gear engaging part Countershaft gear engaging part Final gear engaging part Bearing movable part O-ring face Oil seal lip	<ul style="list-style-type: none"> •Genuine KYMCO Engine Oil (SAE15W-40) •API SE, SF or SG Engine Oil
Starter idle gear Friction spring movable part/shaft movable part Shaft movable grooved part Starter spindle movable part	High-temperature resistant grease
Starter one-way clutch threads	Thread locking agent
A.C. generator connector Transmission case breather tube	Adhesive

1. GENERAL INFORMATION

FRAME

The following is the lubrication points for the frame.

Use general purpose grease for parts not listed.

Apply clean engine oil or grease to cables and movable parts not specified. This will avoid abnormal noise and rise the durability of the motorcycle.

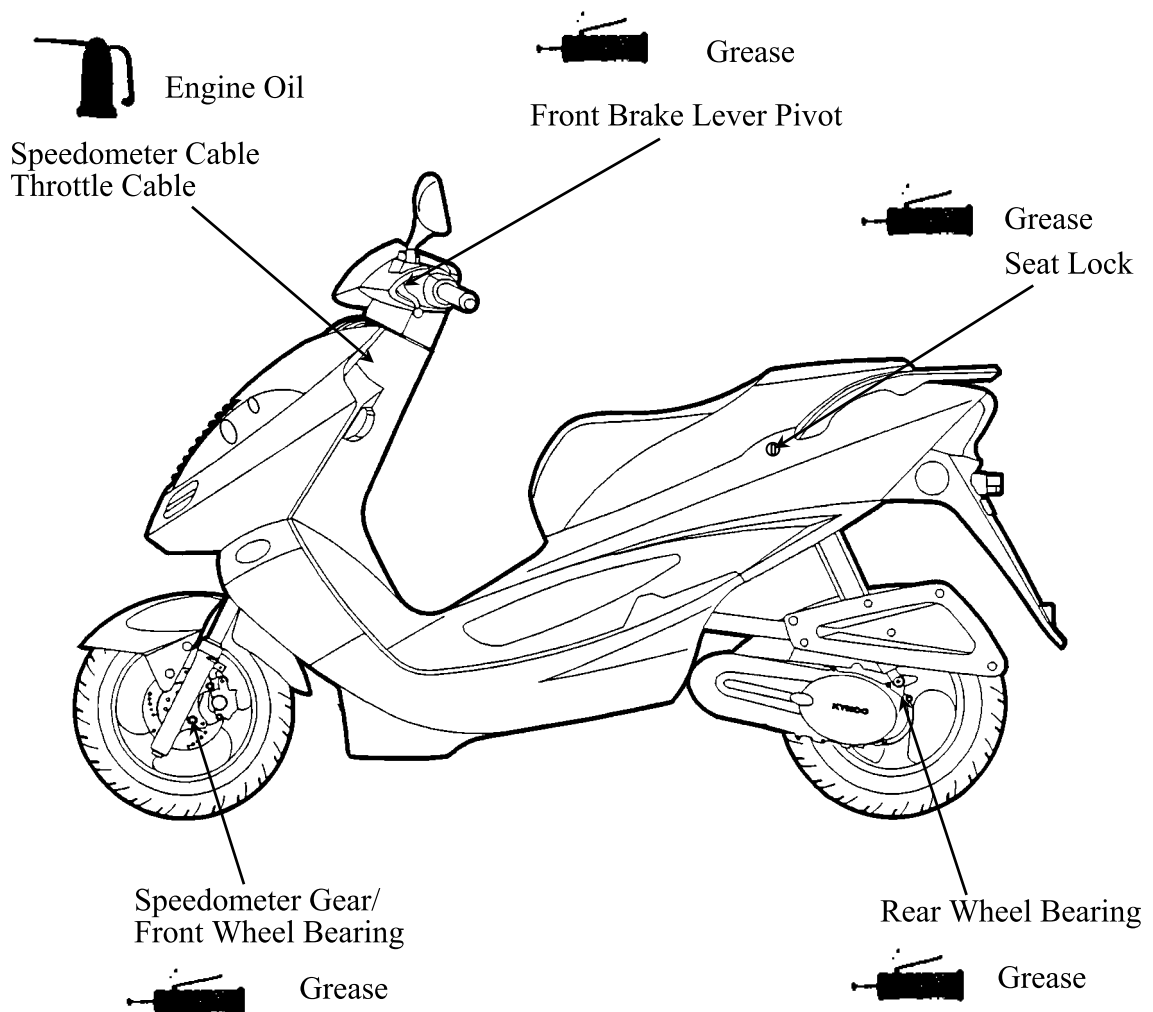

1. GENERAL INFORMATION

CABLE & HARNESS ROUTING

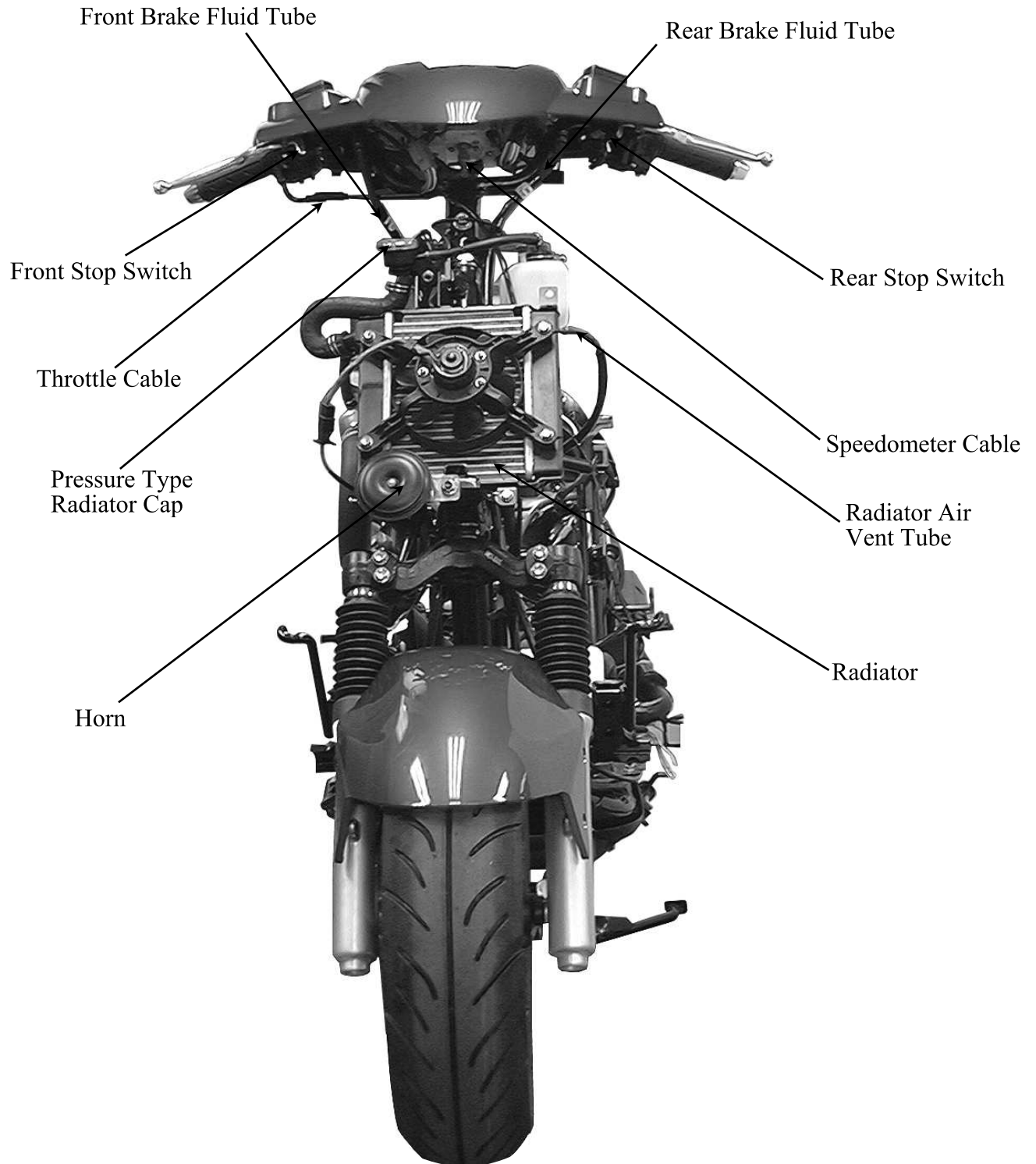

1. GENERAL INFORMATION

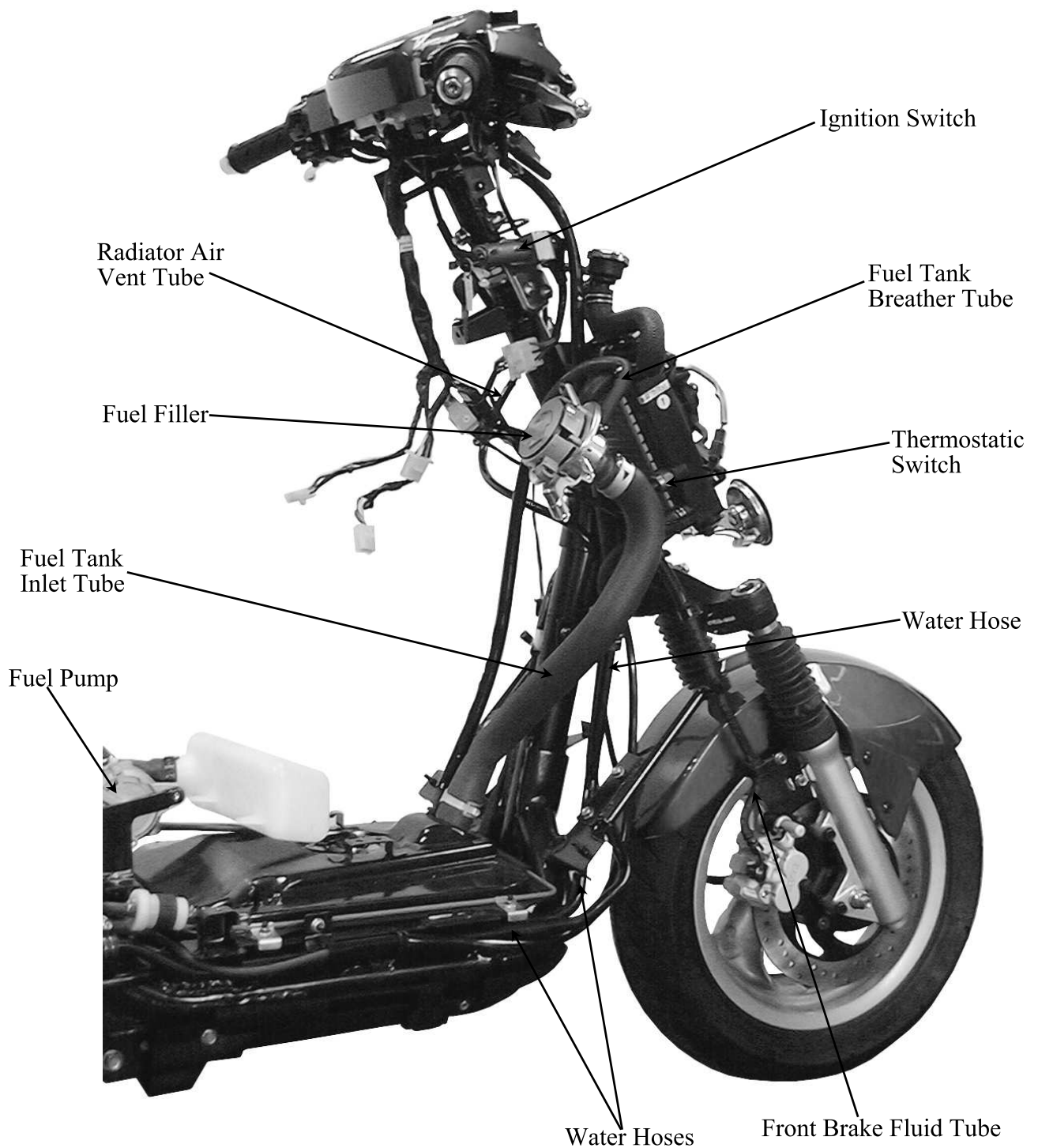

1. GENERAL INFORMATION

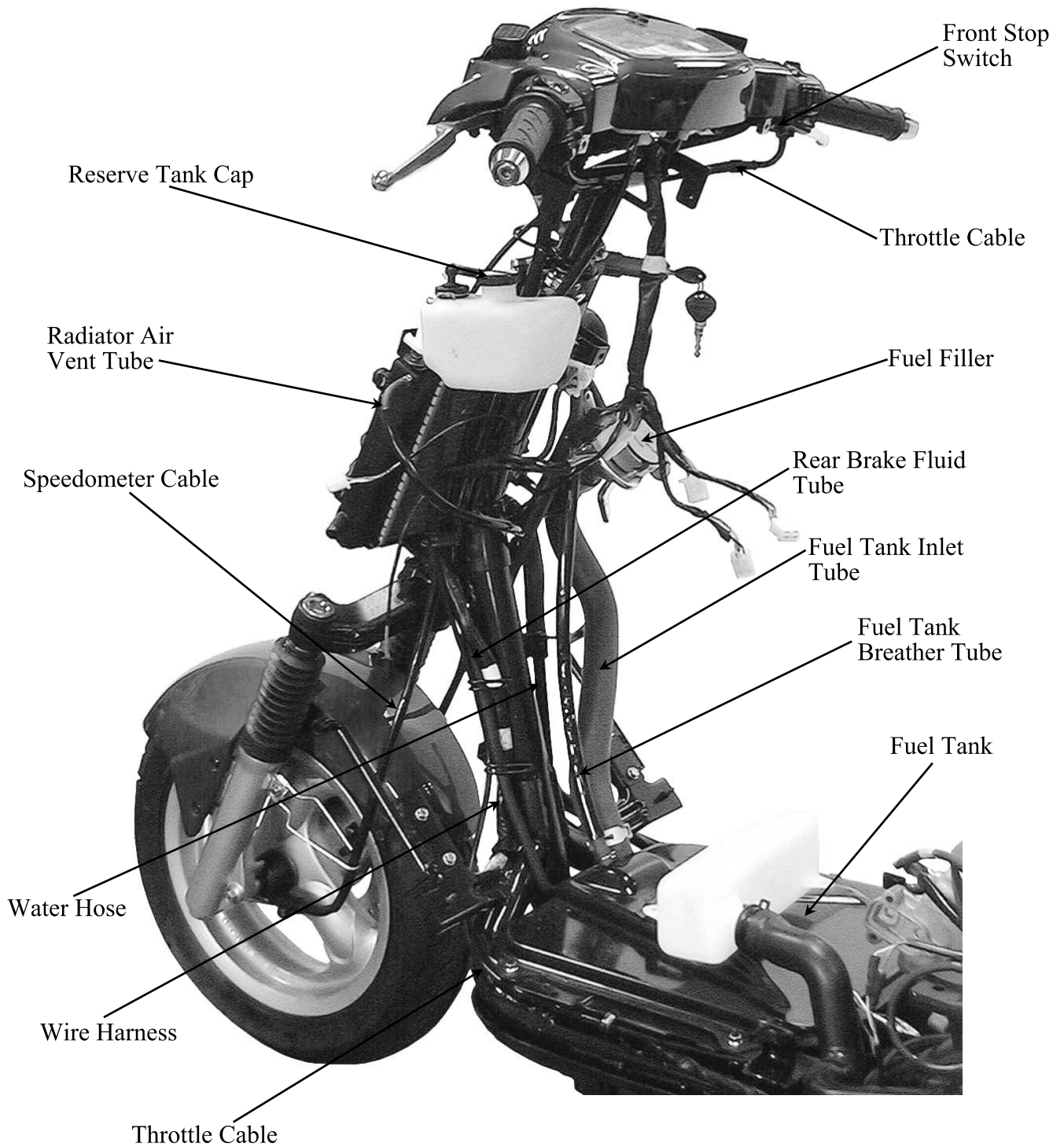

1. GENERAL INFORMATION

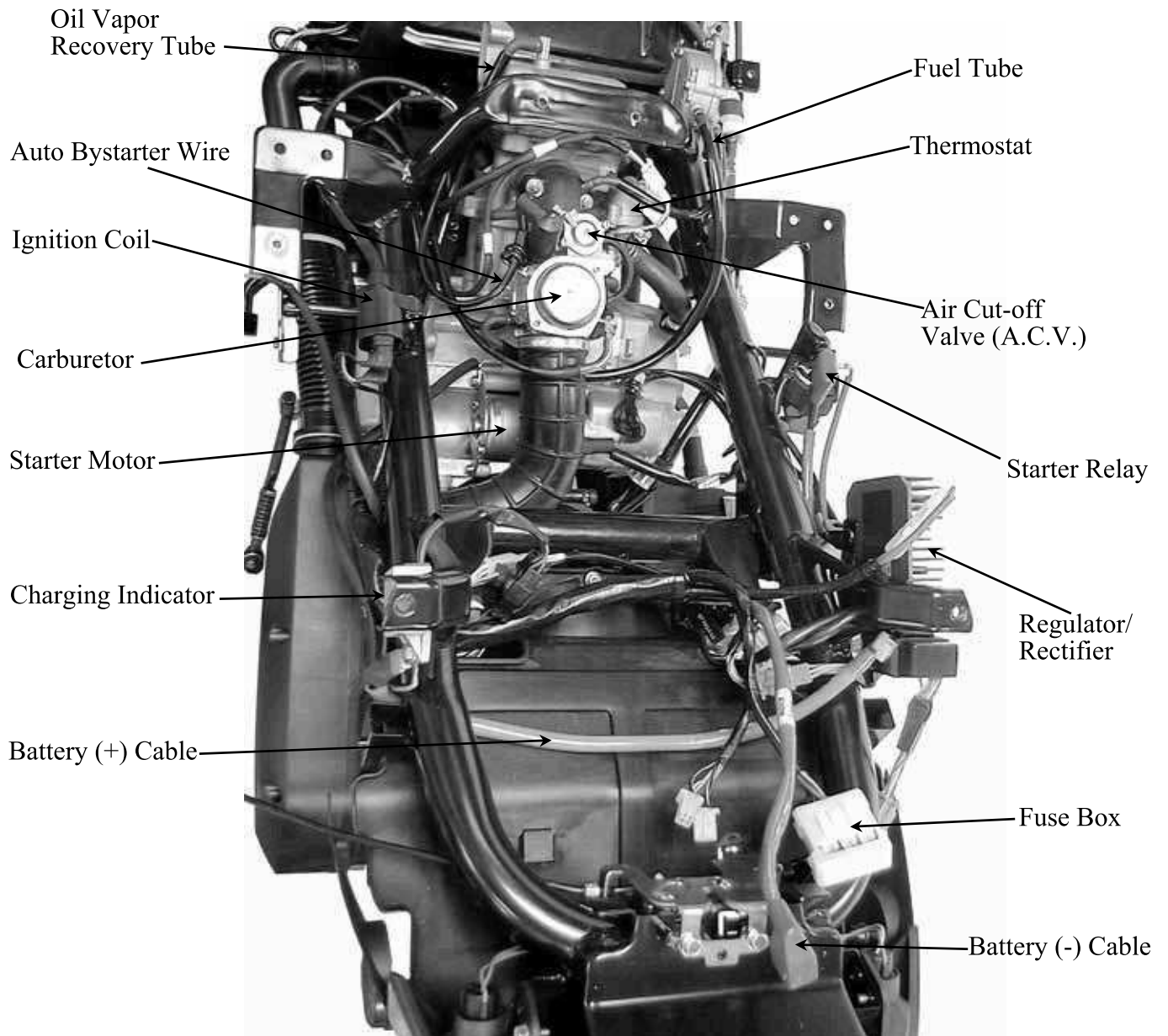

1. GENERAL INFORMATION

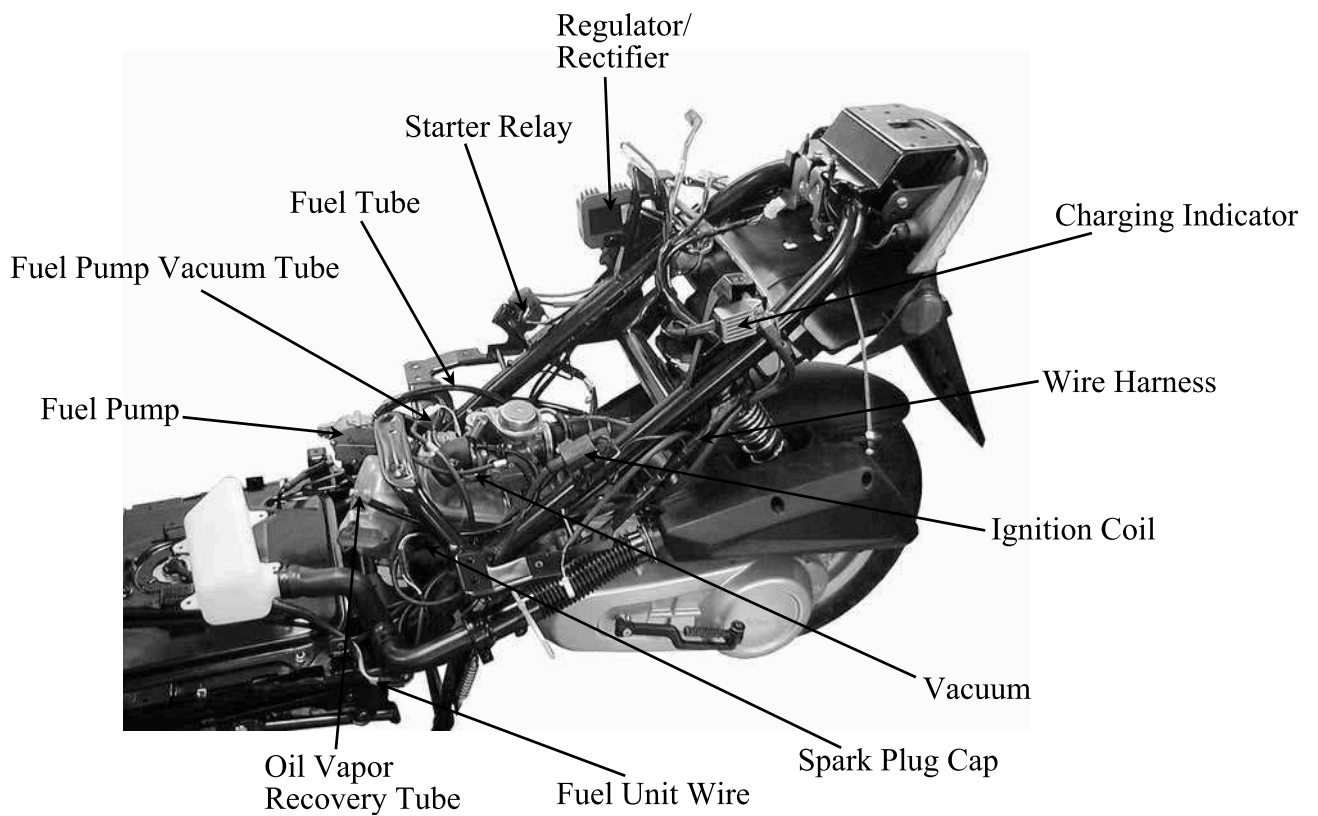
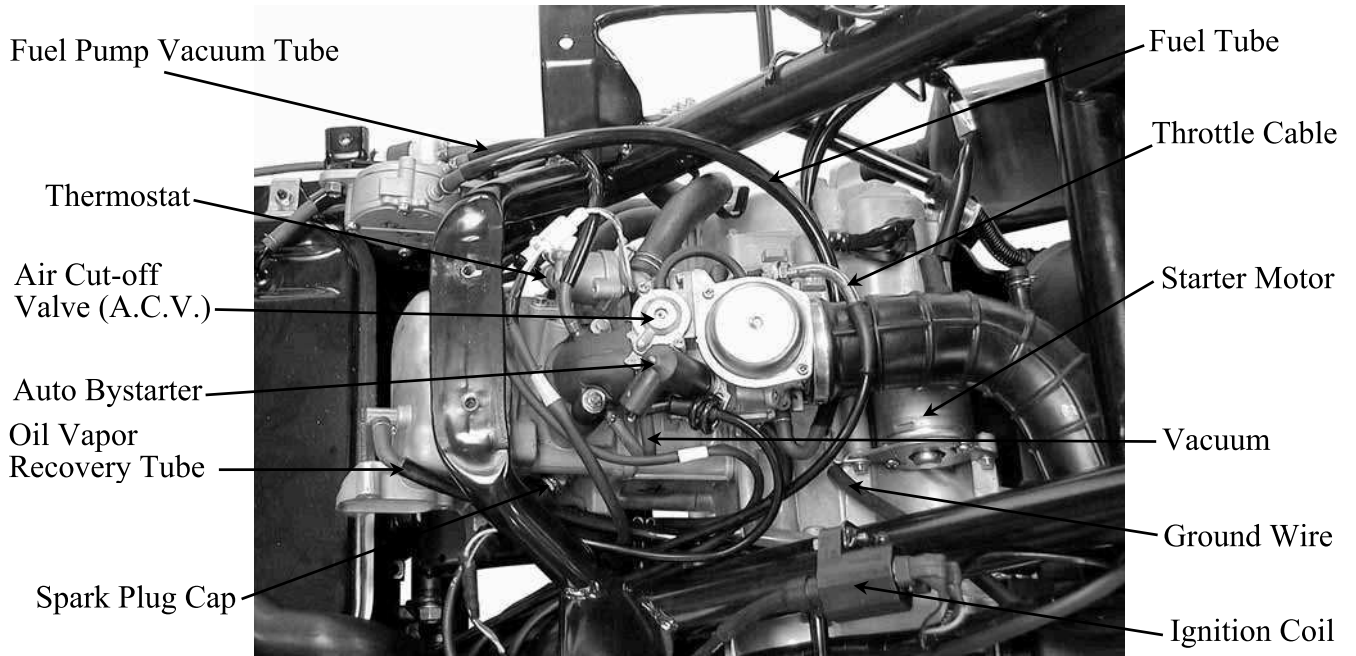

1. GENERAL INFORMATION

TROUBLESHOOTING

ENGINE WILL NOT START OR IS HARD TO START

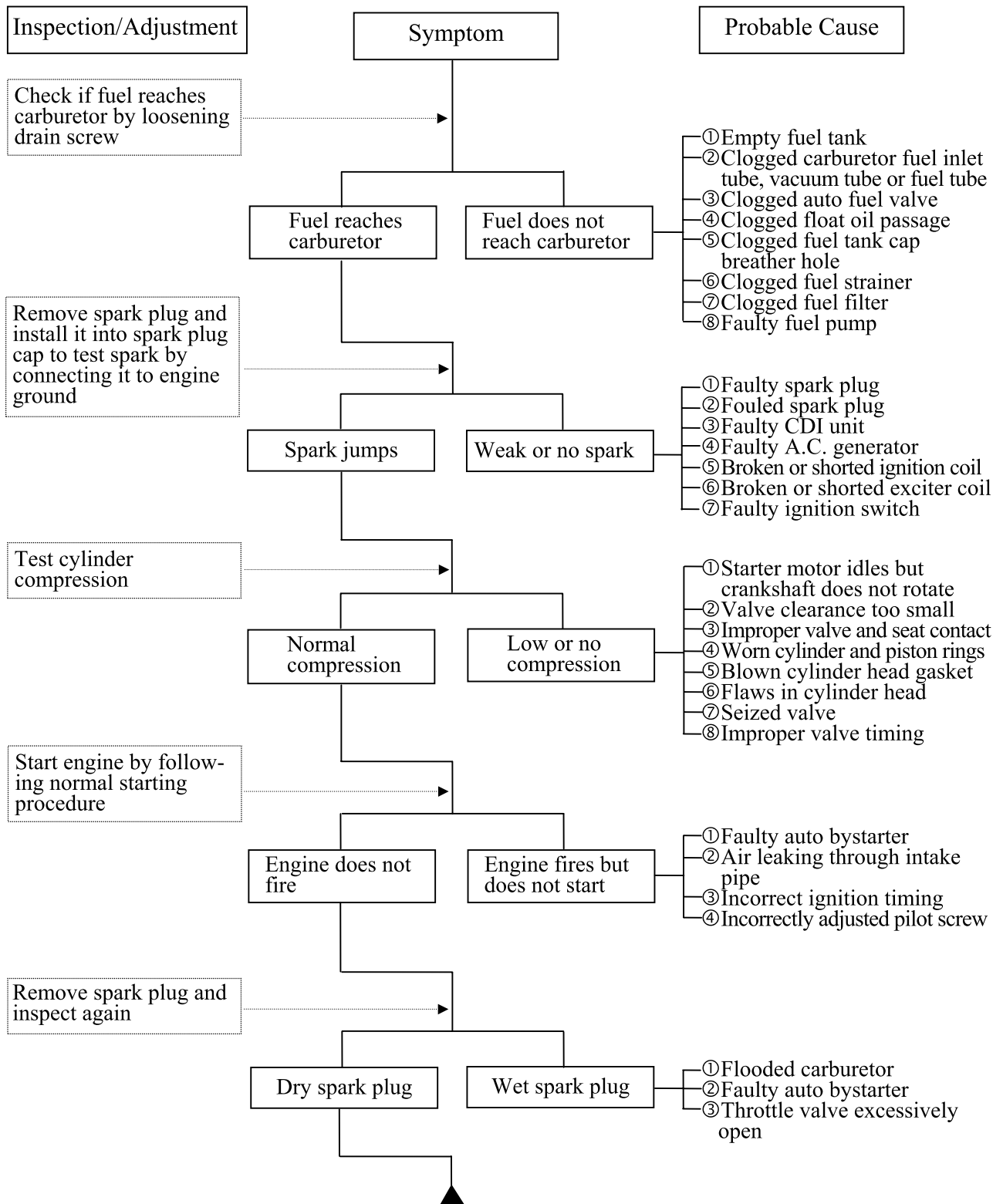

1. GENERAL INFORMATION

ENGINE LACKS POWER

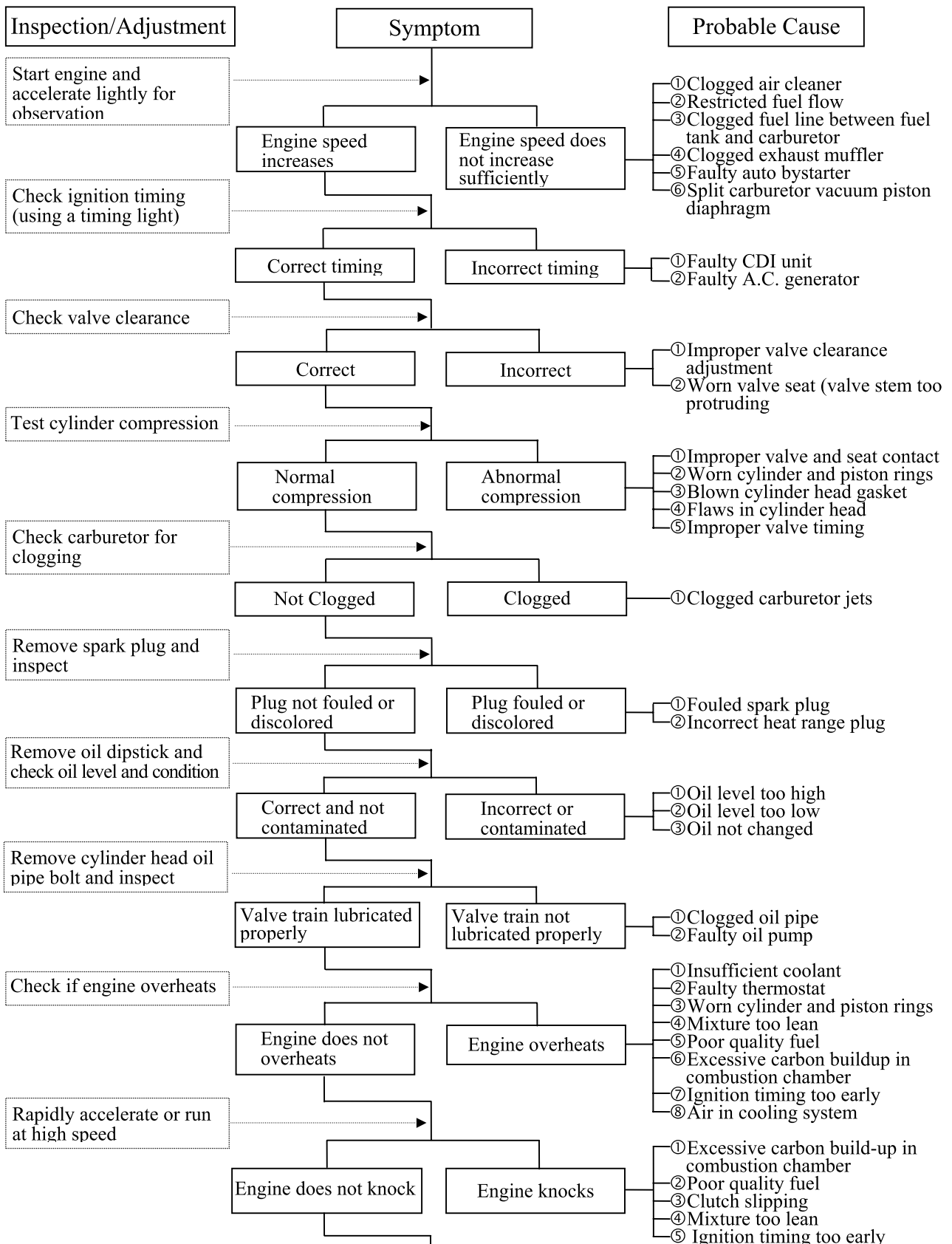

1. GENERAL INFORMATION

POOR PERFORMANCE (ESPECIALLY AT IDLE AND LOW SPEEDS)

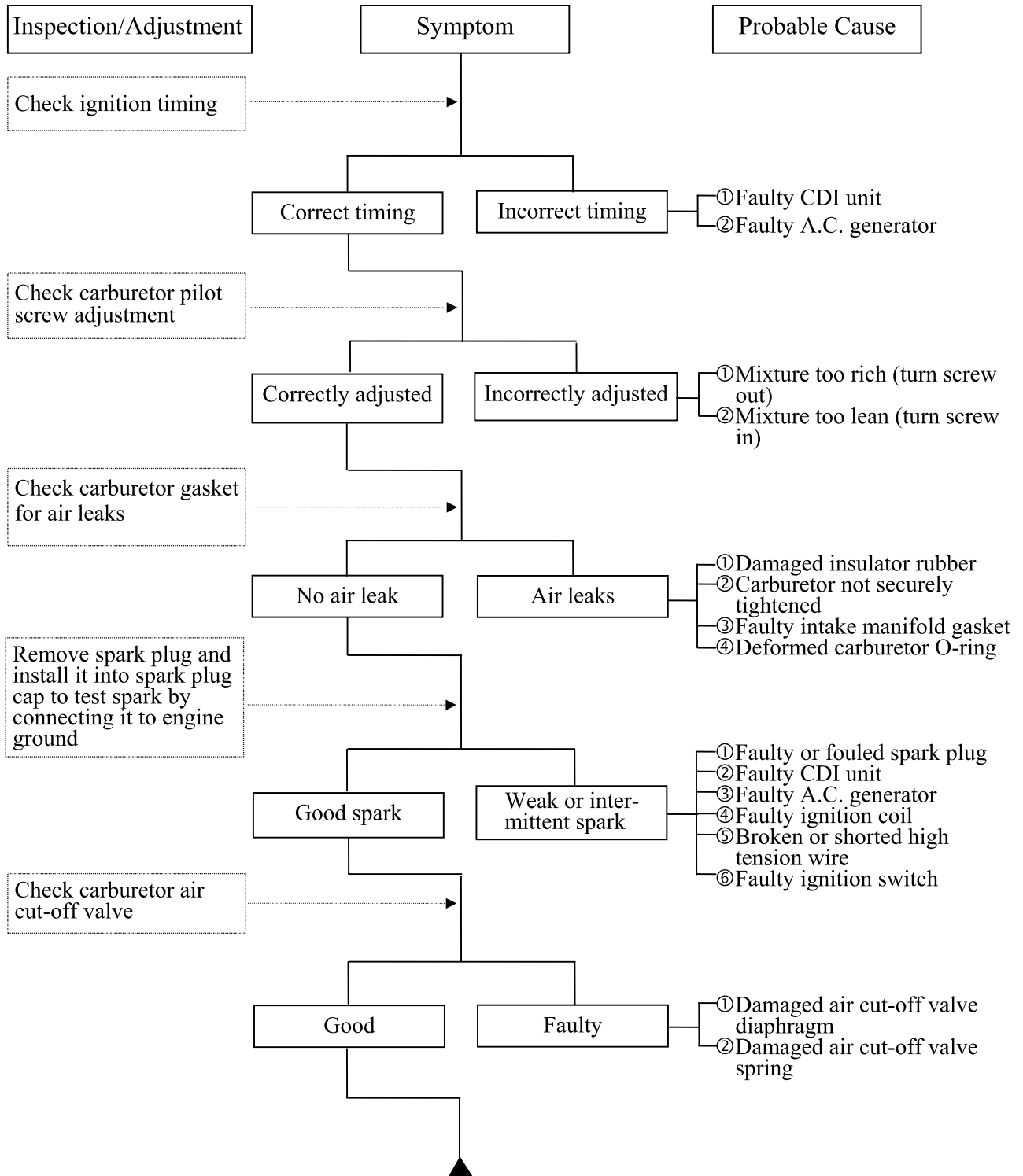

1. GENERAL INFORMATION

POOR PERFORMANCE (AT HIGH SPEED)

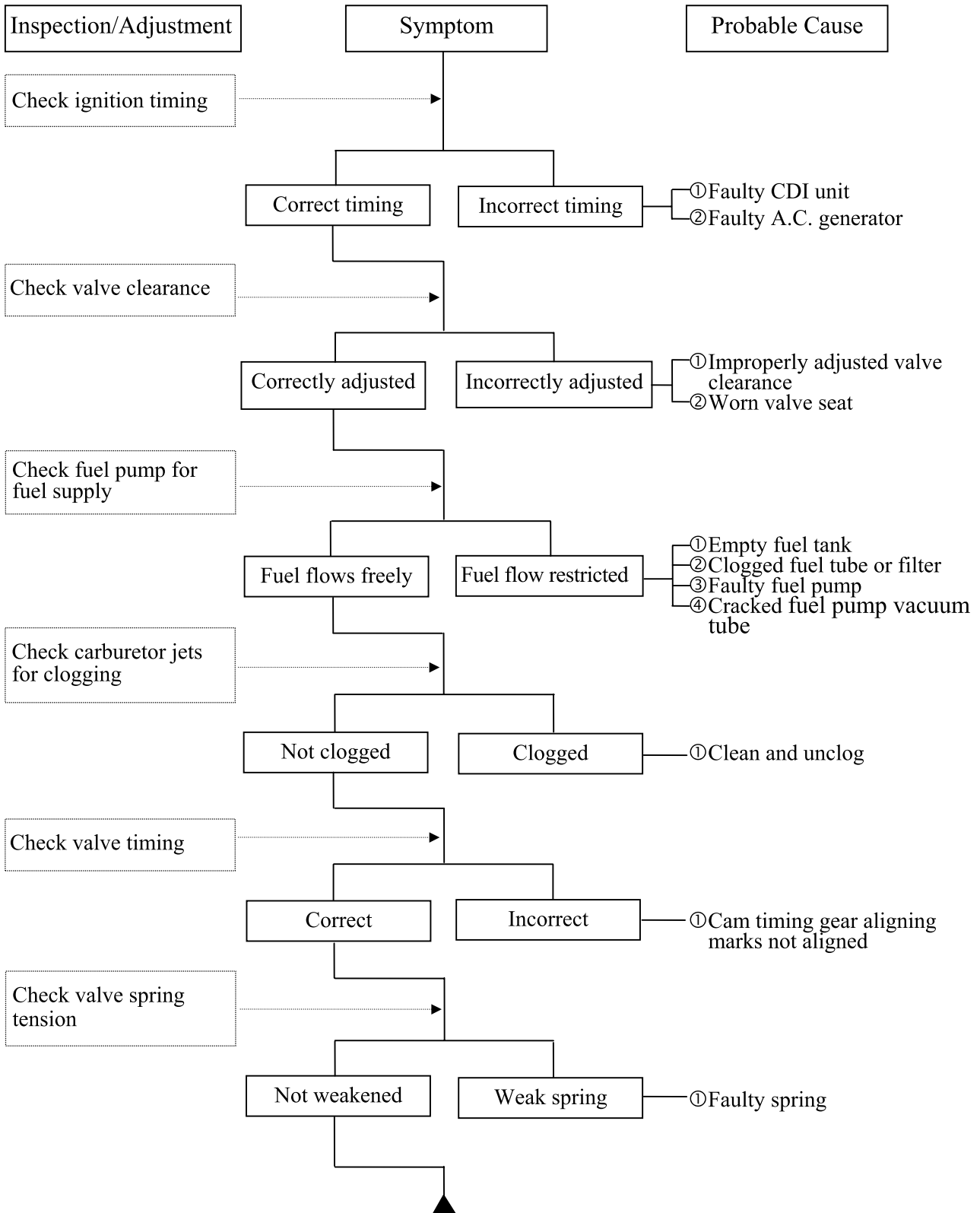

1. GENERAL INFORMATION

ENGINE NOISE

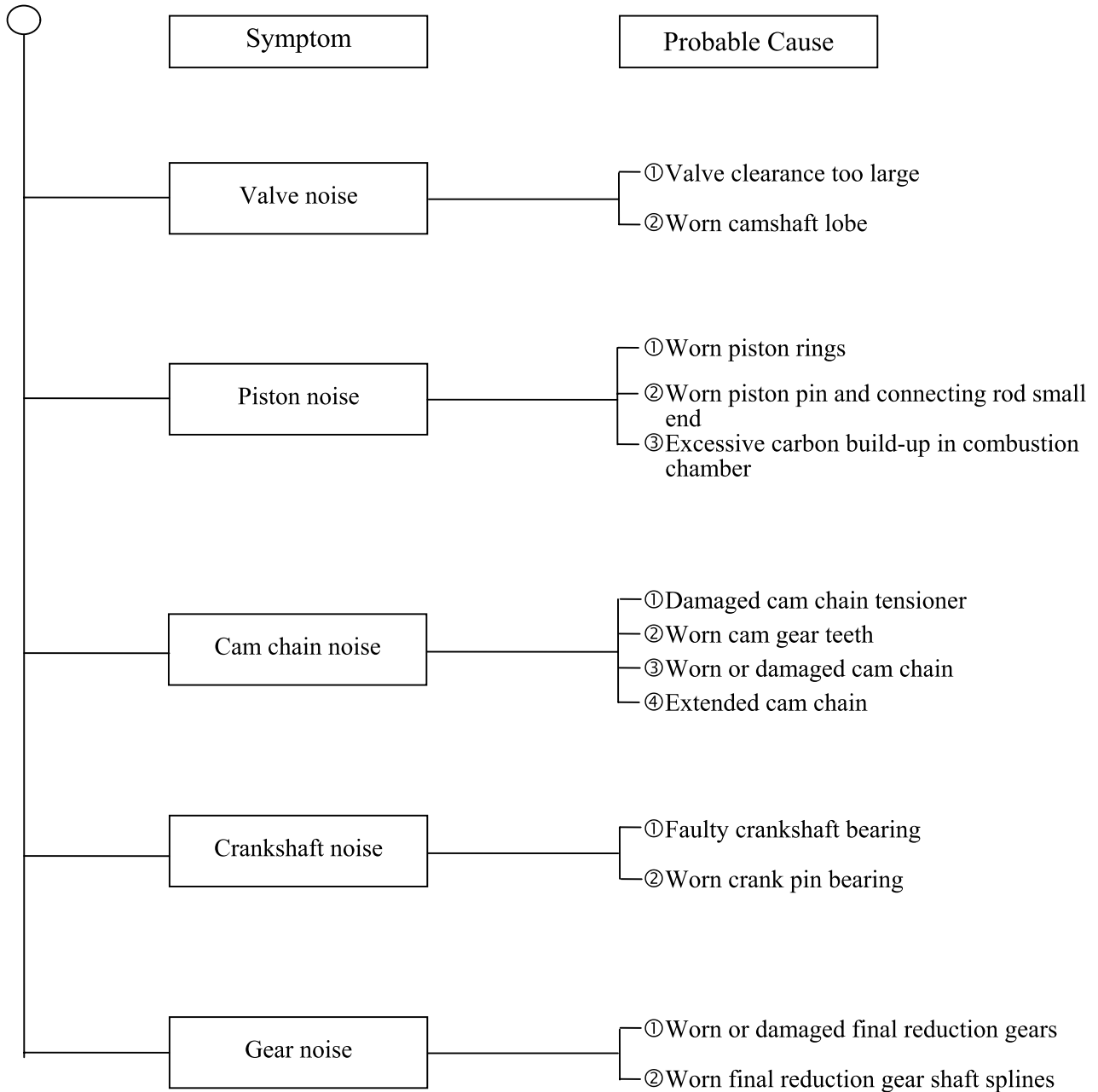

1. GENERAL INFORMATION

CLUTCH, DRIVE AND DRIVEN PULLEYS

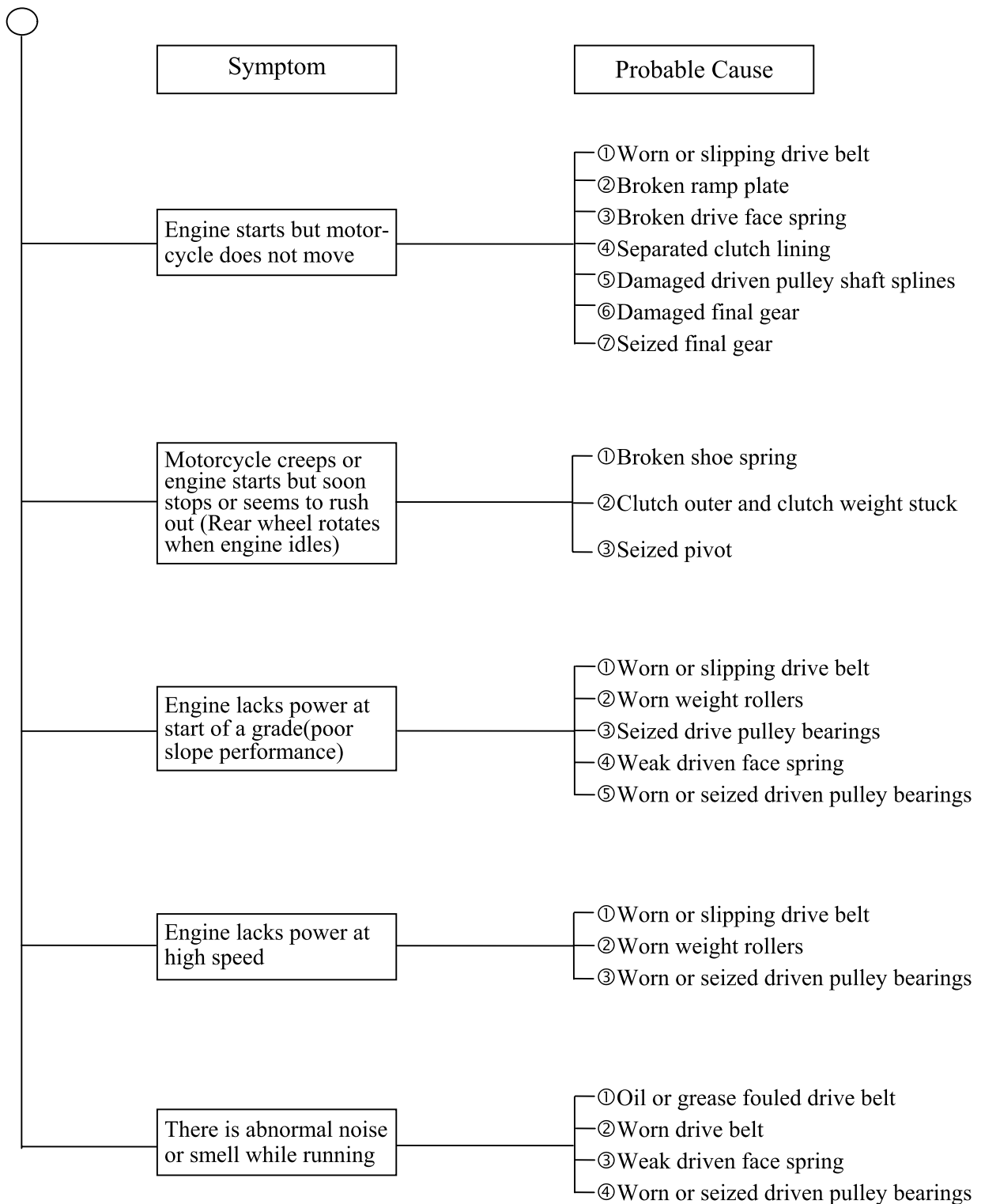

1. GENERAL INFORMATION

STARTER MOTOR

1. Starter motor won't turn

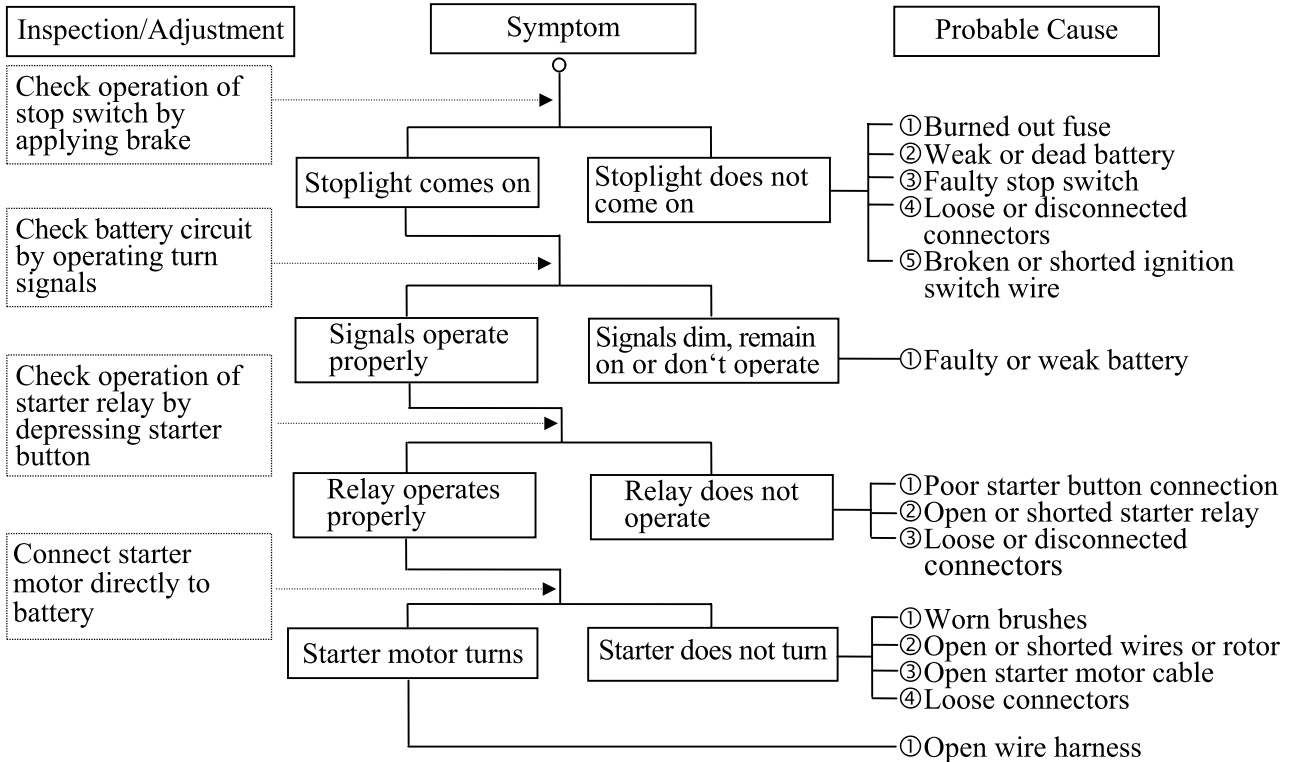

2. Starter motor turns slowly or idles

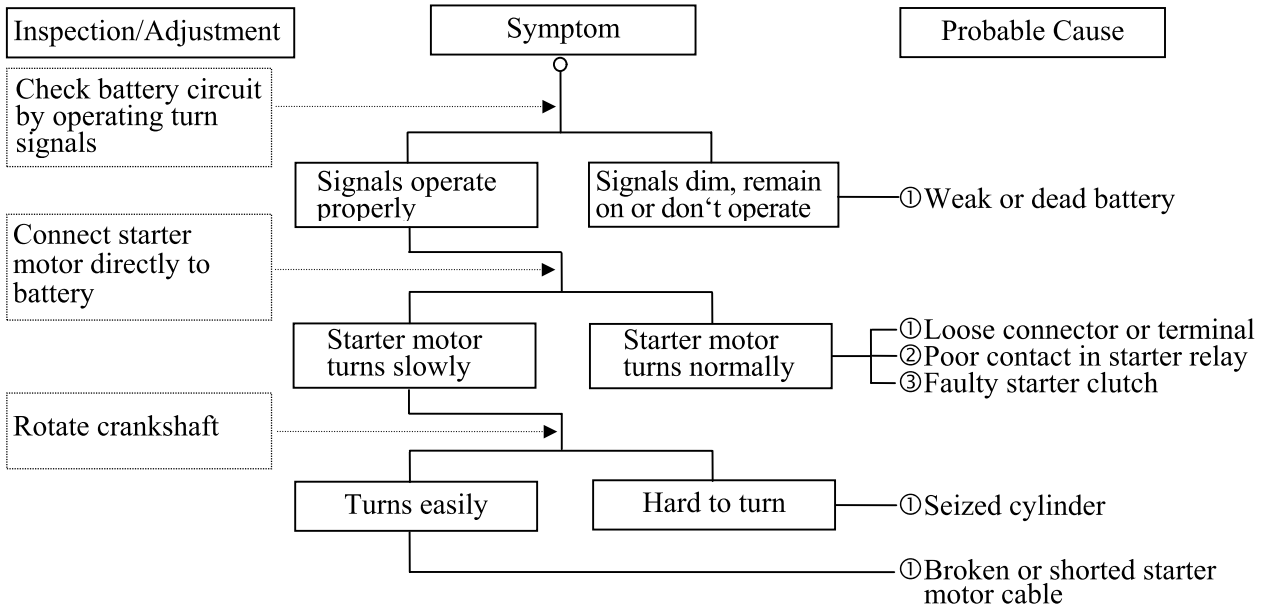

3. Starter motor does not stop turning

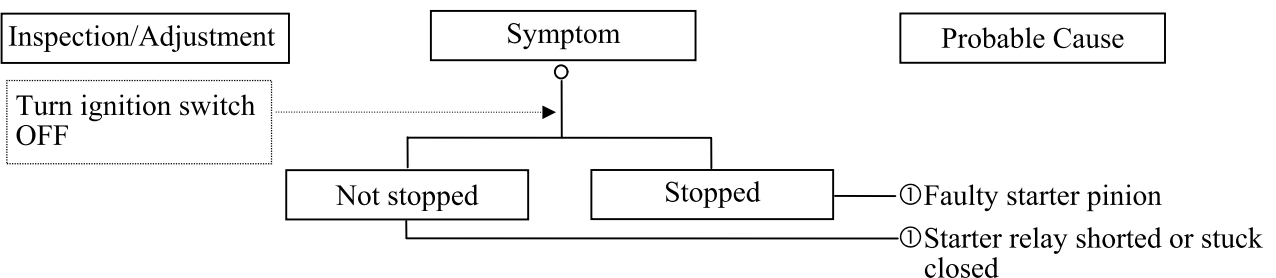

1. GENERAL INFORMATION

NO SPARK AT SPARK PLUG

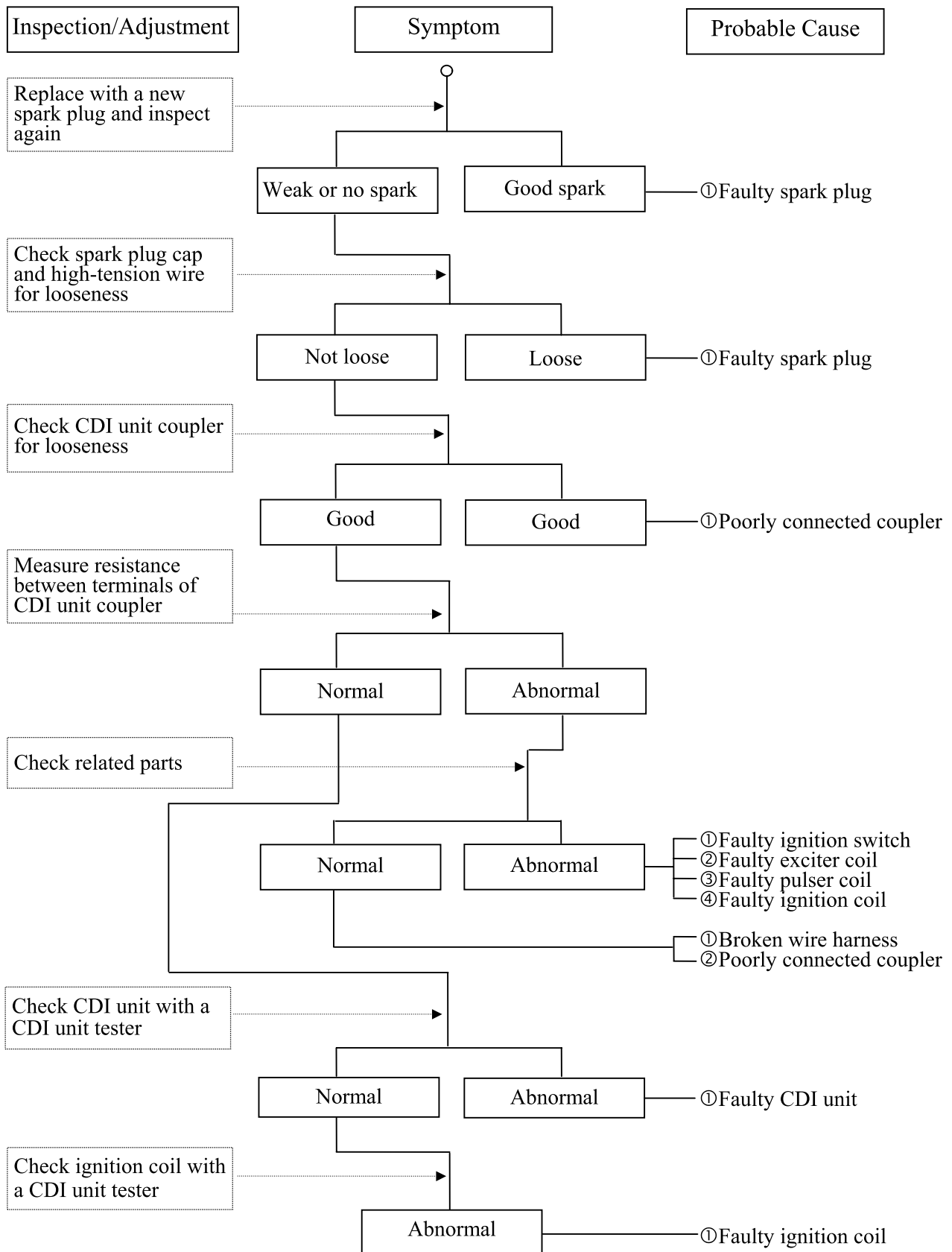

1. GENERAL INFORMATION

POOR CHARGING (BATTERY OVER DISCHARGING OR OVERCHARGING)

Undercharging

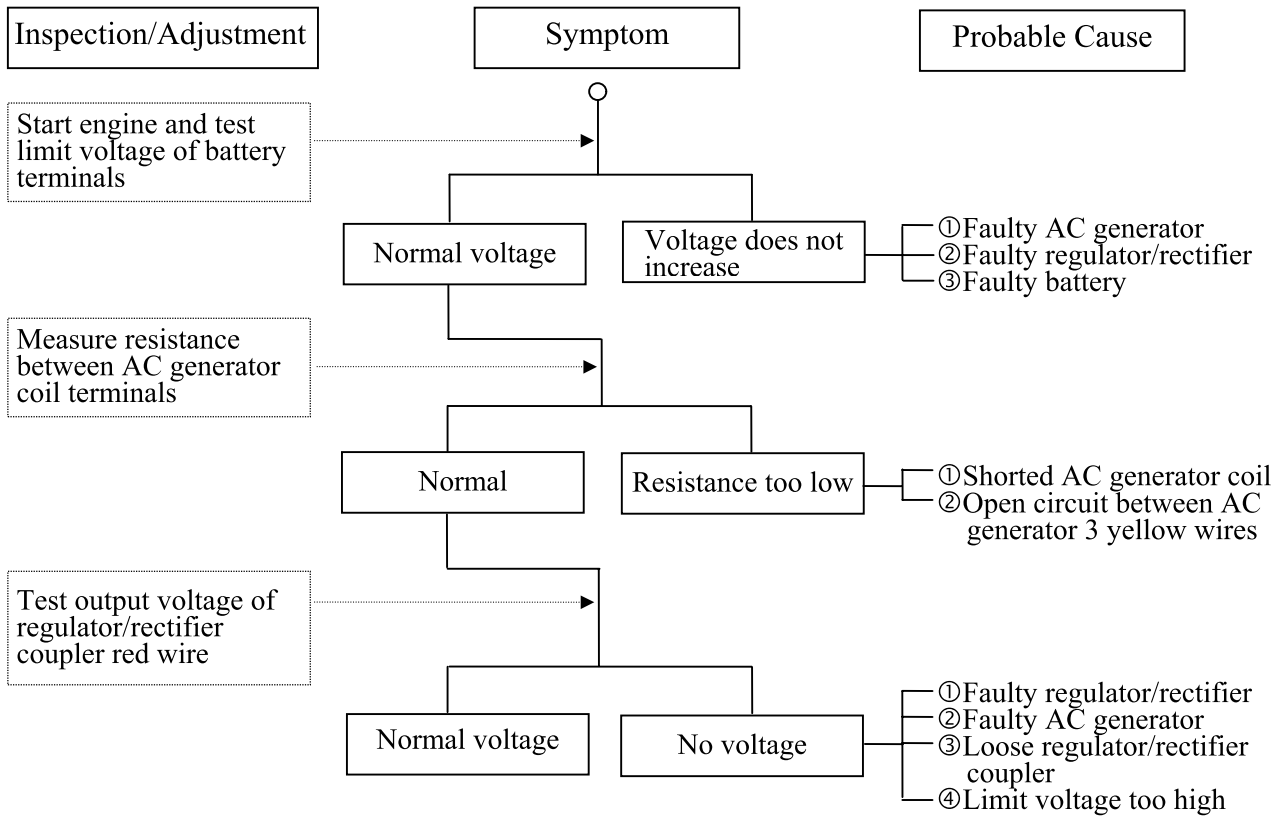

Overcharging

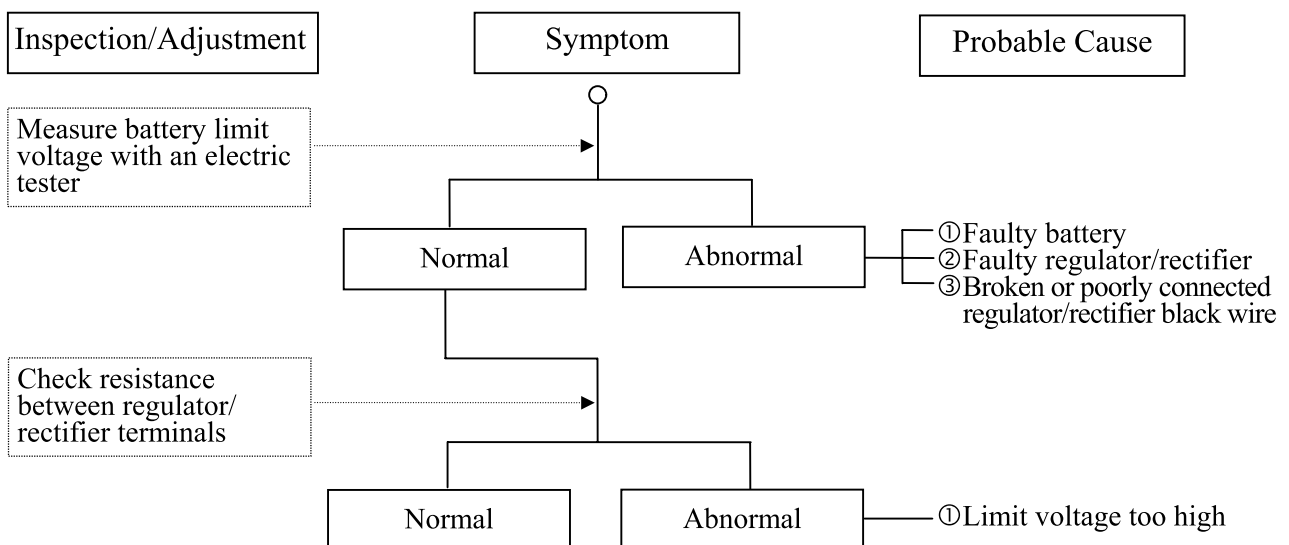

1. GENERAL INFORMATION

FUEL GAUGE

1. Pointer does not register correctly (Ignition switch ON)

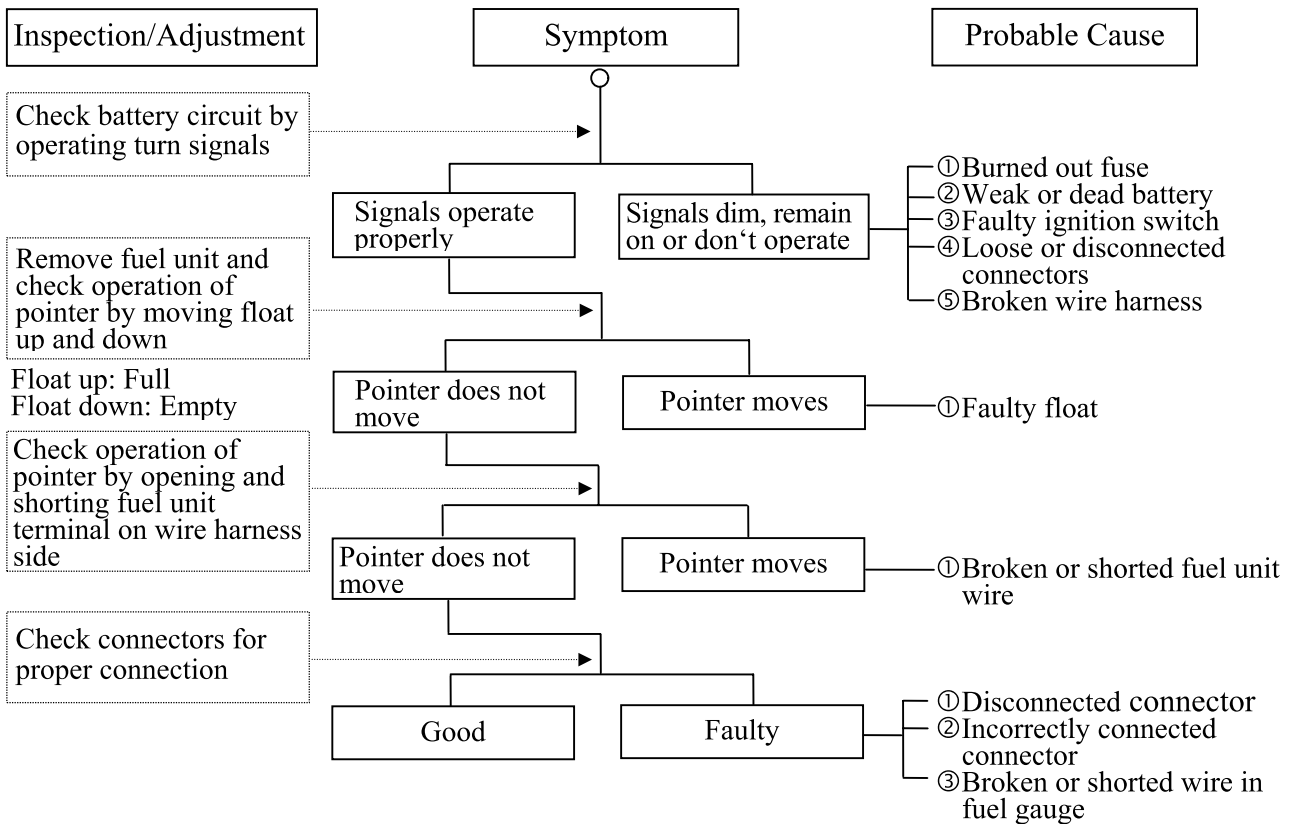

2. Pointer fluctuates or swings (Ignition switch ON)

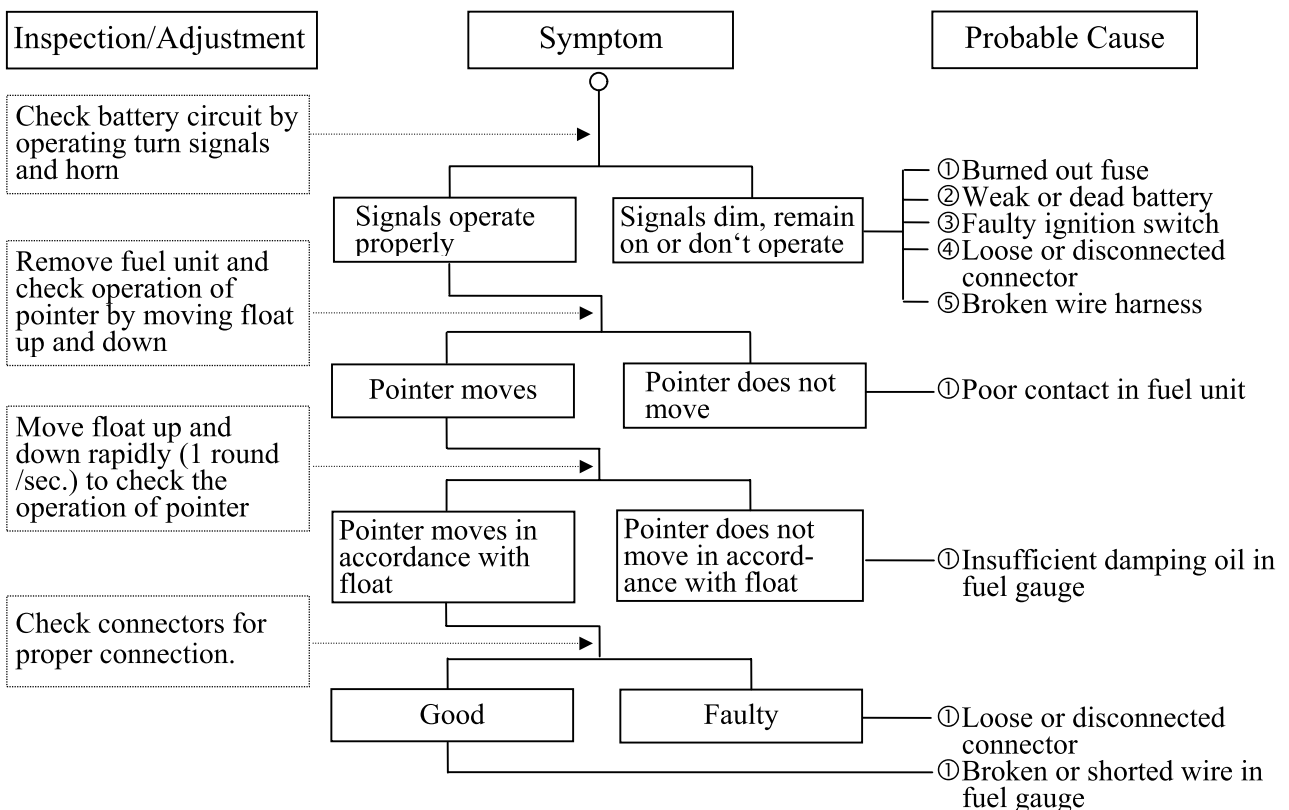

1. GENERAL INFORMATION

STEERING HANDLEBAR DOES NOT TRACK STRAIGHT

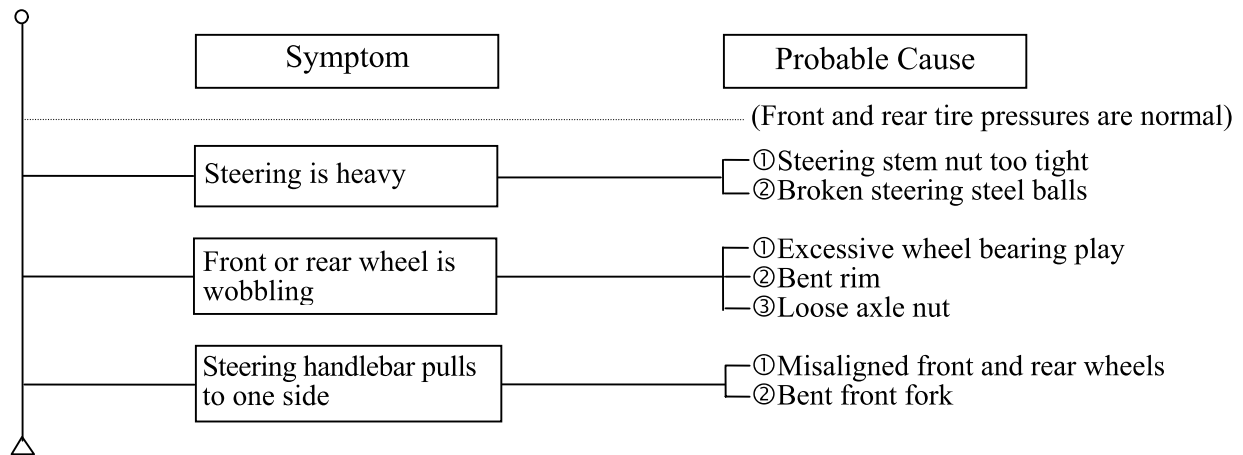

POOR SUSPENSION PERFORMANCE

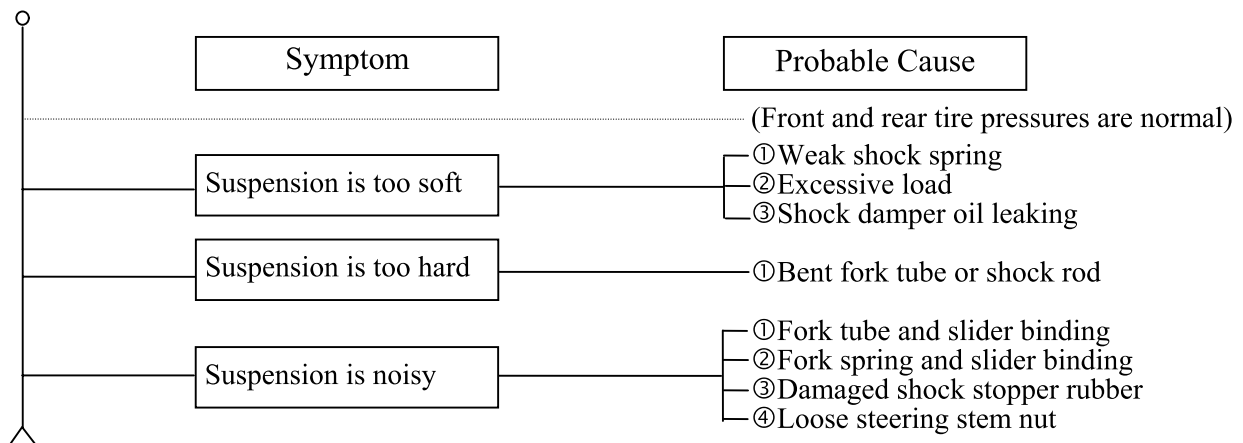

POOR BRAKE PERFORMANCE

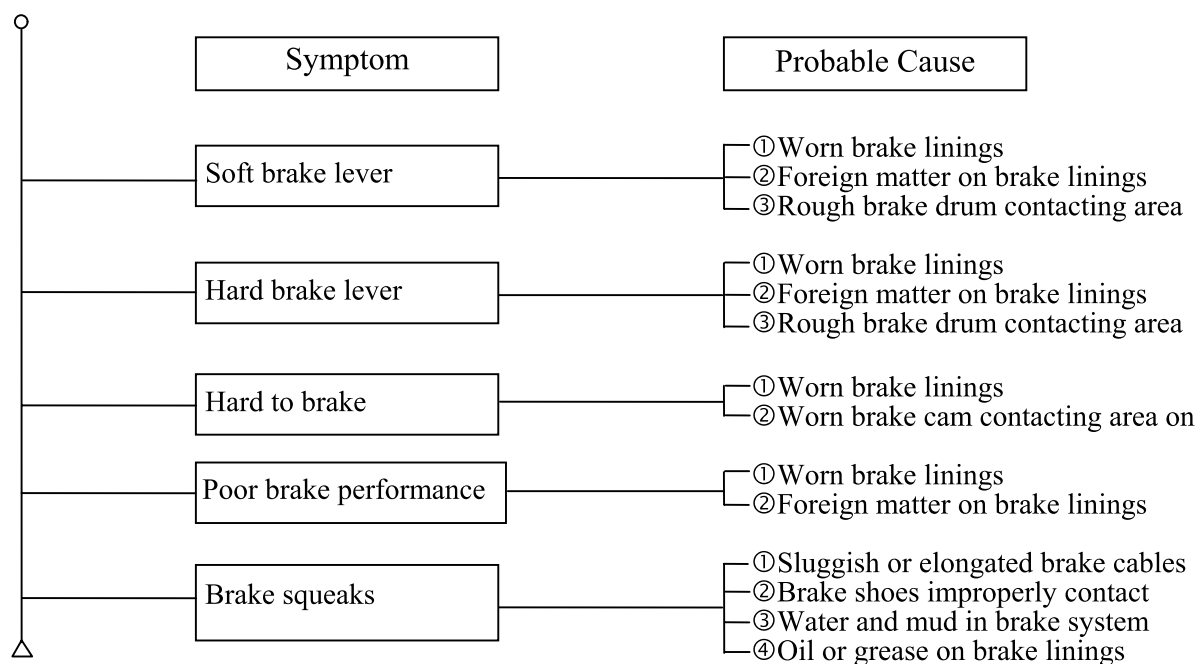

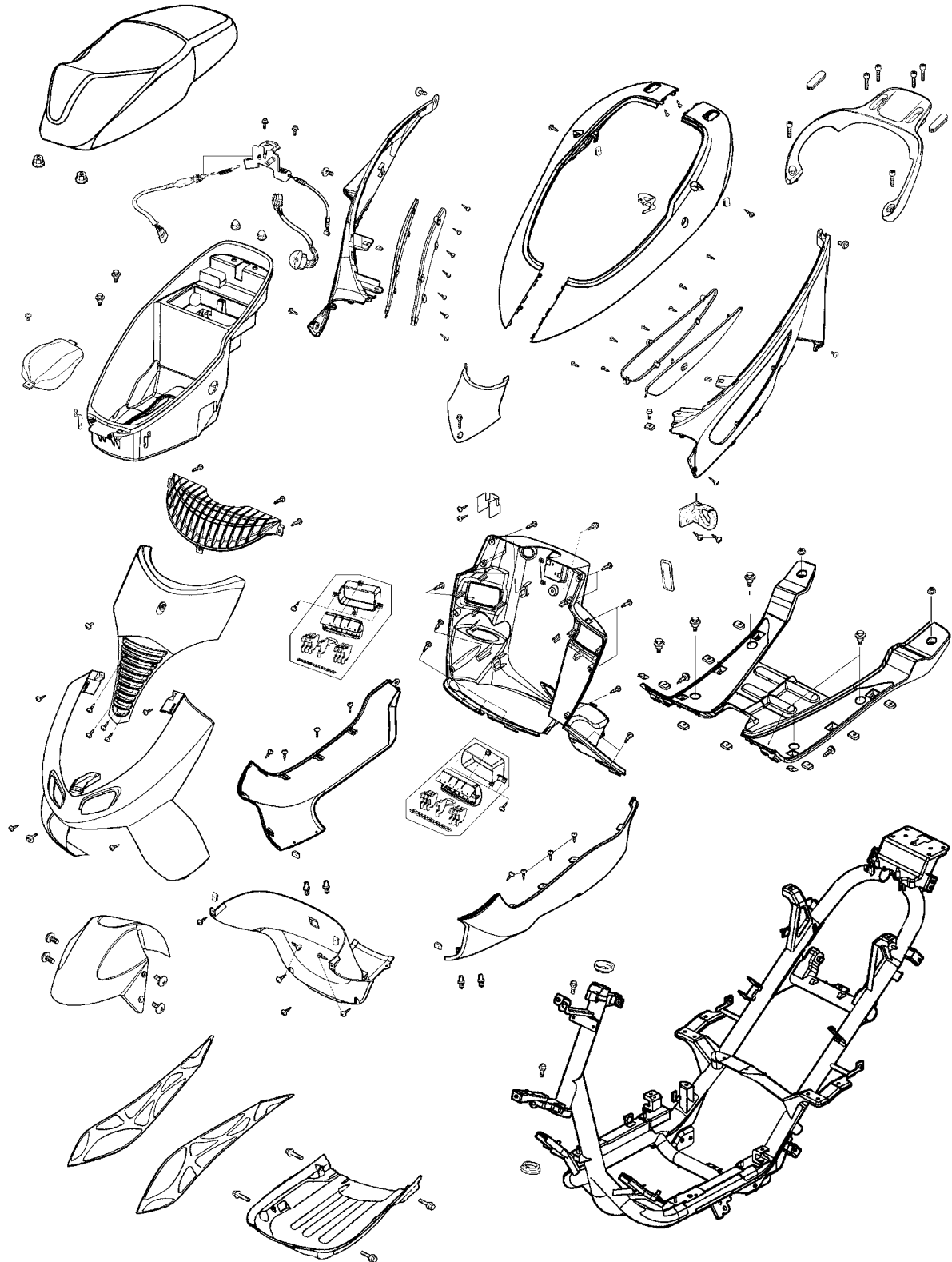
SCHEMATIC DRAWING

2. EXHAUST MUFFLER/FRAME COVERS

SERVICE INFORMATION

GENERAL INSTRUCTIONS

- When removing frame covers, use care not to pull them by force because the cover joint claws may be damaged.
- Make sure to route cables and harnesses according to the Cable & Harness Routing.

TORQUE VALUES

Exhaust muffler lock bolt	34.3N-m
Exhaust muffler joint lock nut	11.8N-m

TROUBLESHOOTING

Noisy exhaust muffler

- Damaged exhaust muffler
- Exhaust muffler joint air leaks

Lack of power

- Caved exhaust muffler
- Clogged exhaust muffler
- Exhaust muffler air leaks

2. EXHAUST MUFFLER/FRAME COVERS

FRAME COVERS REMOVAL

REAR CARRIER & HAND RAIL REMOVAL

Remove the met-in box:
 First remove the two bolts and two nuts attaching the met-in box.
 Remove the battery, C D I, fuse.
 Remove the met-in box.

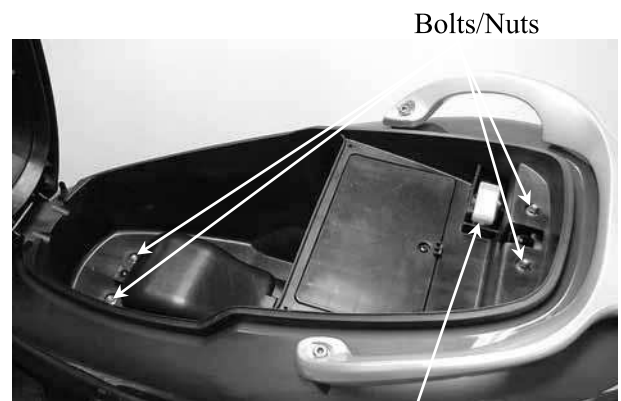

Bolts/Nuts

Fuse

Remove the hand rail right and left lock hex bolts.
 Remove the four hex bolts
 Remove the rear carrier and hand rail.

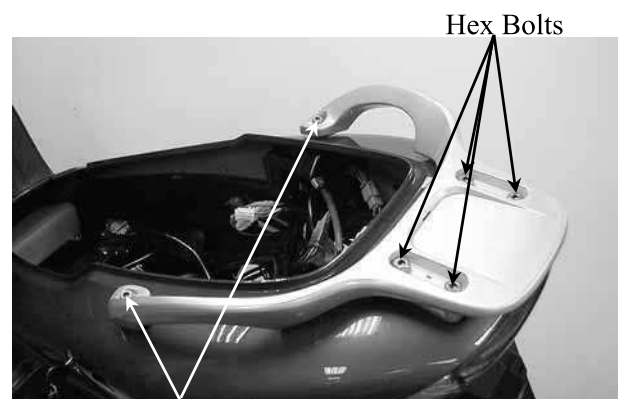

Hex Bolts

Hex Bolts

FRAME BODY COVER REMOVAL

Remove the one screws on the bottom of the center cover.
 Remove the center cover.
 Remove the two screws attaching the front part of the frame body cover.

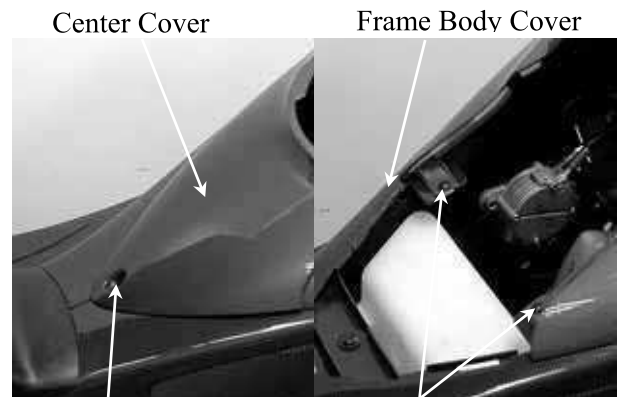

Center Cover

Frame Body Cover

Screws

Screws

Remove the right and left screws on the rear part of the frame body cover.
 Disconnect the seat lock wire.
 Remove the frame body cover.



Screws

2. EXHAUST MUFFLER/FRAME COVERS

Remove the midst screw attaching the right and left side covers.



Screws

Side Cover

Remove the screws attaching the right and left side covers.



Screw

FLOOR BOARD REMOVAL

Remove the floor mat.
 Remove the center cover. (⇒2-3)
 Remove the five screws and four screws attaching the front right and left side covers.
 Remove the two bottom cover adjusting screws.
 Remove the front right and left side covers.

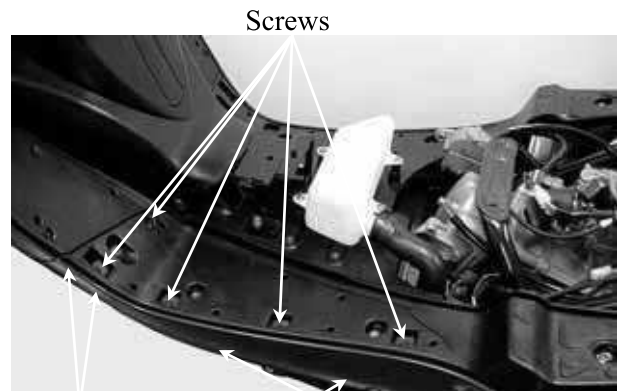

Screws

Screw

Adjusting Screws

Remove the air box four screws.
 Remove the prop two bolts.
 Remove the two nuts
 Remove the six bolts attaching the floor board.
 Remove the floor board .
 The installation sequence is the reverse of removal.

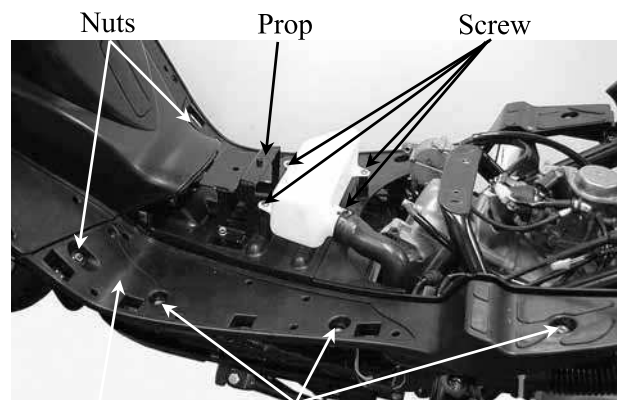

Nuts

Prop

Screw

Floor Board

Bolts

2. EXHAUST MUFFLER/FRAME COVERS

FRONT UPPER COVER REMOVAL

Remove the four screws on the front upper cover.

Remove the four screws on the back of the front upper cover.

Remove the front upper cover.

The installation sequence is the reverse of removal.

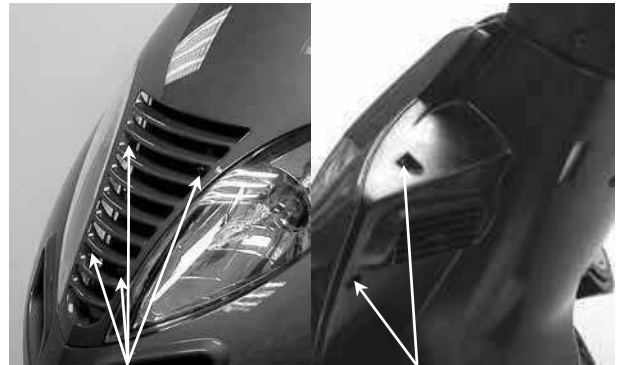

Screws

Screws

FRONT LOWER COVER REMOVAL

First remove the front upper cover.

Remove the two screws attaching the front lower cover.

Remove the four screws on the back of the front lower cover.

Disconnect the right/left turn signal light wire connectors.

Remove the front lower cover

The installation sequence is the reverse of removal.



Screws

Screws

BACK COVER REMOVAL

Remove the front cover.

Remove the key moldings.

Remove the fuel cap moldings.

Remove the back cover bolt.



Key Moldings

Bolt Fuel Cap Moldings

Remove the fuel tank inlet tube join.

Remove the fuel tank breather tube join.

Remove the back cover.

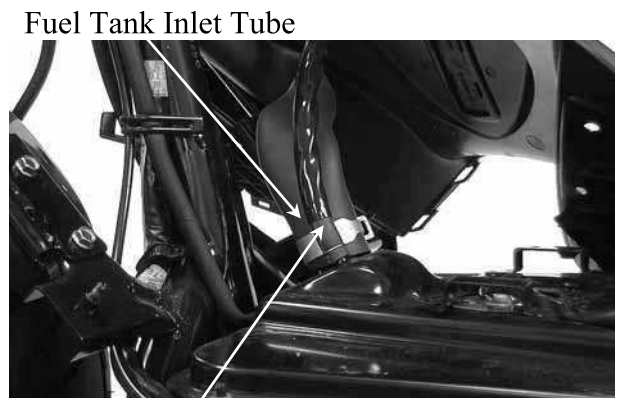

Fuel Tank Inlet Tube

Fuel Tank Breather Tube

2. EXHAUST MUFFLER/FRAME COVERS

HANDLEBAR COVER REMOVAL

First remove the seven screws attaching the handlebar back cover.
Remove the handlebar back cover.

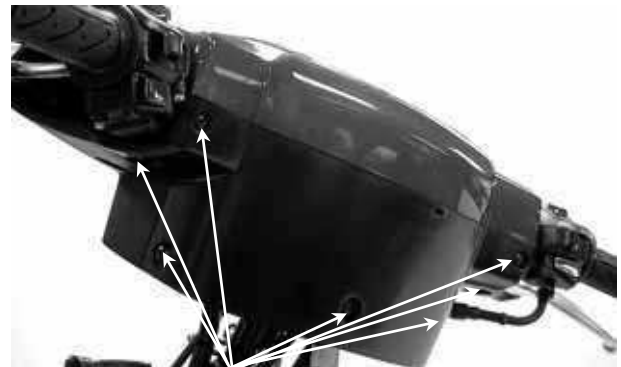

Screws

BOTTOM COVER REMOVAL

Remove the side stand.
Remove the four bolts attaching the bottom cover.
Remove the bottom cover.

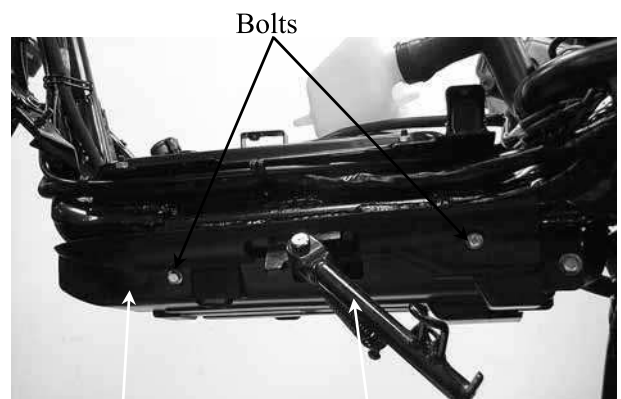

Bottom Cover

Side Stand

FRONT FENDER REMOVAL

Remove the two bolts attaching the fender.
Remove the front fender cover.
The installation sequence is the reverse of removal.

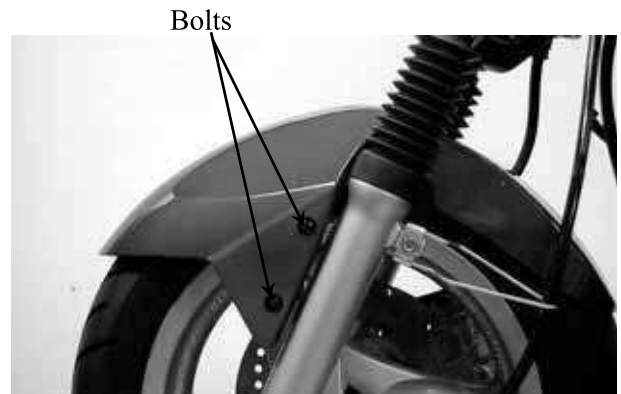

Bolts

EXHAUST MUFFLER REMOVAL

Remove the two exhaust muffler joint lock nuts.
Remove the two exhaust muffler lock bolts to remove the exhaust muffler.
Remove the exhaust muffler joint packing collar.
The installation sequence is the reverse of removal.

Torque:

Exhaust muffler joint lock nut: 11.8N-m
Exhaust muffler lock bolt: 34.3N-m

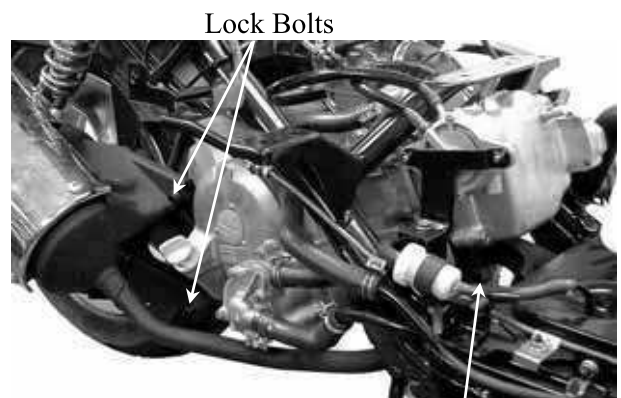

Lock Bolts

Joint Lock Nut