

**By KWANG YANG Motor Co., Ltd.
1st Edition, April 2009
All rights reserved. Any reproduction or
unauthorized use without the written
permission of KWANG YANG Motor Co., Ltd.
is expressly prohibited.
T100-LFA7-A2**

PREFACE

This Service Manual describes the technical features and servicing procedures for the KYMCO **Downtown 125i**.

Section 1 contains the precautions for all operations stated in this manual. Read them carefully before any operation is started.

Section 2 is the removal/installation procedures for the frame covers which are subject to removal/installation frequency during maintenance and servicing operations.

Section 3 describes the inspection/adjustment procedures, safety rules and service information for each part, starting from periodic maintenance.

Sections 5 to 11 give instructions for disassembly, assembly and adjustment of engine parts. Section 13-14 is the AFI system. Section 15 to 16 is the removal/ installation of chassis. Section 17 to 20 states the testing and measuring methods of electrical equipment.

Most sections start with an assembly or system illustration and troubleshooting for the section. The subsequent pages give detailed procedures for the section.

The information and contents included in this manual may be different from the motorcycle in case specifications are changed.

KWANG YANG MOTOR CO., LTD.
QUALITY TECHNOLOGY DEPT.
EDUCATION SECTION

TABLE OF CONTENTS

ENGINE	GENERAL INFORMATION	1
	EXHAUST MUFFLER/FRAME COVERS	2
	INSPECTION/ADJUSTMENT	3
	LUBRICATION SYSTEM	4
	ENGINE REMOVAL/INSTALLATION	5
	CYLINDER HEAD/VALVES	6
	CYLINDER/PISTON	7
	DRIVE AND DRIVEN PULLEYS	8
	FINAL REDUCTION	9
	A.C. GENERATOR/STARTER CLUTCH	10
	CRANKCASE/CRANKSHAFT	11
	COOLING SYSTEM	12
	FI DIAGNOSTIC TOOL OPERATION	13
	FUEL INJECTION SYSTEM	14
CHASSIS	HANDLEBAR/FRONT WHEEL/FRONT BRAKE/FRONT SHOCK ABSORBER/STEERING STEM	15
	REAR BRAKE/REAR FORK/REAR WHEEL/REAR SHOCK ABSORBER	16
ELECTRICAL EQUIPMENT	BATTERY/CHARGING SYSTEM	17
	IGNITION SYSTEM	18
	STARTING SYSTEM	19
	LIGHTS/METERS/SWITCHES	20

1. GENERAL INFORMATION

ENGINE SERIAL NUMBER	1- 1	LUBRICATION POINTS.....	1-14
SPECIFICATIONS	1- 2		
SERVICE PRECAUTIONS	1- 3		
TORQUE VALUES	1-11		
SPECIAL TOOLS.....	1-12		

ENGINE SERIAL NUMBER

**1**

Location of Engine Serial Number

1. GENERAL INFORMATION

SPECIFICATIONS

Name		DOWNTOWN125i		
Model No.		SK25AA		
Overall length		2200mm		
Overall width		800 mm		
Overall height		1410 mm		
Wheel base		1542 mm		
Engine type		O.H.C.		
Displacement		124.8cc		
Fuel Used		92# nonleaded gasoline		
Net weight (kg)	Front wheel	68		
	Rear wheel	96		
	Total	164		
Gross weight(kg)	Front wheel	70		
	Rear wheel	104		
	Total	178		
Tires	Front wheel	120/80-14		
	Rear wheel	150/70-13		
RR Ground clearance		140 mm		
Performance	Braking distance (m)	7.9m/30km/h		
	Min. turning radius	2600mm		
Engine	Starting system		Starting motor	
	Type		liquid cooled 4 stroke	
	Cylinder arrangement		Single cylinder	
	Combustion chamber type		Semi-sphere	
	Valve arrangement		O.H.C.4V	
	Bore x stroke (mm)		54 x 54.5	
	Compression ratio		11.7:1	
	Compression pressure (kg/cm ²)		15	
	Max .horsepower (ps/rpm)		15/8750~9000	
	Max. torque (kg m/rpm)		1.17/8500~8750	
	Port timing	Intake (1mm)	Open	8 °BTDC
			Close	31° BTDC
		Exhaust (1mm)	Open	32° BTDC
			Close	6 °BTDC
	Valve clearance	Intake	0.10 mm	
		Exhaust	0.10 mm	
	Idle speed (rpm)		1850rpm	
	Lubrication System	Lubrication type		Forced pressure & Wet sump
		Oil pump type		Inner/outer rotor type
		Oil filter type		Full-flow filtration
Oil capacity		1.2 L		
Exchanging capacity		1.0 L		
Cooling Type		Liquid cooling		

Fuel System	Air cleaner type & No		Paper element, wet	
	Fuel capacity		12.5 L	
Electrical Equip.	Ignition System	Type	ECU	
		Spark plug	NGK CR7E	
		Spark plug gap	0.6~0.7mm	
Power Drive System	Battery	Capacity	12V10AH	
	Clutch	Type	Dry multi-disc clutch	
		Transmission Gear	Type	Non-stage transmission
	Reduction Gear		Operation	Automatic centrifugal type
Reduction ratio		Type	Two-stage reduction	
	1st	0.83~2.2		
		2nd	10.41	
Moving Device	Front Axle	Caster angle	28°	
		Trail length	140mm	
	Tire pressure (kg/cm ²) 1 person	Front	2.0	
		Rear	2.25	
Turning angle	Left	40°		
	Right	40°		
Brake system type	Front	Disk brake		
	Rear	Disk brake		
Damping Device	Suspension type	Front	Telescope	
		Rear	DOUBLE SWING	
Frame type		PIPE UNDER BONE		

1. GENERAL INFORMATION

SERVICE PRECAUTIONS

- Make sure to install new gasket, O-rings, circlips, cotter pins, etc. When reassembling.

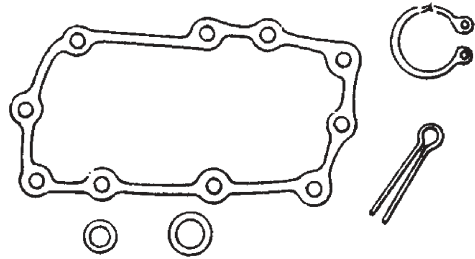

- When tightening bolts or nuts, begin with larger-diameter to smaller ones at several times, and tighten to specified torque diagonally.

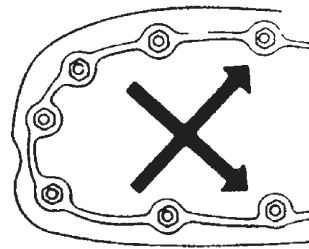

- Use genuine parts and lubricants.

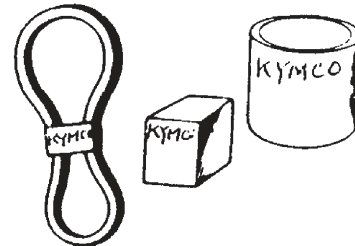

- When servicing the motorcycle, be sure to use special tools for removal and installation.

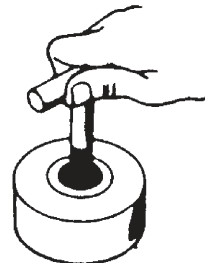

- After disassembly, clean removed parts. Lubricate sliding surfaces with engine oil before reassembly.

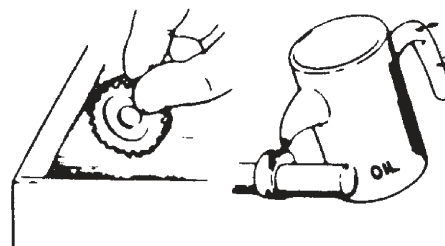

1. GENERAL INFORMATION

- Apply or add designated greases and lubricants to the specified lubrication points.

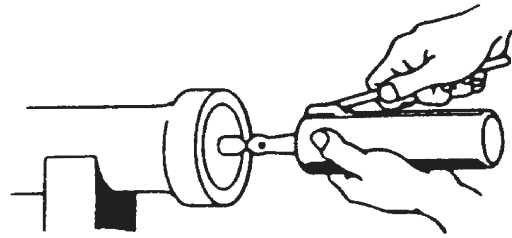

- After reassembly, check all parts for proper tightening and operation.

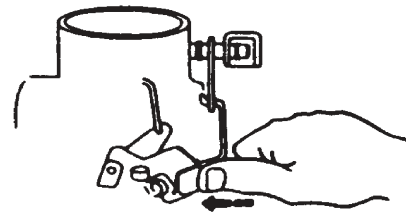

- When two person work together, pay attention to the mutual working safety.

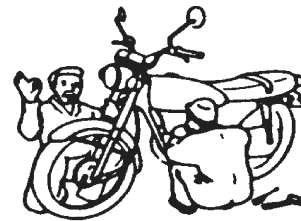

- Disconnect the battery negative (-) terminal before operation.

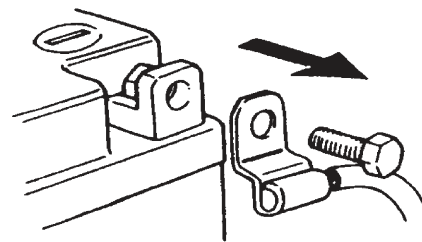

- When using a spanner or other tools, make sure not to damage the motorcycle surface.

- After operation, check all connecting points, fasteners, and lines for proper connection and installation.

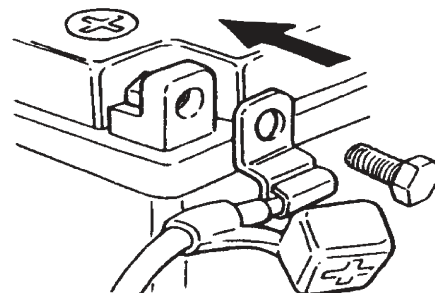

- When connecting the battery, the positive (+) terminal must be connected first.

- After connection, apply grease to the battery terminals.

- Terminal caps shall be installed securely.

1. GENERAL INFORMATION

- If the fuse is burned out, find the cause and repair it. Replace it with a new one according to the specified capacity.

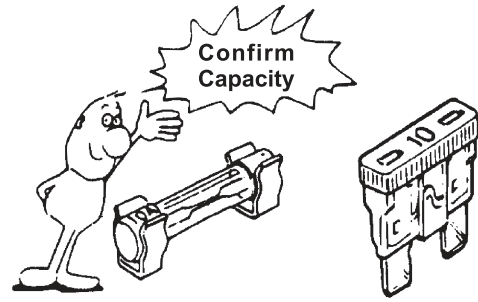

- After operation, terminal caps shall be installed securely.



- When taking out the connector, the lock on the connector shall be released before operation.

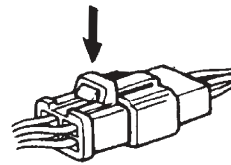

- Hold the connector body when connecting or disconnecting it.
- Do not pull the connector wire.



- Check if any connector terminal is bending, protruding or loose.

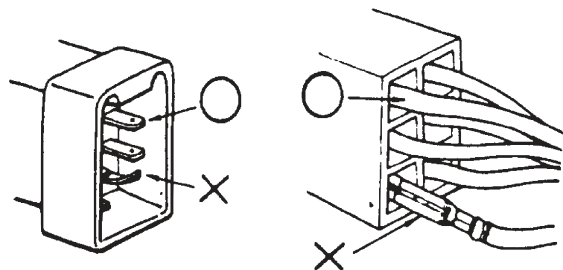

1. GENERAL INFORMATION

- The connector shall be inserted completely.
- If the double connector has a lock, lock it at the correct position.
- Check if there is any loose wire.

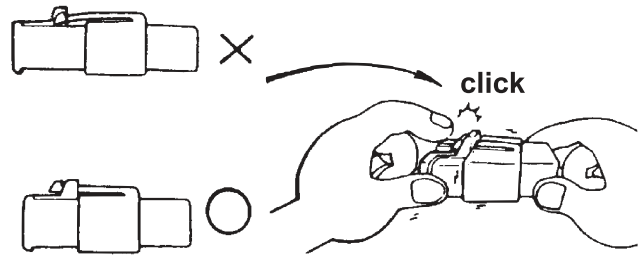

- Before connecting a terminal, check for damaged terminal cover or loose negative terminal.

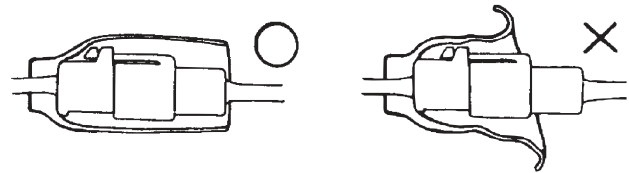

- Check the double connector cover for proper coverage and installation.

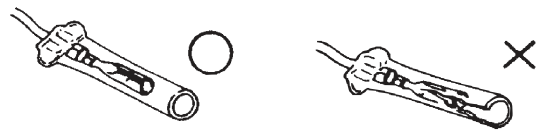

- Insert the terminal completely.
- Check the terminal cover for proper coverage.
- Do not make the terminal cover opening face up.

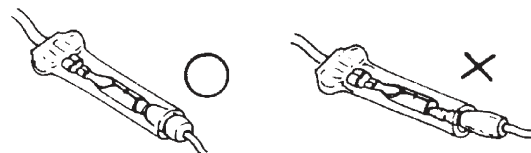

- Secure wire harnesses to the frame with their respective wire bands at the designated locations.
Tighten the bands so that only the insulated surfaces contact the wire harnesses.

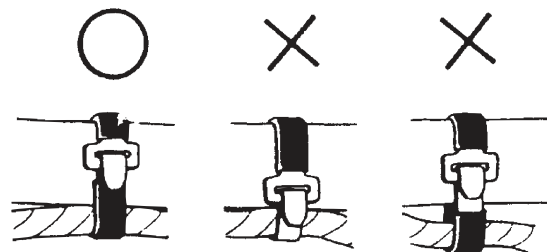

1. GENERAL INFORMATION

- After clamping, check each wire to make sure it is secure.

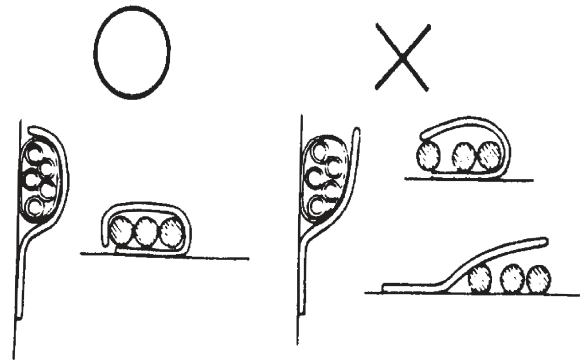

- Do not squeeze wires against the weld or its clamp



- After clamping, check each harness to make sure that it is not interfering with any moving or sliding parts.

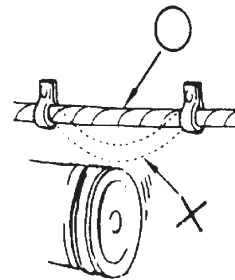

- When fixing the wire harnesses, do not make it contact the parts which will generate high heat.

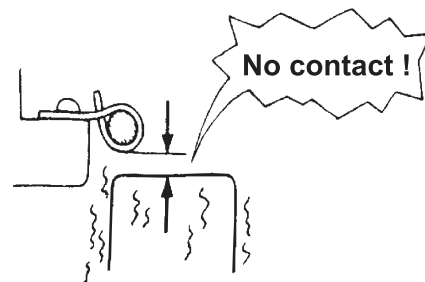

- Route wire harnesses to avoid sharp edges or corners. Avoid the projected ends of bolts and screws.

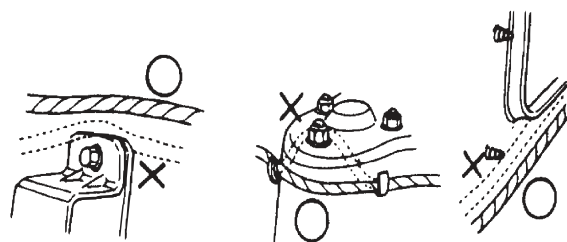

- Route wire harnesses passing through the side of bolts and screws. Avoid the projected ends of bolts and screws.

1. GENERAL INFORMATION

- Route harnesses so they are neither pulled tight nor have excessive slack.

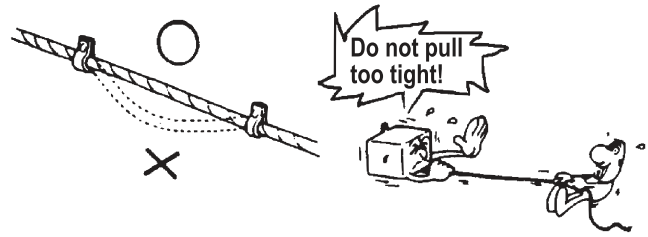

- Protect wires and harnesses with electrical tape or tube if they contact a sharp edge or corner.

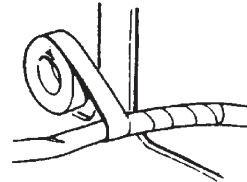

- When rubber protecting cover is used to protect the wire harnesses, it shall be installed securely.

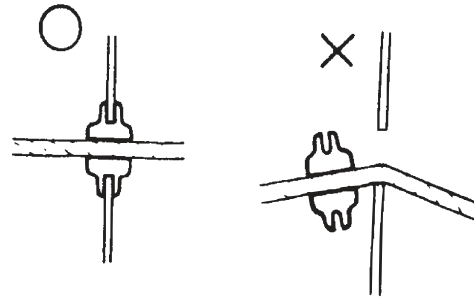

- Do not break the sheath of wire.
- If a wire or harness is with a broken sheath, repair by wrapping it with protective tape or replace it.

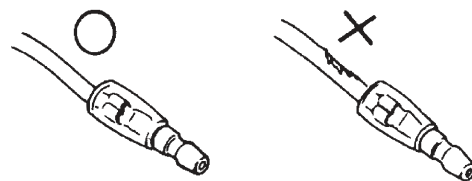

- When installing other parts, do not press or squeeze the wires.



1. GENERAL INFORMATION

- After routing, check that the wire harnesses are not twisted or kinked.

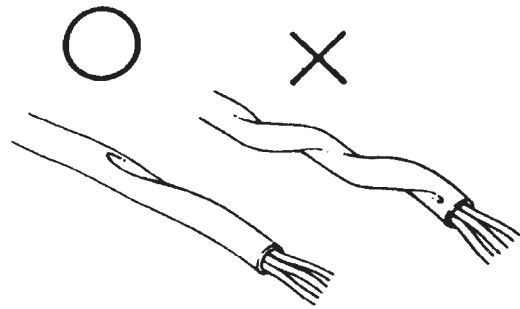

- Wire harnesses routed along with handlebar should not be pulled tight, have excessive slack or interfere with adjacent or surrounding parts in all steering positions.

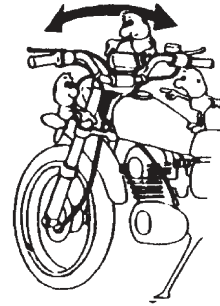

- When a testing device is used, make sure to understand the operating methods thoroughly and operate according to the operating instructions.

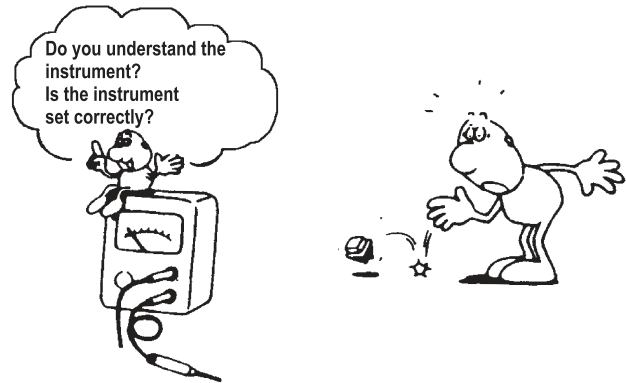

- Be careful not to drop any parts.



- When rust is found on a terminal, remove the rust with sand paper or equivalent before connecting.

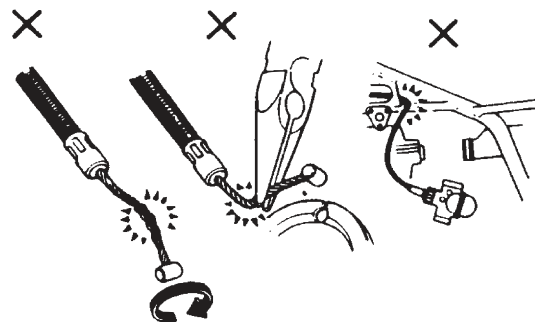

1. GENERAL INFORMATION

■ Symbols :

The following symbols represent the servicing methods and cautions included in this service manual.



:Apply engine oil to the specified points.
(Use designated engine oil for lubrication).



:Apply grease for lubrication.



:Transmission Gear Oil (90#)



:Use special tool.



:Caution



:Warning

1. GENERAL INFORMATION

TORQUE VALUES

STANDAR TORQUE VALUES

Item	Torque (kgf-m)	Item	Torque (kgf-m)
5mm bolt, nut	0.45~0.6	5mm screw	0.45~0.6
6mm bolt, nut	0.8~1.2	6mm screw, SH bolt	0.7~1.1
8mm bolt, nut	1.8~2.5	6mm flange bolt, nut	1.0~1.4
10mm bolt, nut	3.0~4.0	8mm flange bolt, nut	2.4~3.0
12mm bolt, nut	5.0~6.0	10mm flange bolt, nut	3.0~4.5

Torque specifications listed below are for important fasteners.

ENGINE

Item	Qty	Thread dia.(mm)	Torque (kgf-m)	Remarks
Cylinder head bolt A		6	0.7~1.1	
Cylinder head bolt B		6	0.7~1.1	
Oil filter screen cap		30	2.0~3.0	
O2 sensor		12	0.7~1.1	
Cylinder head cover		6	0.8~0.9	
Tappet adjusting hole cap		30	1.0~2.0	
Cam chain set plate		6	1.0~1.4	
Engine oil drain bolt		12	2.0~3.0	
Clutch outer nut		12	5.0~6.0	
Clutch drive plate nut		28	5.0~6.0	
Starter motor mounting bolt		6	0.8~1.2	
Oil pump bolt		6	0.7~1.1	
Drive face nut		12	5.5~6.5	
Spark plug		10	1.0~1.4	
A.C. Generator flywheel		12	5.0~6.0	
Cam chain tensioner pivot		6	0.8~1.2	

FRAME

Item	Qty	Thread dia.(mm)	Torque (kgf-m)	Remarks
Steering stem lock nut		Bc1	6.0~6.5	
Front axle		14	1.5~2.5	U - nut
Rear axle nut		16	11~13	U - nut
Rear shock absorber upper bolt		10	3.5~4.5	
Rear shock absorber lower bolt		10	3.5~4.5	
Muffler exh. Pipe		8	1.8~2.0	

1. GENERAL INFORMATION

SPECIAL TOOLS

Tool Name	Tool No.	Illustration (Note: the special tools may differ slightly from those shown in the figure of this manual.)
Flywheel puller (Refer to the “ STARTER CLUTCH ” section in the chapter 10.)	A120E00003	
Oil seal and bearing installer	A120E00014	
Universal holder (Refer to the “ DRIVE PULLEY, DRIVE BELT AND DRIVEN PULLEY ” section in the chapter 8.)	A120E00017	
Flywheel holder (Refer to the “ STARTER CLUTCH ” section in the chapter 10.)	A120E00021	
Clutch spring compressor (Refer to the “ DRIVE PULLEY, DRIVE BELT AND DRIVEN PULLEY ” section in the chapter 8.)	A120E00034	
Valve adjuster (Refer to the “ VALVE CLEARANCE ” section in the chapter 3.)	A120E00036	

(Cont'd)

1. GENERAL INFORMATION

SPECIAL TOOLS

Tool Name	Tool No.	Illustration (Note: the special tools may differ slightly from those shown in the figure of this manual.)
Bearing puller	A120E00037	
Valve spring compressor (Refer to the “CYLINDER HEAD” section in the chapter 6.)	A120E00040	
Lock nut wrench (Refer to the “STEERING STEM” section in the chapter 15.)	A120F00023	
Lock nut wrench (Refer to the “STEERING STEM” section in the chapter 15.)	A120F00002	
Bottom Ball Race Remove special tool/ Top Ball Cone Race Remove special tool (Refer to the “STEERING STEM” section in the chapter 15.)	A120F00009	
Bottom Ball Race Install special tool Top Ball Cone Race Install special tool (Refer to the “STEERING STEM” section in the chapter 15.)	A120F00019	

1. GENERAL INFORMATION

LUBRICATION POINTS

ENGINE

Lubrication Points	Lubricant
Valve guide/valve stem movable part Cam lobes Valve rocker arm friction surface Cam chain Cylinder lock bolt and nut Piston surroundings and piston ring grooves Piston pin surroundings Cylinder inside wall Connecting rod/piston pin hole Connecting rod big end Crankshaft R/L side oil seal Starter reduction gear engaging part Countershaft gear engaging part Final gear engaging part Bearing movable part O-ring face Oil seal lip	<ul style="list-style-type: none"> • Genuine KYMCO Engine Oil (SAE15W-40) • API , SJ Engine Oil
Starter idle gear Friction spring movable part/shaft movable part Shaft movable grooved part	High-temperature resistant grease
A.C. generator connector Transmission case breather tube	Adhesive

2. EXHAUST MUFFLER/FRAME COVERS

2

EXHAUST MUFFLER/FRAME COVERS

SERVICE INFORMATION-----	2- 1
TROUBLESHOOTING-----	2- 1
FASTENER REMOVAL AND REINSTALLATION-----	2- 2
FRAME COVERS REMOVAL/INSTALLATION-----	2- 3
EXHAUST MUFFLER -----	2-14

2. EXHAUST MUFFLER/FRAME COVERS

SERVICE INFORMATION

GENERAL INSTRUCTIONS

- When removing frame covers, use care not to pull them by force because the cover joint claws may be damaged.
- Make sure to route cables and harnesses according to the Cable & Harness Routing.

TORQUE VALUES

Exhaust muffler pipe nuts	1.8~2.2 kgf-m
Exhaust muffler brake /RR Fork	3.2~3.8 kgf-m
RR/Engine case	3.0~4.0 kgf-m

TROUBLESHOOTING

Noisy exhaust muffler

- Damaged exhaust muffler
- Exhaust muffler joint air leaks

Lack of power

- Caved exhaust muffler
- Clogged exhaust muffler
- Exhaust muffler air leaks

2. EXHAUST MUFFLER/FRAME COVERS

FASTENER REMOVAL AND REINSTALLATION

REMOVAL

Depress the head of fastener center piece ①.
Pull out the fastener.

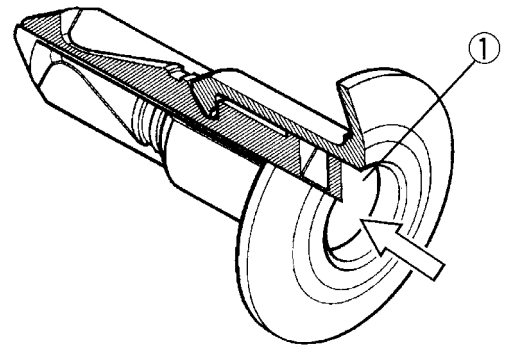

INSTALLATION

Let the center piece stick out toward the head so that the pawls ② close.
Insert the fastener into the installation hole.

To prevent the pawl ② from damage,
insert the fastener all the way into the
installation hole

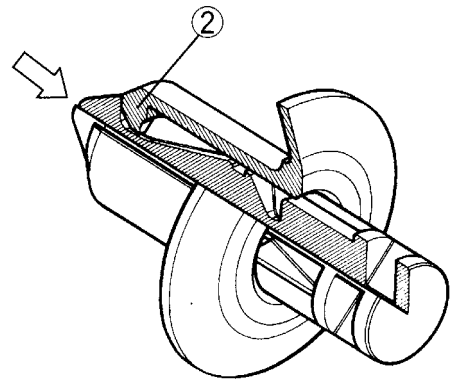

Push in the head of center piece until it
becomes flush with the fastener outside face.

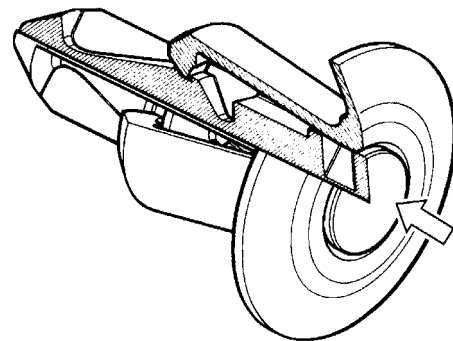

2. EXHAUST MUFFLER/FRAME COVERS

FRAME COVERS REMOVAL/ INSTALLATION

SEAT

Unlock the seat with the ignition key.
Open the seat.

Remove the two nuts and the seat.

Installation is in the reverse order of removal.



LUGGAGE BOX

Unlock the seat with the ignition key.
Open the seat.

Remove four bolts, and the fastener on the right side of luggage box, then lift luggage box.



Disconnect the luggage box light connector,
then remove the luggage box.

Installation is in the reverse order of removal.

Luggage Box Light Connector

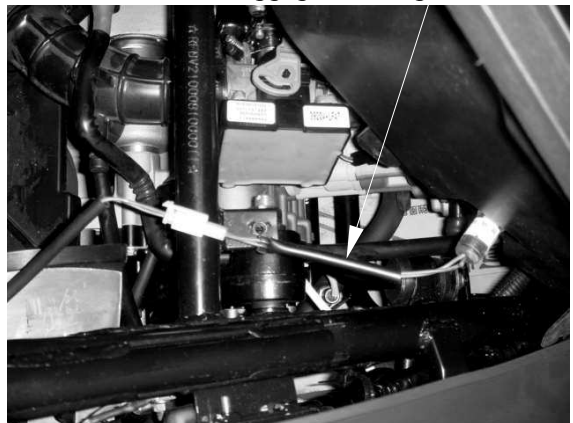

2. EXHAUST MUFFLER/FRAME COVERS

CENTER COVER

Remove the luggage box.

Remove the center cover.

During removal, do not pull the joint claws forcedly to avoid damage.

Installation is in the reverse order of removal.



Remove four bolts and , then remove the rear carrier.



2. EXHAUST MUFFLER/FRAME COVERS

Installation is in the reverse order of removal.



UPPER/LOWER HANDLEBAR COVER

Remove the four screws, then remove upper handlebar cover.



Remove the four screws, then remove the bottom handlebar cover.

Disconnect the throttle cable refer to the “**THROTTLE BODY /TPS**” section , then pull the throttle cable out from the lower cover. Remove the lower cover.



Installation is in the reverse order of removal.

2. EXHAUST MUFFLER/FRAME COVERS

WINDSHIELD/WINDSHIELD GARNISH

Remove five bolts and windshield garnish.



2. EXHAUST MUFFLER/FRAME COVERS

FRONT CENTER COVER

Remove the windshield

Remove four screws, then remove the front center cover.

Remove the front cover.

Installation is in the reverse order of removal.



FRONT COVER

Remove the small front cover(black) screw

Remove the small front cover(black)

Remove two nuts.

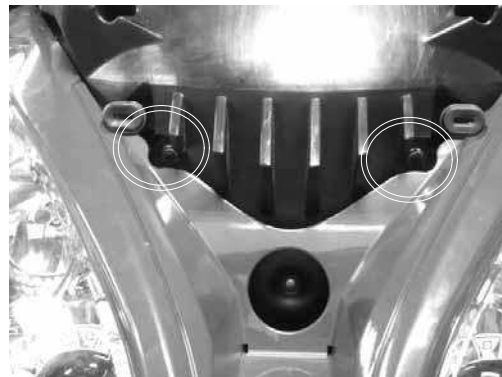

Remove eight screws from the inner cover.

Remove the front cover



2. EXHAUST MUFFLER/FRAME COVERS

Disconnect the headlight/position light connect and right/left turn signal light connectors.

Installation is in the reverse order of removal.



FRONT FENDER

Remove four screws.

screws and front fender.

Installation is in the reverse order of removal.



RIGHT/LEFT FOOT SKIRT

Remove the six screws attaching to the right or left skirt.

During removal, do not pull the joint claws forcedly to avoid damage.

Installation is in the reverse order of removal.

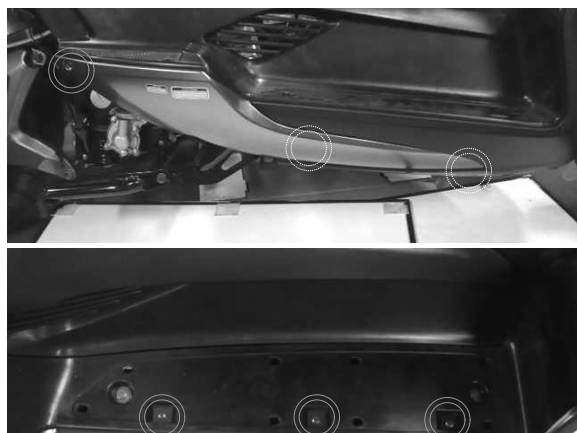

2. EXHAUST MUFFLER/FRAME COVERS

FRONT LOWER COVER

Remove the front cover
Remove the foot skirt

Remove seven screws and front lower cover.

Installation is in the reverse order of removal.



REAR FENDER

Remove the body cover and then the rear fender .

Installation is in the reverse order of removal.

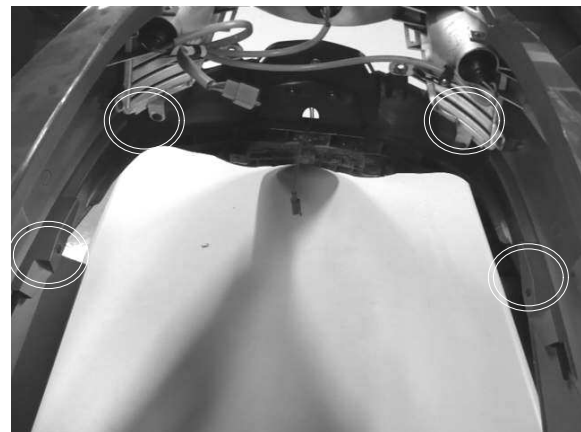

BODY COVER

Remove the rear center cover.
Remove the right and left foot skirts

Remove the rear carrier.

Remove six screws and two nuts then
remove the body cover.



2. EXHAUST MUFFLER/FRAME COVERS

Disconnect the taillight connector.

Installation is in the reverse order of removal.

Taillight Connector



TIRE FENDER

Remove the body cover .

Remove four bolts attaching to the tire fender

Installation is in the reverse order of removal.



FLOORBOARD

Remove the body cover

Remove the right /left skirt

Remove two screws.



2. EXHAUST MUFFLER/FRAME COVERS

Remove eight bolts, then remove the floorboard.

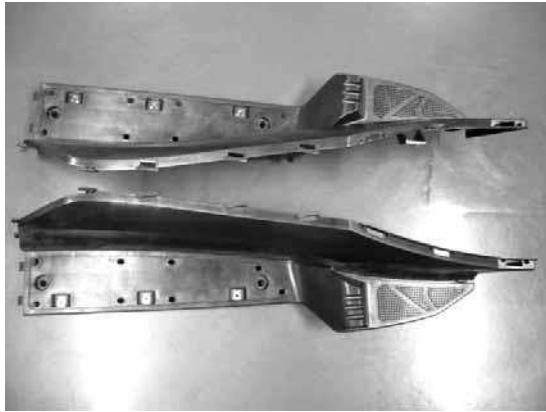

UNDER COVER

Remove four bolts
Remove the under cover.



2. EXHAUST MUFFLER/FRAME COVERS

Remove the fuel tank cap cover.

Installation is in the reverse order of removal.

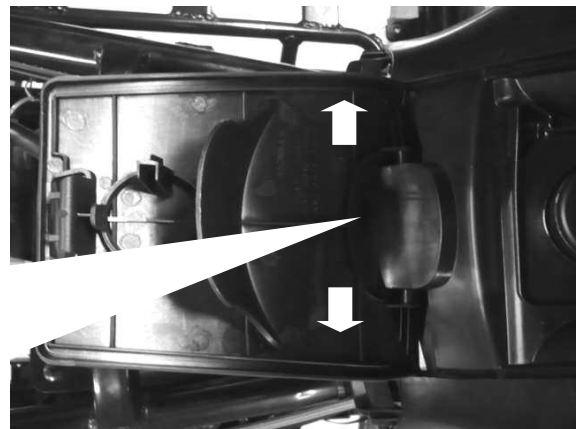

METER PANEL

Disconnect the speedometer wires.
Disconnect the DC power connectors.

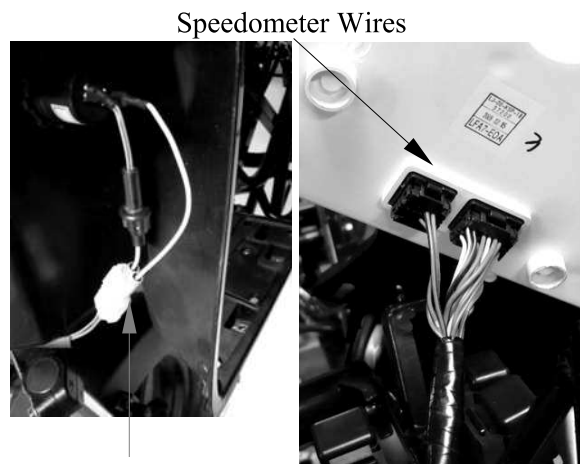

Speedometer Wires

DC power Connectors

Remove one screws
Remove the ignition key garnish
Remove three screws from the inner cover,
then remove the handler panel.

Installation is in the reverse order of removal.



2. EXHAUST MUFFLER/FRAME COVERS

INNER COVER

Remove the front cover .
Remove the front lower cover .
Remove the floorboard

Remove four bolts and front glove box one screw.

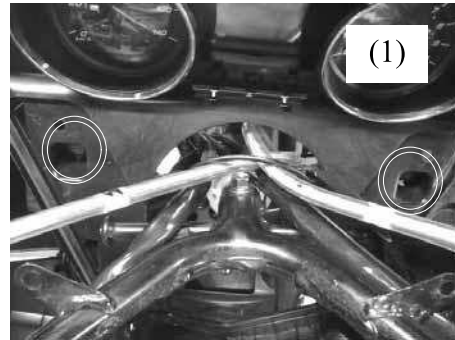

Remove two fastener bolts then remove the fuel tank fill cap.
Remove the inner cover

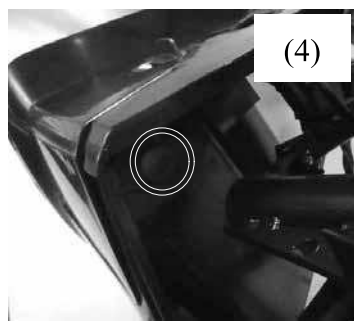
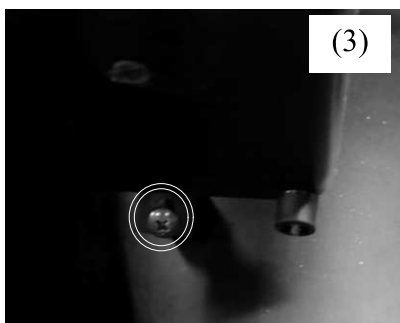
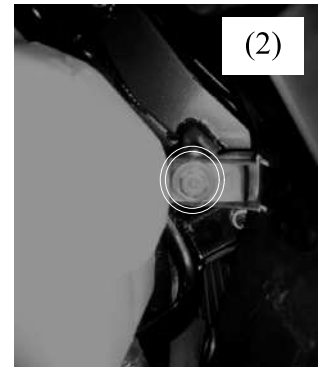

2. EXHAUST MUFFLER/FRAME COVERS

EXHAUST MUFFLER

REMOVAL

Disconnect the O2 heater/O2 sensor connector .

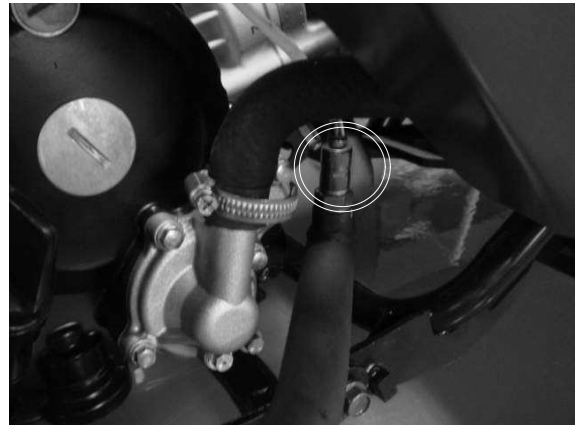

Remove the two exhaust pipe joint nuts



Remove three muffler mount bolts and muffler and gasket.



2. EXHAUST MUFFLER/FRAME COVERS

INSTALLATION

Replace the gasket with a new one.
Install the exhaust muffler and three mounting bolt.

Install and tighten the two exhaust pipe joint nuts to the specified torque

Torque: 20 N•m (2 kgf•m,)

Tighten the three mounting bolts

Torque: 35 N•m (3.5 kgf•m,)

Remove the coolant tank cover.



Gasket

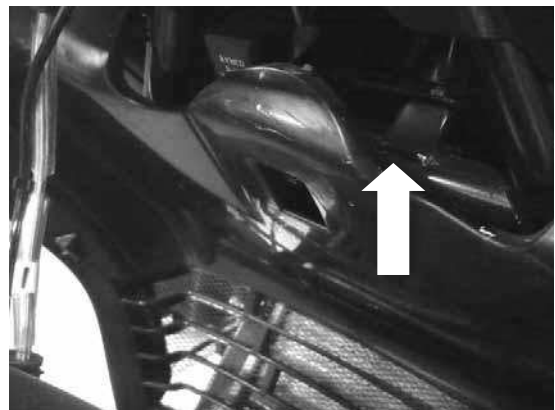

3. INSPECTION/ADJUSTMENT

INSPECTION/ADJUSTMENT

SERVICE INFORMATION-----	3- 1
MAINTENANCE SCHEDULE-----	3- 2
FUEL LINE-----	3- 4
THROTTLE OPERATION-----	3- 4
ENGINE OIL -----	3- 5
TRANSMISSION OIL -----	3-11
AIR CLEANER -----	3-12
SPARK PLUG-----	3-13
VALVE CLEARANCE -----	3-14
IDLE SPEED -----	3-15
CYLINDER COMPRESSION -----	3-16
DRIVE BELT -----	3-16
CLUTCH SHOE WEAR-----	3-17
HEADLIGHT AIM -----	3-17
COOLANT -----	3-18
BRAKE FLUID -----	3-19
BRAKE PAD WEAR -----	3-19
NUTS/BOLTS/FASTENERS -----	3-20
WHEELS/TIRES -----	3-20
SUSPENSION-----	3-21
SIDE STAND -----	3-22

3. INSPECTION/ADJUSTMENT

SERVICE INFORMATION

GENERAL

⚠ WARNING

- Before running the engine, make sure that the working area is well-ventilated. Never run the engine in a closed area. The exhaust contains poisonous carbon monoxide gas which may cause death to people.
- Gasoline is extremely flammable and is explosive under some conditions. The working area must be well-ventilated and do not smoke or allow flames or sparks near the working area or fuel storage area.

SPECIFICATIONS

Throttle grip free play : 2~6 mm

Spark plug :
: DOWNTOWN125 i: NGK CR7E

Spark plug gap : 0.6~0.7 mm

Valve clearance : IN: 0.1 mm EX: 0.1 mm

Idle speed : 1850 rpm

Cylinder compression : 15 kg/cm²

Engine oil capacity:

At disassembly : 1.2L

At change : 1.0L

Gear oil capacity :

At disassembly : 0.13L

At change : 0.12L

Coolant capacity :

Reserve tank capacity: 0.49 liter

Radiator capacity : 0.87 liter

Ignition timing : ECU control

TIRE

	1 Rider (75 kg)	2 Riders (150 kg)
Front	2.0 kgf/cm ²	2.00 kgf/cm ²
Rear	2.25 kgf/cm ²	2.25 kgf/cm ²

TIRE SPECIFICATION:

Front :120/80-14

Rear : 150/70-13

3. INSPECTION/ADJUSTMENT

TORQUE VALUES

Front axle : 2.0 kgf-m

Rear axle nut : 12 kgf-m

MAINTENANCE SCHEDULE

Perform the pre-ride inspection at each scheduled maintenance period.

This interval should be judged by odometer reading or months, whichever comes first.

I: INSPECT AND CLEAN, ADJUST, LUBRICATE OR REPLACE IF NECESSARY

C: CLEAN R: REPLACE A: ADJUST L: LUBRICATE

The following maintenance schedule specifies all maintenance required to keep your scooter in peak operating condition. Maintenance work should be performed in accordance with standards and specifications of KYMCO by properly trained and equipped technicians. Your KYMCO dealer meets all of these requirements.

- * Should be serviced by your KYMCO dealer, unless the owner has the proper tools and service data and is mechanically qualified.
- * * In the interest of safety, we recommend these items be serviced only by your KYMCO dealer. KYMCO recommends that your KYMCO dealer should road test your scooter after each periodic maintenance is carried out.

3. INSPECTION/ADJUSTMENT

MAINTENANCE SCHEDULE

ITEM	FREQUENCY	WHICHEVER COMES FIRST	ODOMETER READING								REFER TO PAGE
			X 1000 km	1	5	10	15	20	25	30	
			X 1000 mi	0.6	3	6	9	12	15	18	
		NOTE	MONTH	1	6	12	18	24	30	36	
AIR CLEANER					R	R	R	R	R	R	
SPARK PLUGS					I	R	I	R	I	R	
THROTTLE OPERATION					I	I	I	I	I	I	
VALVE CLEARANCE					I	A	I	A	I	A	
FUEL LINE						I		I		I	
CRANKCASE BREATHER				C	C	C	C	C	C	C	
ENGINE OIL				R	R	R	R	R	R	R	
ENGINE OIL FILTER						R	C	R	C	R	
ENGINE IDLE SPEED						I		I		I	
TRANSMISSION OIL				R	R	R	R	R	R	R	
DRIVE BELT					I	I	I	I	I	I	
OIL STRAINER SCREEN				C	C	C	C	C	C	C	

ITEM	FREQUENCY	WHICHEVER COMES FIRST	ODOMETER READING [NOTE (1)]								REFER TO PAGE
			X 1000 km	1	5	10	15	20	25	30	
			X 1000 mi	0.6	3	6	9	12	15	18	
		NOTE	MONTH	1	6	12	18	24	30	36	
CLUTCH SHOE WEAR						I		I		I	
BRAKE FLUID					I	R	I	R	I	R	
BRAKE PAD WEAR					I	I	I	I	I	I	
BRAKE SYSTEM					I	I	I	I	I	I	
BRAKE LIGHT SWITCH					I	I	I	I	I	I	
STEERING BEARINGS					I	I	I	I	I	I	
HEADLIGHT AIM					I	I	I	I	I	I	
NUTS, BOLTS, FASTENERS					I	I	I	I	I	I	
WHEELS/TIRES					I	I	I	I	I	I	

3. INSPECTION/ADJUSTMENT

FUEL LINE

Check the fuel lines and replace any parts which show signs of deterioration, damage or leakage.

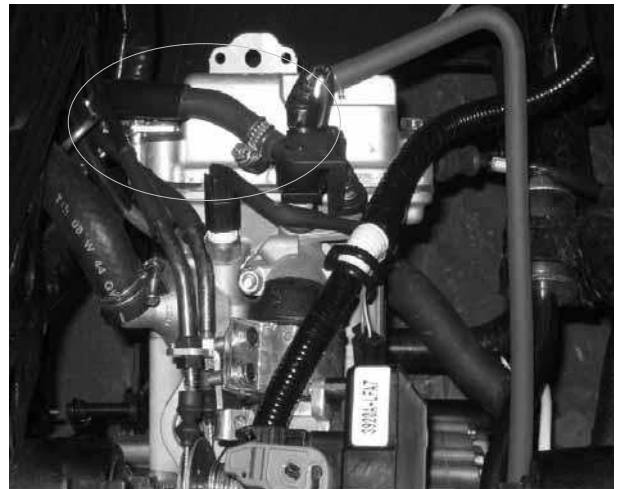

THROTTLE OPERATION

Check the throttle grip for smooth movement. Measure the throttle grip free play.

Free Play: 2~6 mm

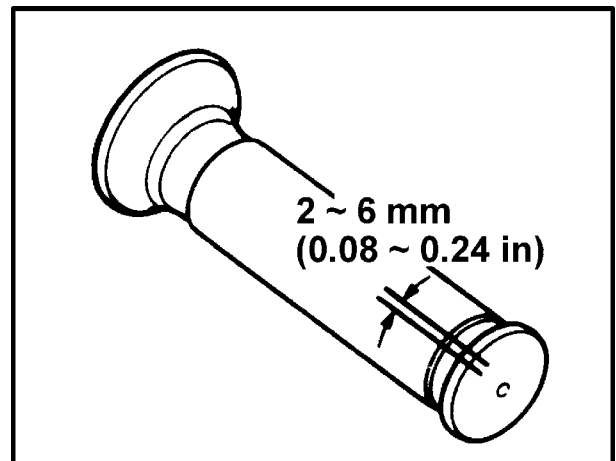

Major adjustment of the throttle grip free play is made with the adjusting nut at the throttle body side. Adjust by loosening the lock nut and turning the adjusting nut.



3. INSPECTION/ADJUSTMENT

Minor adjustment is made with the adjusting nut at the throttle grip side. Slide the rubber cover (1) out and adjust by loosening the lock nut (3) and turning the adjusting nut (2).

(Chart)

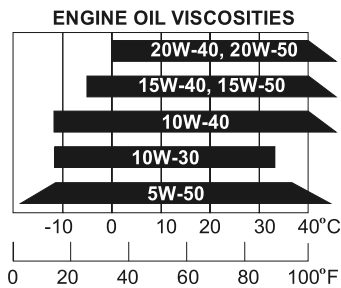

ENGINE OIL

Engine oil recommendation

Use a premium quality 4-stroke motor oil to ensure longer service life of your scooter. Use only oils which are rated, SJ under the API service classification. The recommended viscosity is SAE 15W-40. If a SAE 15W-40 motor oil is not available, select an alternative according to the chart.

Engine oil capacity:

At disassembly:
1.2 L

At change:
1.0 L

Engine oil level check

Check the engine oil level each day before riding the scooter.

The level must be maintained between the upper and lower level marks on the oil filler cap/dipstick.

1. Start the engine and let it idle for a few minutes.

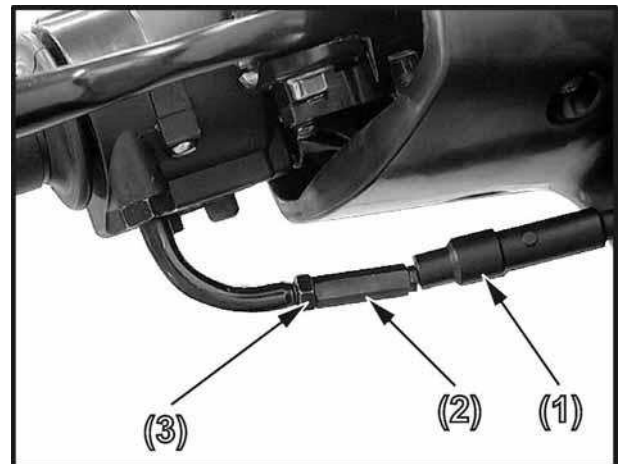

2. Stop the engine and put the scooter on its center stand on level ground.
3. After a few minutes, remove the oil filler cap/dipstick, wipe it clean, and reinsert the oil filler cap/dipstick without screwing it in. Remove the oil filler cap/dipstick. The oil level should be between the upper and lower marks on the oil filler cap/dipstick.
4. If required, add the specified oil up to the upper level mark. Do not overfill.
5. Reinstall the oil filler cap/dipstick. Check for oil leaks.

* Let the engine and exhaust system cool before working in those areas.



3. INSPECTION/ADJUSTMENT

Engine oil replacement

Engine oil quality is the chief factor affecting engine service life. Change the engine oil as specified in the maintenance schedule.

When running in very dusty conditions, oil changes should be performed more frequently than specified in the maintenance schedule.

Please dispose of used engine oil in a manner that is compatible with the environment. We suggest you take it in a sealed container to your local recycling center or service station for reclamation. Do not throw it in the trash or pour it on the ground or down a drain.

Used engine oil may cause skin cancer if repeatedly left in contact with the skin for prolonged periods. Although this is unlikely unless you handle used oil on a daily basis, it is still advisable to thoroughly wash your hands with soap and water as soon as possible after handling used oil.

Change the engine oil with the engine at normal operating temperature and the scooter on its center stand to assure complete and rapid draining.

3. INSPECTION/ADJUSTMENT

1. Remove the oil filler cap/dipstick(1) from the right crankcase cover.
2. Place a container under the left crankcase.
3. Remove the oil drain plug (2) to drain the oil.
4. Reinstall the drain plug and tighten the drain plug to specification.

Oil drain plug torque:

25 N-m (2.5 kgf-m,)

5. Fill the crankcase with the recommended grade oil and install the oil filler cap.

Oil capacity (after draining):

1.0 L

6. Start the engine and let it idle for 2 – 3 minutes.
7. Stop the engine and check that the oil level is at the upper level mark on the oil filler cap/dipstick with the scooter upright on firm, level ground. Make sure there are no oil leaks.

* Let the engine and exhaust system cool before working in those areas.



(1)



(2)

3. INSPECTION/ADJUSTMENT

Oil strainer screen clean

Change the engine oil with the engine at normal operating temperature and the scooter on its center stand to assure complete and rapid draining.

* Let the engine and exhaust system cool before working in those areas.

1. Remove the oil filler cap/dipstick (1) from the right crankcase cover.
2. Place a drain pan under the crankcase and remove the oil strainer screen cap (2). The spring (3) and oil strainer screen (4) will come out when the drain plug is removed.

Let the engine oil drain out.

3. Clean the oil strainer screen.
4. Check that the oil strainer screen, sealing rubber and drain plug O-ring are in good condition.
5. Install the oil strainer screen, spring and oil strainer screen cap.

Oil strainer screen cap torque:

15N-m (1.5 kgf-m)

6. Fill the crankcase with the recommended grade oil and install the oil strainer screen cap.

Oil capacity (after draining):

1.0 L

7. Start the engine and let it idle for 2–3 minutes.
8. Stop the engine and check that the oil level is at the upper level mark on the oil filler cap/dipstick with the scooter upright on firm, level ground. Make sure there are no oil leaks.



(1)

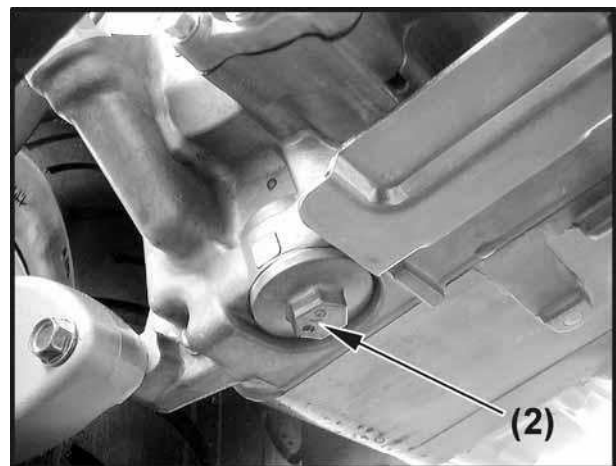

(2)

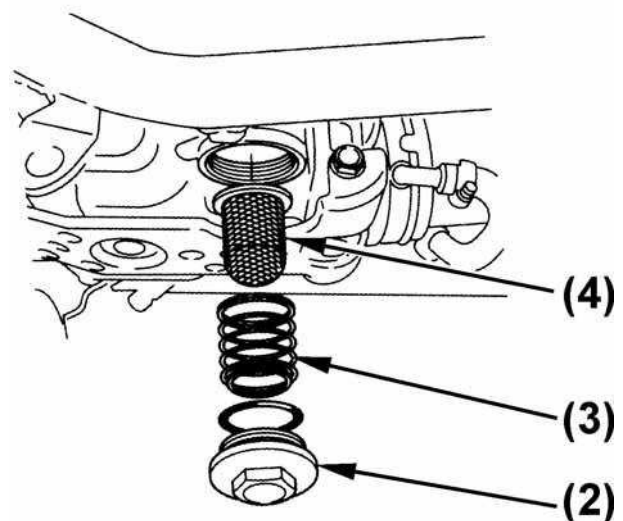

(4)

(3)

(2)

3. INSPECTION/ADJUSTMENT

Oil filter replacement

Change the engine oil with the engine at normal operating temperature and the scooter on its center stand to assure complete and rapid draining.

* Let the engine and exhaust system cool before working in those areas.

1. Remove the oil filler cap/dipstick (1) from the right crankcase cover.



(1)

2. Place a drain pan under the crankcase. Remove three bolts and then remove the oil filter cap (2) and O-ring (3). The spring (4) will come out when the filter cap is removed. Let the engine oil drain out.

3. Remove and discard the oil filter (5).

* Do not remain the rubber seal on the oil filter in the oil filter housing.



(2)

4. Check that the O-ring is in good condition.

3. INSPECTION/ADJUSTMENT

5. Install the new oil filter.

* Make sure the rubber seal on the oil filter facing the left crankcase.

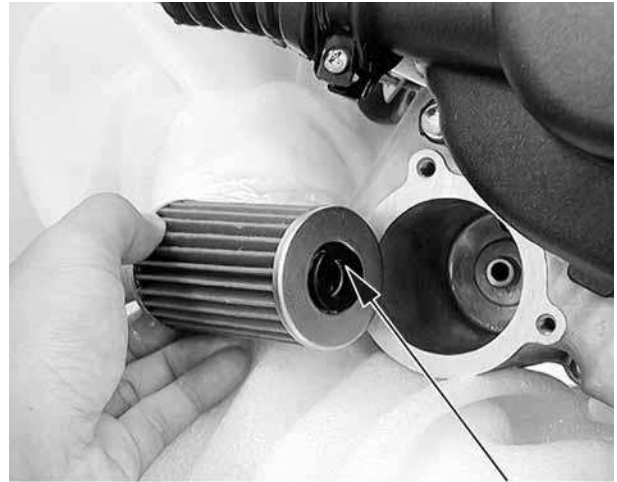

Rubber Seal

6. Install the spring, O-ring and cap.

Torque:

12 N-m (1.2 kgf-m)

7. Fill the crankcase with the recommended grade oil and install the oil filler cap.

Oil capacity (after draining):

1.0 L

8. Start the engine and let it idle for 2–3 minutes.

9. Stop the engine and check that the oil level is at the upper level mark on the oil filler cap/dipstick with the scooter upright on firm, level ground. Make sure there are no oil leaks.

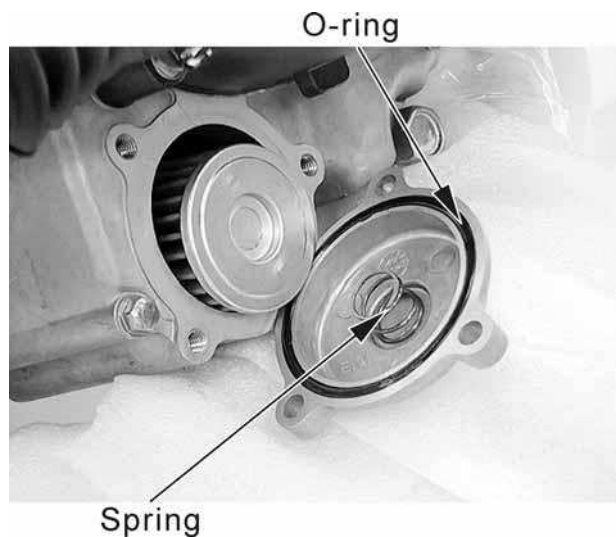

O-ring

Spring

3. INSPECTION/ADJUSTMENT

TRANSMISSION OIL

Oil change

1. Place the scooter in its center stand.
2. Place a drain pan under the drain bolt (1).
3. Remove the transmission oil drain bolt.
4. Remove the transmission oil filler bolt (2), slowly turn the rear wheel and drain the oil.
After draining the oil completely, install the oil drain bolt with a new sealing washer and tighten it.



(1)

Torque: 13 N-m (1.3 kgf-m)

5. Fill the transmission case with recommended oil.

Recommended transmission oil: SAE 90

Oil capacity (at draining):

0.12 L

6. Install the transmission oil filler bolt with a new sealing washer and tighten it.



(2)

Torque: 13 N-m (1.3 kgf-m)

3. INSPECTION/ADJUSTMENT

AIR CLEANER

The air cleaner should be serviced at regular intervals. Service more frequently when riding in unusually wet or dusty areas.

Air cleaner element replacement

1. Remove the screws from the air cleaner cover , then remove air cleaner cover.
2. Remove screws from the air cleaner element , then remove and discard this air cleaner element.
3. (This step is implied by the reverse order of removal mentioned in step 4.)
4. The new air cleaner element installation is in the reverse order of removal.

Use the KYMCO genuine air cleaner element or an equivalent air cleaner element specified for your model. Using the wrong KYMCO air cleaner element or a non-KYMCO air cleaner element which is not of equivalent quality may cause premature engine wear or performance problems.



3. INSPECTION/ADJUSTMENT

SPARK PLUG

Remove the spark plug cap and spark plug
Check the spark plug for wear and fouling deposits.
Clean any fouling deposits with a spark plug cleaner or a wire brush.



Specified Spark Plug:
NGK CR7E

Measure the spark plug gap.
Spark Plug Gap: 0.6~0.7 mm

* plug by hand and then tighten it with a spark plug wrench. k

Torque: 0.9 kgf-m (9 N-m)

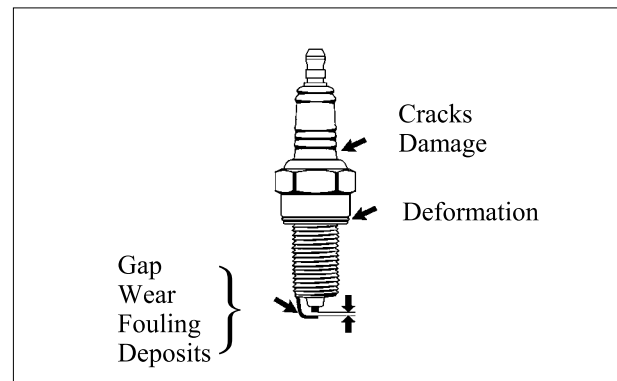

3. INSPECTION/ADJUSTMENT

VALVE CLEARANCE

- * • Inspect and adjust valve clearance while the engine is cold (below 35°C).

Remove the four bolts , then remove cylinder head cover.



Timing hole cap

Remove the timing hole cap and O-ring
Remove the crankshaft hole cap and O-ring .



Crankshaft hole cap

Turn the A.C. generator flywheel to the top dead center (TDC) on the compression stroke so that the “T” mark on the flywheel aligns with the index mark on the left crankcase cover.

The punch mark on the camshaft should face upward as shown.

If the punch mark on the camshaft are facing downward, turn the crankshaft one full turn (180°) and the punch mark are facing upward.

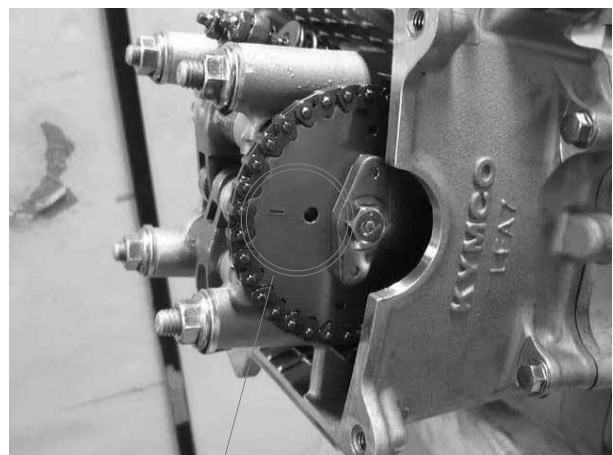

Punch Mark

3. INSPECTION/ADJUSTMENT

Adjust by loosening the valve adjusting screw lock-nut and turning the adjusting screw until there is a slight drag on the thickness gauge .

Valve Clearance: IN: 0.1 mm
EX:0.1 mm

Apply oil to the valve adjusting screw lock-nut threads and seating surface.

Hold the adjusting screw and tighten the lock nut to the specified torque.

Torque: 0.9 kgf-m (9 N-m)

Special tool:

Valve adjuster A120E00036

After tightening the lock-nut, recheck the valve clearance.

Install the removed parts in the reverse order of removal.

IDLE SPEED

*

- It is not necessary to adjust idle speed for **DOWNTOWN125i**. The throttle body is factory preset originally, do not loosen or tighten the painted bolts and screws of throttle body. Loosening or tightening them can cause throttle a idle and valve with failure.

Idle Speed:

DOWNTOWN125i: 1850 rpm

3. INSPECTION/ADJUSTMENT

CYLINDER COMPRESSION

Warm up the engine before compression test.
Remove the center cover and spark plug cap.
Remove the spark plug .
Insert a compression gauge.
Open the throttle valve fully and push the starter button to test the compression.

Compression:

Downtown125i:15 kg/cm²

If the compression is low, check for the following:

- Leaky valves
- Valve clearance too small
- Leaking cylinder head gasket
- Worn pistons
- Worn piston/cylinder

If the compression is high, it indicates that carbon deposits have accumulated on the combustion chamber and the piston head.

DRIVE BELT

Remove the left crankcase cover.
Inspect the drive belt for cracks or excessive wear.
Replace the drive belt with a new one if necessary and in accordance with the Maintenance Schedule.

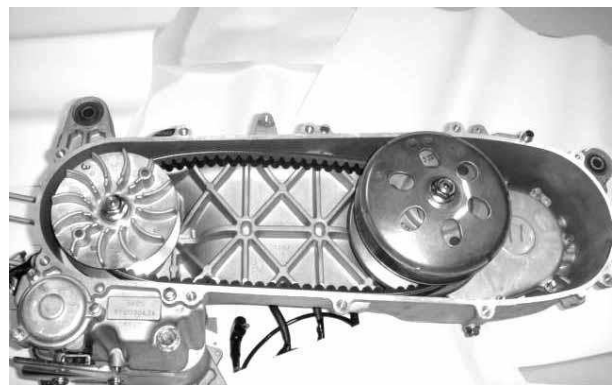

3. INSPECTION/ADJUSTMENT

CLUTCH SHOE WEAR

Start the engine and check the clutch operation by increasing the engine speed gradually.

If the scooter tends to creep, or the engine stalls, check the clutch shoes for wear and replace if necessary (refer to the “**DRIVE PULLEY, DRIVE BELT AND DRIVEN PULLEY**” section in the chapter 8).



HEADLIGHT AIM

Remove the front cover

Place the scooter on a level surface

Adjust the headlight beam adjuster.

A clockwise rotation moves the beam up and counterclockwise rotation moves the beam down.

Adjust the headlight beam horizontally by turning the horizontal beam adjuster.

A clockwise rotation moves the beam toward the right side of the rider.

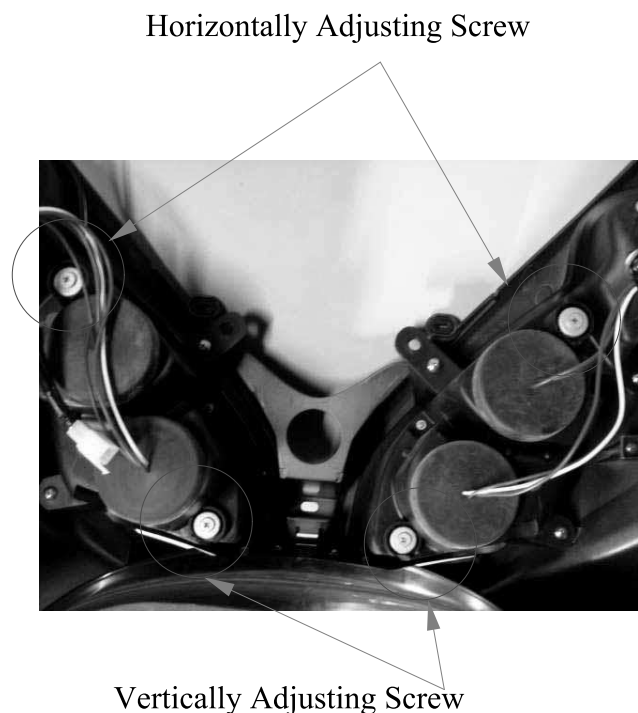

3. INSPECTION/ADJUSTMENT

COOLANT

Inspection

The reserve tank is under left foot board. Check the coolant level through the inspection window (1) at the front lower cover while the engine is at the normal operating temperature with the scooter in an upright position. If the coolant level is below the LOWER level mark (3), remove screw (4) and reserve tank lid (5) and reserve tank cap (6) and add coolant mixture until it reaches the upper level mark (2).

Always add coolant to the reserve tank. Do not attempt to add coolant by removing the radiator cap.

If the reserve tank is empty, or if coolant loss is excessive, check for leaks and see your KYMCO dealer for repair.

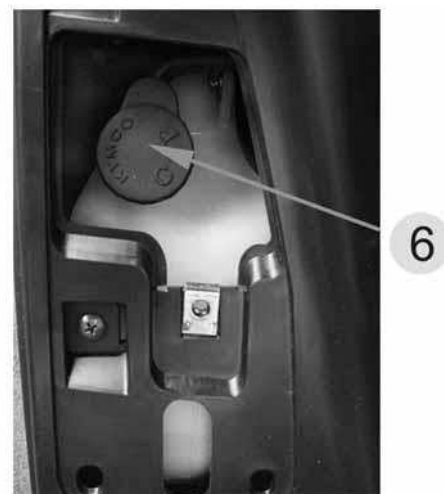
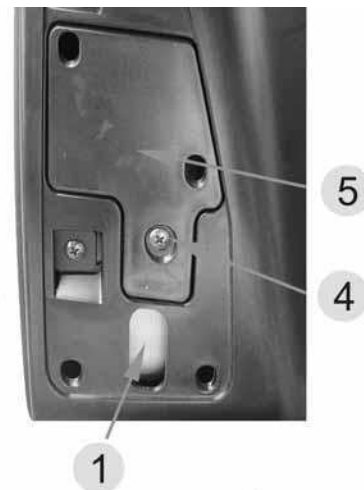

3. INSPECTION/ADJUSTMENT

BRAKE FLUID

Brake fluid level

With the scooter in an upright position, check the front and rear fluid level. It should be above the lower level mark. If the level is at or below the lower level mark "L", check the brake pads for wear.

Worn pads should be replaced. If the pads are not worn, have your brake system inspected for leaks.

The recommended brake fluid is **DOT 4** brake fluid from a sealed container, or an equivalent.

Other checks

Make sure there are no fluid leaks. Check for deterioration or cracks in the hoses and fittings.



Front brake

BRAKE PAD WEAR

Brake pad wear depends upon the severity of usage, the type of riding, and road conditions. (Generally, the pads will wear faster on wet and dirty roads.) Inspect the pads at each regular maintenance interval.

Front brake /Rear brake

Check the cutout in each pad.

If either pad is worn to the cutout, replace both pads as a set. See your KYMCO dealer for this service.



Rear brake



3. INSPECTION/ADJUSTMENT

NUTS/BOLTS/FASTENERS

Check all important chassis nuts and bolts for looseness.

Tighten them to their specified torque values if any looseness is found.

WHEELS/TIRES

Tire pressure

Insufficient air pressure in the tires not only hastens tire wear but also seriously affects the stability of the scooter. Under inflated tires make smooth cornering difficult and overinflated tires decrease the amount of tire in contact with the ground which can lead to skids and loss of control. Be sure that the tire pressure is within the specified limits at all times. Tire pressure should only be adjusted when the tires are cold.

Cold inflation tire pressure

	1 Rider (75 kg)	2 Riders (150 kg)
Front	2.0kg/cm ²	2.25 kg/cm ²
Rear	2.0kg/cm ²	2.25 kg/cm ²

3. INSPECTION/ADJUSTMENT

SUSPENSION

Check the action of the front/rear shock absorbers by compressing them several times. Check the entire shock absorber assembly for oil leaks, looseness or damage. Jack the rear wheel off the ground and move the rear wheel sideways with force to see if the engine hanger bushings are worn. Replace the engine hanger bushings if there is any looseness.



Rear suspension adjustment

Each shock absorber (1) has 5 adjustment positions for different load or riding conditions. Use a pin spanner (2) to adjust the rear shocks. Always adjust the shock absorber position in sequence (1-2-3-4-5 or 5-4-3-2-1). Attempting to adjust directly from 1 to 5 or 5 to 1 may damage the shock absorber. Position 1 is for light loads and smooth road conditions. Positions 3 to 5 increase spring preload for a stiffer rear suspension, and can be used when the scooter is heavily loaded. Be certain to adjust both shock absorbers to the same position.

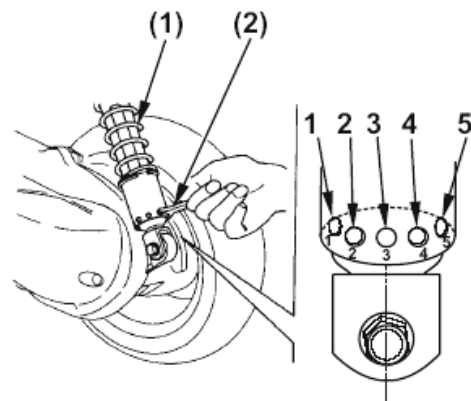

3. INSPECTION/ADJUSTMENT

SIDE STAND

Perform the following maintenance in accordance with the maintenance schedule.

Functional check

Check the spring for damage or loss of tension and the side stand assembly for freedom of movement.

Check the side stand ignition cut-off system:

1. Place the scooter on its center stand.
2. Put the side stand up and start the engine.
3. Lower the side stand. The engine should stop as you put the side stand down.

If the side stand system does not operate as described, see your KYMCO dealer for service.

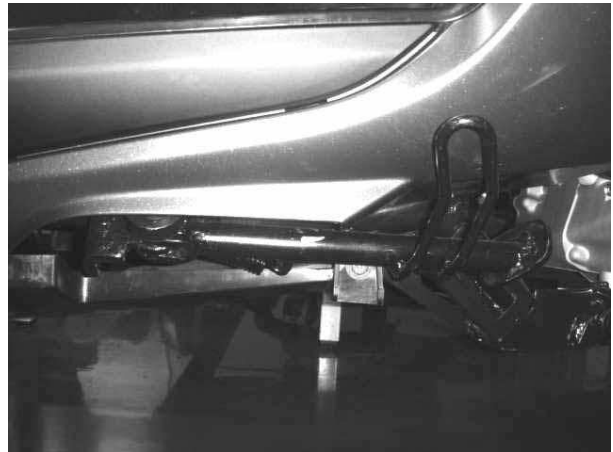

Side stand up



Side stand down

4. LUBRICATION SYSTEM



LUBRICATION SYSTEM

LUBRICATION SYSTEM DIAGRAM -----	4-1
SERVICE INFORMATION-----	4-2
TROUBLESHOOTING-----	4-2
OIL PUMP -----	4-3

4. LUBRICATION SYSTEM

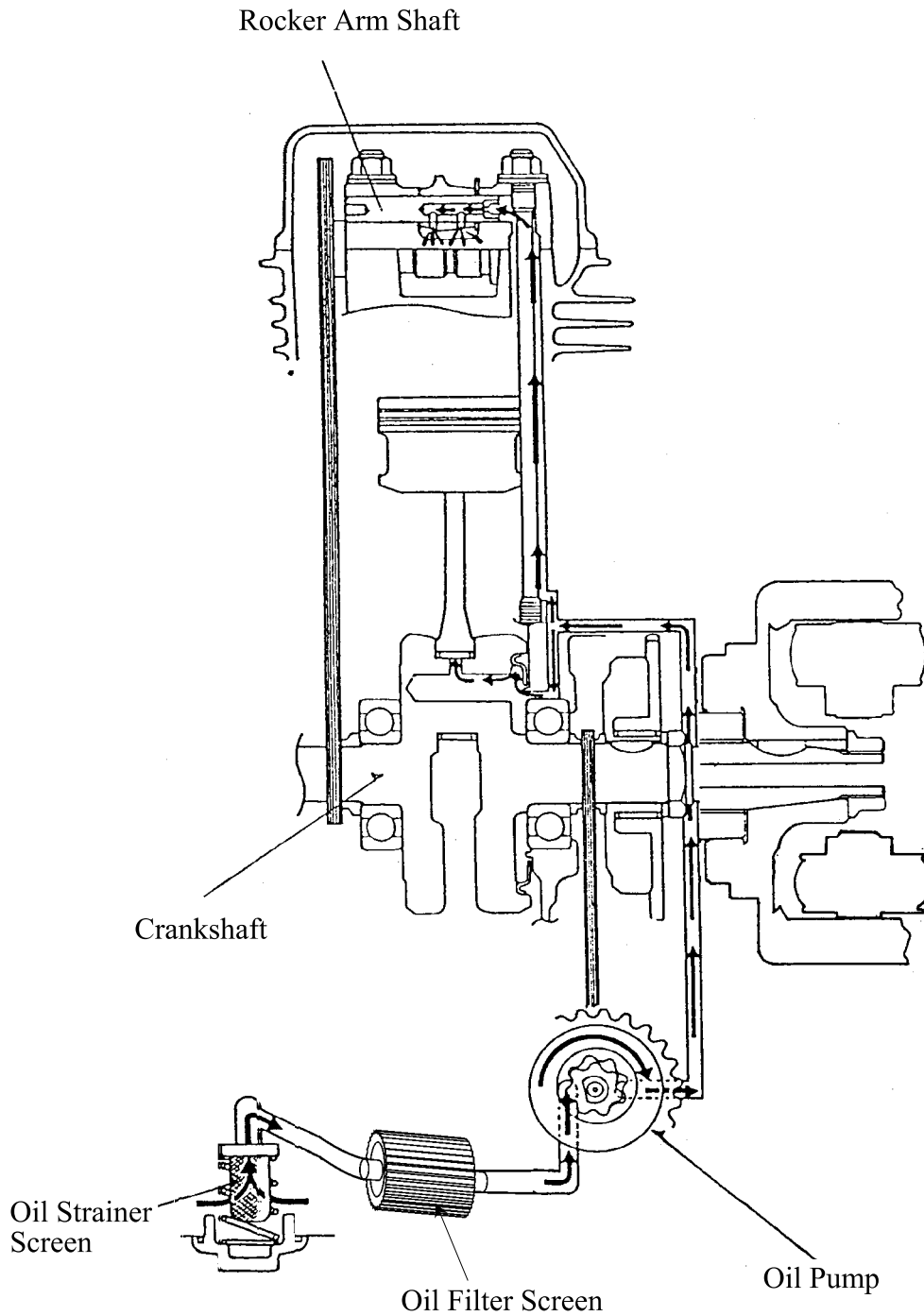

4. LUBRICATION SYSTEM

SERVICE INFORMATION

GENERAL INSTRUCTIONS

- The maintenance of lubrication system can be performed with the engine installed in the frame.
- Drain the coolant before starting any operations.
- Be careful when removing and installing the oil pump not to allow dust and foreign matters to enter the engine and oil line.
- Do not attempt to disassemble the oil pump. The oil pump must be replaced as a set when it reaches its service limit.
- After the oil pump is installed, check each part for oil leaks.

SPECIFICATIONS

Unit: mm

	Standard
Inner rotor-to-outer rotor clearance	0.15
Outer rotor-to-pump body clearance	0.15~0.2
Rotor end-to-pump body clearance	0.04~0.09

ENGINE OIL

Engine Oil Capacity	At disassembly:	1.2 liter
	At change:	1.0 liter
Recommended Oil	SAE15W40 API: SJ	

TROUBLESHOOTING

Oil level too low

- Natural oil consumption
- Oil leaks
- Worn piston rings
- Worn valve guide
- Worn valve guide seal

Poor lubrication pressure

- Oil level too low
- Clogged oil filter or oil passage
- Faulty oil pump

Oil contamination

- Oil not changed often enough
- Faulty cylinder head gasket
- Loose cylinder head bolts

4. LUBRICATION SYSTEM

OIL PUMP

REMOVAL

Remove the flywheel and driven gear (refer to the “**STARTER CLUTCH**” section in the chapter 10).

Remove the bolt and then oil separator cover.

* When removing and installing the oil pump, be careful not to allow dust or dirt to enter the engine.

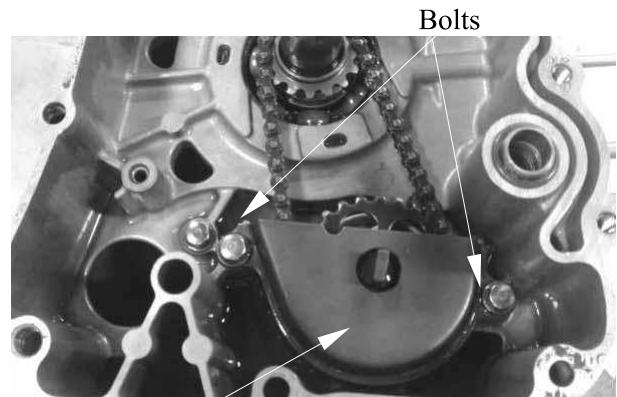

Oil Separator Cover

Pry the snap ring off and remove the oil pump driven gear, then remove the oil pump drive chain.

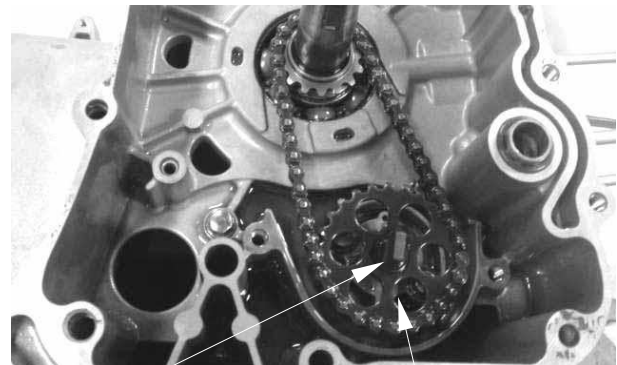

Snap Ring

Oil Pump Driven Gear

Remove the two oil separator bolts to remove the oil pump.

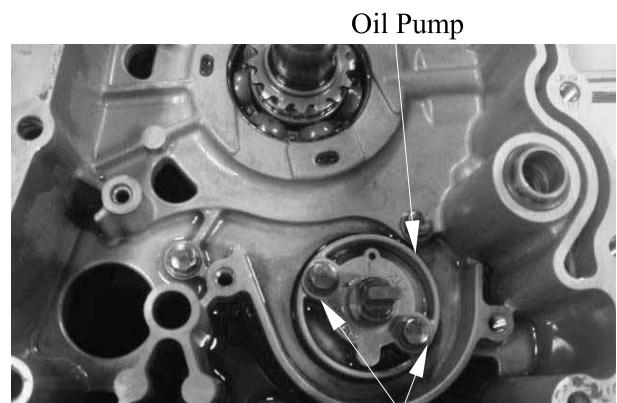

Oil Separator Bolt

4. LUBRICATION SYSTEM

INSTALLATION

Install the oil pump and oil separator and tighten the two bolts.
The arrow mark must be keep upward.

* Make sure the pump shaft rotates freely and arrow on the oil pump is upside.

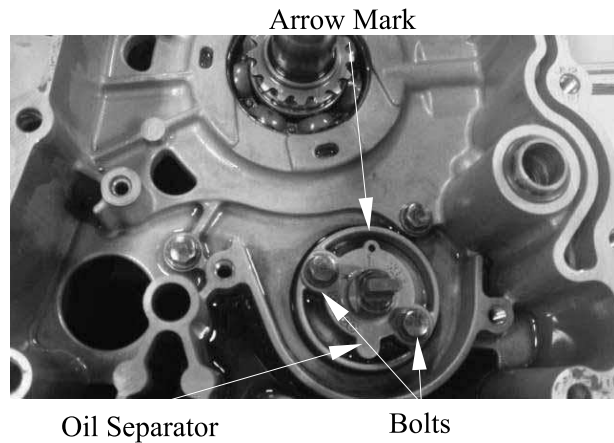

Install the pump drive chain and driven gear, then set the snap ring securely on the pump shaft.

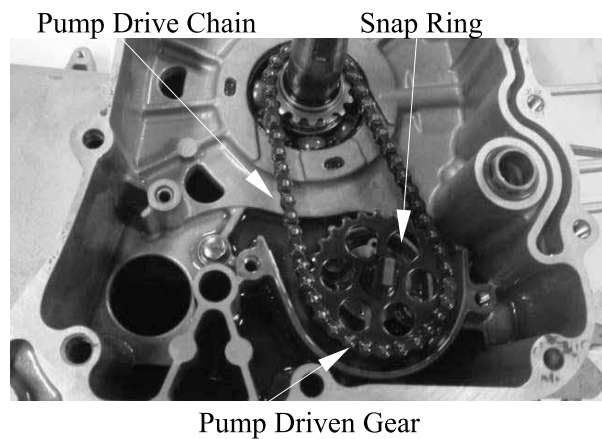

Install the oil separator cover properly.

* Fit the tab of the separator cover into the slit in the separator.



4. LUBRICATION SYSTEM

DISASSEMBLY

Remove the screw and disassemble the oil pump as shown.

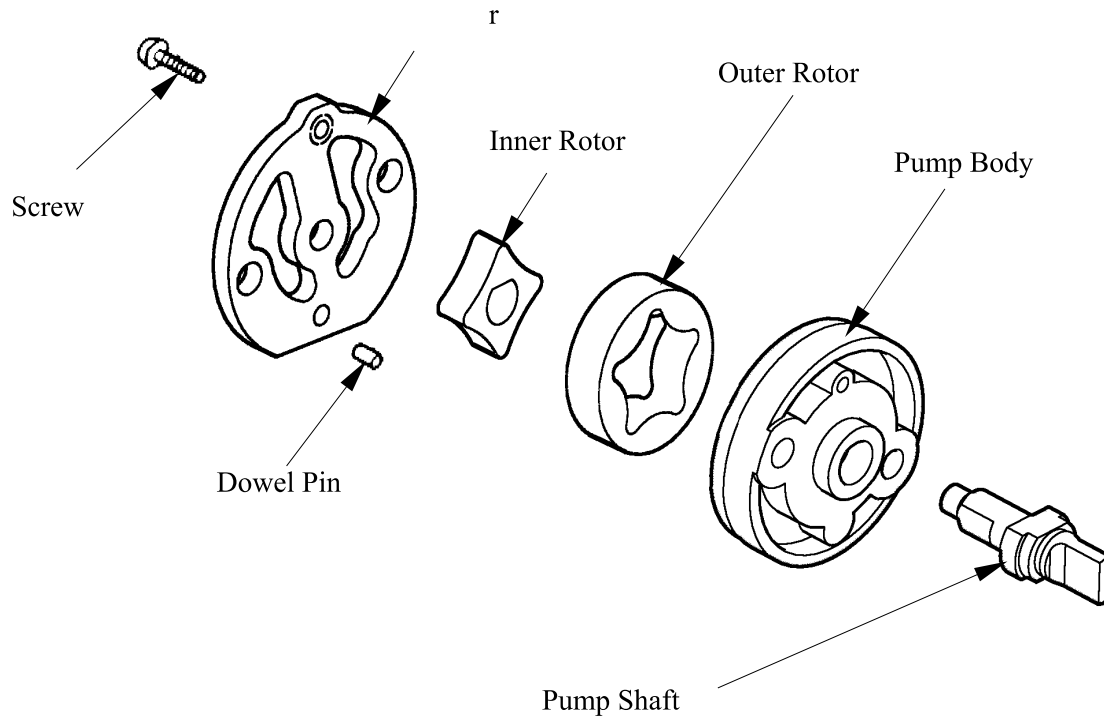

ASSEMBLY

Install the outer rotor, inner rotor and pump shaft into the pump body.

* Insert the pump shaft by aligning the flat on the shaft with the flat in the inner rotor. Install the dowel pin.

There is one punch mark on the surface of the inner rotor and outer rotor.

The mark is upside.

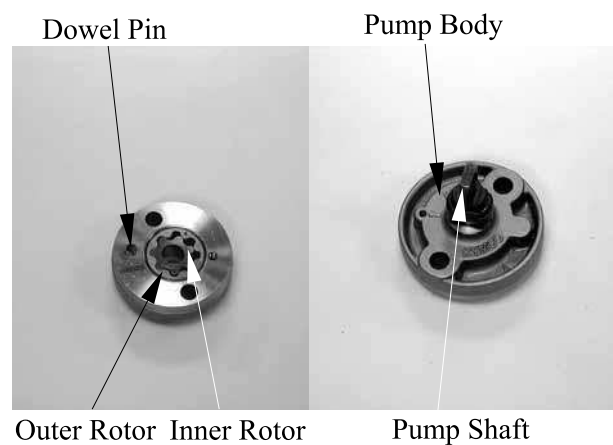

5. ENGINE REMOVAL/INSTALLATION

5

ENGINE REMOVAL/INSTALLATION

SERVICE INFORMATION-----	5-1
ENGINE REMOVAL/INSTALLATION-----	5-2
ENGINE HANGER -----	5-8

5. ENGINE REMOVAL/INSTALLATION

SERVICE INFORMATION

GENERAL INSTRUCTIONS

- A floor jack or other adjustable support is required to support and maneuver the engine. Be careful not to damage the scooter body, cables and wires during engine removal.
- Use shop towels to protect the scooter body during engine removal.
- Drain the coolant before removing the engine.
- After the engine is installed, fill the cooling system with coolant and be sure to bleed air from the water jacket. Start the engine to check for coolant leaks.
- Before removing the engine, the rear brake caliper must be removed first. Be careful not to bend or twist the brake fluid tube.

SPECIFICATIONS

Engine oil capacity: at disassembly: 1.2 L (1.27 US qt)
: at change: 1.0 L (1.06 US qt)

Coolant capacity:

Radiator capacity : 0.87 liter

Reserve tank capacity : 0.49 liter

TORQUE VALUES

Engine hanger (Engine side) 5 kgf-m (50 N-m)

Engine hanger (Frame side) 6.5 kgf-m (65 N-m)

5. ENGINE REMOVAL/INSTALLATION

ENGINE REMOVAL/INSTALLATION

REMOVAL

Remove the air cleaner
 Disconnect the ECU connector (A)
 Disconnect the O2 heater/O2 sensor connector
 Disconnect the throttle cable(B)

(A)

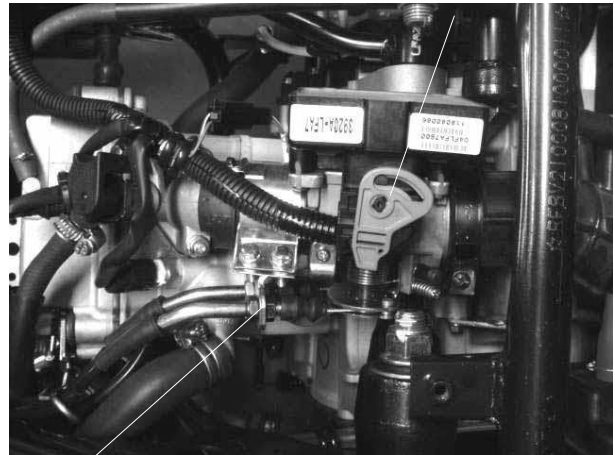

(B)

Remove a bolt from fuel hose guide (C).
 Disconnect the fuel hose (D) from fuel injector.
 Disconnect the WTS connector (E) from WTS.
 Disconnect the coolant temperature sensor connector (F) from coolant temperature sensor.
 Disconnect the fuel injector connector(G)
 Disconnect the output water hose(H)
 Disconnect the air bleed hose(I)

(G)

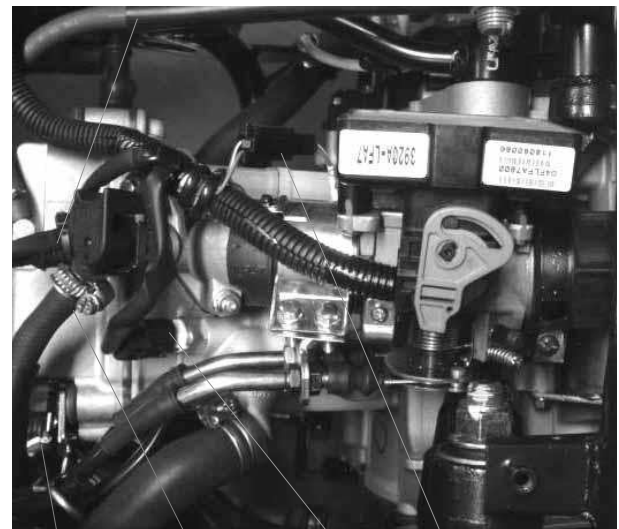

(C)

(D)

(E)

(F)

(I)



(H)

5. ENGINE REMOVAL/INSTALLATION

Loosen the rear axle nut.
Support the scooter securely on its main stand.

Remove three bolts (1) attaching to rear brake hose clamps.
Remove the two bolts (2), then remove the rear brake caliper.

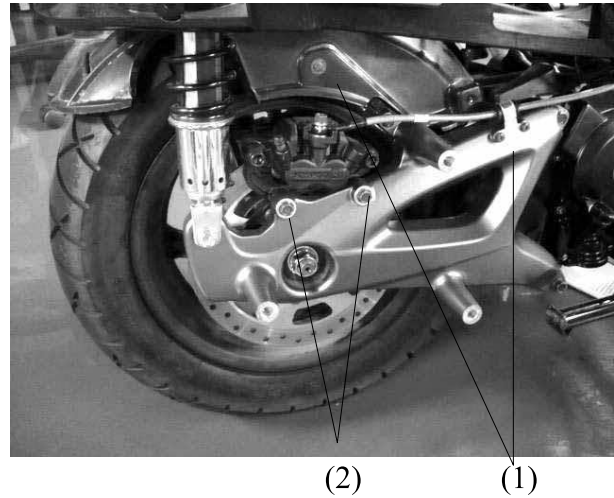

Disconnect the alternator connector (3).
Disconnect the ignition pulse generator connector (4).

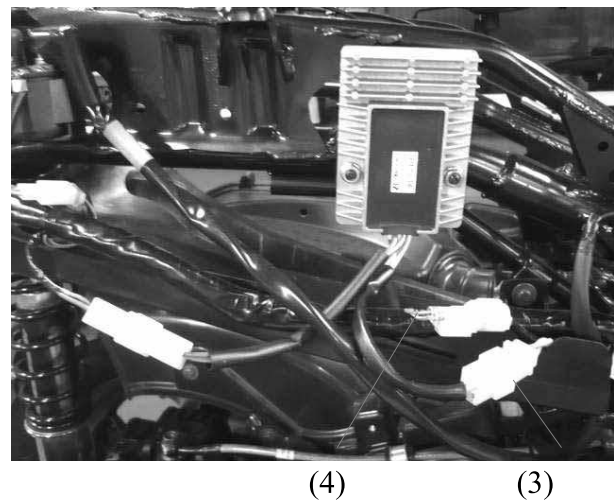

(5)

Release the rubber cap and remove the terminal screw (5) to disconnect the start motor cable from the start motor.



5. ENGINE REMOVAL/INSTALLATION

Remove the bolts and engine ground cable.

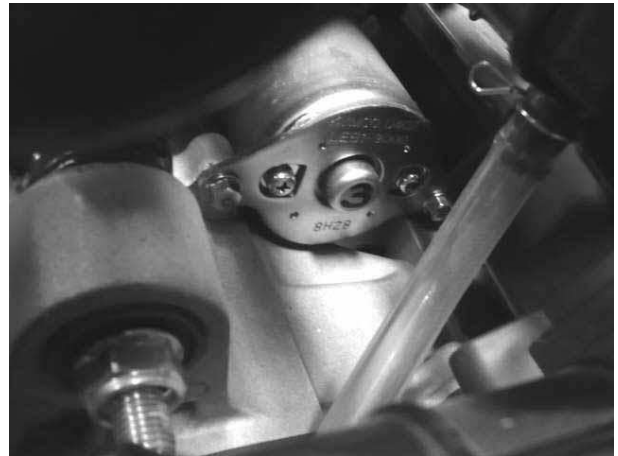

Remove the spark plug cap .

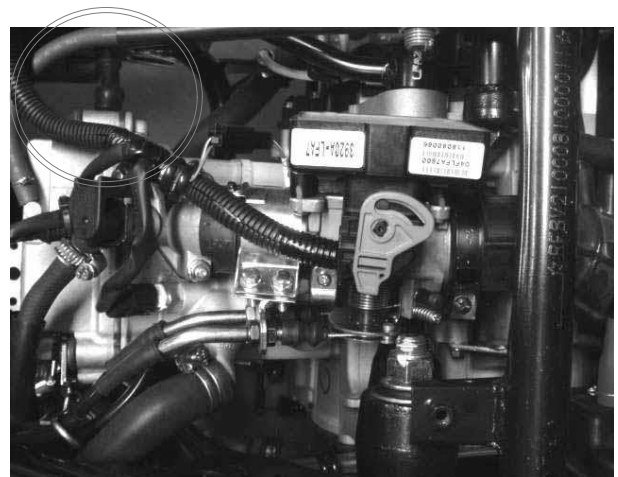

5. ENGINE REMOVAL/INSTALLATION

Disconnect the lower radiator hose from lower radiator pipe.

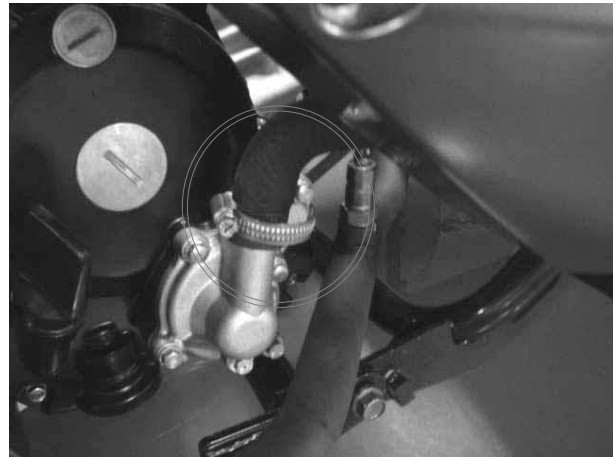

Remove the right and left rear shock absorber lower mount bolts .



5. ENGINE REMOVAL/INSTALLATION

Remove the engine mount nut
Pull out the engine mount bolt.



Remove the engine from the frame.

At removing the engine, be careful not to catch your hand or finger between the engine hanger and crankcase.

5. ENGINE REMOVAL/INSTALLATION

INSTALLATION

Installation is in the reverse order of removal.

Tighten the engine mounting bolt/nut to the specified torque.

Torque: 5 kgf-m (50 N-m)

Tighten the right and left rear shock absorber lower mount bolts to the specified torque.

Torque: 4.0kgf-m (40N-m)

Install the rear brake caliper and tighten the mount bolts to the specified torque.

Torque: 3.2 kgf-m (32 N-m, 23 lbf-ft)

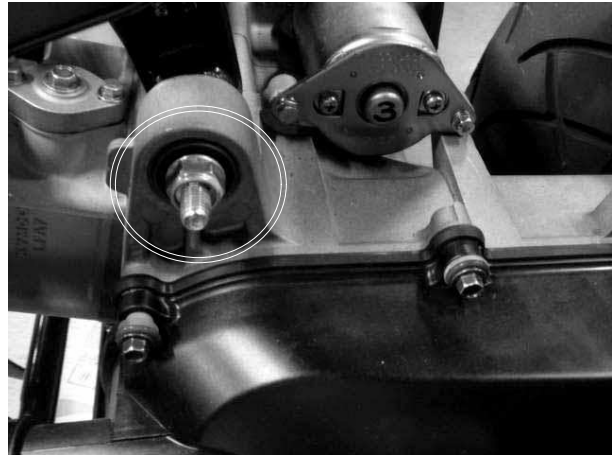

After installation, inspect and adjust the following:

- Throttle grip free play
- Fill the cooling system with coolant and start the engine to bleed air from the system.

API/ABV Reset(Refer to chapter14 page 17)

5. ENGINE REMOVAL/INSTALLATION

ENGINE HANGER

REMOVAL

Remove the engine mount nut .
Pull the engine mount bolt out.

Be careful to put the engine down.

Remove the left engine hanger mount bolt .
Remove the right engine hanger mount bolt
and collar .
Remove the engine from frame.



INSTALLATION

Installation is in the reverse order of removal.

Tighten the engine hanger mount bolts to the
specified torque.(engine side)

Torque: 5 kgf-m (50 N-m)

Tighten the engine mount bolt/nut to the
specified torque. (frame side)

Torque: 5 kgf-m (50 N-m, 36 lbf-ft)

6. CYLINDER HEAD/VALVES

CYLINDER HEAD/VALVES

6

SCHEMATIC DRAWING -----	6- 1
SERVICE INFORMATION-----	6- 2
TROUBLESHOOTING-----	6- 3
CYLINDER HEAD COVER-----	6- 4
CAMSHAFT HOLDER-----	6- 5
CAMSHAFT -----	6- 8
CYLINDER HEAD-----	6- 13

6. CYLINDER HEAD/VALVES

SCHEMATIC DRAWING

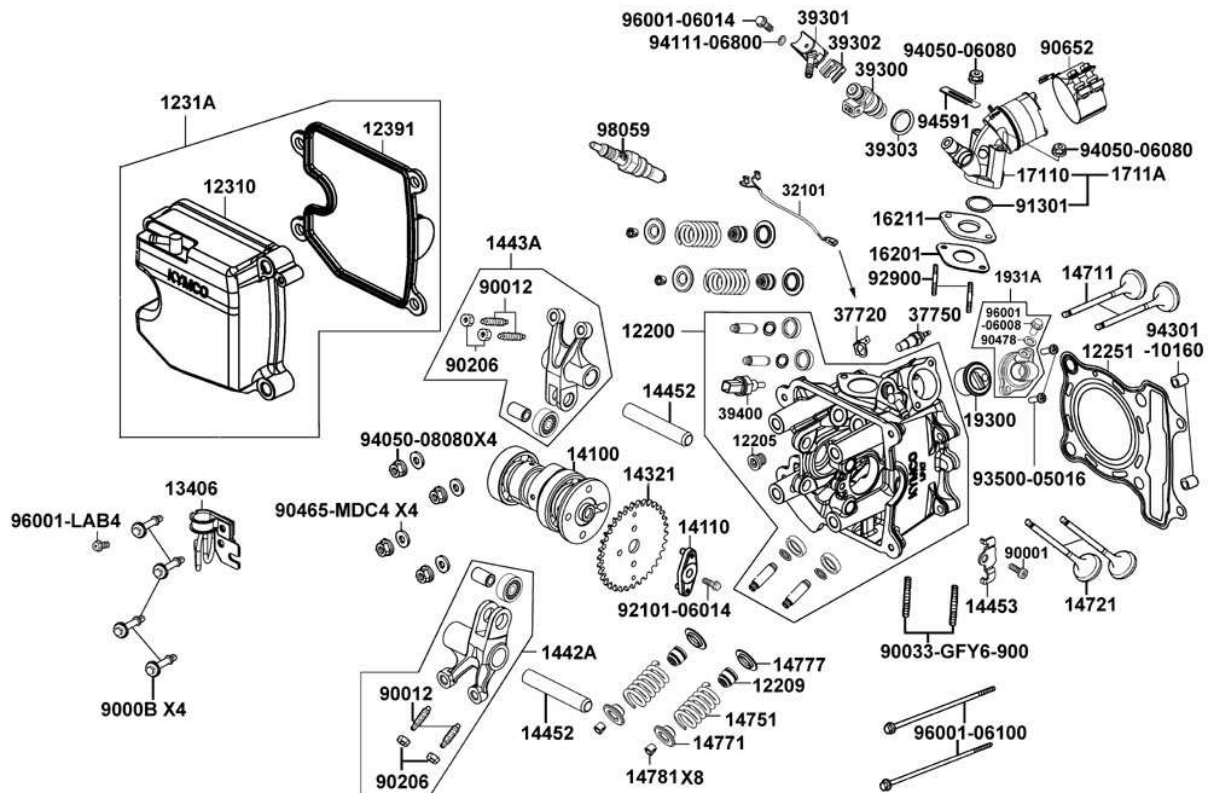

6. CYLINDER HEAD/VALVES

SERVICE INFORMATION

GENERAL INSTRUCTIONS

- The cylinder head can be serviced with the engine installed in the frame. Coolant in the radiator and water jacket must be drained first.
- When assembling, apply molybdenum disulfide grease or engine oil to the valve guide movable parts and valve arm sliding surfaces for initial lubrication.
- The valve rocker arms are lubricated by engine oil through the cylinder head engine oil passages. Clean and unclog the oil passages before assembling the cylinder head.
- After disassembly, clean the removed parts and dry them with compressed air before inspection.
- After removal, mark and arrange the removed parts in order. When assembling, install them in the reverse order of removal.

SPECIFICATIONS

Unit: mm

Item		Standard
Valve clearance (cold)	IN	0.1
	EX	0.1
Cylinder head compression pressure		15kg/cm ²
Cylinder head warpage		—
Camshaft cam height	IN	25.965
	EX	25.810
Valve rocker arm I.D.	IN	10.0~10.015
	EX	10.0~10.015
Valve rocker arm shaft O.D.	IN	9.972~9.987
	EX	9.972~9.987
Valve stem O.D.	IN	4.975~4.970
	EX	4.975~4.970
Valve guide I.D.	IN	5.0~5.012
	EX	5.0~5.012
Valve stem-to-guide clearance	IN	0.010~0.037
	EX	0.030~0.057

TORQUE VALUES

Cylinder head cover bolt	0.8~0.9 kgf-m
Tensioner mounting bolt	0.9 kgf-m
Tensioner sealing bolt	0.9 kgf-m

Cylinder head cap nut	2 kgf-m
Cylinder head bolt	0.7~1.1 kgf-m

Apply engine oil to threads

6. CYLINDER HEAD/VALVES

SPECIAL TOOLS

Valve spring compressor A120E00040

TROUBLESHOOTING

- The poor cylinder head operation can be diagnosed by a compression test or by tracing engine

Poor performance at idle speed

- Compression too low

Compression too low

- Incorrect valve clearance adjustment
- Burned or bend valves
- Incorrect valve timing
- Broken valve spring
- Poor valve and seat contact
- Leaking cylinder head gasket
- Warped or cracked cylinder head
- Poorly installed spark plug

Compression too high

- Excessive carbon build-up in combustion chamber

White smoke from exhaust muffler

- Worn valve stem or valve guide
- Damaged valve stem oil seal

Abnormal noise

- Incorrect valve clearance adjustment
- Sticking valve or broken valve spring
- Damaged or worn camshaft
- Worn cam chain tensioner
- Worn camshaft and rocker arm

6. CYLINDER HEAD/VALVES

CYLINDER HEAD COVER

REMOVAL

Remove four bolts then remove the cylinder head cover.



INSTALLATION

Install a new cylinder head cover O-ring and install the cylinder head cover.

* Be sure to install the O-ring into the groove properly.

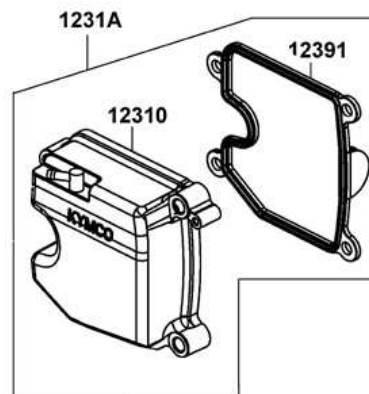

Install and tighten the cylinder head cover bolts to the specified torque in a crisscross pattern.

Torque: 0.8~0.9kgf-m



6. CYLINDER HEAD/VALVES

CAMSHAFT HOLDER

REMOVAL

Turn the A.C. generator flywheel so that the T mark on the flywheel aligns with the index mark on the crankcase.

Hold the round hole on the camshaft gear facing up and location is the top dead center on the compression stroke.

Remove two bolts attaching cam chain tensioner.

Remove four nuts of camshaft holder and remove the sprocket fixed nut then remove the sprocket.



Remove the camshaft gear bolt.



INSTALLATION

Install the camshaft gear bolt and holder washers and nuts.

Tighten four cylinder head nuts to the specified torque.

Torque:

- 0.7~1.1 kgf-m (Holder nuts)
- 1.0~1.4 kgf-m (Cam shaft set plate)
- 1.8~2.2 kgf-m (Cylinder head M8X1.25)



- *
 - Install the camshaft holder with the “EX” mark face exhaust valve side.
 - Apply engine oil to the threads of the cylinder head cap nuts.
 - Diagonally tighten the cylinder head nuts in 2~3 times.

6. CYLINDER HEAD/VALVES

DISASSEMBLY

Take out the valve rocker arm shafts
Remove the valve rocker arms.

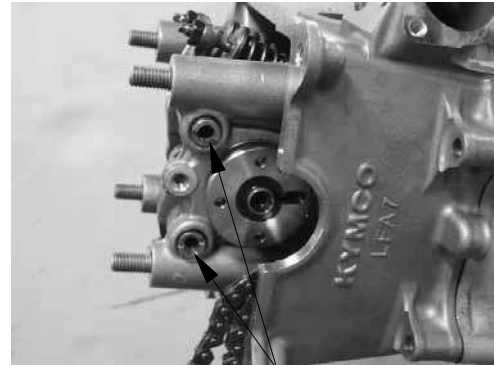

Rocker Arm Shafts

INSPECTION

Inspect the camshaft holder, valve rocker arms and rocker arm shafts for wear or damage.

* If the valve rocker arm contact surface is worn, check each cam lobe for wear or damage.

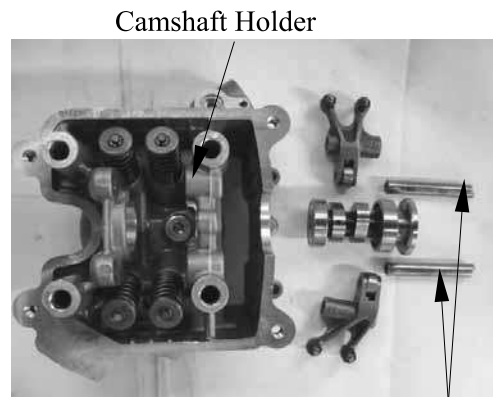

Rocker Arm Shafts

Inspect the rocker arm bore, cam lobe contact surface and adjuster surface for wear/pitting/scratches/blue discoloration.

If any defects are found, replace the rocker arm shaft with a new one, then inspect lubrication system.

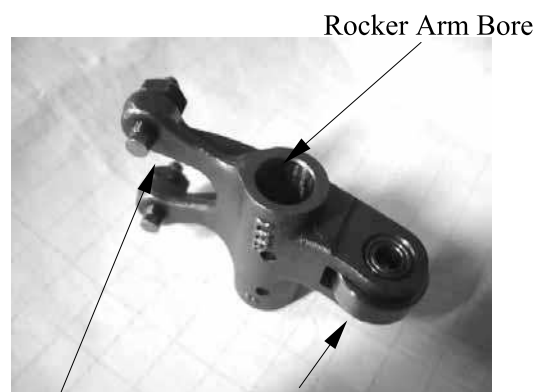

Adjuster Surface

Contact Surface

6. CYLINDER HEAD/VALVES

ASSEMBLY

Apply engine oil to the rocker arms and rocker arm shafts.

Install the rocker arms and shafts into the camshaft holder.

- Install the exhaust valve rocker arm shaft on the “EX” side of the camshaft holder
- Clean the intake valve rocker arm shaft off any grease before installation.

Rocker Arm Shafts

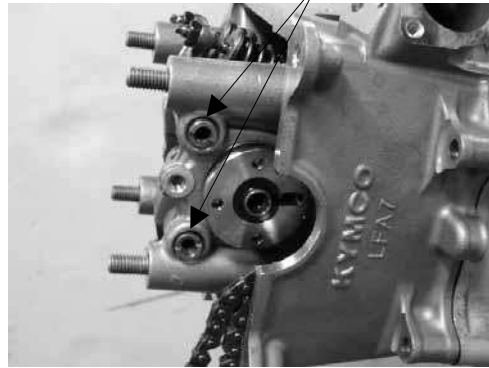

6. CYLINDER HEAD/VALVES

CAMSHAFT

REMOVAL

Turn the A.C. generator flywheel so that the "T" mark on the flywheel aligns with the index mark on the crankcase.
Hold the round hole on the camshaft gear facing up and the location is the top dead center on the compression stroke.

Remove the tensioner sealing bolt and spring.
Remove the two bolts from cam chain tensioner and then remove the tensioner and gasket.

Remove the camshaft gear and bolt.

Remove the camshaft from the cylinder head

Tensioner Sealing Bolt

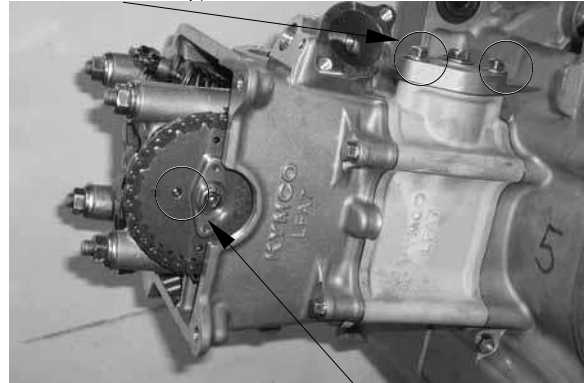

Round Hole

Camshaft



6. CYLINDER HEAD/VALVES

INSPECTION

Camshaft

Inspect camshaft lobes for pitting/scratches/blue discoloration.



If any defects are found, replace the camshaft with a new one, then inspect lubrication system.

Check each camshaft bearing for play or damage. Replace the camshaft assembly with a new one if the bearings are noisy or have excessive play.



6. CYLINDER HEAD/VALVES

INSTALLATION

Turn the A.C. generator flywheel so that the “T” mark on the flywheel aligns with the index mark on the crankcase.
Keep the round hole on the camshaft gear facing up and align the punch marks on the camshaft gear with the cylinder head surface (Position the intake and exhaust cam lobes down.) and install the cam chain onto the camshaft gear.

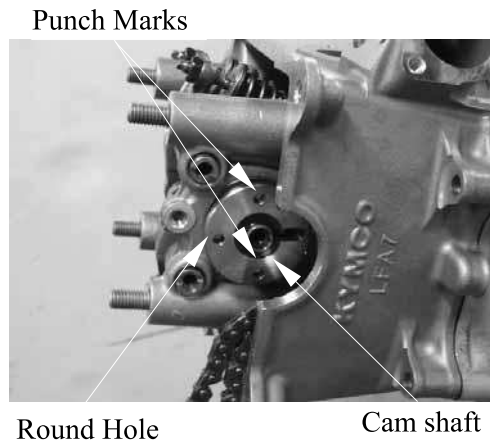

Install the rocker arms shafts fixed bolt .

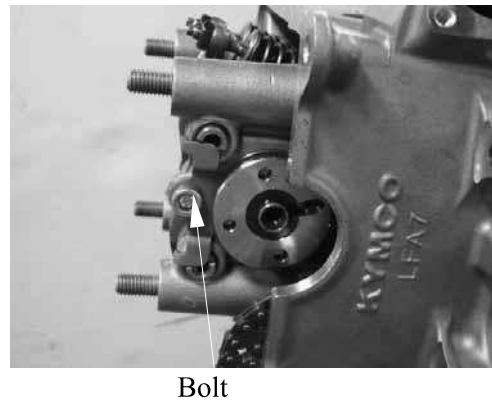

Install the camshaft gear

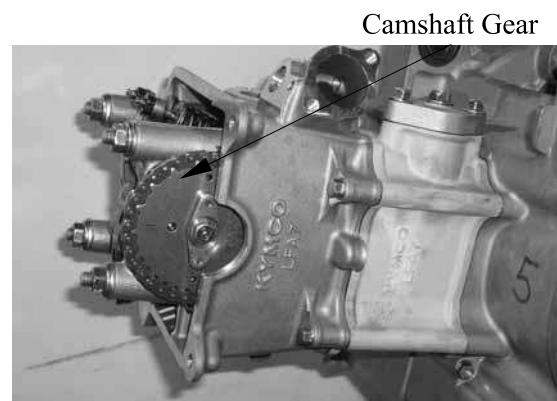

6. CYLINDER HEAD/VALVES

DISASSEMBLY

Remove the valve spring cotters, retainers, springs, spring seats, oil seals and valves using a valve spring compressor.

- *
- Be sure to compress the valve springs with a valve spring compressor.
 - Mark all disassembled parts to ensure correct reassembly.

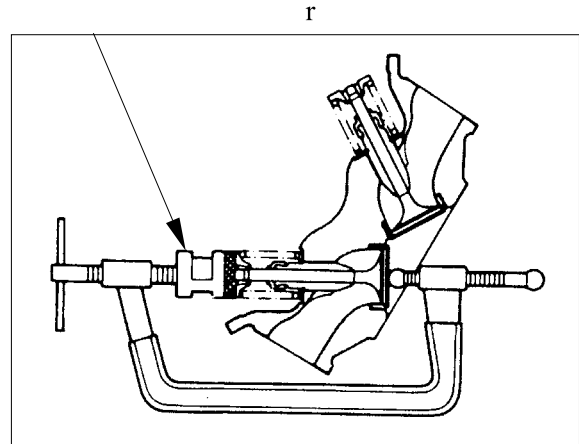

Special tool:

Valve Spring Compressor A120E00040

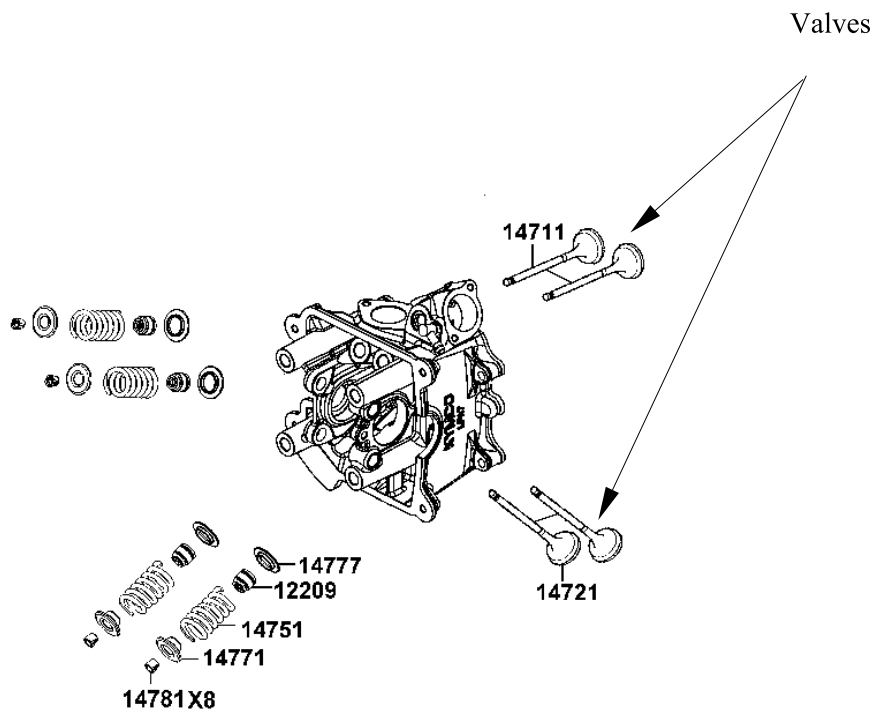

6. CYLINDER HEAD/VALVES

INSPECTION

Remove carbon deposits from the exhaust port and combustion chamber.

- * Be careful not to damage the cylinder head mating surface.

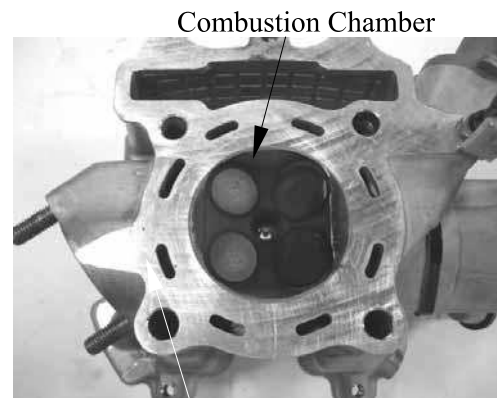

Exhaust Port

Valve /Valve guide

Inspect each valve for bending, burning, scratches or abnormal stem wear.
If any defects are found, replace the valve with a new one.

- * If the stem-to-guide clearance exceeds the service limits, replace the cylinder head is necessary.

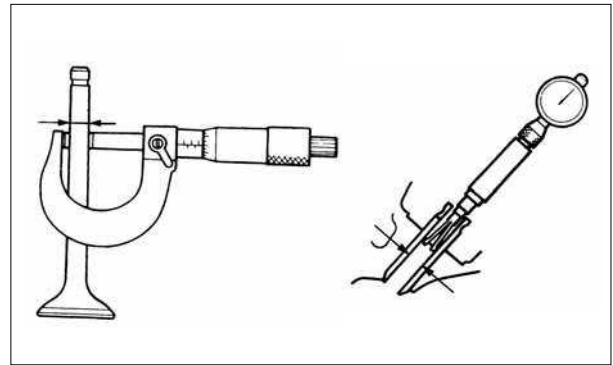

Valve spring

Measure the free length of the inner and outer valve springs.

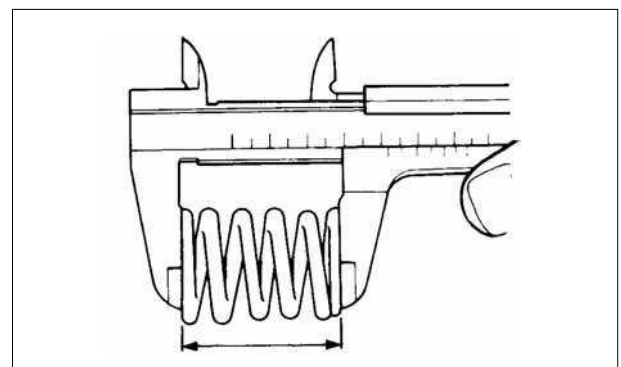

6. CYLINDER HEAD/VALVES

Cylinder head

Check the spark plug hole and valve areas for cracks.

Check the cylinder head for warpage with a straight edge and feeler gauge.

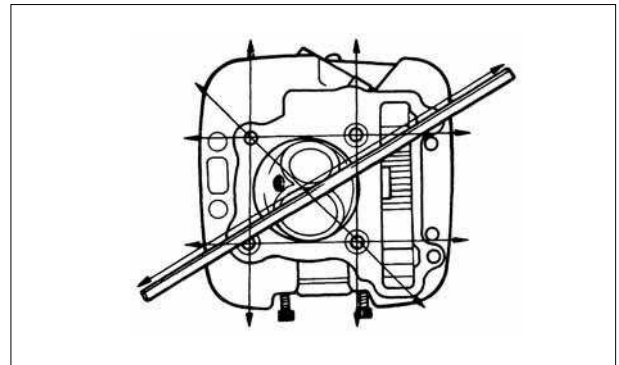

ASSEMBLY

Install the valve spring seats and oil seal.

* Be sure to install the new oil seals.

Lubricate each valve with engine oil and insert the valves into the valve guides. Install the valve springs and retainers. Compress the valve springs using the valve spring compressor, then install the valve cotters.

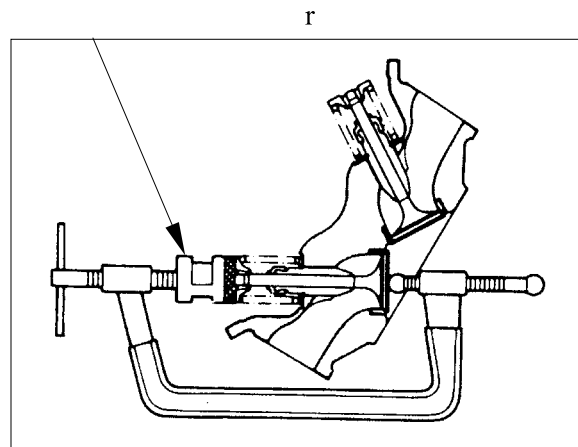

* When assembling, a valve spring compressor must be used.

Special tool:

Valve Spring Compressor A120E00040

Tap the valve stems gently with a plastic hammer for 2~3 times to firmly seat the cotters.

* Be careful not to damage the valves.

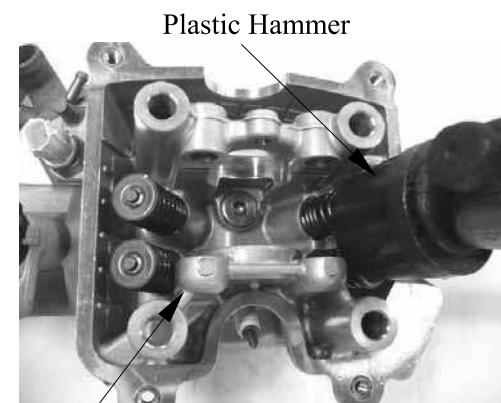

Cylinder Head

7. CYLINDER/PISTON

CYLINDER/PISTON

SCHEMATIC DRAWING -----	7-1
SERVICE INFORMATION-----	7-2
TROUBLESHOOTING-----	7-3
CYLINDER AND PISTON -----	7-4



7. CYLINDER/PISTON

SCHEMATIC DRAWING

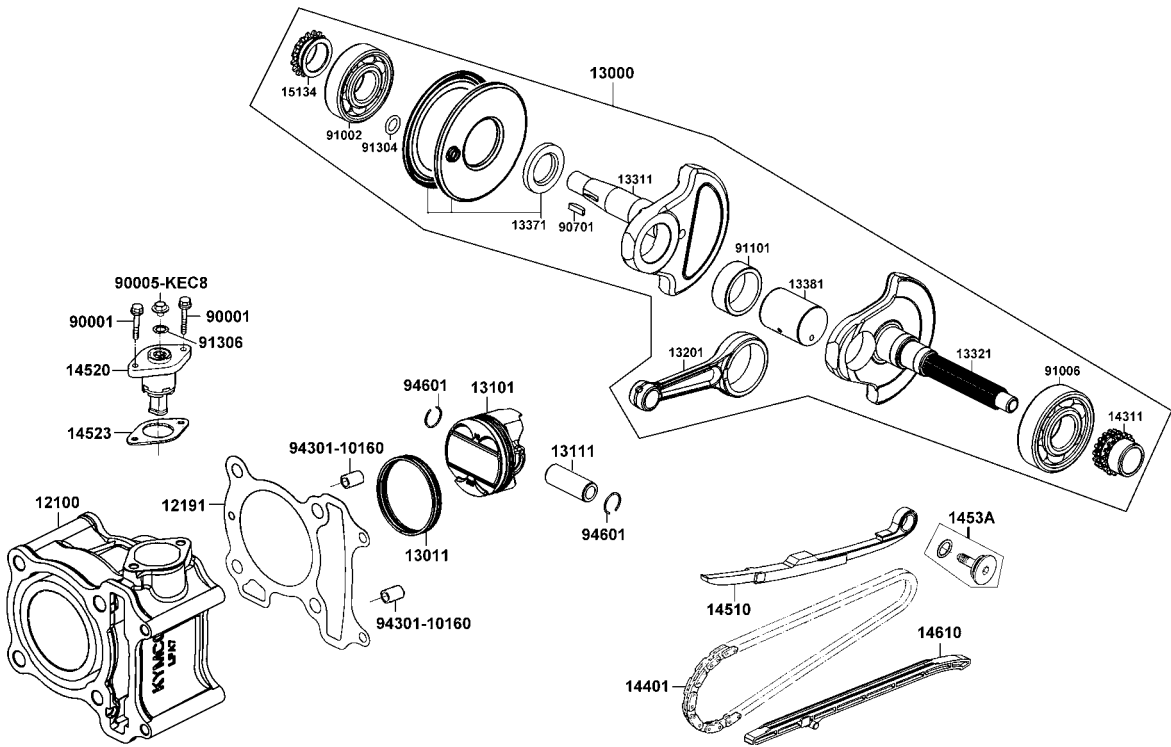

7. CYLINDER/PISTON

SERVICE INFORMATION

GENERAL INSTRUCTIONS

- When installing the cylinder, use a new cylinder gasket and make sure that the dowel pins are correctly installed.
- After disassembly, clean the removed parts and dry them with compressed air before inspection.

SPECIFICATIONS

Unit: mm

Item		Standard	
Cylinder	I.D.	52.4~52.41	
	Warpage	—	
	Cylindricity	—	
	True roundness	—	
Piston, piston ring	Ring-to-groove clearance	Top	0.015~0.055
		Second	0.015~0.055
	Ring end gap	Top	0.10~0.25
		Second	0.10~0.25
		Oil side rail	0.2~0.7
	Piston O.D.		52.37~52.39
	Piston O.D. measuring position		9 mm from bottom of skirt
	Piston-to-cylinder clearance		0.01~0.04
	Piston pin hole I.D.		15.002~15.008
Piston pin O.D		14.994~15	
Piston-to-piston pin clearance		0.002~0.014	
Connecting rod small end I.D. bore		15.016~15.034	

7. CYLINDER/PISTON

TROUBLESHOOTING

- When hard starting or poor performance at low speed occurs, check the crankcase breather for white smoke. If white smoke is found, it means that the piston rings are worn, stuck or broken.

Compression too low or uneven compression

- Worn or damaged cylinder and piston rings
- Worn, stuck or broken piston rings

Compression too high

- Excessive carbon build-up in combustion chamber or on piston head

Excessive smoke from exhaust muffler

- Worn or damaged piston rings
- Worn or damaged cylinder and piston

Abnormal noisy piston

- Worn cylinder, piston and piston rings
- Worn piston pin hole and piston pin
- Incorrectly installed piston

7. CYLINDER/PISTON

CYLINDER AND PISTON

REMOVAL

Remove the cylinder head (refer to “**CYLINDER HEAD**” section in the chapter 6).

Remove the water hose attached the cylinder.

Remove the cylinder.

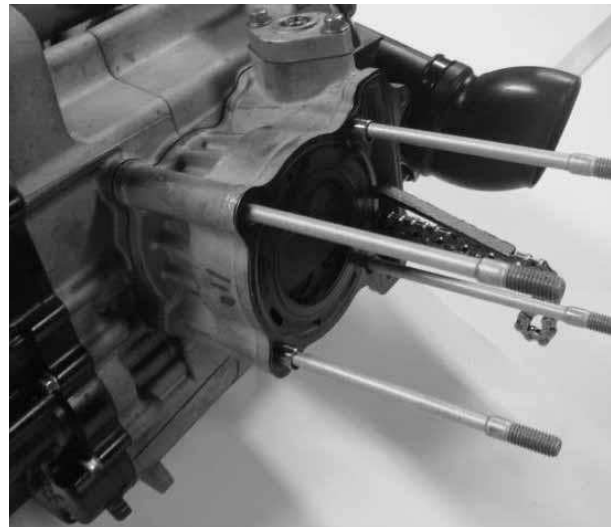

Remove the cylinder gasket (4) and dowel pins (3).
Clean any gasket material onto the cylinder surface.

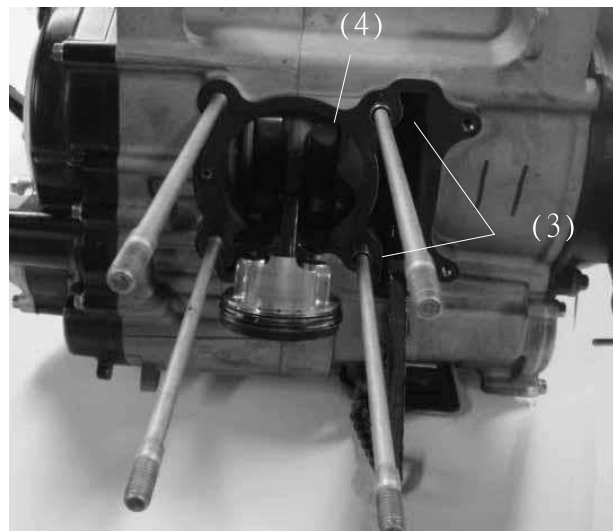

Remove the piston pin clip

* Place a clean shop towel in the crankcase to keep the piston pin clip from falling into the crankcase.

Press the piston pin out of the piston and remove the piston .



7. CYLINDER/PISTON

Spread each piston ring and remove it by lifting up at a point opposite the gap

- * Do not damage the piston ring by spreading the ends too far.

Clean carbon deposits from the piston ring grooves.

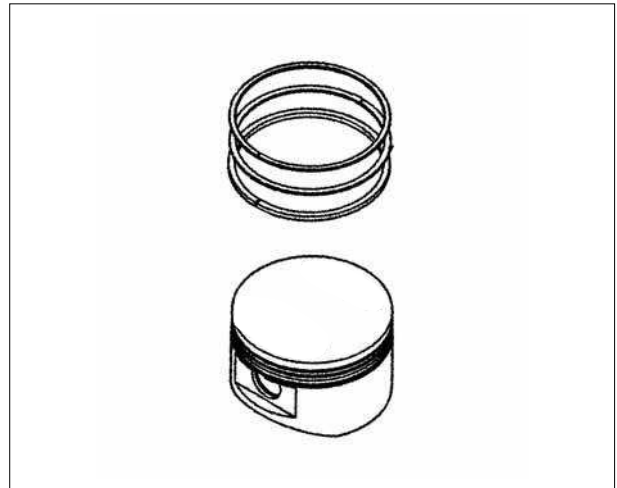

INSPECTION

Piston ring

Inspect the piston rings for movement by rotating the rings. The rings should be able to move in their grooves without catching.

Push the ring until the outer surface of the piston ring is nearly flush with the piston and measure the ring-to-groove clearance.

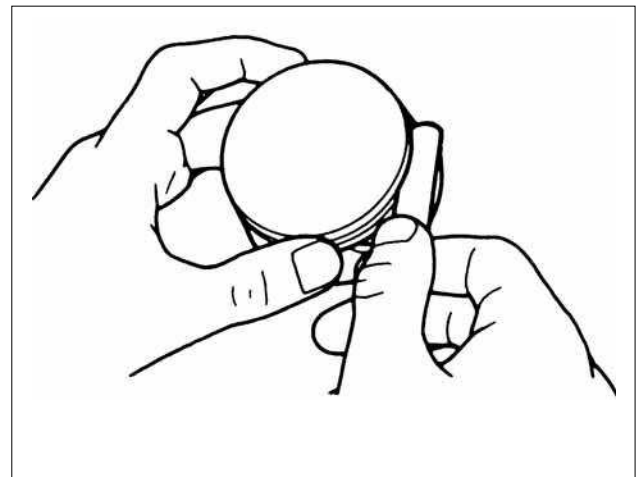

Insert each piston ring into the bottom of the cylinder squarely.

- * Use the piston head to push each piston ring into the cylinder.

Measure the piston ring end gap.

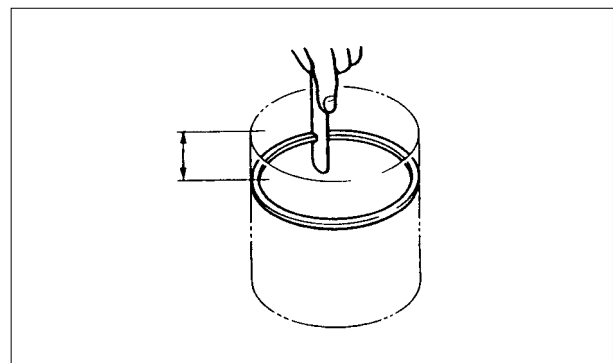

7. CYLINDER/PISTON

Piston/Piston pin

Measure the piston O.D. at the point (A) from the bottom and 90° to the piston pin hole.

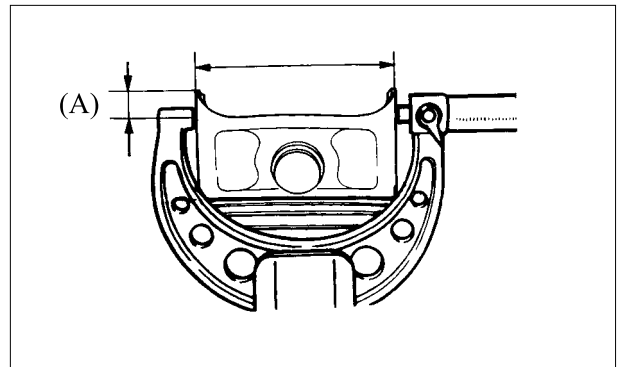

7. CYLINDER/PISTON

Cylinder

Check the cylinder for warpage with a straight edge and feeler gauge in the directions shown.

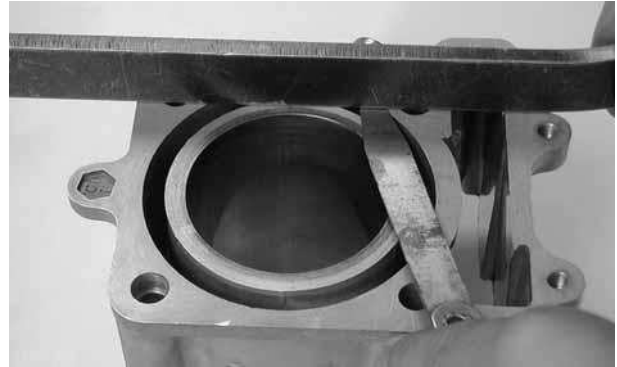

Check the cylinder wall for wear or damage. Measure and record the cylinder I.D. at three levels in an X and Y axis. Take the maximum reading to determine the cylinder wear.

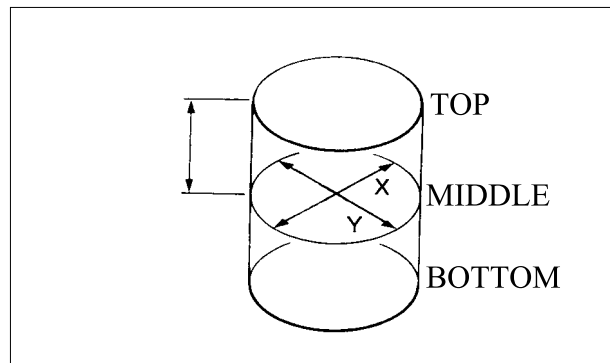

Measure the piston-to-cylinder clearance. Take a maximum reading to determine the clearance.

Measure the taper and out-of-round at three levels in an X and Y axis. Take the maximum reading to determine them.

Measure the connecting rod small end I.D.

Measure the connecting rod-to-piston pin clearance.



7. CYLINDER/PISTON

Inspect the exhaust side and intake side chain guides.

Wear/Damage → Replace.

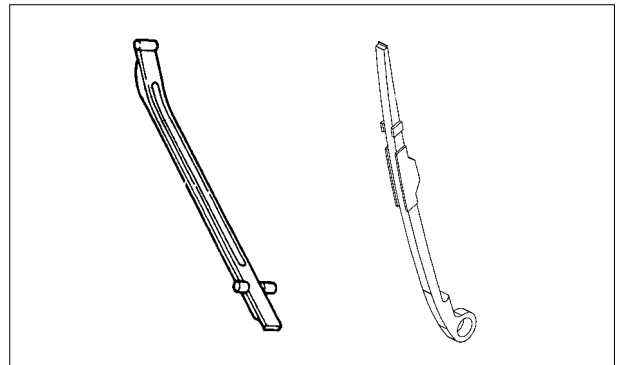

INSTALLATION

Piston ring

Carefully install the piston rings into the piston ring grooves with the markings facing up.

* Be careful not to damage the piston and rings.

- ♦ Do not confuse the top and second rings.
- ♦ To install the oil ring, install the oil ring, then install the side rails.

Stagger the piston ring end gaps 120° degrees apart from each other.

Stagger the side rail end gaps as shown.

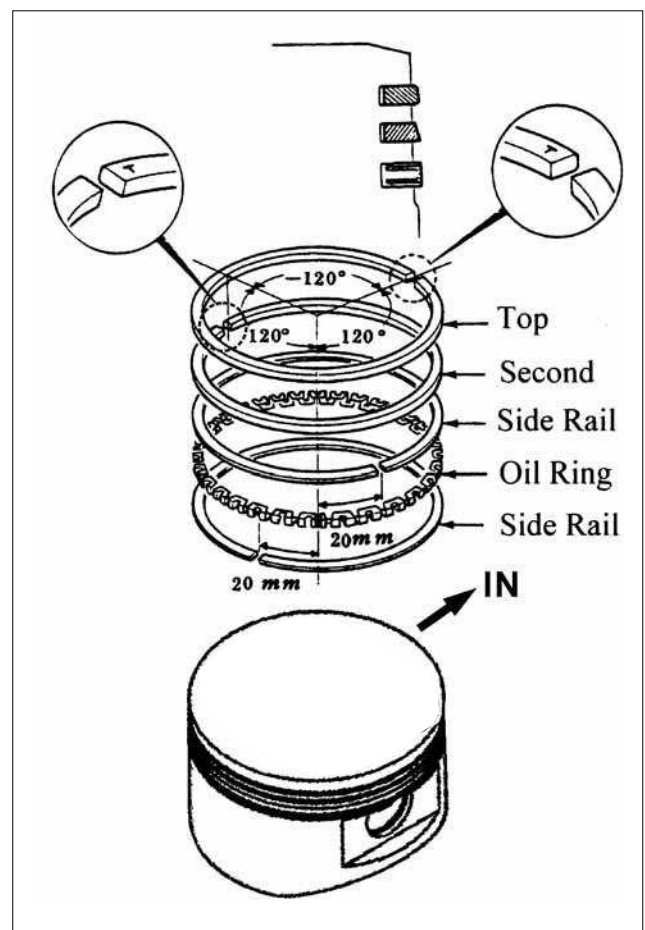

7. CYLINDER/PISTON

Cylinder/Piston

Clean any gasket material attached the cylinder mating surfaces of the crankcase and oil passage.

Apply engine oil to the piston pin.

Apply engine oil to the connecting rod small end and piston pin hole.

Install the piston with the “IN” mark face intake side and piston pin.



Place a clean shop towel over the crankcase prevent the clip from falling into the crankcase.

Install the new pin clip.

- * ♦Make sure that the piston pin clips are seated securely.
- ♦Do not align the piston pin clip end gap with the piston cut-out



Gasket

Install the dowel pins and gasket.



Dowel pins

7. CYLINDER/PISTON

Apply engine oil to the cylinder wall, piston and piston ring outer surfaces.

Pass the cam chain through the cylinder and install the cylinder over the piston.

* Be careful not to damage the piston rings and cylinder walls.

Install the cylinder head and camshaft holder has installed (refer to the “**CYLINDER HEAD**” section in the chapter 6),

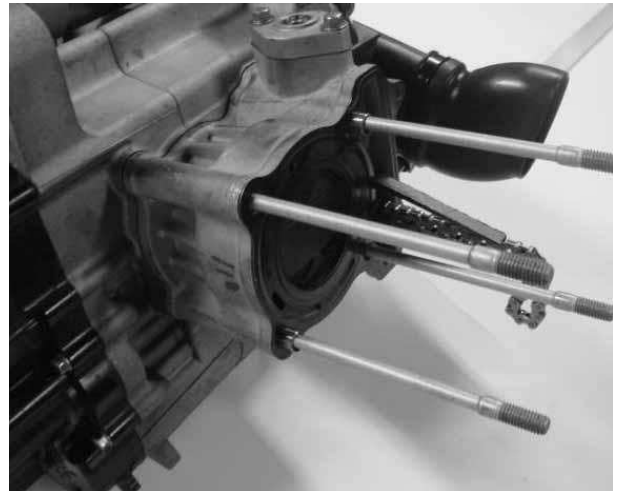

Connect the water hose

.

DRIVE AND DRIVEN PULLEYS

SCHEMATIC DRAWING -----	8- 1
SERVICE INFORMATION-----	8- 2
TROUBLESHOOTING-----	8- 3
LEFT CRANKCASE COVER -----	8- 4
DRIVE PULLEY, DRIVE BELT AND DRIVEN PULLEY -----	8- 5



8. DRIVE AND DRIVEN PULLEYS



DOWNTOWN 125i

SCHEMATIC DRAWING

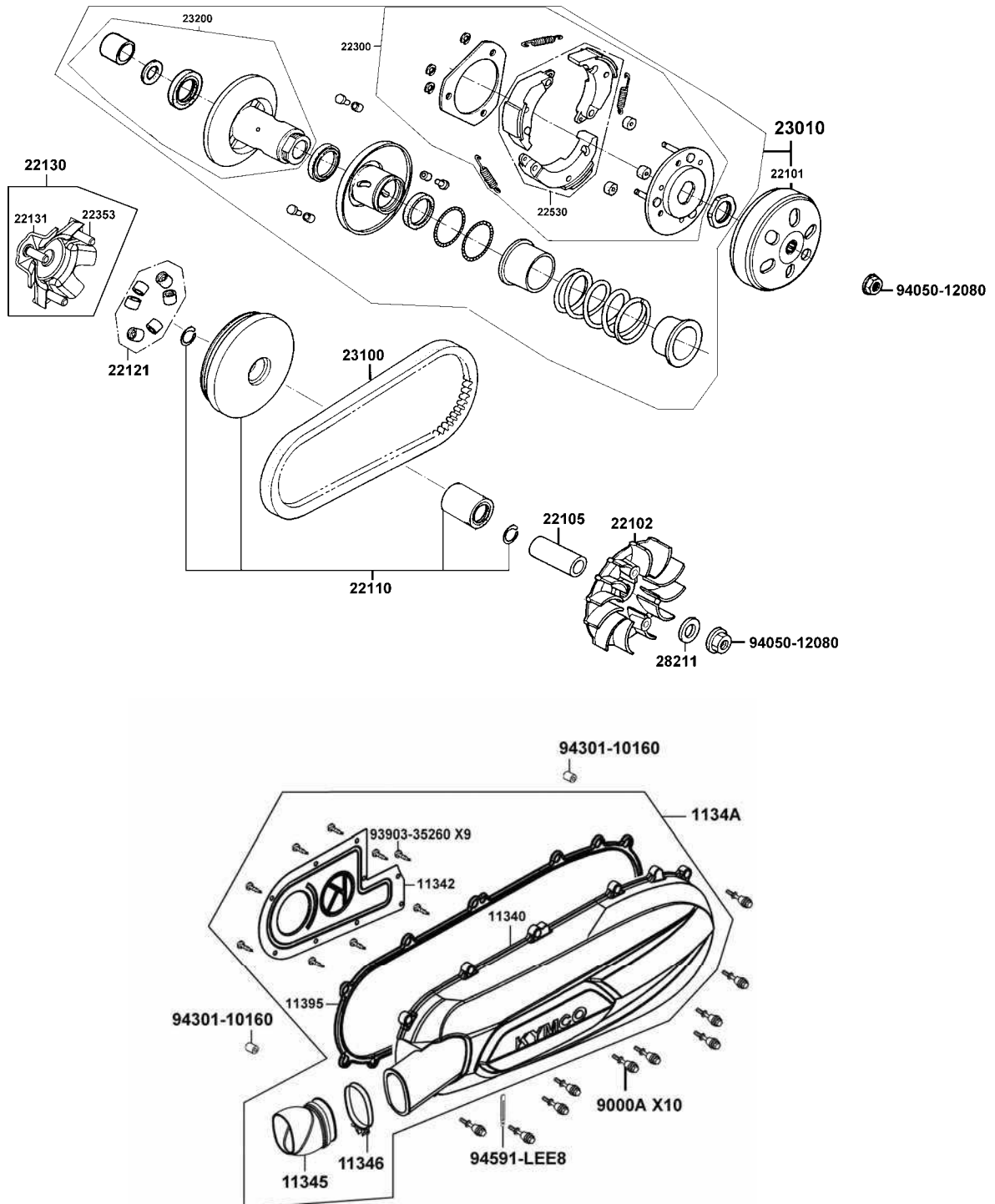

SERVICE INFORMATION

GENERAL INSTRUCTIONS

- The drive pulley, clutch and driven pulley can be serviced with the engine installed.
- Avoid getting grease and oil on the drive belt and pulley faces. Remove any oil or grease from them to minimize the slipping of drive belt and drive pulley.

SPECIFICATIONS

Unit: mm

Item	Standard
Movable drive face bushing I.D.	24.011~24.052
Drive face collar O.D.	23.960~23.974
Clutch outer I.D.	130~130.2
Driven face O.D.	33.965~33.985
Movable driven face I.D.	34~34.025
Weight roller O.D.	17.920~18.080

TORQUE VALUES

Drive face nut	5.5~6.5 kgf-m
Clutch outer nut	5.0~6.0 kgf-m
Clutch plate comp	5.0~6.0 kgf-m

SPECIAL TOOLS

Universal holder	A120E00017
Clutch spring compressor	A120E00034

TROUBLESHOOTING

Engine starts but motorcycle fail to move

- Worn drive belt
- Broken ramp plate
- Worn or damaged clutch lining
- Broken driven face spring

Engine stalls or motorcycle creeps

- Broken clutch weight spring

Lack of power

- Worn drive belt
- Weak driven face spring
- Worn weight roller
- Faulty driven face

8. DRIVE AND DRIVEN PULLEYS

LEFT CRANKCASE COVER

REMOVAL

Remove ten left crankcase cover bolts and then remove the left crankcase cover. Remove the gasket and dowel pins.

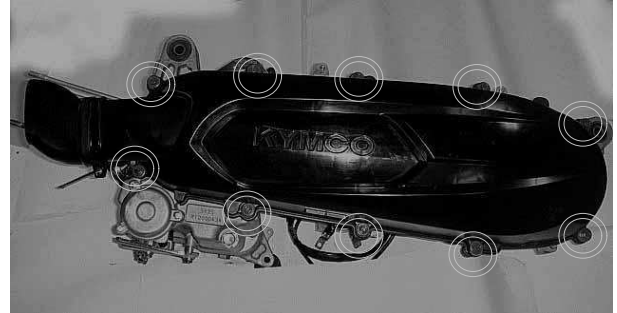

Dowel Pins

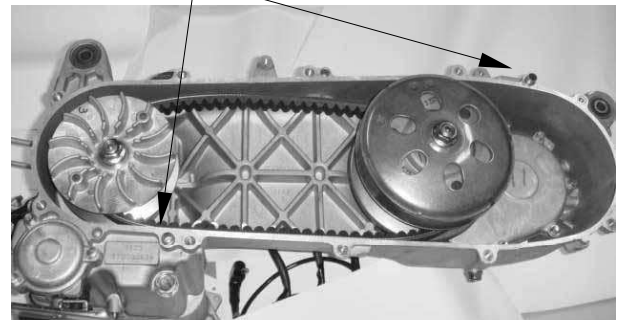

INSTALLATION

Install the dowel pins and gasket.

Install the left crankcase cover.

Install and tighten ten bolts diagonally to specified torque.



DRIVE PULLEY, DRIVE BELT AND DRIVEN PULLEY

REMOVAL

Remove the left crankcase cover

Use the special tool to hold the drive pulley, then remove the nut and ratchet.

Special tool:

Universal holder A120E00017

Remove the drive pulley face and washer.

Nut/Ratchet

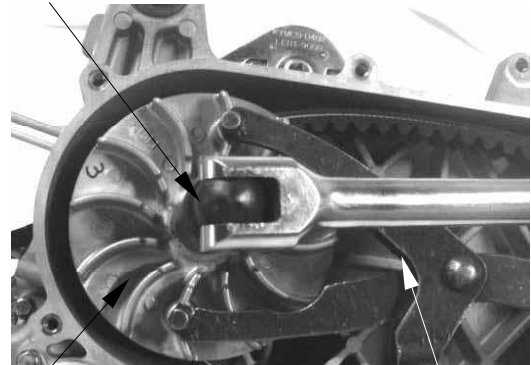

Drive Pulley Face

Universal Holder

Hold the clutch outer with the universal holder and remove the clutch outer nut.

Special tool:

Universal Holder A120E00017

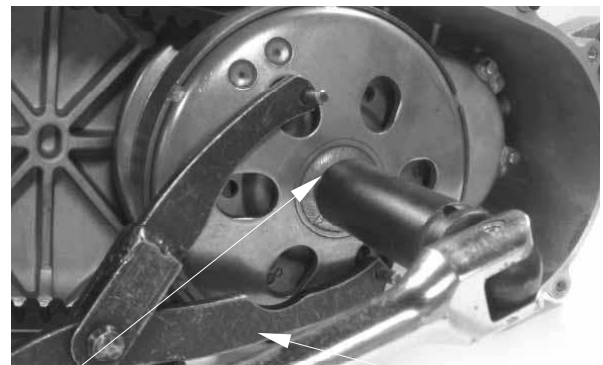

Nut

Universal Holder

Remove the clutch outer, driven pulley assembly and drive belt together.

Clutch Outer/Driven Pulley Assembly

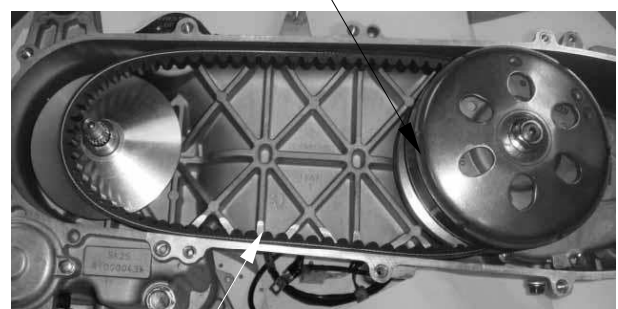

Drive Belt

8. DRIVE AND DRIVEN PULLEYS

Remove the movable drive face assembly.



Movable Drive Face Assembly

Drive belt inspection

Check the drive belt for cracks, separation or abnormal or excessive wear.
Replace a new belt at every 20000KM

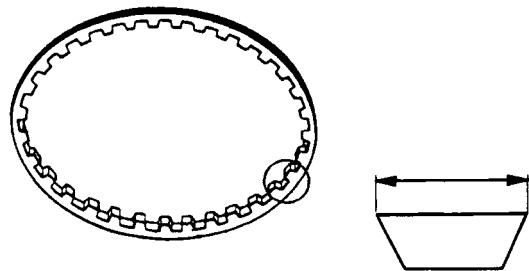

* Use specified genuine parts for replacement.

Clutch out inspection

Inspect the clutch out for wear or damage.
Measure the clutch out I.D.

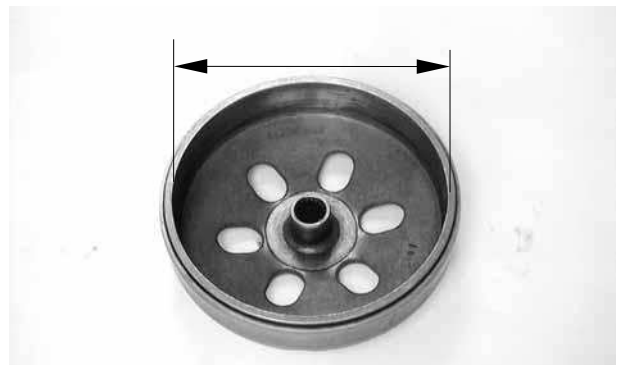

INSTALLATION

Apply lubricant to the drive face boss inner surface, then install the movable drive face assembly.

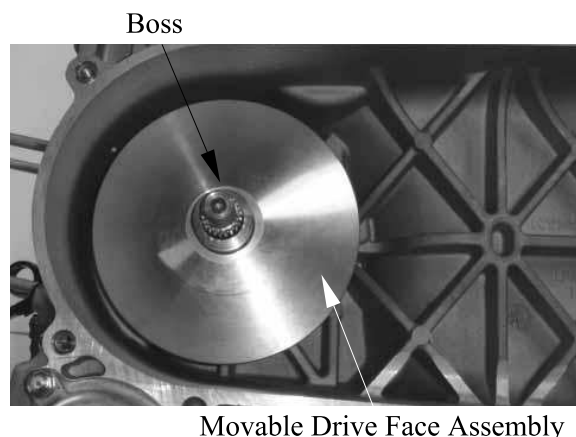

Install the clutch outer onto the driven pulley assembly.
Compress the driven pulley assembly by hand, then install the drive belt into the driven pulley assembly.

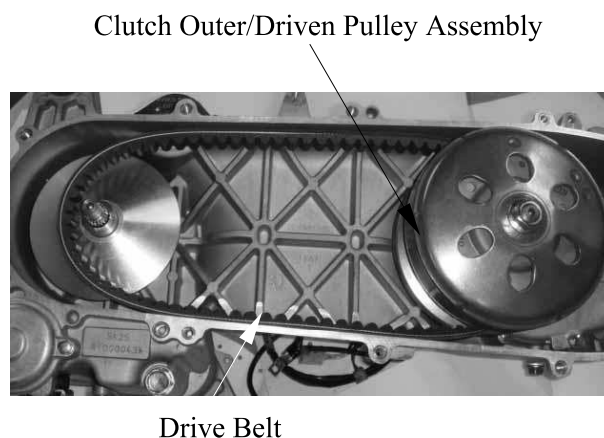

- * ● The drive belt should be installed so that the arrows on the drive belt periphery point in the normal turning direction if the drive belt has arrow mark.
- The drive belt contact surface of the driven face should be thoroughly cleaned.

Install the driven pulley assembly/clutch outer and drive belt together.

Use the special tool to hold clutch outer, then tighten the nut to the specified torque.

Torque: 5.0~6.0kgf-m (50 ~60N-m)

Special tool:

Universal holder A120E00017



8. DRIVE AND DRIVEN PULLEYS

Install the drive pulley face and ratchet.
Use the special tool to hold drive pulley face,
then tighten the nut to the specified torque.

Torque:

5.5~6.5 kgf-m (55~65 N-m)

Special tool:

Universal holder A120E00017

Noted:

There is a washer between the drive pulley face and nut, don't forget to mount it when installation.

Nut/Ratchet

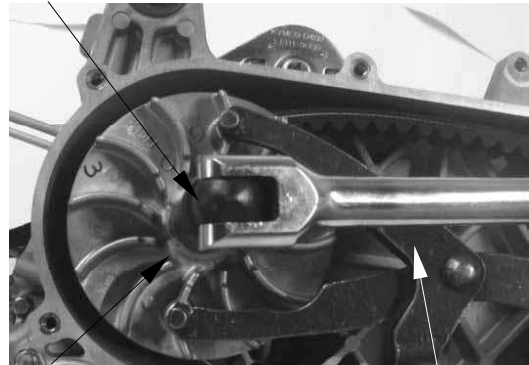

Drive Pulley Face

Universal Holder

8. DRIVE AND DRIVEN PULLEYS

DRIVE PULLEY DISASSEMBLY

Remove the drive face boss.



Boss

Remove the ramp plate

Ramp Plate



Take out six weight rollers.



Weight Roller

8. DRIVE AND DRIVEN PULLEYS

DRIVE PULLEY INSPECTION

Weight rollers

Check each roller for wear or damage.
Measure outside diameter.

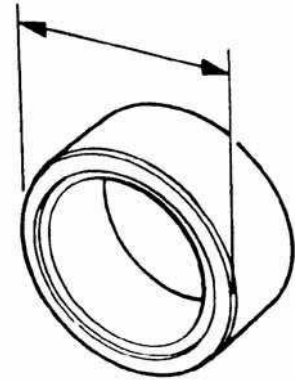

Movable drive face/Slide pieces/Drive pulley face

Check the movable drive face splines for wear, cracks or damage.

Check the ramp plate for cracks or damage.

Ramp Plate



Check the movable drive face and drive pulley face cracks or damage.

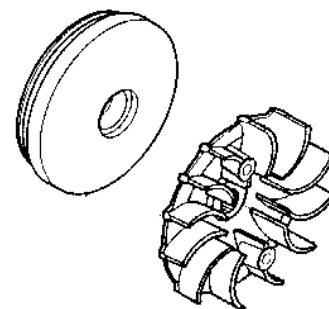

8. DRIVE AND DRIVEN PULLEYS

DRIVE PULLEY ASSEMBLY

Clean the movable drive face, drive pulley face, weight rollers, slide pieces, ramp plate and drive face boss.

- * Remove any excess grease.



Install the weight rollers.

- * The direction of all weight rollers is the same. The thin side is towards to clockwise.



Weight Roller

Install the slide pieces and ramp plate.

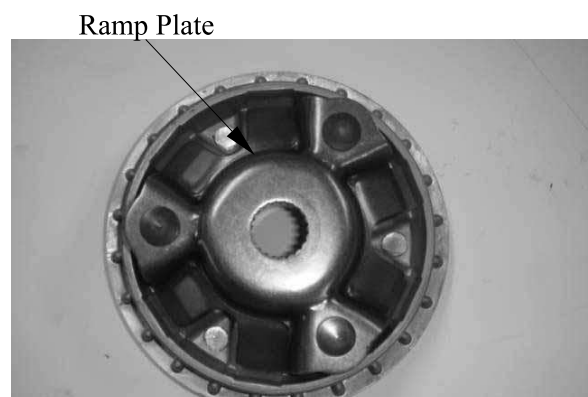

Ramp Plate

8. DRIVE AND DRIVEN PULLEYS

Install the drive face boss.

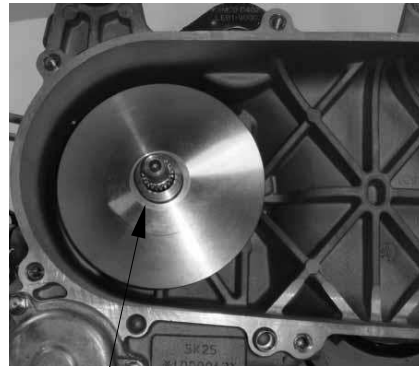

Boss

8. DRIVE AND DRIVEN PULLEYS

DRIVEN PULLEY DISASSEMBLY

Hold the clutch/driven pulley assembly with the clutch spring compressor.

* Be sure to use a clutch spring compressor to avoid spring damage.

Special tool:

Clutch Spring Compressor A120E00034

Set the tool in a vise and remove the clutch drive plate nut.

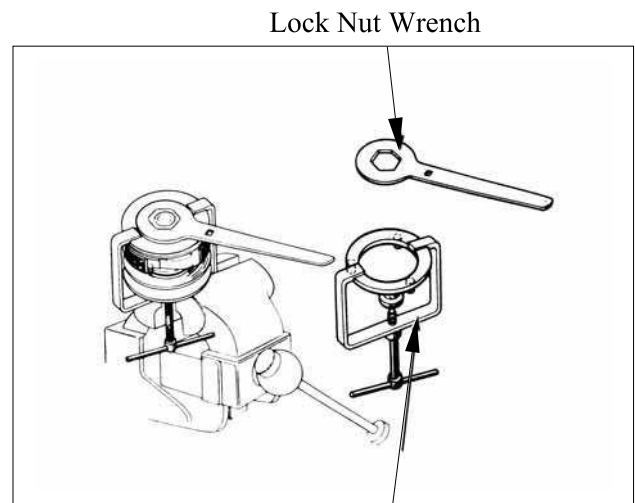

Clutch spring compressor

Remove the clutch weight.



8. DRIVE AND DRIVEN PULLEYS

Remove the spring.

Remove the spring collar on the movable driven face.

Remove the three guide pins/rollers, then remove the movable driven face.

Remove the needle bearing from driven face.

Remove the snap ring, then remove the bearing from driven face.

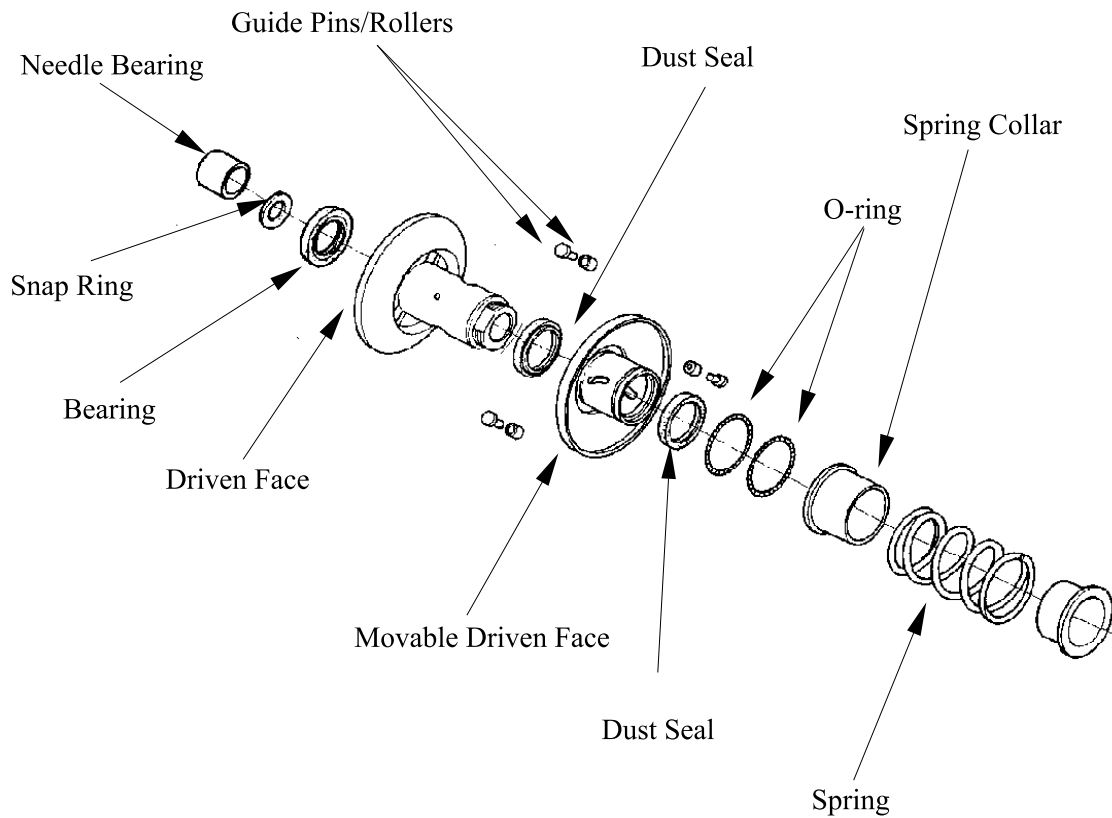

8. DRIVE AND DRIVEN PULLEYS

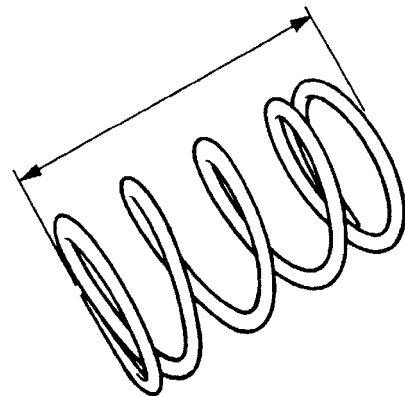
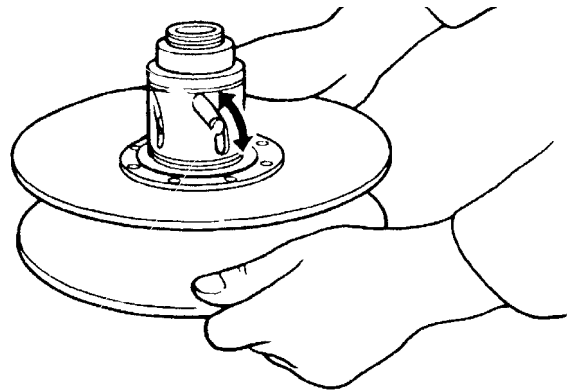

Check the clutch shoe for heat damage.

Measure the clutch shoe thickness.



8. DRIVE AND DRIVEN PULLEYS

DRIVEN PULLEY ASSEMBLY

Clean any oil from the drive belt sliding surfaces on the driven face.

Filling 12 g of grease to driven face inner side.

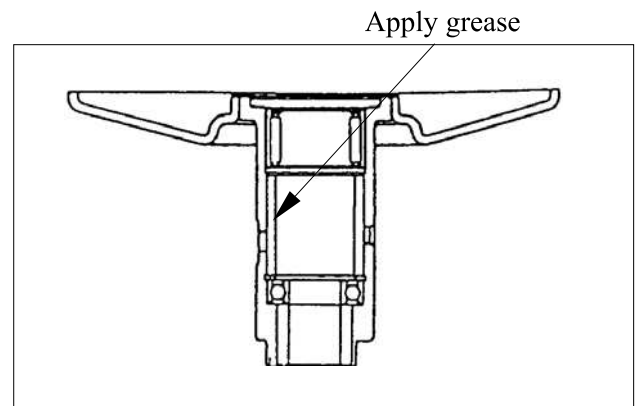

Apply grease to lips of the new dust seals and install into the movable driven face.

Coat new O-rings with grease and install them into the movable driven face grooves.

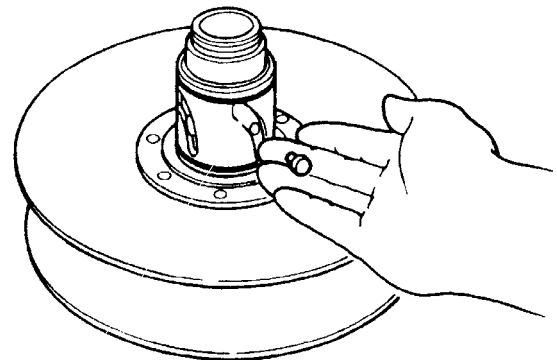

Install the movable driven face onto the driven face.

Install the guide rollers and guide roller pins.

Filling 5 g of grease to each guide groove.

Install the guide pins/rollers.

Install spring collar.

Use the special tool to install spring and clutch, then install and tighten the nut to the specified torque.

Torque: 5.5 ~6.5m (55~65N-m)

Special tool:

Clutch Spring Compressor A120E00034

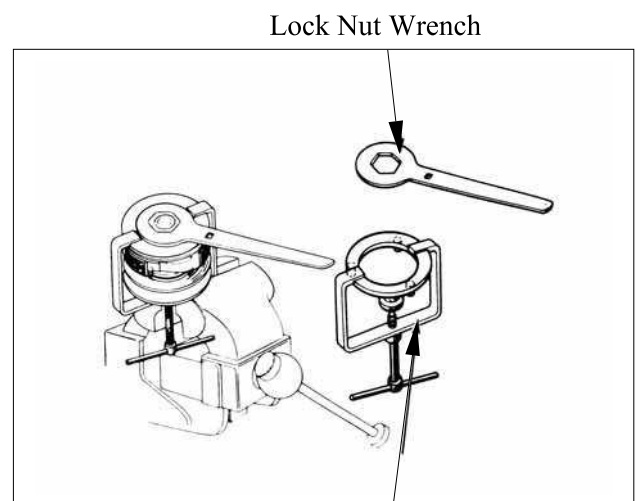

r

9. FINAL REDUCTION



FINAL REDUCTION

SCHEMATIC DRAWING -----	9-1
SERVICE INFORMATION-----	9-2
TROUBLESHOOTING-----	9-2
FINAL REDUCTION -----	9-3
BEARING REPLACEMENT -----	9-7



9. FINAL REDUCTION

SCHEMATIC DRAWING

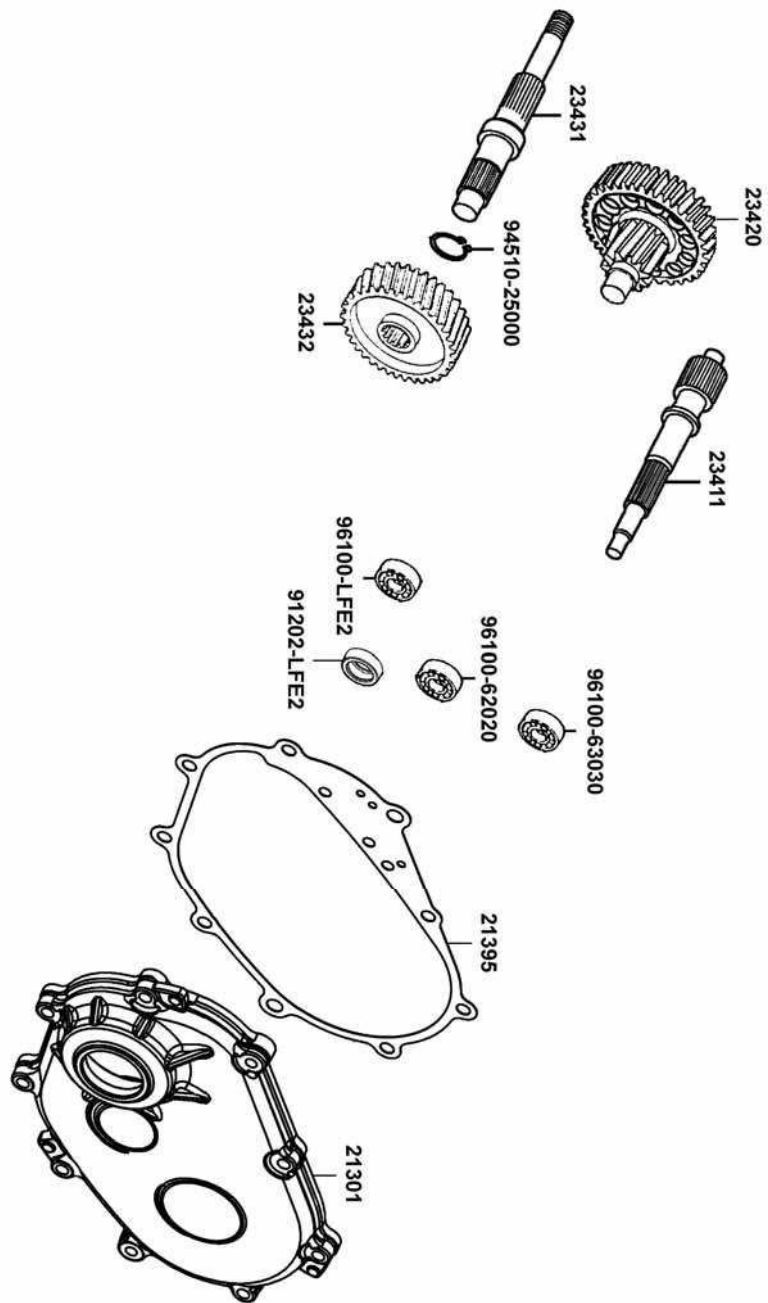

9. FINAL REDUCTION

SERVICE INFORMATION

GENERAL INSTRUCTIONS

- The servicing operations of this section can be made with the engine installed.
- When replacing the drive shaft, use a special tool to hold the bearing inner race for this operation.

SPECIFICATIONS

Specified Oil: SAE 90#

Oil Capacity:

At disassembly : 0.13L

At change : 0.12L

TORQUE VALUES

Transmission case cover bolt 1.0~1.4kgf-m

SPECIAL TOOLS

Oil seal and bearing installer A120E00014

Bearing puller A120E00037

TROUBLESHOOTING

Engine starts but motorcycle fail to move

- Damaged transmission
- Seized or burnt transmission

Abnormal noise

- Worn, seized or chipped gears
- Worn bearing

Oil leaks

- Oil level too high
- Worn or damaged oil seal

9. FINAL REDUCTION

FINAL REDUCTION

REMOVAL

Drain the transmission gear oil into a clean container (refer to the “**TRANSMISSION OIL**” section in the chapter 3).

Remove the driven pulley (refer to the “**DRIVE PULLEY, DRIVE BELT AND DRIVEN PULLEY**” section in the chapter 8).

Remove nine bolts attached the transmission case cover, then remove the transmission case cover.

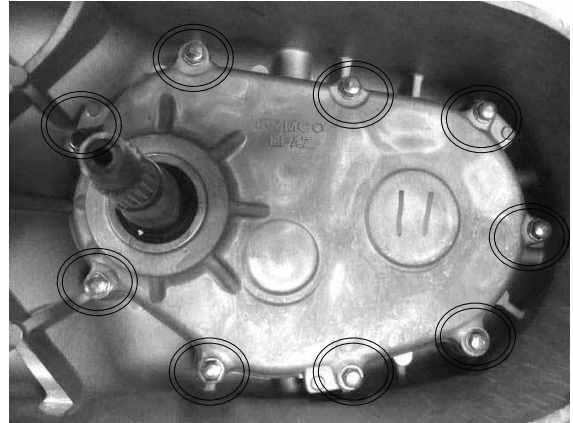

Remove the dowel pins and gasket.
Remove the final gear and shaft, then
remove the countershaft .

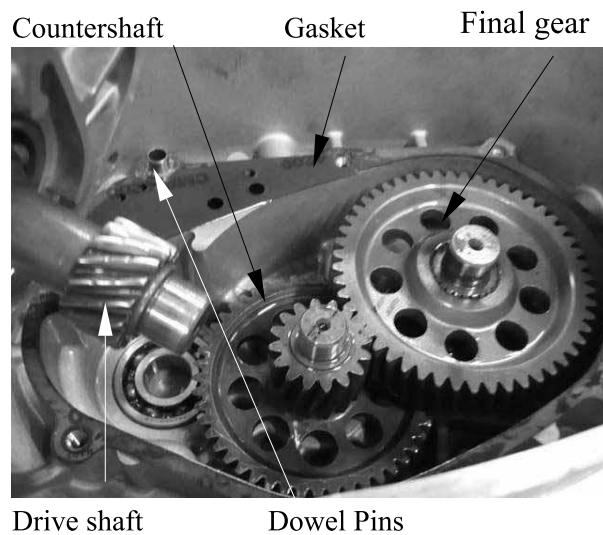

9. FINAL REDUCTION

INSPECTION

Inspect the countershaft and gear for wear or damage.



Inspect the final gear and final gear shaft for wear, damage or seizure.



Check the driveshaft for wear or damage.
Check the left crankcase bearings for excessive play and inspect the oil seal for wear or damage.



9. FINAL REDUCTION

Check the transmission case cover bearings for excessive play and inspect the final shaft bearing oil seal for wear or damage.

Drive Shaft Bearing

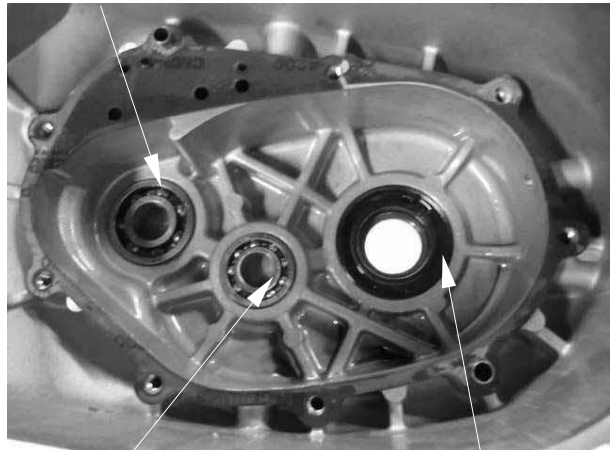

Countershaft Bearing

Final Shaft Bearing

Final Gear Shaft Bearing

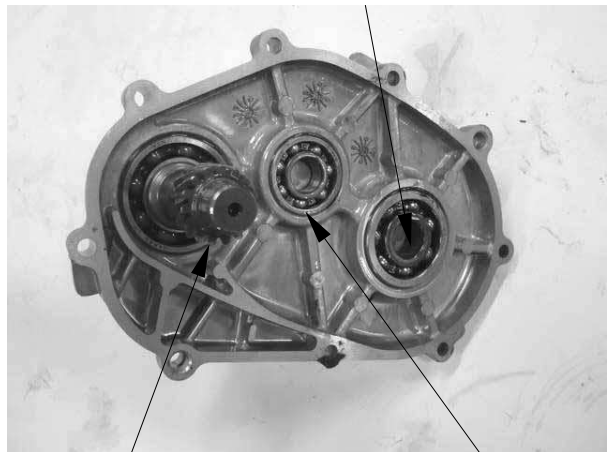

Drive Shaft Bearing

Countershaft Bearing

INSTALLATION

Install the final gear and final gear shaft.

Install the Countershaft

Install the driveshaft.

Countershaft

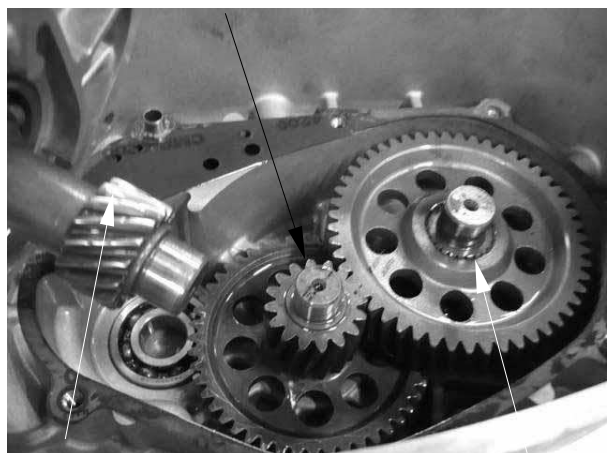

Driveshaft

Final Gear Shaft/Final Gear

9. FINAL REDUCTION

Install new gasket.
Install two dowel pins.

Dowel pins

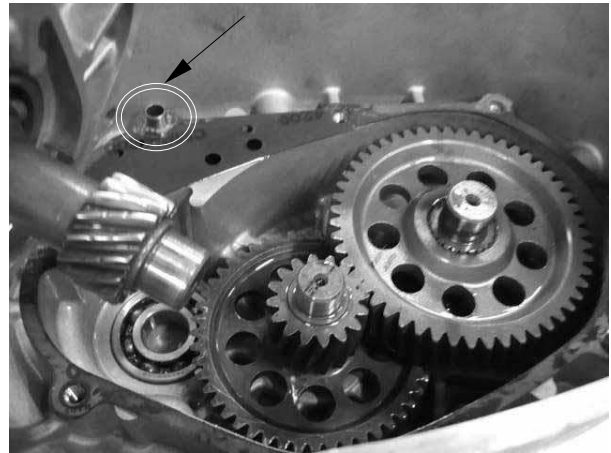

Install the transmission case cover.
Install and tighten the nine bolts to the specified torque in a crisscross pattern in 2 or 3 steps.

Torque: 1.0~1.4kgf-m

Fill the transmission case with the specified oil (refer to the “TRANSMISSION OIL” section in the chapter 3).



9. FINAL REDUCTION

BEARING REPLACEMENT TRANSMISSION CASE COVER

Remove the transmission case cover
Remove the transmission case cover
bearings by using the special tool.

Special tool:

Bearing puller A120E00037

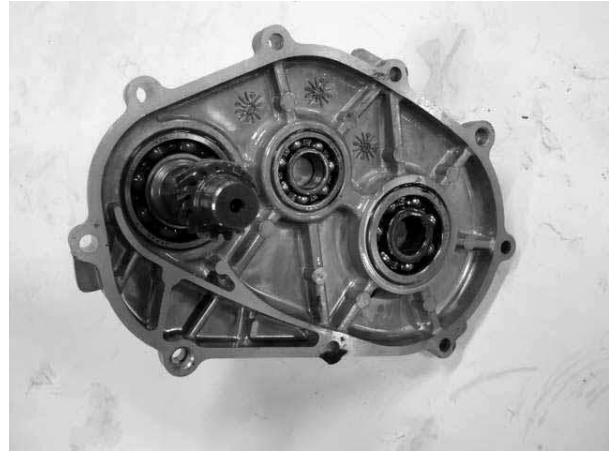

Install the new bearings or new oil seal into
the transmission case cover by using the
special tool.

Special tool:

Oil seal and bearing installer

A120E00014



TRANSMISSION CASE

Remove the all transmission gears
Remove the transmission case bearings by
using the special tool.

Special tool:

Bearing puller A120E00037

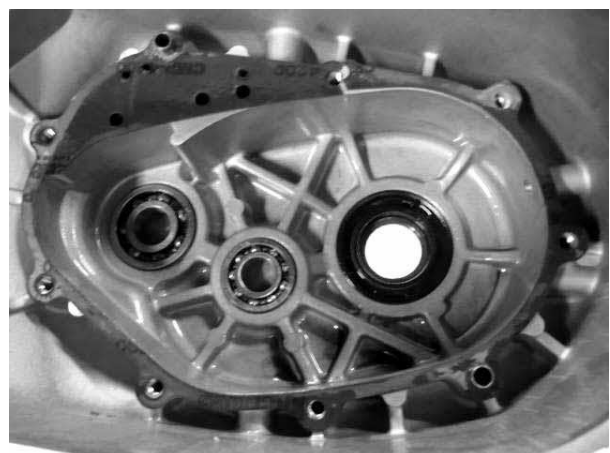

9. FINAL REDUCTION

Install the new bearings or new oil seal into the transmission case by using the special tool.

Special tool:

Oil seal and bearing installer

A120E00014

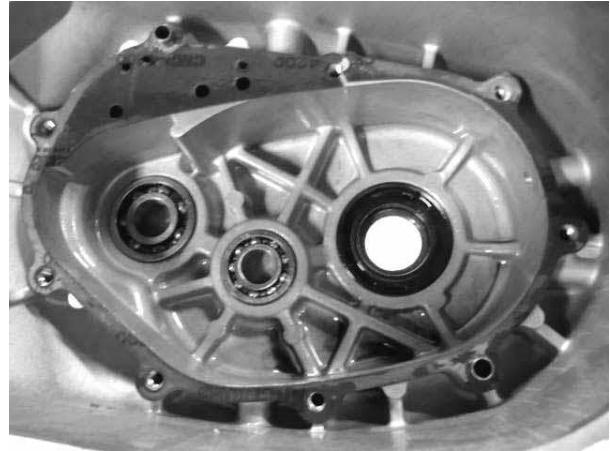

After installation, fill the transmission case with the specified oil.

Specified gear oil :SAE90#

Oil capacity :

At disassembly: 0.13 L

At change: 0.12L

Install and tighten the oil check bolt.

Torque : 0,8~1,2kgf-m

Start the engine and check for oil leaks.



Drain Bolt



Oil Filler Bolt

10. A.C. GENERATOR/STARTER CLUTCH



A.C. GENERATOR/STARTER CLUTCH

SCHEMATIC DRAWING -----	10-1
SERVICE INFORMATION-----	10-2
TROUBLESHOOTING-----	10-2
ALTERNATOR STATOR-----	10-3
STARTER CLUTCH-----	10-6

10. A.C. GENERATOR/STARTER CLUTCH

SCHEMATIC DRAWING

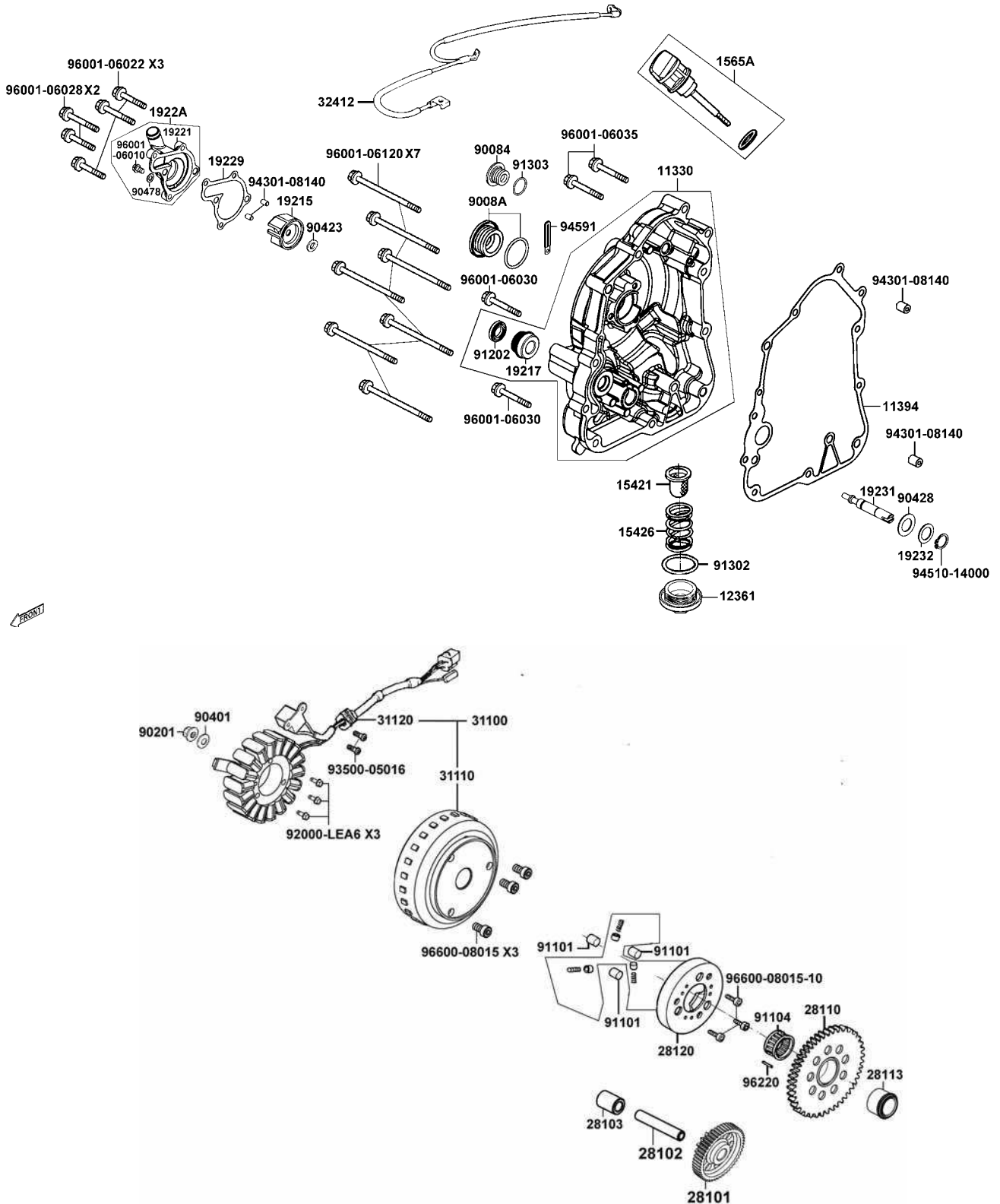

10. A.C. GENERATOR/STARTER CLUTCH

SERVICE INFORMATION

GENERAL INSTRUCTIONS

- All servicing operations and inspections in this section can be made with the engine installed.
- Drain the coolant before removing the right crankcase cover.
- Be careful not to drain the coolant when the engine temperature is high. (Perform this operation when the engine is cold.)
- Drain the coolant into a clean container.
- Drain the engine oil into a clean container before removing the right crankcase cover.
- When the right crankcase cover is installed, fill with the recommended engine oil and coolant. Then, bleed air from the water jacket.

SPECIFICATIONS

Engine oil: SAE 15W/40#
API-SJ

Oil capacity at change: 1.0 L

Coolant: distilled water + coolant concentrate

Coolant capacity: 0.87L

SPECIAL TOOLS

Flywheel puller	A120E00003
Flywheel holder	A120E00021

TORQUE VALUES

Flywheel nut : 5.0~6.0 kgf-m

TROUBLESHOOTING

Starter motor rotates but engine fail to start

- Faulty starter clutch
- Starter motor rotates reversely
- Weak battery

10. A.C. GENERATOR/STARTER CLUTCH

A.C.GENERATOR

REMOVAL

Drain the engine oil (refer to the “ENGINE OIL” section in the chapter 3).

Disconnect the generator connectors

Remove ten bolts attached the right crankcase cover and then remove the cover.

Remove two dowel pins and gasket.



Dowel Pins

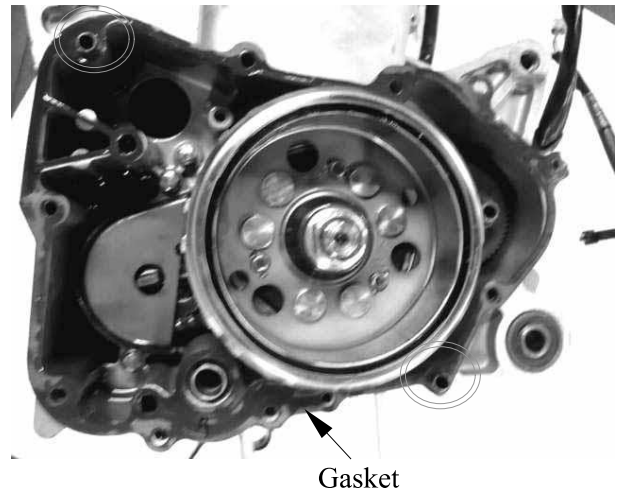

Remove two pulse coil mount screws.
Remove three stator mount bolts, grommet and the stator attached the right crankcase cover.

Stator



10. A.C. GENERATOR/STARTER CLUTCH

INSPECTION

Check the stator and pulse coil for damage.

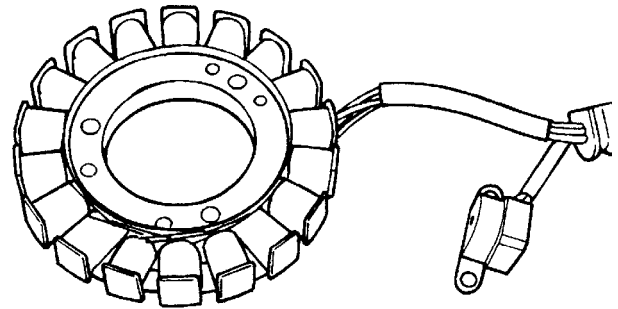

INSTALLATION

Install the stator and tighten the stator mount bolts to the specified torque.

Torque: 1 kgf-m

Apply sealant to the grommet seating surface and install it to the cover groove properly.

Install the pulse coil and tighten mount screws securely.

Clean the mating surfaces of the right crankcase and cover.

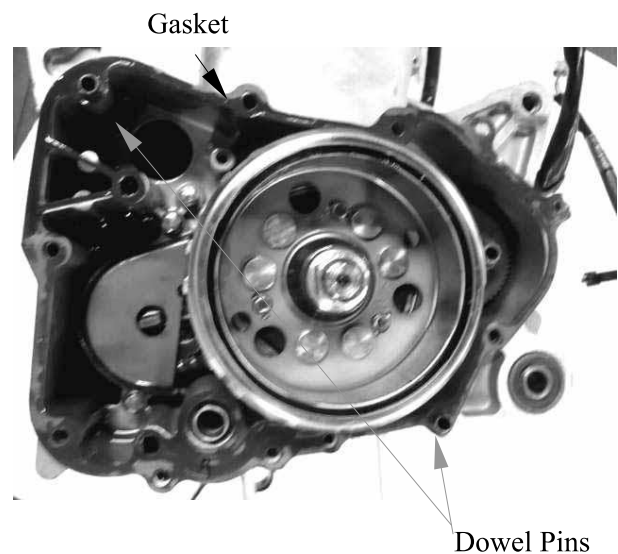
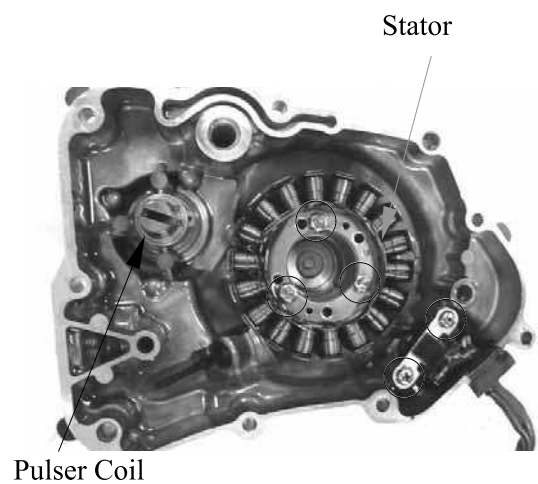

10. A.C. GENERATOR/STARTER CLUTCH

Install the dowel pins and gasket.

Install the right crankcase cover and tighten the bolts in a crisscross pattern in 2 or 3 steps.

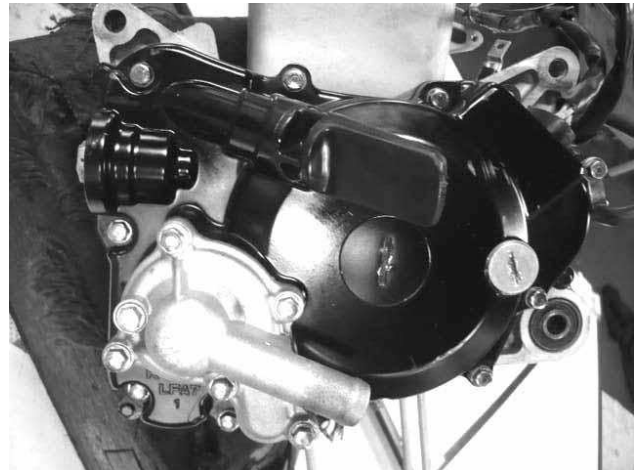

10. A.C. GENERATOR/STARTER CLUTCH

STARTER CLUTCH

REMOVAL

Remove the right crankcase cover

Hold the flywheel with a special tool and remove the flywheel nut.

Special tool:

Flywheel holder A120E00021

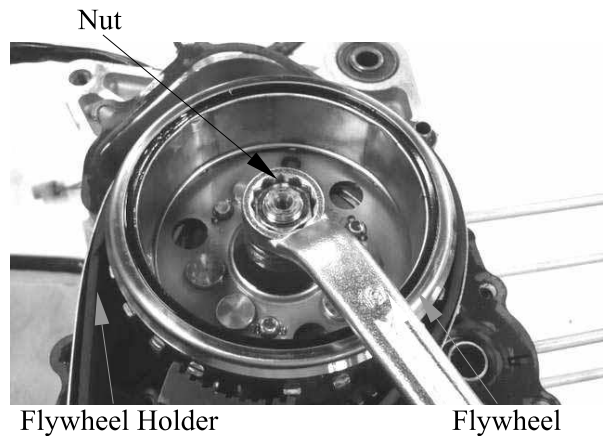

Remove the flywheel by using the special tool.

Special tool:

Flywheel puller A120E00003

Flywheel Puller



Remove the reduction gear shaft and reduction gear.

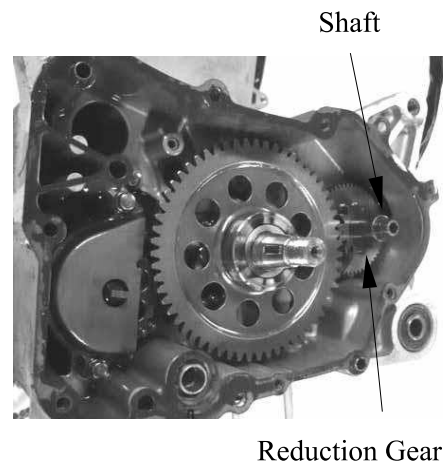

10. A.C. GENERATOR/STARTER CLUTCH

Remove the starter driven gear.



INSPECTION

Install the driven gear into the flywheel.

Check the operation of the sprag clutch by turning the driven gear. You should be able to turn the driven gear clockwise smoothly, but the gear should not turn counterclockwise.

Remove the starter driven gear by turning the driven gear.

Check the starter driven gear teeth for wear or damage.

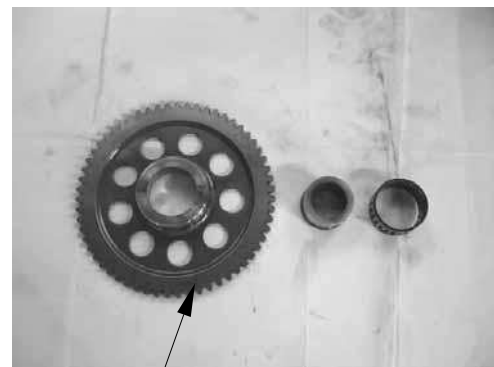

Starter Driven Gear

Check the starter reduction gear teeth and shaft for wear or damage.

Starter Idle Gear

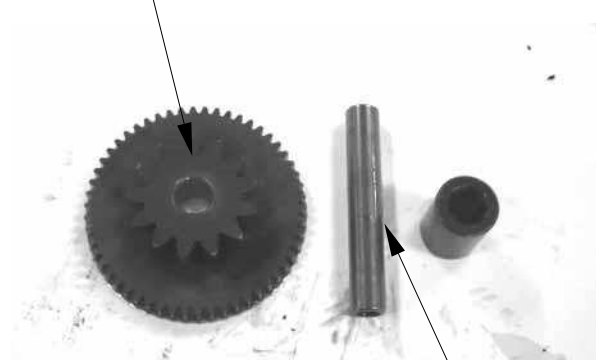

Shaft

10. A.C. GENERATOR/STARTER CLUTCH

INSTALLATION

Install the starter driven gear onto the crankshaft.



Apply oil to the starter reduction gear shaft. Install the starter reduction gear and shaft to the right crankcase.

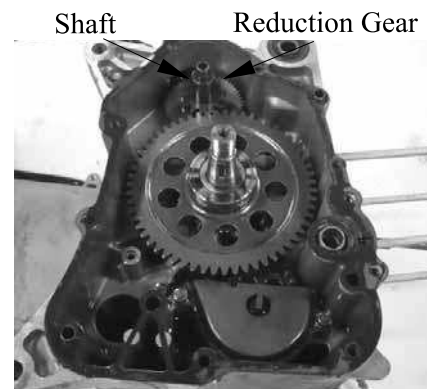

Install the flywheel onto the crankshaft by aligning the key on the crankshaft with the groove in the flywheel.

Before installation, check and make sure that the inside the flywheel is not contaminated.

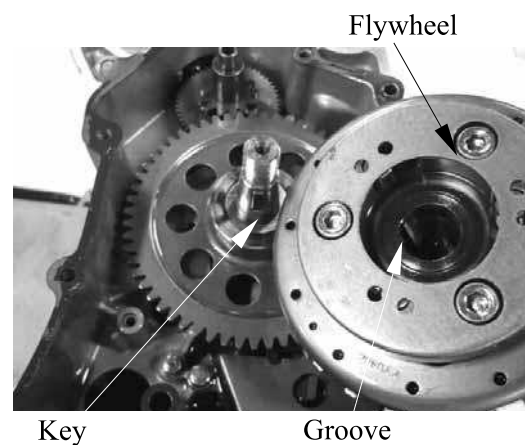

10. A.C. GENERATOR/STARTER CLUTCH

Hold the flywheel with the special tool and tighten the flywheel nut.

Torque: 5.0~6.0 kgf-m

Special tool:

Flywheel holder A120E00021

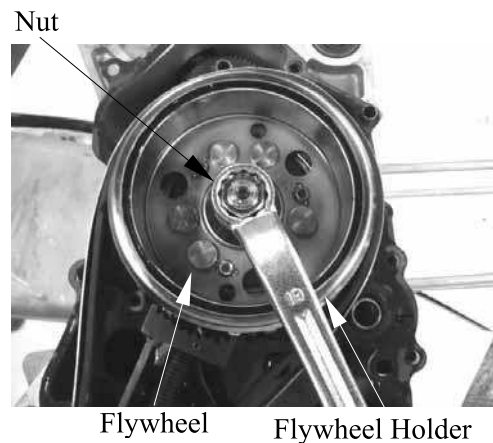

Install the dowel pins and gasket.

Install the right crankcase cover and tighten the bolts in a crisscross pattern in 2 or 3 steps.



11. CRANKCASE/CRANKSHAFT

CRANKCASE/CRANKSHAFT

SCHEMATIC DRAWING -----	11-1
SERVICE INFORMATION-----	11-2
TROUBLESHOOTING-----	11-2
CRANKCASE SEPARATION -----	11-3
CRANKCASE ASSEMBLY -----	11-4

11. CRANKCASE/CRANKSHAFT

DOWNTOWN 125i

SCHEMATIC DRAWING

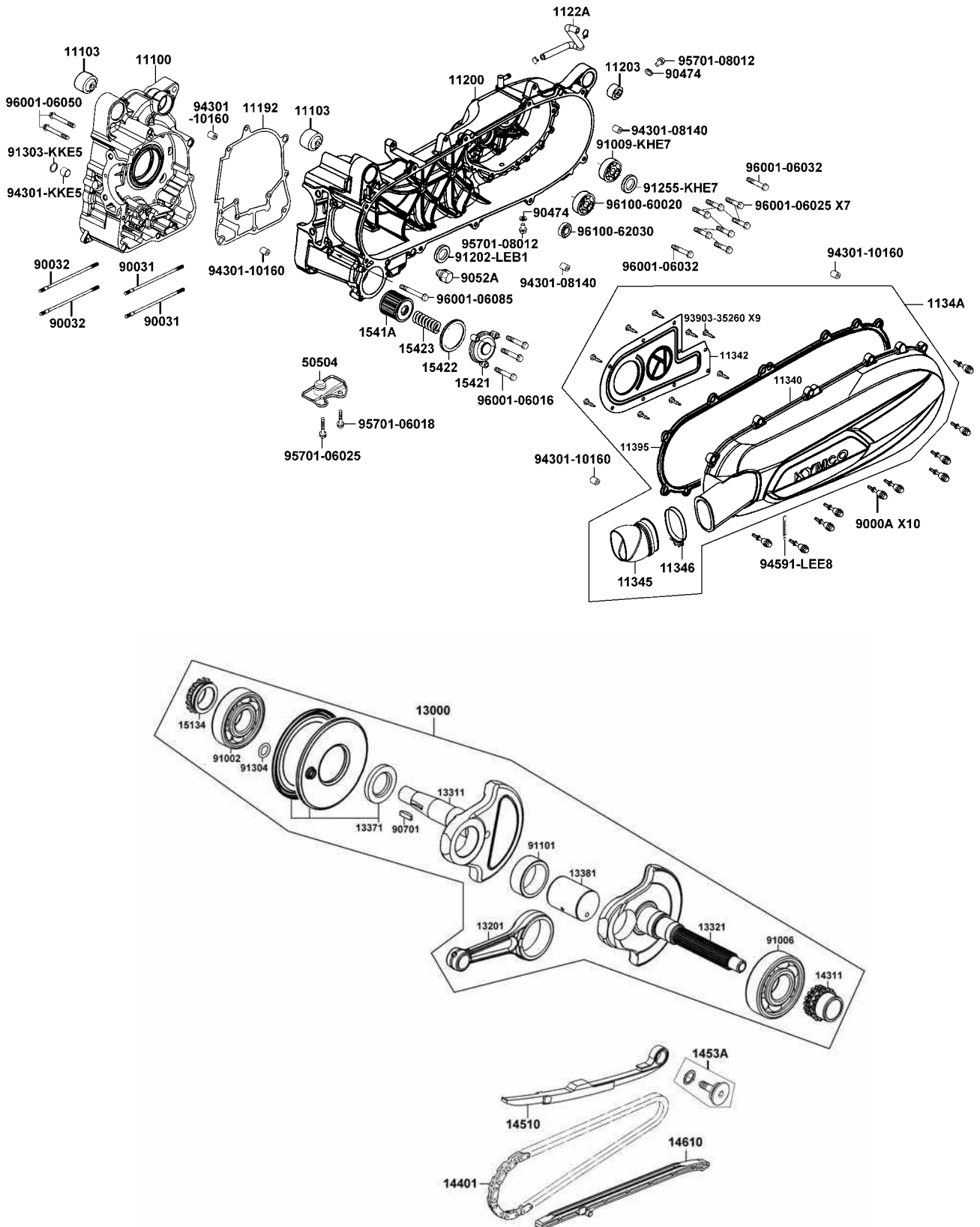

11. CRANKCASE/CRANKSHAFT

SERVICE INFORMATION

GENERAL INSTRUCTIONS

- This section covers crankcase separation to service the crankshaft. The engine must be removed for this operation.
- When separating the crankcase, never use a driver to pry the crankcase mating surfaces apart forcibly to prevent damaging the mating surfaces.
- When installing the crankcase, do not use an iron hammer to tap it.
- The following parts must be removed before separating the crankcase.
 - Cylinder head
 - Cylinder/piston
 - Drive and driven pulley
 - A.C. generator/starter clutch
 - Rear wheel/rear shock absorber
 - Starter motor
 - Oil pump

SPECIFICATIONS

Unit: mm

	Item	Standard
Crankshaft	Connecting rod big end side clearance	0.15~0.35
	Connecting rod big end radial clearance	0~0.008

TORQUE VALUES

Crankcase bolt	1.0 kgf-m
Cam chain tensioner slipper bolt	1.0 kgf-m

TROUBLESHOOTING

Excessive engine noise

- Excessive bearing play
- Excessive crankpin bearing play
- Worn piston pin and piston pin hole

11. CRANKCASE/CRANKSHAFT

CRANKCASE SEPARATION

Remove the two right crankcase attaching bolts.

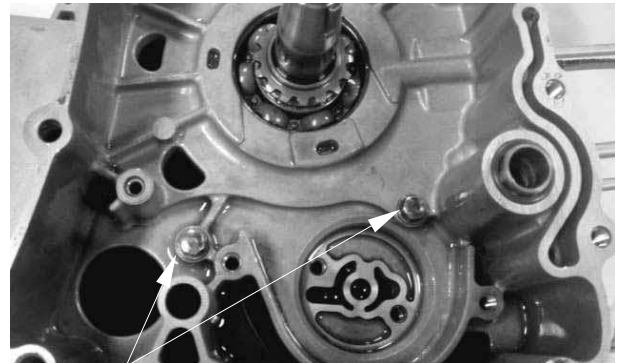

Bolt

Remove the left crankcase bolts.

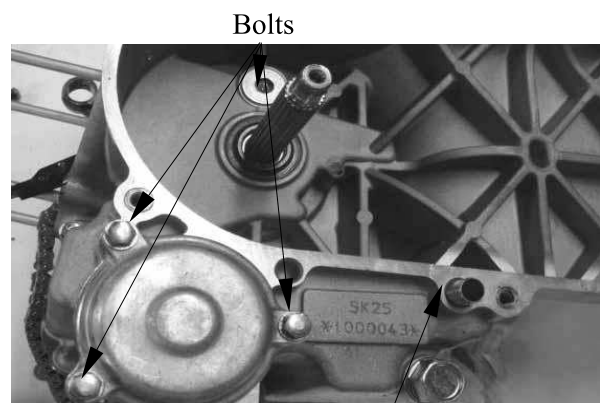

Bolts

Left Crankcase

Place the crankcase with the left crankcase down and remove the right crankcase from the left crankcase.

* Never use a driver to pry the crankcase mating surfaces apart.

Remove the gasket and dowel pins.



Right Crankcase

Left Crankcase

Remove the crankshaft from the left crankcase.

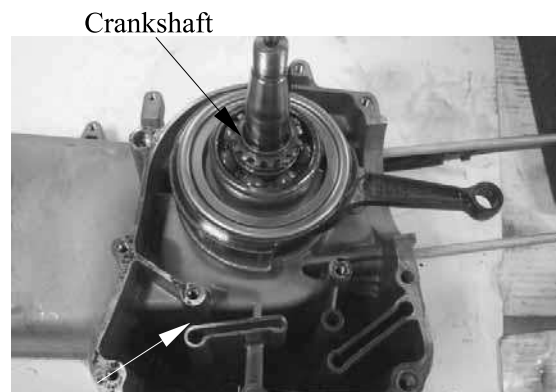

Crankshaft

Left Crankcase

11. CRANKCASE/CRANKSHAFT

Remove the oil seal from the left crankcase.



Left Crankcase

CRANKCASE ASSEMBLY

Clean off all gasket material from the crankcase mating surfaces.

- * Avoid damaging the crankcase mating surfaces.



Install a new oil seal into the left crankcase.

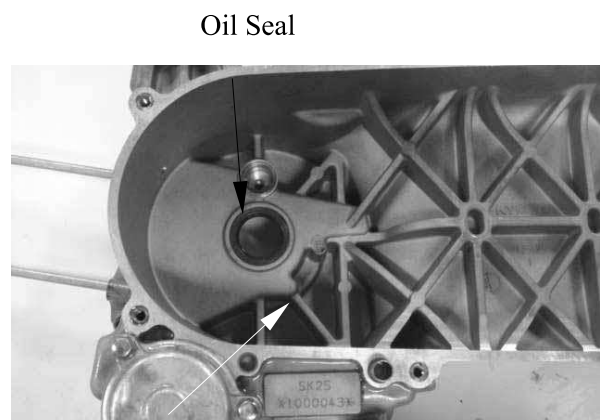

Left Crankcase

11. CRANKCASE/CRANKSHAFT

Place the left crankcase down and install the crankshaft into the left crankcase.

- *
 - Avoid damaging the oil seal.
 - Apply grease to the lip of the oil seal.



Change a new gasket.

Place into the crankshaft and onto the left crankcase.

- *
 - Install the right crankcase squarely and do not tap it with an iron or plastic hammer.

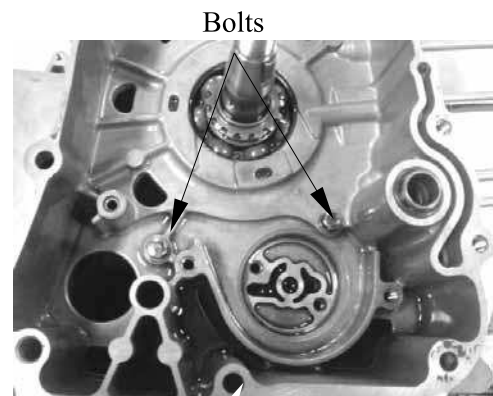

Install and tighten the right and left crankcase attaching bolts.

Torque: 1 kgf-m

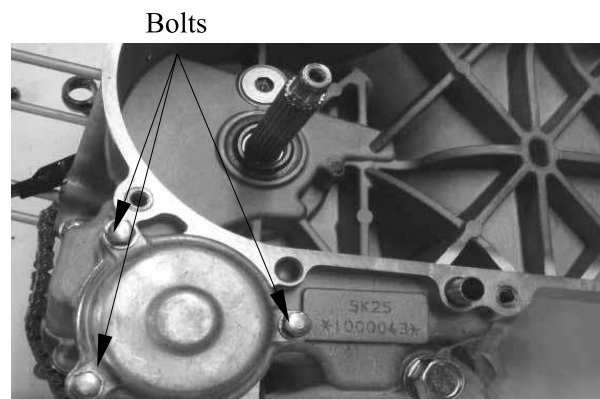

11. CRANKCASE/CRANKSHAFT

Install the cam chain.
Install the cam chain tensioner slipper.
Install and tighten the cam chain tensioner slipper bolt.

Torque: 1.0kgf-m

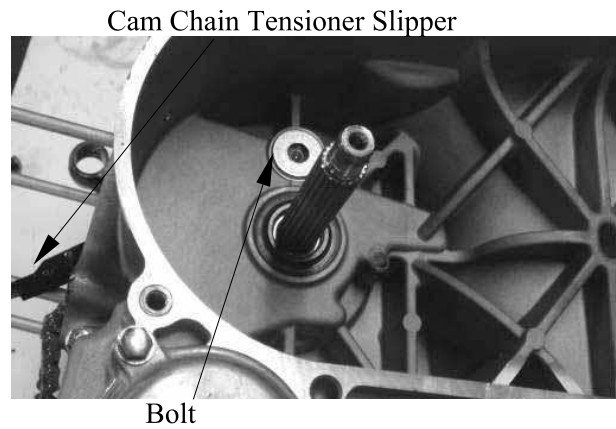

12. COOLING SYSTEM

COOLING SYSTEM

SERVICE INFORMATION-----	12- 1
TROUBLESHOOTING-----	12- 1
COOLING SYSTEM TESTING-----	12- 3
COOLANT REPLACEMENT -----	12- 4
RADIATOR -----	12- 7
FAN MOTOR -----	12- 9
FAN MOTOR SWITCH -----	12-10
WATER PUMP -----	12-11
WATER TEMPERATURE SENSOR -----	12-16
THERMOSTAT-----	12-18

12. COOLING SYSTEM

SERVICE INFORMATION

GENERAL INSTRUCTIONS

- The water pump must be serviced after removing the engine. Other cooling system service can be done with the engine installed in the frame.
- The engine must be cool before servicing the cooling system.
When the coolant temperature is over 100 °C, never remove the radiator cap to release the pressure because the boiling coolant may cause danger.
- Avoid spilling coolant on painted surfaces because the coolant will corrode the painted surfaces. Wash off any spilled coolant with fresh water as soon as possible.
- After servicing the system, check for leaks with a cooling system tester.

SPECIAL TOOL

Mechanical seal driver

TORQUE VALUES

Water pump impeller	1.2 kgf-m (12 N-m, 9 lbf-ft)	Left hand threads
Water pump cover bolt	1.0 kgf-m (10 N-m, 7 lbf-ft)	

TROUBLESHOOTING

Engine temperature too high

- Faulty temperature gauge or thermosensor
- Faulty radiator cap
- Faulty thermostat
- Insufficient coolant
- Passages blocked in hoses or water jacket
- Clogged radiator fins
- Passages blocked in radiator
- Faulty water pump

Coolant leaks

- Faulty pump mechanical (water) seal
- Deteriorated O-rings
- Damaged or deteriorated water hoses

Temperature gauge pointer does not register the correct coolant temperature

- Faulty temperature gauge or thermosensor
- Faulty thermostat

12. COOLING SYSTEM

Downtown 125 i

SPECIFICATIONS

Radiator cap relief pressure		90 kPa (0.9 kgf/cm ² , 12.8 psi)
Thermostat temperature	Begins to open	80 - 82°C (176 - 180°F)
	Full-open	90°C (198°F)
	Valve lift	3.5 mm (0.14 in) minimum
Coolant capacity	Radiator and engine	0.87 liter
	Reserve tank	0.49 liter
Standard coolant concentration		1:1 mixture with soft water

COOLANT GRAVITY

Temp. Coolant concentration	0	5	10	15	20	25	30	35	40	45	50
5%	1.009	1.009	1.008	1.008	1.007	1.006	1.005	1.003	1.001	0.009	0.997
10%	1.018	1.107	1.017	1.016	1.015	1.014	0.013	1.011	1.009	1.007	1.005
15%	1.028	1.027	1.026	1.025	1.024	1.022	1.020	1.018	1.016	1.014	1.012
20%	1.036	1.035	1.034	1.033	1.031	1.029	1.027	1.025	1.023	1.021	1.019
25%	1.045	1.044	1.043	1.042	1.040	1.038	1.036	1.034	1.031	1.028	1.025
30%	1.053	1.051	1.051	1.049	1.047	1.045	1.043	1.041	1.038	1.035	1.032
35%	1.063	1.062	1.060	1.058	1.056	1.054	1.052	1.049	1.046	1.043	1.040
40%	1.072	1.070	1.068	1.066	1.064	1.062	1.059	1.056	1.053	1.050	1.047
45%	1.080	1.078	1.076	1.074	1.072	1.069	1.056	1.063	1.062	1.057	1.054
50%	1.086	1.084	1.082	1.080	1.077	1.074	1.071	1.068	1.065	1.062	1.059
55%	1.095	1.093	1.091	1.088	1.085	1.082	1.079	1.076	1.073	1.070	1.067
60%	1.100	1.098	1.095	1.092	1.089	1.086	1.083	1.080	1.077	1.074	1.071

COOLANT MIXTURE (WITH ANTI-RUST AND ANTI-FREEZING EFFECTS)

Freezing Point	Mixing Rate	KYMCO SIGMA Coolant Concentrate	Distilled Water
-9	20%		
-15	30%		
-25	40%		
-37	50%		
-44.5	55%		

Cautions for Using Coolant:

- Use coolant of specified mixing rate.
- Do not mix coolant concentrate of different brands.
- Do not drink the coolant which is poisonous.
- The freezing point of coolant mixture shall be 5 lower than the freezing point of the riding area.

12. COOLING SYSTEM

COOLING SYSTEM TESTING

RADIATOR CAP INSPECTION

Removing the radiator cap while the engine is hot can cause the coolant to spray out, seriously scalding you.

Always let the engine and radiator cool down before removing the radiator cap.

Remove the radiator cap (1).

Pressure test should be served on the radiator cap.

Replace the radiator cap if it does not hold pressure, or if relief pressure is too high or too low.

It must hold the specified pressure for at least six seconds.

Before installing the cap in the tester, wet the sealing surface.

Radiator Cap Relief Pressure:

90 kPa (0.9 kg/cm², 12.8 psi)

Pressurize the radiator, engine and hoses, and check for leaks.

Excessive pressure can damage the cooling system components.

Do not exceed 105 kPa (1.05 kg/cm², 14.9 psi).

Repair or replace components if the system will not hold the specified pressure for at least six seconds.



(1)

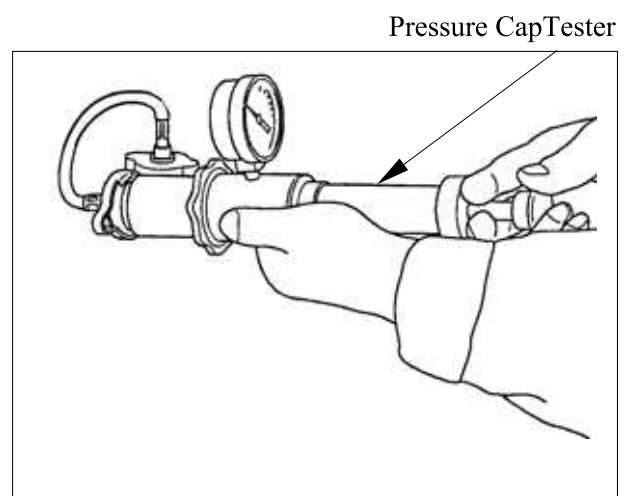
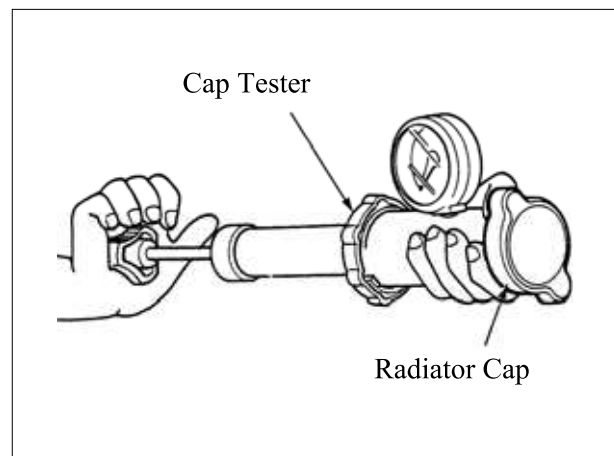

12. COOLING SYSTEM

Downtown 125 i

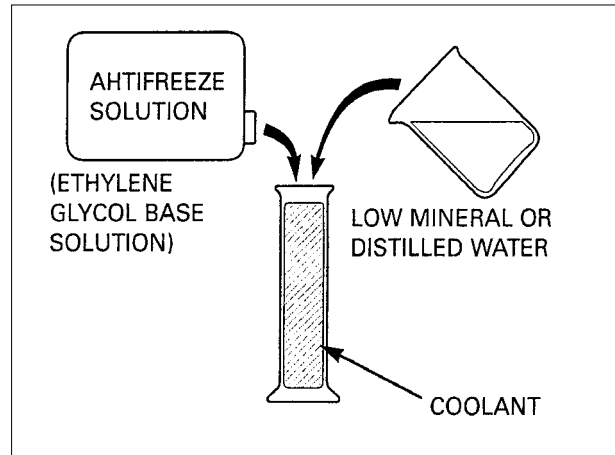

(1)



(2)

12. COOLING SYSTEM

Remove the screw (3) and reserve tank lid (4).

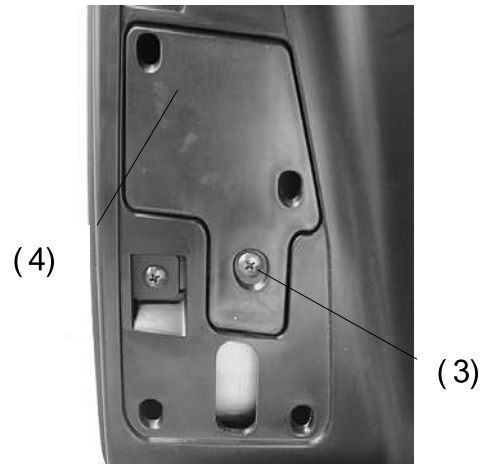

Remove the reserve tank cap (5) and drain the coolant from the reserve tank.

Reinstall and tighten the drain bolt securely.

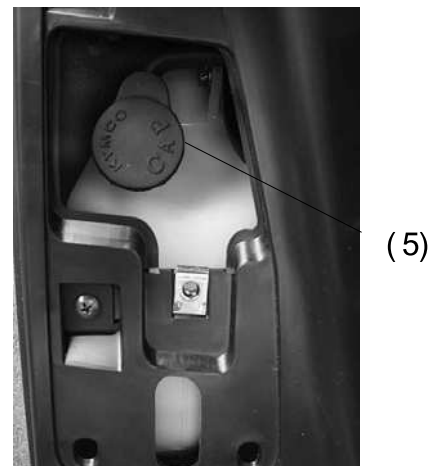

Fill the reserve tank to the upper level line (6).



12. COOLING SYSTEM

Fill the system with the recommended coolant through the filler opening up to the filler neck (1).

Bleed air from the system as follow:

1. Start the engine and let it idle for 2–3 minutes.
2. Snap the throttle three to four times to bleed air from the system.
3. Stop the engine and add coolant to the proper level if necessary. Reinstall the radiator cap.
4. Check the level of coolant in the reserve tank and fill to the upper level if it is low.



(1)

12. COOLING SYSTEM

Downtown 125 i

RADIATOR

REMOVAL

Drain the coolant.

Disconnect the siphon hose (1) and air bleed hose (2).

Remove the nut(3).

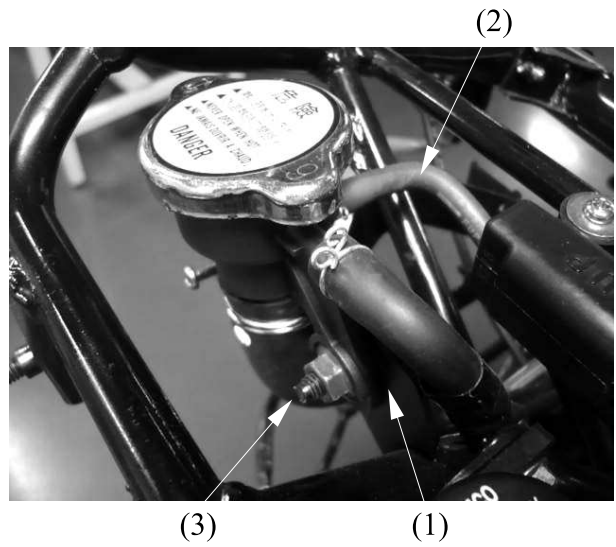

Loosen the hose bands, then disconnect the input radiator hose (4) and output radiator hose (5) from the radiator.

Disconnect the thermal switch connectors (6).

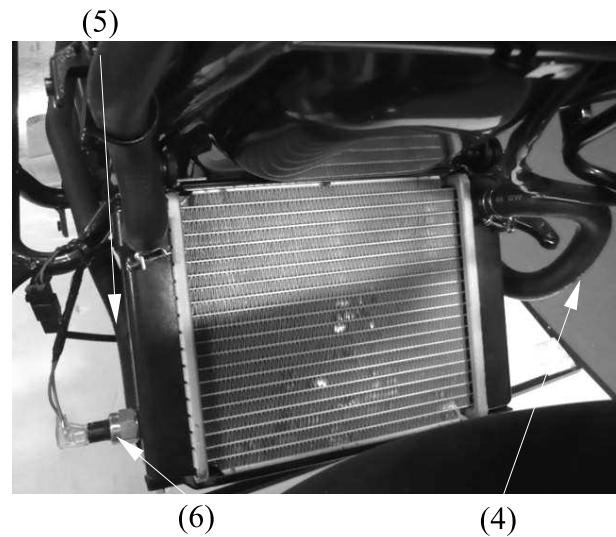

. Disconnect the fan motor connector (7)

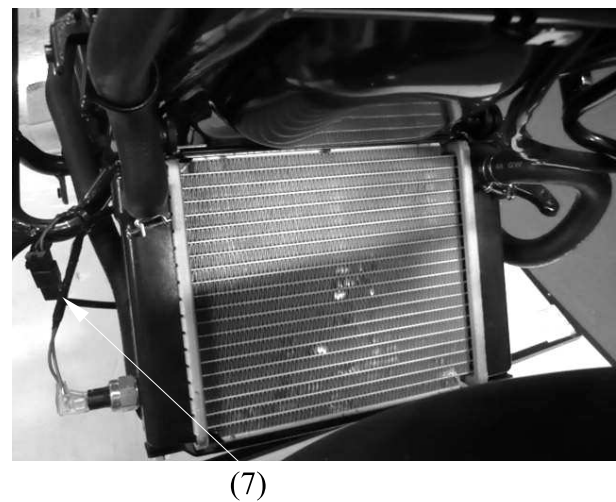

12. COOLING SYSTEM

Remove three nuts (10) and then remove the radiator from frame.

INSTALLATION

Installation is in the reverse order of removal.

Refill the coolant

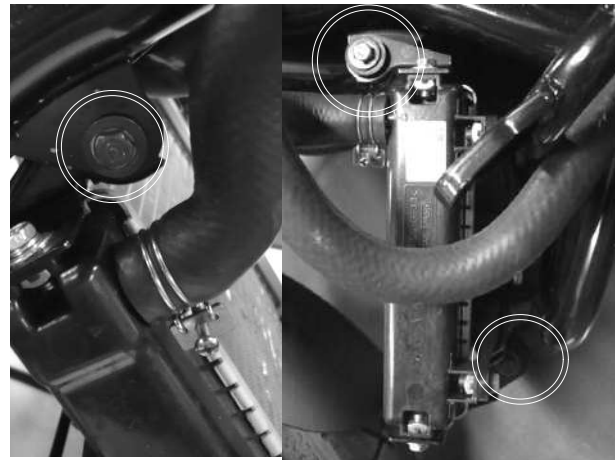

(10)

12. COOLING SYSTEM

FAN MOTOR

REMOVAL

Remove the radiator
Remove the three mounting bolts (1) and
then remove the fan motor (2)

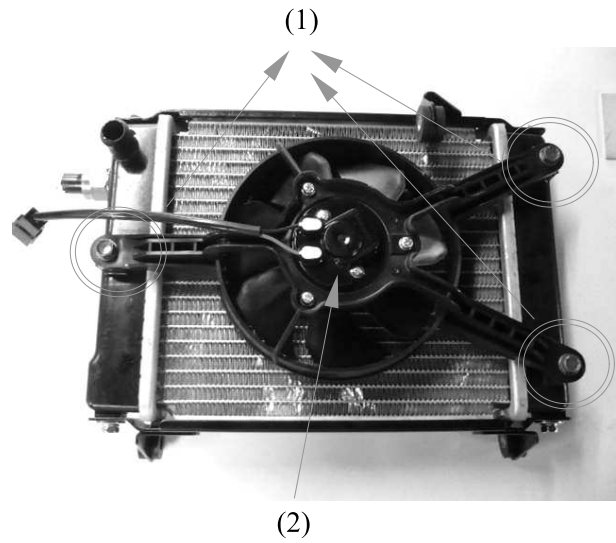

INSPECTION

Check the fan motor to operate using an
available battery.

INSTALLATION

Installation is in the reverse order of
removal.

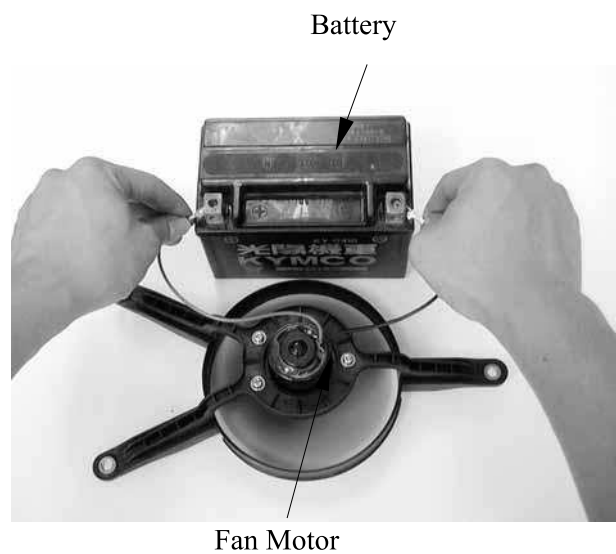

12. COOLING SYSTEM

Downtown 125 i

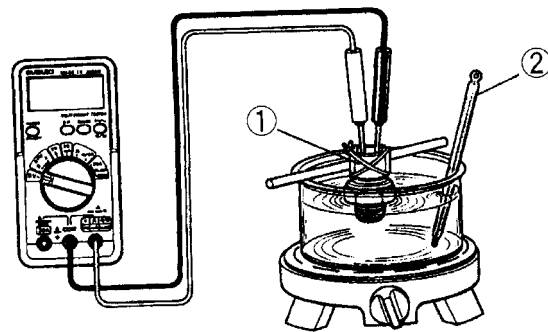
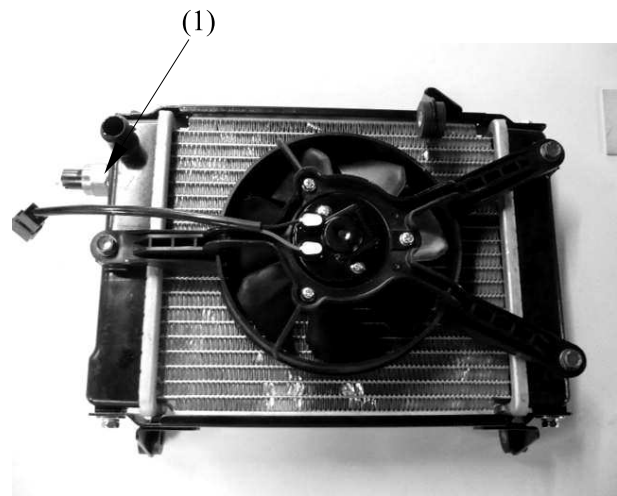

- Replace the O-ring a new one.
- Do not use grease to the O-ring.

12. COOLING SYSTEM

WATER PUMP

MECHANICAL SEAL (WATER SEAL) INSPECTION

Inspect the telltale hole for signs of mechanical seal coolant leakage. If the mechanical seal is leaking, remove the right crankcase cover and replace the mechanical seal.

Right Crankcase Cover



Water Pump

WATER PUMP/IMPELLER REMOVAL

Drain the coolant .

Remove the coolant inlet hose and outlet hose.

Outlet Hose

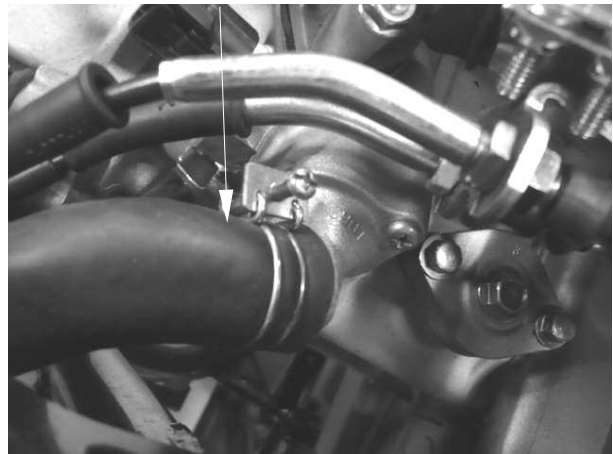

Inlet Hose

12. COOLING SYSTEM

Remove four bolts and the water pump cover, gasket and two dowel pins.

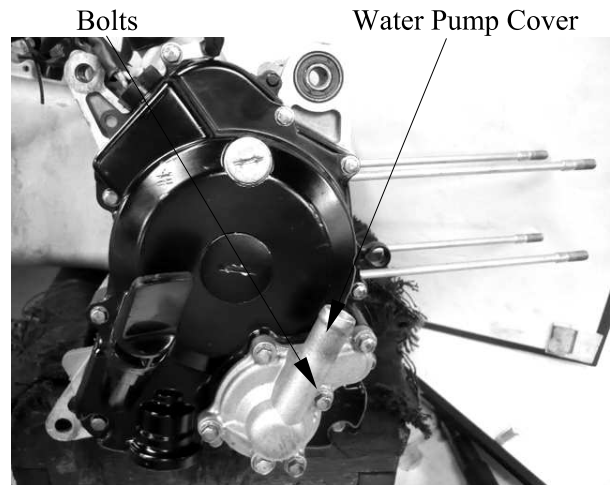

Remove the water pump impeller.

The impeller has left hand threads.

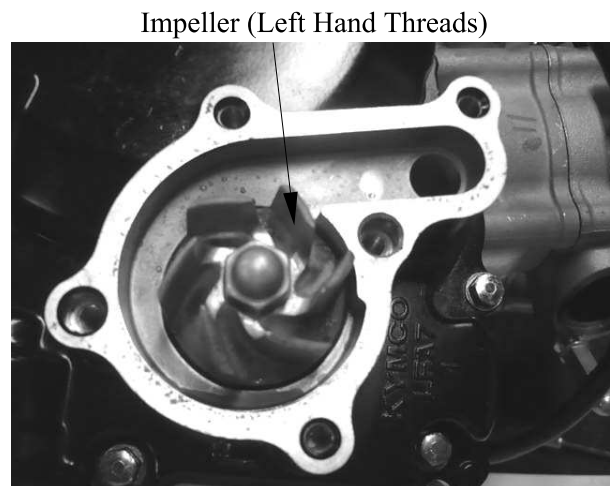

Inspect the mechanical (water) seal and seal washer for wear or damage.

The mechanical seal and seal washer must be replaced as a set.

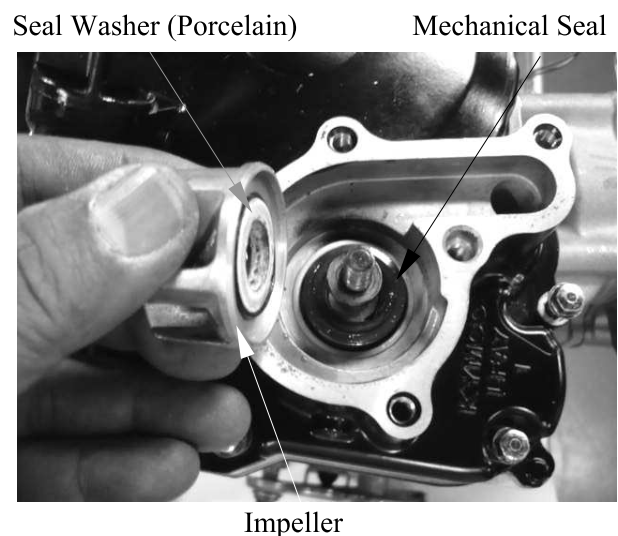

12. COOLING SYSTEM

WATER PUMP SHAFT REMOVAL

Disconnect the water hose from the right crankcase cover.
Remove five bolts attaching the water pump assembly.
Remove the water pump assembly, gasket and dowel pins.



Remove the water pump shaft clip and water pump shaft



12. COOLING SYSTEM

Install the dowel pins and a new gasket and then install the water pump assembly to the right crankcase cover.
Tighten five bolts to secure the water pump assembly.

When installing the water pump assembly, aligning the groove on the water pump shaft with the tab on the oil pump shaft.

Water Pump Assembly



WATER PUMP/IMPELLER INSTALLATION

When the mechanical seal is replaced, a new seal washer must be installed to the impeller.

Seal Washer (Porcelain)

Mechanical Seal

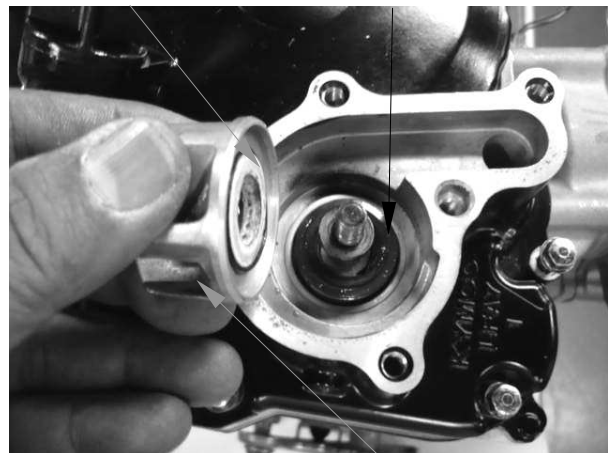

Impeller

12. COOLING SYSTEM

Install the impeller onto the water pump shaft.

Torque: 1.2 kgf-m (12 N-m, 9 lbf-ft)

The impeller is with left hand threads.

Impeller (Left Hand Threads)

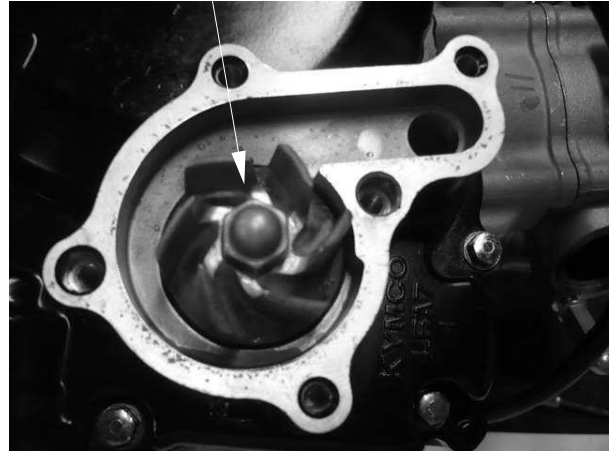

Install two dowel pins and a new gasket.

Dowel Pins

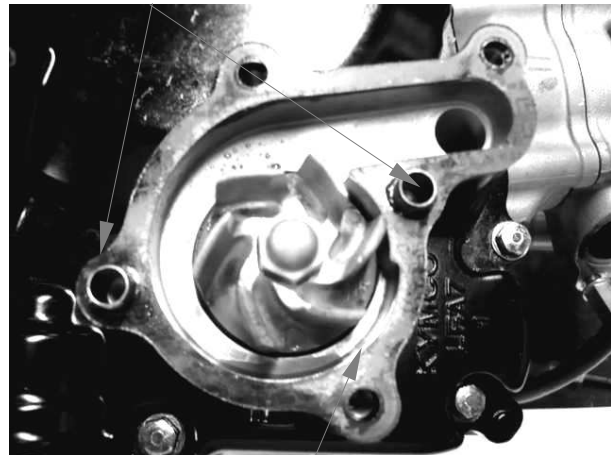

Gasket

Install the water pump cover and tighten the 4 bolts.

Torque: 1 kgf-m (10 N-m, 7 lbf-ft)

Water Pump Cover



Bolt

12. COOLING SYSTEM

WATER TEMPERATURE SENSOR

REMOVAL

Remove the luggage box

Drain the coolant

Disconnect the water temperature sensor connectors (1).

Remove the water temperature sensor (2) from thermostat.

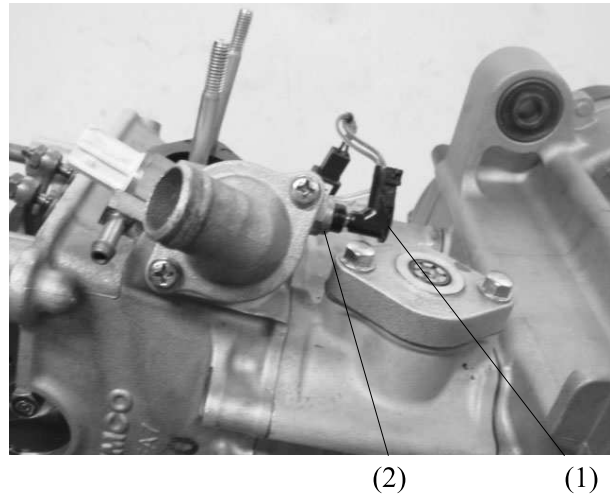

(2)

(1)

INSPECTION

Connect the water temperature sensor to the ohmmeter and dip it in water contained in a pan which is placed on an electric heater.

Gradually raise oil temperature while reading the thermometer in the pan and the ohmmeter connected. If the resistance measured is out of specification, replace the temperature gauge with a new one.

Temperature	Standard resistance
50°C	133.9– 178.9 Ω
100°C	26– 29.3 Ω

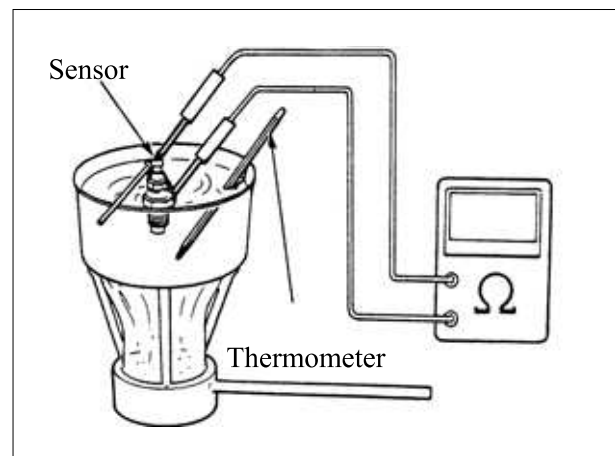

- Handle the water temperature sensor carefully as it is vulnerable to impact.
- Do not allow the water temperature sensor and the thermometer to come in contact with the bottom of the pan.

12. COOLING SYSTEM

INSTALLATION

Tighten the water temperature sensor.

Torque: 0.8 kgf-m (8 N-m, 5.8 lbf-ft)

Connect the sensor connectors.

After the water temperature sensor has been installed, fill coolant and perform air bleeding .

12. COOLING SYSTEM

THERMOSTAT

THERMOSTAT REMOVAL

REMOVAL

Drain the coolant

Remove the luggage box

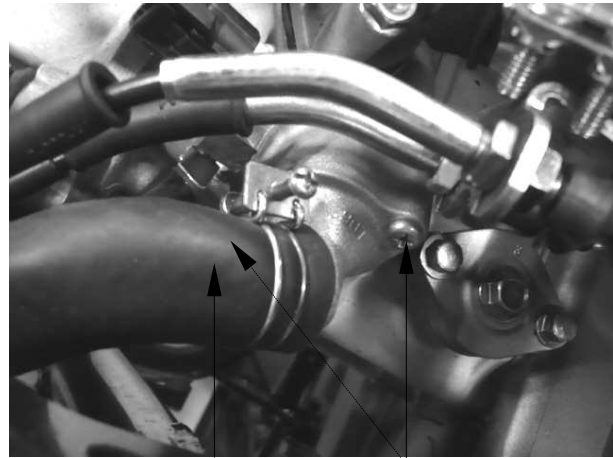

(1)

Bolts

Disconnect the water hose (1) from the thermostat housing.

Remove the mounting bolt (2) and the thermostat housing attaching the cylinder head.

INSTALLATION

The installation sequence is the reverse of removal.

After the water thermostat has been installed, fill coolant and perform air bleeding .

12. COOLING SYSTEM

DISASSEMBLY

Remove two screws and separate the thermostat housing halves.

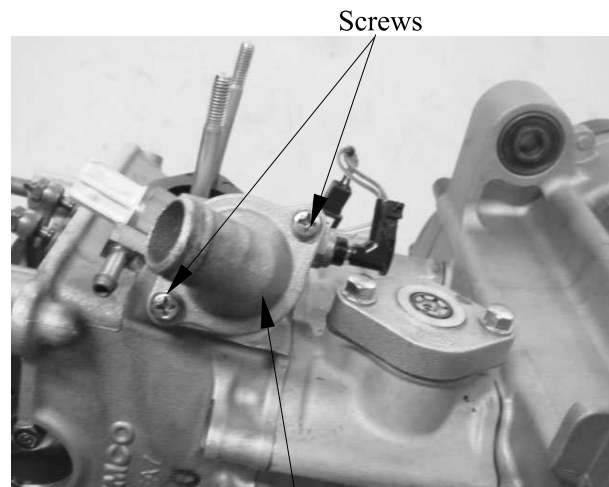

Thermostat

Remove the thermostat from the thermostat housing.

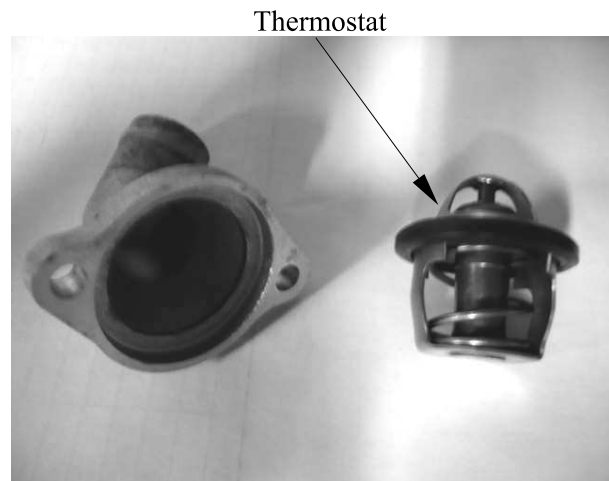

Thermostat

12. COOLING SYSTEM

Downtown 125 i

INSPECTION

Suspend the thermostat in a pan of water over a burner and gradually raise the water temperature to check its operation.

Technical Data

Begins to open	71 ± 1.5°C
Full-open	80°C
Valve lift	3.5 mm (0.14 in) minimum

- Do not let the thermostat touch the pan as it will give a false reading.
- Replace the thermostat if the valve stays open at room temperature.
- Test the thermostat after it is opened for about 5 minutes and holds the temperature at 70 .

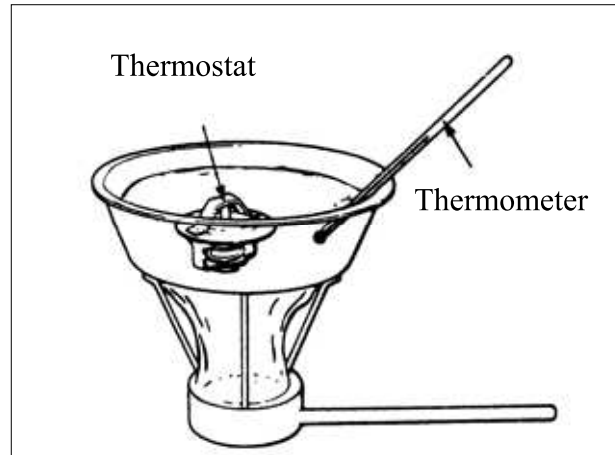

ASSEMBLY

Thermostat assembly is in the reverse order of disassembly.



Thermostat Housing

Fi Diagnostic Tool Operation Instructions Part No. 3620A-LEB2-E00

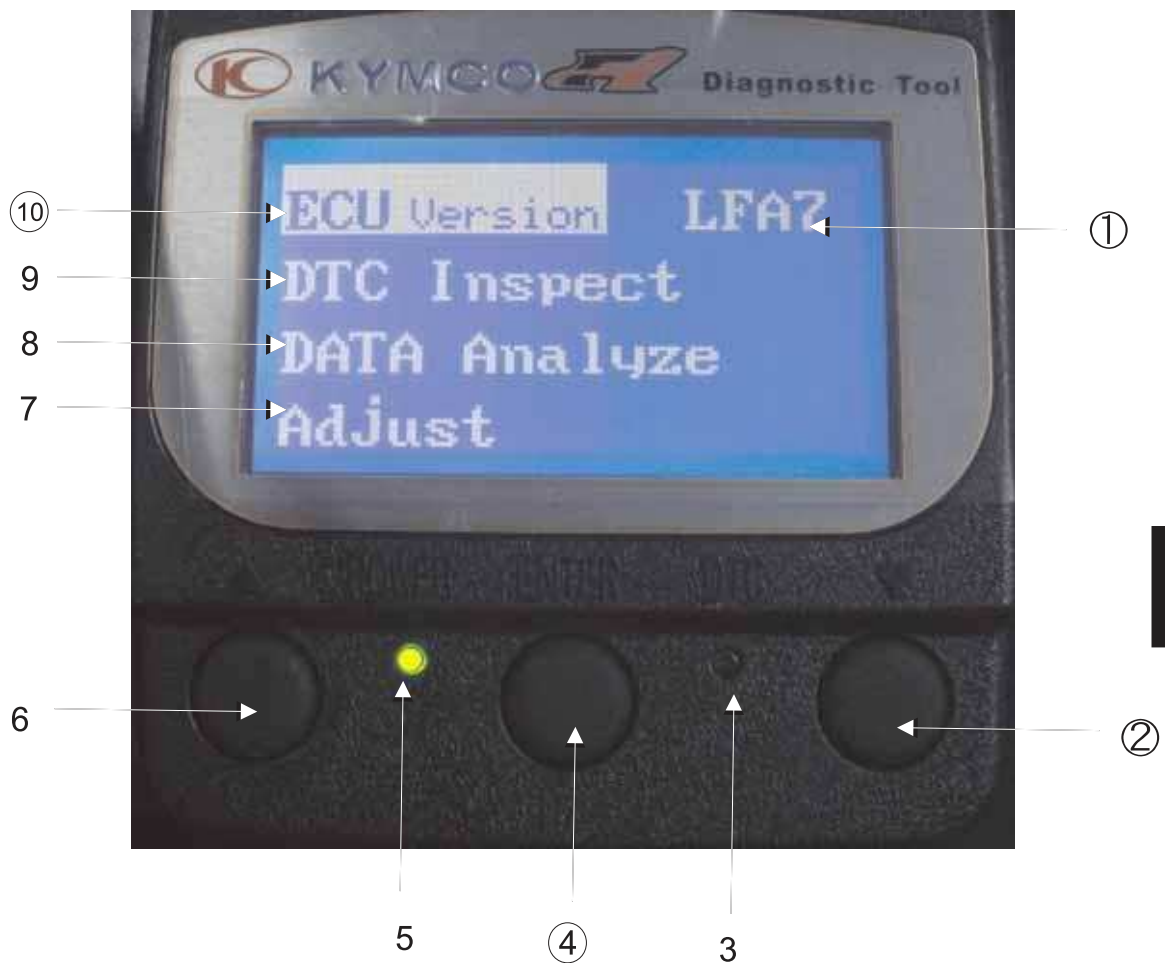

13

KEY FUNCTION

- | | |
|--------------------------------------|---------------|
| 1 Model No. | 8 DATAAnalyze |
| 2 Down Button | 9 DTC Inspect |
| 3 DTC indicator(Failure codes) | ⑩ ECU Version |
| ④ Enter or Exit | |
| 5 Power indicator | |
| 6 UP Button | |
| 7 Adjust(TPI and ABV reset function) | |

13. Fi DIAGNOSTIC TOOL OPERATION DOWN TOWN 125i

Fi diagnostic tool Outlook.....	13-0	Adjust.....	13-8
DTC Inspection Precedure	13-2	Diagnostic Standard Specifications	13-9
DTC Clear Procedure	13-5		
Data Analysis.....	13-6		

13. Fi DIAGNOSTIC TOOL OPERATION DOWN TOWN 125i

DTC INSPECTION PROCEDURE

Connect Fi diagnostic tool with the connector of harness wire located beside the Battery.



Diagnostic Tool Connector

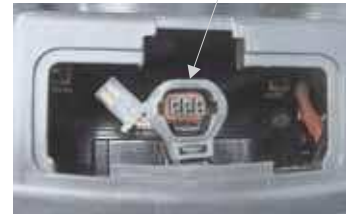

Press the "Enter" button

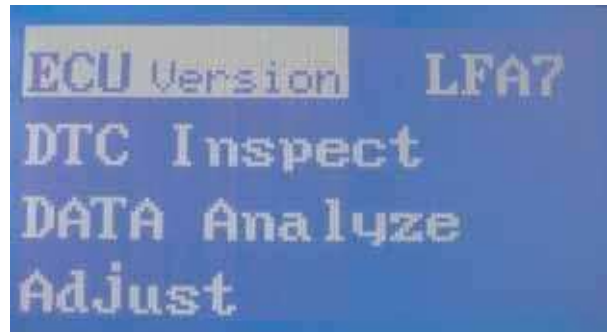

Check the software version

Press the "Enter" button and then turn to the first page.



Press the "Down" button to enter the DTC Inspect.

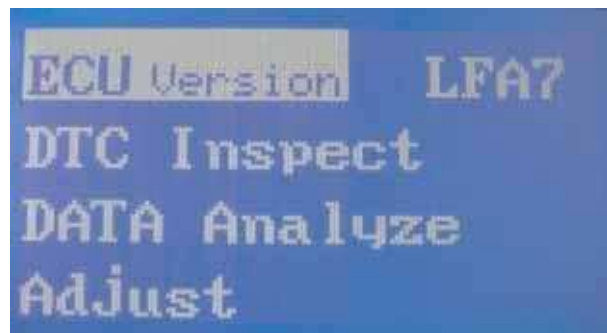

13. Fi DIAGNOSTIC TOOL OPERATION DOWN TOWN 125i

Press the " Enter " button to check the DTC number

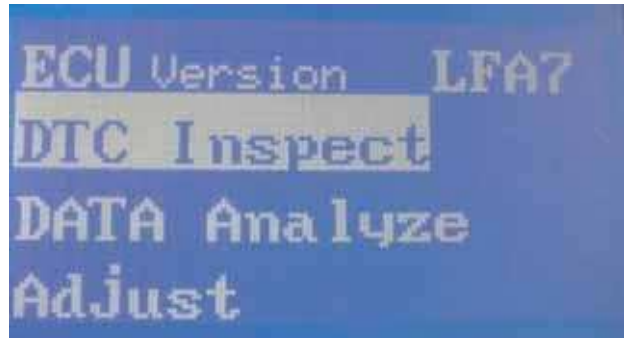

Press the " Enter " button

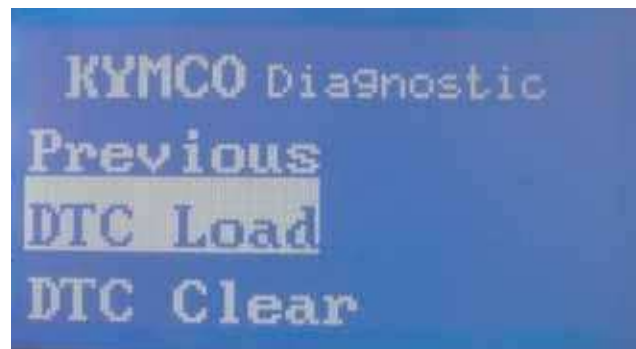

Press the " Enter " button

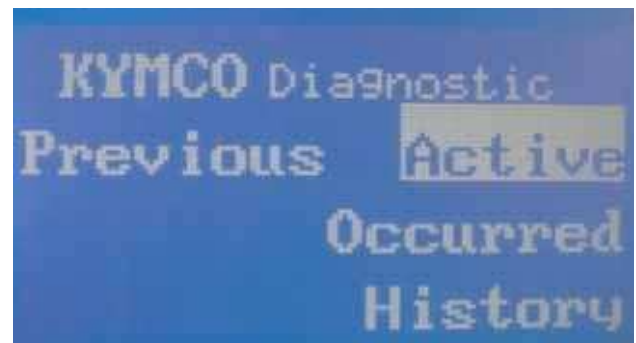

Display what's DTC number on this DTC-List.
 Refer to DTC summary list.

Press the " Enter " button and then turn to the
 previous page

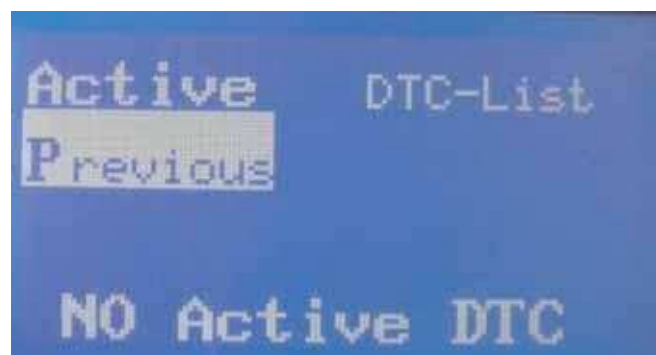

13. Fi DIAGNOSTIC TOOL OPERATION DOWN TOWN 125i

Press the "UP" button

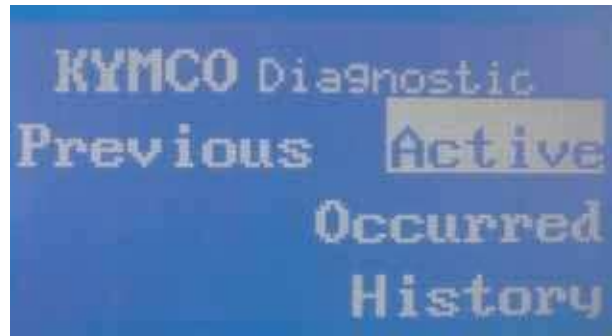

Press the "Enter" button and then turn to the previous page.

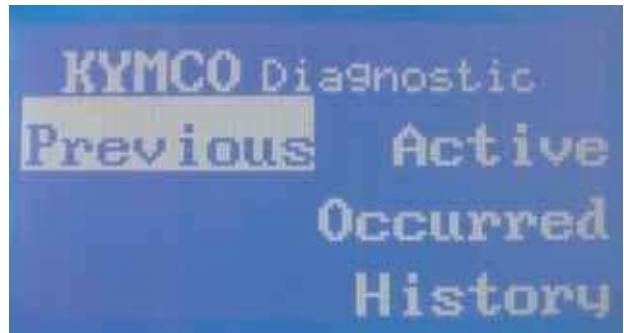

Press the "UP" button

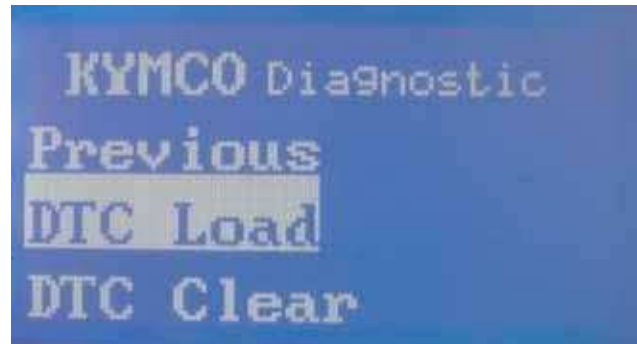

Press the "Enter" button and then turn to the first page.

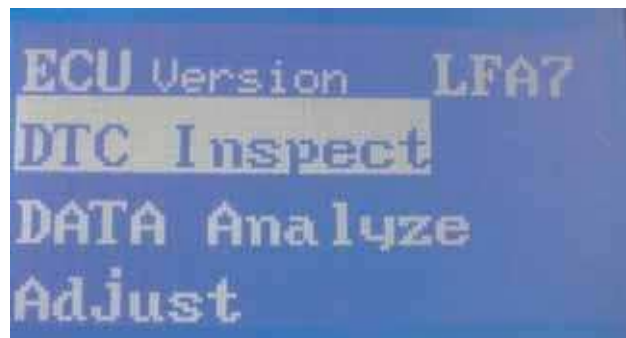

13. Fi DIAGNOSTIC TOOL OPERATION DOWN TOWN 125i

DTC CLEAR PROCEDURE

Choose "Load DTC"

Press the "Down" button

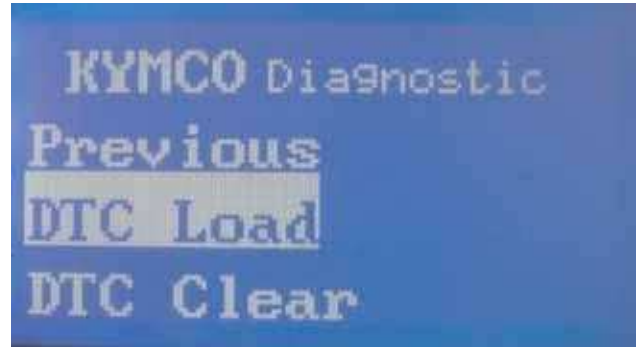

Press the "Enter" button

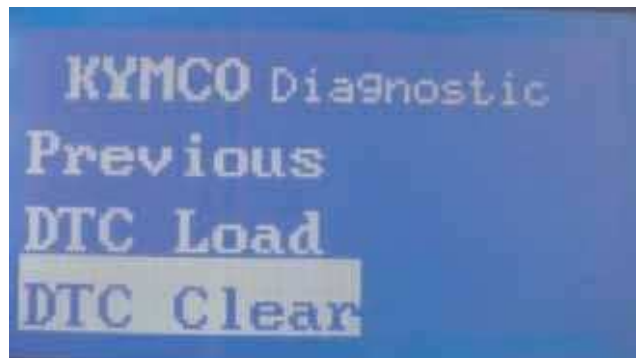

The DTC indicator is lighting at that time.



Clearing DTC completed until the DTC indicator is off.



13. Fi DIAGNOSTIC TOOL OPERATION DOWN TOWN 125i

DATA ANALYSIS

Choose "Data Analyze"

Press the "Enter" button to enter page 01.

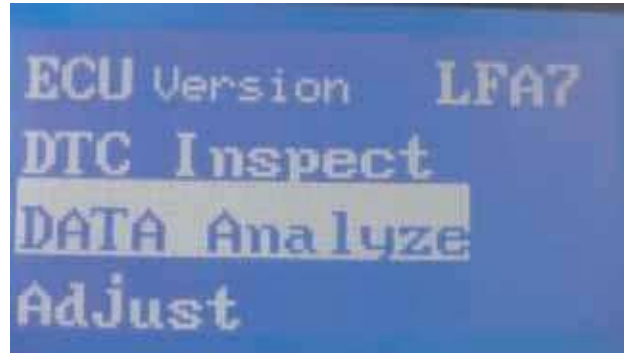

The figure includes engine speed, idle speed setpoint and battery voltage.

Refer to standard specifications.

Press the "Down" button to enter page 02.

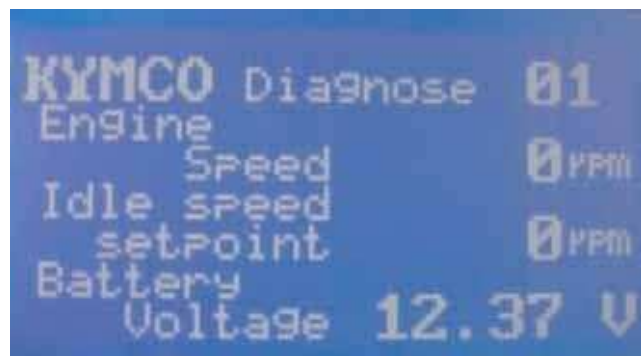

The figure includes TPS position, TPI idle adapted voltage and TPI WOT adapted (Throttle grip fully opened).

Refer to standard specifications.

Press the "Down" button to enter page 03.

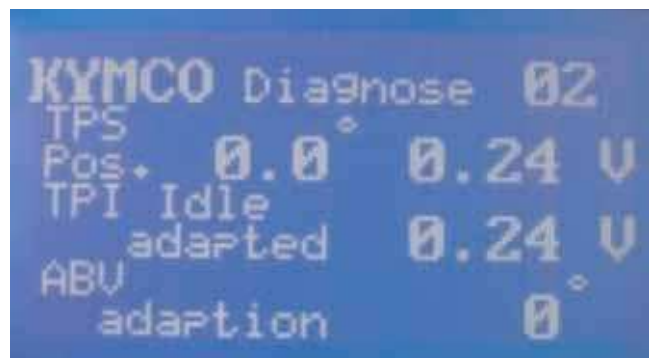

The figure includes engine working temperature, atmosphere pressure and Manifold pressure.

Refer to standard specifications on page 18-9.

Press the "Down" button to enter page 04.



13. Fi DIAGNOSTIC TOOL OPERATION DOWN TOWN 125i

The figure includes fuel injector interval, ignition advance angle and ABV angle.

Refer to standard specifications .

Press the " Down " button to enter page 05.

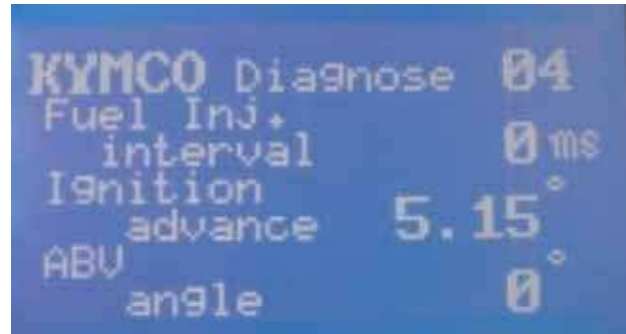

The figure includes O2 sensor voltage, O2 heater working condition and O2 correction.

Refer to standard specifications .

Press the " Down " button to enter page 06.



The figure includes rollover voltage .

Refer to standard specifications .

Press the " Down " button to enter page 07.



The figure includes ECU counter hours.

Press the " UP " button to the first page.

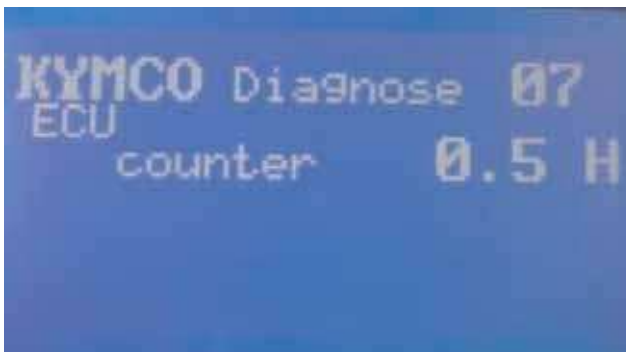

13. Fi DIAGNOSTIC TOOL OPERATION DOWN TOWN 125i

ADJUST

Need to make TPI/ABV reset to operate after changing new ECU and clean THROTTLE BODY and changing the engine department product, let ECU set up and set up initially

Choose "Adjust"

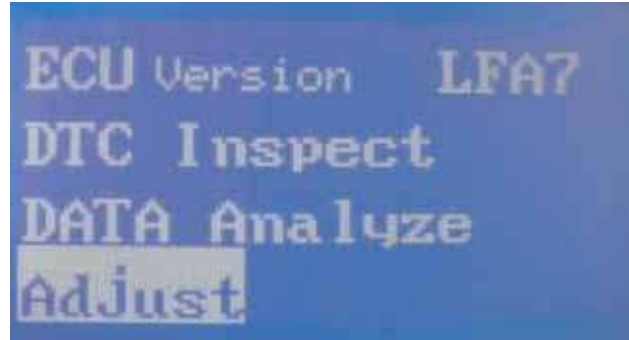

Press the "Enter" button to TPI/ABV Reset

Press the "Enter" button

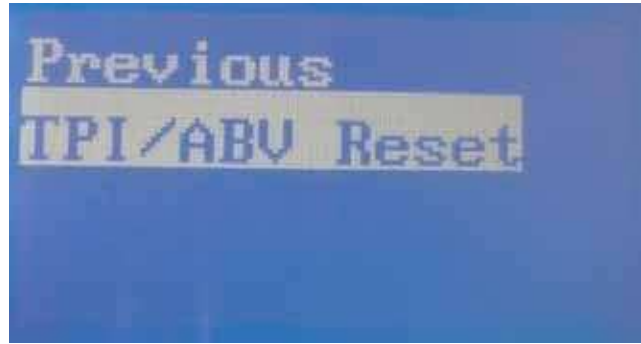

Please key switch off then key switch on
Completed the TPI/ABV reset operate.

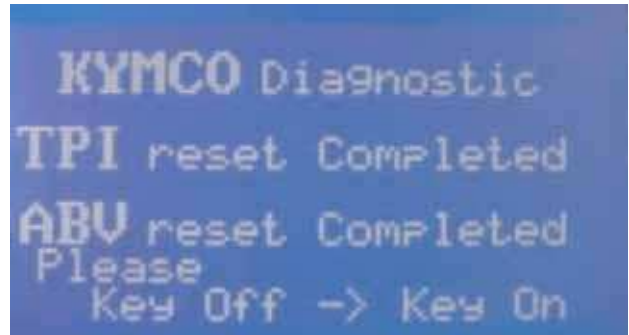

13. Fi DIAGNOSTIC TOOL OPERATION DOWN TOWN 125i

Diagnostic Standard Specifications

Reason of repair: <input type="checkbox"/> maintenance <input type="checkbox"/> breakdown				
Item		Date	Reference	Mem
E C U Version	ECUNo			LFA7
	Hardware Ver			
	Software Ver			
	Calibration Ver			
	Model Name			
D T C	Active			
	Occured			
	History			
(Cool Engine) Engines Stop	Air Temp.(°C)		environ.temp±2°C	
	Engine Temp.(Coiling)		environ.temp±2°C	
	Atom Pressure(kPa)		101.3±3 kPa	The ambient pressure drop about 12 kpa at the altitude every 1000m raised
	Throttle Position(%)		0°/90° 以上.	
	Throttle Position (V)		0.23V±0.05/ >3.27V	IDLE/Throttle fully
	TPIdleMean (V)		0.23±0.05	IDLE/Throttle fully
	Battery Volt (V)		>12 V	
	Idle speed setpoint (rpm)		—	
	ISCA adapMean (°)		—	
	Cut Out switch volt (V)		0.4~1.44 V	3.7~4.7 V(Over 65°)
	Accumulated eng. run time (hr)		—	
	(Hot Engine) Before Repair	EngineSpeed IDLE(rpm)		1850±100 rpm
MAPSample (kPa)			48~60 kpa	80~90°C
Injection duration (ms)			1.6~2.7 ms	80~90°C
Ign. Advance (°)			3~20 BTDC	80~90°C
Ign.Dwell duration (ms)			1.9~2.6 ms	
Air Temp.(°C)			environ.temp±2°C	
Engine Temp. (°C)			>80 °C	
O2 sensor voltage (V)			0~1 V	
O2 sensor heater (Yes/no)			YES	
O2 sensor correct			±20%	
IDLE CO(%)			0.4~1.2%	Engine warmup to 80-90°C
ABVAngDurMech (°)			<140°	>140° The scooter with exchange engine oil and clean throttlly body >180° The scooter must clean throttlly body
(Hot Engine) After Repair		EngineSpeed IDLE(rpm)		1850±100 rpm
	MAPSample (kPa)		48~60 kpa	80~90°C
	Injection duration (ms)		1.6~2.7 ms	80~90°C
	Ign. Advance (°)		3~20 BTDC	80~90°C
	Ign.Dwell duration (ms)		1.9~2.6 ms	Battery Volt (V)14V-1.9~2.1ms,12V-2.5~2.6ms
	Air Temp.(°C)		environ.temp±2°C	
	Engine Temp. (°C)		>80 °C	
	O2 sensor voltage (V)		0~1 V	
	O2 sensor heater (Yes/no)		YES	
	O2 sensor correct		±20%	
	IDLE CO(%)		0.4~1.2%	Engine warmup to 80-90°C

14. DOWNTOWN 125 i FUEL SYSTEM (Auto Control Fuel Injection System)

FUEL SYSTEM (Auto Control Fuel Injection System)

SYSTEM DIAGRAM	14-1
SYSTEM LOCATION.....	14-2
SERVICE INFORMATION	14-3
TROUBLESHOOTING.....	14-4
CHECK ENGINE LAMP (CELP)	14-5
HOW TO SHOW THE FAILURE CODE	14-6
CELP FAILURE CODES CHART	14-7
MAINTAINING BY CHECKING COMPONENT	14-11
MAINTAINING SPECIAL NOTICE	14-16
MAINTAINING RESET	14-17
DIAGNOSTIC RECORD SHEET	14-18

14. DOWNTOWN 125 i FUEL SYSTEM (Auto Control Fuel Injection System)

SYSTEM DIAGRAM

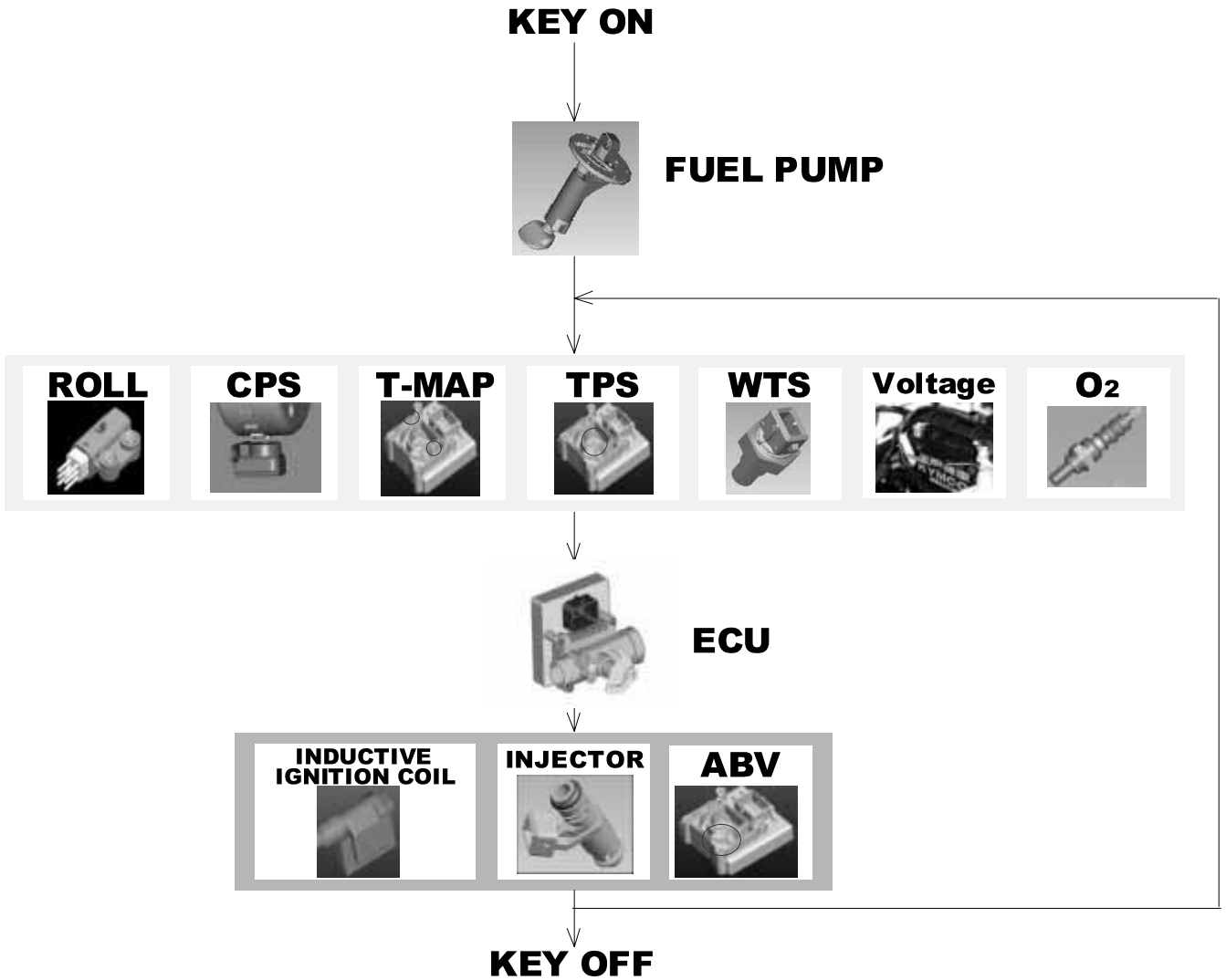

14. DOWNTOWN 125 i FUEL SYSTEM (Auto Control Fuel Injection System)

SYSTEM LOCATION

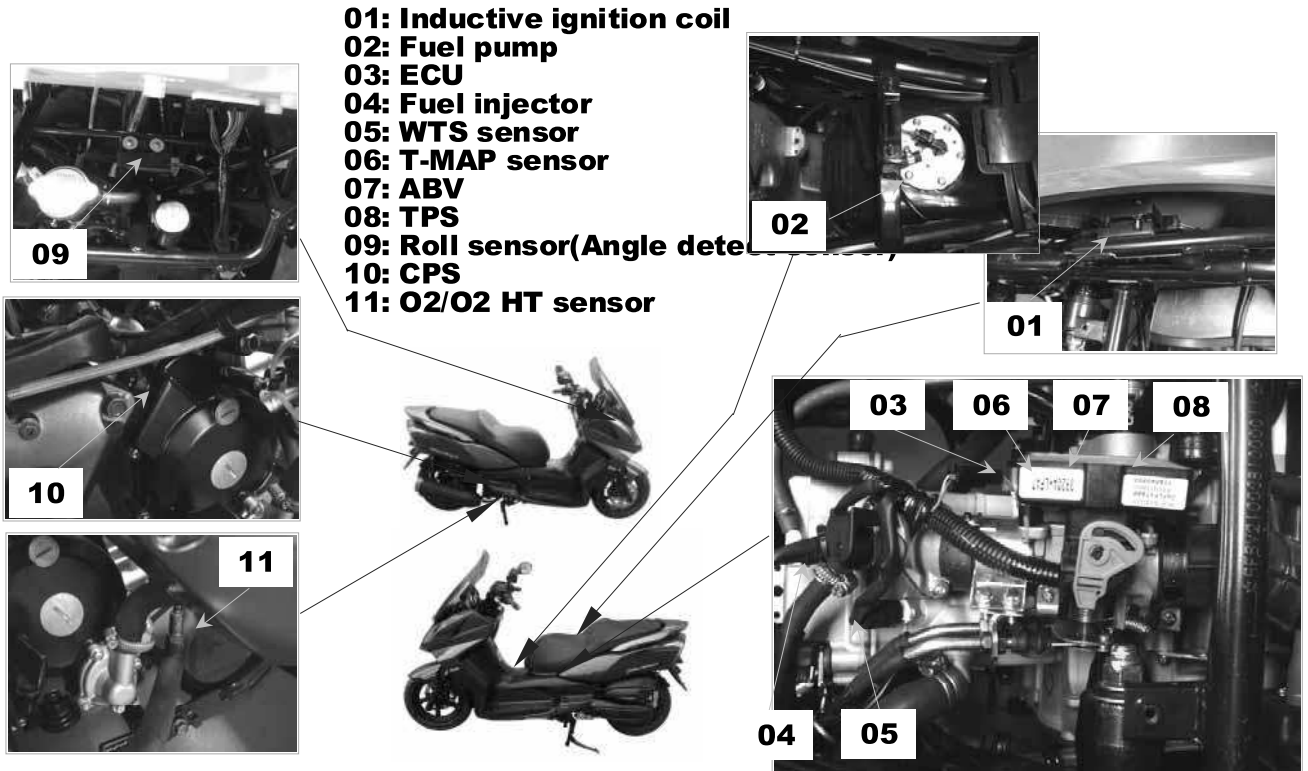

14. DOWNTOWN 125 i FUEL SYSTEM (Auto Control Fuel Injection System)

SERVICE INFORMATION

GENERAL INSTRUCTIONS

Gasoline is very dangerous. When working with gasoline, keep sparks and flames away from the working area.
Gasoline is extremely flammable and is explosive under certain conditions. Be sure to work in a well-ventilated area.

- Disconnect the cables of the battery when the engine is running, which could lead to ECU damage.
- Connect the harness positive (+) cable to the battery negative (-) terminal or connect the harness negative (-) to the battery positive (+) terminal, which could lead to ECU damage.
- Always keep fuel over 750 cc in fuel tank.

SPECIFICATIONS

Item		Standard	
Charging voltage of battery		13.5~14.5V	
Voltage from the ECU to sensor		5±0.1V	
Fuel injector resistance (20°C/68°F)		10.6~15.9Ω	
Water temperature sensor resistance		2.075±10 KΩ (20~30°C)	
Throttle position sensor voltage		Idle (0°)=0.23±0.05V Throttle fully (90° /3.27V over)	
Fuel pump resistance (20°C/68°F)		F: about 1100Ω E: about 100Ω	
O2 sensor	O2 sensor heater resistance	6.7~9.5Ω	
	Voltage	Air/Fuel<14.7 (Rich)	>0.7V
		Air/Fuel>14.7 (Lean)	<0.18V

Item	Standard
Crank position sensor (Pulser) resistance (20°C/68°F)	95~144Ω
Inductive ignition coil resistance (20°C/68°F)	0.55~0.75Ω
Roll sensor voltage (diagnostics)	Normal: 0.3~1.4V Over 65° fall down: 3.5~4.7V
Idle speed	1850±100 rpm

14. DOWNTOWN 125 i FUEL SYSTEM (Auto Control Fuel Injection System)

TROUBLESHOOTING

Engine won't start

- Battery voltage too low
- Fuel level too low
- Pinched or clogged fuel hose
- Faulty fuel pump operating system
- Clogged fuel filter (fuel pump)
- Clogged fuel injector
- Faulty spark plug or wrong type
- Cut by ECU due to angle detect sensor or incorrect function

Backfiring or misfiring during acceleration

- Ignition system malfunction

Poor performance (drive ability) and poor fuel economy

- Pinched or clogged fuel hose
- Faulty fuel injector

Engine stall, hard to start, rough idling



- Intake air leak
- Fuel contaminated/deteriorated
- Pinched or clogged fuel hose
- Idle speed misadjusted

14. DOWNTOWN 125 i FUEL SYSTEM (Auto Control Fuel Injection System)

CHECK ENGINE LAMP (CELP)

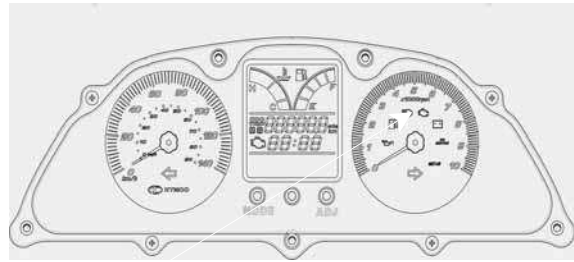
- When turning on the switch, the lamp will be lighted for 2 seconds then off. Let user to know the lamp is available and connect to ECU.
- But after then or during riding, if the CELP start to blink or keep lighting, it means something wrong with this vehicle, you better do the further check to find out the failure code to know which part get trouble
- There are 3 kinds of priority grade let user to know what kind of trouble was happened.
- Priority grade 1: CELP blinks continuously. This is the most emergent situation like engine over heat. User better slow down the riding and go to dealer for checking.
- Priority grade 2: CELP lights all the time. It means components get trouble or circuit something wrong. Do the further check to find out the failure code to know which part get trouble.
- Priority grade 3: CELP just blinks once suddenly and then disappear. It sometimes just warning like the RPM was too high in a short term.

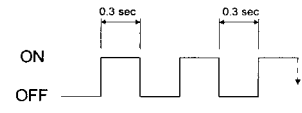

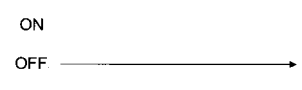
PRIORITY	LAMP ACTION
1	<p>ON</p> <p>OFF</p> 
2	<p>ON</p> <p>OFF</p> 
3	<p>ON</p> <p>OFF</p> 

14. DOWNTOWN 125 i FUEL SYSTEM (Auto Control Fuel Injection System)

How To Show Failure Code

- You can read the failure code by as below :
- Turn switch on. The CELP will be lighted for 2 seconds then off. The CELP start to blink to show the failure codes (The number of blinks from 1 to 25).
- If vehicle got more than one failure code, the CELP will be shown from lower number failure code and then show the other higher number one after four seconds. All the failure codes would be shown repeatedly.

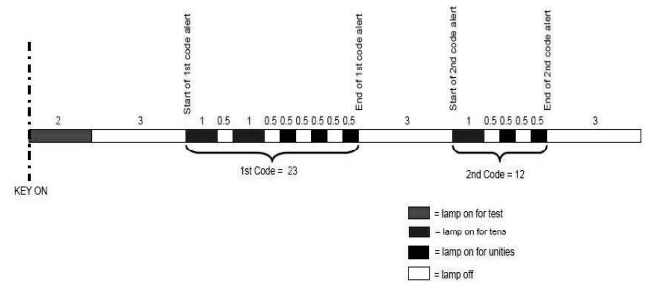

How To Reset Failure Code

- After repairing the trouble, you should clear the failure code or it will still exist in the ECU memory. When you maintain this vehicle next time, it will show again and you get confuse.
- Turn switch on. The CELP will be lighted for two seconds then off.
- The CELP begins to blink to show the failure codes.
- The self-diagnosis memory data will be erased when all the failure codes has showed for 4 cycles.

14. DOWNTOWN 125 i FUEL SYSTEM (Auto Control Fuel Injection System)

CELP Failure Code Chart(1)

Blink	Failure Codes	Fault description	Priority	Fault management
1	P0217	Engine temperature overheat	1	1.Slow down the vehicle and go to workshop for checking immediately. 2.Confirm if the engine temperature sensor or electric circuit is abnormality.
2	P0335	Crankshaft position sensor or circuit malfunction	2	1.Check if the connector of crankshaft position sensor is loosen. 2.Check if the Rotor is align with Crankshaft position sensor during the crankshaft running.
3	P1120	Throttle position sensor setting value problem	2	1.Make sure if the connector of Throttle position sensor is connected correctly. 2.Check if the Throttle position sensor is adjusted.
4	P1121	Throttle position sensor output range problem	2	1.Make sure if the connector of Throttle position sensor is connected correctly. 2.Check if the Throttle position sensor is adjusted.

14. DOWNTOWN 125 i FUEL SYSTEM (Auto Control Fuel Injection System)

CELP Failure Code Chart(2)

Blink	Failure Codes	Fault description	Priority	Fault management
5	P1122	Throttle position sensor movement speed problem	2	<ol style="list-style-type: none"> 1. Make sure if the connector of Throttle position sensor is connected correctly. 2. Check if the Throttle position sensor is adjusted.
6	P0560	Battery voltage malfunction	1	<ol style="list-style-type: none"> 1. Check if the battery voltage is lower or higher. 2. Check if the charge system is malfunction.
7	P0110	Inlet air temperature sensor or electric circuit malfunction	2	<ol style="list-style-type: none"> 1. Check if the connector of Inlet air temperature sensor loosen. 2. Check if the resistance of sensor is normal .
8	P0410	Idle air valve or electric circuit malfunction	2	<ol style="list-style-type: none"> 1. Check if the connector of Idle air valve loosen. 2. Check if the resistance of valve is normal.
9	P0505	Idle speed volume control range	2	<ol style="list-style-type: none"> 1. Check if the opening angle is over 180 ° for Idle air valve. 2. Check if the opening angle is malfunction.
10	P0251	Injector or electric circuit	2	<ol style="list-style-type: none"> 1. Check if the connector of Injector is loosen. 2. Check if the ECU send signal to Injector. 3. Check if the power source and resistance of Injector are malfunction.

14. DOWNTOWN 125 i FUEL SYSTEM (Auto Control Fuel Injection System)

CELP Failure Code Chart(3)

Blink	Failure Codes	Fault description	Priority	Fault management
11	P0350	Ignition coil or electric circuit malfunction	2	1. Check if the connector of ignition coil is loosen. 2. Check if the ECU send signal to Ignition coil. 3. Check if the power source and resistance is malfunction.
12	P0230	Fuel pump relay or electric circuit malfunction	2	1. Check if the connector of relay is loosen. 2. Check if the ECU send signal to relay. 3. Check the fuel pump relay resistance
13	P0219	Engine speed is over than top speed	2	Check if the belt of CVT is broken.
14	P1560	Sensor don't receive power source from ECU	2	1. Check if ECU output DC5V to sensor. 2. Check if the power source of all sensor is DC5V. 3. Replace a new ECU if the CELP still blinks even the output power source of ECU is normal.
15	P0700	Engine starting speed exceed CVT speed limited	2	1. Check if the throttle wire locked. 2. Check if the position of throttle screw is correct. 3. Check if the belt of CVT is broken.
16	P0115	Engine temperature sensor or electric circuit malfunction	2	1. Check if the connector of sensor is loosen. 2. Check if ECU pin is broken. 3. Check if the resistance of sensor is malfunction.
17	P1561	Temperature gauge electric circuit malfunction	2	Don't use it at present.

14. DOWNTOWN 125 i FUEL SYSTEM (Auto Control Fuel Injection System)

CELP Failure Code Chart(4)

Blink	Failure Codes	Fault description	Priority	Fault management
18	P0650	CELP electric circuit malfunction	3	<ol style="list-style-type: none"> 1. Check if the lamp of CELP is broken. 2. Check if wires of CELP is broken.
21	P0105	Atmospheric Pressure Sensor or electric Circuit Malfunction	2	<ol style="list-style-type: none"> 1. Check if the connector of sensor is loosen. 2. Check if ECU pin is broken. 3. Check if voltage of sensor is fit in specification.
22	P1110	Roll sensor or electric circuit malfunction	2	<ol style="list-style-type: none"> 1. Check if the sensor installation direction is correct. 2. Check if voltage of sensor is fit in specification. 3. Check if ECU pin is broken.
23	P0136	O2 sensor malfunction	1	<ol style="list-style-type: none"> 1. Check if the connector of sensor is loosen. 2. Check if ECU pin is broken.
24	P0141	O2 sensor heater malfunction	1	<ol style="list-style-type: none"> 1. Check if the connector of sensor is loosen. 2. Check if ECU pin is broken. 3. Check if the resistance of sensor is malfunction.
25	P0171	O2 sensor electric circuit malfunction	1	<ol style="list-style-type: none"> 1. Check if the connector of sensor is loosen. 2. Check if O2 sensor is blocked. 3. Don't follow a routine maintenance.

14. DOWNTOWN 125 i FUEL SYSTEM (Auto Control Fuel Injection System)

Maintaining By Checking Component

ECU(Engine Control Unit)

Outlook checking

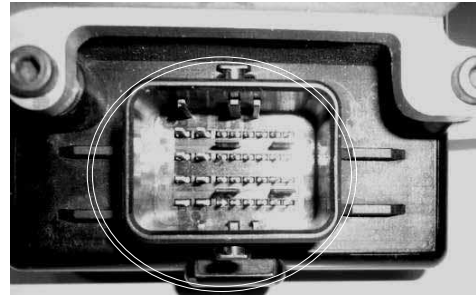

Voltage inspection

Connect the meter (+) probe to the F4(R/W)wire and the meter (-) probe to the H4(G/B) wire to measure the voltage.



MAP content (edition issue no.)

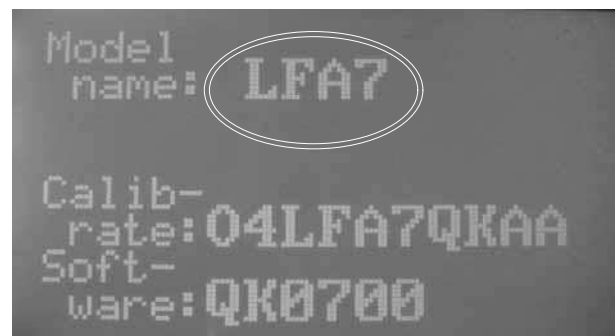

14. DOWNTOWN 125 i FUEL SYSTEM (Auto Control Fuel Injection System)

FUEL PUMP

Connect the meter (+) probe to the red/black wire and the meter (-) probe to the green wire to measure the voltage from the ECU input to fuel pump unit.

Standard : 8~16 V (Battery volt)

Measure the resistance of the fuel pump to see if it is short circuit or not.

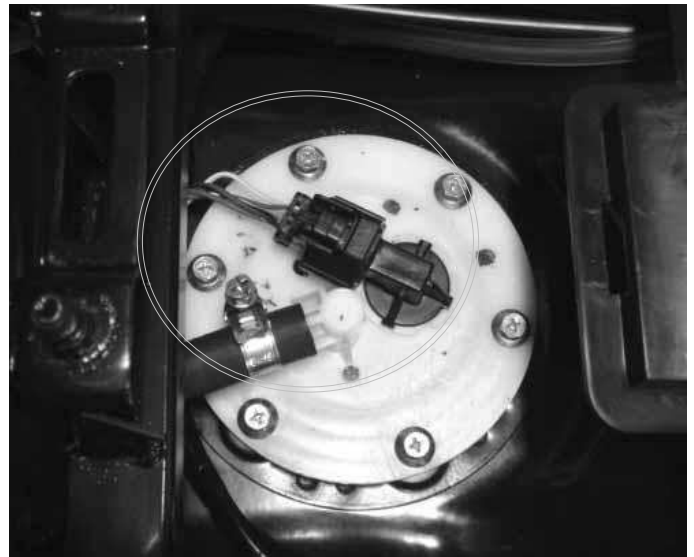

14. DOWNTOWN 125 i FUEL SYSTEM (Auto Control Fuel Injection System)

T-MAP(Manifold Air Temperature Pressure) Sensor

Connect the PDA or KYMCO Fi diagnostic tool.
Into the Data Analyze item .

Check if the manifold pressure data is malfunction.

(Key switch ON but engine is not start)

If data was incorrect.

It is possible T-map sensor is not normal.

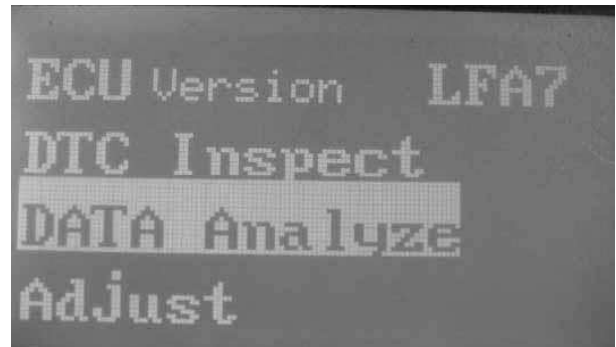

Standard : 101.3 ±3 kpa(see level)

The ambient pressure drop about 12Kpa at the altitude every raised.

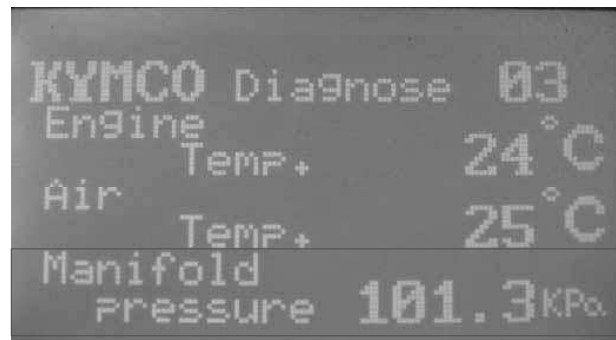

TPS(Throttle Position Sensor)

Connect the PDA or KYMCO Fi diagnostic tool.
Into the Data Analyze item .

Check if the TPS position data is malfunction.

(Key switch ON but engine is not start)

If data was incorrect.(Idle and throttle fully)

It is possible TPS is not normal.

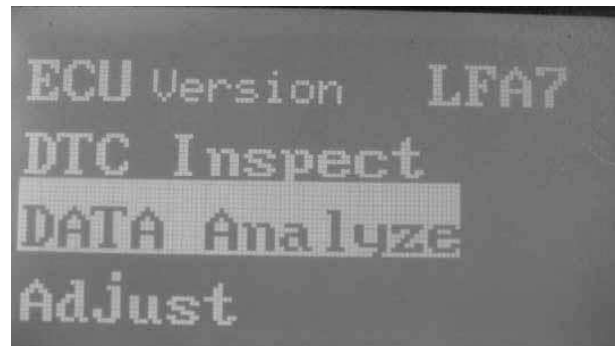

Standard :Idle ~0 ° voltage~0.23V ±0.05

Throttle fully~90°over

voltage~3.27V over

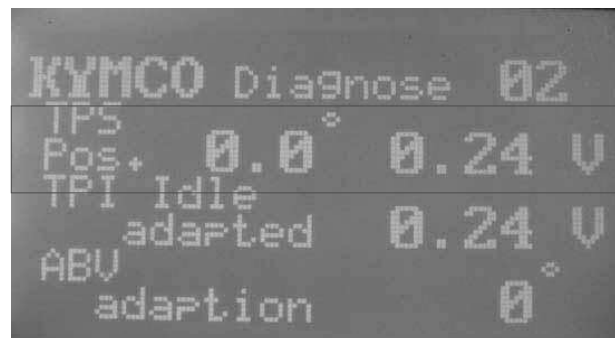

14. DOWNTOWN 125 i FUEL SYSTEM (Auto Control Fuel Injection System)

WTS (Water Temperature Sensor)

Connect the meter (+) probe to the V/G wire and the meter (-) probe to the G/L wire to measure the voltage

Standard : 5 ± 0.25 V

Measure the resistance of the WTS

Standard (20°C/68°F): $2.075\pm 10\%$ k Ω



INJECTOR

Measure the resistance of the Injector

Standard (20°C/68°F): 10.6~15.9 Ω



14. DOWNTOWN 125 i FUEL SYSTEM (Auto Control Fuel Injection System)

O2 SENSOR

Measure the resistance of the O2 sensor heater.
(2 white wire pin)

Standard (20°C/68°F): 6.7 ~9.5Ω



Connect the PDA or KYMCO Fi diagnostic tool.
Into the Data Analyze item .

Check Page 05

(Key switch ON then start engine until O2
heater activation is ON)

If data was incorrect.

It is possible O2 sensor is not normal

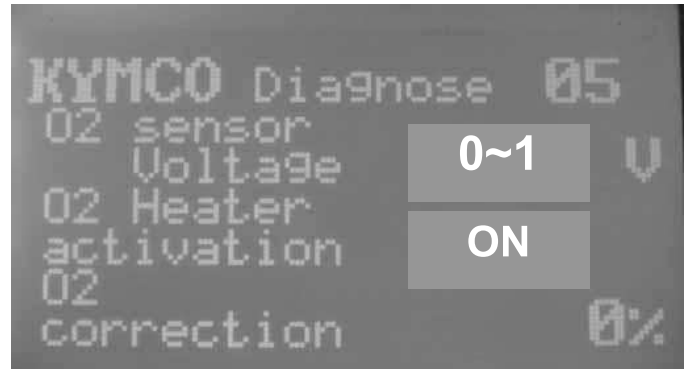

14. DOWNTOWN 125 i FUEL SYSTEM (Auto Control Fuel Injection System)

ROLL SENSOR

The engine should be stall when the vehicle incline over 65° for safety. When you place the vehicle back to normal situation, you have to key-off and key-on the switch, then it can be restarted.

Standard: Normal: 0.4~1.4V

OVER 65°: 3.7~4.4 V

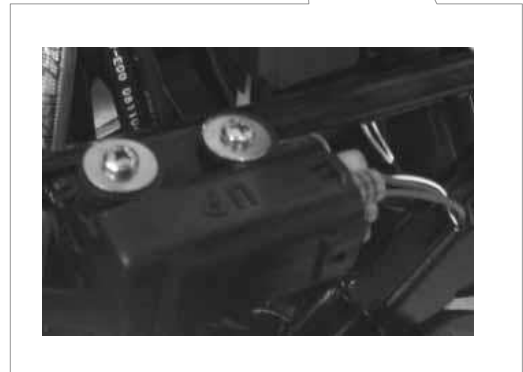
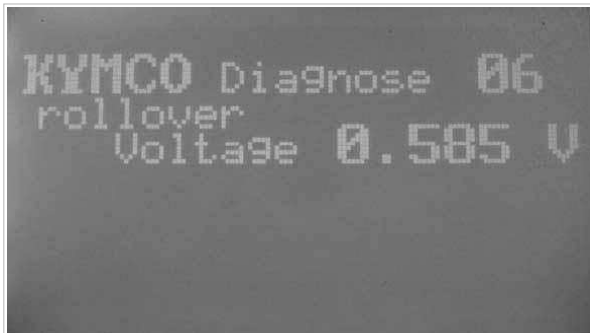

Maintaining Special Notice

Never adjust those two TP screws, those were adjusted to be the best condition by KYMCO, if change this condition it may cause instable riding.

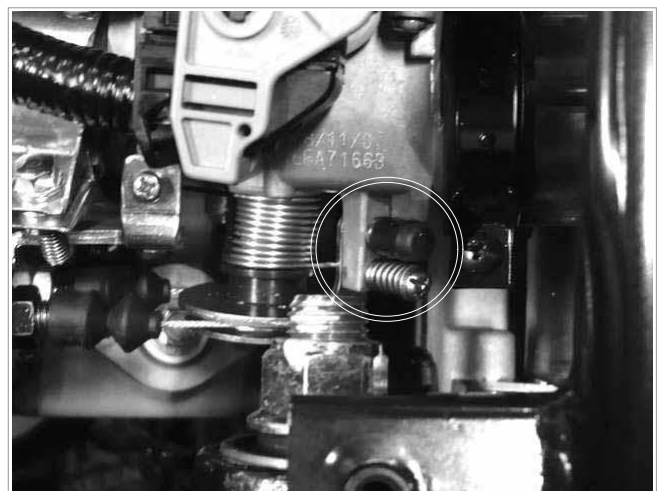

TP screws

14. DOWNTOWN 125 i FUEL SYSTEM (Auto Control Fuel Injection System)

Connect the PDA or KYMCO Fi diagnostic tool.
Into the Data Analyze item .

Check if the ignition advance data is malfunction.

(Key switch is ON then start engine until 80 ° C)

If data was over **20 °**

you can adjustment the air bypass adjustment screw 1~1.5 circle.(counterclockwise)

Don't adjust the air bypass adjustment screw over 1.5 circle.

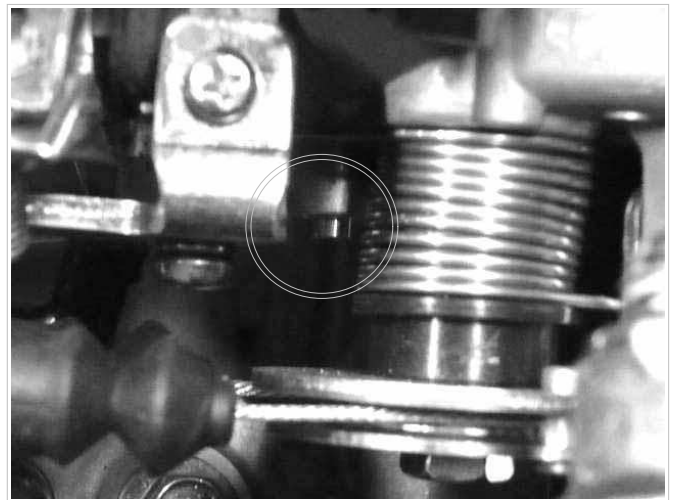
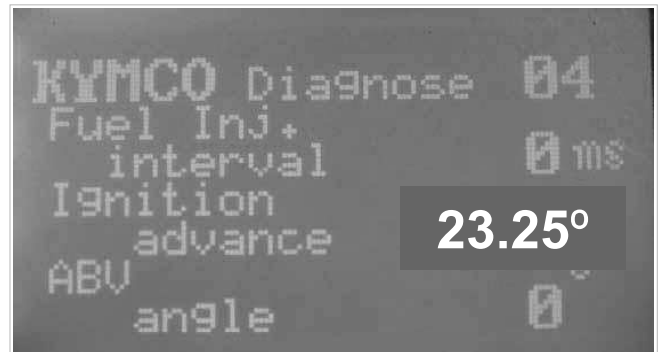

Maintenance reset

TPI and ABV Initialization Method

After replacing throttle body or engine overhauled, It will change the efficiency of air intake so must be do the TPI/ABV initialization process.

- When the vehicle is started, turn off the ignition and Key On again (do not start the engine).

Use test rod or wire clip short Reset (pink) wire to short with negative of battery or the earthing of frame to complete TPI ABV resetting.

Precautions:

1. After short, remove test rod or wire clip. Never let it connected all the time.
2. Do not break the PVC sleeve of Reset wire.



14. DOWNTOWN 125 i FUEL SYSTEM (Auto Control Fuel Injection System)

KYMCO Diagnostic Report DOWNTOWN 125 i
SF
Customer :
Eng.Num :
Date of
Date of
Mileage :
production
repair :

Reason of repair: maintenance breakdown

Item		Date	Reference	Memo
ECU Version	ECU No			LFA7
	Hardware Ver			
	Software Ver			
	Calibration Ver			
	Model Name			
DTC	Active			
	Occurred			
	History			
(Cool Engine) EngineStop	Air Temp.(°C)		environ.temp ± 2 °C	
	Engine Temp.(Coiling)		environ.temp ± 2 °C	
	Atom. Pressure(Kpa)		101.3 ± 3 kPa	The ambient pressure drop about 12 kpa at the altitude every 1000m raised
	Throttle Position(%)		0° / 90° 以上	
	Throttle Position (V)		0.23V ± 0.05 / >3.27V	IDLE/Throttle fully
	TPIIdleMean (V)		0.23±0.05	IDLE/Throttle fully
	Battery Volt (V)		>12 V	
	Idle speed setpoint (rpm)		---	
	ISCAdapMean (°)		---	
	Cut Out switch volt (V)		0.4 ~ 1.44 V	3.7 ~ 4.7 V(Over 65°)
	Accumulated eng. run time (hr)		---	
(Hot Engine) BeforeRepair	EngineSpeed IDLE(rpm)		1850 ± 100 rpm	80~90°C
	MAPSample (kPa)		48 ~ 60 kpa	80~90°C
	Injection duration (ms)		1.6 ~ 2.7 ms	80~90°C
	Ign. Advance (°)		3 ~ 20 BTDC	80~90°C
	Ign.Dwell duration (ms)		1.9 ~ 2.6 ms	
	Air Temp.(°C)		environ.temp ±2 °C	
	Engine Temp. (°C)		>80 °C	
	O2 sensor voltage (V)		0 ~ 1 V	
	O2 sensor heater (Yes/no)		YES	
	O2 sensor correct		±20%	
	IDLE CO(%)		0.4 ~ 1.2 %	Engine warm up to 80~90 °C
	ABVAngDurMech (°)		140 °	>140 ° The scooter with exchange engine oil and clean throttlly body >180 ° The scooter must clean throttlly body
	(Hot Engine) AfterRepair	EngineSpeed IDLE(rpm)		1850 ± 100 rpm
MAPSample (kPa)			48 ~ 60 kpa	80~90°C
Injection duration (ms)			1.6 ~ 2.7 ms	80~90°C
Ign. Advance (°)			3 ~ 20 BTDC	80~90°C
Ign.Dwell duration (ms)			1.9 ~ 2.6 ms	Battery Volt (V)14V-1.9~2.1ms,12V-2.5~2.6ms
Air Temp.(°C)			environ.temp ±2 °C	
Engine Temp. (°C)			>80 °C	
O2 sensor voltage (V)			0 ~ 1 V	
O2 sensor heater (Yes/no)			YES	
O2 sensor correct			±20%	
IDLE CO(%)			0.4 ~ 1.2 %	Engine warm up to 80~90 °C
ABVAngDurMech (°)			140 °	>140 ° The scooter with exchange engine oil and clean throttlly body >180 ° The scooter must clean throttlly body
Repair description		Repair Process		

Report ID=

Report Version : DEC/11/2008

**HANDLEBAR/FRONT WHEEL/FRONT BRAKE/
FRONT SHOCK ABSORBER/STEERING STEM**

SERVICE INFORMATION-----	15- 1
TROUBLESHOOTING-----	15- 2
HANDLEBAR -----	15- 3
FRONT WHEEL-----	15- 7
FRONT BRAKE FLUID-----	15-11
FRONT BRAKE PAD -----	15-15
BRAKE DISC INSPECTION -----	15-17
FRONT SHOCK ABSORBER-----	15-18
STEERING STEM-----	15-19

SERVICE INFORMATION

GENERAL INSTRUCTIONS

- Remove the motorcycle frame covers before removing the front wheel, steering handlebar, front shock absorber and front fork. Jack the motorcycle front wheel off the ground and be careful to prevent the motorcycle from falling down.
- During servicing, keep oil or grease off the brake pads and brake disk.

SPECIFICATIONS

Unit: mm

Item	Standard
Brake disk thickness	3.9~4.1 (0.156~0.164)
Brake disk runout	—
Brake master cylinder I.D.	12.7~12.74 (0.508~0.5096)
Brake master cylinder piston O.D.	12.65~12.68 (0.506~0.5072)
Brake caliper piston O.D.	26.93~26.96 (1.077~1.0784)
Brake caliper cylinder I.D.	27~27.05 (1.08~1.082)

TORQUE VALUES

Handlebar lock nut	45 N•m (4.5 kgf•m,)
Steering stem lock nut	63 N•m (6.3 kgf•m,)
Steering stem pinch bolt	27 N•m (2.7 kgf•m)
Front axle	20 N•m (2.0 kgf•m,)
Master cylinder reservoir cover screw	1.6N•m (0.16 kgf•m)
Master cylinder holder bolt	12 N•m (1.2 kgf•m)
Brake lever pivot bolt	2 N•m (0.2 kgf•m)
Brake lever pivot nut	10 N•m (1 kgf•m,)
Brake light switch screw	1 N•m (0.1 kgf•m,)
Brake caliper mounting bolt	35 N•m (3.5 kgf•m,)
	ALOC bolt: replace with a new one.
Brake caliper bleed screw	5.5N•m (0.55 kgf•m)
Brake hose oil bolt	35 N•m (3.5 kgf•m)

SPECIAL TOOLS

Lock nut wrench	A120F00002
Oil seal and bearing installer	A120E00014
Bearing piller	A120E00037
Lock nut wrench	A120F00023
Ball Cone Remover	A120F00009
Ball Cone Installer	A120F00009

TROUBLESHOOTING

Hard steering (heavy)

- Excessively tightened steering stem top cone race
- Broken steering balls
- Insufficient tire pressure

Steers to one side or does not track straight

- Uneven front shock absorbers
- Bent front fork
- Bent front axle or uneven tire

Poor brake performance

- Worn brake pads
- Contaminated brake pad surface
- Deformed brake disk
- Air in brake system
- Deteriorated brake fluid
- Worn brake master cylinder piston oil seal
- Clogged brake fluid line
- Unevenly worn brake caliper

Front wheel wobbling

- Bent rim
- Loose front axle
- Bent spoke plate
- Faulty tire
- Improperly tightened axle nut

Soft front shock absorber

- Weak shock springs
- Insufficient damper oil

Front shock absorber noise

- Slider bending
- Loose fork fasteners
- Lack of lubrication

HANDLEBAR

REMOVAL

Remove the lower handlebar cover and front cover (refer to the “**FRAME COVERS REMOVAL/INSTALLATION**” section in the chapter 2).

Remove the two bolts (1) and disconnect the brake light switch wire (2), then remove the rear brake master cylinder.

Remove the two bolts (3) and disconnect the brake light switch wire (4), then remove the front brake master cylinder.

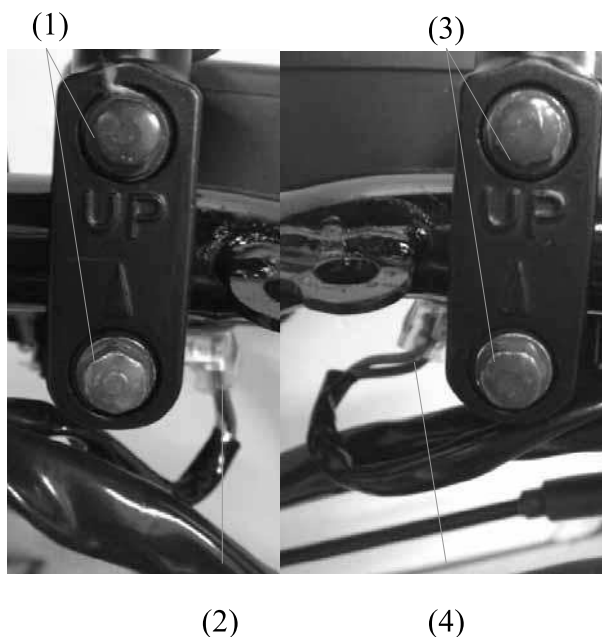

Remove the handlebar lock nut (5) and take out the bolt (6).

Remove the handlebar and collar (7).

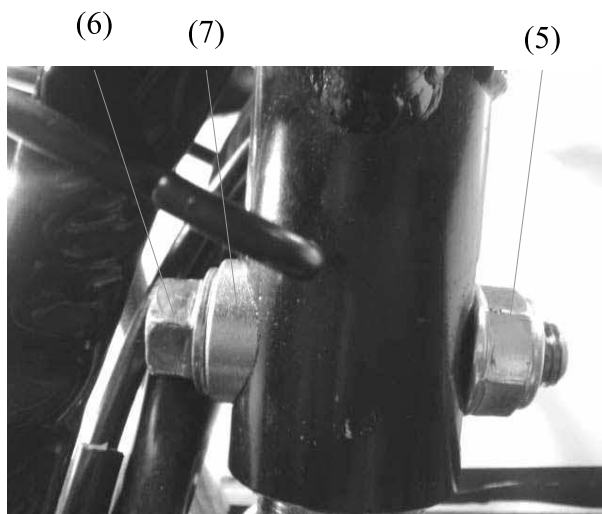

15. HANDLEBAR/FRONT WHEEL/FRONT BRAKE/ FRONT SHOCK ABSORBER/STEERING STEM

INSTALLATION

Install the handlebar onto the steering stem and install the handlebar collar, lock nut and bolt.

Tighten the bolt to the specified torque.

Torque: 4.5 kgf-m (45 N-m, 32 lbf-ft)



Install the front and rear master cylinders and connect the brake light switch wires



DISASSEMBLY

Remove two screws (1) attaching right handlebar switch.



Disconnect the throttle cable (2) attaching the throttle grip.
Remove the right headlight switch.

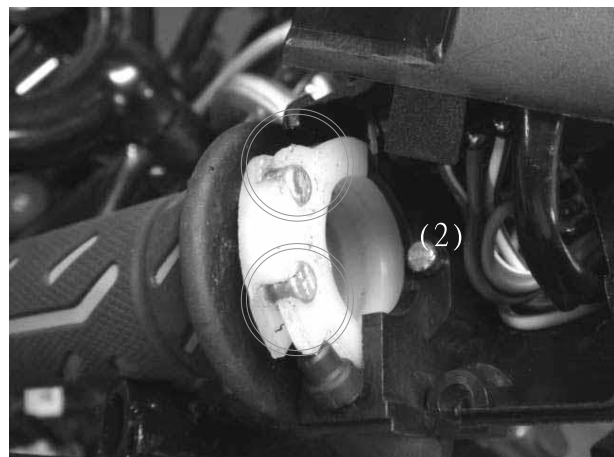

Remove two screws (3) and then remove the turn light switch.



ASSEMBLY

Install the turn light switch.

- * Align the pin on the turn light switch with the hole on the handlebar.

Install the headlight switch.

- * Align the pin on the headlight switch with the hole on the handlebar.

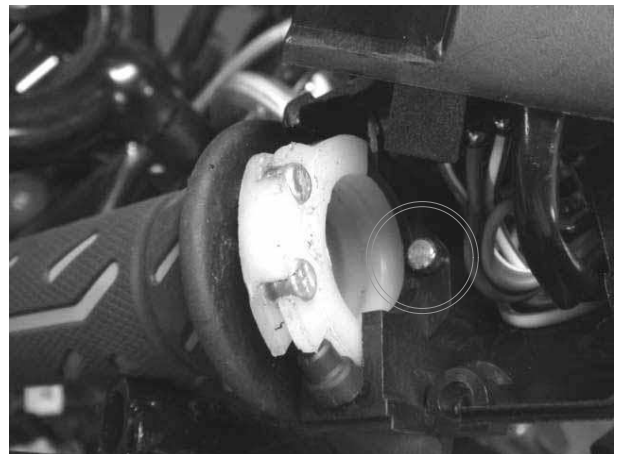

Lubricate the throttle grip front end with grease and then connect the throttle cable to the throttle grip.

Install and tighten the two screws.

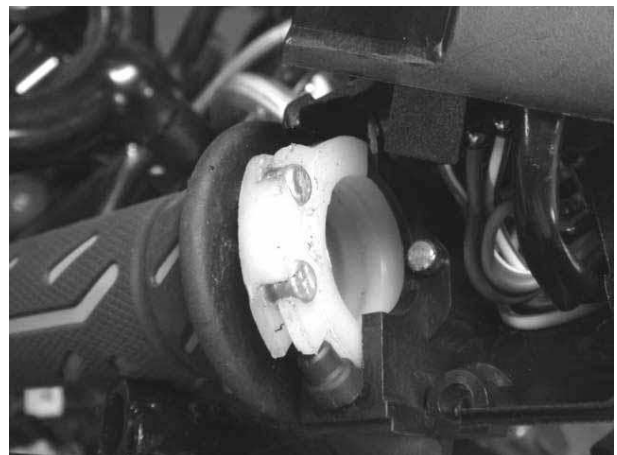

FRONT WHEEL

REMOVAL

Jack the scooter front wheel off the ground.
Remove the bolt , then pull out the axle .
Remove the front wheel and collar.



INSTALLATION

Apply grease to the collar (1), then install the collar onto the wheel.



(1)

Install the speedometer speed wheel sensor(2)



(2)

DISASSEMBLY

Remove the side collar (1) and dust seal (2).

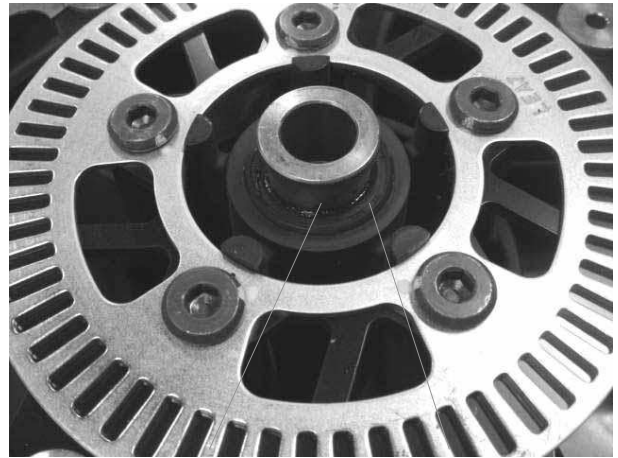

(1) (2)

Turn the inner race of each bearing with your finger to see if they turn smoothly and quietly. Also check if the outer race fits tightly in the hub.

Replace the bearings if the races do not turn smoothly, quietly, or if they fit loosely in the hub.

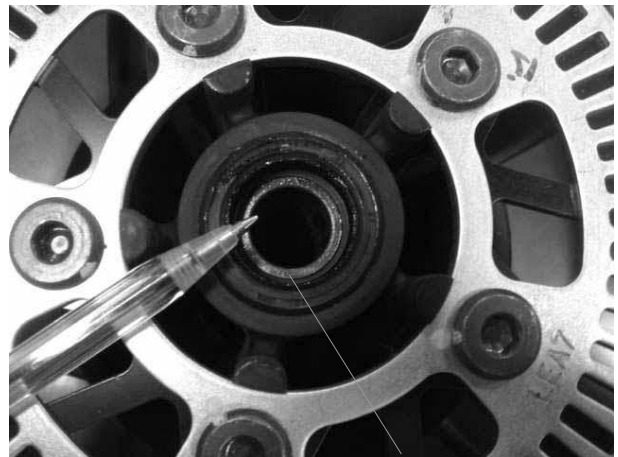

(3)

Remove the front wheel bearing (3) by using the special tool.

Special tool:

Bearing puller A120E00037

Remove the distance collar from wheel.

(3)

15.HANDLEBAR/FRONT WHEEL/FRONT BRAKE/ FRONT SHOCK ABSORBER/STEERING STEM

Remove the front wheel bearing (5) by using the special tool.

Special tool:

Bearing puller A120E00037

ASSEMBLY

Install the front wheel bearing (5) by using the special tool.

Special tool:

Bearing installer A120E00014

Install the distance collar.

Install the front wheel bearing (5) by using the special tool.

Special tool:

Bearing installer A120E00014

Apply grease to the collar, then install the collar onto the wheel.



(5)



(5)

FRONT BRAKE FLUID

FLUID REPLACEMENT/AIR BLEEDING

- *

<ul style="list-style-type: none">● A contaminated brake disc or pad reduces stopping power. Discard contaminated pads and clean a contaminated disc with a high quality brake degreasing agent.● Do not allow foreign material to enter the system when filling the reservoir.● Avoid spilling brake fluid on painted, plastic or rubber parts. Place a rag over these parts whenever the system is serviced.
--

Once the hydraulic system has been opened, or if the brake feels spongy, the system must bled. When using a commercially available brake bleeder, follow the manufacturer's operating instructions.

15.HANDLEBAR/FRONT WHEEL/FRONT BRAKE/ FRONT SHOCK ABSORBER/STEERING STEM

Brake fluid draining

Make sure that the master cylinder parallel to the ground, before removing the reservoir cover.

Remove the two screws (1).



Remove the reservoir cover , diaphragm plate and diaphragm .

Connect a bleed hose to the bleed valve



Loosen the bleed valve and pump the brake lever.
Stop operating the brake when no more fluid flows out of the bleed valve.

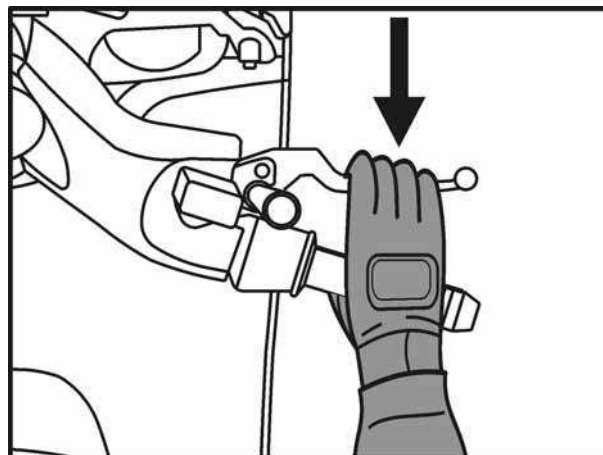

Brake fluid filling/Air bleeding

* Do not mix different types of fluid since they are not compatible.

Fill the master cylinder with DOT 4 brake fluid to the upper level.

Connect a commercially available brake bleeder to the front caliper bleed valve.

Check the fluid level while bleeding the brake to prevent air from being pumped into the system.

When using a brake bleeding tool, follow the manufacture's operating instructions.

Pump the brake bleeder and loosen the front caliper bleed valve. Add fluid when the fluid level in the master cylinder is low to prevent drawing air into the system.

Repeat the above procedures until no air bubbles appear in the brake hose.

Close the front caliper bleed valve and operate the front brake lever.

If it still spongy, bleed the system again.

15. HANDLEBAR/FRONT WHEEL/FRONT BRAKE/ FRONT SHOCK ABSORBER/STEERING STEM

If the brake bleeder is not available, perform the following procedure.

Pump up the system pressure with the brake lever until there are no air bubbles in the fluid flowing out of the reservoir small hole and lever resistance is felt.

1. Pump the brake lever several times, then squeeze the brake lever all the way and loosen the bleed valve 1/4 turn. Wait several seconds and close the bleed valve.

* Do not release the brake lever until the bleed valve has been closed.

2. Release the brake lever slowly until the bleed valve has been closed. Add fluid when the fluid level in the master cylinder is low to prevent drawing air into the system.
3. Repeat the steps 1 - 2 until there are no air bubbles in the bleed hose.

After bleeding air completely, tighten the bleed valve to the specified torque.

Torque: 6 N•m (0.6 kgf•m, 4.3 lbf•ft)
Fill the reservoir to the casting ledge with DOT 4 brake fluid to the upper level.

Install the diaphragm, set plate and reservoir cover and tighten the screws to the specified torque.

Torque: 2 N•m (0.2 kgf•m, 1.1 lbf•ft)

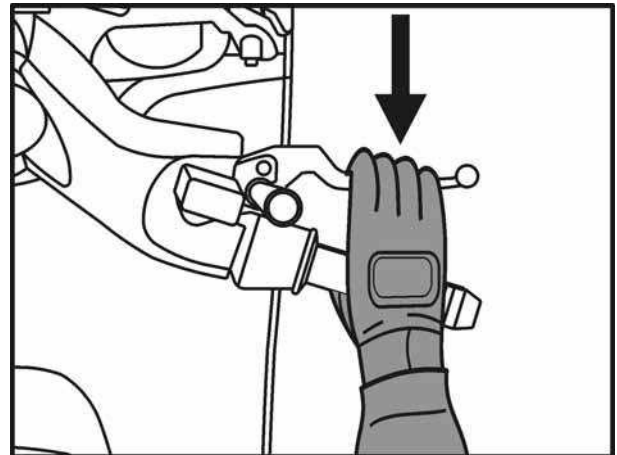

FRONT BRAKE PAD

BRAKE PAD REPLACEMENT

Remove the pad pins (1).
Remove two caliper mounting bolts (2),
then remove the caliper.



(1) (2)

Remove the brake pads(3).



(3)

* Always replace the brake pads in pairs to ensure even disc pressure.



15. HANDLEBAR/FRONT WHEEL/FRONT BRAKE/ FRONT SHOCK ABSORBER/STEERING STEM

Install new pads so that their ends rest on the pad retainer on the brake properly.



Install the pad pin by pushing the pads against the pad spring to align the pad pin holes in the pads and caliper.

Install the front caliper onto the fork leg and then install and tighten the new two caliper mounting bolts to the specified torque.

Torque: 35 N-m (3.5 kgf-m)

Tighten the pad pins to the specified torque.

Torque: 18 N-m (1.8 kgf-m, 13 lbf-ft)



BRAKE DISC INSPECTION

Visually inspect the brake disc for damage or cracks.

Measure the brake disc thickness.

Service limits: 3 mm (0.12 in)



FRONT SHOCK ABSORBER

REMOVAL

Remove the front cover and front fender. (refer to the “**FRAME COVERS REMOVAL/INSTALLATION**” section in the chapter 2).

Remove the front brake caliper

Remove the front wheel

Remove the speed wheel sensor bolt (1) and then remove the brake hose guide from right front shock absorber.

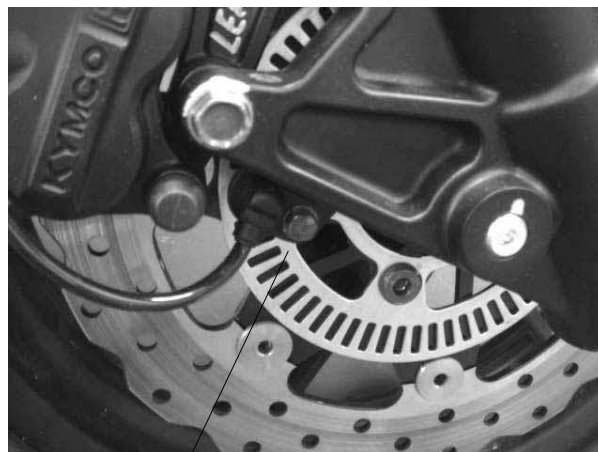

(1)

Remove two mounting bolts (2) and then remove the right front shock absorber.

Remove two mounting bolts (3) and then remove the left front shock absorber.

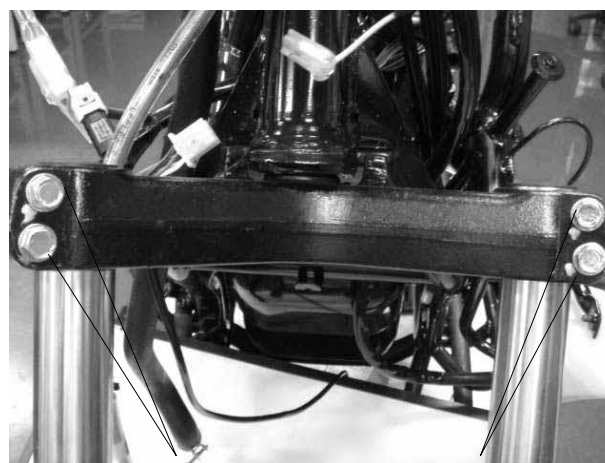

(2)

(3)

INSTALLATION

Installation is in the reverse order of removal.

* Tighten the shock absorber mounting bolt to the specified torque.

Torque: 2.7 kgf-m (27 N-m, 19 lbf-ft)

INSPECTION

Inspect the following items and replace if necessary.

- Front shock absorber tube bending, damage or wear
- Weak front shock absorber spring
- Damper and damper rod bending
- Oil seal damage or wear

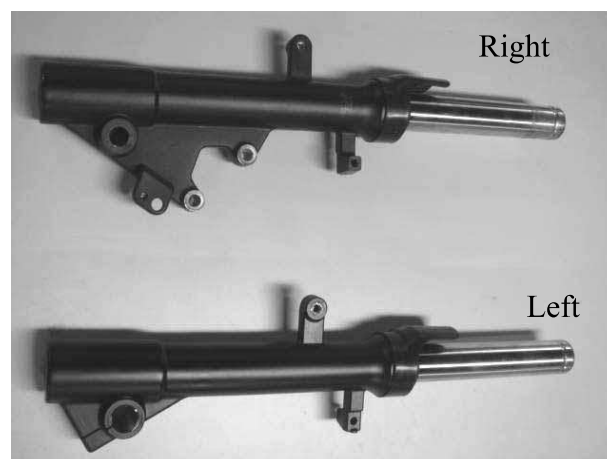

Right

Left

15.HANDLEBAR/FRONT WHEEL/FRONT BRAKE/ FRONT SHOCK ABSORBER/STEERING STEM

REMOVAL

Remove the steering handlebar Remove the front shock absorber

Remove the front brake hose and speed wheel Sensor connector



Hold the steering stem top cone race and remove the steering stem lock nut by using the special tool.



Lock Nut Wrench

Special tool:

Lock nut wrench A120F00002



Remove the top cone race and washer remove the steering stem.



Special tool:

Lock nut wrench A120F00023

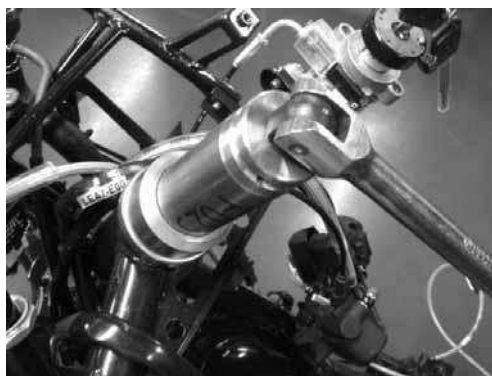

15.HANDLEBAR/FRONT WHEEL/FRONT BRAKE/ FRONT SHOCK ABSORBER/STEERING STEM

Inspect the ball races, cone races and steel balls for wear or damage. Replace if necessary.

Remove the top balls.

Remove the upper ball race by using a chisel if necessary.

Ball



Top Ball Cone Race

Remove the bottom balls.

Remove the bottom ball race by using a pipe if necessary.

Bottom Ball Race

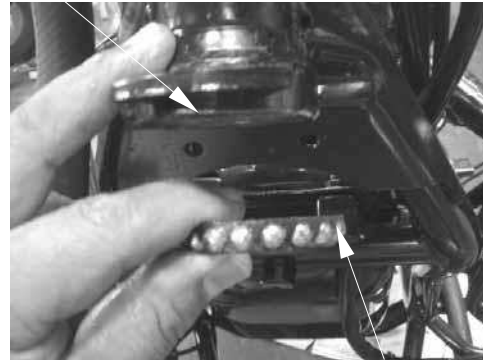

Bottom Balls

Remove the bottom cone race by using a chisel if necessary.

* Be careful not to damage the steering stem.

Bottom Cone Race

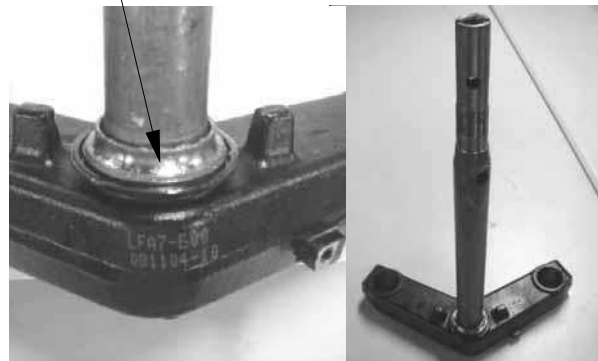

15. HANDLEBAR/FRONT WHEEL/FRONT BRAKE/ FRONT SHOCK ABSORBER/STEERING STEM

INSTALLATION

Install the new bottom cone race onto the steering stem.

Install the new upper and bottom ball races into the frame.

Apply grease to the top and bottom ball races and install new steel balls on the top ball race and new steel balls on the bottom ball race. Install the steering stem.



Apply grease to the top cone race and install it.

Tighten the top cone race and then turn the steering stem right and left several times to make steel balls contact each other closely.

*

Check that the steering stem rotates freely without vertical play.

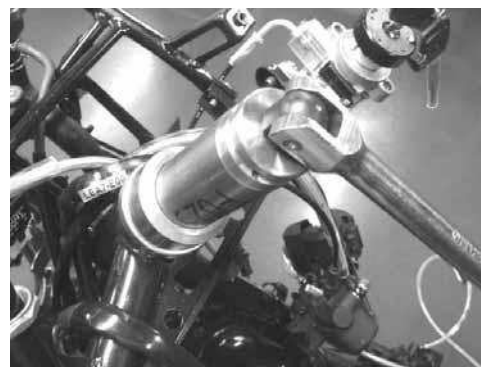

Special tool:

Lock nut wrench A120F00023

Install the steering stem lock nut and tighten it to the specified torque by using the special tool while holding the top cone race.

Torque: 7 kgf-m (70 N-m)

Special tool:

Lock nut wrench A120F00002



**15.HANDLEBAR/FRONT WHEEL/FRONT BRAKE/
FRONT SHOCK ABSORBER/STEERING STEM**

Top Ball Cone Race
Remove special tool

Bottom Ball Race
Remove special tool



A120 F00009

Bottom Ball Race
Install special tool

Top Ball Cone Race
Install special tool

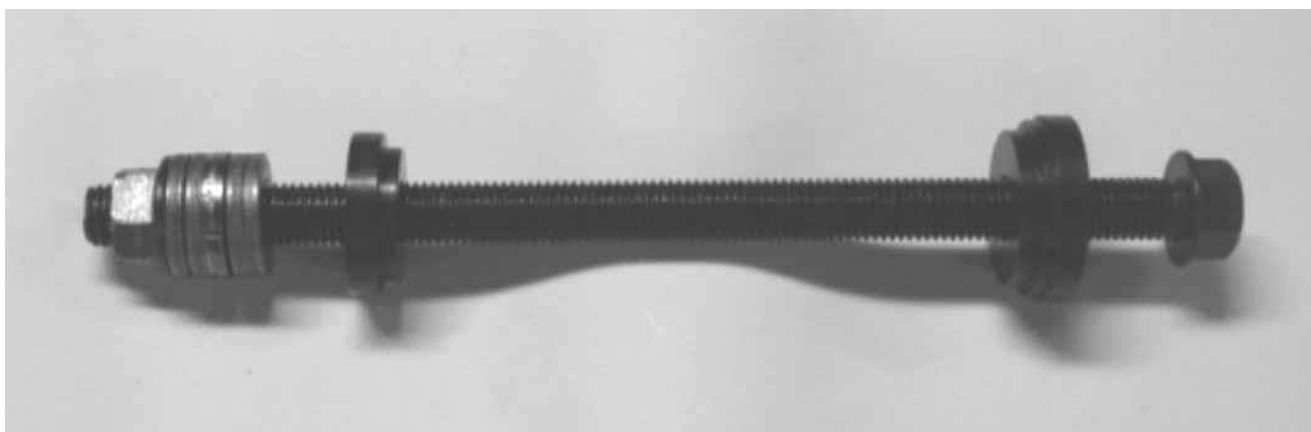

A120 F00019

16. REAR BRAKE/REAR FORK/REAR WHEEL/REAR SHOCK ABSORBER

REAR BRAKE/REAR FORK/REAR WHEEL/ REAR SHOCK ABSORBER

SCHEMATIC DRAWING	16-1
SERVICE INFORMATION.....	16-2
TROUBLESHOOTING.....	16-2
REAR BRAKE	16-3
REAR FORK	16-6
REAR WHEEL.....	16-7
REAR SHOCK ABSORBER	16-7

16. REAR BRAKE/REAR FORK/REAR WHEEL/REAR SHOCK ABSORBER



DOWNTOWN 125i

SCHEMATIC DRAWING

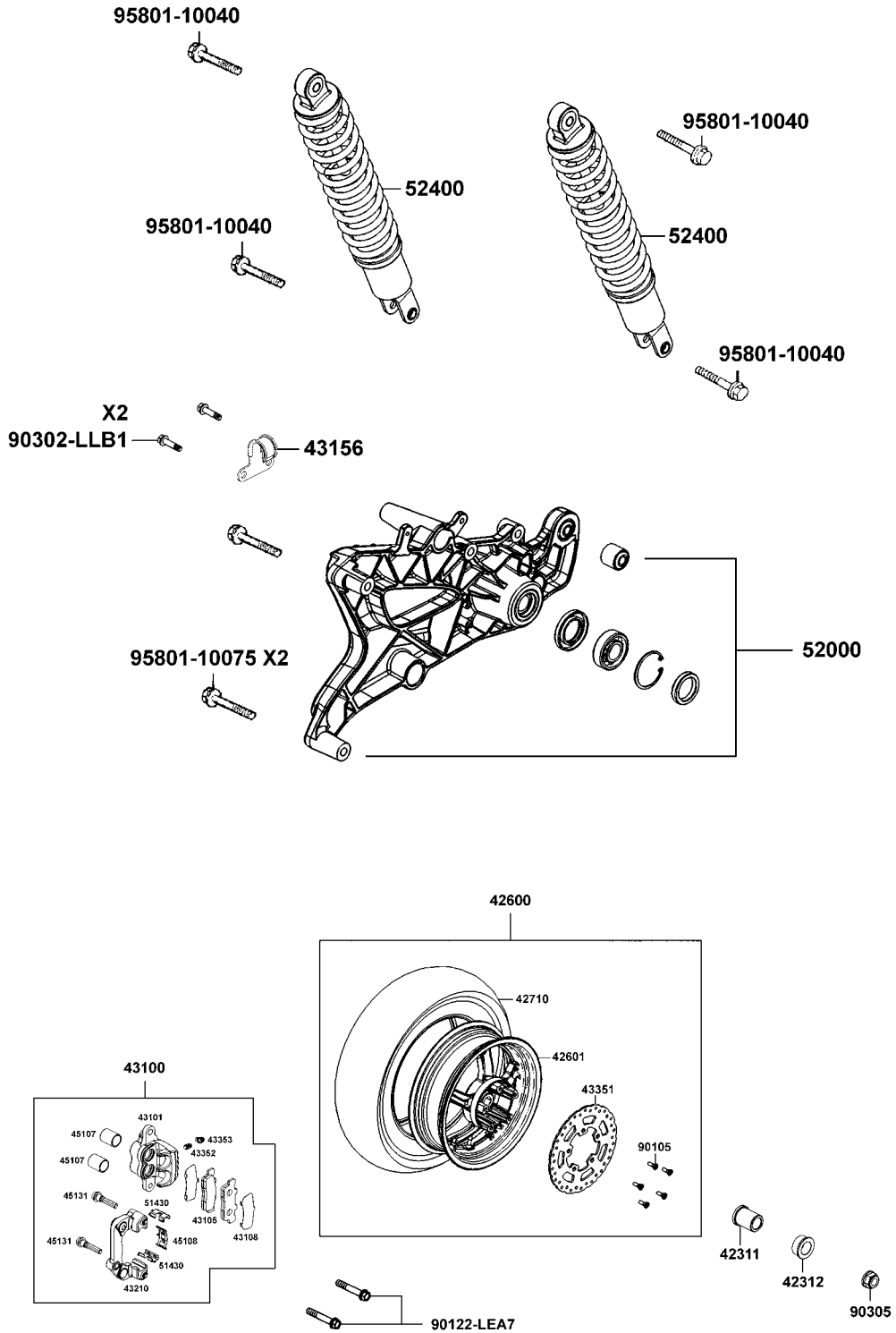

16. REAR BRAKE/REAR FORK/REAR WHEEL/REAR SHOCK ABSORBER

SERVICE INFORMATION

GENERAL INSTRUCTIONS

- When performing the services stated in this section, the engine and exhaust muffler must be cold to avoid scalding.
- During servicing, keep oil or grease off the brake pads and brake disk.

SPECIFICATIONS

Item	Standard (mm)
Rear brake disk thickness	4.9~5.1
Rear brake caliper piston O.D.	25.33~25.36
Rear brake caliper cylinder I.D.	25.4~25.45
Rear brake master cylinder I.D.	12.7~12.74
Rear brake master cylinder piston O.D.	12.65~12.68

TORQUE VALUES

Exhaust muffler lock bolt	35 N-m/3.5 kgf-m
Exhaust muffler pipe nut	20 N-m/2 kgf-m
Rear axle nut	120 N-m/12 kgf-m
Rear shock absorber lower mount bolt	40N-m/4 kgf-m
Rear shock absorber upper mount bolt	40N-m/4 kgf-m
Rear brake caliper holder bolt	27 N-m/2.7 kgf-m

TROUBLESHOOTING

Rear wheel wobbling

- Bent rim
- Faulty tire
- Axle not tightened properly

Soft rear shock absorber

- Weak shock absorber spring
- Damper oil leaks

Rear wheel noise

- Worn rear wheel axle bearings
- Worn rear fork bearings
- Deformed rear fork

Poor brake performance

- Air in brake system
- Deteriorated brake fluid
- Contaminated brake pad surface
- Worn brake pads
- Clogged brake fluid line
- Deformed brake disk
- Unequal worn brake caliper

16. REAR BRAKE/REAR FORK/REAR WHEEL/REAR SHOCK ABSORBER

REAR BRAKE

REAR BRAKE CALIPER REMOVAL

First remove the exhaust muffler.
Remove the rear brake fluid tube bolt and disconnect the brake fluid tube.
Remove two bolts attaching the rear brake caliper.
Remove the rear brake caliper.

* When removing the brake fluid tube, use shop towels to cover plastic parts and coated surfaces to avoid damage.

Fluid Tube Bolt

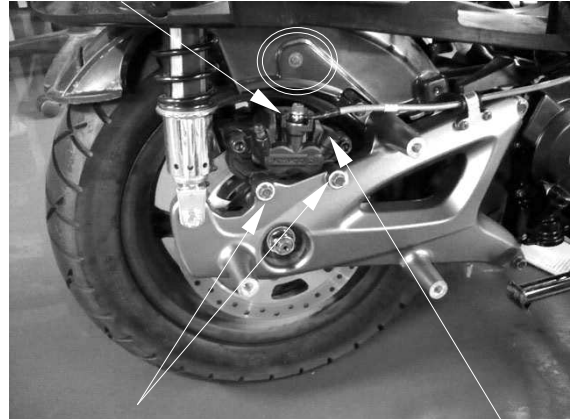

Bolts

Brake Caliper

INSPECTION

Inspect the brake pads and brake disk.

Measure the brake disk thickness.

Brake Disk



Visually check the brake pad thickness

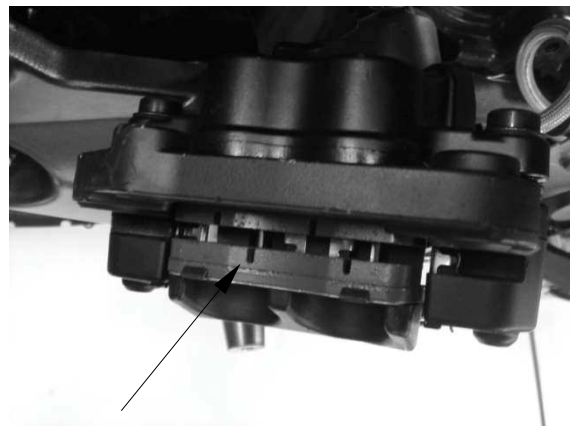

Brake pads

DISASSEMBLY

Remove two brake pads dowel pins and three bolts from the brake caliper.

Remove the brake pads.

16. REAR BRAKE/REAR FORK/REAR WHEEL/REAR SHOCK ABSORBER

Remove the piston from the brake caliper.
If necessary, use compressed air to squeeze out the piston through the brake fluid inlet opening and place a towel under the caliper to avoid contamination caused by the removed piston.
Check the piston cylinder for scratches or wear and replace if necessary.

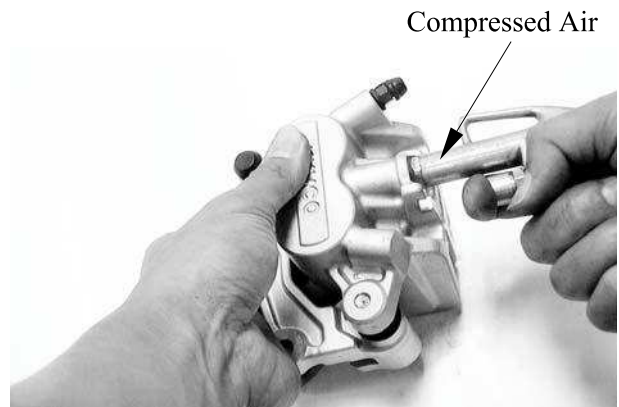

Check the caliper cylinder for scratches or wear and measure the cylinder bore.



16. REAR BRAKE/REAR FORK/REAR WHEEL/REAR SHOCK ABSORBER DOWNTOWN 125i

ASSEMBLY

Install the two spring plates onto the groove of the caliper.

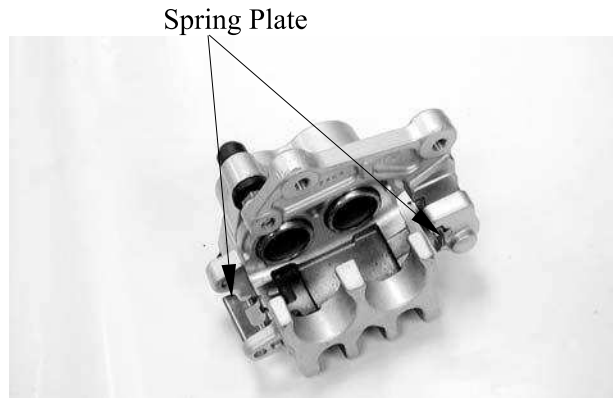

* Make sure the spring plate next to the brake pad dowel pin orientation.

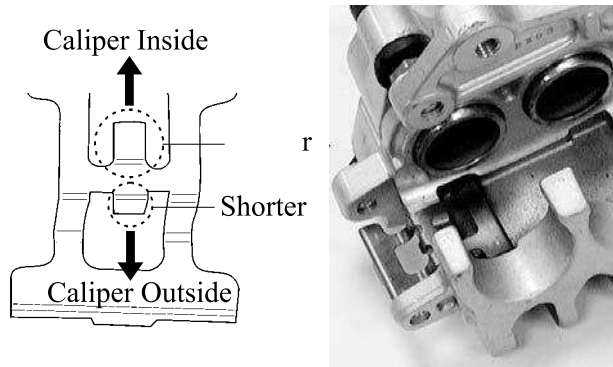

Install two brake pads.

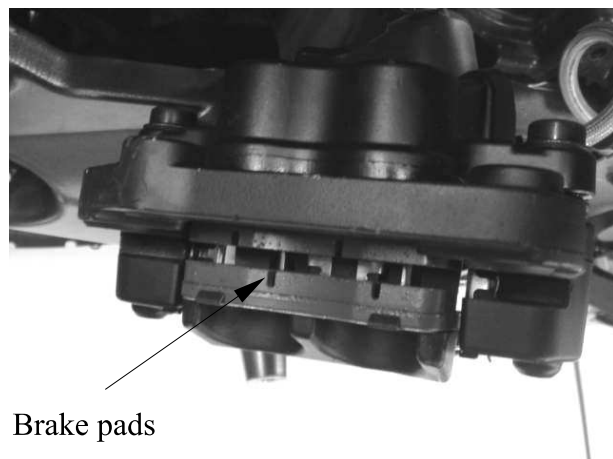

16. REAR BRAKE/REAR FORK/REAR WHEEL/REAR SHOCK ABSORBER

INSTALLATION

Install the brake caliper to the rear fork and tighten the two bolts.

Torque: 27 N-m

Connect the brake fluid tube to the brake caliper and install fluid tube bolt, copper washers and tighten the fluid tube bolt.

Fill the brake reservoir with the specified brake fluid and bleed air from the brake system.

* When installing the brake fluid tube, be sure to install the two copper sealing washers.

REAR FORK

REMOVAL

Remove the exhaust muffler.
Remove the rear brake caliper.

Remove the right rear shock absorber lower mount bolt.
Remove the rear axle nut and remove the collar.
Remove the rear fork.

The installation sequence is the reverse of removal.

Fluid Tube Bolt

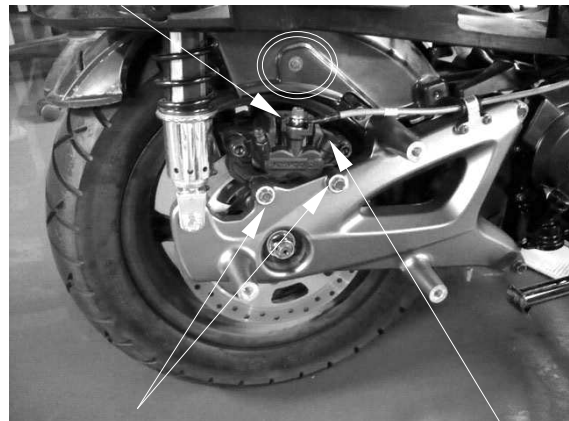

Bolts

Brake Caliper



Rear Axle Nut
Bolt

Rear Brake Caliper

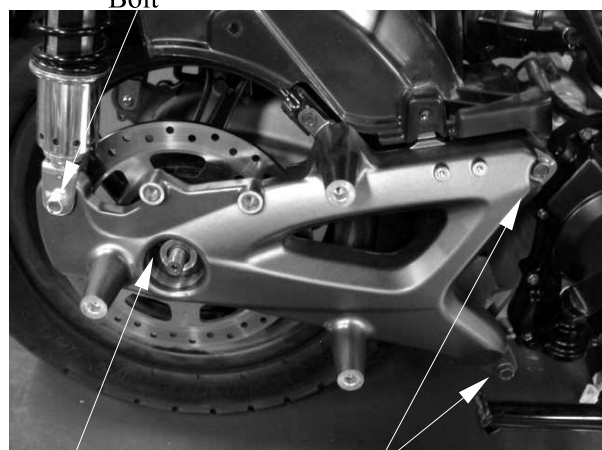

Collar

Bolts

16. REAR BRAKE/REAR FORK/REAR WHEEL/REAR SHOCK ABSORBER DOWNTOWN 125i



REAR WHEEL

REMOVAL

- Remove the exhaust muffler.
- Remove the rear brake caliper.
- Remove the rear fork.
- Remove the rear axle collar.
- Remove the rear wheel.



Rear Brake Disk

Rear Axle Collar

INSTALLATION

The installation sequence is the reverse of removal.

Torque:

- Rear shock absorber lower mount bolt: 35~45N-m
- Rear axle nut: 120N-m



Collar

Bolts

REAR SHOCK ABSORBER

REMOVAL

- Remove the met-in box and carrier.
- Remove the body cover, center cover and rear fender A together.
- Remove the right/left rear shock absorber upper and lower mount bolts.
- Remove the right and left rear shock absorbers.



16. REAR BRAKE/REAR FORK/REAR WHEEL/REAR SHOCK ABSORBER

INSTALLATION

Install the rear suspension in the reverse order of removal.

Torque:

Upper Mount Bolt: 40 N-m

Lower Mount Bolt: 40 N-m

Suspension

Each shock absorber ⑨ on your scooter has 5 spring preload adjustment positions for different load or riding conditions.

Use a pin spanner ⑩ to adjust the rear shock spring preload. Position 1 is for light loads and smooth road conditions. Position 3 to 5 increase spring preload for a stiffer rear suspension and can be used when the scooter is heavily loaded. Be certain to adjust both shock absorbers to the same spring preload positions.

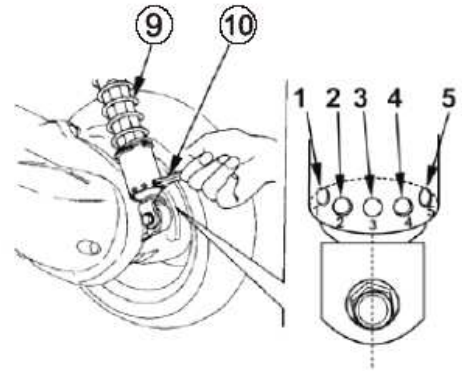

Standard spring preload position: 3

CAUTION

Always adjust the shock absorber pre-load position in sequence (1-2-3-4-5 or 5-4-3-2-1). Attempting to adjust directly from 1 to 5 or 5 to 1 may damage the shock absorber.

17. BATTERY/CHARGING SYSTEM

17

BATTERY/CHARGING SYSTEM

CHARGING SYSTEM LAYOUT	17-1
CHARGING CIRCUIT	17-1
SERVICE INFORMATION.....	17-2
TROUBLESHOOTING.....	17-3
BATTERY	17-4
CHARGING VOLTAGE INSPECTION	17-6
REGULATOR/RECTIFIER	17-7

17. BATTERY/CHARGING SYSTEM

CHARGING SYSTEM LAYOUT

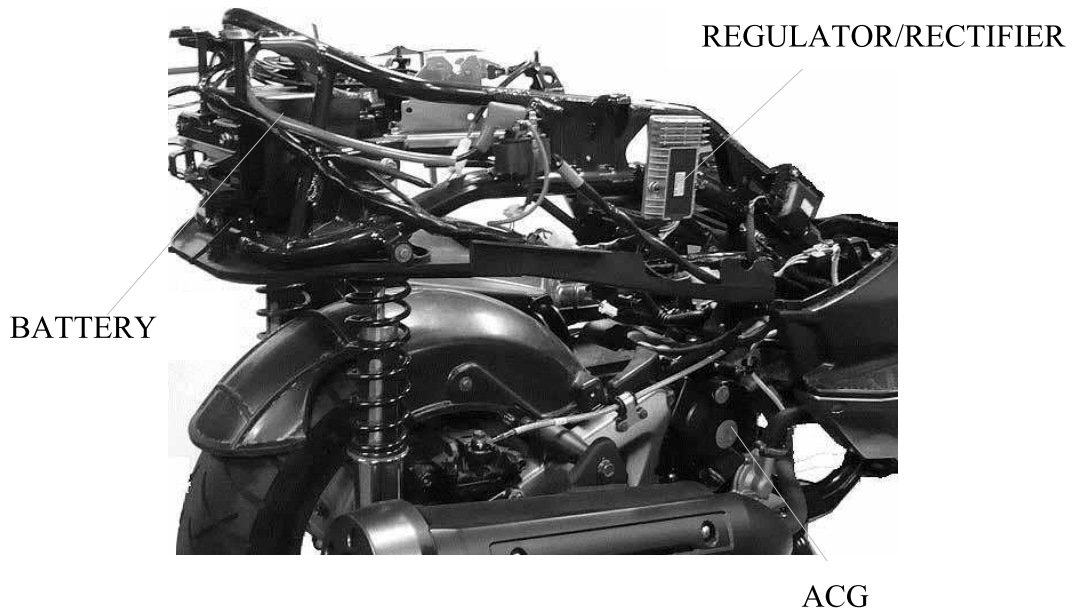

17. BATTERY/CHARGING SYSTEM

SERVICE INFORMATION

GENERAL INSTRUCTIONS

* The battery electrolyte (sulfuric acid) is poisonous and may seriously damage the skin and eyes. Avoid contact with skin, eyes, or clothing. In case of contact, flush with water and get prompt medical attention

- The battery can be charged and discharged repeatedly. If a discharged battery is not used for a long time, its service life will be shortened. Generally, the capacity of a battery will decrease after it is used for 2~3 years. A capacity-decreased battery will resume its voltage after it is recharged but its voltage decreases suddenly and then increases when a load is added.
- When a battery is overcharged, some symptoms can be found. If there is a short circuit inside the battery, no voltage is produced on the battery terminals. If the rectifier can not be operated, the voltage will become too high and shorten the battery service life.
- If a battery is not used for a long time, it will discharge by itself and should be recharged every 3 months.
- A new battery filled with electrolyte will generate voltage within a certain time and it should be recharged when the capacity is insufficient. Recharging a new battery will prolong its service life.
- Inspect the charging system according to the sequence specified in the Troubleshooting.
- It is not necessary to check the MF battery electrolyte or fill with distilled water.
- Check the load of the whole charging system.
- Do not quick charge the battery. Quick charging should only be done in an emergency.
- Remove the battery from the motorcycle for charging.
- When replacing the battery, do not use a traditional battery.
- When charging, check the voltage with an electric tester.

Caution:

To avoid damage from the scooter's electronic fuel injection system, do not remove or install a battery wire when the ignition switch is at the "ON" position.

SPECIFICATIONS

Item		Standard	
Battery	Capacity	12V10AH	
	Voltage (20°C)	Fully charged	13.2V
		Insufficient charged	12.3V below
	Charging current	Normal	1.2AX5~10H
Quick		5.0AX1H	

17. BATTERY/CHARGING SYSTEM

TROUBLESHOOTING

No power

- Dead battery
- Disconnected battery cable
- Fuse burned out
- Faulty ignition switch

Low power

- Weak battery
- Loose battery connection
- Charging system failure
- Faulty regulator/rectifier

Intermittent power

- Loose battery cable connection
- Loose charging system connection
- Loose connection or short circuit in ignition system

Charging system failure

- Loose, broken or shorted wire or connector
- Faulty regulator/rectifier
- Faulty A.C. generator

17. BATTERY/CHARGING SYSTEM

BATTERY

REMOVAL/INSTALLATION

The battery is in the battery box behind seat.

1. Remove the seat.
2. Remove the met-in box

3. Remove four screws and then remove the battery retainer



4. Pull battery out to expose the terminal leads
5. Disconnect the negative (-) terminal lead (3) from the battery first, then disconnect the positive (+) terminal lead (4).
6. Remove the battery from the battery box.

(4)

(3)



Battery installation:

Install in the reverse order of the removal.

* When install the battery, first connect the positive (+) cable and then negative (-) cable to avoid short circuit.

17. BATTERY/CHARGING SYSTEM

*

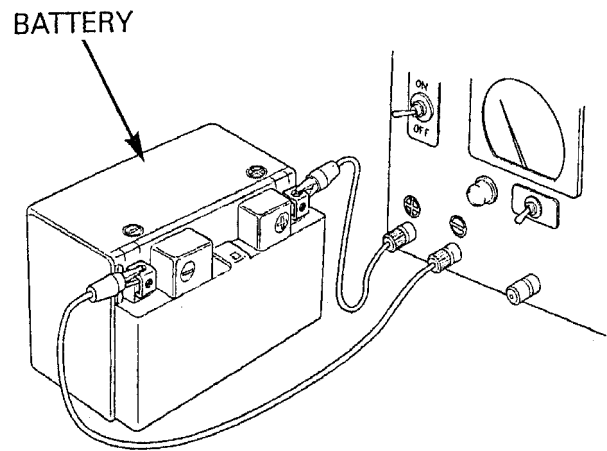

17. BATTERY/CHARGING SYSTEM

CHARGING VOLTAGE INSPECTION

Be sure that the battery is in good condition before performing this test.

- * Do not disconnect the battery or any cable in the charging system without first switching off the ignition switch. Failure to follow this precaution can damage the tester or electrical components.

Connect the multimeter between the positive and negative terminals of the battery.

To prevent short, make absolutely certain which are the positive and negative terminals or cable.

With the headlight on and turned to the high beam position, restart the engine.

Measure the voltage on the multimeter when the engine runs at 5000 min (rpm).

Standard:

Measure charging voltage

14.5±0.5 V



17. BATTERY/CHARGING SYSTEM

REGULATOR/RECTIFIER

WIRE HARNESS INSPECTION

Remove the luggage box (refer to the “**FRAME COVERS REMOVAL/INSTALLATION**” section in the chapter 2).

Disconnect the regulator/rectifier connectors (1).

Check the connector for loose contacts of corroded terminals.

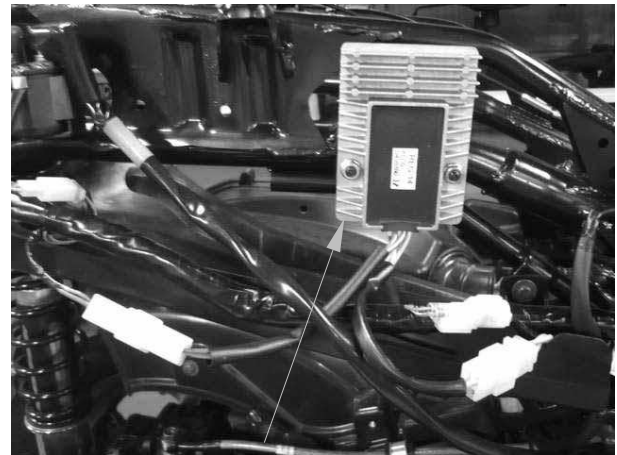

Regulator/Rectifier

Measure the voltage between the Red/White wire terminal and ground.
There should be same with battery voltage at all times.

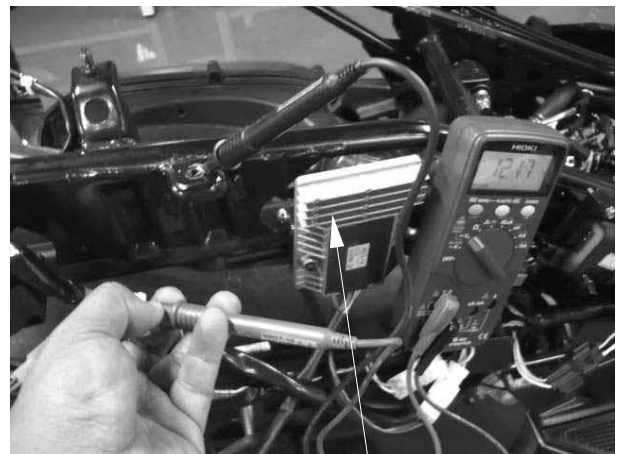

Regulator/Rectifier

17. BATTERY/CHARGING SYSTEM

Check the continuity between the Green wire terminal and ground.

There should be continuity at all times.



Measure the resistance between each Yellow wire terminals.

Standard: 0.4 – 0.6 Ω (20°C/68°F)



Disconnect the regulator/rectifier connector.

Check for continuity between each Yellow wire terminal regulator/rectifier side and ground.

There should be no continuity.

17. BATTERY/CHARGING SYSTEM

REMOVAL/INSTALLATION

Remove the body cover (refer to the “**FRAME COVERS REMOVAL/INSTALLATION**” section in the chapter 2).

Disconnect the regulator/rectifier connectors (1).

Remove the two bolts (2), attaching regulator/rectifier (3).

Installation is in the reverse order of removal.

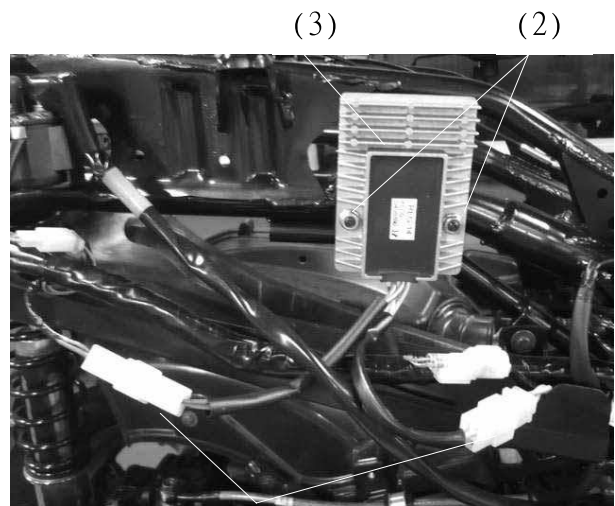

(1)

18. IGNITION SYSTEM

18

IGNITION SYSTEM

IGNITION SYSTEM LAYOUT	18-1
SERVICE INFORMATION.....	18-2
TROUBLESHOOTING.....	18-3
IGNITION COIL INSPECTION	18-4

18. IGNITION SYSTEM

IGNITION SYSTEM LAYOUT

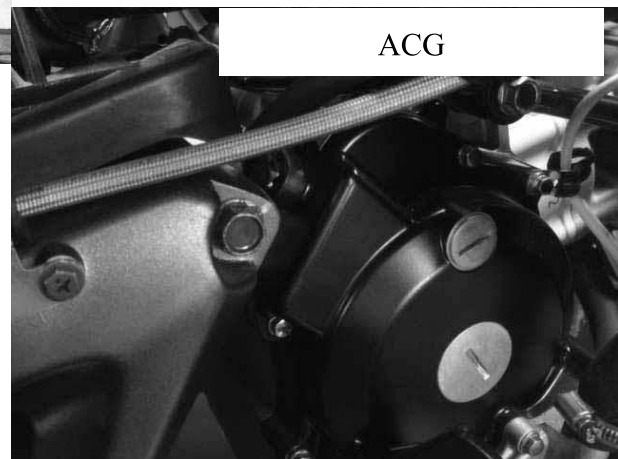
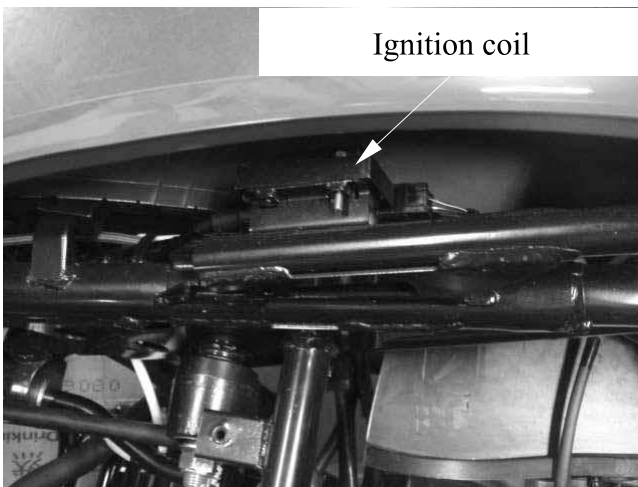
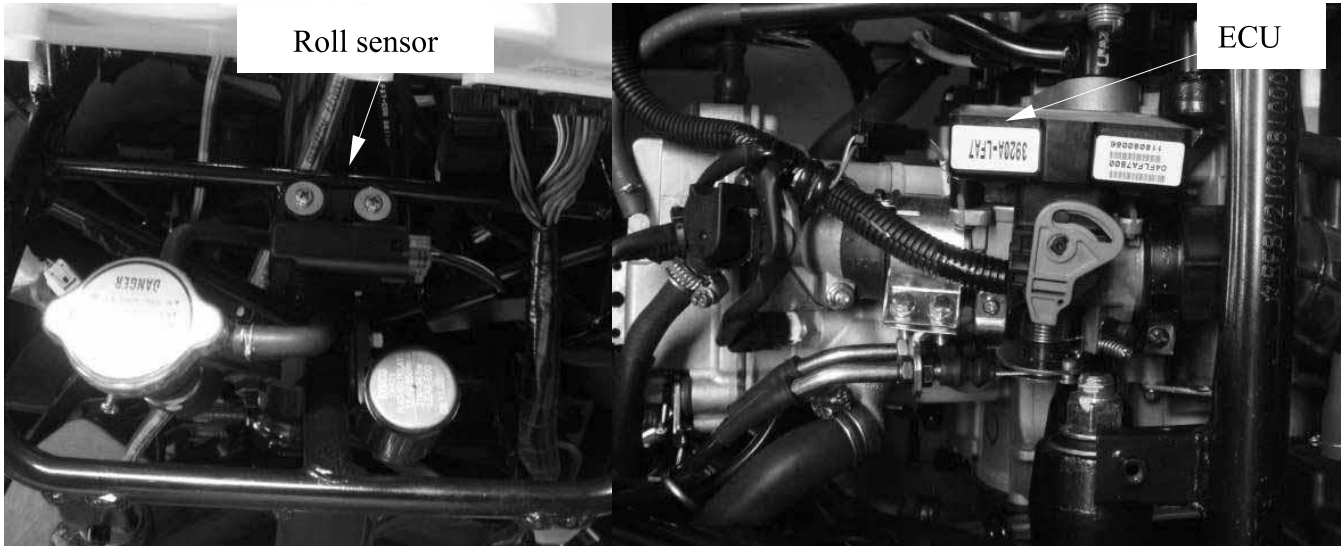

18. IGNITION SYSTEM

SERVICE INFORMATION

GENERAL INSTRUCTIONS

Some electrical components may be damaged if terminals or connectors are connected or disconnected while the ignition switch is “ON” and current is present.

- When servicing the ignition system, always follow the steps in the troubleshooting..
- The ignition control module or ECU may be damaged if dropped. Also, if the connector is disconnected when current is flowing, the excessive voltage may damage the ignition control module or ECU. Always turn off the ignition switch before servicing.
- A faulty ignition system is often related to poor connections. Check those connections before proceeding.
- Make sure the battery is adequately charged. Using the starter motor with a weak battery results in a slower engine cranking speed as well as no spark at the spark plug.
- Use a spark plug of the correct heat range. Using spark plug with an incorrect heat range can damage the engine.

SPECIFICATIONS

Item	Standard
Spark plug	NGK CR7E
Spark plug gap	0.6~0.7mm
Ignition timing	TPS
Ignition system	ECU

18. IGNITION SYSTEM

TROUBLESHOOTING

LOW PEAK VOLTAGE

- Cranking speed is too low (battery is undercharged).
- Poorly connected connectors or an open circuit in the ignition system.
- Faulty ignition-coil.
- Faulty ignition control module.

NO PEAK VOLTAGE

- Short circuit in engine stop switch or ignition switch wire.
- Faulty engine stop switch or ignition switch.
- Loose or poorly connected ignition control module connectors.
- Open circuit or poor connection in ground wire of the ignition control module.
- Faulty ignition pulse generator.
- Faulty ignition control module.

PEAK VOLTAGE IS NORMAL, BUT NO SPARK JUMPS AT THE PLUG

- Faulty spark plug or leaking ignition coil secondary current.
- Faulty ignition coil.

18. IGNITION SYSTEM

IGNITION COIL INSPECTION

IGNITION COIL PRIMARY PEAK VOLTAGE

Remove the body cover (refer to the “**FRAME COVERS REMOVAL/INSTALLATION**” section in the chapter 2).

Check cylinder compression and check that the spark plug (1) is installed correctly in the cylinder.

Disconnect the spark plug cap (2) from the spark plug.

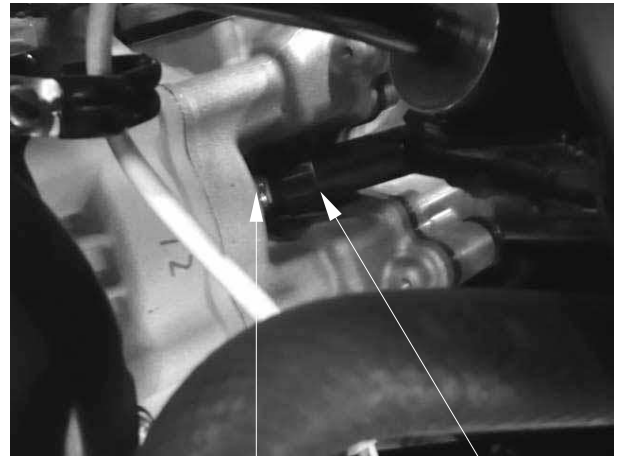

(1)

(2)

Turn the ignition switch to “ON” and engine stop switch ON and side stand is up.

Connect the multimeter (+) probe to the black wire and the multimeter (-) to the body ground.

Check for initial voltage at this time.

The battery voltage should be measured.

If the initial voltage cannot be measured, check the power output circuit.

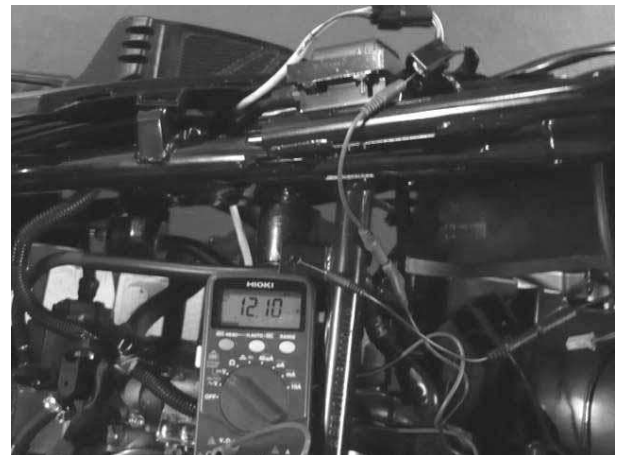

:

18. IGNITION SYSTEM

IGNITION PULSE GENERATOR INSPECTION

Remove the luggage box (refer to the “**FRAME COVERS REMOVAL/INSTALLATION**” section in the chapter 2).

Disconnect the ignition pulse generator connector (1).



Measure the pulse generator resistance between the Green/White wire and Blue/Yellow wire.

Standard:

96~144Ω (20°C/68°F)



18. IGNITION SYSTEM

IGNITION COIL REMOVAL/INSTALLATION

Remove the luggage box (refer to the “**FRAME COVERS REMOVAL/INSTALLATION**” section in the chapter 2).

Disconnect the spark plug cap attaching the spark plug (1).



(1) (3)

Disconnect the ignition coil connector (2).
Remove two bolts (3) attaching the ignition coil (4).



(2) (4)

Installation is in the reverse order of removal.

19. STARTING SYSTEM



STARTING SYSTEM

19

STARTING SYSTEM LAYOUT	19-1
STARTING CIRCUIT	19-1
SERVICE INFORMATION.....	19-2
TROUBLESHOOTING.....	19-2
STARTER MOTOR	19-3
STARTER RELAY INSPECTION.....	19-5

19. STARTING SYSTEM

STARTING SYSTEM LAYOUT

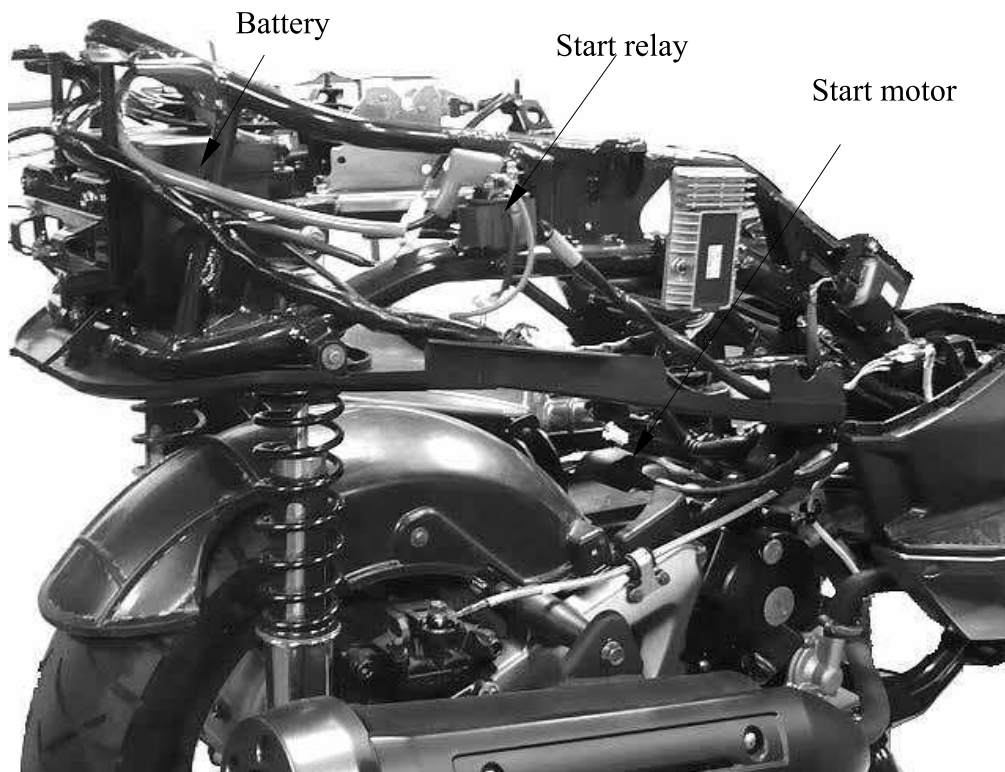

19. STARTING SYSTEM

SERVICE INFORMATION

GENERAL INSTRUCTIONS

- The removal of starter motor can be accomplished with the engine installed.
- After the starter clutch is installed, be sure to add the engine oil and coolant and then bleed air from the cooling system.

TORQUE VALUES

Starter motor mounting bolt 1 kgf-m (10 N-m,)

TROUBLESHOOTING

Starter motor can not working

- Fuse burned out
- Weak battery
- Faulty ignition switch
- Faulty starter clutch
- Faulty front or rear stop switch
- Faulty starter relay
- Poorly connected, broken or shorted wire
- Faulty starter motor

Lack of power

- Weak battery
- Loose wire or connection
- Foreign matter stuck in starter motor or gear

Starter motor rotates but engine does not start

- Faulty starter pinion
- Starter motor rotates reversely
- Weak battery

19. STARTING SYSTEM

STARTER MOTOR

INSPECTION

Disconnect the starter motor cable (2) from the start relay(1).

Connect the start motor cable directly to the battery positive terminal (3).
If the starter motor fail to work, the starter motor is faulty.

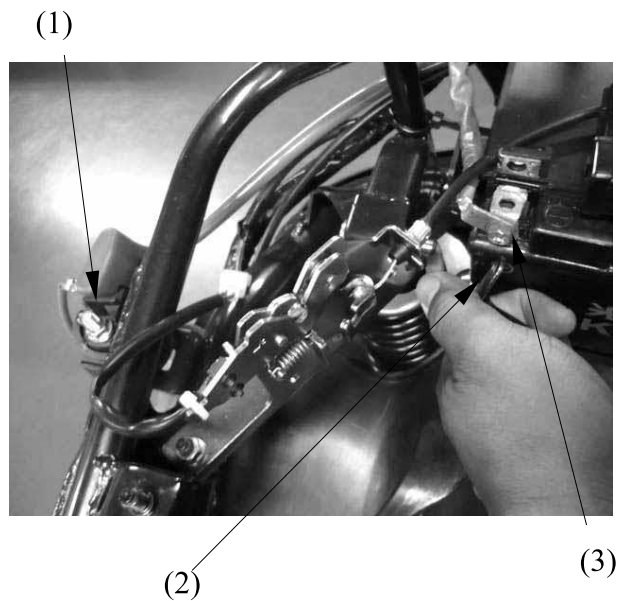

REMOVAL

Turn the ignition switch turned to “OFF” position.
Release the rubber cap (1) and remove the terminal screw (2) to disconnect the start motor cable from the start motor.

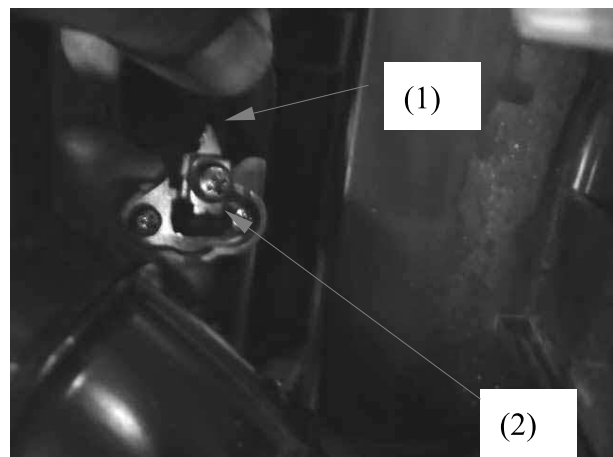

Remove two mounting bolts (3) , then remove the start motor.

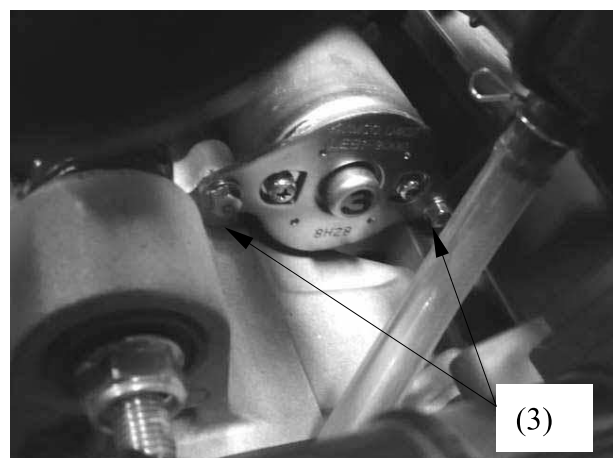

19. STARTING SYSTEM

INSTALLATION

Coat a new O-ring (1) with engine oil and install it into the start motor groove.

Install the starter motor into the crankcase.

Install the two mounting bolts and engine ground cable, then tighten the bolts securely.

Connect the start motor cable to motor terminal with the terminal screw and tighten it securely.

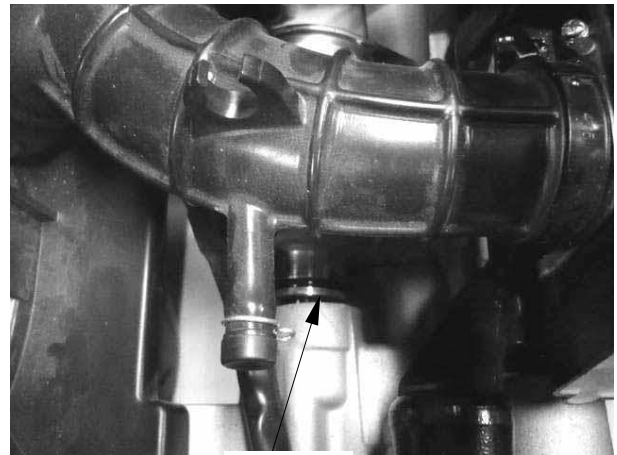

(1)

19. STARTING SYSTEM

START RELAY INSPECTION

Release the rubber cap (1) and remove the nut (2), then disconnect the start motor cable. Turn the ignition switch to “ON” position.

Squeeze and hold the brake lever fully then push the starter switch.

The coil is normal if the start relay switch clicks.



(2) (1)

Release the rubber caps (1) and remove the nuts (2), then disconnect the start motor cable, battery positive cable and harness wire.

Disconnect the start relay connector (3) and then remove start relay.

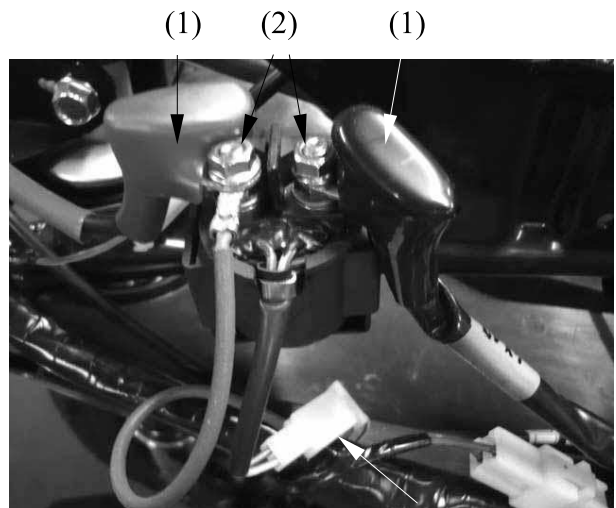

(3)

Connect a fully charged 12 V battery positive wire to the relay switch Yellow/Red wire terminal and negative wire to the Green/Yellow wire terminal.

There should be continuity between the cable terminals while the battery is connected, and no continuity when the battery is disconnected.

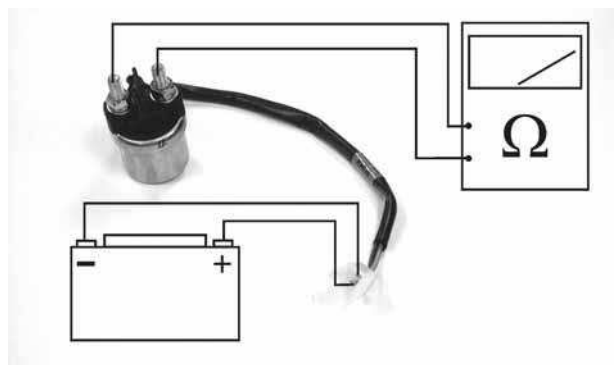

20. LIGHTS/METERS/SWITCHES

LIGHTS/METERS/SWITCHES

SERVICE INFORMATION-----	20- 1
BULB REPLACEMENT -----	20- 2
BRAKE LIGHT SWITCH-----	20- 6
IGNITION SWITCH -----	20- 6
HANDLEBAR SWITCH -----	20- 7
LUGGAGE BOX LIGHT SWITCH -----	20- 9
FUEL PUMP -----	20-10
SIDE STAND SWITCH -----	20-12
HORN -----	20-13

20. LIGHTS/METERS/SWITCHES

SERVICE INFORMATION

GENERAL

A halogen head light bulb becomes very hot while the head light is turned on, and remains for a while after it is turned off. Be sure to let it cool down before servicing.

- Note the following when replacing the halogen headlight bulb
 - Wear clean gloves while replacing the bulb. Do not put finger prints on the headlight bulb, as they may create hot spots on the bulb and cause it to fail.
 - If you touch the bulb with your bare hands, clean it with a cloth moistened with alcohol to prevent its early failure.
 - Be sure to install the dust cover after replacing the bulb.
- Check the battery condition before performing any inspection that requires proper battery voltage.
- A continuity test can be made with the light switches installed on the scooter.
- Route the wires and cables properly after servicing each component.

20. LIGHTS/METERS/SWITCHES

BULB REPLACEMENT

POSITION LIGHT

Remove the front cover (refer to the “**FRAME COVERS REMOVAL/INSTALLATION**” section in the chapter 2).

Remove the bulb socket (1).



(1)

Remove the bulb (2) and replace with a new one.

Installation is in the reverse order of removal.

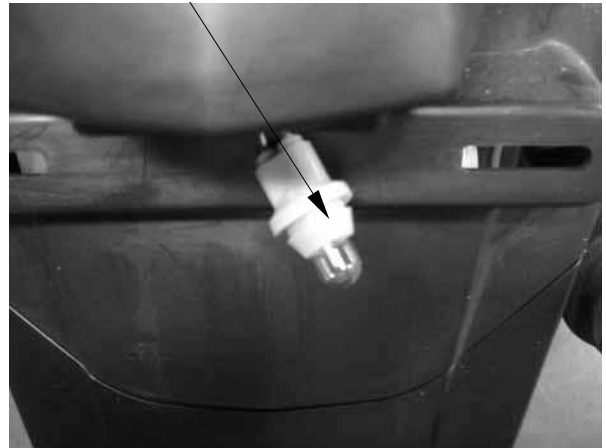

(2)



20. LIGHTS/METERS/SWITCHES

HEADLIGHT

A halogen headlight bulb becomes very hot while the headlight is ON, and remain for a while after it is turned OFF. Be sure to let it cool down before servicing.

Remove the front cover (refer to the “**FRAME COVERS REMOVAL/INSTALLATION**” section in the chapter 2).

Disconnect the headlight cover
Disconnect the headlight connector (1) from the headlight bulb (2).

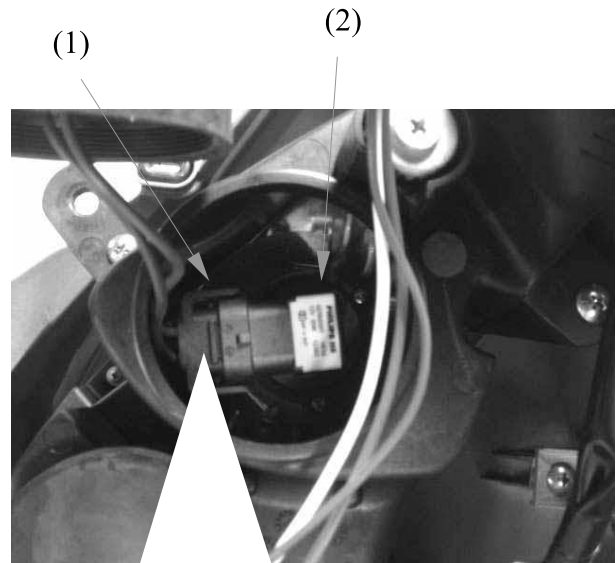

Install a new bulb in the headlight case,

Install the headlight and connect the headlight connector



20. LIGHTS/METERS/SWITCHES

FRONT TURN SIGNAL LIGHT

Remove the front cover (refer to the “**FRAME COVERS REMOVAL/INSTALLATION**” section in the chapter 2).

Turn the bulb socket (1), then remove the front turn signal light .

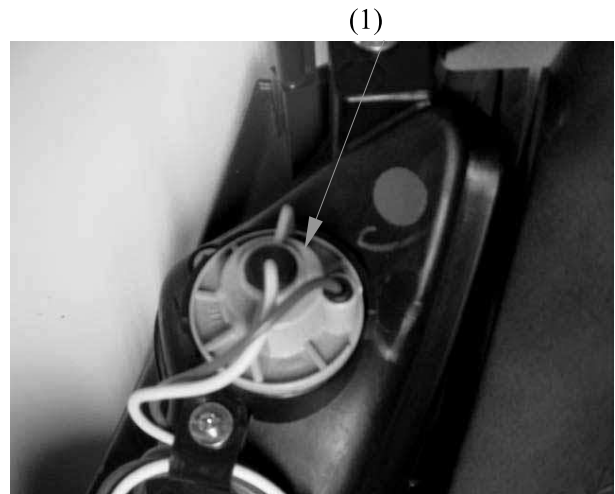

Push and turn the bulb counterclockwise to remove it, then replace with a new one..

Installation is in the reverse order of removal.



TAILLIGHT/BRAKE LIGHT/REAR TURN SIGNAL LIGHT

Remove the seat and luggage box, then remove the light bulb socket.



20. LIGHTS/METERS/SWITCHES

Rear turn signal light

Push and turn the bulb counterclockwise to remove it, then replace with a new one.

Installation is in the reverse order of removal.



Taillight/Brake light

Push and turn the bulb counterclockwise to remove it, then replace with a new one.

Installation is in the reverse order of removal.

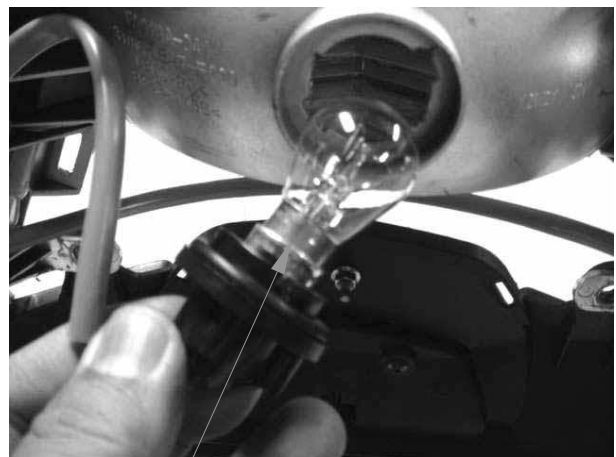

20. LIGHTS/METERS/SWITCHES

BRAKE LIGHT SWITCH

Remove the upper handlebar cover (refer to the **“FRAME COVERS REMOVAL/INSTALLATION”** section in the chapter 2).

Disconnect front or rear light switch connectors and check for continuity between the switch terminals (1).

There should be continuity with the front or rear brake lever squeezed, and there should be no continuity with the front or rear brake lever is released.

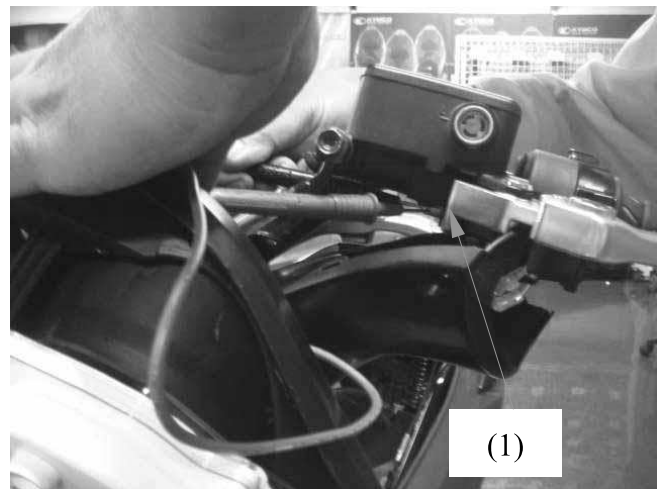

IGNITION SWITCH

INSPECTION

Remove the front cover (refer to the **“FRAME COVERS REMOVAL/INSTALLATION”** section in the chapter 2).

Disconnect the ignition switch connector (2) and check the ignition switch (1) for continuity at the switch side connector terminals.

Continuity should exist between the color code wires as follows:

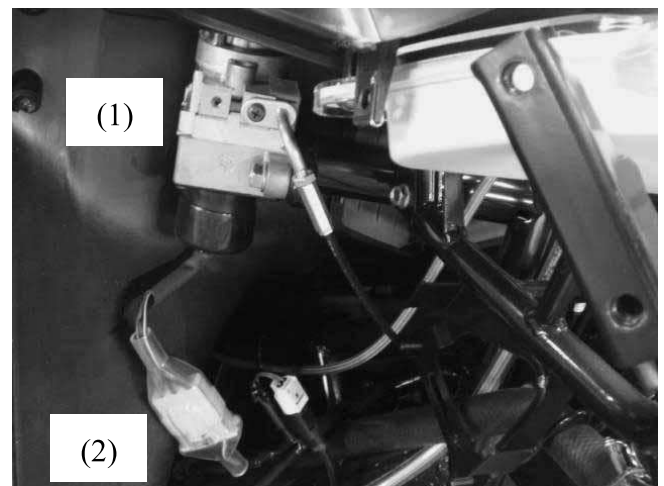

COMB SW

	BAT2	IG	E	BAT1	HA
LOCK		○—○			
OFF		○—○		○—○	
ON	○—			○—○	
COLOR	B	B/W	G	R	B/L

20. LIGHTS/METERS/SWITCHES

HANDLEBAR SWITCH

INSPECTION

Remove the front cover (refer to the “**FRAME COVERS REMOVAL/INSTALLATION**” section in the chapter 2).

Right handlebar switch

Disconnect the right handlebar switch connector and check for continuity for switch side connector terminals.

Continuity should exist between the color code wires as follows:

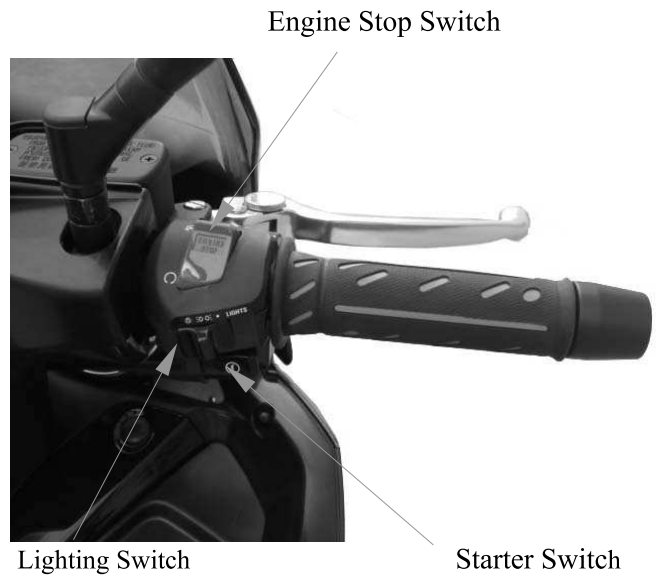

LIGHTING SW

	BAT3	PO	TL	HL
•				
(N)				
P	○	○	○	
(N)	○	○	○	○
H	○		○	○
COLOR	BR/L	BR/W	BR	W/L

STARTER SW

	E	ST
FREE		
PUSH	○	○
COLOR	G	Y/R

ENGINE STOP SW

	IG	BAT3
OFF		
RUN	○	○
COLOR	B/W	B/G

20. LIGHTS/METERS/SWITCHES

Left handlebar switch

Disconnect the left handlebar switch connector and check for continuity for switch side connector terminals.

Continuity should exist between the color code wires as follows:

WINKER SW			
	WR	R	L
R	○	○	
N			
L	○		○
COLOR	GR	SB	O

HORN SW		
	BAT4	HO
FREE		
PUSH	○	○
COLOR	BR/L	LG

DIMMER SW			
	HL	HI	LO
LO	○		○
(N)	○	○	○
HI	○	○	
COLOR	W/L	L	W

PASSING SW		
	BAT4	HI
FREE		
PUSH	○	○
COLOR	BR/L	L

Dimmer Switch



Horn Switch

Turn Signal light Switch

Passing Switch



20. LIGHTS/METERS/SWITCHES

LUGGAGE BOX LIGHT SWITCH

INSPECTION

Remove the luggage box (refer to the “**FRAME COVERS REMOVAL/INSTALLATION**” section in the chapter 2).

Disconnect the luggage box light switch connector (2) and check the luggage box light switch (1) for continuity between the switch terminals.

There should be no continuity with the luggage box light switch pushed, and there should be continuity with the luggage box light switch is released.

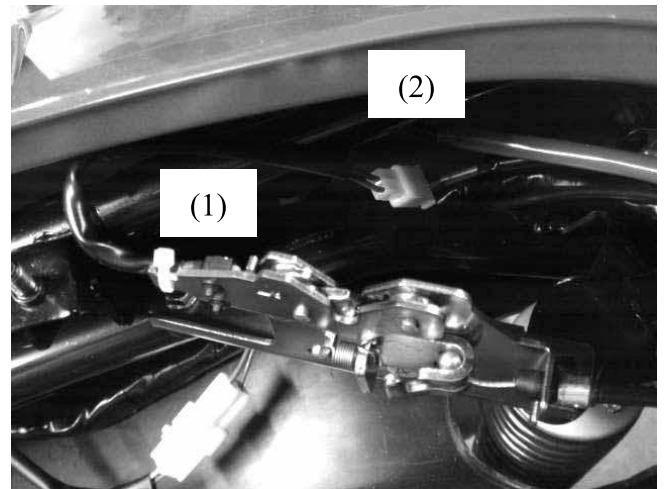

20. LIGHTS/METERS/SWITCHES

FUEL PUMP

REMOVAL

Remove the seat and luggage box
Remove the center cover
Remove the fuel pump connector
Be sure to relieve the fuel pressure
before removing fuel pump or fuel hose.

Remove the six nuts (1) and fuel unit
connector(2) then remove the fuel hose.(3)

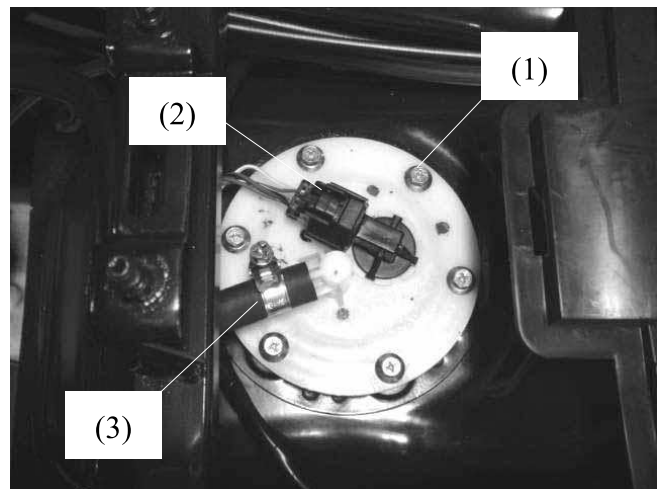

Take out the fuel pump(4)

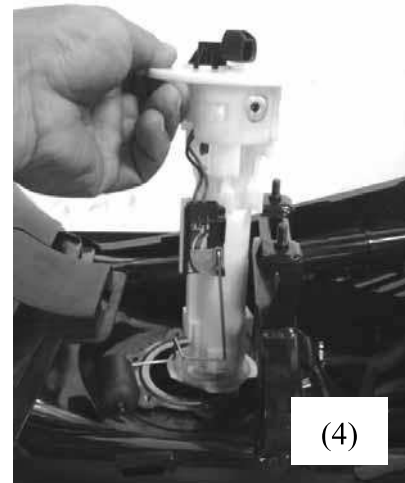

Check the fuel pump O-ring.(5)
Replace a new one If was damage

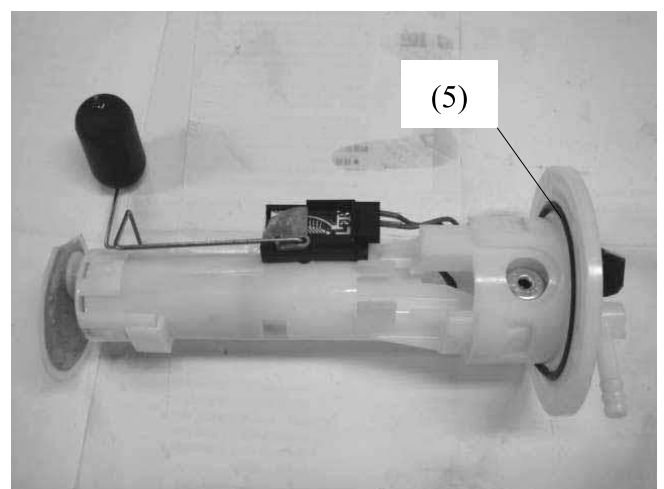

20. LIGHTS/METERS/SWITCHES

INSPECTION

Connect the fuel unit wire connectors and turn the ignition switch "ON".

Before performing the following test, operate the turn signals to determine that the battery circuit is normal.

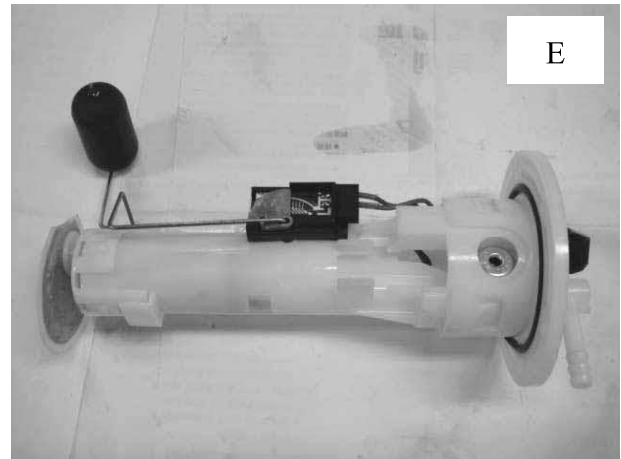
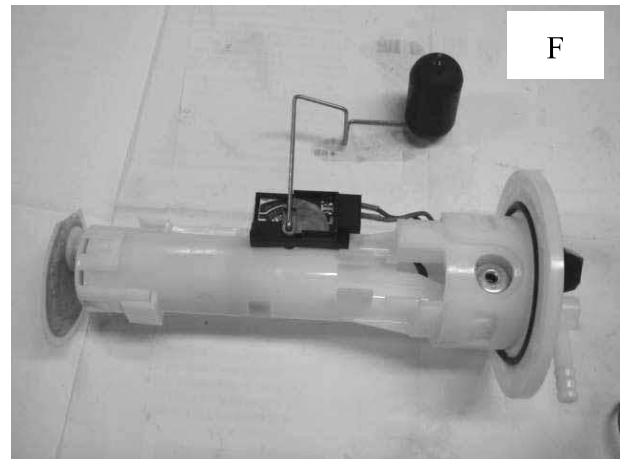

Measure the resistance between the Yellow/White and Blue/White terminals of the fuel unit connector.

Standard (at 20°C/68°F):

Float at full position	About 1100 Ω
Float at empty position	About 100 Ω

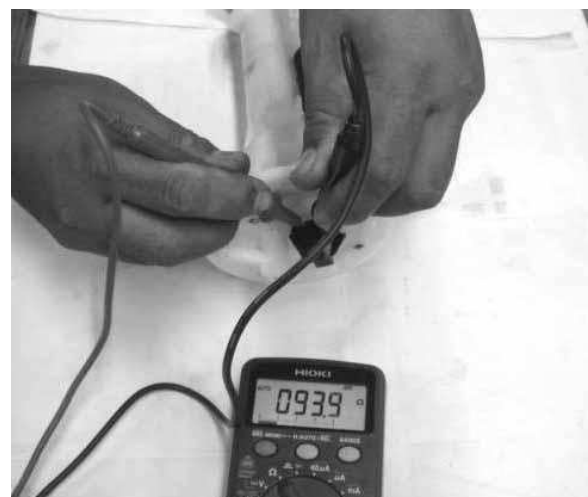

20. LIGHTS/METERS/SWITCHES

SIDE STAND SWITCH

INSPECTION

Remove the luggage box (refer to the “**FRAME COVERS REMOVAL/INSTALLATION**” section in the chapter 2).

Side stand switch is located on side stand

Disconnect the side stand switch connector (1).

There should be continuity between the Yellow/Green and Green with the side stand retracted.

There should be continuity between the Yellow/Black and Green with the side stand applied.

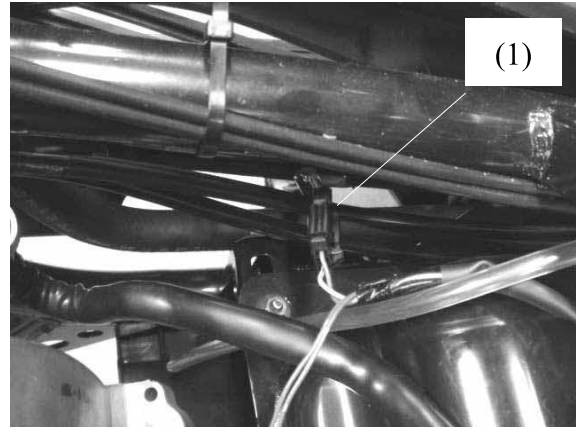

REMOVAL

Disconnect the side stand switch connector.
Remove the bolt (1) and side stand switch attaching the side stand.

INSTALLATION

Installs the side stand switch aligning the groove on the switch with the pin on the side stand stay.

Install and tighten the side stand switch bolt securely.

Connect the side stand switch connector.

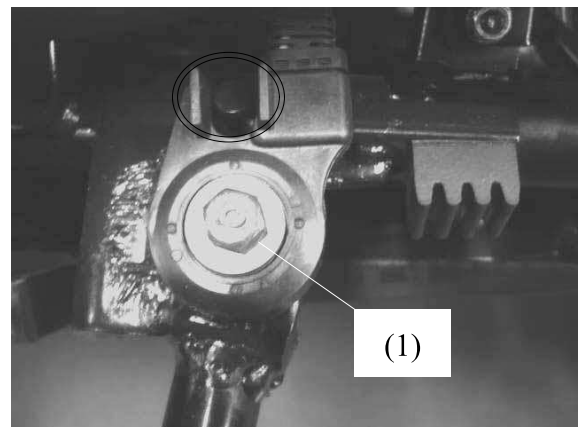

20. LIGHTS/METERS/SWITCHES

HORN

INSPECTION

Remove the front cover (refer to the “**FRAME COVERS REMOVAL/INSTALLATION**” section in the chapter 2)

Disconnect the horn connectors (1) from the horn.

Connect a 12 V battery to the horn terminals. The horn is normal if it sounds when the 12 V battery is connected across the horn terminals.

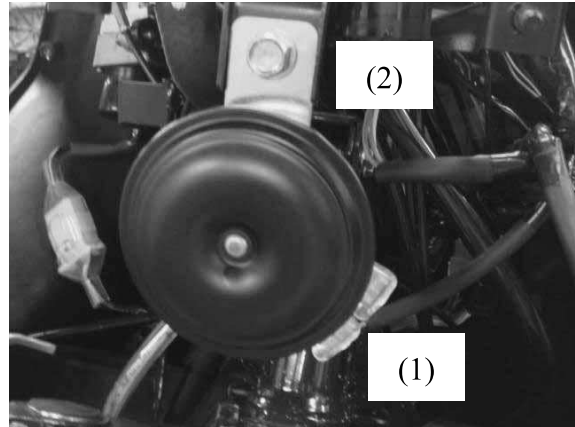

REMOVAL/INSTALLATION

Disconnect the horn connectors from the horn.

Remove the bolt (2) and horn.

Installation is in the reverse order of removal.

18. IGNITION SYSTEM

18

IGNITION SYSTEM

IGNITION SYSTEM LAYOUT -----	18-1
SERVICE INFORMATION-----	18-2
TROUBLESHOOTING-----	18-3
IGNITION COIL INSPECTION -----	18-4
IGNITION CIRCUIT -----	18-7

18. IGNITION SYSTEM

IGNITION SYSTEM LAYOUT

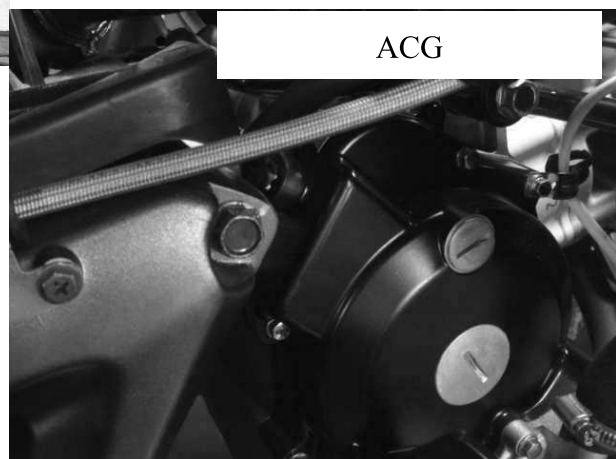
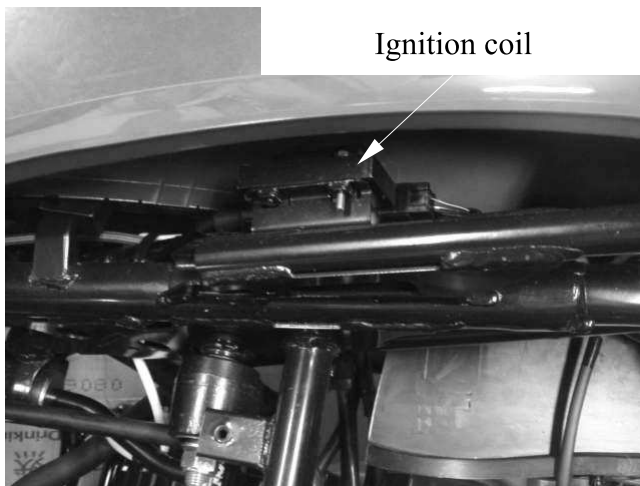
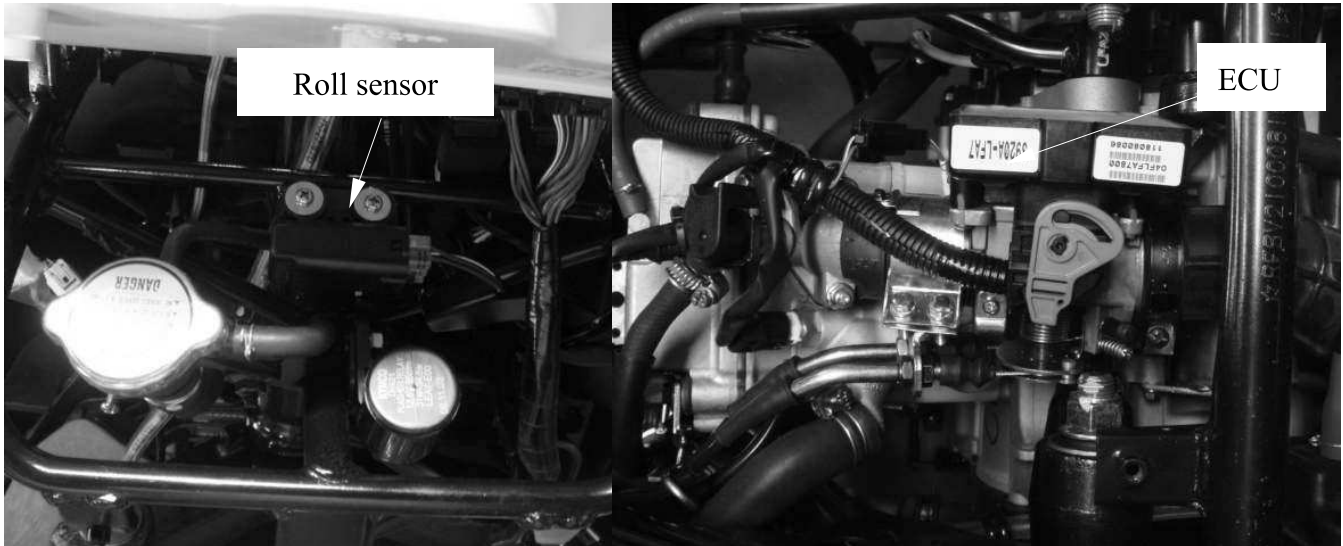

18. IGNITION SYSTEM

SERVICE INFORMATION

GENERAL INSTRUCTIONS

Some electrical components may be damaged if terminals or connectors are connected or disconnected while the ignition switch is “ON” and current is present.

- When servicing the ignition system, always follow the steps in the troubleshooting..
- The ignition control module or ECU may be damaged if dropped. Also, if the connector is disconnected when current is flowing, the excessive voltage may damage the ignition control module or ECU. Always turn off the ignition switch before servicing.
- A faulty ignition system is often related to poor connections. Check those connections before proceeding.
- Make sure the battery is adequately charged. Using the starter motor with a weak battery results in a slower engine cranking speed as well as no spark at the spark plug.
- Use a spark plug of the correct heat range. Using spark plug with an incorrect heat range can damage the engine.

SPECIFICATIONS

Item	Standard
Spark plug	NGK CR7E
Spark plug gap	0.6~0.7mm
Ignition timing	TPS
Ignition system	ECU

18. IGNITION SYSTEM

TROUBLESHOOTING

LOW PEAK VOLTAGE

- Cranking speed is too low (battery is undercharged).
- Poorly connected connectors or an open circuit in the ignition system.
- Faulty ignition-coil.
- Faulty ignition control module.

NO PEAK VOLTAGE

- Short circuit in engine stop switch or ignition switch wire.
- Faulty engine stop switch or ignition switch.
- Loose or poorly connected ignition control module connectors.
- Open circuit or poor connection in ground wire of the ignition control module.
- Faulty ignition pulse generator.
- Faulty ignition control module.

PEAK VOLTAGE IS NORMAL, BUT NO SPARK JUMPS AT THE PLUG

- Faulty spark plug or leaking ignition coil secondary current.
- Faulty ignition coil.

18. IGNITION SYSTEM

IGNITION COIL INSPECTION

IGNITION COIL PRIMARY PEAK VOLTAGE

Remove the body cover (refer to the **“FRAME COVERS REMOVAL/INSTALLATION”** section in the chapter 2).

Check cylinder compression and check that the spark plug (1) is installed correctly in the cylinder.

Disconnect the spark plug cap (2) from the spark plug.

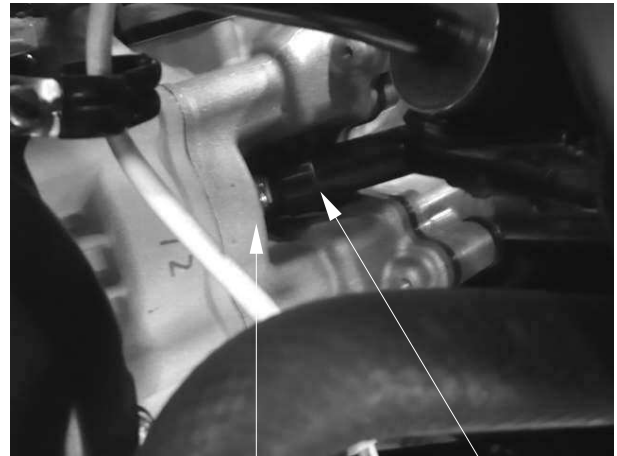

(1)

(2)

Turn the ignition switch to “ON” and engine stop switch ON and side stand is up.

Connect the multimeter (+) probe to the black wire and the multimeter (-) to the body ground.

Check for initial voltage at this time.

The battery voltage should be measured.

If the initial voltage cannot be measured, check the power output circuit.



:

18. IGNITION SYSTEM

IGNITION PULSE GENERATOR INSPECTION

Remove the luggage box (refer to the “**FRAME COVERS REMOVAL/INSTALLATION**” section in the chapter 2).

Disconnect the ignition pulse generator connector (1).

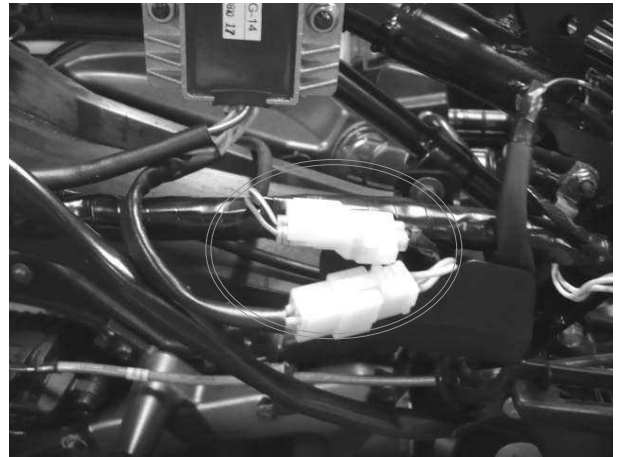

Measure the pulse generator resistance between the Green/White wire and Blue/Yellow wire.

Standard:

96~144Ω (20°C/68°F)



18. IGNITION SYSTEM

IGNITION COIL REMOVAL/INSTALLATION

Remove the luggage box (refer to the “**FRAME COVERS REMOVAL/INSTALLATION**” section in the chapter 2).

Disconnect the spark plug cap attaching the spark plug (1).



(1)

Disconnect the ignition coil connector (2).
Remove two bolts (3) attaching the ignition coil (4).

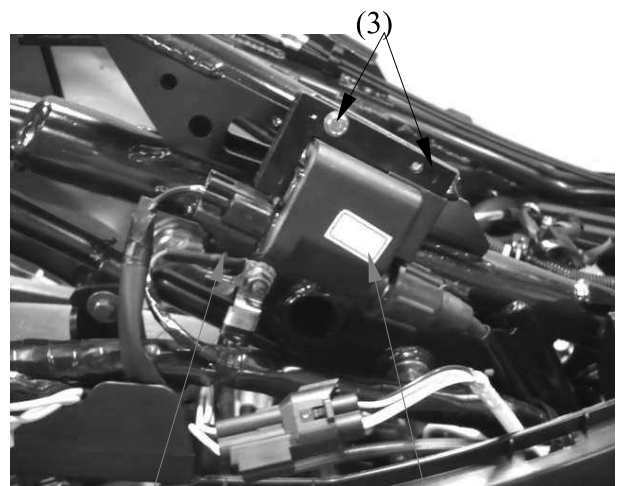

(2)

(4)

Installation is in the reverse order of removal.

18. IGNITION SYSTEM

IGNITION CIRCUIT

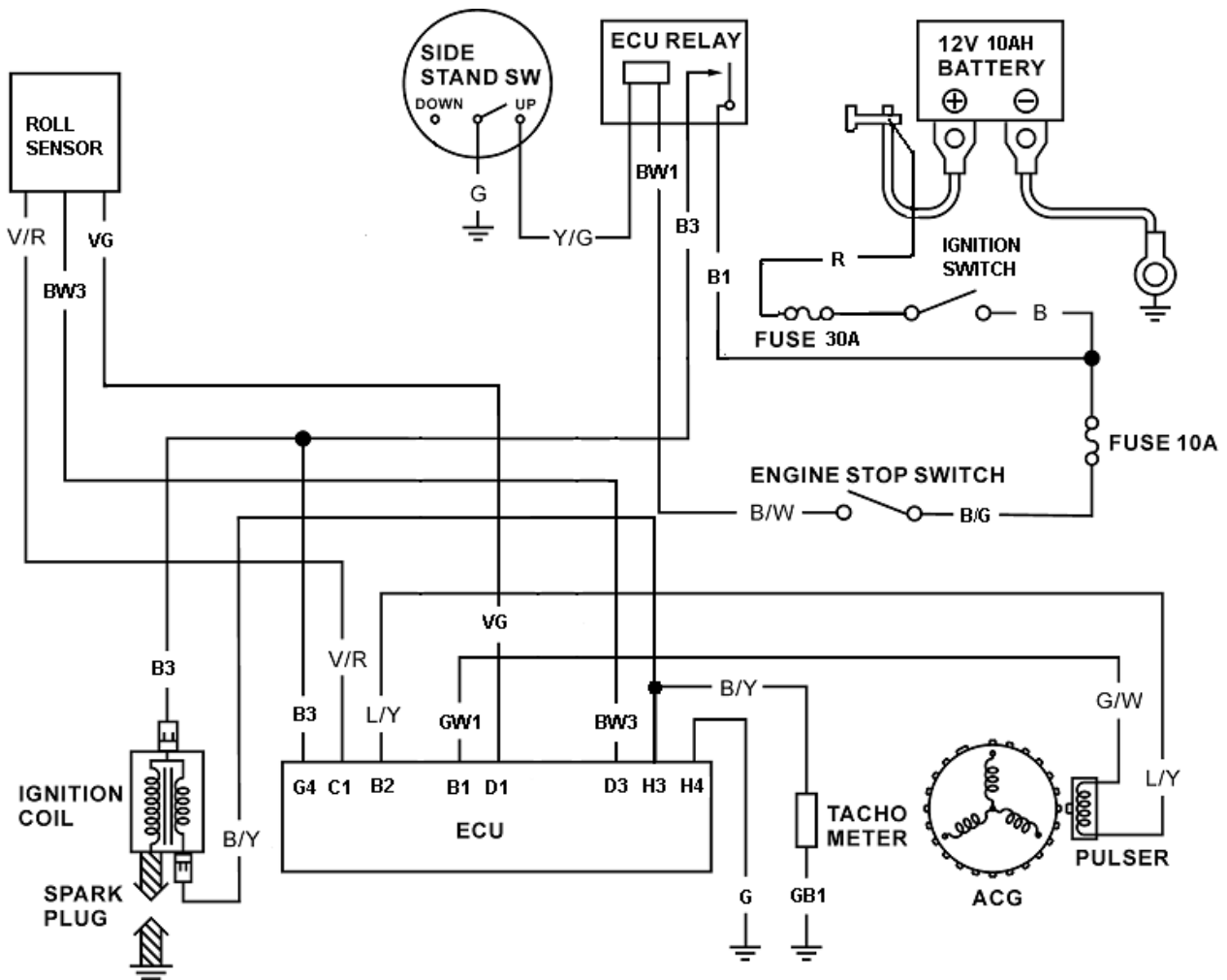

19. STARTING SYSTEM



STARTING SYSTEM

19

STARTING SYSTEM LAYOUT	19-1
STARTING CIRCUIT	19-1
SERVICE INFORMATION.....	19-2
TROUBLESHOOTING.....	19-2
STARTER MOTOR	19-3
STARTER RELAY INSPECTION.....	19-5

19. STARTING SYSTEM

STARTING SYSTEM LAYOUT

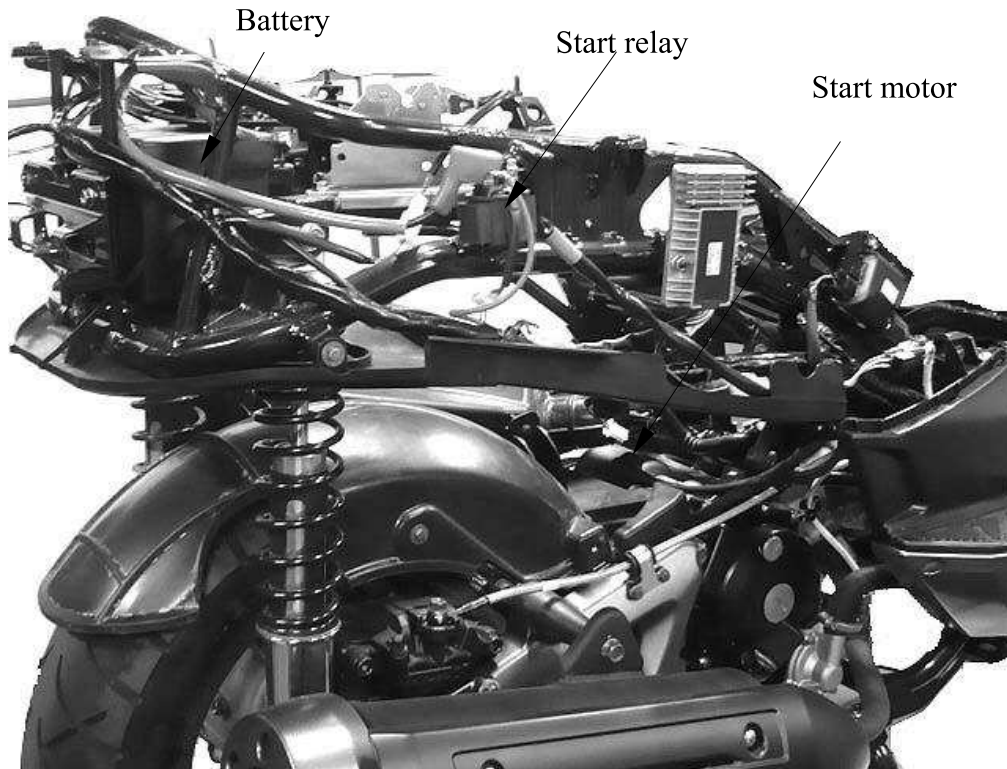

STARTING CIRCUIT

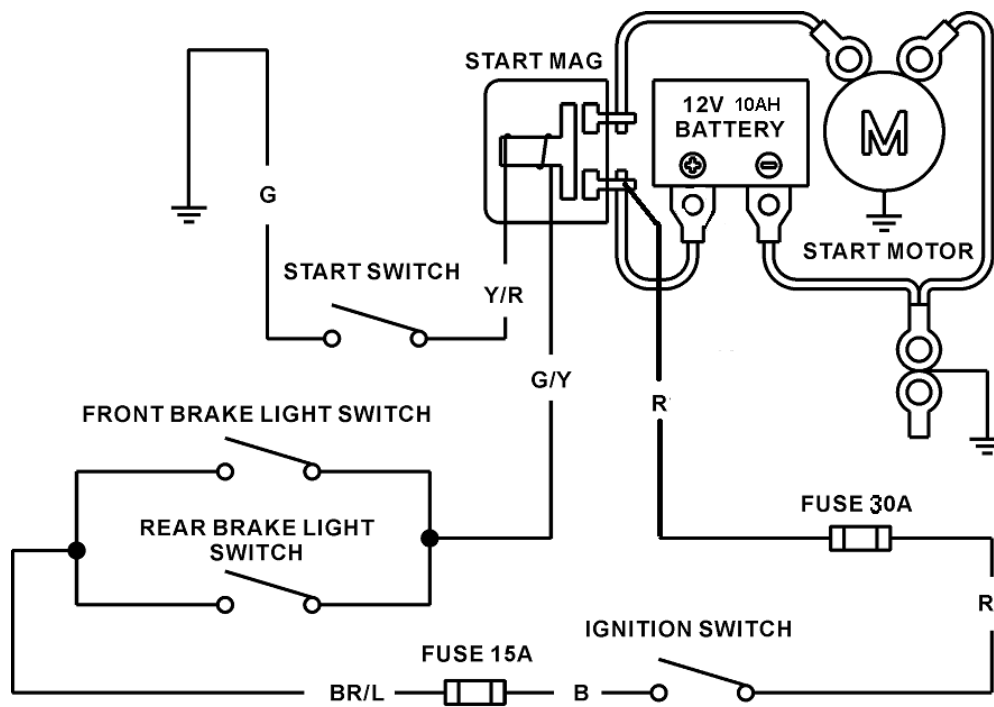

19. STARTING SYSTEM

SERVICE INFORMATION

GENERAL INSTRUCTIONS

- The removal of starter motor can be accomplished with the engine installed.
- After the starter clutch is installed, be sure to add the engine oil and coolant and then bleed air from the cooling system.

TORQUE VALUES

Starter motor mounting bolt 1 kgf-m (10 N-m,)

TROUBLESHOOTING

Starter motor can not working

- Fuse burned out
- Weak battery
- Faulty ignition switch
- Faulty starter clutch
- Faulty front or rear stop switch
- Faulty starter relay
- Poorly connected, broken or shorted wire
- Faulty starter motor

Lack of power

- Weak battery
- Loose wire or connection
- Foreign matter stuck in starter motor or gear

Starter motor rotates but engine does not start

- Faulty starter pinion
- Starter motor rotates reversely
- Weak battery

19. STARTING SYSTEM

STARTER MOTOR

INSPECTION

Disconnect the starter motor cable (2) from the start relay(1).

Connect the start motor cable directly to the battery positive terminal (3).
If the starter motor fail to work, the starter motor is faulty.

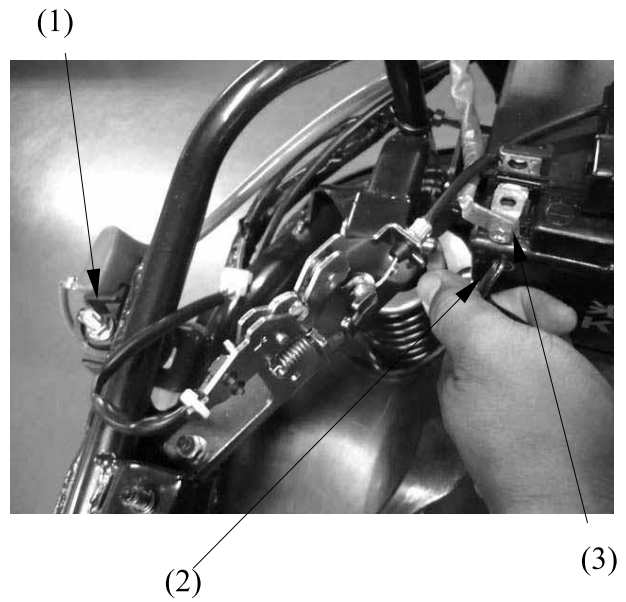

REMOVAL

Turn the ignition switch turned to “OFF” position.
Release the rubber cap (1) and remove the terminal screw (2) to disconnect the start motor cable from the start motor.

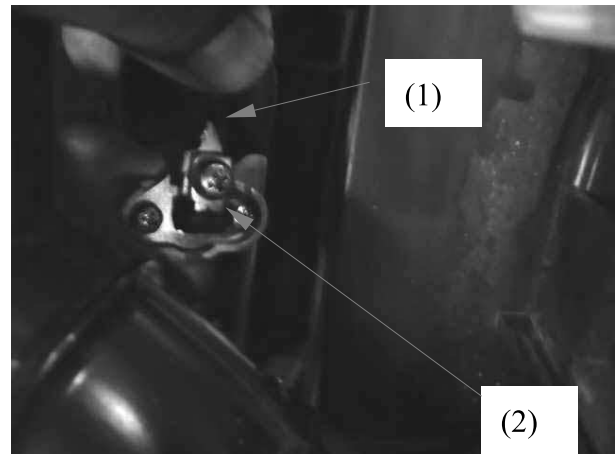

Remove two mounting bolts (3) , then remove the start motor.

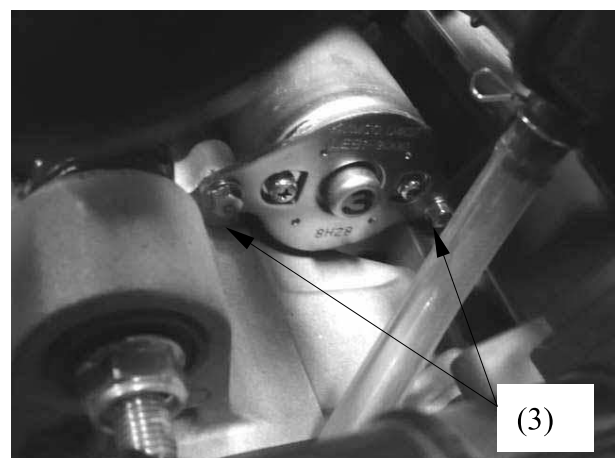

19. STARTING SYSTEM

INSTALLATION

Coat a new O-ring (1) with engine oil and install it into the start motor groove.

Install the starter motor into the crankcase.

Install the two mounting bolts and engine ground cable, then tighten the bolts securely.

Connect the start motor cable to motor terminal with the terminal screw and tighten it securely.

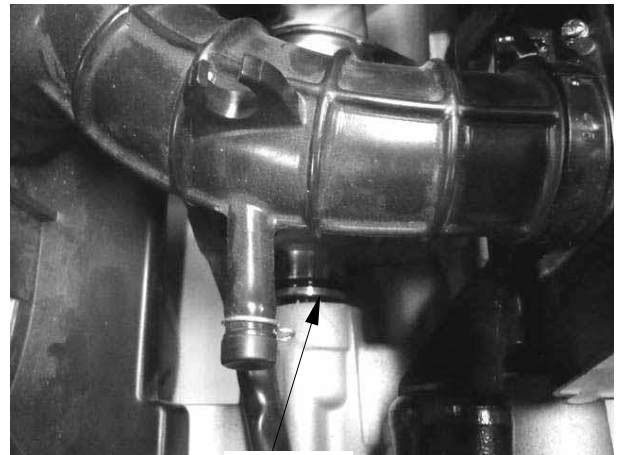

(1)

19. STARTING SYSTEM

START RELAY INSPECTION

Release the rubber cap (1) and remove the nut (2), then disconnect the start motor cable. Turn the ignition switch to “ON” position.

Squeeze and hold the brake lever fully then push the starter switch.

The coil is normal if the start relay switch clicks.



(2) (1)

Release the rubber caps (1) and remove the nuts (2), then disconnect the start motor cable, battery positive cable and harness wire.

Disconnect the start relay connector (3) and then remove start relay.

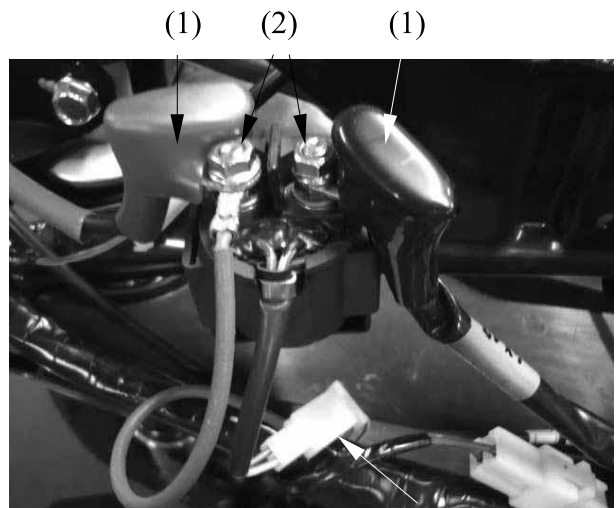

(3)

Connect a fully charged 12 V battery positive wire to the relay switch Yellow/Red wire terminal and negative wire to the Green/Yellow wire terminal.

There should be continuity between the cable terminals while the battery is connected, and no continuity when the battery is disconnected.

