

1. External Components

External Components

This chapter covers the location and servicing of the external components for the **KYMCO G-Dink 125i**.

• <u>Exhaust System</u>	2-12
• <u>Seat</u>	13-15
• <u>Luggage Box</u>	16-18
• <u>Body Cover</u>	19-31
• <u>Front Cover</u>	32-43
• <u>Front Lower Cover</u>	44-48
• <u>Inner Cover</u>	49-56
• <u>Front Fender</u>	57-61
• <u>Rear Carrier</u>	62-64
• <u>Rear Fender</u>	65-68
• <u>Stands</u>	69-74
• <u>Handlebar Cover</u>	75-80
• <u>Under Cover</u>	81-84

1. External components > Exhaust System

Exhaust System

SAFETY FIRST: Protective gloves and eyewear are recommended at this point.

General Instructions

- When removing frame covers, use care not to pull them by force because the cover joint claws may be damaged.
- Make sure to route cables and harnesses according to the Cable & Harness Routing.

Troubleshooting

Noisy exhaust muffler

- Damaged exhaust muffler
- Exhaust muffler joint air leaks

Lack of power

- Caved exhaust muffler
- Clogged exhaust muffler
- Exhaust muffler air leaks

Removal

Remove the seat. See the [Seat](#) topic for more information.

Remove the luggage box. See the [Luggage Box](#) topic for more information.

Remove the rear carrier. See the [Rear Carrier](#) topic for more information.

Remove the body cover. See the [Body Cover](#) topic for more information.

1. External components > Exhaust System

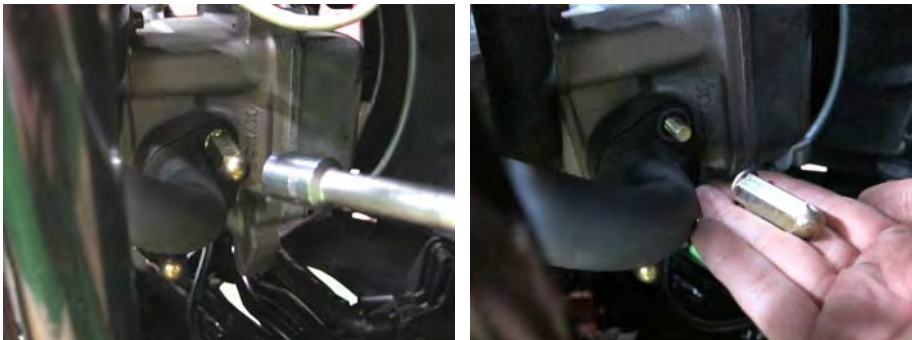
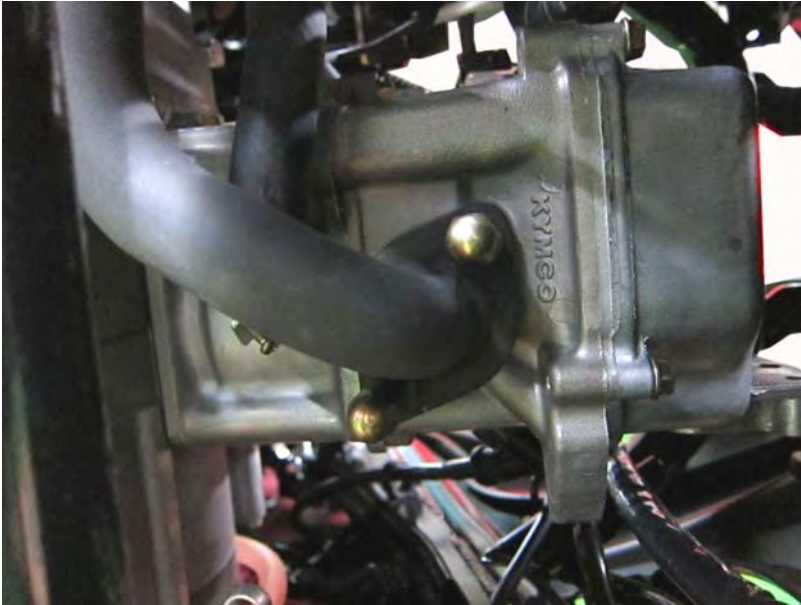

Remove the two exhaust pipe joint nuts with a 12 mm deep well socket.



Unplug the O² sensor connector.



Remove the three muffler mounting bolts with a 14 mm socket.

1. External components > Exhaust System



Remove the exhaust system.



Remove the exhaust pipe gasket and discard it.

1. External components > Exhaust System

O² Sensor

Removal



Remove the O² sensor with a 17 mm wrench. Use care not to pinch the wires.

The O² sensor issues signal to ECU when the temperature is over 350° C while the engine is running.

Test the O² sensor at room temperature.

Use a digital multimeter set to ohms of resistance to inspect the O² sensor.

1. External components > Exhaust System



Measure the resistance between the white wire terminals of the O² sensor connector. Replace the O² sensor if the reading is out of specification.

ITEM	SPECIFICATIONS
O ² heater sensor resistance (at 20°C/68°F)	6.7 - 9.5 Ω (engine warming condition)

Heat Shields



1. External components > Exhaust System



Remove the four muffler heat shield bolts with a #2 screwdriver if needed.



Remove the heat shield.



1. External components > Exhaust System

To remove the heat shield on the exhaust pipe remove the two bolts with an 8 mm socket.



To remove the four bolts to free the heat shield on the muffler.



Remove the two bolts to remove the heat shield on the head pipe. Loosen the clamp to separate the muffler and the head pipe. Inspect the exhaust gasket and replace it as needed.

1. External components > Exhaust System

Installation

Heat Shields



Install the heat shields and tighten the bolts securely.

O² Sensor



Apply anti-seize compound to the threads of the O² sensor. Install the O² sensor and tighten it to specification with a 17 mm wrench. Use care not to pinch the wires.

Item	Torque	
	N-m	lb-ft
O ² Sensor	25	18

1. External components > Exhaust System

Exhaust System



Insert a new exhaust pipe gasket into the exhaust port.



Fit the exhaust system into place

1. External components > Exhaust System

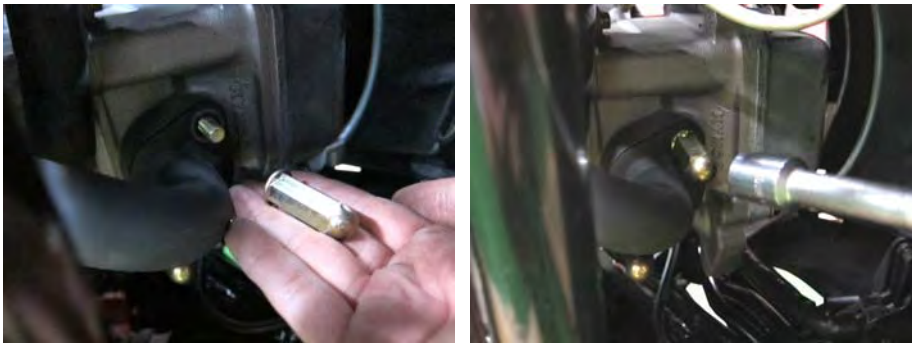

Install the two exhaust pipe joint nuts with a 12 mm deep well socket. Do not tighten.



Install the three muffer mounting bolts and tighten to specification with a socket.

Item	Torque	
	N-m	kgf-m
Muffer Mounting Bolts	20	2



Tighten the two exhaust pipe joint nuts to specification with a 12 mm deep well socket.

Item	Torque	
	N-m	kgf-m
Exhaust Pipe Joint Nuts	35	3.5

1. External components > Exhaust System

If the exhaust pipe and muffler were separated tighten the muffler clamp securely.



Plug in the O² sensor.

Install the luggage box. See the [Luggage Box](#) topic for more information.

Install the seat. See the [Seat](#) topic for more information.

1. External Components > Seat

Seat

SAFETY FIRST: Protective gloves and eyewear are recommended at this point.

Removal



Insert the key and turn it counterclockwise .

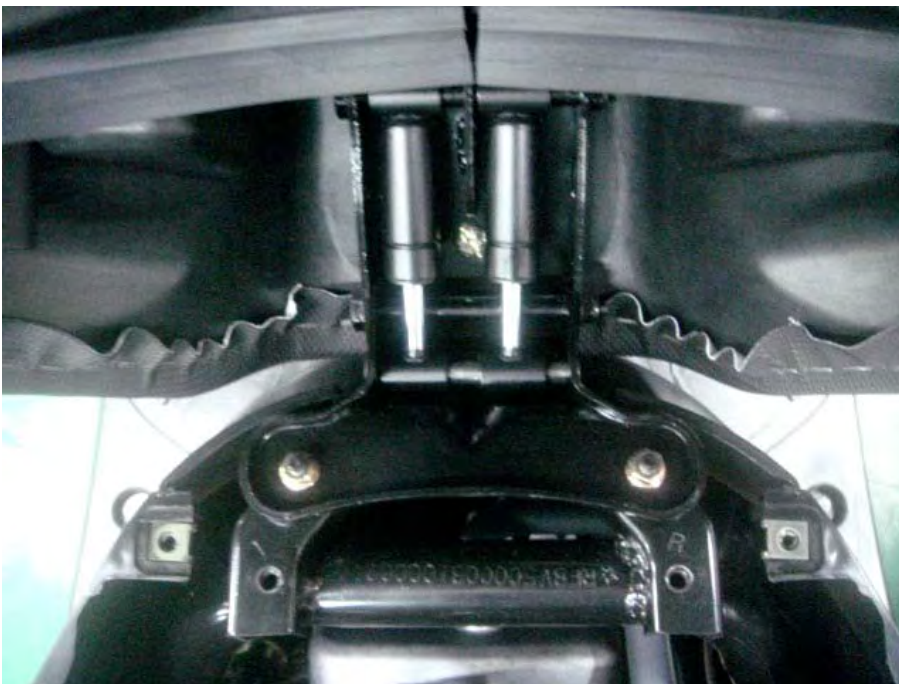

Remove the two luggage box hinge nuts with a 10 mm socket.

1. External Components > Seat



Remove the two seat hinge nuts with a 10 mm socket.

Remove the seat with the piston pivot.

Seat Latch Cable

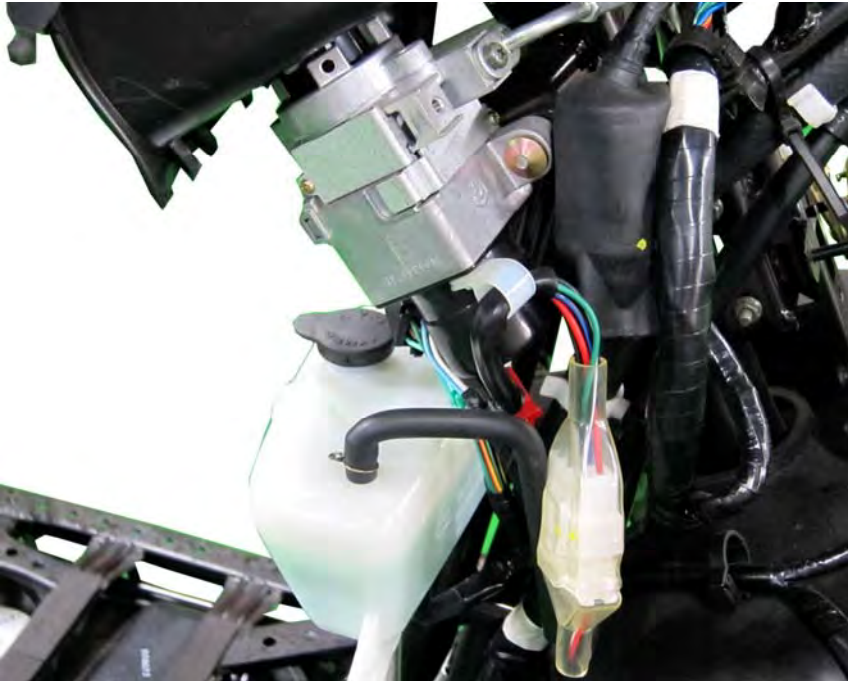

The seat latch cable runs from the ignition switch to the seat latches. The cable must be adjusted periodically so that the latches will open correctly.

Open the seat.

1. External Components > Seat

Installation

Install the seat with the piston pivot onto the hinge.

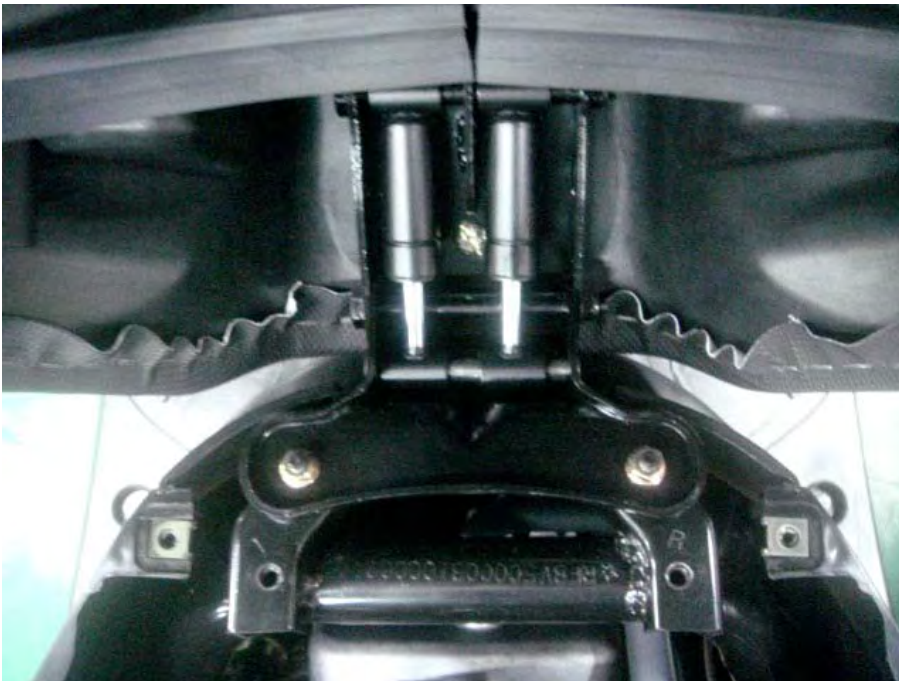

Install the two seat hinge nuts and tighten securely with a 10 mm socket.



Install the two luggage box hinge nuts and tighten securely with a 10 mm socket.
Push down the back of the seat to lock closed.

Luggage Box

SAFETY FIRST: Protective gloves and eyewear are recommended at this point.

Removal

Remove the seat. See the Seat topic for more information.



Remove the two luggage nuts with a 10 mm socket.

1. ExternalComponents > Luggage Box



Remove the PDA panel located at the rear of the luggage box and free the PDA plug.

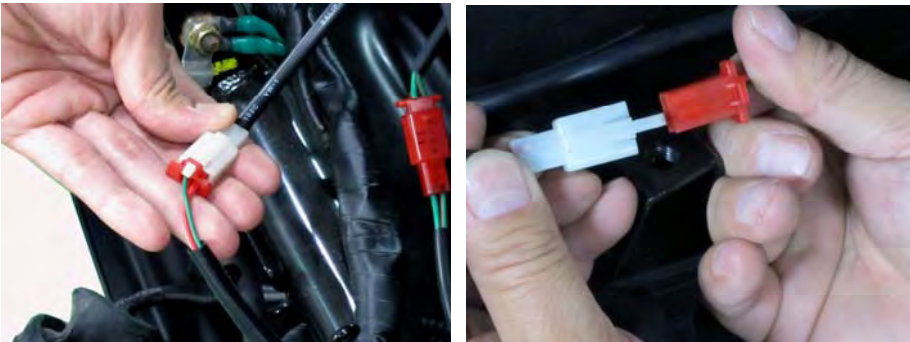

Lift up the luggage box to unplug the luggage box light connector.

Remove the luggage box.

Installation

Plug in the luggage box light connector.

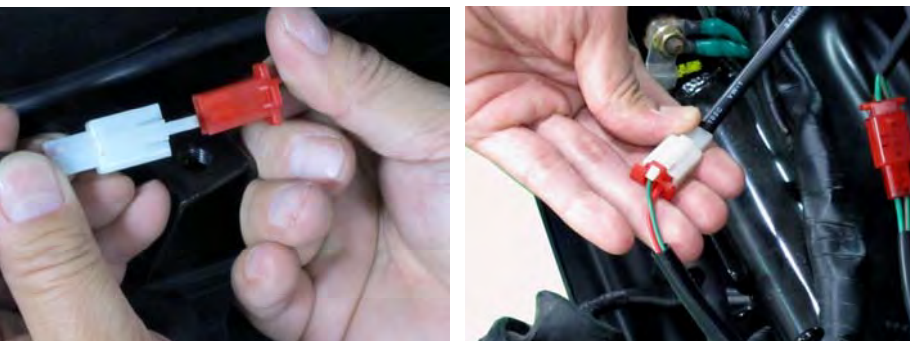

Install the luggage box.

1. ExternalComponents > Luggage Box



Mount the PDA plug and install the panel located at the rear of the luggage box.

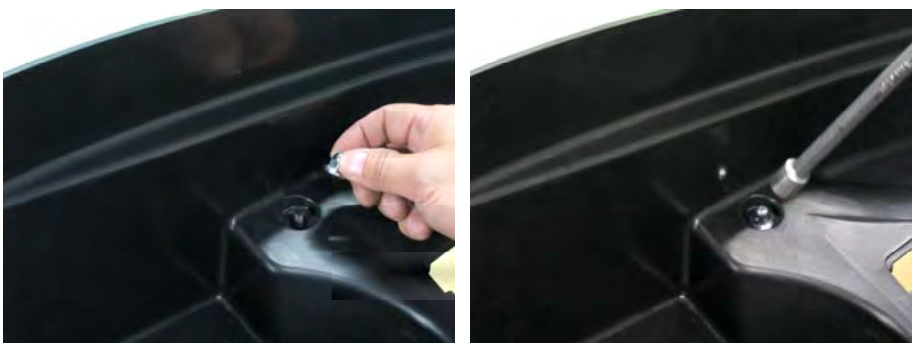

Install the two luggage nuts and tighten securely with a 10 mm socket.

Install the seat. See the Seat topic for more information.

Body Cover

SAFETY FIRST: Protective gloves and eyewear are recommended at this point.

Removal

Remove the seat. See the [Seat](#) topic for more information.

Remove the luggage box. See the [Luggage Box](#) topic for more information.

Remove the rear carrier. See the [Rear Carrier](#) topic for more information.



Remove the two rear center cover screws with a #2 Phillips.

1. External Components > Body Cover



Remove the rear center cover.



Remove the upper body cover bolt with a 10 mm socket.

1. External Components > Body Cover



Remove the two lower body cover nuts with a 10 mm socket.



Unplug the taillight connector.

1. External Components > Body Cover



Remove the two screws from the front of the body cover.



Remove the two bolts on both sides of the body cover.
Carefully unhook the tabs on both sides of the body cover.

1. External Components > Body Cover



Remove the body cover.

Disassembly

Taillight Assembly

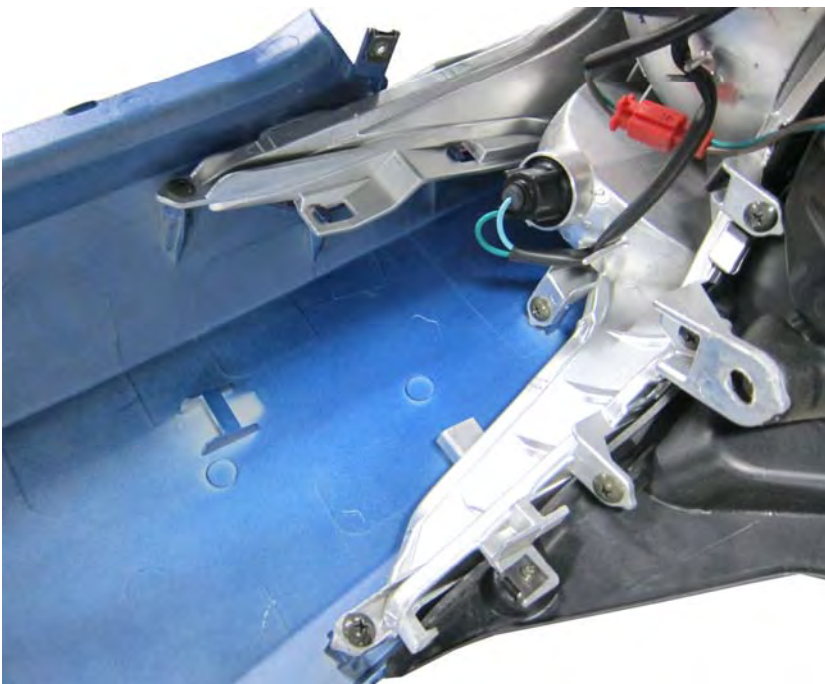

1. External Components > Body Cover



Remove the six taillight assembly screws with a #2 Phillips.



Unhook the taillight section and separate from the body cover.



1. External Components > Body Cover



Remove the two mud flap screws with a #2 Phillips.



Separate the mud flap from the taillight assembly.

1. External Components > Body Cover

License Light



Remove the two license light assembly screws with a screwdriver.



Remove the license light assembly.

1. External Components > Body Cover

Mud Flap



Installation



Fit the body cover into place.

1. External Components > Body Cover



Install the two screws on both sides of the body cover.
Carefully push the hooks into the corresponding tabs on both sides of the body cover.



Install the two screws into body cover and tighten them securely with a #2 Phillips.

1. External Components > Body Cover



Plug in the taillight connector.



Install the two lower body cover nuts and tighten securely with a 10 mm socket.

1. External Components > Body Cover

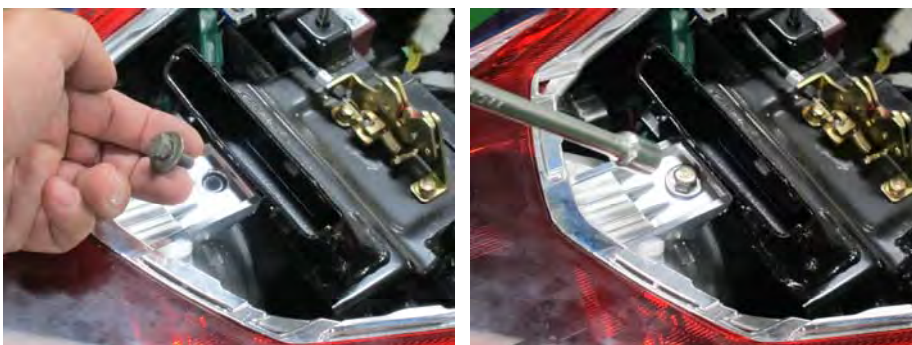

Install the upper body cover bolts and tighten securely with a 10 mm socket.



Carefully install the rear center cover.

1. External Components > Body Cover

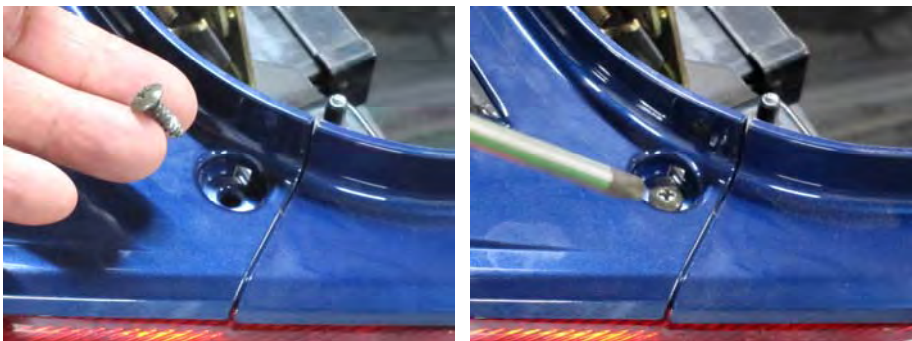

Install the two rear center cover screws and tighten securely with a #2 Phillips.

Install the rear carrier. See the [RearCarrier](#) topic for more information.

Install the luggage box. See the [LuggageBox](#) topic for more information.

Install the seat. See the [Seat](#) topic for more information.

1. External Components > Front Cover

Front Cover

SAFETY FIRST: Protective gloves and eyewear are recommended at this point.

Removal

Remove the windshield. See the [Windshield](#) topic for more information.



Open the hidden bolt cover.



Remove the hidden bolt with a 10mm socket.

1. External Components > Front Cover



Remove the four windshield bolts with a 6mm Allen. There are two bolts on each side.



Remove the windshield.



1. External Components > Front Cover



Remove the four front cover mounting screws with a #2 Phillips. There are two screws on each side.



Remove the push pin. Depress the head of the fastener center piece. Pull out the fastener. Free the two posts from the grommets. Carefully pull out off the small black cover.



Remove the two bolts mounting on the speedometer cover on each side.



Remove the protector ignition switch counterclockwise.

1. External Components > Front Cover



Remove the two front cover mounting nuts with a 10 mm socket.



Carefully pull out off the front cover with a screwdriver.



Gently pull the cover forward and free the tabs.

1. External Components > Front Cover



Unplug the headlight and turn signal leads.
Remove the front cover.

Disassembly

Lower Fairing



Remove the four lower fairing push pins on each side.
Remove the six upper fairing push pins on the upper.



Remove the lower fairing.

1. External Components > Front Cover

Light Assembly

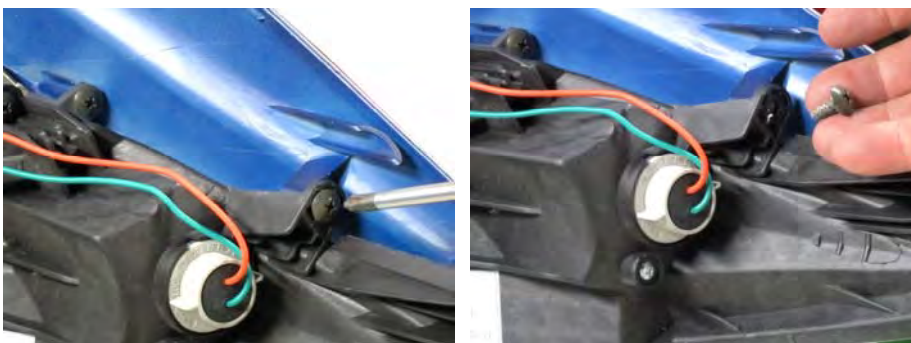
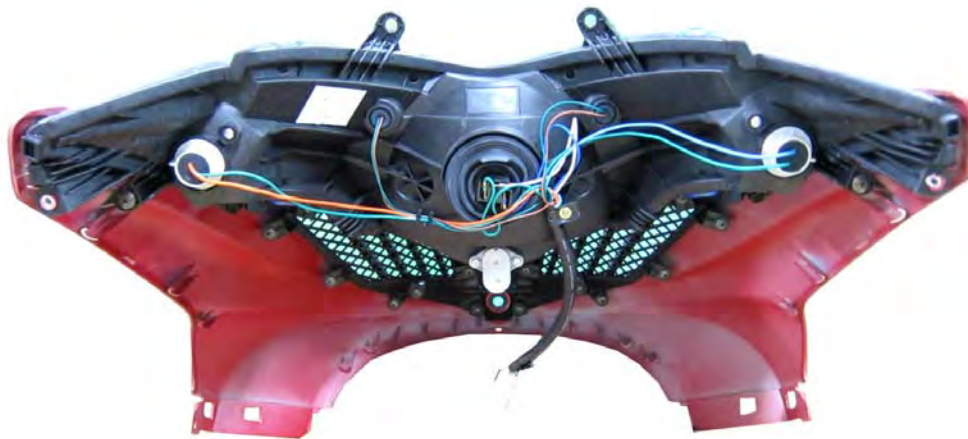

Remove the eight light assembly mounting screws with a #2 Phillips.



Remove the light assembly from the front cover.

1. External Components > Front Cover

Side Piece



Remove the eighteen side piece screws with a #2 Phillips.



Remove the side piece.

1. External Components > Front Cover

Assembly

Side Piece



Install the side piece on the front cover.



Install the eighteen side piece screws and tighten securely with a #2 Phillips.

1. External Components > Front Cover

Light Assembly



Install the light assembly on the front cover.

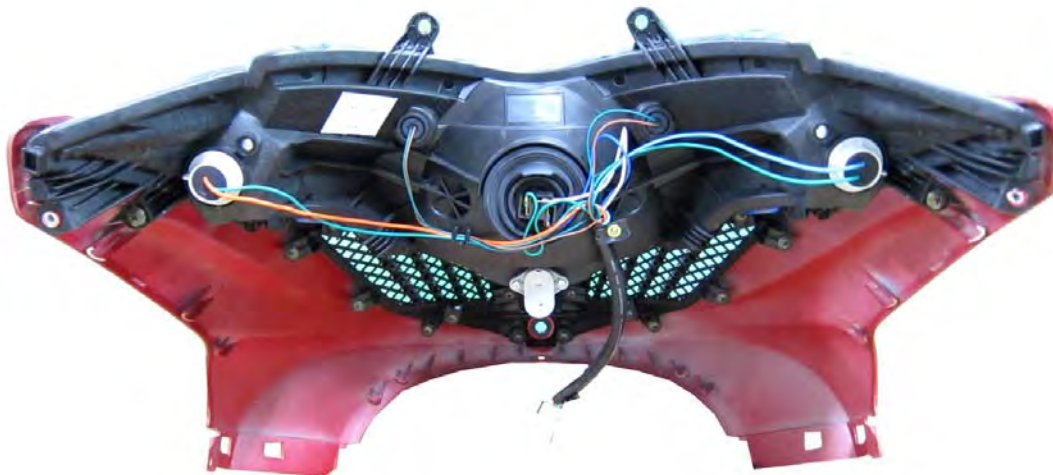

Install the eight light assembly mounting screws and tighten securely with a #2 Phillips.

1. External Components > Front Cover

Lower Fairing



Install the lower fairing.

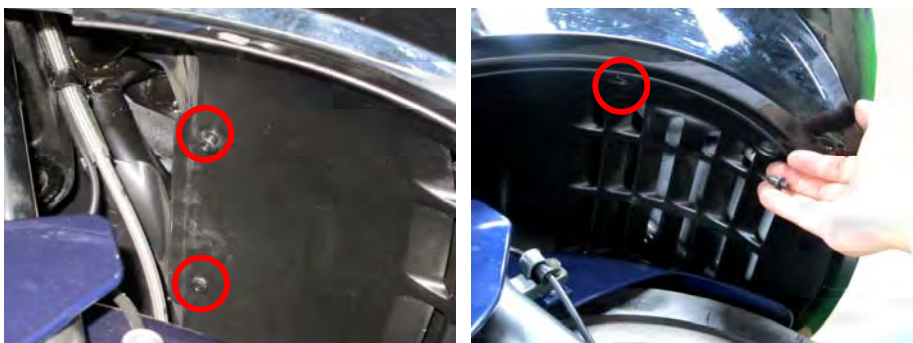

Install the four lower fairing push pins on each side.
Install the six upper fairing push pins on the upper side.

Installation



Plug in the headlight and turn signal leads.

1. External Components > Front Cover



Align front cover tabs. Install the front cover.



Install the four front cover mounting screws and tighten securely with a #2 Phillips. There are two screws on each side.

1. External Components > Front Cover



Install the two front cover mounting nuts and tighten securely with a 10 mm socket.



Align the two posts with the grommets. Carefully push on the small black cover. Install the small black cover push pin.



Install the windshield. See the [Windshield](#) topic for more information.

1. External Components > Front Lower Cover

Front Lower Cover

SAFETY FIRST: Protective gloves and eyewear are recommended at this point.



The process for removing and installing the front lower covers are the same for both sides.



Remove the screw from the bottom of the cover.

1. External Components > Front Lower Cover



Pull up the front skirt rubber covers.



Remove the two upper screws under the lower rubber cover with a #2 Phillips on each side.



Remove the screw under the rubber cover with a #2 Phillips.



Remove the push pin. Depress the head of the fastener center piece. Pull out the fastener.

1. External Components > Front Lower Cover



Remove the screw mounting on the front lower cover with a #2 Phillips on each side.



Gently separate the front lower cover from the front cover. Remove the front lower cover.

Installation



Install the front lower cover. Carefully fit the upper tabs of the front lower cover into the front cover.

1. External Components > Front Lower Cover



Install the two screws under the rubber cover with a #2 Phillips. Tighten them securely.



Install the screw under the rubber cover with a #2 Phillips.



Install the lower screws mounting on the body frame with a #2 Phillips on each side. Tighten them securely.



Install the front skirt rubber covers.

1. External Components > Front Lower Cover



Install the screw.

Inner Cover

SAFETY FIRST: Protective gloves and eyewear are recommended at this point.

Removal

Remove front cover. See the [Front Cover](#) topic for more information.

Remove front center cover. See the [Front Center Cover](#) topic for more information.

Remove the handlebar covers. See the [Handlebar Covers](#) topic for more information.

Remove the center cover. See the [Center Cover](#) topic for more information.

Remove the right and left foot skirts. See the [Foot Skirt](#) topic for more information.

Remove the right and left front lower covers. See the [Front Lower Cover](#) topic for more information.

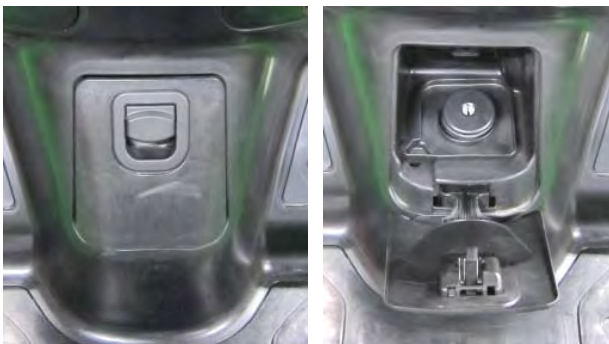

Open the fuel cap panel.

1. External Components > Inner Cover



Remove the fuel cap with the key.



Remove the two push pins below the handlebar. Depress the head of the fastener center piece. Pull out the fastener.

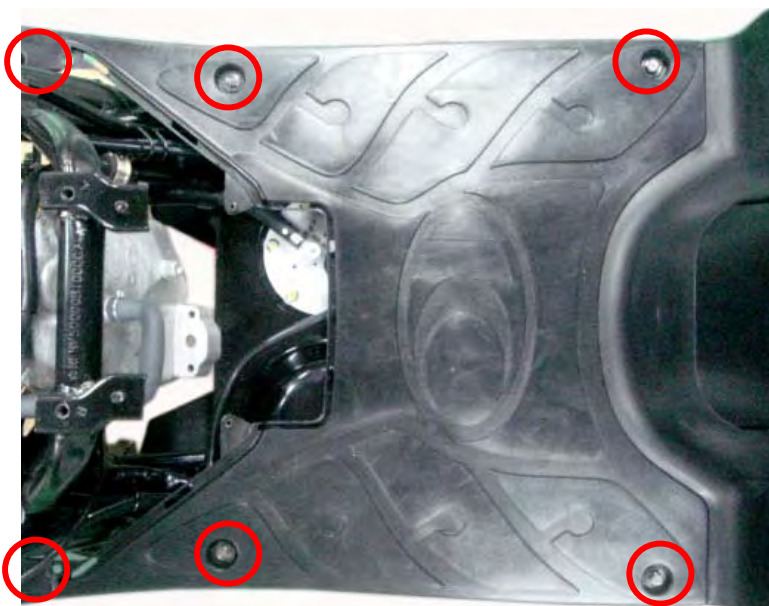

There are six mounting bolts on the floorboard.

1. External Components > Inner Cover

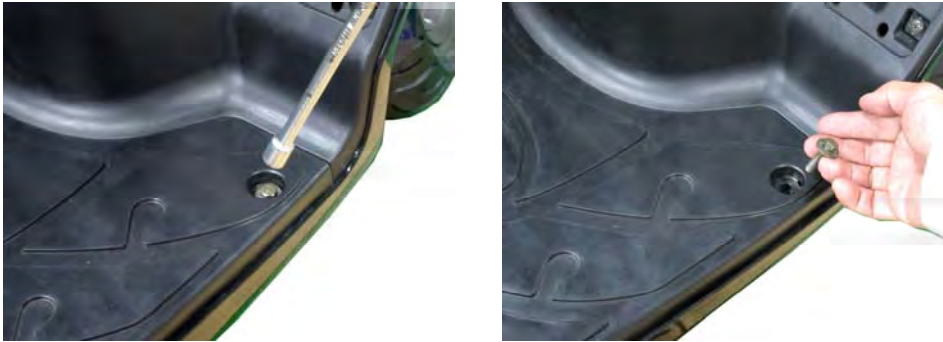

Remove the six mounting bolts on both sides with a 10 mm socket.



Lift off the inner cover.



Remove the mounting bolt on the water reserve box.

1. External Components > Inner Cover



Remove the two mounting bolts on the body frame.



Remove the gas cap overflow pad.

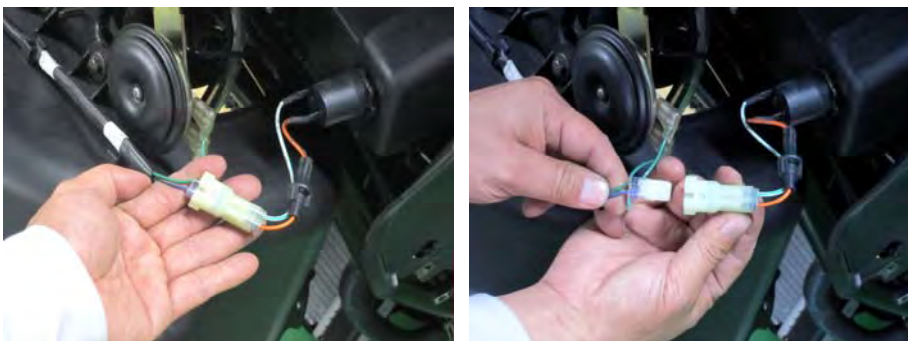

Remove the connector output voltage device.

1. External Components > Inner Cover



Remove the inner cover.



Inspect the gas panel.

1. External Components > Inner Cover

Installation



Install the inner cover and align the bolt holes.



Install the gas cap overflow pad.



Install the two front mounting bolts on both sides and tighten them securely with a 10 mm socket.

1. External Components > Inner Cover



Install the bolt attaching to the water reserve box and tighten securely with a #10 socket.



Install the floorboard.



Install the six mounting bolts and tighten them securely on both sides with a 10 mm socket.

1. External Components > Inner Cover



Install the two side push pins. Push in the head of the center piece until it becomes flush with the fastener outside face.

Note: To prevent the pawl from damage, insert the fastener all the way into the installation hole.

Install the right and left front lower covers. See the [Front Lower Cover](#) topic for more information.

Install the right and left foot skirts. See the [Foot Skirt](#) topic for more information.

Install the center cover. See the [Center Cover](#) topic for more information.

Install the handlebar covers. See the [Handlebar Covers](#) topic for more information.

Install front center cover. See the [Front Center Cover](#) topic for more information.

Install front cover. See the [Front Cover](#) topic for more information.

Install the fuel cap. See the [Fuel Tank](#) topic for more information.

Front Fender

SAFETY FIRST: Protective gloves and eyewear are recommended at this point.

Removal

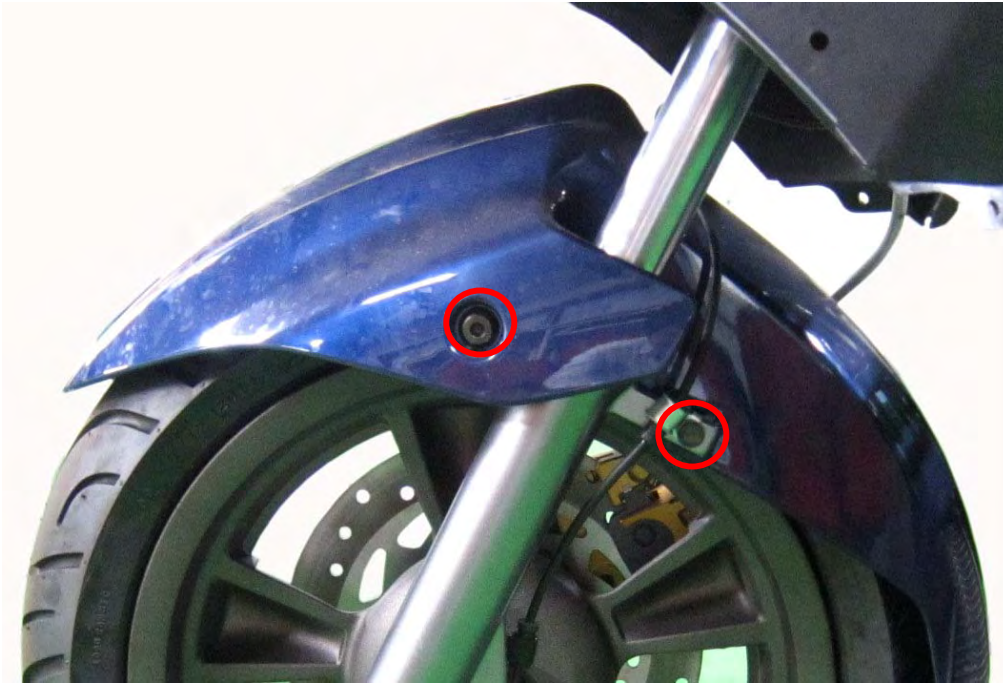

The front fender is held in place with four bolts, two on each side.

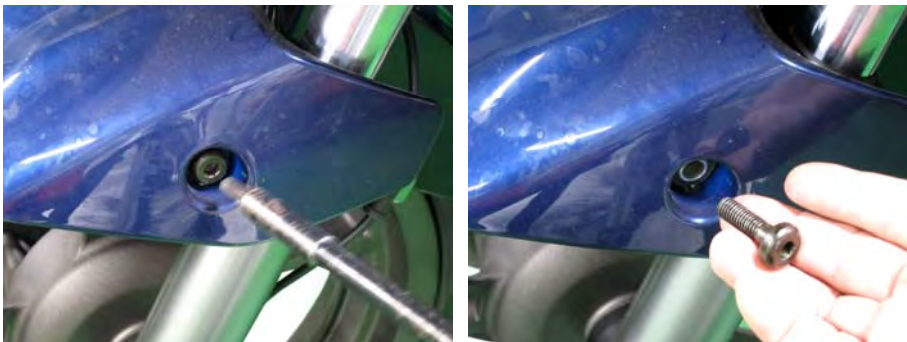

Remove the left forward front fender bolt with a 6 mm Allen.

1. External Components > Front Fender



Remove the left rear fender bolt with a 10 mm socket.

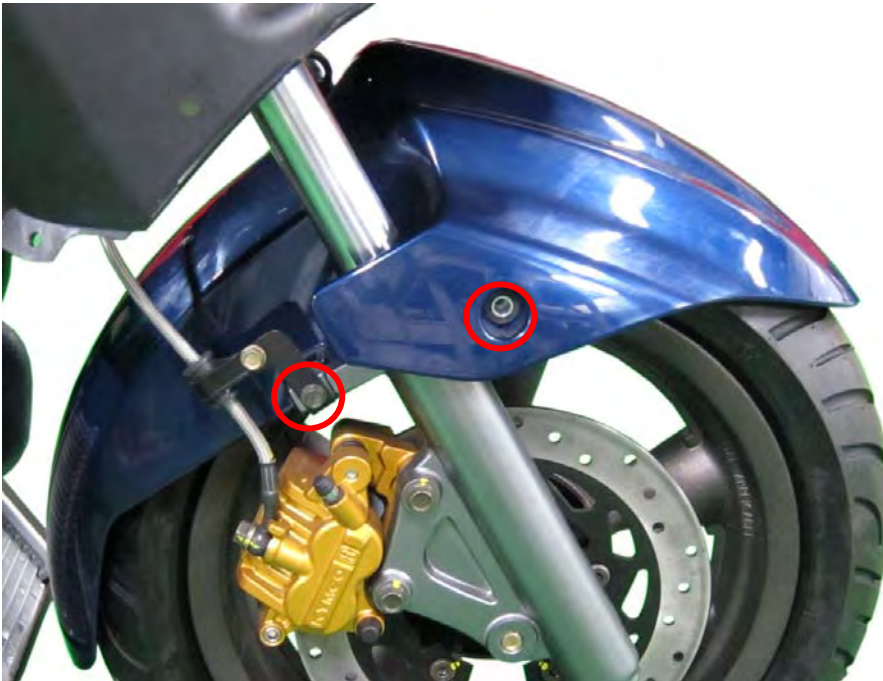

Remove the right forward front fender bolt with a 6 mm Allen.



Remove the right rear fender bolt with a 10 mm socket.

1. External Components > Front Fender



Remove the front fender from the forks.

Installation



Guide the fender between the forks.

1. External Components > Front Fender



Install the left forward front fender bolt and tighten securely with a 6 mm Allen.

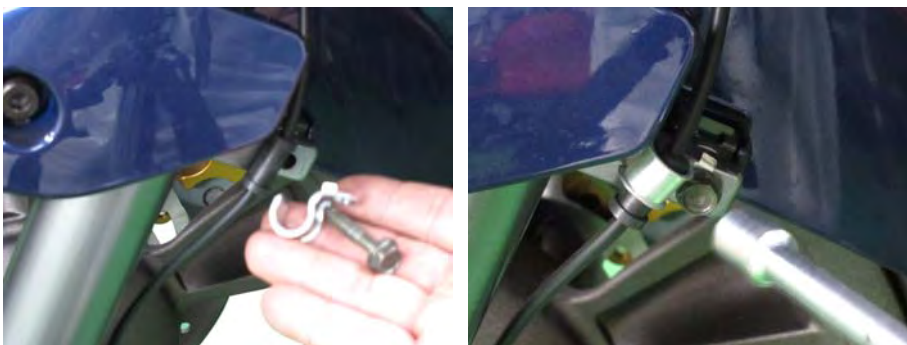

Install the left rear fender bolt and tighten securely with a 10 mm socket.



1. External Components > Front Fender



Install the right forward front fender bolt and tighten securely with a 6 mm Allen.



Install the right rear fender bolt and tighten securely with a 10 mm socket.

1. ExternalComponents > Rear Carrier

Rear Carrier

Removal

SAFETY FIRST: Protective gloves and eyewear are recommended at this point.



1. External Components > Rear Carrier



Remove the four carrier bolts with a 6 mm Allen.



Remove the carrier.

Installation

1. External Components > Rear Carrier



Install the carrier.



Install the two upper carrier bolts with a 6 mm Allen.



Install the two carrier bolts on each side with a 6 mm Allen.

Rear Fender

SAFETY FIRST: Protective gloves and eyewear are recommended at this point.

Removal

Remove the airbox. See the [Airbox](#) topic for more information.



1. External Components > Rear Fender

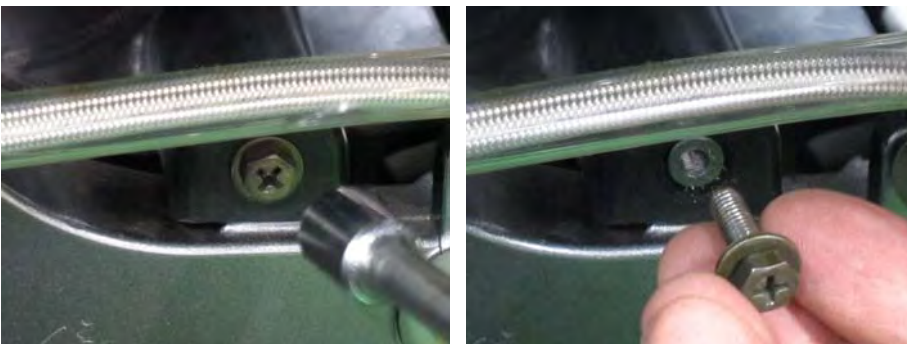

Remove the two fender mounting bolts with a 8 mm socket on the right side.



Remove the airbox.

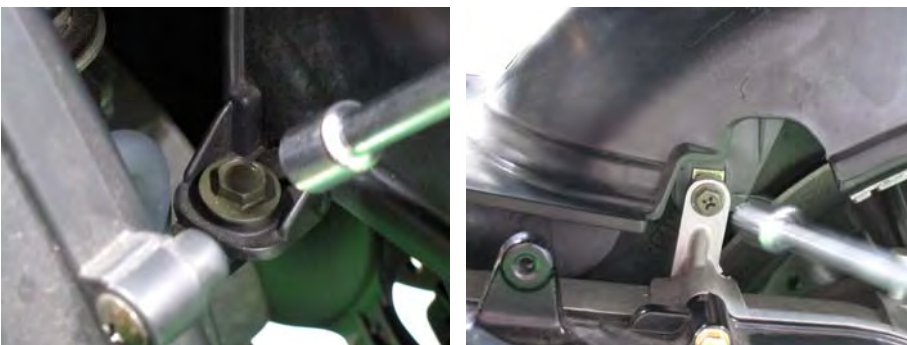

Remove the left fender mounting bolts with a 10 mm socket on the back side.
Remove the left fender mounting bolts with a 8 mm socket on the front side.

1. External Components > Rear Fender



Remove the rear fender.

Installation



Install the rear fender.

1. External Components > Rear Fender



Install the left fender mounting bolts with a 10 mm socket on the back side.
Install the left fender mounting bolts with a 8 mm socket on the front side.



Install the two right fender mounting bolts and tighten securely with a 8 mm socket on the right side.



Install the airbox. See the [Airbox](#) topic for more information.

Stands

SAFETY FIRST: Protective gloves and eyewear are recommended at this point.

Side stand

Removal

Remove the luggage box. See the [LuggageBox](#) topic for more information.

Remove the foot skirt. See the [FootSkirt](#) topic for more information.



Unplug the three-pin side stand switch connector.

1. ExternalComponents > Stands



Remove the side stand spring with a spring puller.



Remove the side stand bolt, switch, and side stand.

Installation

1. External Components > Stands



Install the side stand, switch, and bolt. Make sure to fit the switch into place correctly. Tighten the bolt securely.



Install the side stand spring with a spring puller.

1. External Components > Stands



Plug in the side stand switch connector.

Install the foot skirt. See the [Foot Skirt](#) topic for more information.

Install the luggage box. See the [Luggage Box](#) topic for more information.

Center Stand

Removal



Remove the center stand spring with a spring puller.

1. ExternalComponents > Stands



Remove the two center stand nuts and bolts. Remove the center stand.

Installation



Install the nuts and bolts. Tighten them securely.

1. External Components > Stands



Install the center stand spring with a spring puller.

Handlebar Covers

SAFETY FIRST: Protective gloves and eyewear are recommended at this point.

Removal

Upper Cover



Remove the four cover screws with a #2 Phillips.

1. External Components > Handlebar Cover



Carefully free the tabs and remove the upper handlebar cover.

Lower Cover

Remove the luggage box. See the [Luggage Box](#) topic for more information.

Remove the throttle cables from the throttle body. See the [Throttle Body Removal](#) topic for more information.

1. External Components > Handlebar Cover



Route the throttle cables out of the handlebar cover.



1. External Components > Handlebar Cover



Remove the lower cover.

Installation

1. External Components > Handlebar Cover



Place the lower cover onto the handlebar.



1. External Components > Handlebar Cover



Route the throttle cables into the handlebar cover. See the [Throttle Cable](#) topic for more information.

1. External Components > Under Cover

Under Cover

SAFETY FIRST: Protective gloves and eyewear are recommended at this point.

Removal

Remove the right and left foot skirts. See the [Foot Skirt](#) topic for more information.

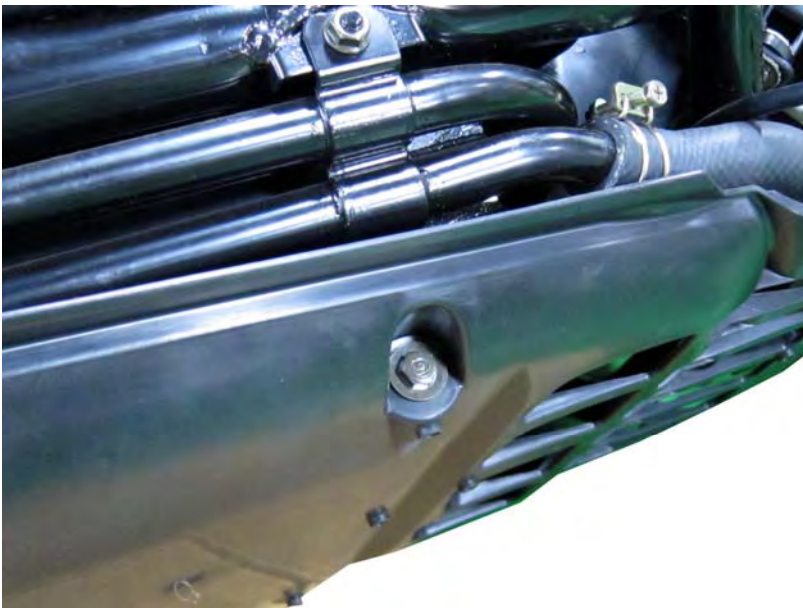

Remove the two under cover bolts on the right side with a 10 mm socket.

1. External Components > Under Cover



Remove the two under cover bolts on the left side with a 10 mm socket.



Remove the under cover.

1. External Components > Under Cover

Installation



Install the under cover.



1. External Components > Under Cover



Install the two under cover bolts on the left side and tighten securely with a 10 mm socket.



Install the two under cover bolts on the right side and tighten securely with a 10 mm socket.

Install the right and left foot skirts. See the [Foot Skirt](#) topic for more information.

Engine

This chapter covers the location and servicing of the engine components for the **KYMCO G-Dink 125i**.

• <u>Generator Removal & Installation</u>	4-23
• <u>Crankshaft</u>	24-26
• <u>Crankcase Splitting & Assembly</u>	27-36
• <u>Cylinder Head Cover</u>	37-41
• <u>Camshaft</u>	42-54
• <u>Valves</u>	55-63
• <u>Cylinder and Piston</u>	64-78
• <u>Oil Pump</u>	79-85
• <u>Engine Removal</u>	86-92
• <u>Engine Installation</u>	93-99
• <u>Engine Specifications</u>	100-102

GENERAL INSTRUCTIONS

Lubrication System

The maintenance of lubrication system can be performed with the engine installed in the frame. Use care when removing and installing the oil pump not to allow dust and foreign matters to enter the engine and oil line.

Do not attempt to disassemble the oil pump. The oil pump must be replaced as a set when it reaches its service limit.

After the oil pump is installed, check each part for oil leaks.

TROUBLESHOOTING

Oil level too low

1. Natural oil consumption
2. Oil leaks
3. Worn or poorly installed piston rings
4. Worn valve guide or seal

2. Engine

Poor lubrication pressure

1. Oil level too low
2. Clogged filter or oil passages
3. No use the specified oil

Cylinder Head, Camshaft, and Valves

- The cylinder head can be serviced with the engine installed in the frame. Coolant in the radiator and water hoses must be drained.
- When assembling, apply molybdenum disulfide grease or engine oil to the valve guide movable parts and valve arm sliding surfaces for initial lubrication.
- The valve rocker arms are lubricated by engine oil through the engine oil passages. Clean and unclog the oil passages before assembling the cylinder head.
- After disassembly, clean the removed parts and dry them with compressed air before inspection.
- After removal, mark and arrange the removed parts in order. When assembling, install them in the reverse order of removal.

TROUBLESHOOTING

- The poor cylinder head operation can be diagnosed by a compression test or by tracing engine top-end noises.

Poor performance at idle speed

- Compression too low

Compression too low

- Incorrect valve clearance adjustment
- Burned or bent valves
- Incorrect valve timing
- Broken valve spring
- Poor valve and seat contact
- Leaking cylinder head gasket
- Warped or cracked cylinder head
- Poorly installed spark plug

2. Engine

Compression too high

- Excessive carbon build-up in combustion chamber

Abnormal noise

- Incorrect valve clearance adjustment
- Sticking valve or broken valve spring
- Damaged or worn camshaft
- Worn cam chain tensioner
- Worn camshaft and rocker arm

White smoke from exhaust muffler

- Worn valve stem or valve guide
- Damaged valve stem oil seal

Cylinder and Piston

- The cylinder and piston cannot be serviced with the engine installed in the frame.
- After disassembly, clean the removed parts and dry them with compressed air before inspection.
- If replacing the piston or cylinder, they must be changed as a pair.

TROUBLESHOOTING

Compression too low or uneven compression

- Worn, stuck or broken piston rings
- Worn or damaged cylinder and piston

Compression too high

- Excessive carbon build-up in combustion chamber or on piston head.

Excessive smoke from exhaust muffler

- Worn or damaged piston rings
- Worn or damaged cylinder and piston

Abnormal noisy piston

- Worn cylinder, piston and piston rings
- Worn piston pin hole and piston pin

2. Engine > Generator

A.C. Generator and Starter clutch

SAFETY FIRST: Protective gloves and eyewear are recommended at this point.

Removal

Generator Cover

Remove the following components -

- # Seat
- # Luggage Box
- # Center Cover
- # Rear Carrier
- # Body Cover
- # Front Cover
- # Front Lower Cover
- # Foot Skirt

Drain engine oil and remove the oil filter. See the [Engine Oil](#) topic for more information.

Drain the coolant. See the [Coolant](#) topic for more information.

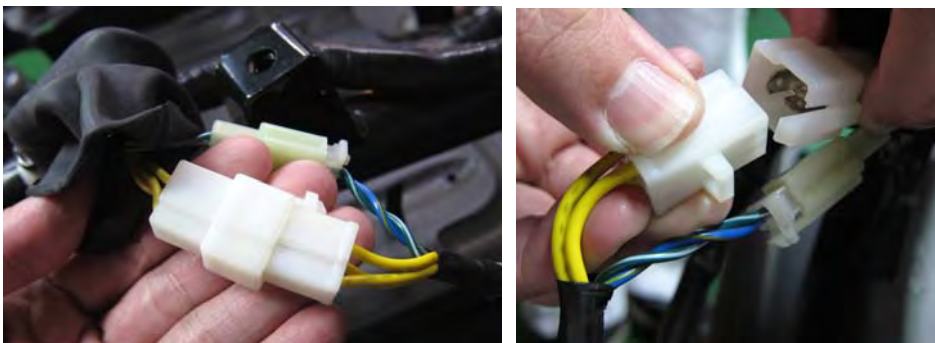

Disconnect the generator 3-pin connector.

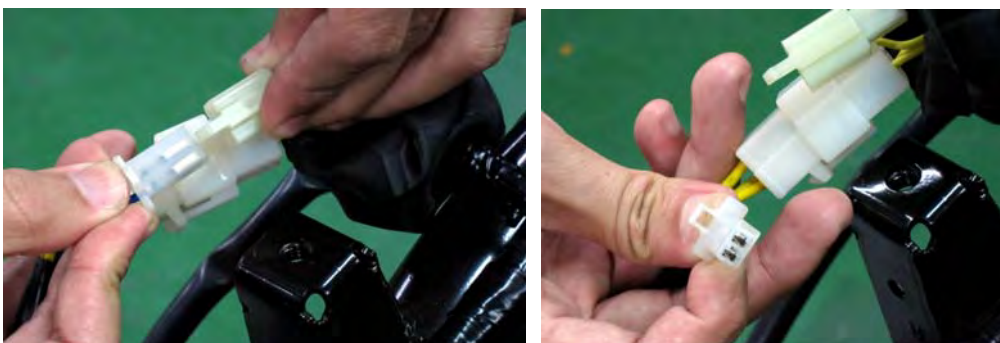

Disconnect the crank position sensor wire coupler.

2. Engine > Generator



Loosen the water pump hose clamp with a #2 Phillips screwdriver. Slide up the clamp and free the coolant hose from the water pump. Allow any remaining coolant to drain into a suitable container.



Loosen the right crankcase coolant hose clamp with a #2 Phillips screwdriver. Slide up the clamp and free the coolant hose from the right crankcase cover. Allow any remaining coolant to drain into a suitable container.



2. Engine > Generator

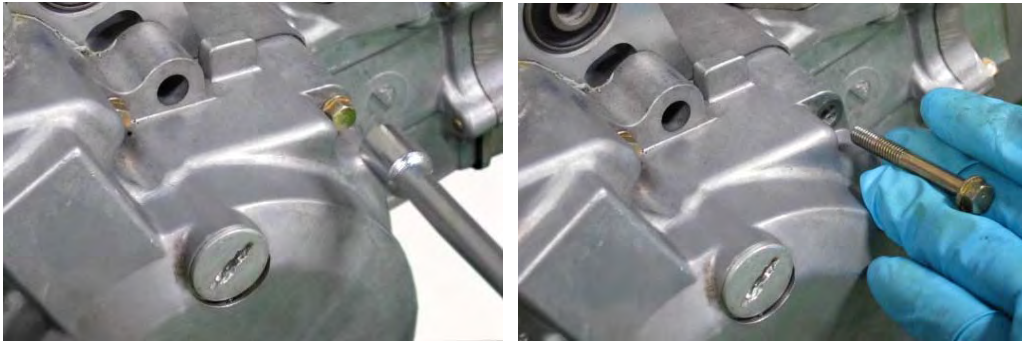

Remove the 9 generator cover bolts with an 8 mm socket. Note the upper most bolt holds a wire stay.

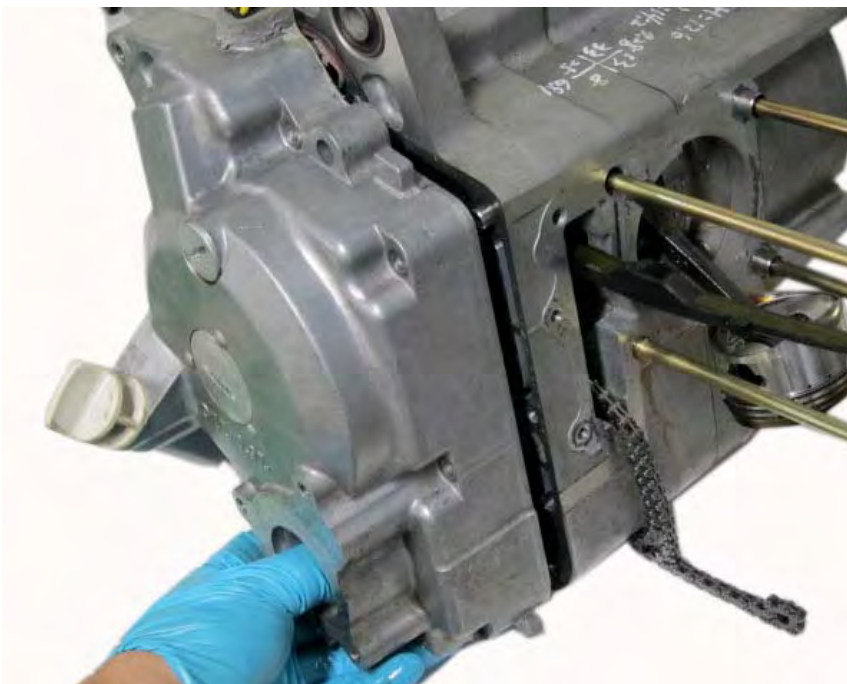

Utilize the pry points and remove the generator cover.

2. Engine > Generator



Remove the generator cover gasket.

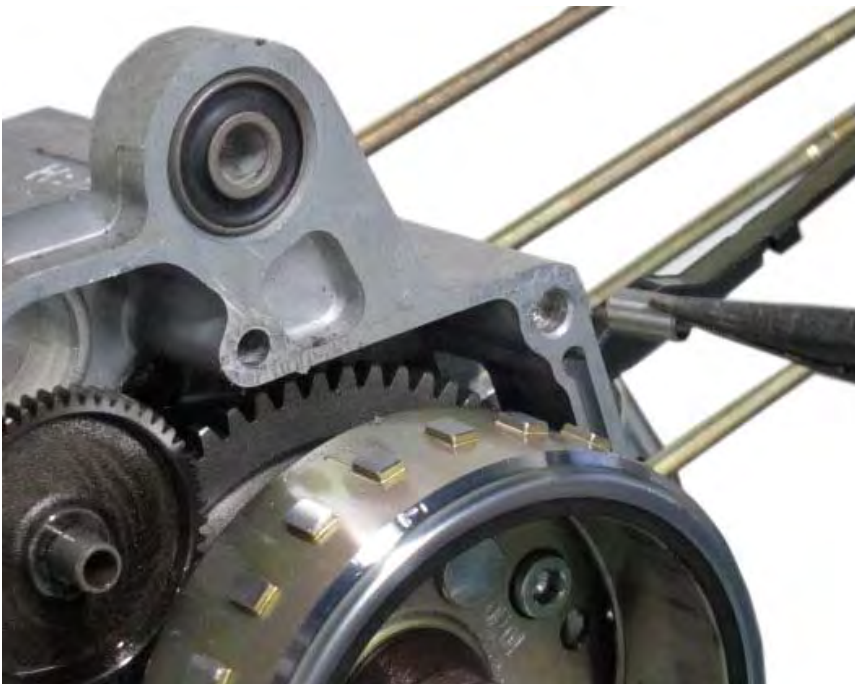

Remove the two dowel pins.

2. Engine > Generator

Stator and Pulsar Coil/Crank Position Sensor

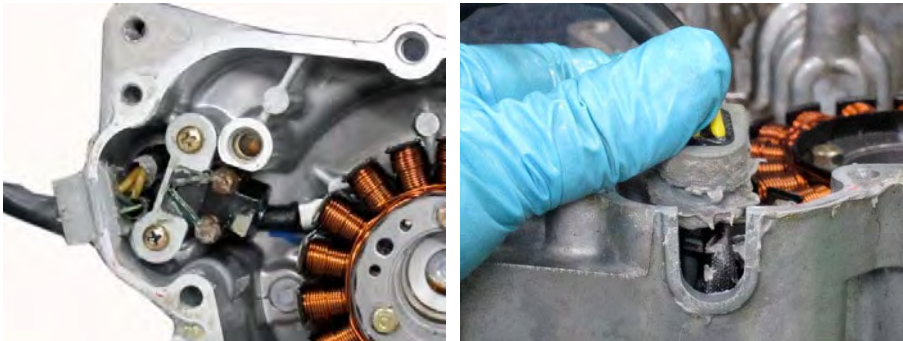

Free the rubber wire grommet from the right crankcase cover.



Remove the three stator mounting bolts and the two crank position sensor bolts with an 8 mm socket. Remove the stator and the crank position sensor together.

Flywheel

2. Engine > Generator



To remove the fly wheel two special tools are needed.

ITEM	TOOL NO.
UNIVERSAL HOLDER	A120E00021



ITEM	TOOL NO.
FLYWHEEL PULLER	A120E00003

2. Engine > Generator

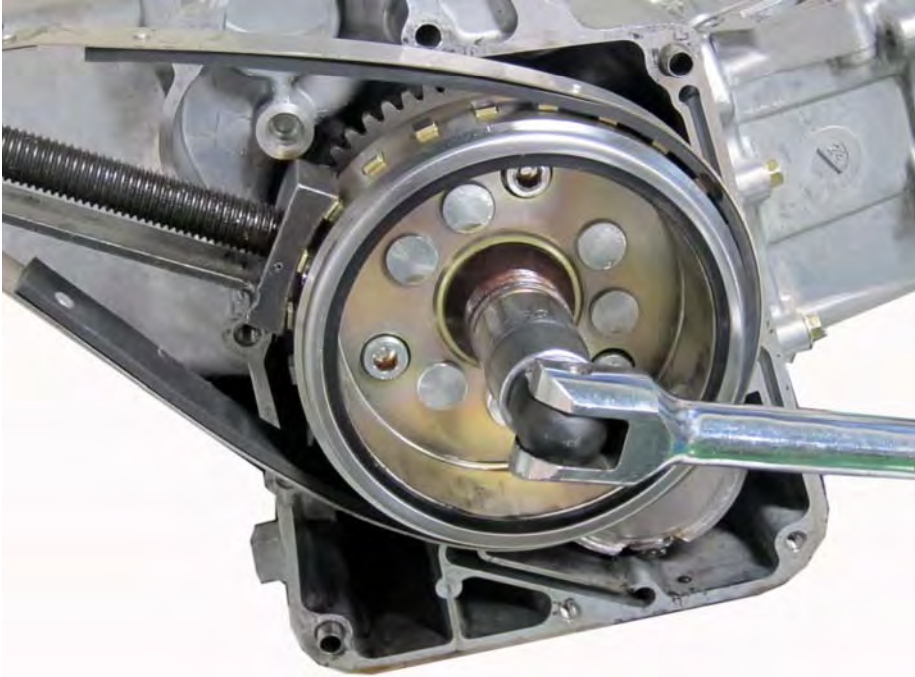

Hold the flywheel with the universal holder and loosen the nut with a 19 mm socket.



Remove the flywheel nut and washer.

2. Engine > Generator

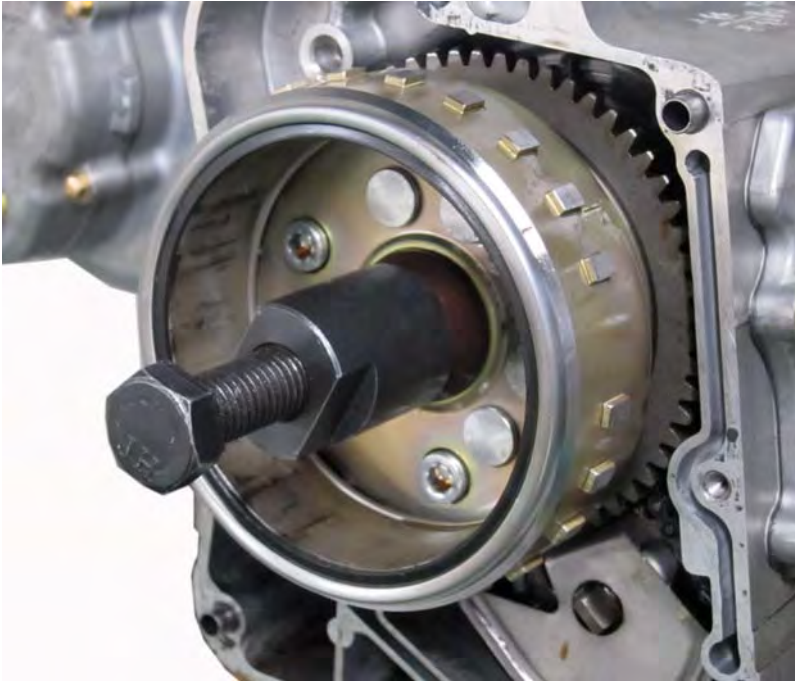

Apply grease to the threads of the flywheel puller tool before using it. Thread the puller onto the flywheel. Hold the tool with a large wrench and turn in the bolt until the pressure separates the flywheel from the crankshaft.

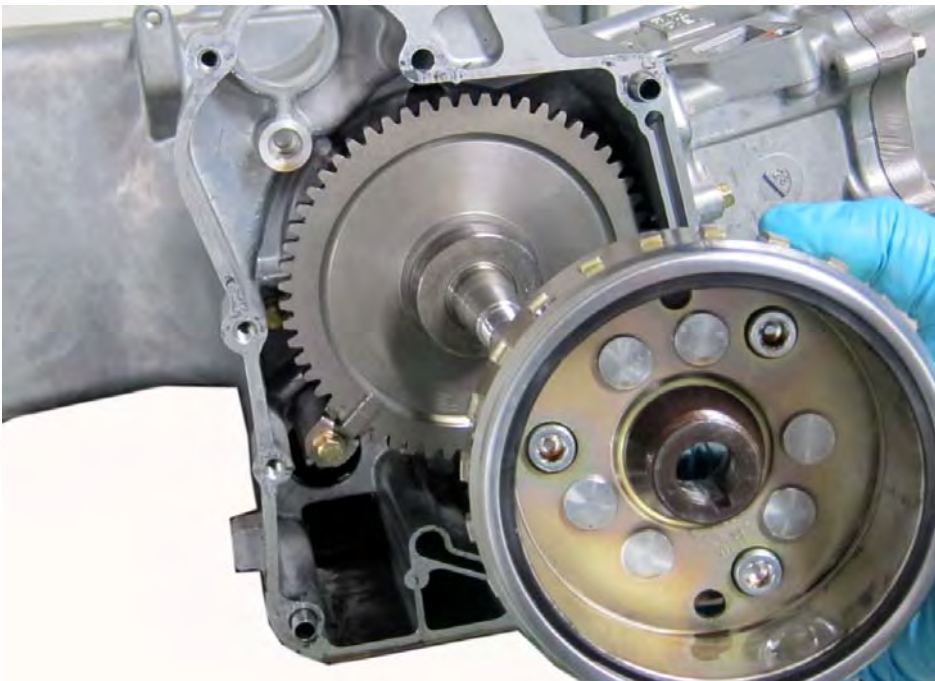

Remove the flywheel from the crankshaft.

2. Engine > Generator



Slide the starter driven gear off of the crankshaft.



Remove the woodruff key from the crankshaft.

Starter Clutch

2. Engine > Generator

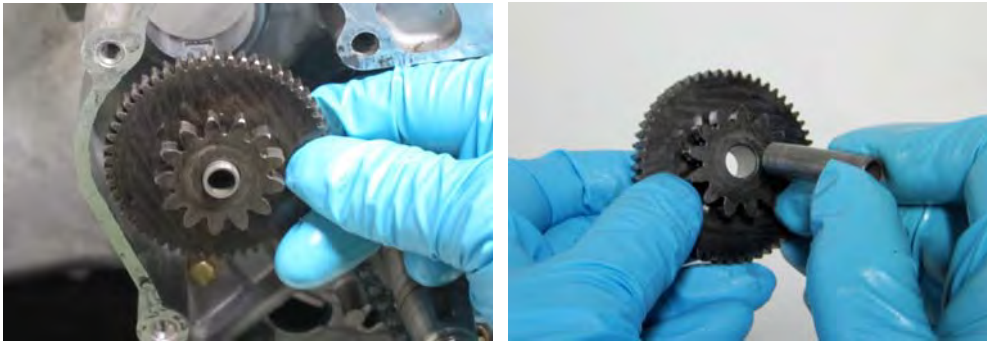

Remove the starter idle gear and shaft from the crankcase.



Inspect the starter idle gear and shaft for wear and damage. Replace the idle gear and shaft as needed.



Inspect the starter driven gear for wear and damage. Measure the inside and outside diameter of the starter driven gear and replace it as needed.

Item	Service Limit (mm)
Starter drive gear I.D.	20.05
Starter drive gear O.D.	39.50

2. Engine > Generator

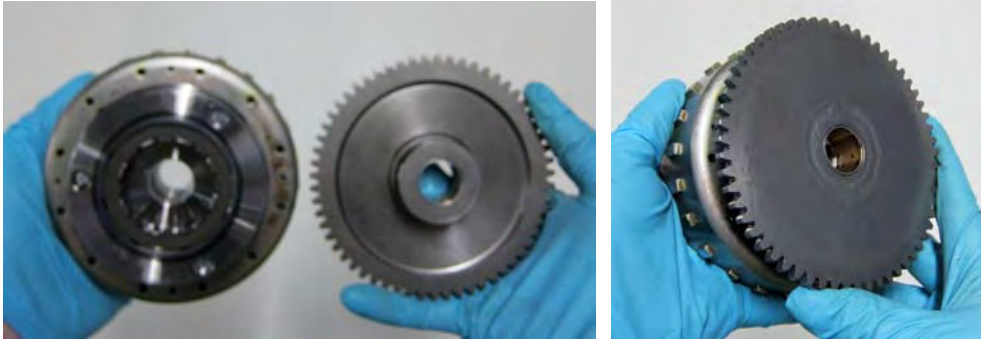

Fit the boss of the starter driven gear into the starter clutch. The starter clutch should only allow the driven gear to turn in one direction. If the starter clutch allows turning both ways or will not let the driven gear rotate smoothly in one direction the starter clutch must be replaced.



Remove the three starter clutch mounting bolts with a 6 mm Allen socket.

Installation

Starter Clutch



Fit the starter clutch to the back of the flywheel. Apply blue Loctite to the threads of the three starter clutch mounting bolts. Insert the three starter clutch mounting bolts.

2. Engine > Generator



Tighten the starter clutch mounting bolts to specification with a 6 mm Allen socket.

Item	Qty	Thread size (mm)	Torque	
			kgf-m	lb-ft
Oneway clutch bolt	3	8	1.8-2.2	13.02-15.91



Lubricate the starter idle gear shaft with fresh engine oil. Install the starter idle gear and shaft into the crankcase.

Flywheel

2. Engine > Generator



Install the woodruff key into its slot on the end of the crankshaft.



Lubricate the inside of the starter driven gear with fresh engine oil. Slide the starter driven gear onto the flywheel as shown.

Clean off the tapered end of the crankshaft where the flywheel will ride and make sure the inside of the flywheel is oil free where it will contact the crankshaft.

2. Engine > Generator

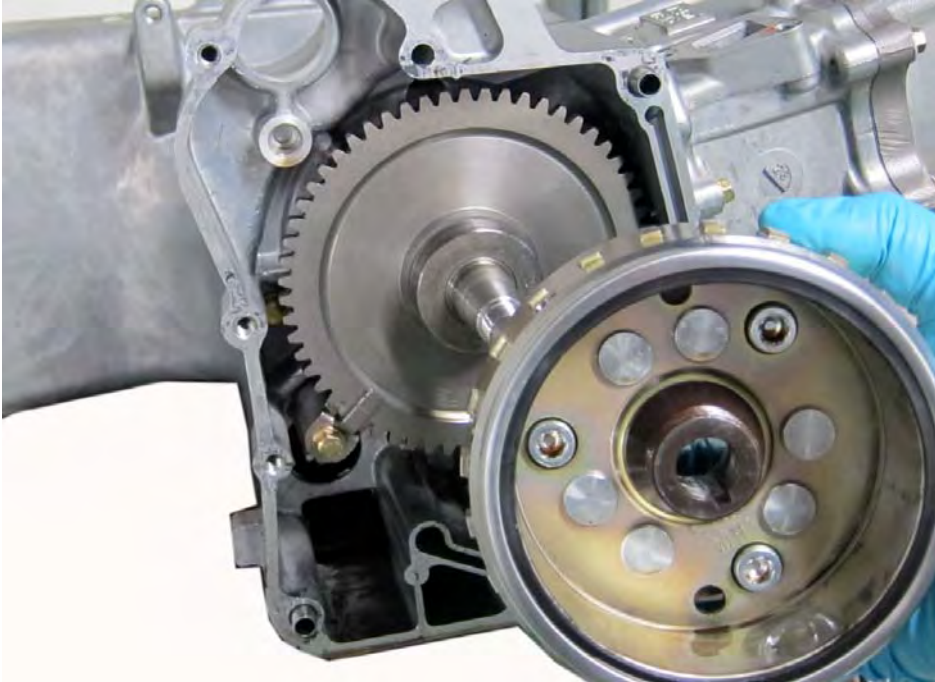

Line up the groove in the flywheel with the key and fit the flywheel onto the crankshaft. Guide the starter driven gear into the starter clutch on the back of the flywheel.



Install the washer and flywheel nut.

2. Engine > Generator

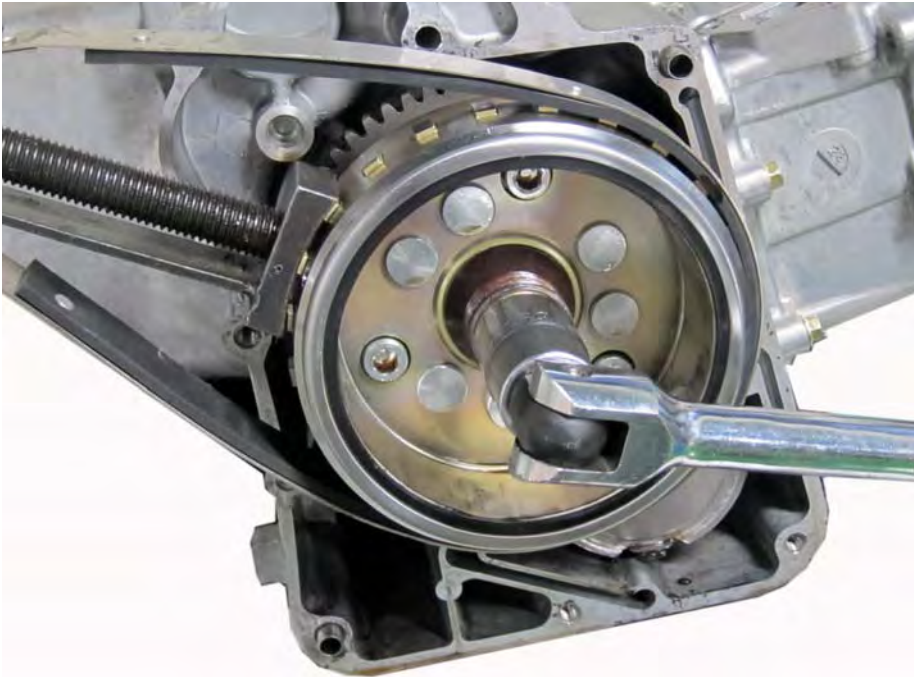

Hold the flywheel with the universal holder and torque the flywheel nut to specification with a 19 mm socket.

Item	Qty	Thread size (mm)	Torque	
			kgf-m	lb-ft
ACG flywheel nut	1	14	5.0 - 6.0	36.0 – 43.2

ITEM	TOOL NO.
UNIVERSAL HOLDER	E021

Stator and Crank Position Sensor



2. Engine > Generator

Fit the stator and the crankshaft position sensor into the generator cover together as shown. Insert the two crank position sensor mounting bolts and the three stator mounting bolts. Tighten the bolts securely with an 8 mm socket.

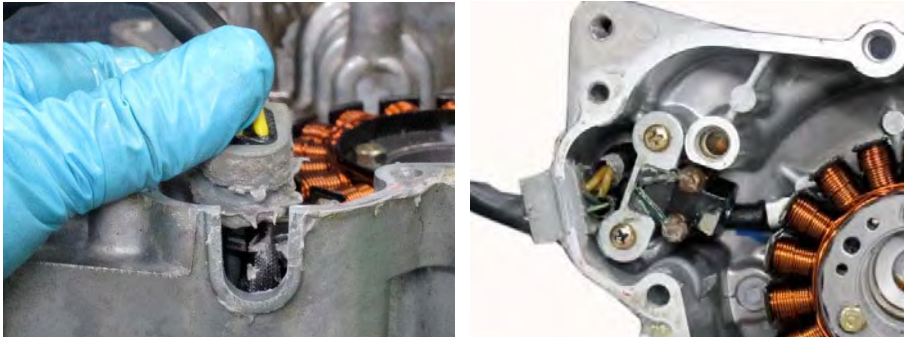

Coat the rubber grommet in silicone sealant where it contacts the generator cover. Fit the rubber wire grommet into its cutout in the crankcase cover.

Generator Cover

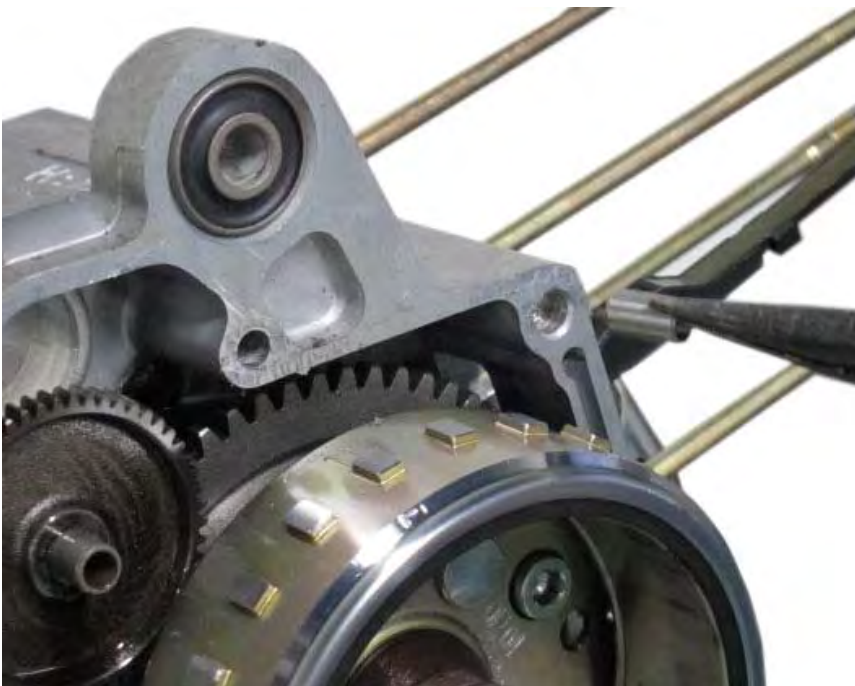

Make sure the generator cover mating surface is clean. Install the two dowel pins and a new generator cover gasket.

2. Engine > Generator

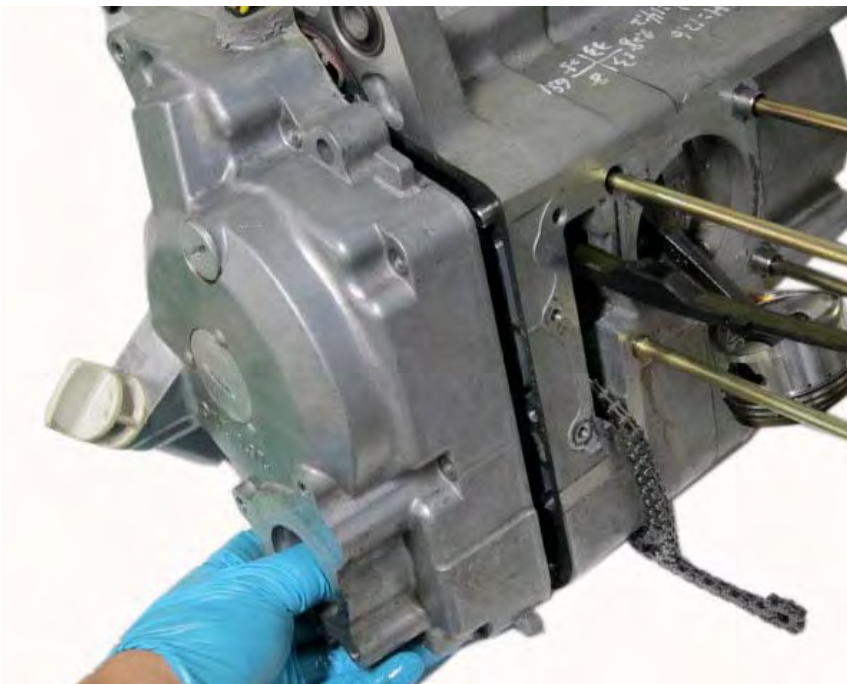

Fit the generator cover into place. Make sure the water pump shaft engages correctly with the oil pump shaft.

2. Engine > Generator

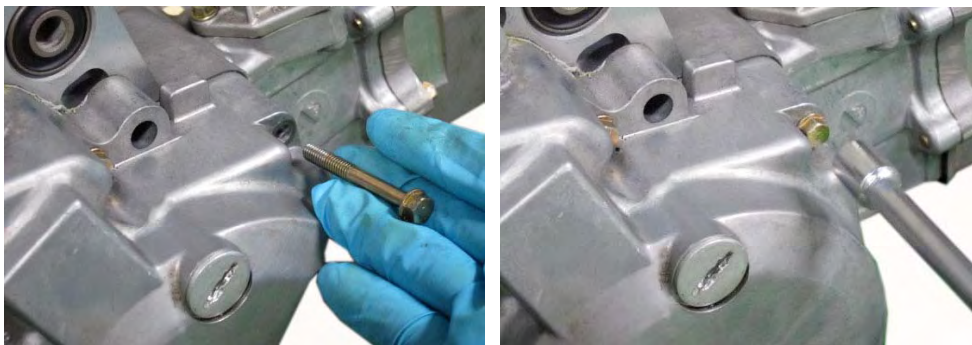

Insert the 12 generator cover bolts. Note the upper most bolt holds a wire stay. Tighten the bolts securely in a with an 8 mm socket.

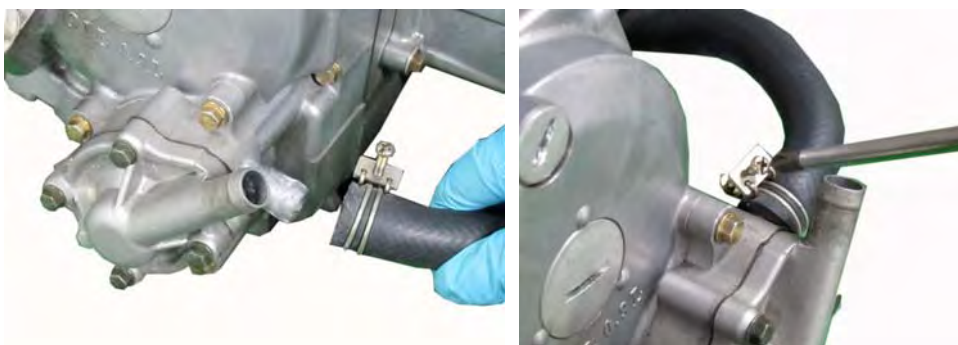

Fit the coolant hose to the right crankcase cover pipe. Secure the hose with the clamp and tighten the coolant hose clamp securely with a #2 Phillips screwdriver.

2. Engine > Generator



Connect the coolant hose to the water pump. Move the clamp into place and tighten it securely with a #2 Phillips screwdriver.

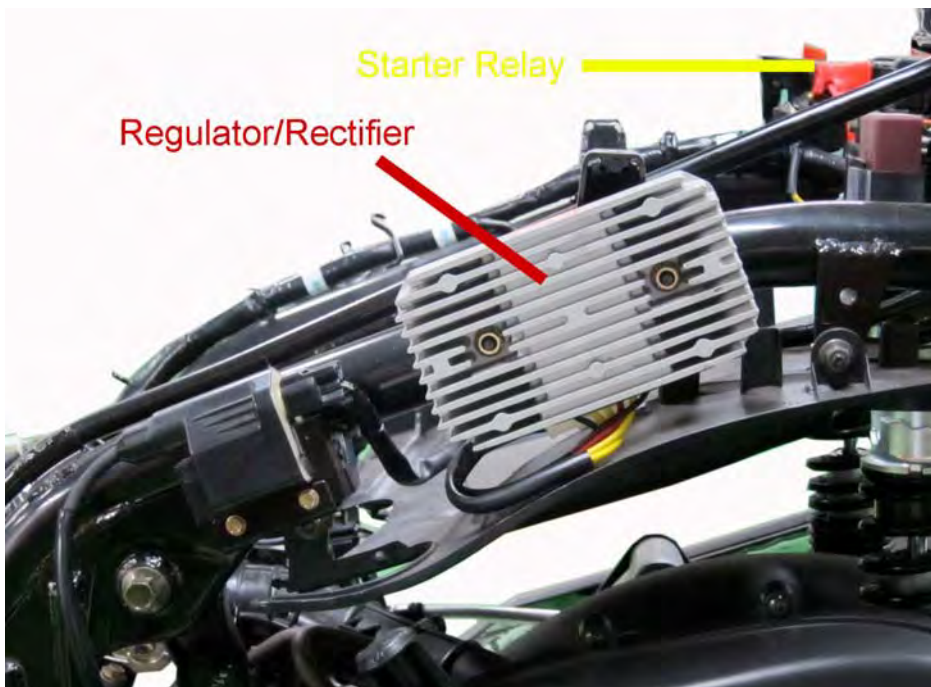

Plug in the regulator/rectifier 3-pin connector.

2. Engine > Generator



Plug in the crank position sensor wire coupler on the right side of the frame.

Fill the engine oil. See the [Engine Oil](#) topic for more information.

Install the exhaust system. See the [Exhaust System](#) topic for more information.

Fill the coolant and bleed the coolant. See the [Coolant](#) topic for more information.

Install the following components-

- ! [Foot Skirt](#)
- ! [Front Lower Cover](#)
- ! [Front Cover](#)
- ! [Body Cover](#)
- ! [Rear Carrier](#)
- ! [Center Cover](#)
- ! [Luggage Box](#)
- ! [Seat](#)

Crankshaft

SAFETY FIRST: Protective gloves and eyewear are recommended at this point.

Removal

Split the crankcases. See the [Crankcase](#) topic for more information.



Lift the crankshaft out of the left crankcase half.

Crankshaft Inspection



Check the side clearance of the big end of the connecting rod with a feeler gauge.

	Item	Standard (mm)	Service Limit (mm)
Crankshaft	Connecting rod big end side clearance	0.15 - 0.35	0.6



Grip the small end of the connecting rod and try and push the rod down towards the crank weights. If there is definite play between the connecting rod and crank the crankshaft should be replaced.

Crankshaft Bearings Installation

Lubricate the connecting rod big end and crankshaft shaft bearings with fresh engine oil.



Fit the crankshaft into the left crankcase bearing. Take care to avoid damaging the new oil seal.

Join the crankcases. See the [Crankcase](#) topic for more information.

Crankcase

SAFETY FIRST: Protective gloves and eyewear are recommended at this point.

Splitting

Drain the engine oil and remove the strainer screen. See the [Engine Oil](#) topic for more information.

Remove the engine. See the [Engine Removal](#) topic for more information.

Remove the cylinder head cover. See the [Cylinder Head Cover](#) topic for more information.

Remove the camshaft sprocket. See the [Camshaft](#) topic for more information.

Remove the cylinder head. See the [Cylinder Head](#) topic for more information.

Remove the generator cover, flywheel, starter idle gear and starter driven gear. See the [Generator](#) topic.

Remove the starter motor. See the [Starter Motor](#) topic for more information.

Remove the oil pump. See the [Oil Pump](#) topic for more information.

Remove the CVT pulleys and belt. See the [CVT Removal](#) topic.

Remove the rear wheel. See the [Rear Wheel](#) topic for more information.



Remove the upper cam chain guide bolt with an 12 mm Allen.

2. Engine > Crankcase



Remove the upper cam chain guide.



Inspect the cam chain guides for damage and excessive wear. Replace the guides as needed.

2. Engine > Crankcase



Remove the cam chain from the crankshaft and crankcase. Inspect the cam chain for wear and damage. Replace the cam chain as needed.

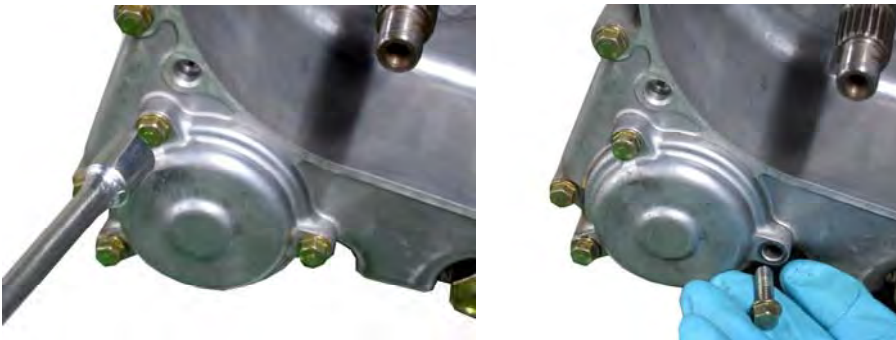

Remove the oil filter cover with an 8 mm socket.



Remove the oil filter. It should be replaced a new one per 2000km.

2. Engine > Crankcase

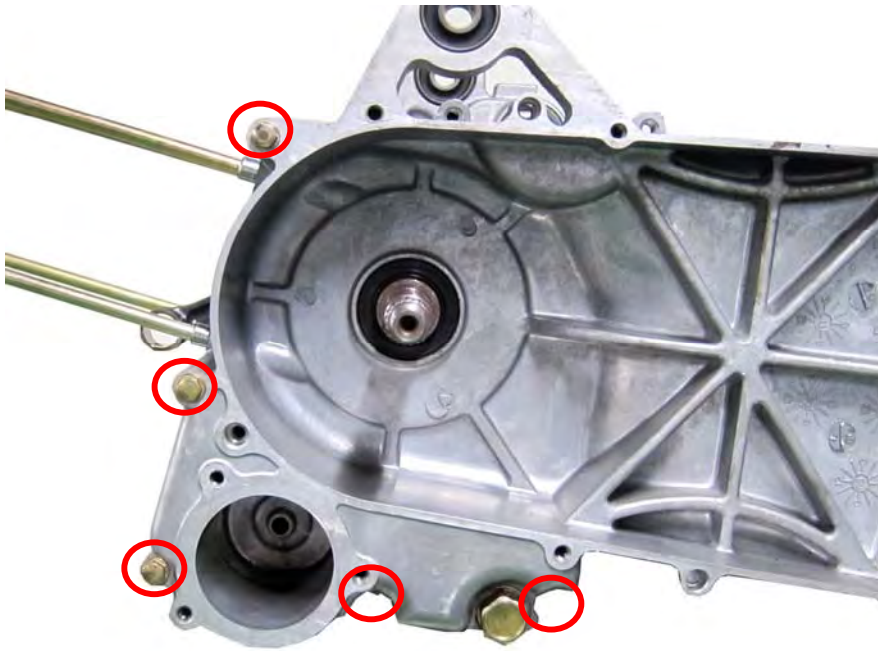

There are 4 crankcase bolts attaching the left side.

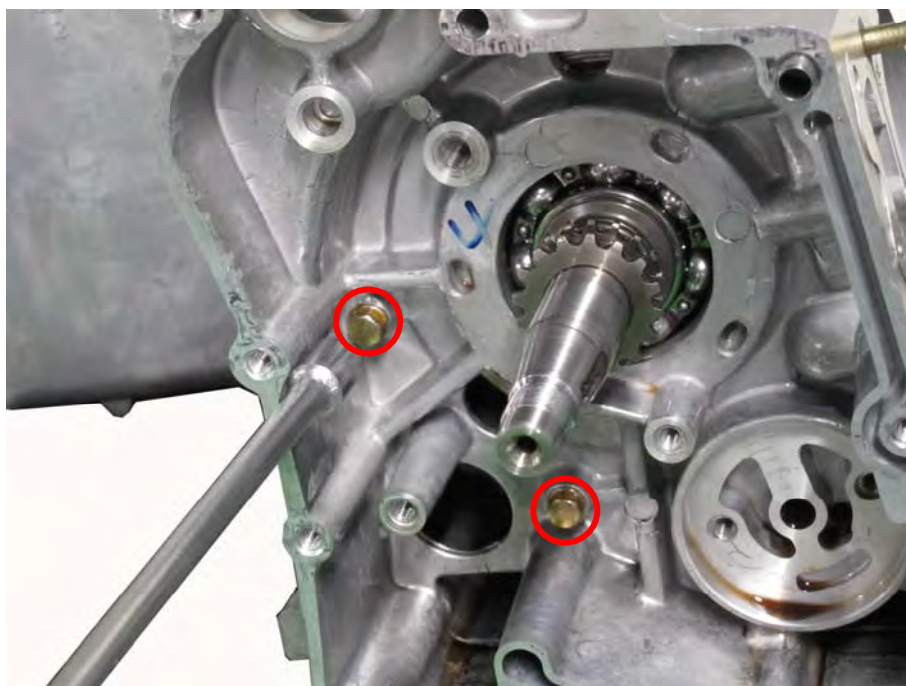

There are 2 crankcase bolts attaching the right side.

Loosen the 6 crankcase bolts in a crisscross pattern with an 8 mm socket. Remove the crankcase bolts from the left side of the engine.

2. Engine > Crankcase



Set the crankcases on the right side.

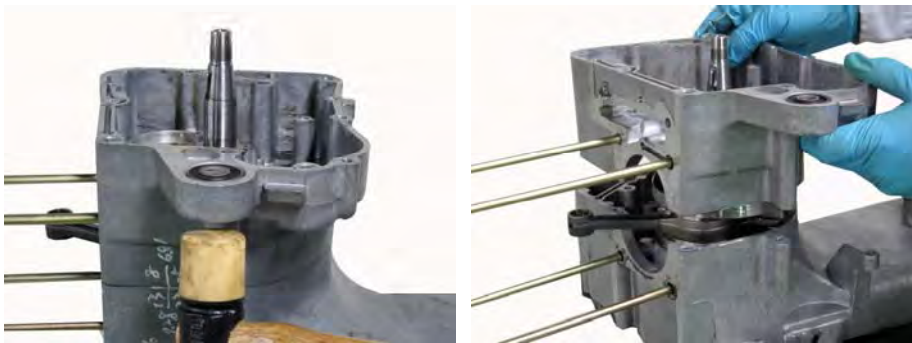

Separate the halves of the crankcase. If needed gently tap the reinforced areas of the right crankcase half with a rubber mallet. Lift the right crankcase off of the left.



Remove the two dowel pins from the crankcase. Inspect the gasket and replace it as needed.

2. Engine > Crankcase

To remove the crankshaft see the [Crankshaft](#) topic.



Replace the left crankshaft seal if the crankcases are separated.



Remove the seal with a seal pick.

2. Engine > Crankcase



Drive the new seal into the left crankcase from the outside with a suitable driver. The driver should have the same outside diameter as the seal. Lubricate the new crankshaft seal lips with fresh engine oil.

Assembly

Thoroughly clean the crankcase mating surface.



Replace a new gasket.

2. Engine > Crankcase

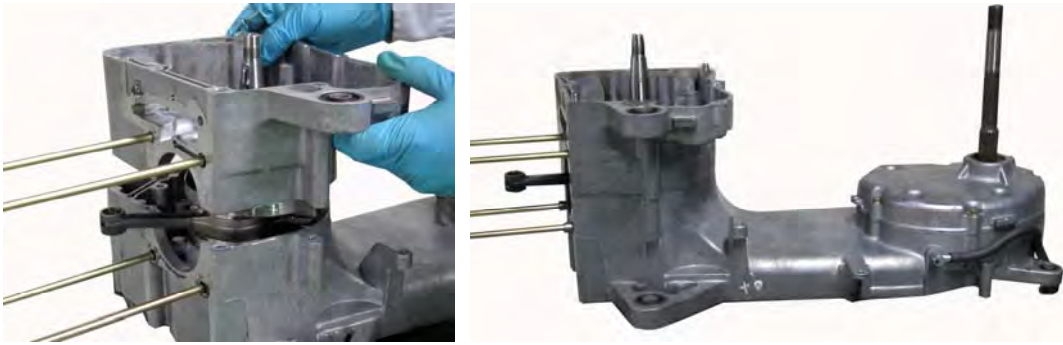

Set the right case half down on top of the left. Install the engine mount spacer.

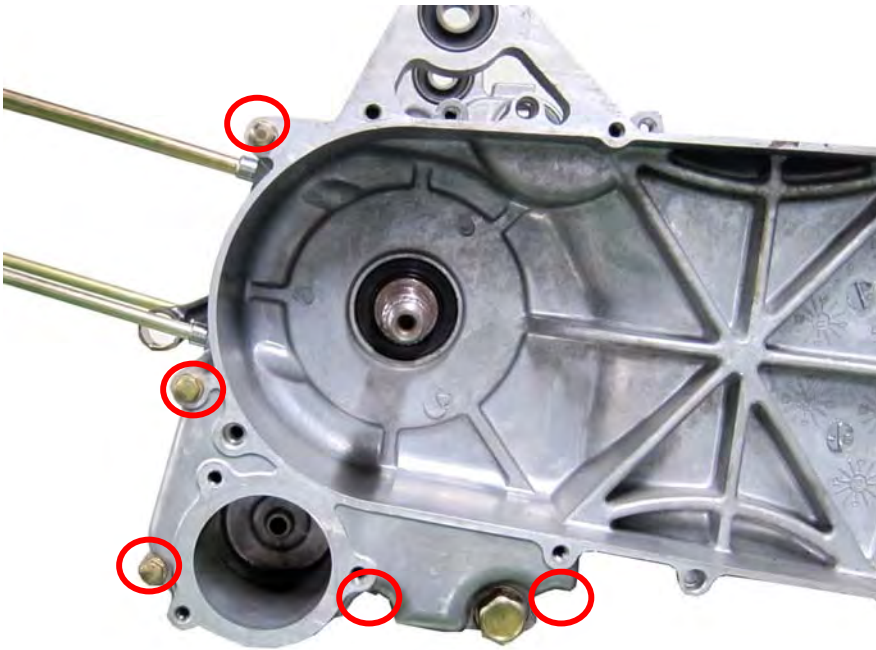

Insert the 5 crankcase bolts onto the left crankcase.

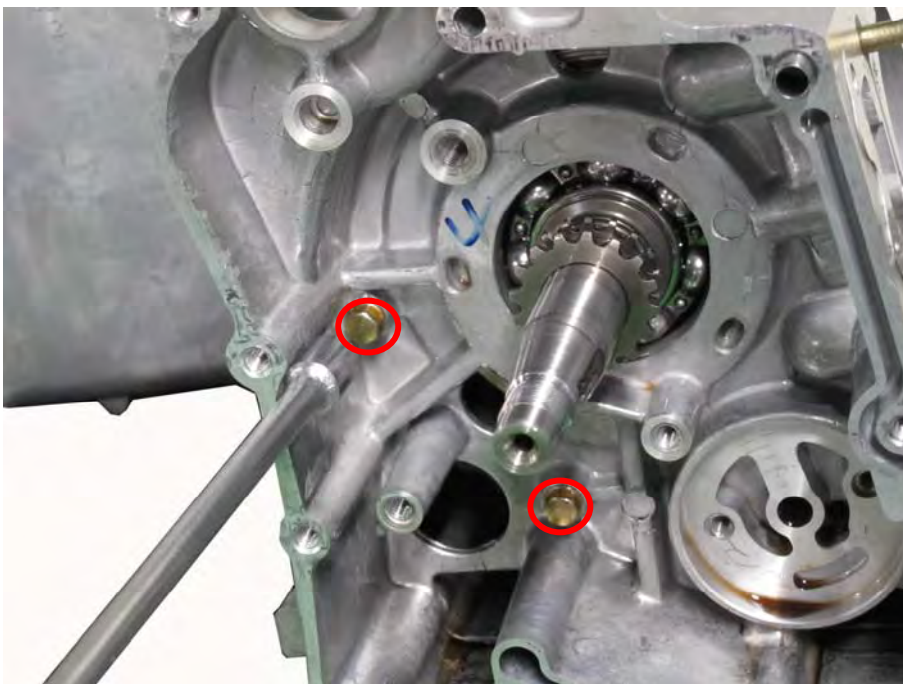

Insert the 2 crankcase bolts onto the right crankcase. Tighten the bolts securely and evenly in a crisscross pattern with an 8 mm socket.

2. Engine > Crankcase

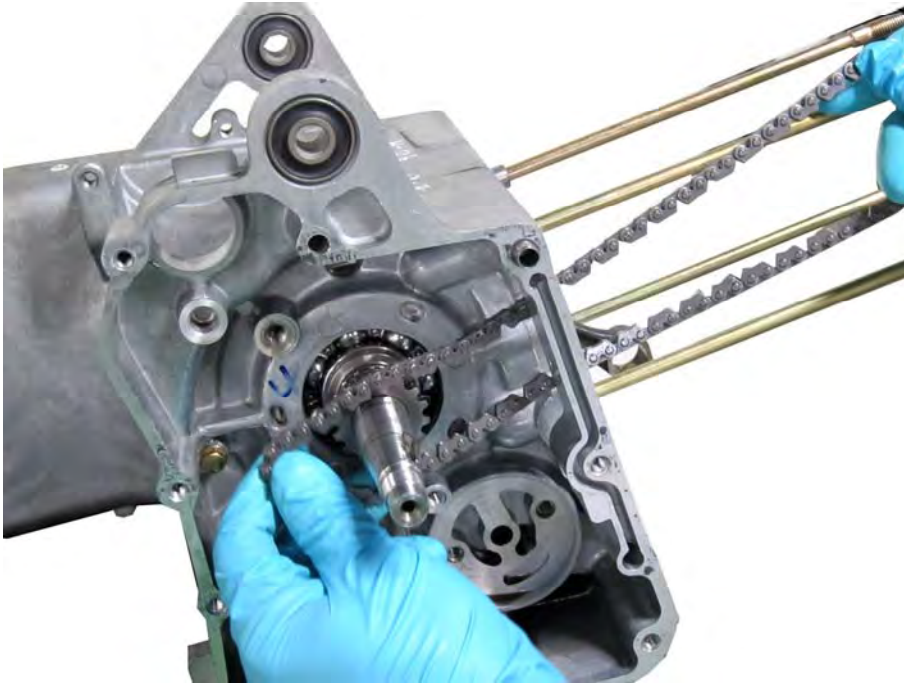

Install the cam chain around the timing sprocket teeth on the crankshaft.



Fit the upper cam chain guide into place.



Insert the upper cam chain guide mounting bolt and tighten it to specification with an 10 mm Allen socket.

2. Engine > Crankcase

Item	Qty	Thread size (mm)	Torque	
			kgf-m	lb-ft
Cam chain tensioner pivot	1	10	1.2-1.6	8.64 – 11.52

Install the oil pump. See the [Oil Pump](#) topic for more information.

Install the starter idle gear, driven gear, flywheel, and the generator cover. See the [Generator](#) topic.

Install the starter motor. See the [Starter Motor](#) topic for more information.

Install the CVT pulleys and belt. See the [CVT Installation](#) topic for more information.

Install the cylinder and piston. See the [Cylinder and Piston](#) topic for more information.

Install the cylinder head. See the [Cylinder Head](#) topic.

Install the camshaft. See the [Camshaft](#) topic for more information.

Install the cylinder head cover. See the [Cylinder Head Cover](#) topic for more information.

Install the rear wheel. See the [Rear Wheel](#) topic for more information.

Install the engine into the frame. See the [Engine Installation](#) topic for more information.

2. Engine > Cylinder Head Cover

Cylinder Head Cover

SAFETY FIRST: Protective gloves and eyewear are recommended at this point.

Removal

Remove the seat. See the [Seat](#) topic for more information.

Remove the luggage box. See the [Luggage Box](#) topic for more information.

Remove the spark plug. See the [Spark Plug](#) topic for more information.



Squeeze the breather hose clamp with needle nose pliers and slide it back. Remove the breather hose from the cylinder head cover.

2. Engine > Cylinder Head Cover



Loosen the fuel hose stay bolt with an 10 mm socket. Free the fuel hose stay from the cylinder head cover.



Loosen the four cylinder head cover bolts with a 10 mm socket. Remove the cylinder head cover bolts.

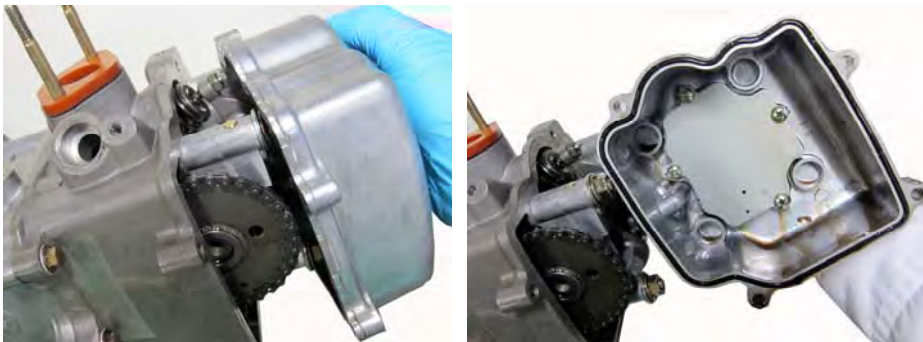

Remove the cylinder head cover and gasket. Discard the gasket and replace it with a new item on installation.

2. Engine > Cylinder Head Cover

Installation



Fit the cylinder head cover gasket onto the cylinder head. Make sure the projection fits into the groove.

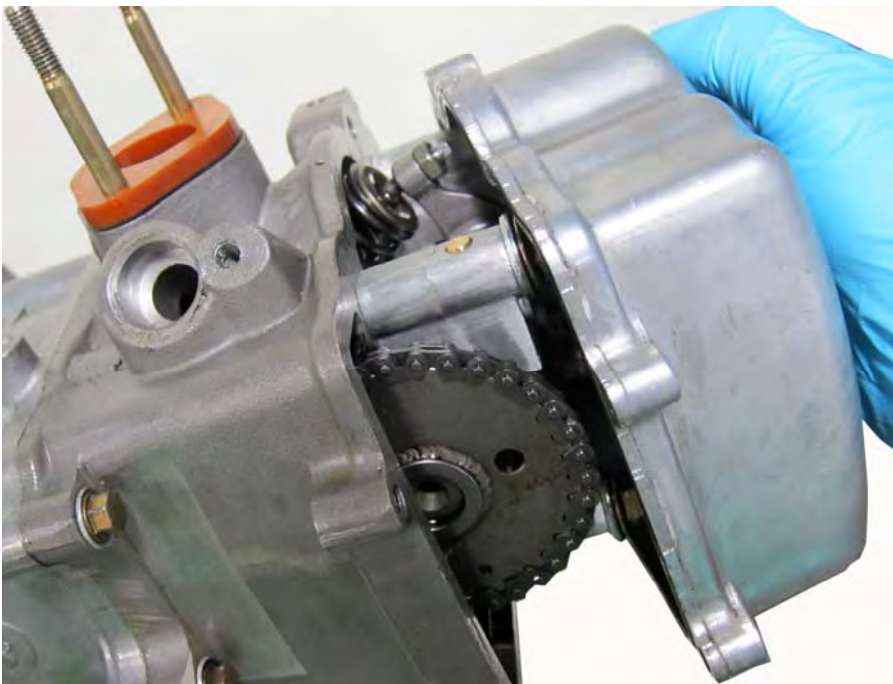

Install the cylinder head cover over the gasket. Make sure the ridge on the gasket fits into the groove on the cylinder head cover correctly. Align the bolt holes.

2. Engine > Cylinder Head Cover



Insert the cylinder head cover bolts.



Tighten the cylinder head cover bolts securely in two steps and in a crisscross pattern with an 10 mm socket.

2. Engine > Cylinder Head Cover



Fit the fuel stay into place. Tighten the stay bolt securely with an 10 mm socket.



Install the breather hose to the cylinder head cover. Secure the hose with the clamp.

Install the spark plug. See the [SparkPlug](#) topic for more information.

Install the luggage box. See the [LuggageBox](#) topic for more information.

Install the seat. See the [Seat](#) topic for more information.

Camshaft

SAFETY FIRST: Protective gloves and eyewear are recommended at this point.

Removal

Remove the seat. See the [Seat](#) topic for more information.

Remove the luggage box. See the [Luggage Box](#) topic for more information.

Remove the spark plug. See the [Spark Plug](#) topic for more information.

Remove the cylinder head cover. See the [Cylinder Head Cover](#) topic for more information.



Remove the crankshaft cap on the right side of the engine with a large flat blade screwdriver. Inspect the O-ring on the cap and replace it as needed.



Remove the timing inspection cap from the right side of the engine with a large flat blade screwdriver. Inspect the O-ring on the cap and replace it as needed.

2. Engine > Camshaft

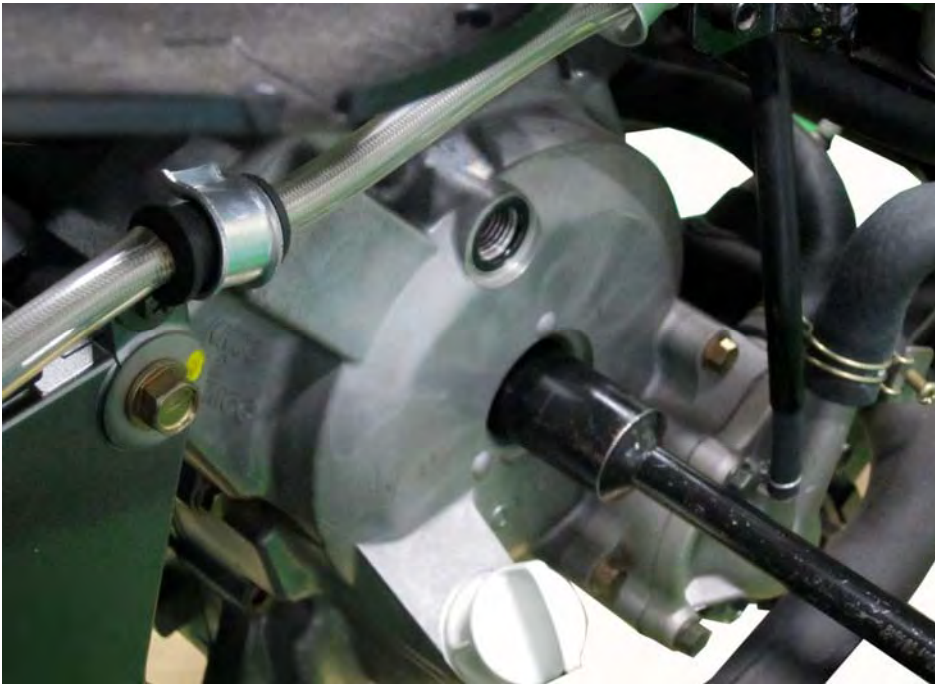

The crankshaft must be rotate (clockwise) until the piston is at top dead center (TDC) on the compression stroke.



Turn crankshaft clockwise until the "T" mark aligns with the index notch in the timing inspection hole.

2. Engine > Camshaft

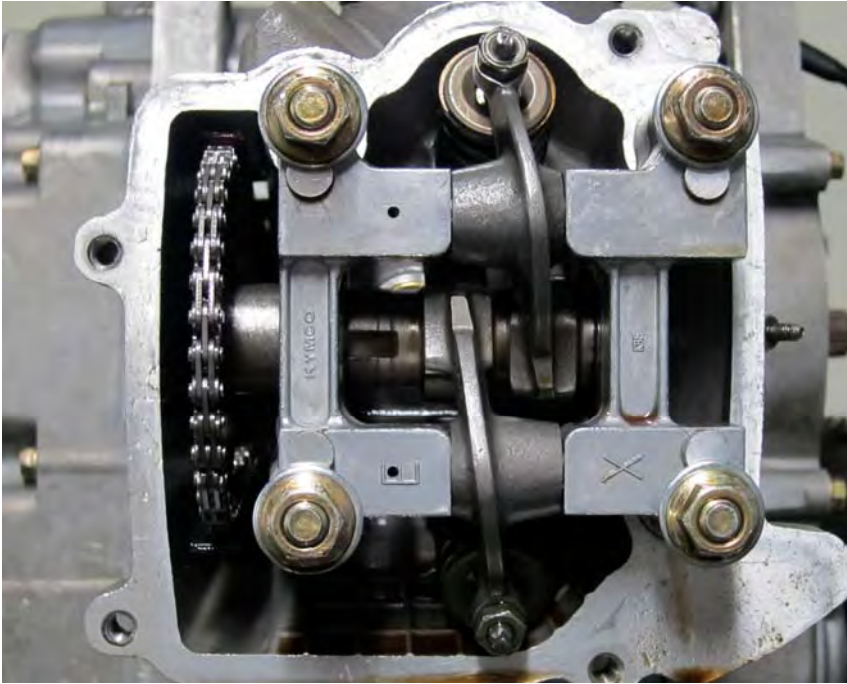

The piston should now be at TDC on the compression stroke. You can make sure that it is on the compression stroke by checking that there is some slack in the rocker arms. If the rocker arms are rigid, rotate the crankshaft 360° clockwise until the "T" mark is once again aligned with the notch on the case cover.



The cam chain tensioner is located on the back of the cylinder.

2. Engine > Camshaft

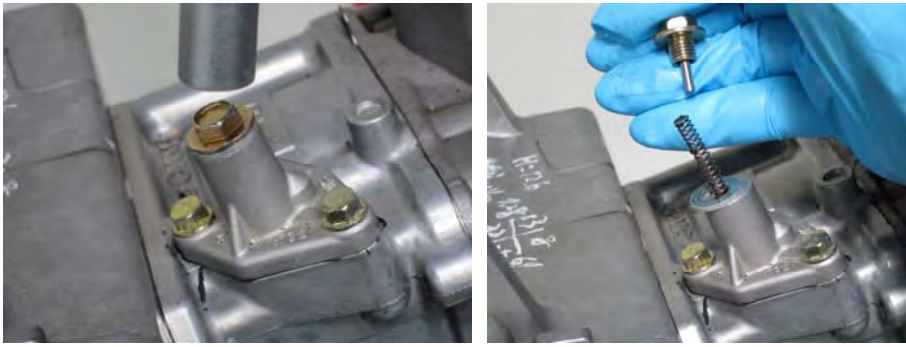

Remove the cam chain tensioner cap bolt with a 10 mm socket.



Loosen the cam chain tensioner mounting bolts evenly with an 8 mm socket.



Lift the cam chain tensioner out of the cylinder. Remove the cam chain tensioner gasket.

2. Engine > Camshaft

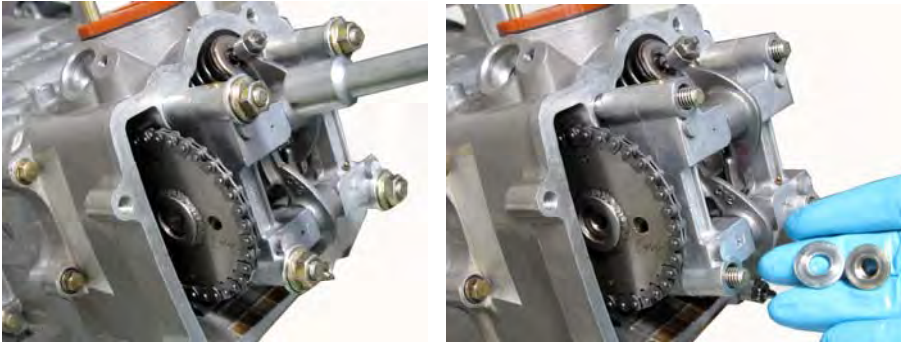

Remove four cam chain holder bolts with a 12 mm socket

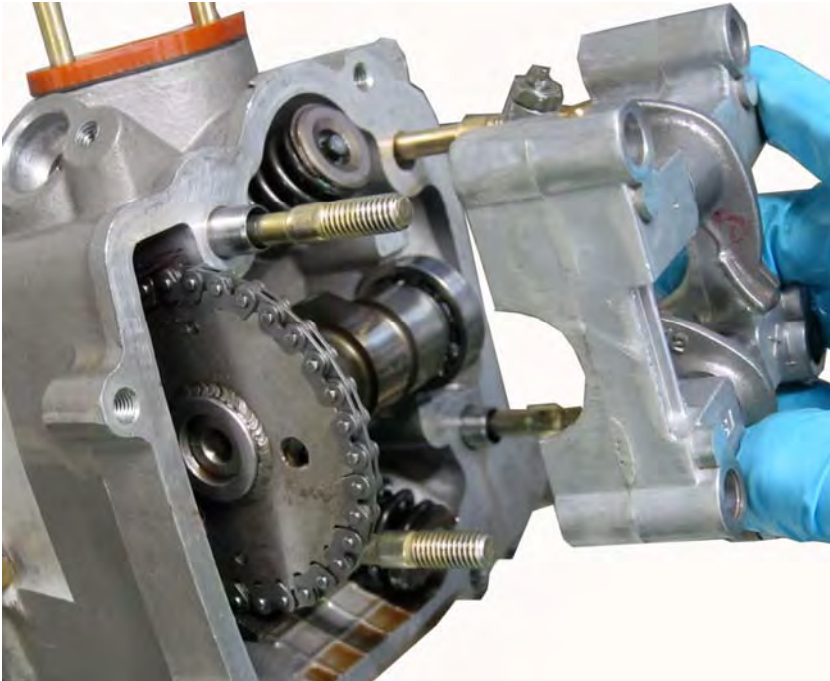

Remove the cam chain holder

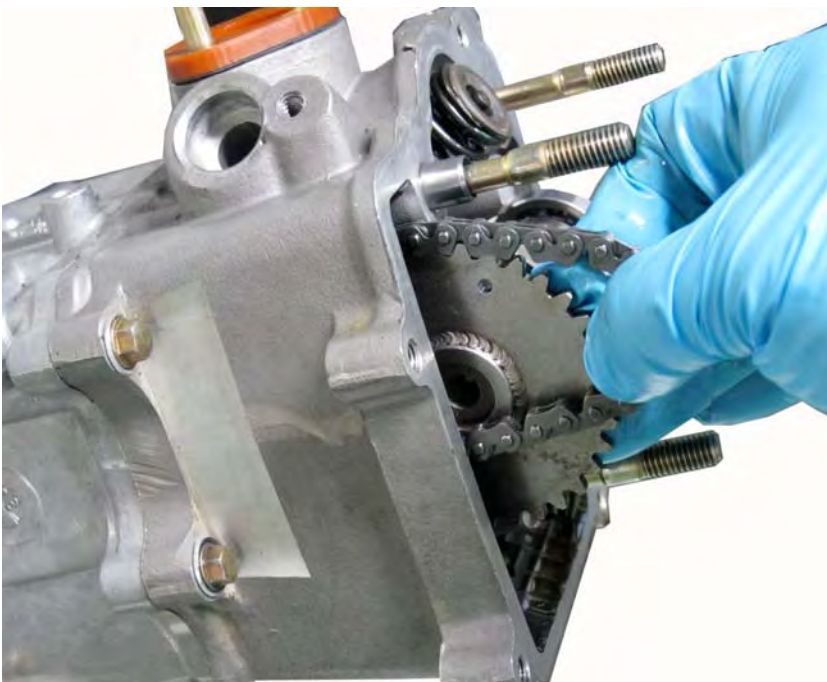

Remove the camshaft sprocket as shown. Support the chain so it does not fall into the cylinder head.

2. Engine > Camshaft

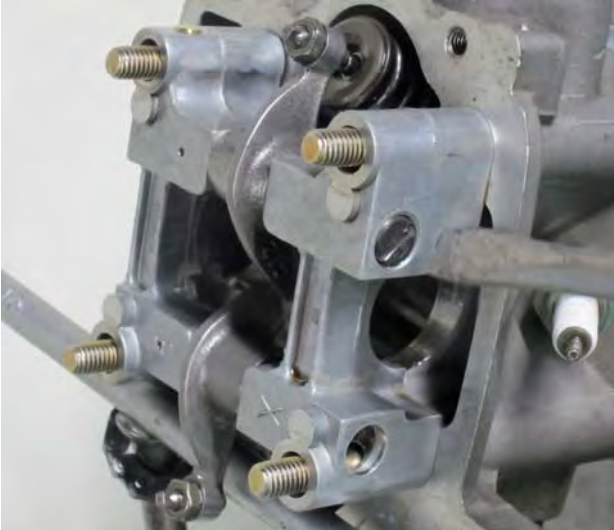

Remove the rocker arm shafts and pull the shafts out with a large flat blade screwdriver.



Lift out the rocker arms as the shafts are removed.



Remove the camshaft from the cylinder head.

2. Engine > Camshaft

Inspection

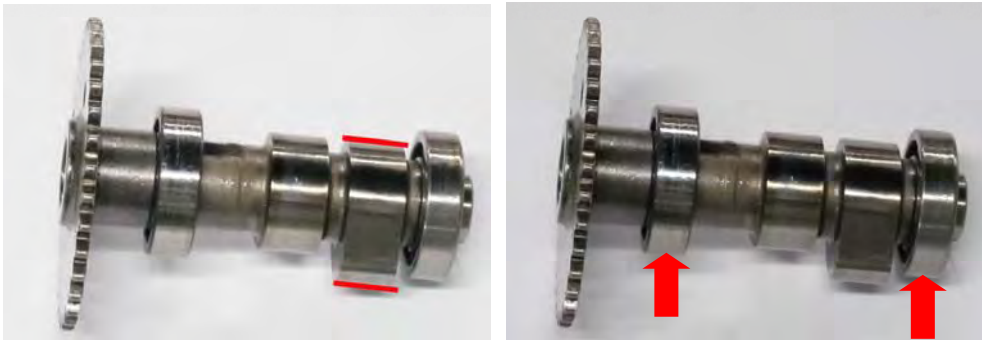

Inspect the camshaft cam heights for the intake and exhaust lobes. Inspect the camshaft bearings for excessive play or roughness. Replace the entire camshaft assembly if the bearings are rough or have excessive play.



Inspect the rocker arm shaft outer diameter for the intake and exhaust valves.

2. Engine > Camshaft



Inspect the rocker arm inner diameter for the intake and exhaust valves.

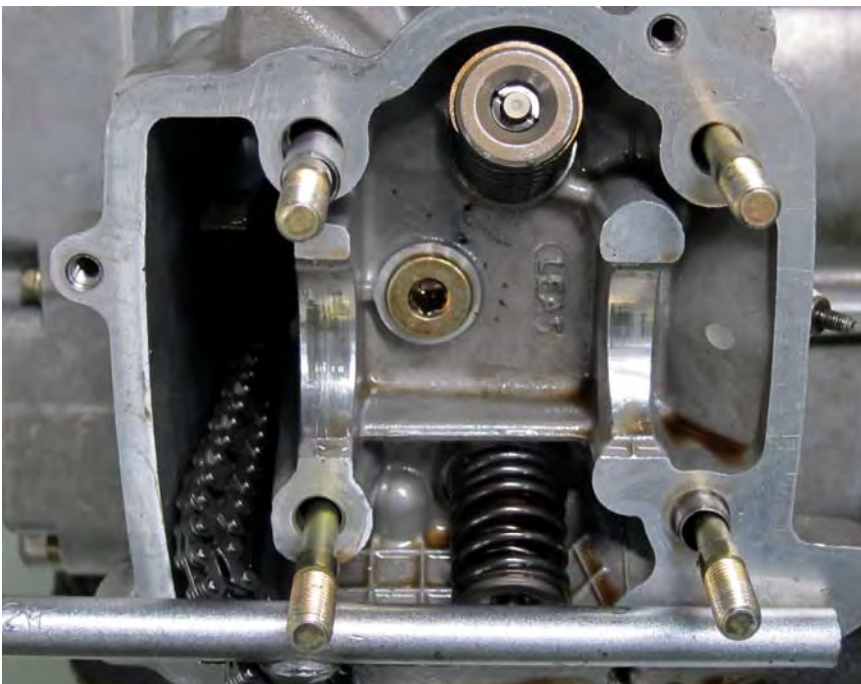

Inspect the camshaft bearing journals for scoring or scratches.

2. Engine > Camshaft



Inspect the camshaft sprocket for worn teeth or other signs of wear or damage.

Camshaft Installation

Clear out the cylinder head oil passages with compressed air. Make sure all cylinder head oil passages are free of clogs.

NOTE: Always wear safety glasses when using compressed air and never point it directly at yourself or anyone else.

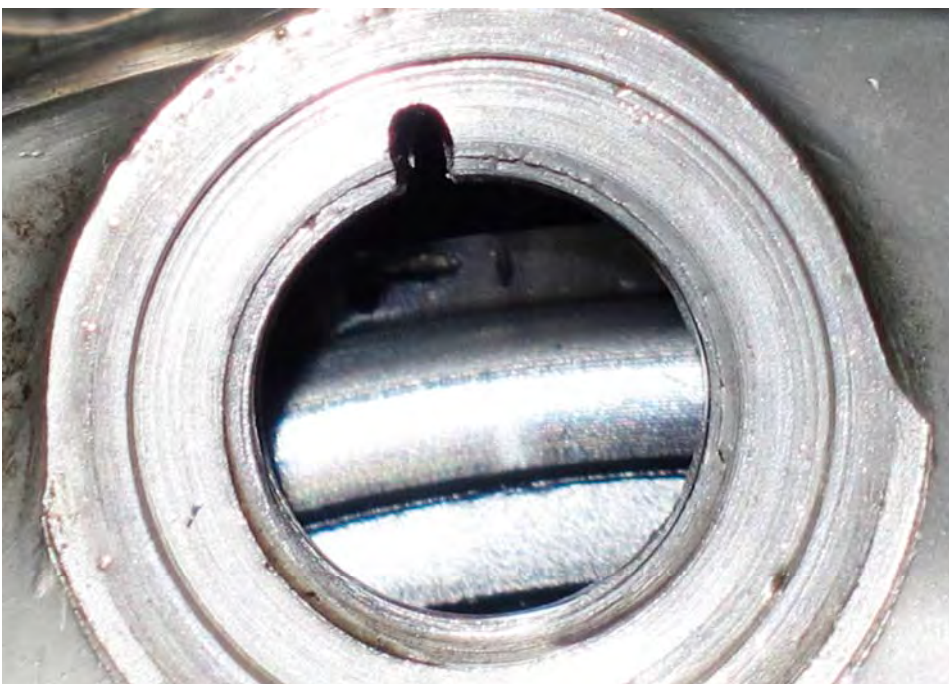

Position the piston at top dead center as above. The "T" mark should be aligned with the index notch in the timing inspection hole. Support the cam chain if the crank must be turned to position the piston correctly.

Lubricate the camshaft lobes and bearings with fresh engine oil.

2. Engine > Camshaft

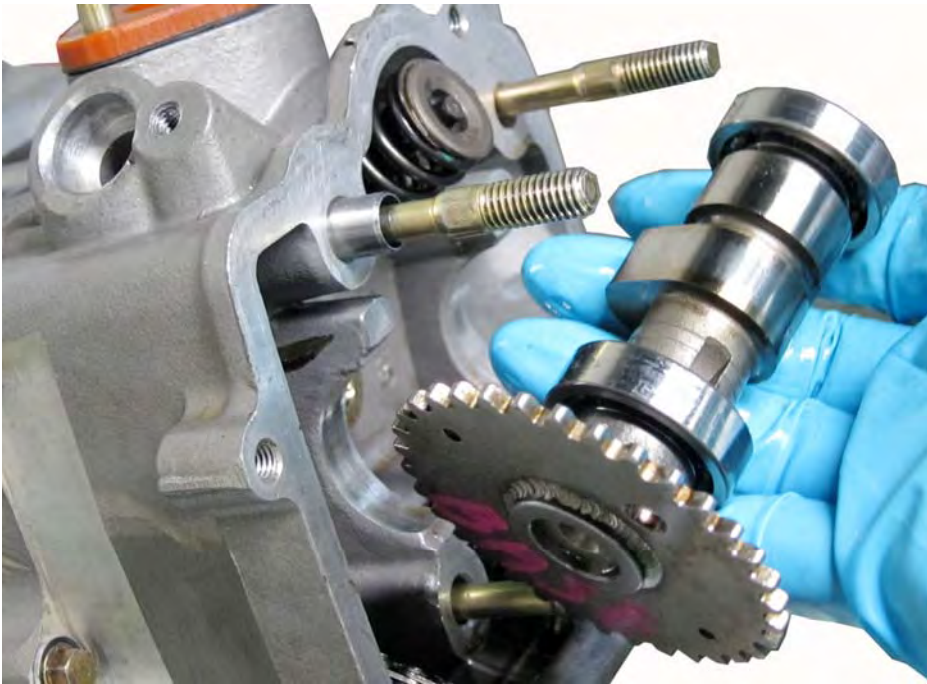

Put the camshaft into the cylinder head with the lobes facing down.



Lubricate the inside diameter of the rocker arms and the roller with fresh engine oil. Position the rocker arms to accept the rocker arm shafts.



Wipe the rocker arm shafts clean. Insert the rocker arm shafts through the camshaft holders and rocker arms. Install the rocker arm shafts so that the end sits as shown.

2. Engine > Camshaft

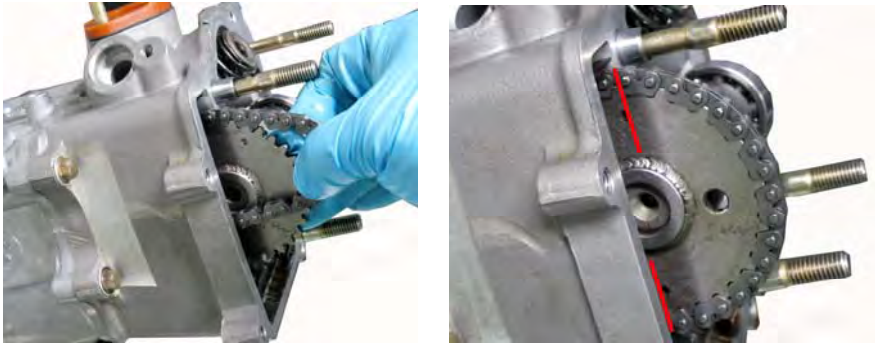

Install the camshaft sprocket onto the camshaft so the camshaft sprocket boss fits into the appropriate hole on the camshaft sprocket. Make sure the camshaft sprocket boss is facing up so it is visible above the edge of the cylinder head as shown. Align the horizontal marks on the camshaft sprocket with the top edge of the cylinder head as shown. Fit the camchain over the camshaft sprocket.

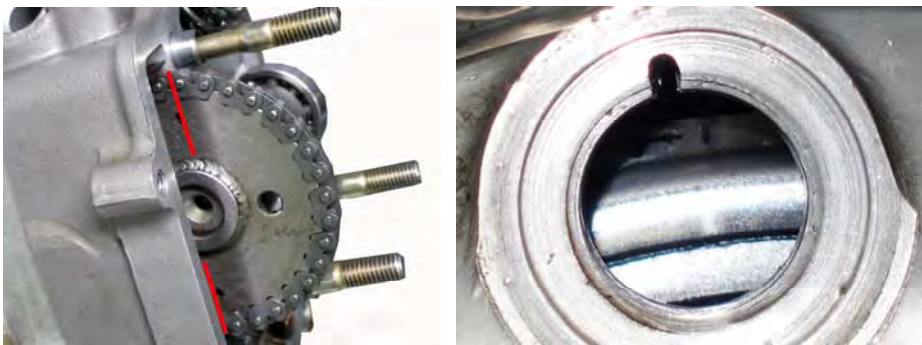

For correct engine timing the marks on the camshaft sprocket must be even with the cylinder head mating surface at the same time the "T" mark is lined up with the with the index notch in the timing inspection hole. The camshaft lobes should be facing down and their should be slack in the rocker arms.

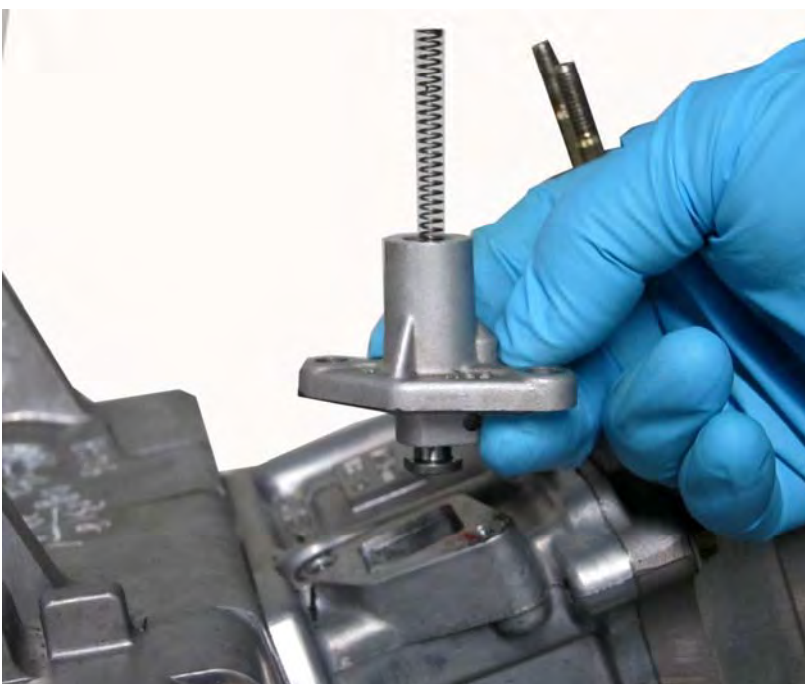

The rod must be held in the cylinder until the cam chain tensioner mounting bolts have been installed.

2. Engine > Camshaft



Install the camchain tensioner with a new gasket. Insert the mounting bolts and tighten them evenly to specification with an 8 mm socket.

Item	Qty	Thread size (mm)	Torque	
			kgf-m	lb-ft
Cam chain tensioner bolt	2	6	1.0-1.4	7.23-10.13

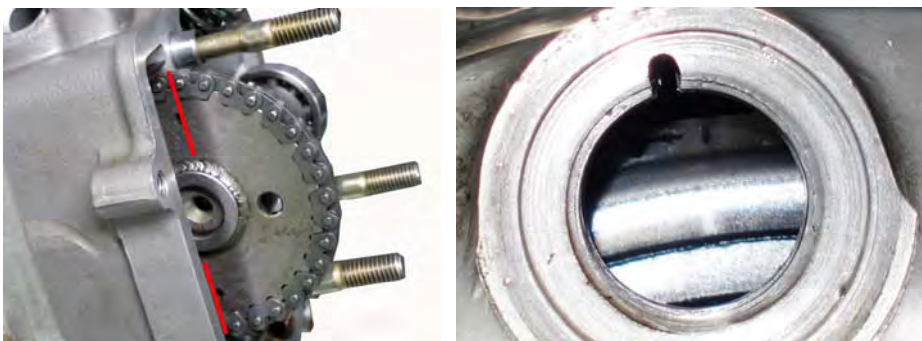

Rotate the crankshaft 360° clockwise and check the engine timing one more time.

2. Engine > Camshaft



Make sure the cam chain tensioner cap bolt washer is in good condition. Install the cam chain tensioner cap bolt. Tighten the bolt to securely with a 10 mm socket.

Check the valve clearance. See the [Valve Clearance](#) topic for more information.

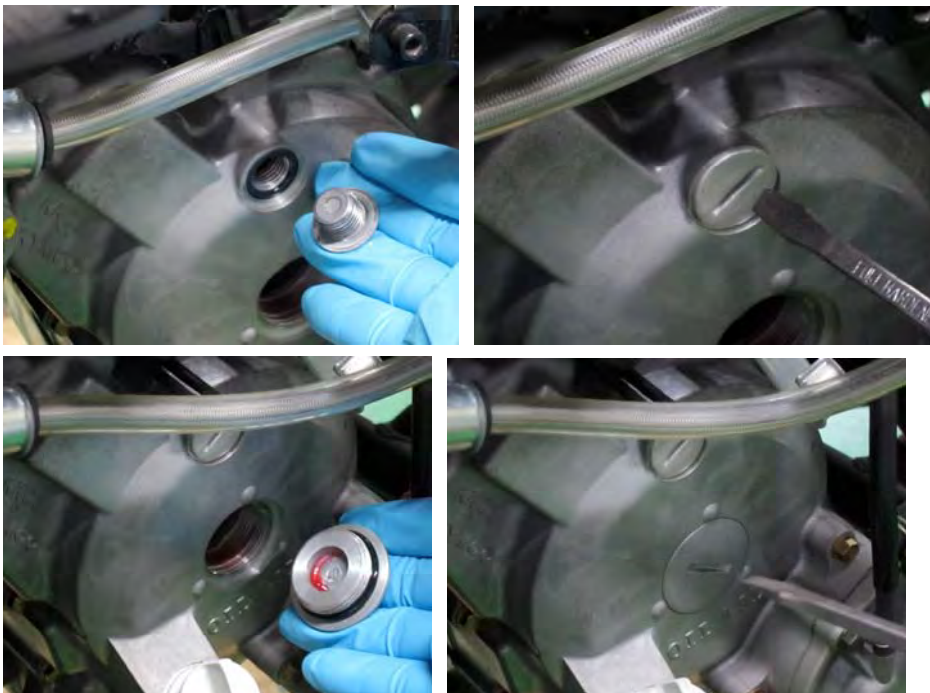

Make sure the O-rings on the crankshaft and timing plugs are in good condition. Replace them as needed. Install the timing inspection and crankshaft caps to the right side of the engine. Tighten the caps securely but not overly with a large flat blade screwdriver.

Install the cylinder head cover. See the [CylinderHead Cover](#) topic for more information.

Install the spark plug. See the [Spark Plug](#) topic for more information.

Install the luggage box. See the [Luggage Box](#) topic for more information.

Install the seat. See the [Seat](#) topic for more information.

2. Engine > Valves

Valves

SAFETY FIRST: Protective gloves and eyewear are recommended at this point.

Removal

Remove the camshaft. See the [Camshaft](#) topic for more information.

Remove the cylinder head. See the [Cylinder Head](#) topic for more information.

IMPORTANT: Record the position of all parts so they can be returned to their proper place during reassembly.



Push down the valve springs with a valve spring compressor.

Special Tool- Valve Spring Compressor: A120E00040



Remove the split keepers. There are two per valve.

2. Engine > Valves



Remove the spring retainer.



Remove the valve springs.



2. Engine > Valves

Push the valve stem down and remove the valve from the combustion chamber side of the cylinder head. Rotate the valve as it is removed.



Remove the valve seal from the valve guide. The valve seals should be replaced if they are removed or you are going to install new valves.

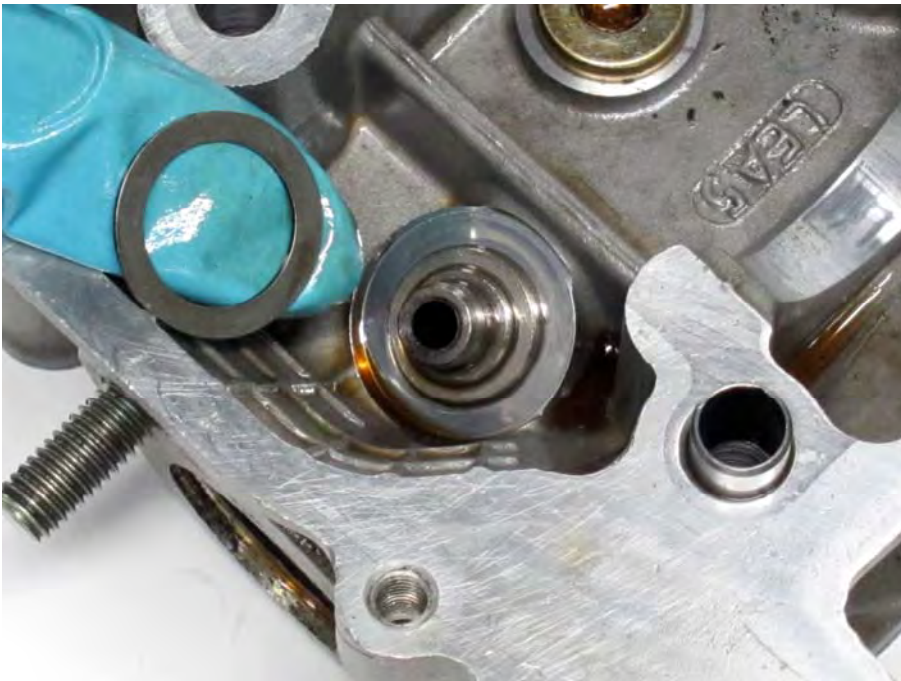

Remove the spring seat.

Inspection

2. Engine > Valves



Inspect the valve springs for fatigue and damage. Replace the valve springs as needed or if the valve is also to be replaced.



2. Engine > Valves

Inspect the valves for damage and burning. Measure the valve stem diameter in several places where the valve makes contact with the guide. If the measurement is below specification replace the valve.

Item		Standard (mm)
Valve stem O.D.	IN	4.975 — 4.990
	EX	4.955 — 4.970



Inspect the valve seat and the valve seat width. The valve seat should be centered on the valve face. If the seat is pitted, worn out, or fits poorly on the valve face the valve seat must be resurfaced.

Item		Standard (mm)
Valve seat width	IN	0.55 — 0.85
	EX	1.15 — 1.45



Measure the inside diameter of the valve guides. Replace the guides if the measurement is out of specification. Calculate the valve stem-to-guide clearance. Replace the guide and valve if the clearance is out of specification.

Item		Standard (mm)
Valve guide I.D.	IN	5.00 - 5.012
	EX	5.00 - 5.012
Valve stem-to-guide clearance	IN	0.010 - 0.037
	EX	0.030 - 0.057

2. Engine > Valves

Installation

Clean the cylinder head components thoroughly with a high flash-point solvent and compressed air. Return the components to their original locations.

NOTE: Always wear safety glasses when using compressed air and never point it directly at yourself or anyone else.



Install the spring seat.



Coat the new valve seal in fresh engine oil and install it onto the valve guide.

2. Engine > Valves

Coat the valve stem in fresh engine oil and insert the valve into the valve guide and through the seal. Turn the valve slowly as it is inserted. If you are installing a new valve you must ream the valve guide first. Make sure the valve will move smoothly in the valve guide without wobble.

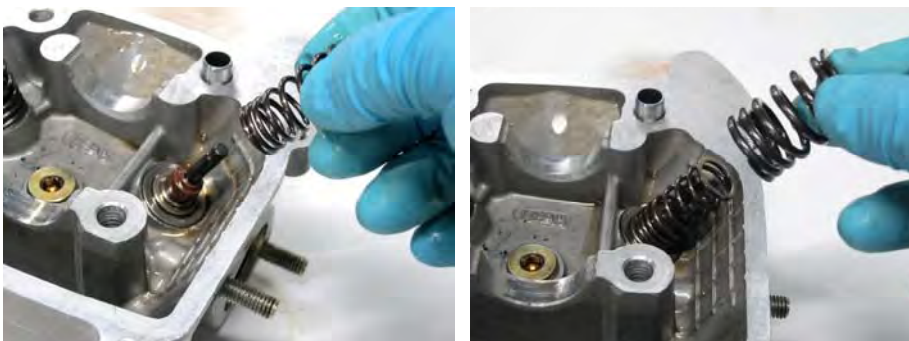

Install the valve springs. The tightly coiled end of the springs should sit against the spring seat.

2. Engine > Valves



Place the spring retainer on top of the spring.



Push down the valve springs with a valve spring compressor to allow enough room to install the split keepers. The valve cotter installer tool can also be used to install the split keepers.

Special Tool- Valve Spring Compressor: E040

2. Engine > Valves

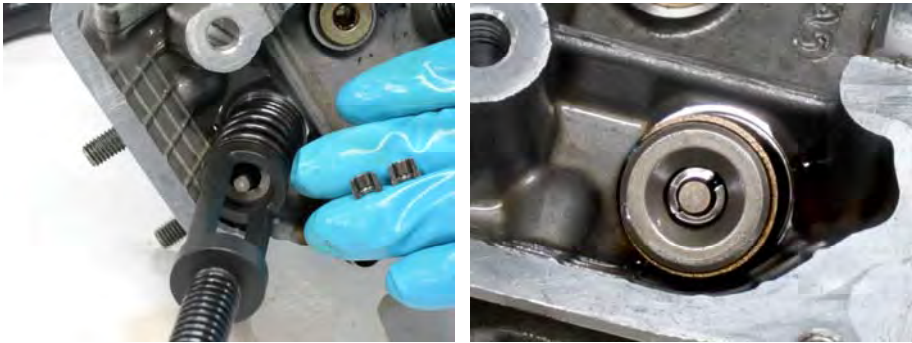

Apply grease to the inside of the split keepers. Apply a dab of grease to the end of a flat blade screwdriver. Set the keeper in the grease on the screwdriver and insert it onto the valve stem. Repeat this with the other keeper.

After the valves have been reassemble place a clean shop towel under the cylinder head in the combustion chamber area and gently tap each valve stem with a plastic rod and rubber mallet to make sure the valves are seated properly.

Install the cylinder head. See the [CylinderHead](#) topic for more information.

Install the camshaft. See the [Camshaft](#) topic for more information.

Cylinders and Pistons

SAFETY FIRST: Protective gloves and eyewear are recommended at this point.

Cylinder Block Removal

Remove the engine from the frame. See the [Engine Removal](#) topic for more information.

Remove the cylinder head cover. See the [CylinderHead Cover](#) topic for more information.

Remove the camshaft sprocket. See the [Camshaft](#) topic for more information.

Remove the cylinder head. See the [CylinderHead](#) topic for more information.

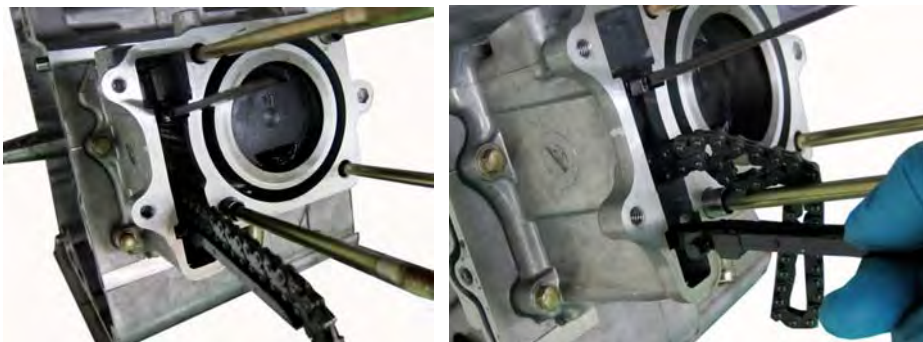

Slide out the lower cam chain guide. Inspect the guide for excessive wear and damage. Replace the guide as needed.

2. Engine > Cylinders and Pistons



Remove the two right side cylinder bolts with an 8 mm socket.



Loosen the cylinder coolant hose clamp with a #2 Phillips screwdriver.
Free the coolant hose from the cylinder.



2. Engine > Cylinders and Pistons

Slide the cylinder off of the studs and piston. Guide the cam chain through its opening and do not allow it to fall into the crankcase. Remove the cylinder.



Remove the two cylinder dowel pins from the left studs.

Place a clean shop towel under and around the base of the piston to prevent any parts or debris falling into the crankcase.

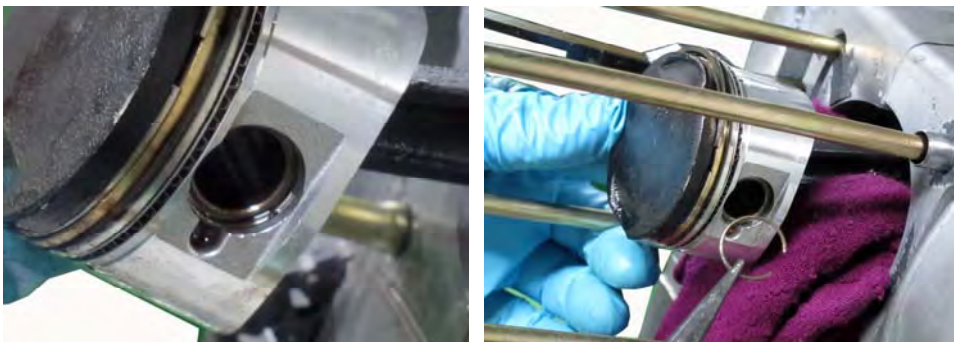

Remove the piston pin clips with a pick or needle nose pliers. Discard the piston pin clips.

2. Engine > Cylinders and Pistons



Remove the piston pin and the piston.

Clean off the cylinder mating surface, but take care to keep debris from falling into the crankcase.

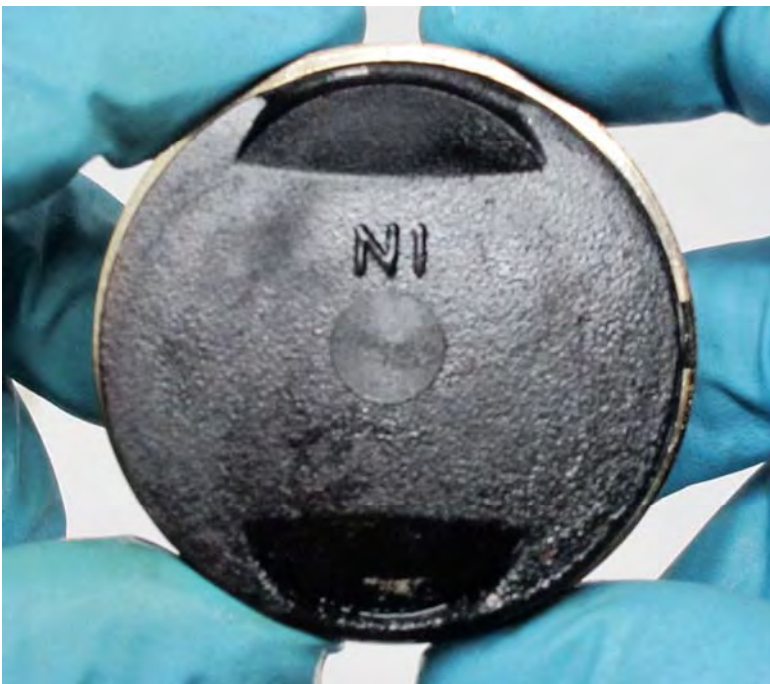

Spread the piston rings and lift them off opposite the gap. Spread the rings the minimum amount during removal. The rings can be easily damaged.

2. Engine > Cylinders and Pistons

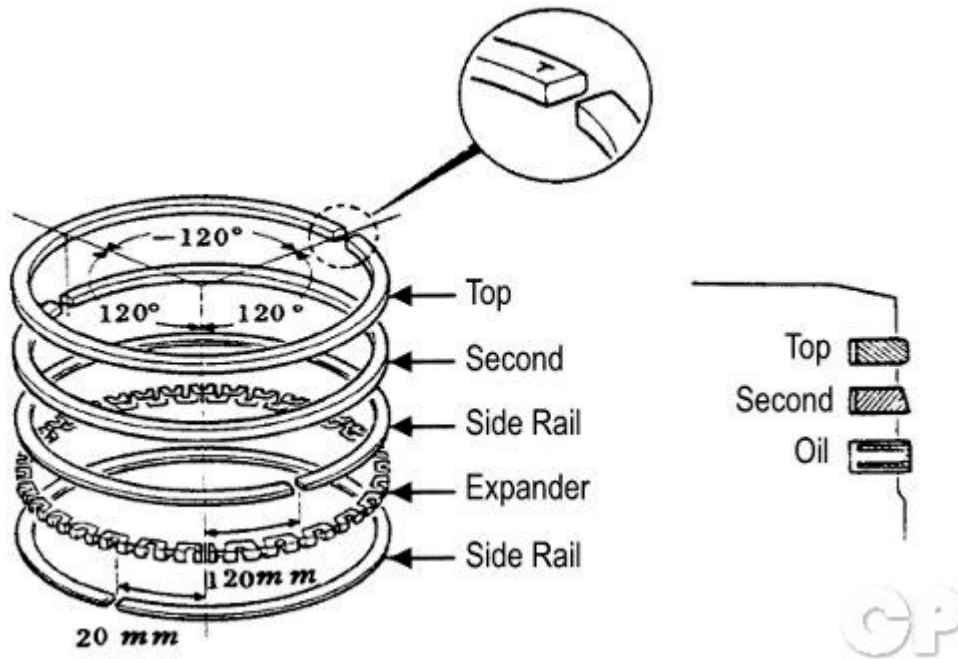

The two upper rings are each a single piece of metal. The oil ring consists of an expander ring and two side rails.



Clean the carbon build up off of the piston with a stiff bristled plastic brush or rag. Never use a wire brush to clean a piston.

2. Engine > Cylinders and Pistons

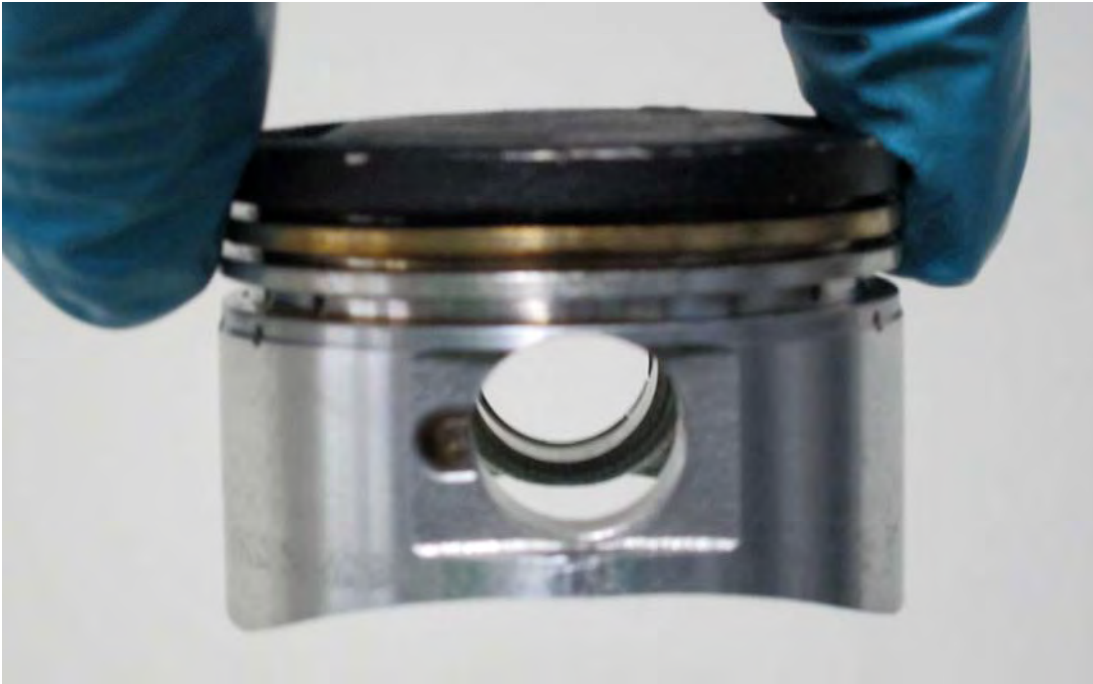

Also clean out the ring grooves. You can use an old ring to scrape out any carbon build up in the grooves.

Inspection



Inspect the cylinder bore for damage and abnormal wear

2. Engine > Cylinders and Pistons

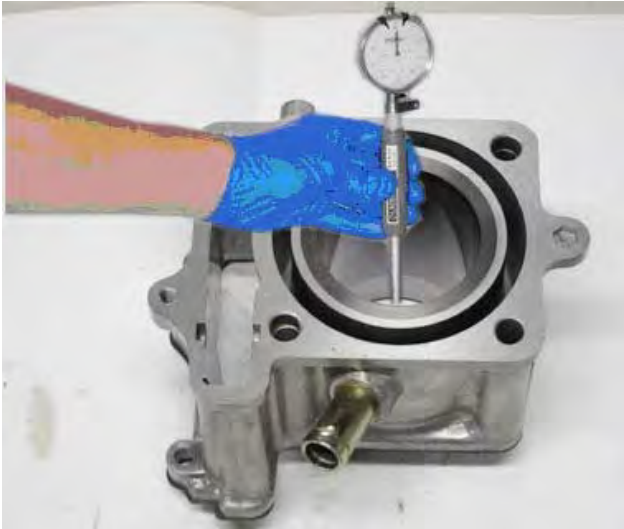

Measure the cylinder diameter as described below with a telescoping gauge.

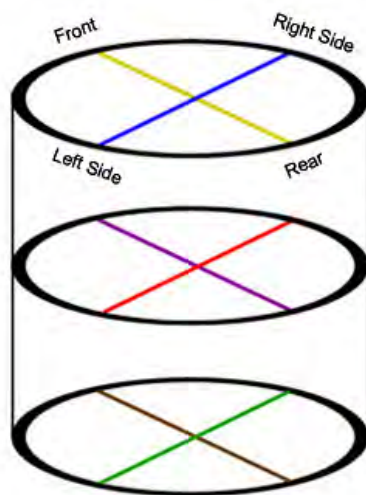

Inspect the cylinder front to back and side to side at three different height levels with a dial bore gauge.

Item		Standard (mm)
Cylinder	I.D.	52.405 ~ 52.415

Calculate the cylinder taper. The taper is the maximum difference between either yellow and brown or blue and green.

Item		Limit (mm)
Cylinder	Taper	0.05

Calculate the cylinder out of round. The out of round is greatest out of yellow, purple, or brown minus the smallest of blue, red, or green.

Item		Limit (mm)
Cylinder	Out of round	0.05

2. Engine > Cylinders and Pistons



Measure the outside diameter of the piston at 9 mm up from the bottom of the skirt at a 90° angle to the piston pin. Measure the piston with vernier calipers or a micrometer. Check the piston for wear, damage, and extreme discoloration.

Subtract the diameter of the piston from the maximum front to rear diameter measurement of the cylinder to calculate the piston-to-cylinder clearance. Replace the piston and cylinder as needed to achieve a correct piston-to-cylinder clearance.

Item	Standard (mm)
Piston-to-cylinder clearance	0.010 - 0.030



Measure the piston pin diameter with a micrometer. Measure the piston pin bore diameter with vernier calipers or a small bore gauge. Measure at three different points for each. Replace the parts if any of the specifications are not met.

Item	Standard (mm)
Piston pin hole I.D.	15.002 - 15.008
Piston pin O.D.	14.994 - 15.000
Piston-to-piston pin clearance	0.002 - 0.014

2. Engine > Cylinders and Pistons



Measure the inside diameter of the small end of the connecting rod with vernier calipers.

Item	Standard (mm)
Connecting rod small end I.D. Bore	15.016 - 15.034

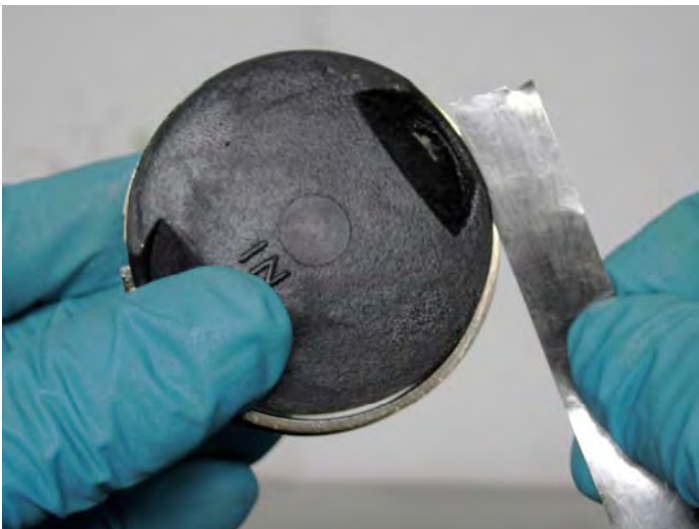

Measure the ring groove width and the ring-to-groove clearance with feeler gauges.

Item		Standard mm
Piston ring-to-groove clearance	1st	0.015 - 0.055
	2nd	0.015 - 0.055

2. Engine > Cylinders and Pistons



Insert the top ring into the cylinder. Push the top ring in the cylinder about an inch. Use the piston to push in the ring to keep it square with the cylinder.

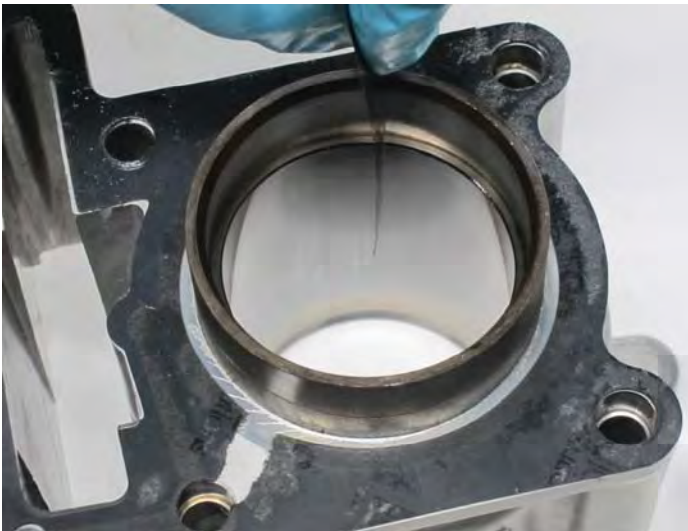

Measure the ring gap with a feeler gauge. Repeat this procedure with second ring and the oil side rails.

Item		Standard mm
Ring end gap	Top	0.10 - 0.25
	Second	0.10 - 0.25
	Oil side rail	0.2 - 0.7

2. Engine > Cylinders and Pistons



Check the oil way for clogs.

Assembly



Clean the piston ring grooves and apply fresh engine oil to the piston rings. Spread the rings the minimum amount possible to install them. Do not try and force them on the piston.

2. Engine > Cylinders and Pistons

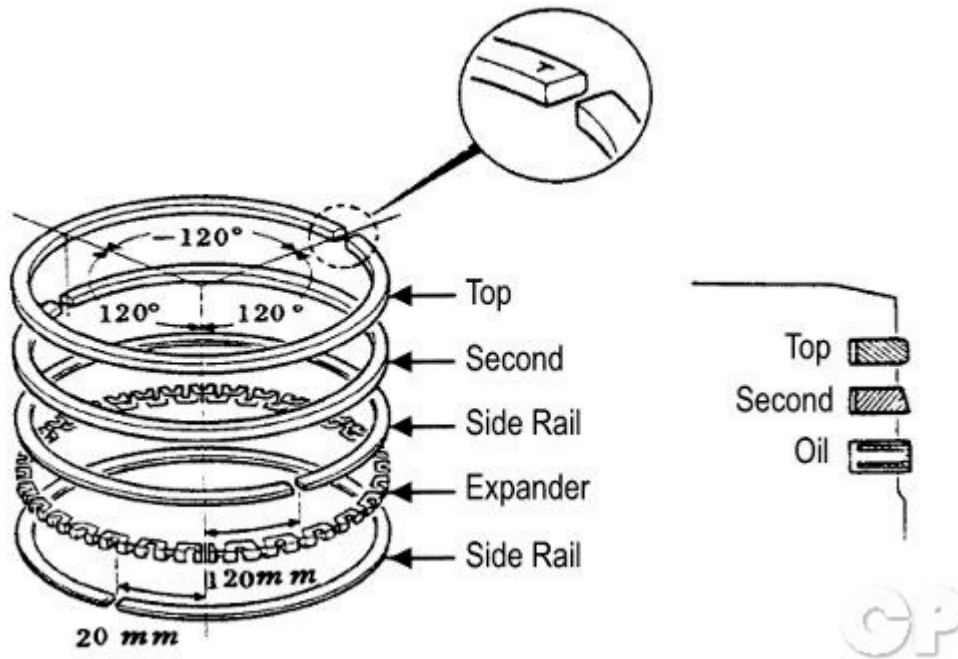

Install the top and second rings with their markings facing up. Install the rings to the piston as shown above so that no ring end gaps line up with the piston pin or perpendicular to the piston pin. The rings should turn easily on the piston without sticking or roughness.

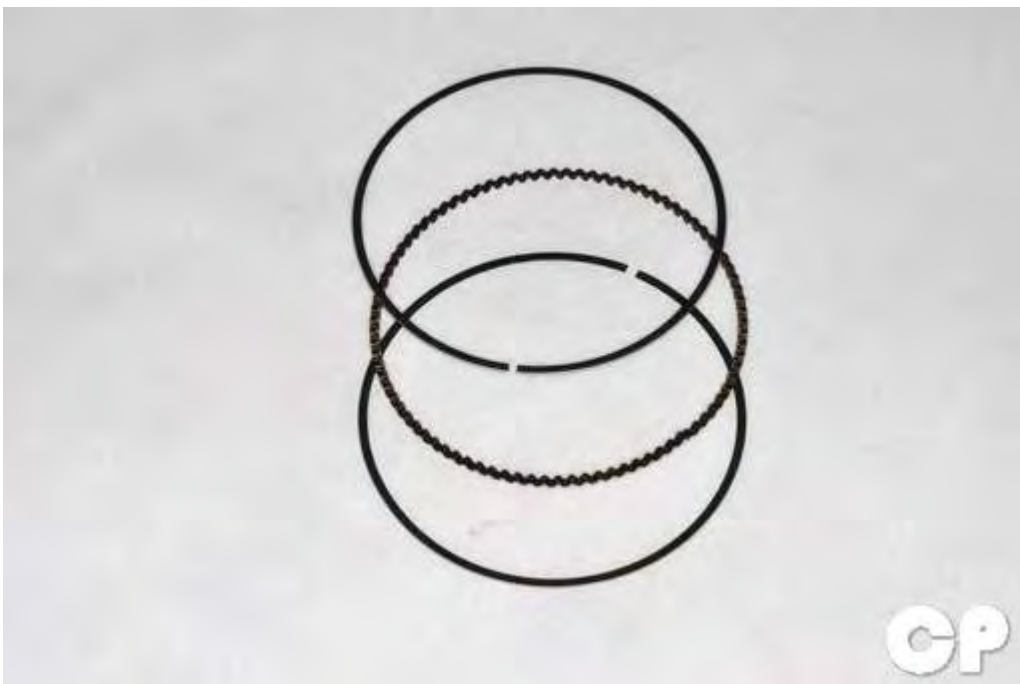

Install the oil expander ring so that the ends are not overlapping. Install the steel rails above and below the oil ring.

Lubricate the piston pin and the small end of the connecting rod with fresh engine oil.

2. Engine > Cylinders and Pistons



The "IN" mark should face the intake side (rear) of the engine.



Place the piston over the connecting rod. Insert the piston pin into the piston and rod.

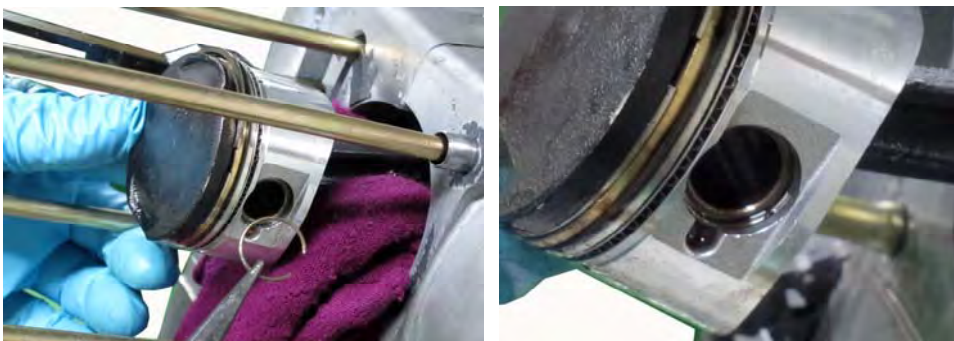

Install new piston pin clips securely into their grooves. Turn the gap in the clips away from the access gap.

2. Engine > Cylinders and Pistons



Make sure the cylinder head mating surface is clean. Install the two dowel pins as shown.

Install the new base gasket onto the crankcase.

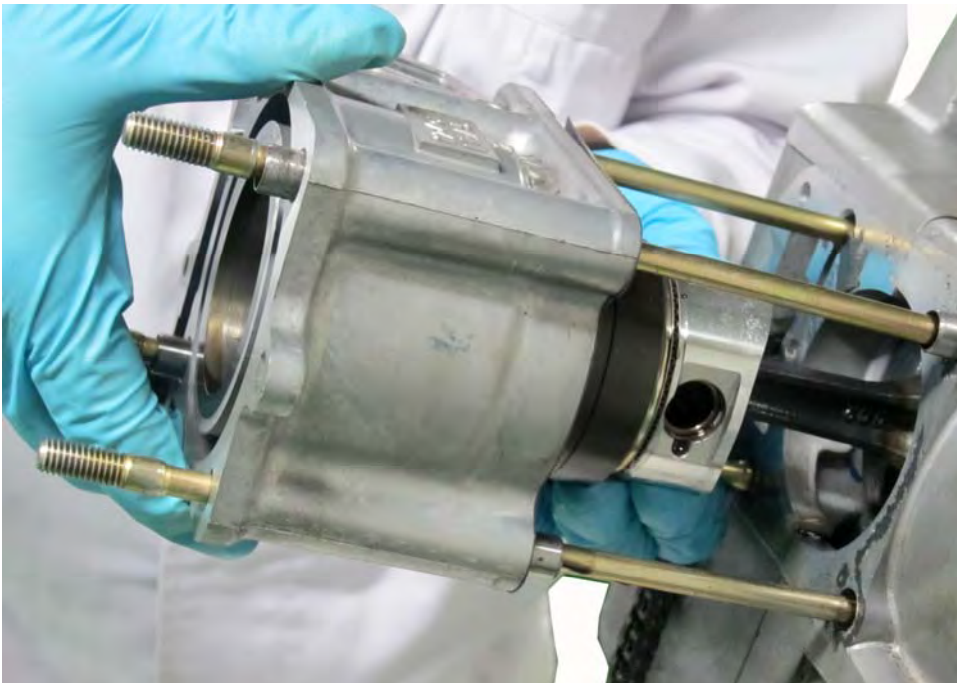

Coat the inside of the cylinder, piston rings, and piston in fresh engine oil. Lower the cylinder over the studs and guide the piston into the cylinder while you are compressing the rings with your fingers. Be careful to not damage the rings during this step. Bring the cam chain and guide through the opening.

2. Engine > Cylinders and Pistons



Thread in the two cylinder bolts on the right side of the engine.

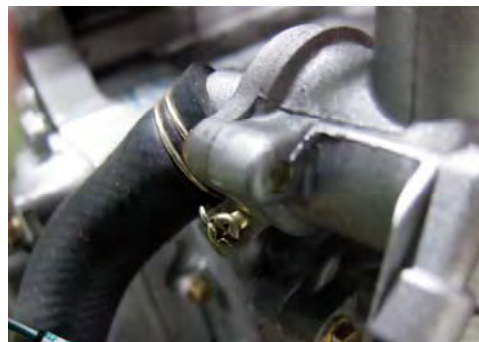

Fit the coolant hose to the cylinder. Tighten the cylinder coolant hose clamp to securely with a #2 Phillips screwdriver.

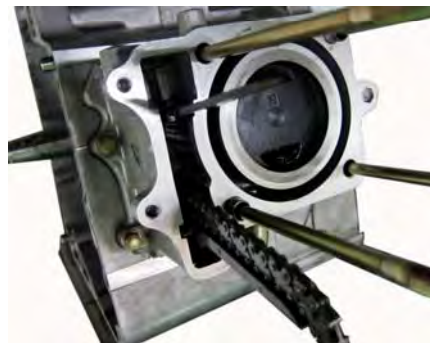
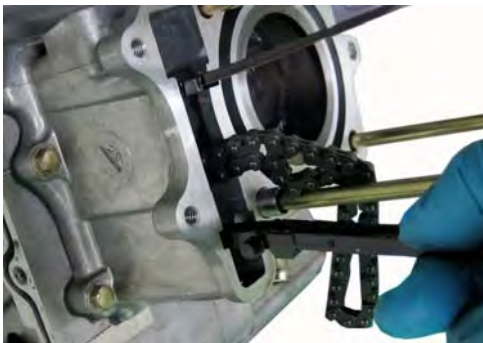

Insert the lower cam chain guide and make sure it is seated correctly.

Install the cylinder head. See the [Cylinder Head](#) topic.

Install the camshaft. See the [Camshaft](#) topic for more information.

Install the cylinder head cover. See the [Cylinder Head Cover](#) topic for more information.

Install the engine into the frame. See the [Engine Installation](#) topic for more information.

Oil Pump

SAFETY FIRST: Protective gloves and eyewear are recommended at this point.

GENERAL INSTRUCTIONS

The maintenance of lubrication system can be performed with the engine installed in the frame. Use care when removing and installing the oil pump not to allow dust and foreign matters to enter the engine and oil line.

Do not attempt to disassemble the oil pump. The oil pump must be replaced as a set when it reaches its service limit.

After the oil pump is installed, check each part for oil leaks.

TROUBLESHOOTING

Oil level too low

1. Natural oil consumption
2. Oil leaks
3. Worn or poorly installed piston rings
4. Worn valve guide or seal

Poor lubrication pressure

1. Oil level too low
2. Clogged filter or oil passages
3. Not using the specified oil

Oil Pump Removal

Drain the engine oil. See the [Engine Oil](#) topic for more information.

Remove the generator cover, flywheel, starter idle gear and starter driven gear. See the [Generator](#) topic.

2. Engine > Oil Pump

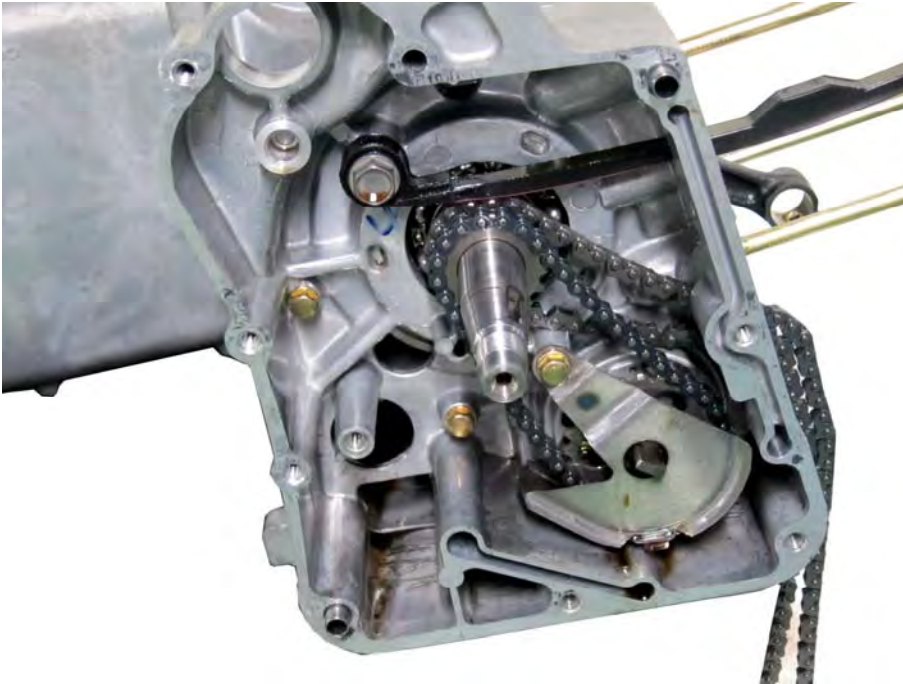

The oil pump is driven by a chain off of the crankshaft.

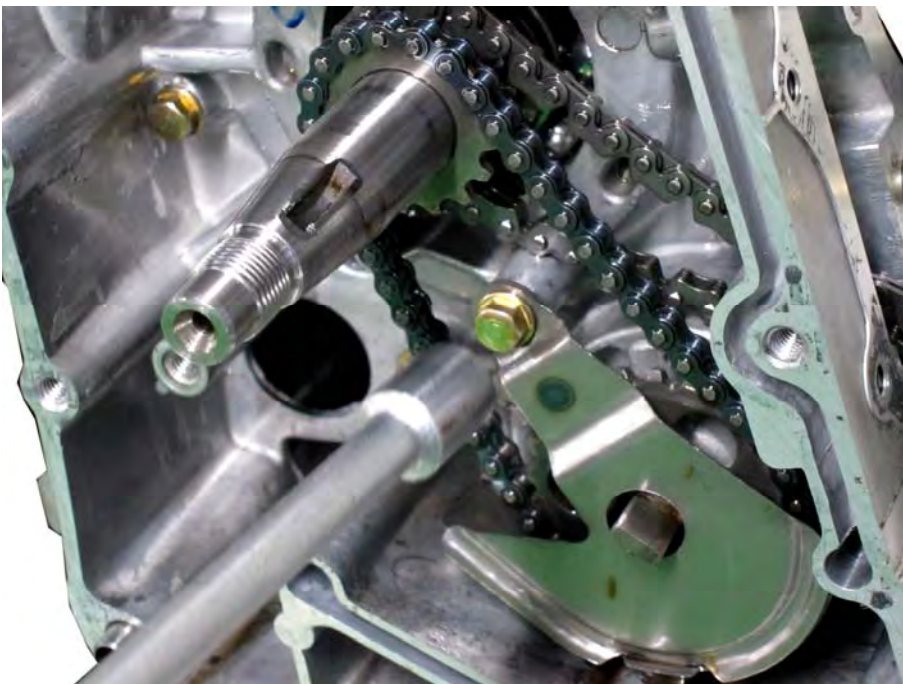

Loosen the oil pump cover bolt with an 8 mm socket.

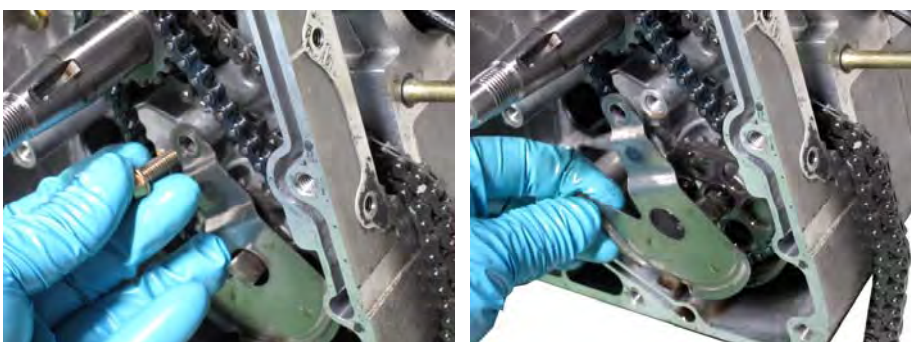

Remove the oil pump cover bolt and the oil pump cover.

2. Engine > Oil Pump

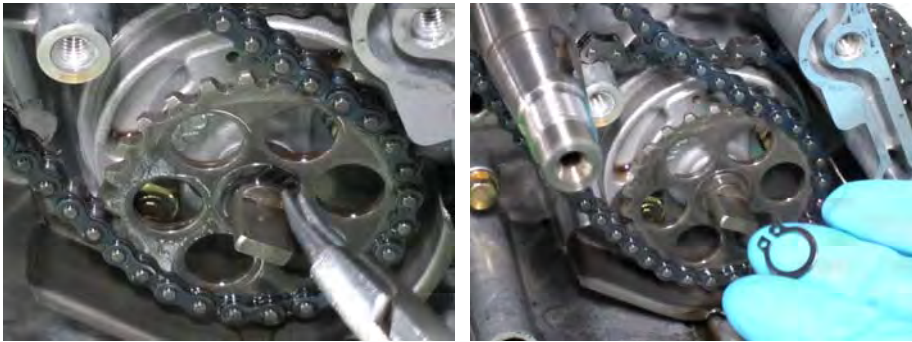

Remove the snap ring on the oil pump shaft with snap ring pliers.



Remove the oil pump drive chain and driven sprocket.



Inspect the oil pump drive chain and sprocket for signs of wear and damage. Replace the parts as needed.

2. Engine > Oil Pump

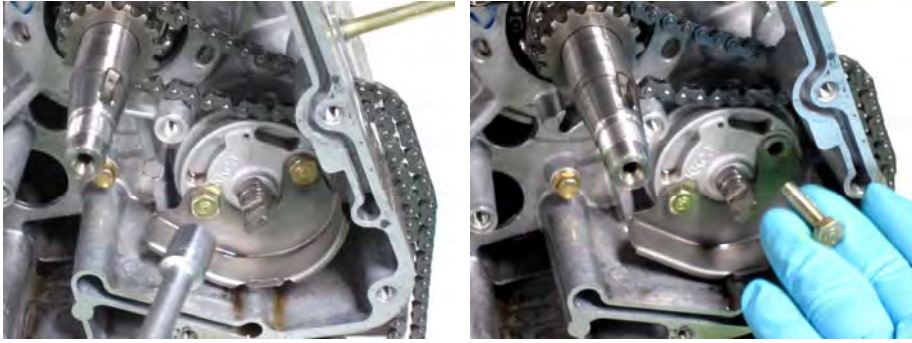

Remove the two oil pump screws with an 10 mm socket.



Remove the oil pump.



2. Engine > Oil Pump

Turn the oil pump shaft by hand and make sure it turns smoothly. If the oil pump shaft will not rotate smoothly the oil pump should be replaced with a new unit.

Oil Pump Installation



Fit the oil pump into place so that the arrow is pointing up.



Insert the two oil pump mounting screws and tighten them securely with an 10 mm socket.

2. Engine > Oil Pump



Fit the oil pump driven sprocket into the drive chain. Install the gear onto the oil pump shaft and fit the chain onto its teeth on the crankshaft.

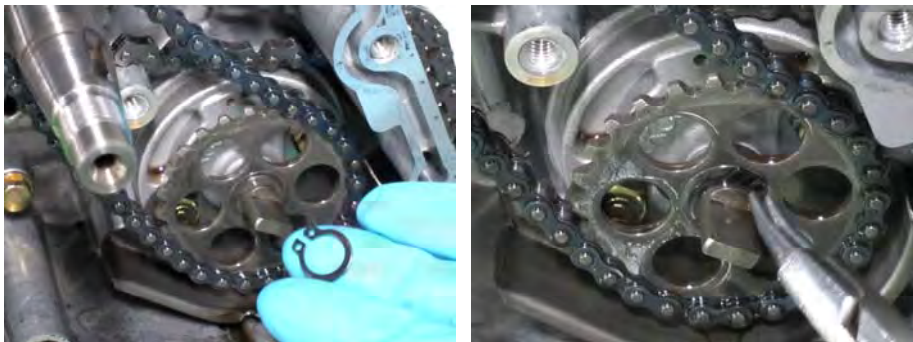

Install a new snap ring into its groove with snap ring pliers.

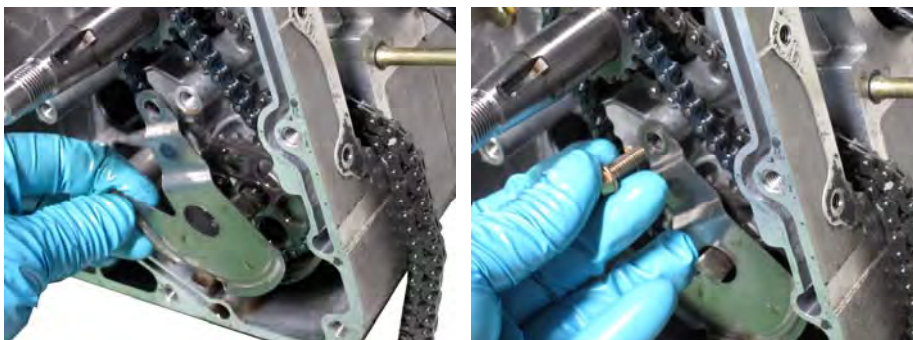

Install the oil pump cover and its two mounting bolts.

2. Engine > Oil Pump

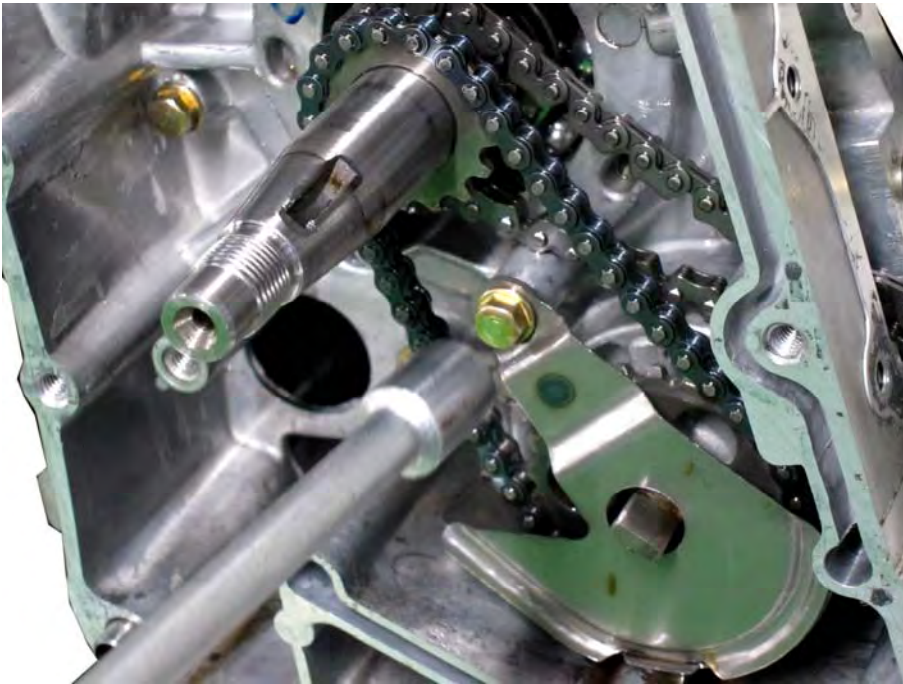

Tighten the oil pump cover bolt securely with an 8 mm socket.

Install the starter driven gear, flywheel, and the generator cover. See the [Generator](#) topic.

Fill the engine oil. See the [Engine Oil](#) topic for more information.

2. Engine > Engine Removal

Engine Removal

SAFETY FIRST: Protective gloves and eyewear are recommended at this point.

- A floor jack or other adjustable support is required to support and maneuver the engine. Be careful not to damage the scooter body, cables and wires during engine removal.
- Use shop towels to protect the scooter body during engine removal.

Place the scooter on the center stand.

Remove the following external components:

- Seat
- Luggage Box
- Center Cover
- Front Cover
- Front Lower Cover
- Foot Skirt
- Rear Carrier
- Body Cover
- Under Cover

Disconnect the cables from the battery terminals. See the Battery topic for more information.

Remove the spark plug cap. See the Spark Plug topic for more information.

Drain the coolant. See the Coolant topic for more information.

Drain the engine oil. See the Engine Oil topic for more information.

Remove the airbox. See the Airbox topic for more information.

Remove the rear brake caliper. See the Rear Brake Caliper topic for more information.

Remove the throttle body. See the Throttle Body topic for more information.

Remove the exhaust system. See the Exhaust System topic for more information.

2. Engine > Engine Removal



The regulator/rectifier is located on the left side of the vehicle.



Disconnect the generator 3-pin connector.

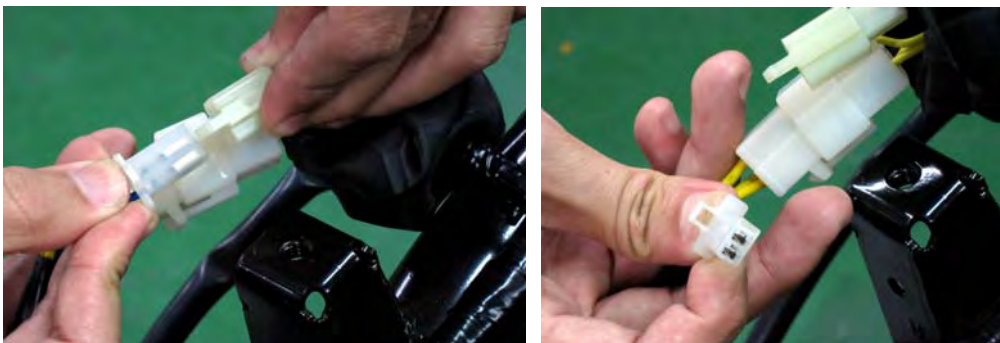

Disconnect the crank position sensor wire coupler.



Unplug the water temperature sensor.

2. Engine > Engine Removal



Unplug the thermosensor unit and thermo unit ground connectors.



Pull back the rubber starter motor lead cover.



Remove the starter motor lead nut with a #2 Phillips screwdriver. Free the cable lead from the starter motor. Thread the screw back on to keep track of it.

2. Engine > Engine Removal



Loosen the fuel hose stay bolt with an 10 mm socket. Free the fuel hose stay from the cylinder head cover.



Loosen the water pump hose clamp with a #2 Phillips screwdriver. Slide up the clamp and free the coolant hose from the water pump. Allow any remaining coolant to drain into a suitable container.



Loosen the thermostat hose clamp with a #2 Phillips screwdriver. Slide up the clamp and free the coolant hose from the thermostat. Allow any remaining coolant to drain into a suitable container.



Squeeze the air bleed hose clamp with needle nose pliers and slide back the clamp. Free the air bleed hose from the thermostat.

2. Engine > Engine Removal



Loosen the main engine ground bolt with an 8 mm socket. Remove the bolt and free the engine ground from the right side of the engine.



Free the starter motor lead from the stay.



Support the engine with a suitable jack or stand.

Remove the rear shock absorbers. See the [ShockAbsorbers](#) topic for more information.

2. Engine > Engine Removal



Loosen the engine mounting bracket damper nut with a 17 mm socket. Remove the nut and washer.



Hold the engine mounting bolts with a 14 mm wrench and loosen the nuts with a 19 mm socket.



Remove the engine mounting nuts and bolts from both sides.



Loosen the engine mounting bracket damper bolt and nut with a 19 mm wrench for the nut and a 14 mm socket for the bolt.

2. Engine > Engine Removal



Remove the engine mounting bracket damper bolt and nut.



Remove the engine mounting bracket.



Remove the engine mounting bracket damper assembly.

Carefully move the engine back and separate it from the chassis.

To install the engine see the [Engine Installation](#) topic.

2. Engine > Engine Installation

Engine Installation

SAFETY FIRST: Protective gloves and eyewear are recommended at this point.

Before the engine is returned to the install the rear wheel. See the [Rear Wheel](#) topic for more information.

Set the chassis on its center stand. Use a jack to support the engine. Guide the engine into the back of the frame.

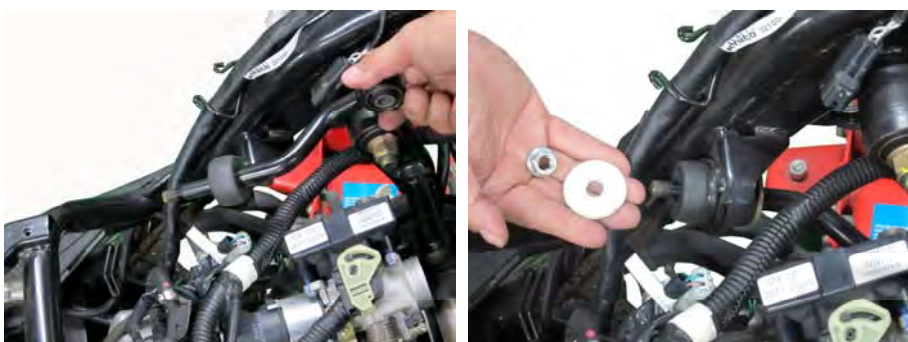

Fit the engine mounting bracket and damper assembly into place.

2. Engine > Engine Installation



Install the two engine mounting bracket to frame mounting bolts and nuts. Insert the bolts from the outside of the frame.



Insert the engine mounting bracket and damper bolt from the right side. Thread on the nut.

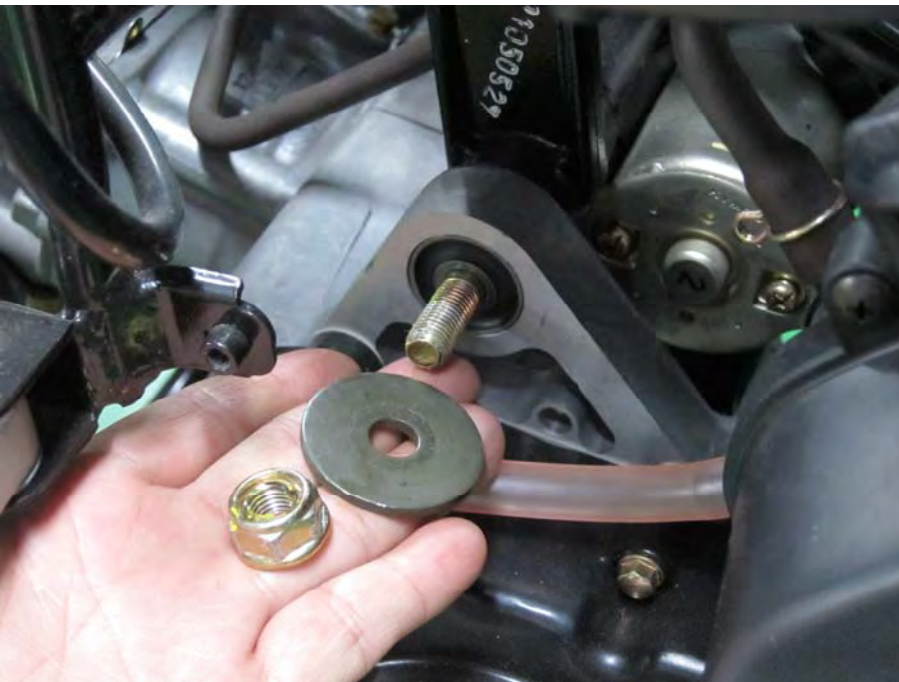

Install the engine mounting bracket damper washer and nut.

2. Engine > Engine Installation



Hold the engine mounting bolts with a 14 mm wrench and torque the nuts to specification with a 17 mm socket.

Item	Qty	Thread size (mm)	Torque		Remarks
			kgf-m	lb-ft	
Engine hanger: Frame side	2	14	6.0-7.0	43.20-50.40	U-nut



Tighten the engine mounting bracket damper bolt and nut with a 19 mm wrench for the nut and a 17 mm socket for the bolt.

Item	Qty	Thread size (mm)	Torque		Remarks
			kgf-m	lb-ft	
Engine hanger: Engine side	2	10	4.5-5.5	32.40-39.60	U-nut

2. Engine > Engine Installation



Tighten the damper nut securely with a 14 mm socket.

Install the rear shock absorbers. See the [Shock Absorbers](#) topic for more information.



Route the starter motor lead to the starter motor and secure it in the stay.



Fit the starter motor cable lead onto the terminal and thread on the nut. Tighten the starter motor lead nut securely with a #2 Phillips screwdriver.

2. Engine > Engine Installation



Fit the rubber starter motor lead cover into place.



Install the main engine ground to the right side of the engine. Tighten the main engine ground bolt securely with an 8 mm socket.

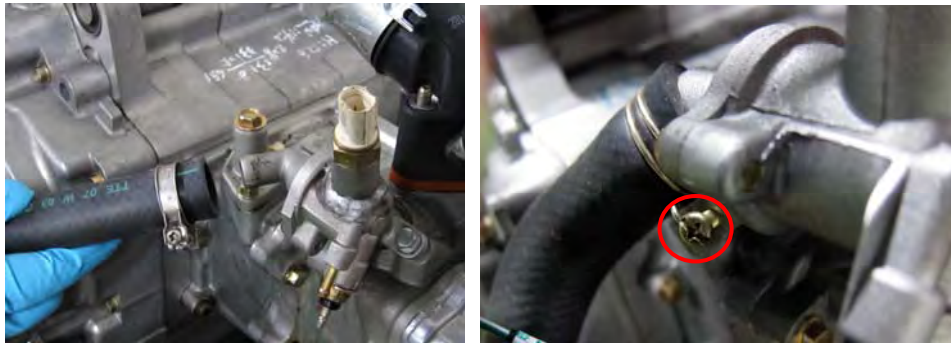

Install air bleed hose and secure it with the clamp.

2. Engine > Engine Installation

Connect the coolant hose to the thermostat. Move the clamp into place and tighten it securely with a #2 Phillips screwdriver.

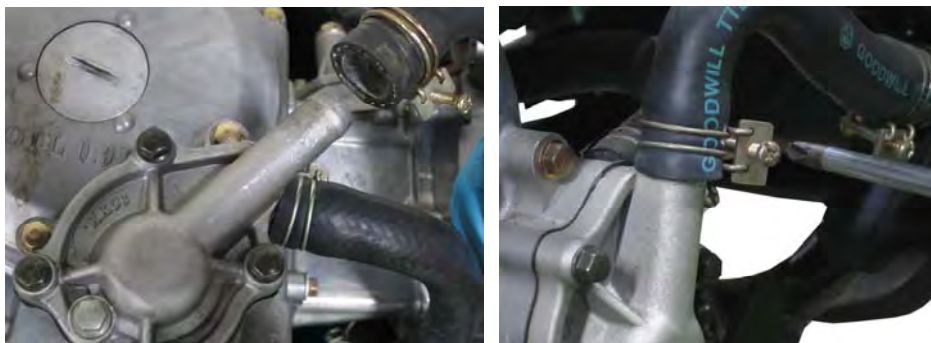

Connect the coolant hose to the water pump. Move the clamp into place and tighten it securely with a #2 Phillips screwdriver.



Fit the fuel stay into place. Tighten the stay bolt securely with an 10 mm socket.



Plug in the thermosensor unit and ground connectors.

2. Engine > Engine Installation



Plug in the water temperature sensor connector.



Connect the generator 3-pin connector for regulator/rectifier.

2. Quick Reference > Specifications

KYMCO G-Dink 125i Specifications

General Information

Engine Head

Item	Standard (mm)	
Valve clearance (cold)	IN	0.10
	EX	0.10
Cylinder head compression pressure	15 kg/cm ² , 214.5 psi	
Camshaft cam height	IN	30.8763
	EX	30.4081
Valve rocker arm I.D.	IN	10 — 10.018
	EX	10 — 10.018
Valve rocker arm shaft O.D.	IN	9.972 — 9.987
	EX	9.972 — 9.987
Valve stem O.D.	IN	4.99 — 4.975
	EX	4.97 — 4.955
Valve stem-to-guide clearance	IN	0.01 — 0.037
	EX	0.03 — 0.057
Valve seat width	IN	1.2
	EX	1.2

Engine

Item	Standard (mm)		
Cylinder	I.D.	52.4~52.41 (2.096~2.0964)	
Piston, piston ring	Ring-to-groove clearance	Top	0.015 — 0.05
		Second	0.015 — 0.05
	Ring end gap	Top	0.15 — 0.3
		Second	0.15 — 0.3
		Oil side rail	0.2 — 0.9
	Piston O.D.	52.37 — 52.39	
	Piston O.D. measuring position	9 mm (0.36 in) from bottom of skirt	
	Piston-to-cylinder clearance	0.01 — 0.04	
Piston pin hole I.D.	15.002 — 15.008		
Piston pin O.D	14.994 — 15		
Piston-to-piston	0.002 — 0.014		
Connecting rod	15.016 — 15.034		

2. Quick Reference > Specifications

Crankshaft

Item	Standard (mm)
Connecting rod big end side clearance	0.15 — 0.35
Connecting rod big end radial clearance	0 — 0.008

CVT

Item	Standard (mm)
Movable drive face bushing I.D.	33 — 33.025
Drive face collar O.D.	32.006 — 32.009
Drive belt width	19
Clutch lining thickness	3.963 — 4.037
Clutch outer I.D.	130 — 130.2
Driven face spring free length	88.3
Driven face O.D.	33.965 — 33.985
Movable driven face I.D.	34 — 34.025
Weight roller O.D.	16.99 — 17

Cooling System

Radiator cap relief pressure	0.9 ± 0.15 kg/cm ² (12.8 ± 2.1 psi)	
Thermostat temperature	Begins to open	71 °C
	Full-open	80 °C
	Valve lift	3.5 - 4.5 mm
Coolant capacity	Total 1300cc	Radiator: 1000±50 cc Reserve tank: 300 cc

2. Quick Reference > Specifications

COOLANT MIXTURE (WITH ANTI-RUST AND ANTI-FREEZING EFFECTS)			
Freezing Point	Mixing Rate	Coolant Concentrate	Distilled Water
-9°C	20%	260 cc	1040 cc
-15°C	30%	390 cc	910 cc
-25°C	40%	520 cc	780 cc
-37°C	50%	650 cc	650 cc
-44.5°C	55%	715 cc	585 cc

COOLANT GRAVITY CHART

COOLANT GRAVITY CHART						
Temp. C° Coolant concentration	0	5	10	15	20	25
5%	1.009	1.009	1.008	1.008	1.007	1.006
10%	1.018	1.107	1.017	1.016	1.015	1.014
15%	1.028	1.027	1.026	1.025	1.024	1.022
20%	1.036	1.035	1.034	1.033	1.031	1.029
25%	1.045	1.044	1.043	1.042	1.040	1.038
30%	1.053	1.051	1.051	1.049	1.047	1.045
35%	1.063	1.062	1.060	1.058	1.056	1.054
40%	1.072	1.070	1.068	1.066	1.064	1.062
45%	1.080	1.078	1.076	1.074	1.072	1.069
50%	1.086	1.084	1.082	1.080	1.077	1.074
55%	1.095	1.093	1.091	1.088	1.085	1.082
60%	1.100	1.098	1.095	1.092	1.089	1.086

Temp. C° Coolant concentration	30	35	40	45	50
5%	1.005	1.003	1.001	0.009	0.997
10%	0.013	1.011	1.009	1.007	1.005
15%	1.020	1.018	1.016	1.014	1.012
20%	1.027	1.025	1.023	1.021	1.019
25%	1.036	1.034	1.031	1.028	1.025
30%	1.043	1.041	1.038	1.035	1.032
35%	1.052	1.049	1.046	1.043	1.040
40%	1.059	1.056	1.053	1.050	1.047
45%	1.056	1.063	1.062	1.057	1.054
50%	1.071	1.068	1.065	1.062	1.059
55%	1.079	1.076	1.073	1.070	1.067
60%	1.083	1.080	1.077	1.074	1.071

CVT Continuously Variable Transmission

This chapter covers the location and servicing of the CVT components for the KYMCO Downtown 300i.

• <u>Belt Case</u>	2-7
• <u>CVT Removal</u>	8-23
• <u>CVT Installation</u>	24

GENERAL INSTRUCTIONS

- The drive pulley, clutch and driven pulley can be serviced with the engine installed.
- Avoid getting grease and oil on the drive belt and pulley faces. Remove any oil or grease from them to minimize the slipping of drive belt and drive pulley.

TROUBLESHOOTING

Engine starts but motorcycle won't move

- Worn drive belt
- Broken ramp plate
- Worn or damaged clutch lining
- Broken driven face spring

Engine stalls or motorcycle creeps

- Broken clutch weight spring

Lack of power

- Worn drive belt
- Weak driven face spring
- Worn weight roller
- Faulty driven face

Belt Case

SAFETY FIRST: Protective gloves and eyewear are recommended at this point.

Removal

Remove the following components -

- Seat
- Luggage Box
- Center Cover
- Rear Carrier
- Body Cover
- Front Cover
- Front Lower Cover
- Foot Skirt

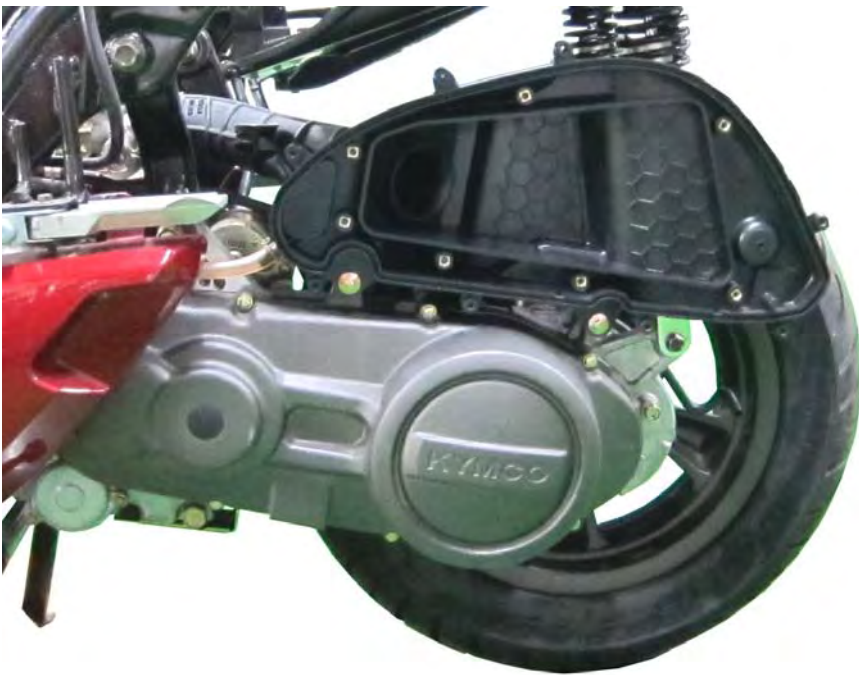

Disconnect the drain hose from the plastic belt case cover.

3. CVT Transmission > Belt Case

Remove the belt case plastic cover bolts with an 8 mm socket.



Remove the belt case cover bolts with an 8 mm socket.

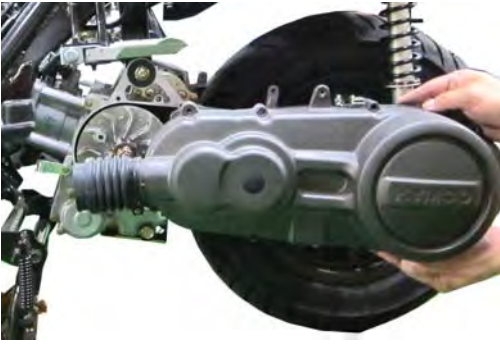

Use the pry points to free the belt case cover.

3. CVT Transmission > Belt Case

Remove the belt case cover and gasket.



Remove the two dowel pins.

Inspection

Inspect the drive belt for cracks or excessive wear.

Installation



Install the two dowel pins into the belt case.

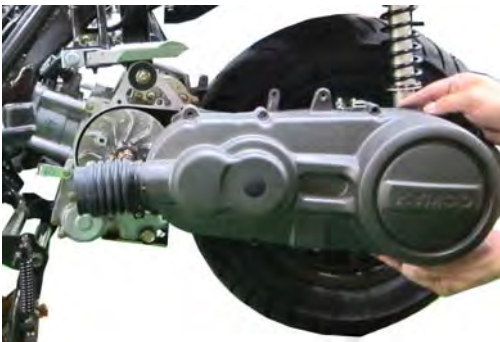

Install a new gasket with the belt case cover.

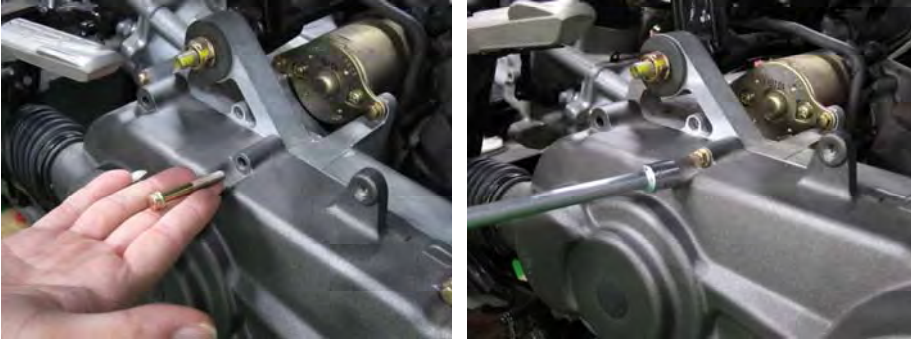

3. CVT Transmission > Belt Case

Install the belt case cover bolts and tighten them securely with an 8 mm socket.



Insert the plastic cover bolts and tighten them securely with an 8 mm socket.

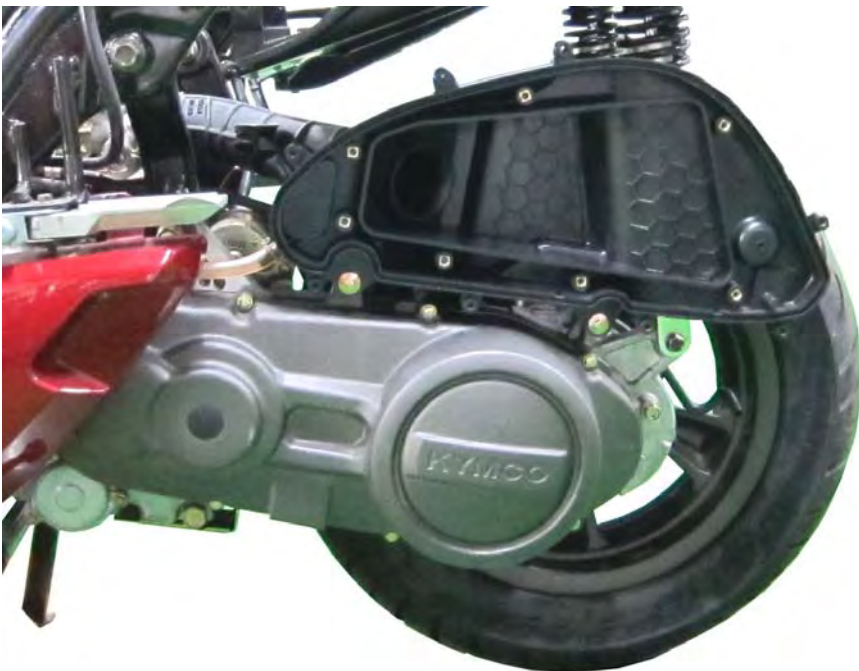

3. CVT Transmission > Belt Case

Fit the drain hose to the plastic belt case cover as shown.

Install the following components -

- Foot Skirt
- Front Lower Cover
- Front Cover
- Body Cover
- Rear Carrier
- Center Cover
- Luggage Box
- Seat

CVT Removal

SAFETY FIRST: Protective gloves and eyewear are recommended at this point.

Remove the belt case. See the [Belt Case](#) topic for more information.

Pulleys and Belt



Hold the drive pulley with a universal holder tool and loosen the nut with a 17 mm socket.

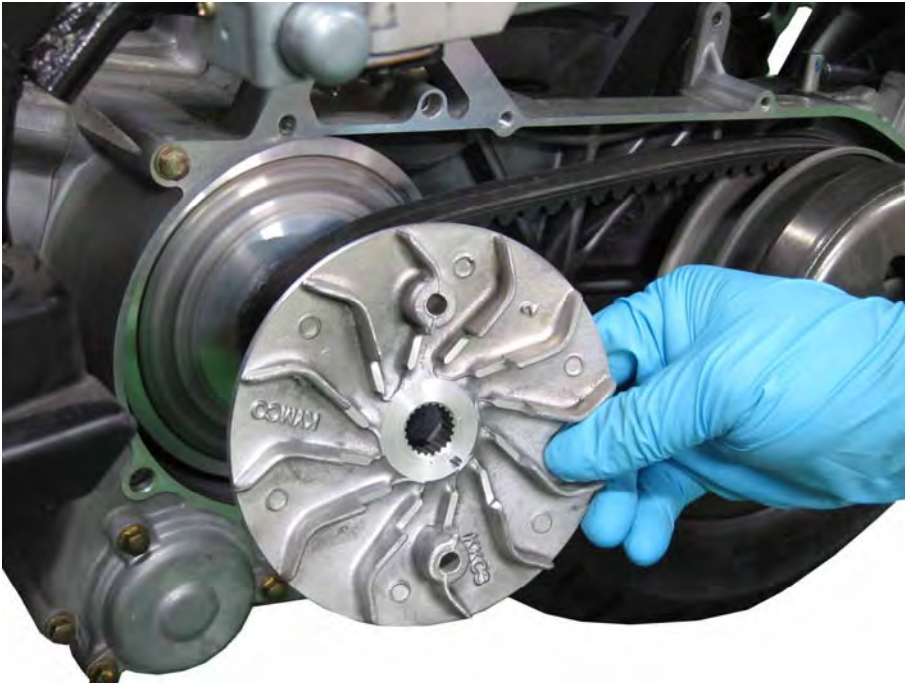

Remove the drive pulley nut and washer from the crankshaft.

3. CVT Transmission > CVT Removal

Remove the left face of the drive pulley.



Loosen the driven pulley nut with a 17 mm socket.

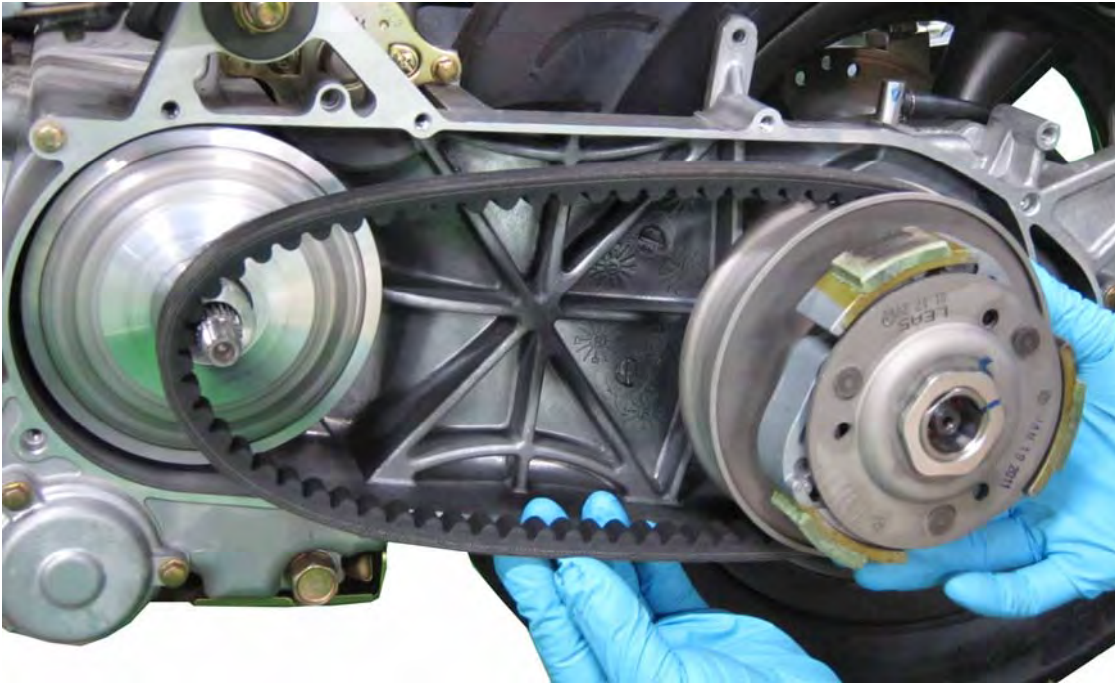

Remove the driven pulley nut.

3. CVT Transmission > CVT Removal

Slide the driven pulley off of the shaft.



Remove the belt from the driven pulley.

3. CVT Transmission > CVT Removal

Inspect the drive belt for cracks or excessive wear.



Remove the right (movable) face of the drive pulley from the crankshaft. Slide the bushing out of the movable drive face.

Drive Pulley Disassembly

Inspect the faces of the drive pulley. Clean away any grease from the faces.

3. CVT Transmission > CVT Removal



Lift the ramp plate out of the back of the left drive pulley face.



Remove the rubber damper pieces from the ramp.



There are six weight rollers in the back of the right face of the drive pulley.



Remove the rollers and check them for excessive or uneven wear. Measure the outside diameter of the rollers. Replace the weight rollers as needed.

Item	Standard (mm)	Service Limit (mm)
Weight roller O.D (Drive Pulley)	15.9 ± 0.3 g	15.0



Inspect the movable drive face and bushing for wear and damage. Replace the parts as needed.

Clutch Disassembly



Lift the clutch outer off of the centrifugal clutch.



Inspect the inside of the clutch outer for excessive wear and damage. Measure the inside diameter of the clutch outer and replace the part as needed.

Item	Standard (mm)	Service Limit (mm)
Clutch outer I.D.	130.0 – 130.2	130.2

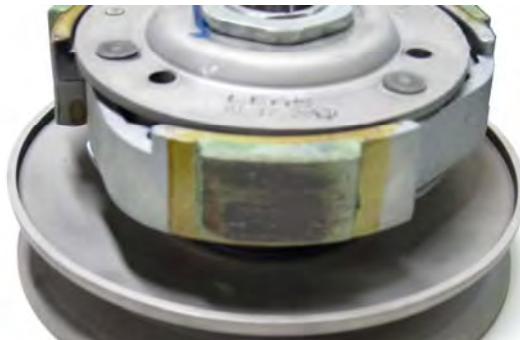

Inspect the clutch shoe lining thickness. Replace the shoes if the wear is below the service limit.

Item	Standard (mm)	Service Limit (mm)
Clutch lining thickness	4.0	2.0

To disassemble the clutch and driven pulley set the clutch fitting tool to onto the clutch.

ITEM	TOOL NO.	DESCRIPTION
Clutch spring compressor	A120E00027	Clutch disassembly

3. CVT Transmission > CVT Removal

Fit the clutch and fitting tool into the clutch spring compressor tool.



Use the clutch spring compressor tool to compress the spring in the driven pulley assembly.

Loosen the clutch drive plate nut with the special socket that comes with the fitting tool.



Remove the clutch drive plate nut.

3. CVT Transmission > CVT Removal

Inspect the left side bearing by turning it with a finger. If the bearing is rough turning or noisy it should be replaced.

Remove the clutch spring compressor tool. Lift off the centrifugal clutch.



Remove the collars and spring.

3. CVT Transmission > CVT Removal



Measure the free length of the clutch spring. Replace the spring if the measurement fails to meet the service limit.



Remove the three circlips from the clutch pivot pins with a small flat blade screwdriver.

3. CVT Transmission > CVT Removal

Lift off the plate.



Slide the clutch shoes off of the pivots on the drive plate.



Inspect the clutch shoe bumpers and replace them as needed.

3. CVT Transmission > CVT Removal**Driven Pulley Disassembly**

Remove the clutch as shown above.



Remove the four guide rollers with guide roller pins.



Separate the left and right faces of the driven pulley.

3. CVT Transmission > CVT Removal

Inspect the faces of the driven pulley. Clean away any grease from the faces where the belt rides.



Remove the seals from the left face of the driven pulley.



Drive in the new seals with a suitable driver with the same outside diameter as the seal.

3. CVT Transmission > CVT Removal

Remove the O-rings on the left face.

Clean the left face and roller pins with a high flash point solvent and compressed air.

NOTE: Always wear safety glasses when using compressed air and never point it directly at yourself or anyone else.

Bearing Replacement

Inspect the bearings in the right face of the driven pulley.

3. CVT Transmission > CVT Removal



Remove the needle bearing with a suitable puller.



Remove the collar, snap ring, and bearing from the right face of the driven pulley.

Clean the right face with a high flash point solvent and compressed air.

NOTE: Always wear safety glasses when using compressed air and never point it directly at yourself or anyone else.

3. CVT Transmission > CVT Removal

Drive in the new bearing so the sealed side face out towards the clutch. Install the snap ring into the groove. Install the collar and drive in the new needle bearing so that its markings face out. Drive in the bearings with a suitable driver with the same outside diameter as the bearing.



Lubricate the bearings in the right face of the driven pulley with grease.

CVT Installation

SAFETY FIRST: Protective gloves and eyewear are recommended at this point.

Driven Pulley



Lubricate the bearings in the right face of the driven pulley with grease.



Drive in the new seals with a suitable driver with the same outside diameter as the seal.

4. Cooling System

Cooling System

This chapter covers the location and servicing of the cooling system components for the **KYMCO G-Dink 125i**.

• <u>Coolant</u>	2-8
• <u>Radiator</u>	9-22
• <u>Radiator cover</u>	23-24
• <u>Thermostat</u>	25-33
• <u>Water Pump</u>	34-42

GENERAL INSTRUCTIONS

- The water pump must be serviced after removing the engine. Other cooling system service can be done with the engine installed in the frame.
- The engine must be cool before servicing the cooling system. When the coolant temperature is over 100, never remove the radiator cap to release the pressure because the boiling coolant may cause danger.
- Avoid spilling coolant on painted surfaces because the coolant will corrode the painted surfaces. Wash off any spilled coolant with fresh water as soon as possible.
- After servicing the system, check for leaks with a cooling system tester.

TROUBLESHOOTING

Engine temperature too high

- Faulty temperature gauge or sensor
- Faulty radiator cap
- Faulty thermostat
- Insufficient coolant
- Passages blocked in hoses or water jacket
- Clogged radiator fins
- Passages blocked in radiator
- Faulty water pump

Temperature gauge shows the wrong temperature

- Faulty temperature gauge or sensor
- Faulty thermostat

Coolant leaks

- Faulty pump mechanical (water) seal
- Deteriorated O-rings
- Damaged or deteriorated water hoses

4. Cooling System > Coolant

Coolant

SAFETY FIRST: Protective gloves and eyewear are recommended at this point.

Warning: Allow the engine sufficient time to cool before handling or working on the cooling system components.

To check the coolant level see the [Coolant Level Check](#) topic for more information.

Draining

SAFETY FIRST: Antifreeze is highly toxic and can kill pets and animals if drank. Do not leave coolant where animals (including children!) can get to it. Remove the windshield. See the [Windshield](#) topic for more information.



Remove the radiator coolant panel screw with a #2 Phillips screwdriver.



Remove the panel to access the radiator cap.

4. Cooling System > Coolant



Remove the radiator cap in two stages. Allow any built up pressure to vent and then open the cap all the way and remove it.

The water pump is located on the right side of the engine. Ready a drain pan under the water pump drain bolt.

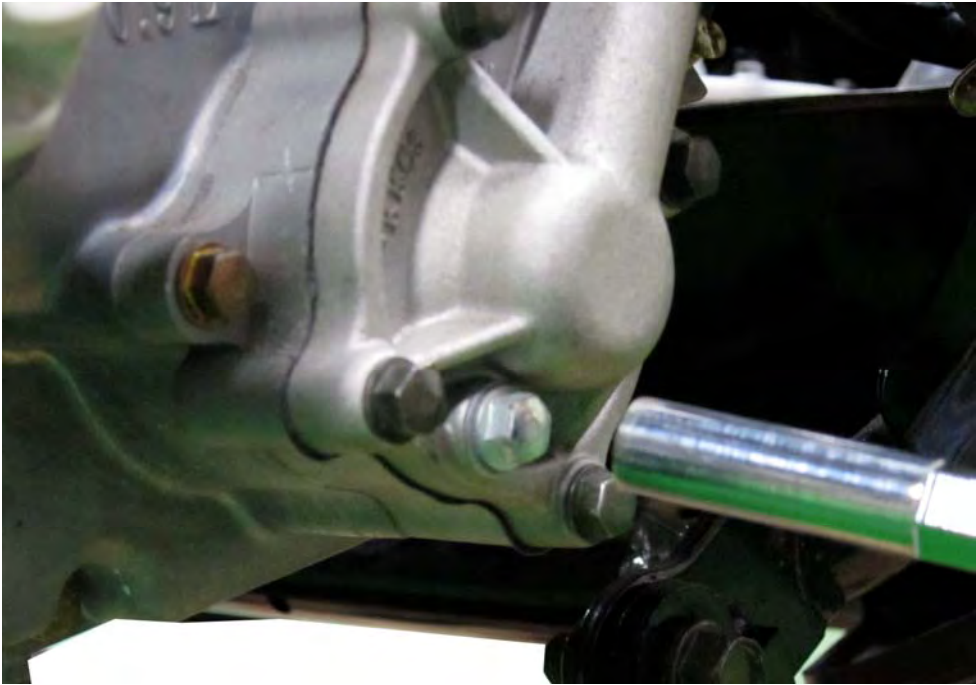

Loosen the coolant drain bolt with an 8 mm socket.

4. Cooling System > Coolant



Remove the drain bolt and sealing washer and allow the coolant to drain into a suitable container.



The coolant reserve tank is under the legshield.
Remove the engine coolant lid screw with a #2 Phillips.
Remove the engine coolant lid.



Open the coolant reserve tank lid. Siphon the coolant out of the reserve tank with an appropriate suction device. If a suction device is unavailable remove the reserve tank and pour it out. See the [Radiator](#) topic for more information.

When the coolant has finished draining return the drain bolt to the water pump with a new sealing washer.

4. Cooling System > Coolant

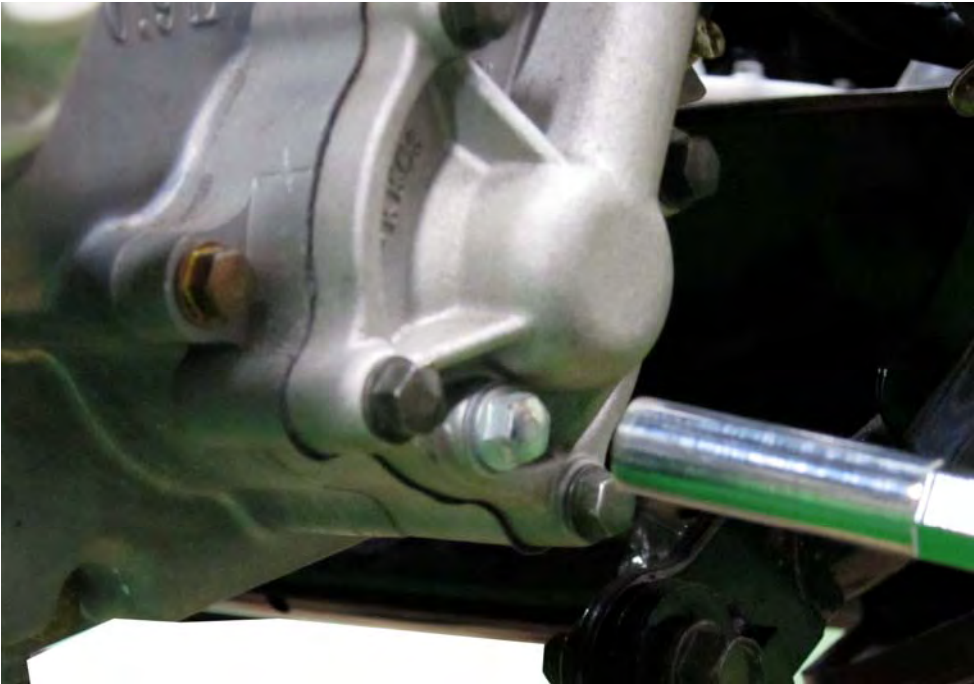

Tighten the drain bolt securely with an 8 mm socket.

Filling

Coolant capacity	Total 1300 cc	Radiator: 1000±50 cc Reserve tank: 300 cc
------------------	---------------	--

- Use coolant of specified mixing rate. (The mixing rate of 520cc coolant concentrate is 40% + 780cc distilled water is 60%.)
- Do not mix coolant concentrate of different brands.
- Do not drink the coolant, which is poisonous.
- The freezing point of coolant mixture shall be 5 °C lower than the freezing point of the riding area.

COOLANT MIXTURE (WITH ANTI-RUST AND ANTI-FREEZING EFFECTS)			
Freezing Point	Mixing Rate	Coolant Concentrate	Distilled Water
-25°C	40%	520 cc	780 cc

4. Cooling System > Coolant



Fill the cooling system with a mix of distilled water and Coolant Concentrate. Continue filling until the coolant until it reaches the bottom of the filler neck as shown.



Add coolant to the reserve tank until it reaches the upper level mark.

Gently rock the vehicle side-to-side to release any air bubbles trapped in the cooling system.

Place the vehicle on its center stand and start the engine. Let it run for several minutes. This will purge any air out of the cooling system.
Check for coolant leaks

4. Cooling System > Coolant

When the air bubbles stop coming up turn off the engine and recheck the coolant level, add coolant if necessary. Check the reserve tank and add coolant if needed.



Wet the seal of the radiator cap and install.



Install the coolant reserve tank lid.



Install the engine coolant reserve tank cover. Insert the screw and tighten its securely with a #2 Phillips.

4. Cooling System > Coolant



Install the radiator cap access panel.



Install the radiator coolant panel screws and tighten securely with a #2 Phillips screwdriver.

Install the windshield. See the [Windshield](#) topic for more information.

Radiator

SAFETY FIRST: Protective gloves and eyewear are recommended at this point.

Warning: Allow the engine sufficient time to cool before handling or working on the cooling system components.

Pressure Testing

Remove the windshield. See the [Windshield](#) topic for more information.



Remove the radiator coolant panel screw with a #2 Phillips screwdriver.



Remove the panel to access the radiator cap.



Remove the radiator cap in two stages. Allow any built up pressure to vent and then open the cap all the way and remove it.

When checking the cooling system for leaks you will need a pressure tester. Remove the radiator cap, wet the tester seal, and install the end of the pressure tester onto the filler neck. Pump the tester up until the gauge reads 0.84 kg/cm² or 12 psi. The cooling system should hold this pressure for at least 6 seconds. If it does not you will need to inspect the entire system for leaks. Do not pressurize the cooling system more than 1.05 kg/cm² or 14.9 psi.

CAUTION: Never remove the radiator cap when the engine is hot.

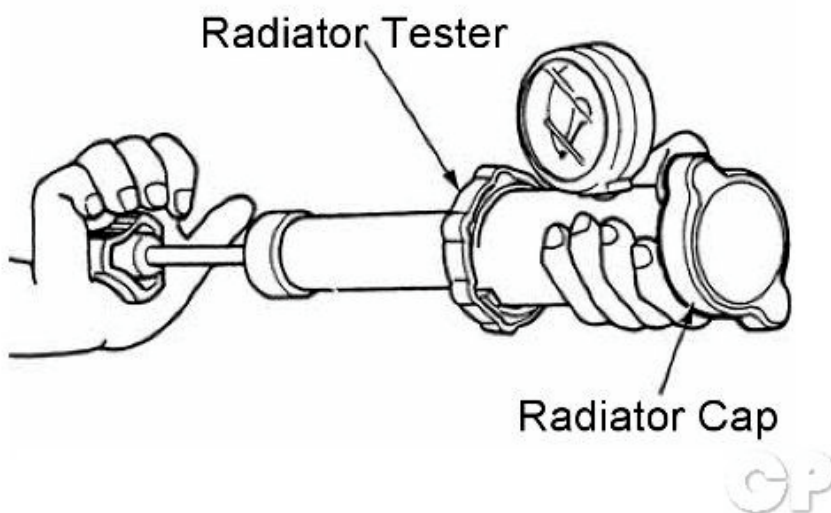

Wet the seal on the radiator cap and install it to the pressure tester. Replace the cap if it does not relieve the pressure as specified.

Radiator cap relief pressure	0.9 ± 0.15 kg/cm ² (12.8 ± 2.1 psi)
------------------------------	--

4. Cooling System > Radiator

Removal

Remove the front cover. See the [FrontCover](#) topic for information.

Remove the right and left front lower covers. See the [FrontLowerCover](#) topic for information.

Remove the radiator cover. See the [RadiatorCover](#) topic for more information.

Drain the coolant. See the [Coolant](#) topic for more information.



Unplug the thermostatic switch connectors.



Unplug the cooling fan motor connector.



There are three coolant hoses that connect to the radiator. The top right hose runs to the filler neck and cap. The top left hose runs to the thermostat on the cylinder head. The bottom right hose runs to the water pump.

4. Cooling System > Radiator



Loosen the coolant hose clamps with a #2 Phillips screwdriver.



Free the filler neck coolant hose from the stay and remove it from the radiator.



Remove the water pump and thermostat hoses in the same manner.



Remove the two radiator mounting bolts with a 10 mm socket.



Slide the radiator to the left and free the grommet from the post above the right side of the radiator.

4. Cooling System > Radiator



Remove the radiator from the frame.

Coolant Reserve Tank



The coolant reserve tank is mounting to the frame with a bolt. There are two hoses that connect to the reserve tank. The top hose is a dump hose that hangs over the other side. The bottom hose is the overflow hose that runs to the filler neck.



Position a suitable container below the reserve tank.



Pull back the clamp and free the overflow hose from the bottom of the reserve tank. Allow the coolant in the reserve tank to drain into the container.

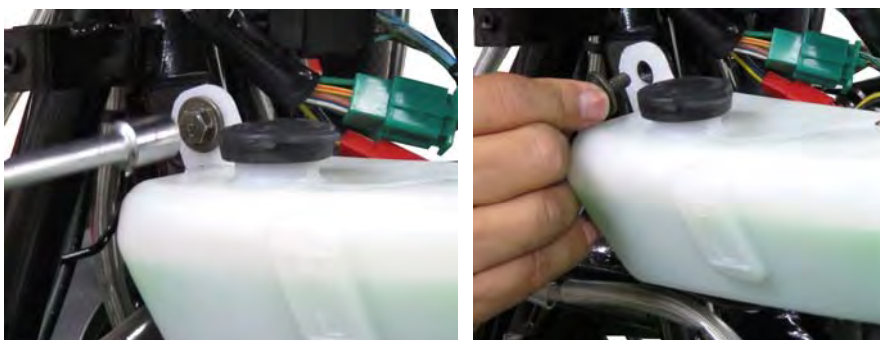

Remove the reserve tank mounting bolt with a 10 mm socket.

4. Cooling System > Radiator

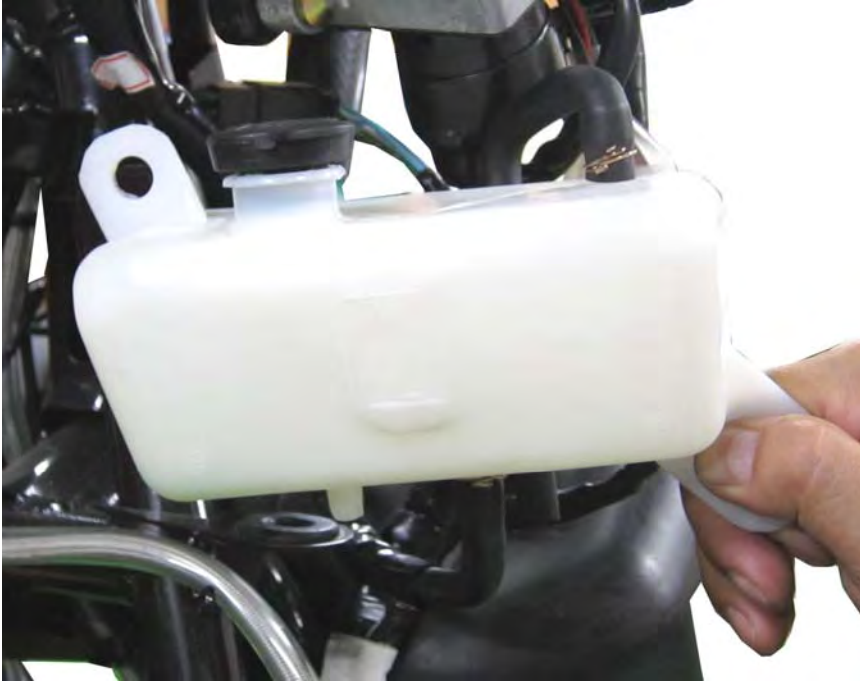

Remove the reserve tank from the frame.

Inspection

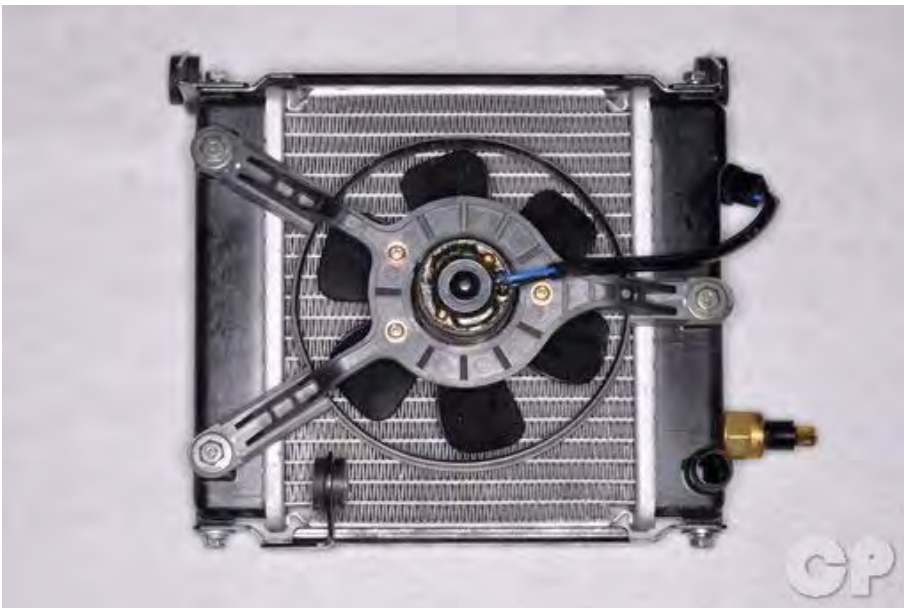

Inspect the radiator fins for damage and clogging. To remove the fan take out the three mounting bolts with a 10 mm socket.

Clean out the fins with low pressure compressed air and water.

NOTE: Always wear safety glasses when using compressed air and never point it directly at yourself or anyone else.



Check the radiator for any bent or damaged fins. Use a small flat blade screwdriver to straighten them out, but be careful not to puncture the radiator.



Jump a 12 volt battery to the fan connector and make sure the radiator fan operates.



If the thermostatic switch needs to be removed use a 22 mm wrench. The thermostatic switch should be off below 85°C (185°F) and on above 90°C (194°F).

Installation

Coolant Reserve Tank

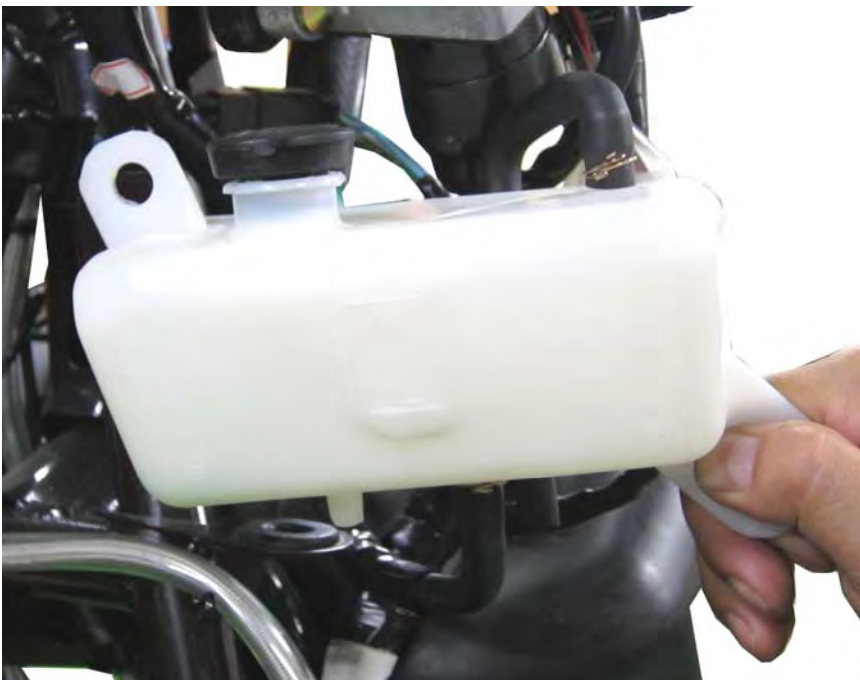

Fit the reserve tank onto the frame.

4. Cooling System > Radiator

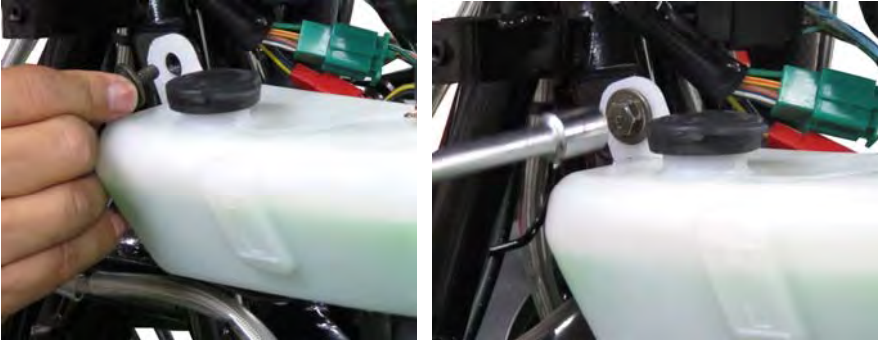

Insert the reserve tank mounting bolt and tighten them securely with a 10 mm socket.



Connect the dump hose to the top of the reserve tank and the overflow hose to the bottom. Secure the hoses with the clamps.

Radiator



4. Cooling System > Radiator



Fit the radiator into place so that the post on the frame fits into the rubber grommet on the right side of the radiator.



Install the two radiator mounting bolts and tighten them securely with a 10 mm socket.

4. Cooling System > Radiator



Route the filler neck coolant hose through the guide to the top right of the radiator.



Connect the coolant hose from the thermostat on the cylinder head to the top left of the radiator. Connect the coolant hose from the water pump to the bottom right of the radiator.



Tighten the coolant hose clamp screws securely with a #2 Phillips screwdriver.

4. Cooling System > Radiator



Plug in the cooling fan motor connector.



Plug in the thermostatic switch connectors.

Fill and bleed the coolant. See the [Coolant](#) topic for more information.

Install the radiator cover. See the [RadiatorCover](#) topic for more information.

Install the right and left front lower covers. See the [FrontLowerCover](#) topic for information.

Install the front cover. See the [Front Cover](#) topic for information.

Radiator Cover

SAFETY FIRST: Protective gloves and eyewear are recommended at this point.

Removal

Remove the right and left front lower covers. See the [Front Lower Cover](#) topic for information.

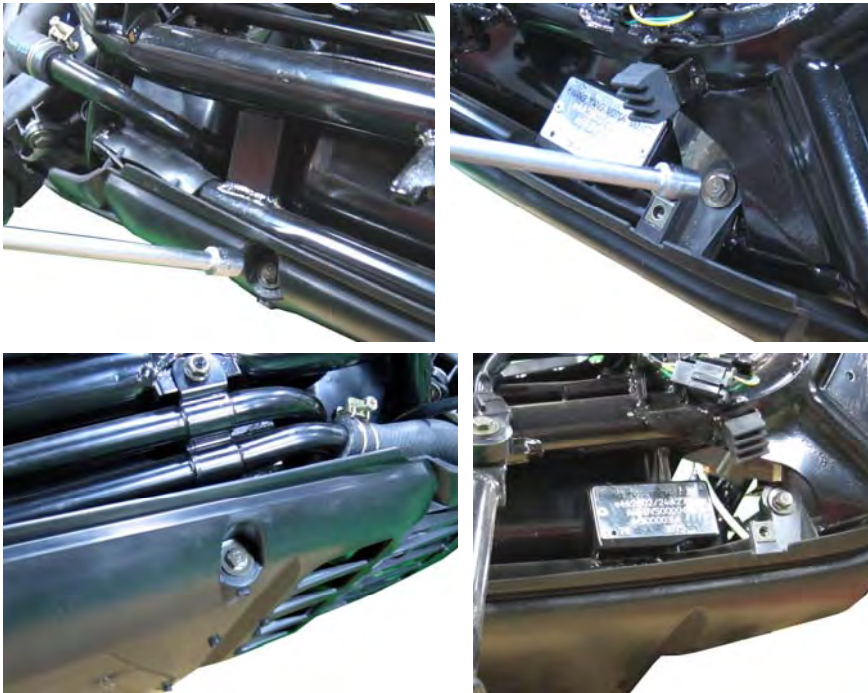

Remove the four bolts from the bottom of the radiator cover.

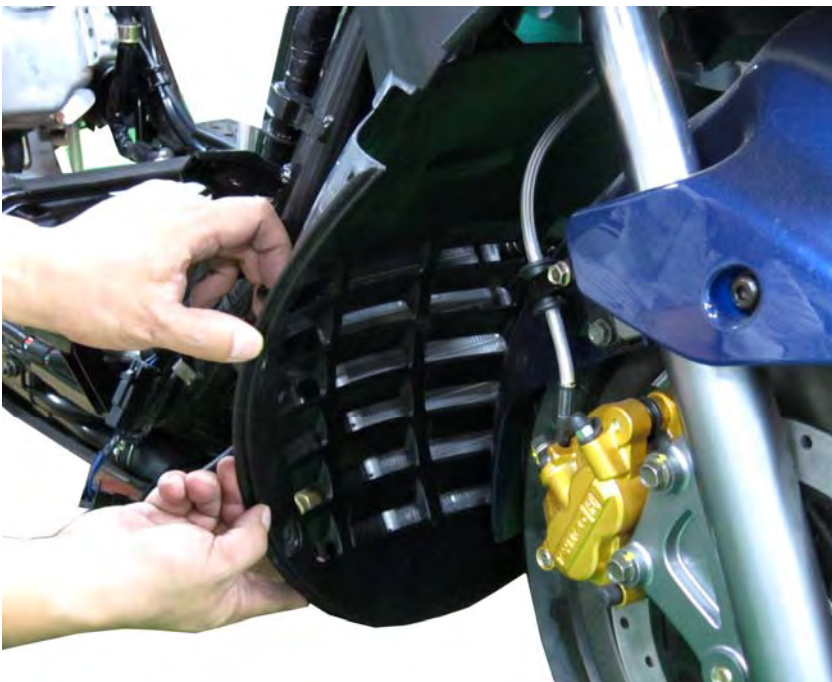

Remove the radiator cover.

Installation



Install the radiator cover.



Install the four bolts.

Install the right and left front lower covers. See the [Front Lower Cover](#) topic for information.

Thermostat and Thermosensor

SAFETY FIRST: Protective gloves and eyewear are recommended at this point.

Removal

Drain the coolant. See the [Coolant](#) topic for more information.

Remove the seat. See the [Seat](#) topic for more information.

Remove the luggage box. See the [Luggage Box](#) topic for more information.

Remove the rear carrier. See the [RearCarrier](#) topic for more information.

Remove the body cover. See the [Body Cover](#) topic for more information.

Thermosensor



Unplug the thermosensor unit and thermo unit ground connectors.

4. Cooling System > Thermostat



Remove the thermostat unit with a 12 mm deep well socket

Water Temperature Sensor (WTS)



Unplug the water temperature sensor.



Use a 17 mm wrench to remove the water temperature sensor.

4. Cooling System > Thermostat

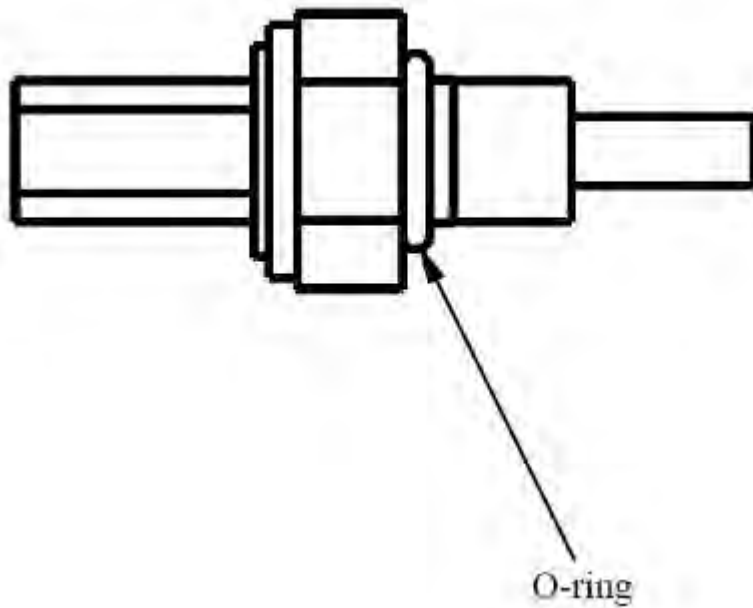

Discard the WTS O-ring and replace it with a new item.

Thermostat

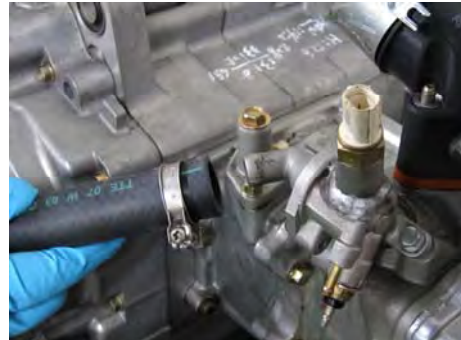

Loosen the thermostat hose clamp with a #2 Phillips screwdriver. Slide up the clamp and free the coolant hose from the thermostat.



Squeeze the air bleed hose clamp with needle nose pliers and slide back the clamp. Free the air bleed hose from the thermostat.

4. Cooling System > Thermostat

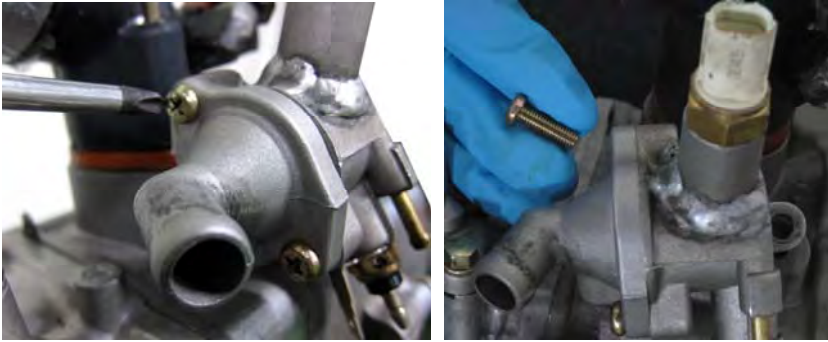

Remove the two thermostat mounting bolts with an impact #3 Phillips screwdriver.



Lift off the thermostat cover.



Lift out the thermostat. Remove the thermostat O-ring and discard it.

4. Cooling System > Thermostat

Inspection

Thermosensor

Set a digital multimeter to read ohms of resistance

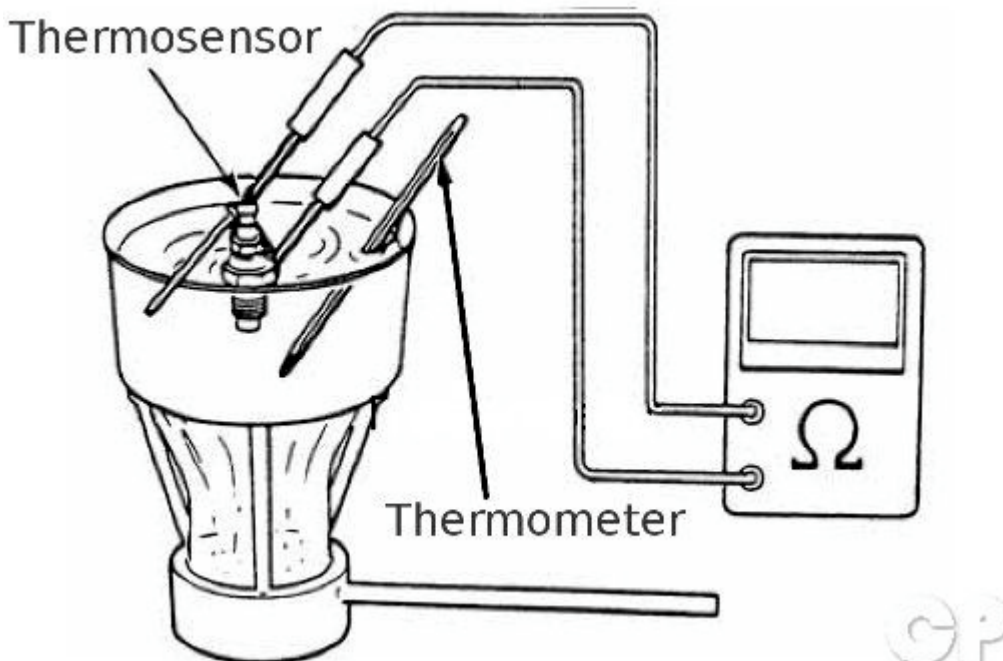

Suspend the thermosensor in a pan of water over a burner and measure the resistance through the sensor as the water heats up. Do not allow the thermosensor or the thermometer to contact the sides of the pan.

Thermosensor resistance	At 50 °C/122 °F	154
	At 80 °C/176 °F	52
	At 100 °C/212 °F	27
	At 120 °C/248 °F	16

Water Temperature Sensor

Inspect the WTS in a similar manner as the thermosensor. Measure the resistance between the WTS terminals and compare this to the specifications.

WTS resistance	At -20 °C/-4 °F	18.8 k
	At 40 °C/104 °F	1.136 k
	At 100 °C/212 °F	0.1553 k

Thermostat

The thermostat should be closed at room temperature.

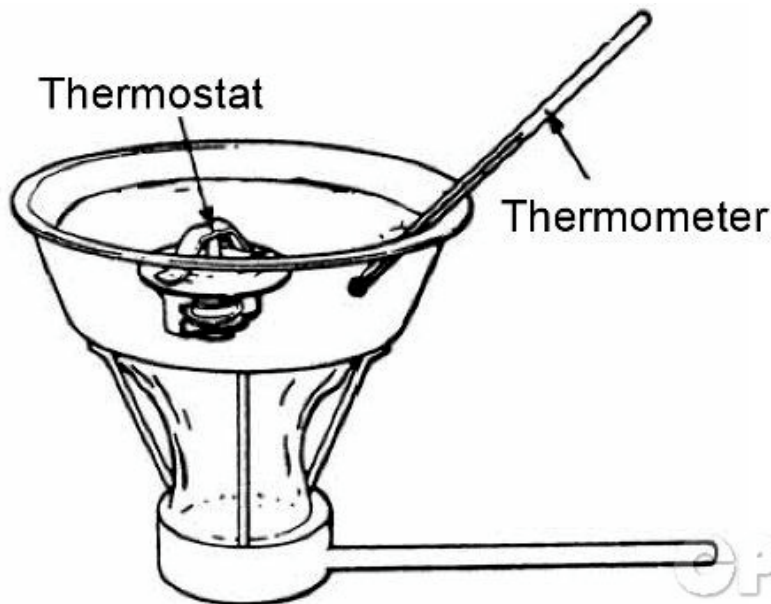

Suspend the thermostat and a thermometer in a pot of water with string. Make sure the thermostat and the thermometer are not touching the pot. Bring the temperature up to the specification slowly and check the operation of the thermostat.

The valve should begin to open around 71° C (160° F). The valve should lift 3.5 - 4.5 mm (0.14 - 0.18 in) at 80° C (176° F).

After the thermostat has been open for around 5 min. allow the thermostat to cool. The thermostat should close at 70° C (158° F).

Replace the thermostat with a new unit if it fails to function properly.

Installation

Thermosensor



Tighten the thermosensor unit securely with a 12 mm deep well socket



Plug in the thermostensor unit and ground connectors.

Water Temperature Sensor



Install the WTS with a new O-ring. Tighten the WTS to specification with a 17 mm wrench.



Plug in the water temperature sensor connector.

Thermostat



Make sure the thermostat seal is in good condition. Replace the thermostat if needed. Apply a light coat of waterproof grease to the thermostat seal. Insert the thermostat into its cavity in the cylinder head.



Fit the thermostat cover into place.

4. Cooling System > Thermostat

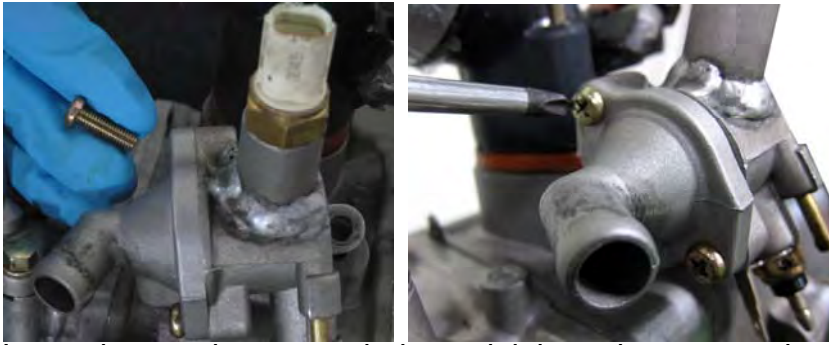

Insert the two thermostat bolts and tighten them securely with an impact #3 Phillips screwdriver.



Install air bleed hose and secure it with the clamp.



Connect the coolant hose to the thermostat. Move the clamp into place and tighten it securely with a #2 Phillips screwdriver.

Fill the coolant and check for leaks. See the [Coolant](#) topic for more information.

Install the body cover. See the [Body Cover](#) topic for more information.

Install the rear carrier. See the [Rear Carrier](#) topic for more information.

Install the luggage box. See the [Luggage Box](#) topic for more information.

Install the seat. See the [Seat](#) topic for more information.

Water Pump

SAFETY FIRST: Protective gloves and eyewear are recommended at this point.

Mechanical Seal Inspection



Inspect the telltale hole in the generator cover below the water pump for signs of coolant leaking. If there is coolant coming from this hole the mechanical seal is compromised and must be replaced.

Removal

Water Pump Cover

Remove the following components -

- ' Seat
- ' Luggage Box
- ' CenterCover
- ' RearCarrier
- ' BodyCover
- ' FrontCover
- ' FrontLowerCover
- ' Foot Skirt
- ' Exhaust System

4. CoolingSystem > Water Pump

Drain the coolant. See the [Coolant](#) topic for more information.



Loosen the water pump hose clamp with a #2 Phillips screwdriver. Slide up the clamp and free the coolant hose from the water pump. Allow any remaining coolant to drain into a suitable container.

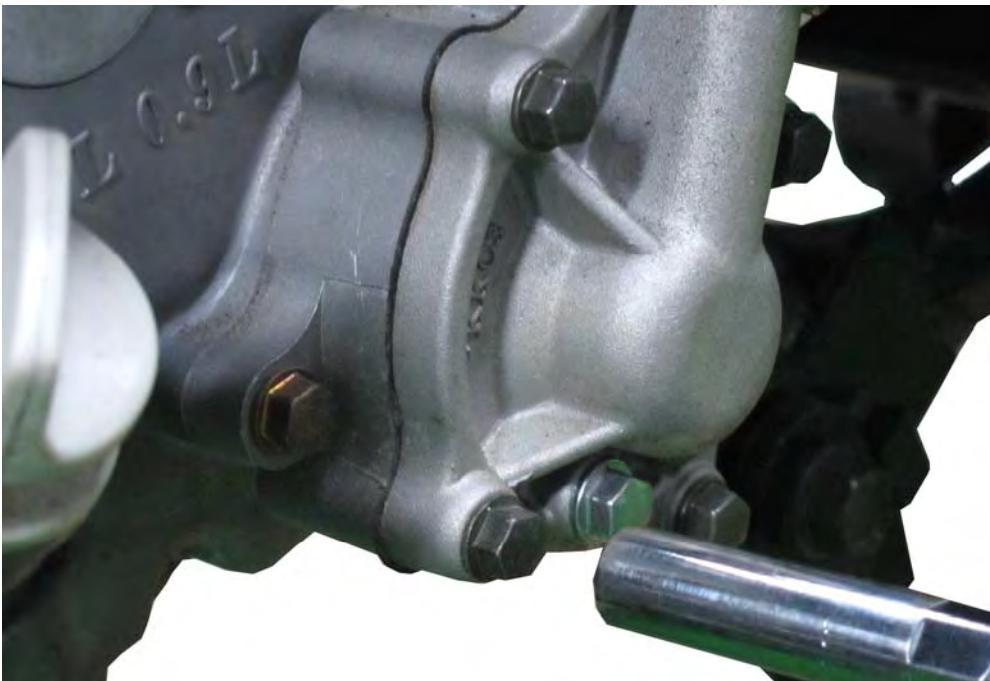

Loosen the four water pump cover bolts with an 8 mm socket.



Remove the bolts and the water pump cover.

4. CoolingSystem > Water Pump



Remove the two dowel pins and the water pump cover gasket.

Impeller and Shaft

Remove the generator cover. See the [Generator](#) topic for more information.



Hold the water pump shaft and loosen the impeller with a 12 mm socket. The impeller has left hand threads.

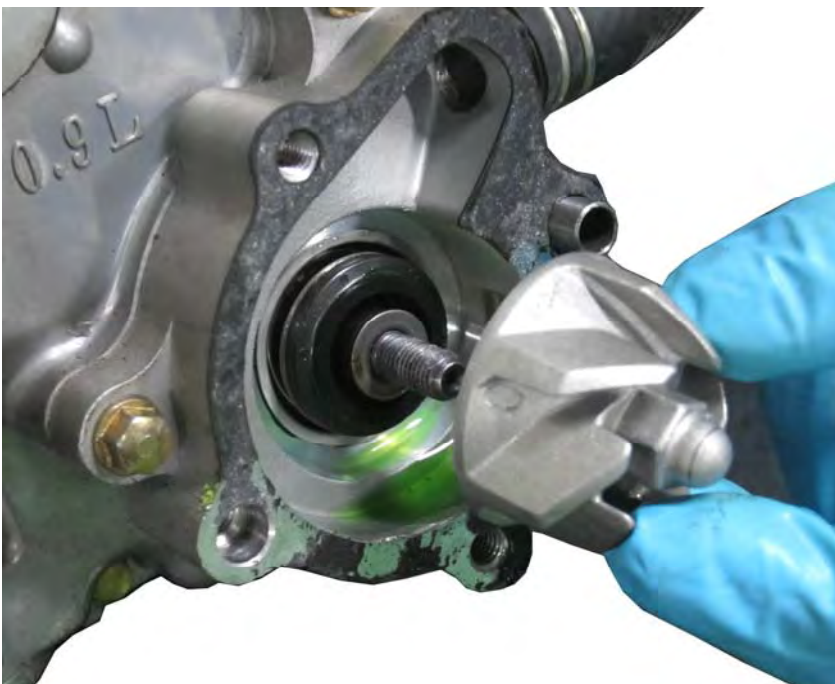

Remove the impeller.

4. CoolingSystem > Water Pump



Remove the seal washer from the back of the impeller. Inspect the impeller blades and seal. Replace the seal washer if the mechanical seal is to be replaced.



Remove the water pump shaft from the generator cover.



To replace the mechanical and oil seals drive them out from the inside of the generator cover.

4. CoolingSystem > Water Pump

Assembly

Seals, Shaft, and Impeller

Coat the lips of the new oil seal in fresh engine oil and drive it in with a suitable drive that is the same outside diameter as the oil seal.



Apply silicone sealant to the outside of the mechanical seal. Press in the seal with a suitable drive that is the same outside diameter as the oil seal.



4. CoolingSystem > Water Pump

Place the washer and thrust washer on the water pump shaft. Install a new snap ring onto the water pump shaft if the snap ring was removed.



Lubricate the water pump shaft with fresh engine oil where it will ride in the case. Insert the water pump shaft into the generator cover from the inside.



Install a new washer into the back of the impeller if the mechanical seal was replaced.

4. CoolingSystem > Water Pump



Install the impeller to the water pump shaft. Note: Left hand threads.



Hold the water pump shaft and tighten the impeller to specification with a 12 mm socket. Remember the impeller has left hand threads.

Item	Qty	Thread size (mm)	Torque	
			kgf-m	lb-ft
Water pump impeller	1	7	1.0-1.4	7.23-10.13

Install the generator cover. See the [Generator](#) topic for more information.

Make sure the water pump cover mating surface is clean.

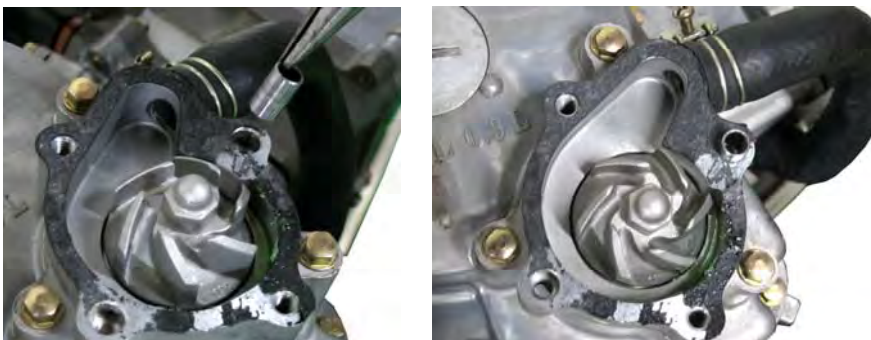

Install the two dowel pins into the generator cover and set a new water pump cover gasket in place.

4. CoolingSystem > Water Pump



Install the water pump cover and insert the four bolts.



Tighten the water pump cover bolts to specification with an 8 mm socket.



Connect the coolant hose to the water pump. Move the clamp into place and tighten it securely with a #2 Phillips screwdriver.

Install the exhaust system. See the [Exhaust System](#) topic for more information.

4. CoolingSystem > Water Pump

Fill the coolant and bleed the coolant. See the [Coolant](#) topic for more information.

[Foot Skirt](#)

[FrontLowerCover](#)

[FrontCover](#)

[BodyCover](#)

[RearCarrier](#)

[CenterCover](#)

[Luggage Box](#)

[Seat](#)

Final Drive

This chapter covers the location and servicing of the final drive components for the KYMCO G-Dink 125i.

- Final Reduction _____ 1
- Final Drive Oil _____ 2-6

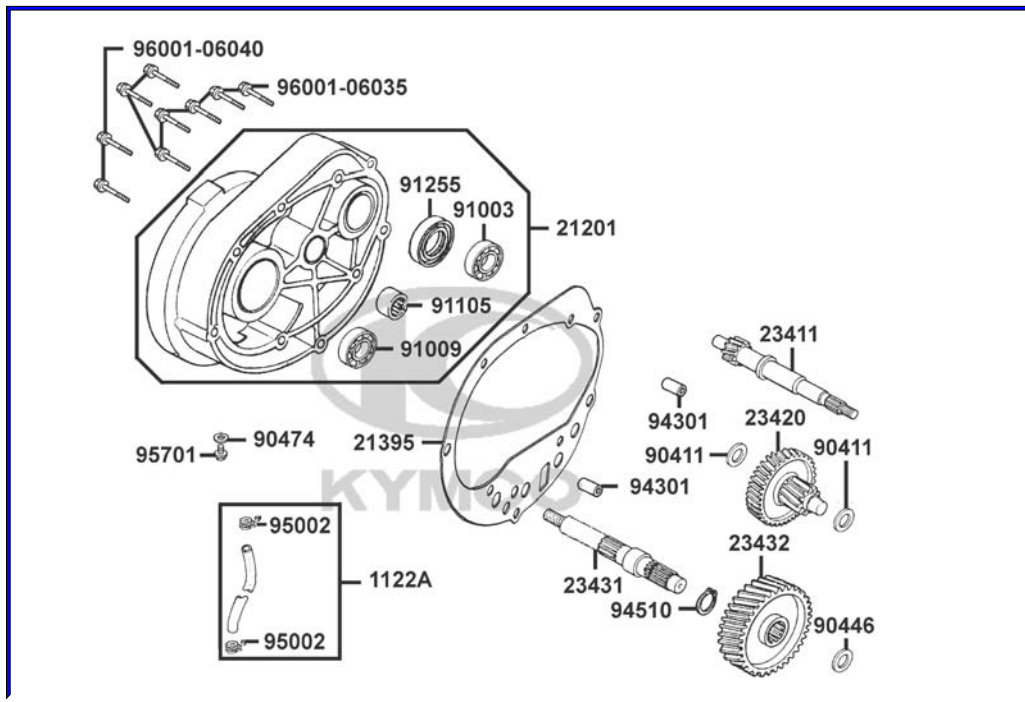

GENERAL INSTRUCTIONS

- The servicing operations of this section can be made with the engine installed.
- When replacing the drive shaft, use a special tool to hold the bearing inner race for this operation.

TROUBLESHOOTING

Engine starts but motorcycle won't move

- Damaged transmission
- Seized or burnt transmission

Abnormal noise

- Worn, seized or chipped gears
- Worn bearing

Oil leaks

- Oil level too high
- Worn or damaged oil seal

Final Drive Oil

SAFETY FIRST: Protective gloves and eyewear are recommended at this point.

Place the scooter on level ground and up on its center stand.

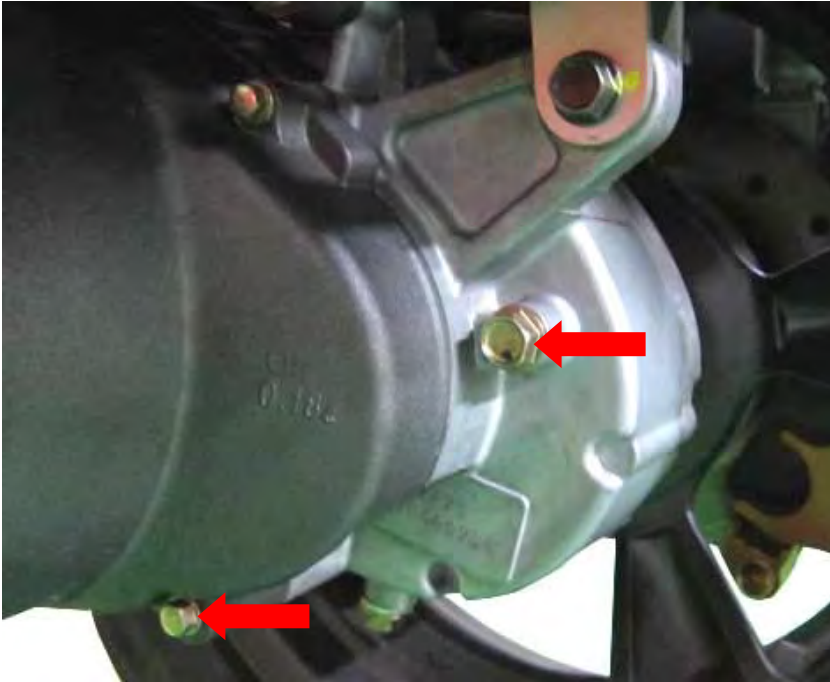

The oil drain bolt and oil filler bolt are located on the transmission.

Gear oil type:	SAE 90
Gear oil capacity:	
At disassembly	0.23 Liter
At change	0.18 Liter

Inspection

Place the vehicle on its center stand on level ground.

5. Final Drive > Transmission Oil

Remove the transmission oil level check bolt with a 12 mm socket. The oil level is correct when oil flows from the bolt hole. Install the oil level check bolt and tighten it to specification with a 12 mm socket.

Item	Qty	Thread size (mm)	Torque	
			kgf-m	lb-ft
Final Drive oil check bolt	1	8	0.8 - 1.2	5.79 - 8.68

If the level is too high allow the oil to flow out of the check hole until the level is even with the bolt hole.

If the level is low add more of the same type and brand of oil as shown below. Inspect for leaks.

Draining

Place the vehicle on its center stand on level ground. Place a suitable oil drain pan under the transmission oil drain plug.

5. Final Drive > Transmission Oil

Place a suitable container under the drain plug to capture the final drive oil. Loosen the oil drain plug with a 12 mm socket. Remove the drain plug and slowly rotate the rear wheel to drain the transmission oil.



Inspect the drain plug and washer.

5. Final Drive > Transmission Oil

Install the oil drain plug and washer with a 12 mm socket. Tighten to specification.

Item	Qty	Thread size (mm)	Torque	
			kgf-m	lb-ft
Final drive oil drain bolt	1	8	0.8-1.2	5.79-8.68

Filling

Fill the final drive oil with a syringe until oil begins to flow from the level check bolt hole.

Gear oil type:	SAE 90
Gear oil capacity:	
At disassembly	0.23 Liter
At change	0.18 Liter

5. Final Drive > Transmission Oil

Thread in the final drive oil level check bolt.



Install the oil check plug and torque it to specification with a 12 mm socket.

Item	Qty	Thread size (mm)	Torque	
			kgf-m	lb-ft
Final drive oil check bolt	1	8	0.8 - 1.2	5.79 - 8.68

Wheels

This chapter covers the location and servicing of the wheels for the **KYMCO G-Dink 125**.

• <u>Front Wheel</u>	2-6
• <u>Rear Wheel</u>	7-15
• <u>Wheel Inspection</u>	16-17
• <u>Bearing Replacement</u>	18-21

Troubleshooting

Front wheel wobbling

- Bent rim
- Loose front axle
- Bent spoke plate
- Faulty tire
- Improperly tightened axle nut

Rear wheel wobbling

- Bent rim
- Faulty tire
- Axle not tightened properly

Rear wheel noise

- Worn rear wheel axle bearings
- Worn rear fork bearings
- Deformed rear fork

Front Wheel

SAFETY FIRST: Protective gloves and eyewear are recommended at this point.

Removal



Loosen the front axle with an 8 mm socket.



Lift the front end of the vehicle with a suitable stand or jack so that the front wheel comes off of the ground.

6. Wheels > Front Wheel

Support the front wheel and slide the front axle out from the left side.



Guide the front wheel out from the fork legs and the brake disc out from between the pads. Do not squeeze the brake lever while the disc is not present between the pads.

6. Wheels > Front Wheel

Remove the collars from right side of the wheel. Inspect the bearing seals and the O-rings seals on the collars. Replace the seals if they are in poor condition.

Inspect the wheels and axle. See the [Wheel Inspection](#) topic for more information.

Inspect the wheel bearings by turning them in the hub. If the bearings have play in them or are rough replace all the bearings for that wheel. See the [Bearing Replacement](#) topic for more information.

To remove the wheel speed sensor rotor loosen the three bolts with an Allen wrench.

To remove the brake disc see the [Brake Disc](#) topic.

Installation

Apply grease to the lips of the dust seals and collar O-rings. Insert the collars into the hub as shown.

6. Wheels > Front Wheel



Make sure the tire direction of rotation marker is correct. Slide the front wheel into the fork. Fit the brake disc between the brake pads in the front caliper.



Apply a light coat of grease to the front axle. Insert the axle from the left side.

Set the front wheel on the ground. Pump the front suspension up and down several times to seat the front axle.

6. Wheels > Front Wheel

Torque the axle to specification with an 8 mm Allen.

Item	Qty	Thread	Torque	
		size (mm)	kgf-m	lb-ft
Front axle	1	14	1.5-2.5	10.84-18.08

Pump the front brake lever to establish pressure and to seat the pads against the disc. If the Brakes do not pump up correctly check the brake fluid. See the [Brake Fluid](#) topic for more information.

5. Wheels > Rear Wheel

SAFETY FIRST: Protective gloves and eyewear are recommended at this point.

- When performing the services stated in this section, the engine and exhaust muffler must be cold to avoid scalding.
- During servicing, keep oil or grease off the brake pads and brake disk.

Removal

Remove the muffler. See the [Exhaust System](#) topic for more information.

Remove the airbox. See the [Airbox](#) topic for more information.

Remove the rear fender. See the [Rear Fender](#) topic for more information.

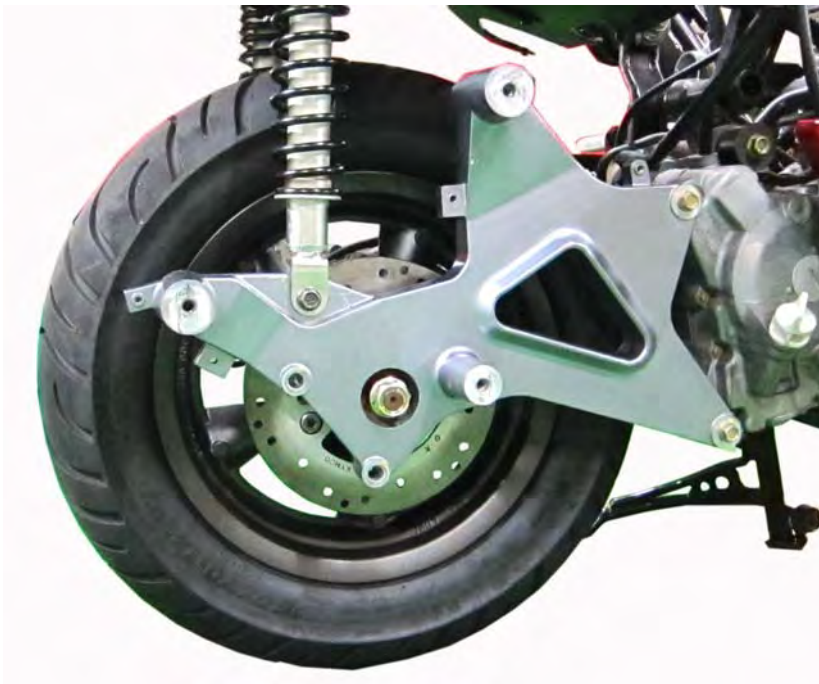

Remove the right side rear shock mounting bolt with a 14 mm socket.

5. Wheels > Rear Wheel



Move the rear shock out of the way.



Hold the rear brake to keep the rear wheel from turning. Remove the rear axle nut with a 24 mm socket.

Remove the rear brake caliper. See the [Rear Brake Caliper](#) topic for more information.

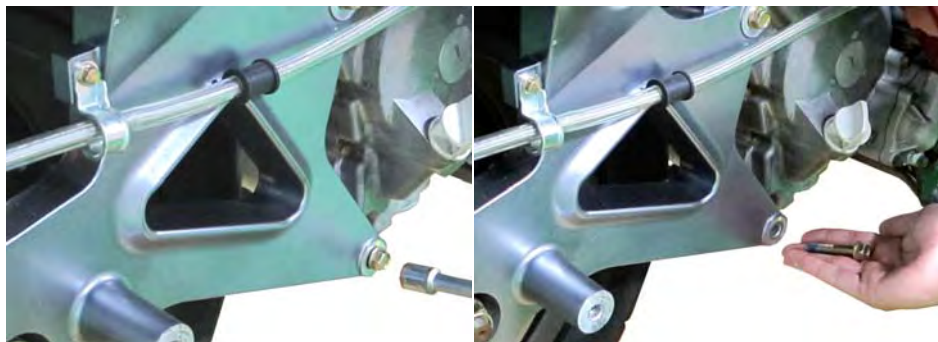

Remove the two rear fork bolts with a 14 mm socket.

5. Wheels > Rear Wheel



Slide the rear fork out and remove it from the right side of the vehicle.

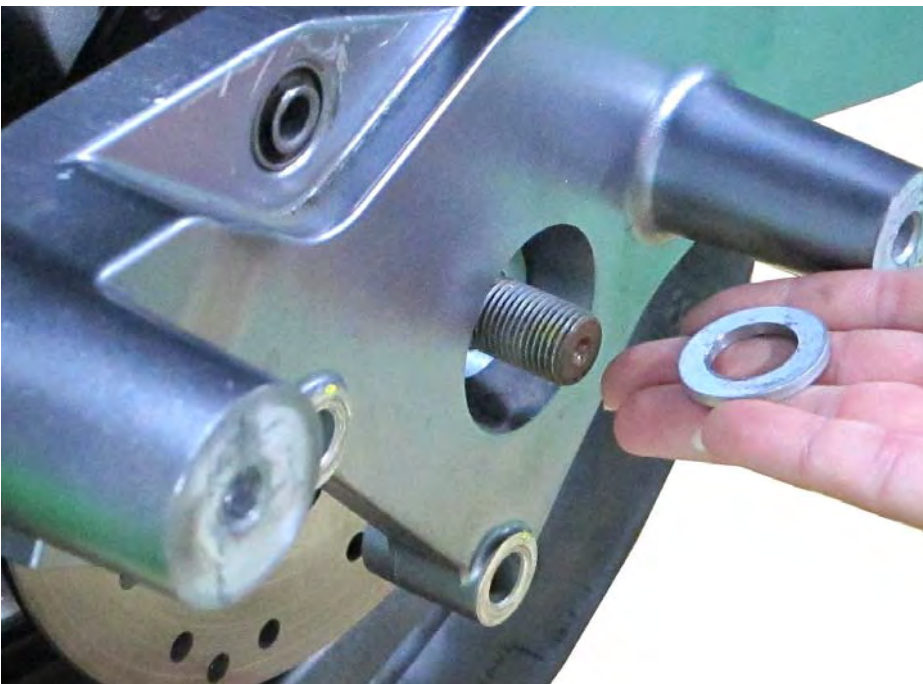

Remove the rear axle washer from the right side of the rear axle.

5. Wheels > Rear Wheel

To remove the rear wheel support the right rear shock absorber so that it is out of the way or remove it.



Remove the upper shock absorber mounting bolt with a 12 mm socket. Free the shock absorber from the frame.



Slide the rear wheel to the right and off of the rear axle.

Inspect the wheel bearings by turning them with a finger. If the bearings have play in them or are rough replace all the bearings for that wheel. See the [Bearing Replacement](#) topic for more information.

Inspect the rear wheel. See the [Wheel Inspection](#) topic for more information.

5. Wheels > Rear Wheel

Installation

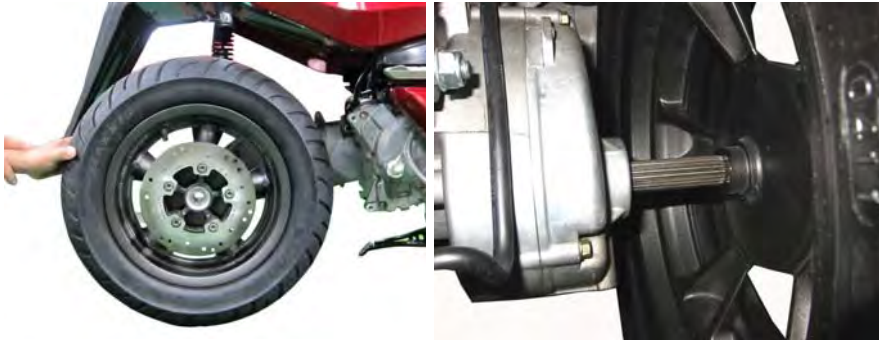

Line up the splines on the rear wheel with those of the rear axle. Slide the rear wheel on to the axle so that the brake disc sits on the right side.



Install the right shock absorber if it was removed. Install the upper mounting bolt and tighten it to specification with a 12 mm socket.

Item	Torque	
	kgf-m	lb-ft
shock absorber mounting bolt	4	28.93

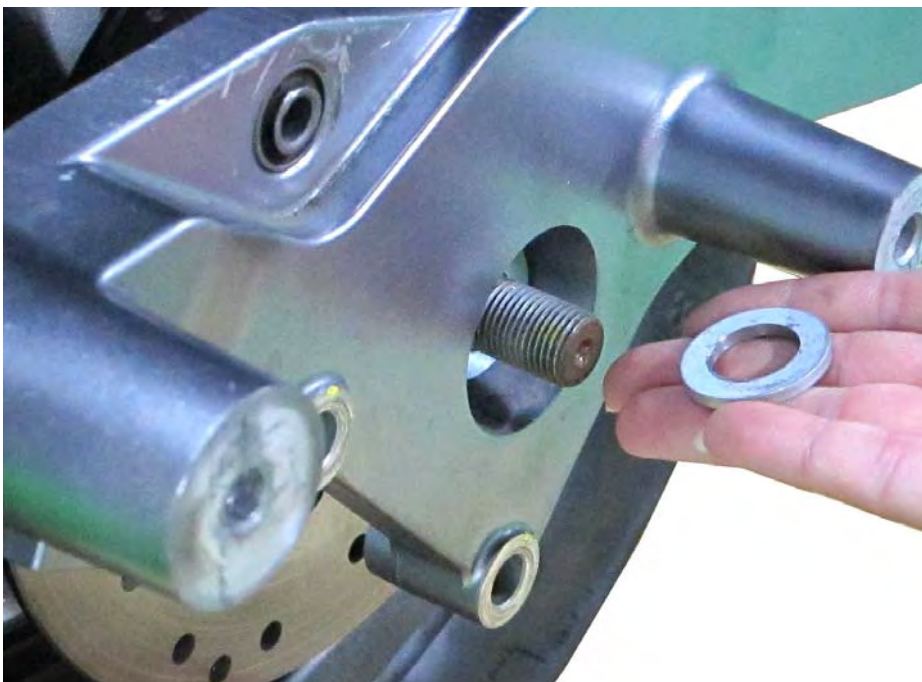

Slide on the rear axle washer.

5. Wheels > Rear Wheel



Fit the rear fork into place.



Install the two rear fork mounting bolts and tighten them securely with a 14 mm socket.

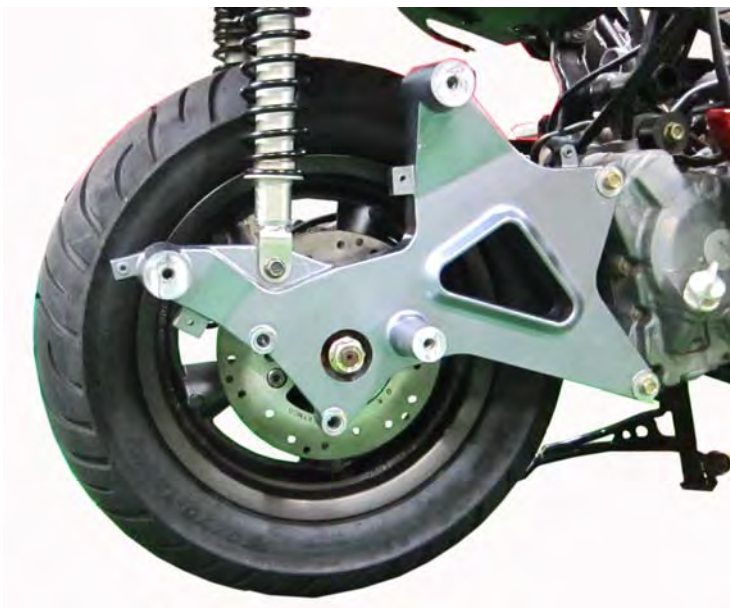

5. Wheels > Rear Wheel



Install the rear axle nut and tighten it to specification with a 24 mm socket.

Item	Qty	Thread size (mm)	Torque		Remarks
			kgf-m	lb-ft	
Rear axle nut	1	16	11-13	79.56-94.03	U-nut



Fit the shock absorber into place. Make sure the preload arrow indicator faces out from the lower mount.

5. Wheels > Rear Wheel



Install the upper shock absorber mounting bolt and torque it to specification with a 12 mm socket.

Item	Torque	
	kgf-m	lb-ft
shock absorber mounting bolt	4	28.93

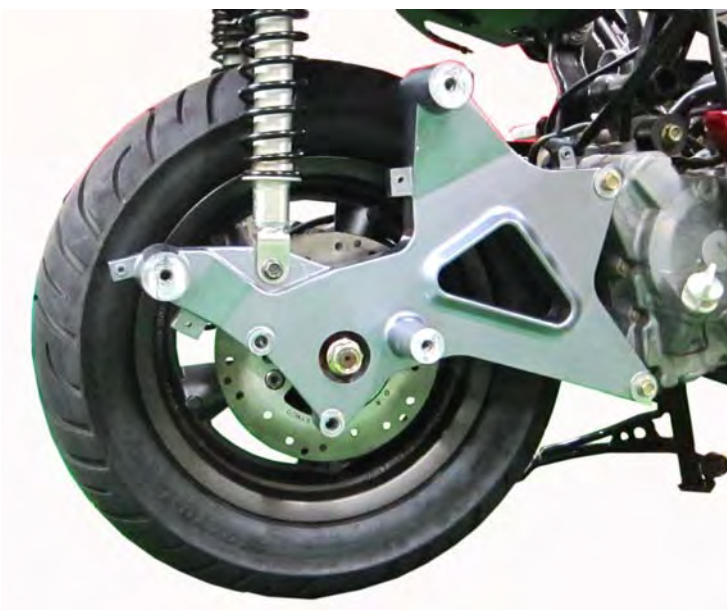



Install the lower shock absorber mounting bolt and torque it to specification with a 12 mm socket.

Item	Torque	
	kgf-m	lb-ft
shock absorber mounting bolt	4	28.93

Install the rear brake caliper. See the [Rear Brake Caliper](#) topic for more information.

Install the rear fender. See the [Rear Fender](#) topic for more information.

Install the airbox. See the [Airbox](#) topic for more information.

Install the muffler. See the [Exhaust System](#) topic for more information.

Wheel Inspection

SAFETY FIRST: Protective gloves and eyewear are recommended at this point.

Turn the inner race of each bearing with your finger to see if they turn smoothly and quietly. Also check if the outer race fits tightly in the hub. Replace the bearings if the races do not turn smoothly, quietly, or if they fit loosely in the hub. See the [Bearing Replacement](#) topic for more information.



Place the wheel on a truing stand and use a dial indicator to check if the rim is out of true. The specifications for the front and rear wheels are the same. Check for lateral wobble. The service limit is 2.0 mm (0.08 in) or less.

6. Wheels > Wheel Inspection

Check for radial hop. The service limit is 2.0 mm (0.08 in) or less.



Check the front axle runout. The axle runout specification is half of the total indicator reading. Replace the axle if the measurement exceeds 0.2 mm or 0.008 in.

Inspect the dust seals and replace them as needed.

Wheel Bearing Replacement

SAFETY FIRST: Protective gloves and eyewear are recommended at this point.

Replace bearings as a set, and do not reuse old bearings.

Place the new bearings in the freezer about an hour before you plan to install them.

Do not let the wheel rest on its brake disc. To remove the Brake discs see the [Brake Disc](#) topic.

Front Wheel



Remove the dust seal from the right side of the front wheel using a seal pick or large flat blade screwdriver. Discard the dust seal, it should be replaced by a new item.



Inspect the wheel bearings by turning them in the hub. If the bearings have excessive play in them or are rough replace all the bearings for that wheel.

6. Wheels > Bearing Replacement

Remove one of the bearings with a bearing puller.

Special Tools- Bearing Puller: E00037



Remove the distance collar.



Repeat the procedure and remove the other bearing and seal. The seal should be replaced with a new item.

6. Wheels > Bearing Replacement

Heat the bearing area of the wheel with a heat gun, take the bearing out of the freezer and install it. You can use a bearing installer tool or a socket with the same outside diameter as the bearing. Make sure the bearing is fully seated and the marked side is facing out.

Special Tools-Bearing Installer: E00014



Insert the distance collar into the hub.

6. Wheels > Bearing Replacement

Drive in the other bearing. The bearing should fit against the distance collar. Do not continue to force the bearing in or the distance collar will begin to push the right bearing back out.



Apply grease to the lips of the dust seals. Drive in new dust seals.

Steering

This chapter covers the location and servicing of the steering components for the KYMCO G-Dink 125i.

- Steering Stem and Bearing Removal 2-7
- Steering Stem and Bearing Installation 8-12
- Handlebar 13-21

TROUBLESHOOTING

Hard steering (heavy)

- Excessively tightened steering stem top cone race
- Broken steering balls
- Insufficient tire pressure

Steers to one side or does not track straight

- Uneven front shock absorbers
- Bent front fork
- Bent front axle or uneven tire

Steering Stem Removal

SAFETY FIRST: Protective gloves and eyewear are recommended at this point.



Support the vehicle with a suitable stand or jack so that the front wheel is off the ground. Grip the bottom of the fork legs and turn the front end side-to-side. If the movement is rough the bearings should be greased or replaced. If the movement is too tight or loose the steering stem adjusting nut may need to be adjusted.

The KYMCO G-Dink 125i uses ball bearings in the steering. Always replace the races at the same time as the bearings.

Remove the handlebar covers. See the [Handlebar Covers](#) topic for more information.

Remove the front cover. See the [Front Cover](#) topic for more information. Remove the handlebar. See the [Handlebar](#) topic for more information.

Remove the front fender. See the [Front Fender](#) topic for more information.

Remove the front wheel. See the [Front Wheel](#) topic for more information.

Remove the front fork. See the [Front Fork](#) topic for more information.

7. Steering > Removal

A special lock nut wrench is needed to loosen the steering stem lock nut.

Special Tool - Lock Nut Wrench: A120F00002

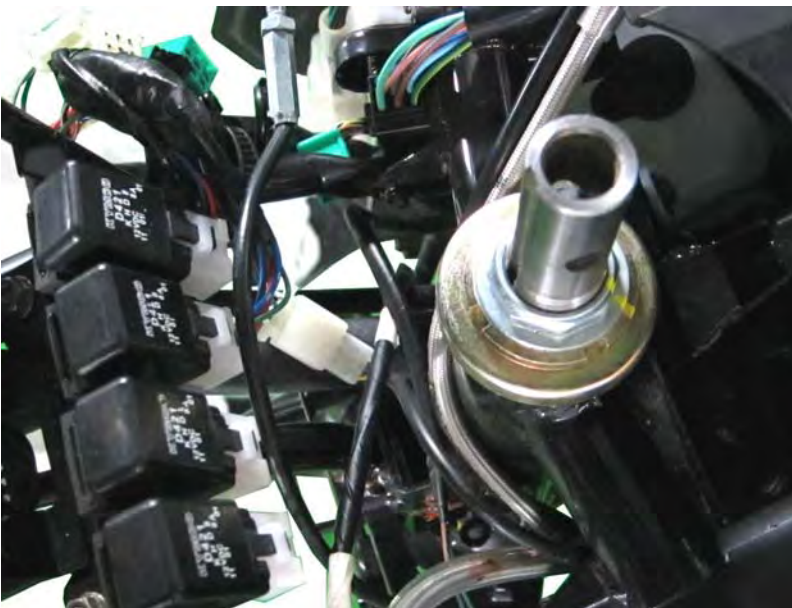

Slide the special tool over the steering stem and loosen the lock nut. Remove the steering stem lock nut.

7. Steering > Removal

Slide off the lock washer.



Support the steering stem and loosen the steering stem adjusting nut with a pin spanner.



Remove the steering stem adjusting nut.

7. Steering > Removal

Remove the dust cover and grease seal.



Lower the steering stem out of the frame.



Remove the upper bearing inner race.

7. Steering > Removal

Lift out the upper ball bearings.



Slide the lower ball bearings up and off of the steering stem.

Inspect the bearings and races for wear and damage. Replace them as needed.



Use a chisel to remove the bottom bearing inner race and dust seal. Do not damage the steering stem.

7. Steering > Removal



Use the special tools or a drift and hammer to drive out the bearing races in the steering head.



Have the drift set against the lip of the race, and work around the race evenly to drive it out. Repeat the process with the remaining bearing race.

To install the steering stem bearings and stem see the [Steering Stem Installation](#) topic.

Steering Stem Installation

SAFETY FIRST: Protective gloves and eyewear are recommended at this point.



Coat the new dust seal in grease and slide it down the steering stem. Drive the new lower bearing inner race onto the steering stem with a pipe with the same outside diameter as the bearing race.



Drive the new bearing races into the steering head with a suitable driver with the same outside diameter as the bearing race.

7. Steering > Installation

Lubricate the upper bearing with grease and set it into place.



Lubricate the new lower bearing with grease and place it on the steering stem.



Set the upper bearing inner race into the upper bearing.

7. Steering > Installation

Guide the steering stem into the steering head of the frame.



Lubricate the grease seal with grease. Set the grease seal and dust cover into place over the steering stem.



Thread on the steering stem adjusting nut.

7. Steering > Installation

Tighten the steering stem adjusting nut. Turn the steering stem lock-to-lock several times to seat the bearings.

Loosen the adjusting nut 1/4 to 1/2 half turn. Adjust the nut so the steering moves correctly. The adjusting nut should be tight enough so that the steering doesn't flop back and forth and vertical movement is eliminated. However, it should not be so tight as to cause binding or require excessive force to turn.



Slide the lock washer onto the steering stem as shown.



Thread the steering stem lock nut onto the steering stem.

7. Steering > Installation

Torque the steering stem lock nut to specification with the lock nut wrench special tool.

Item	Qty	Thread size (mm)	Torque	
			kgf-m	lb-ft
Steering Stem lock nut	1	BC1	6.0-6.5	43.40-46.80

Special Tool - Lock Nut Wrench: A120F00002

Install the front fork. See the [Front Fork](#) topic for more information.

Install the front wheel. See the [Front Wheel](#) topic for more information.

Install the front fender. See the [Front Fender](#) topic for more information.

Install the handlebar. See the [Handlebar](#) topic for more information.

Install the front cover. See the [Front Cover](#) topic for more information.

Install the handlebar covers. See the [Handlebar Covers](#) topic for more information.

Handlebar

SAFETY FIRST: Protective gloves and eyewear are recommended at this point.

Removal

Remove the handlebar covers. See the [Handlebar Covers](#) topic for more information.

Remove the front cover. See the [Front Cover](#) topic for more information.

Bar Ends



Remove the bar ends with a 6 mm Allen.

To remove the brake master cylinders see the. [Brake Master Cylinder](#) topic.

Switch Housings and Throttle



Remove the two right switch housing mounting screws with a #2 Phillips screwdriver. Disconnect the switch.

7. Steering > Handlebar

Separate the switch housing from the handlebar.



Disconnect the throttle cables and free the right switch housing from the handlebar.



Slide off the throttle grip.

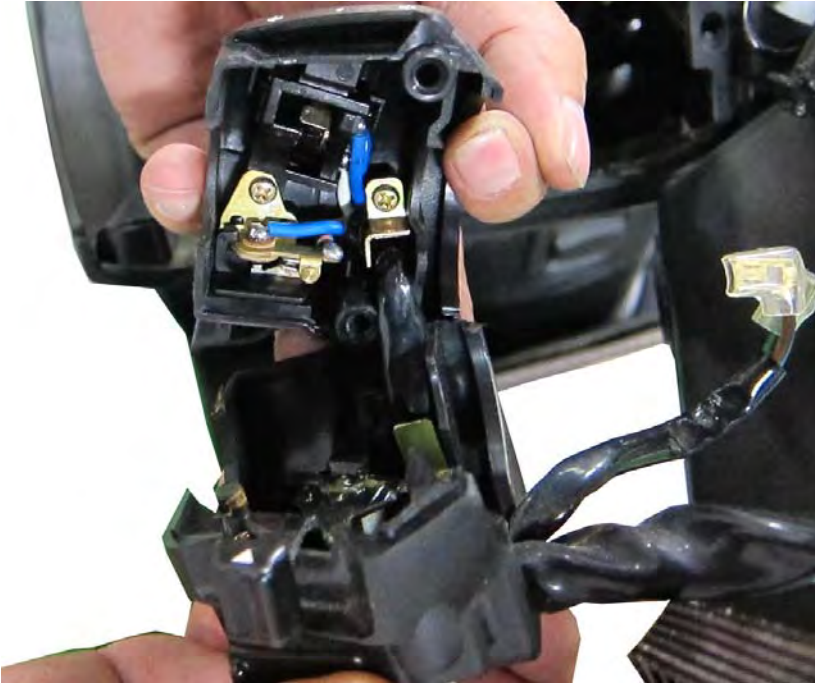

Remove the two left switch housing mounting screws with a #2 Phillips screwdriver.

7. Steering > Handlebar

Disconnect the switch. Separate the left switch housing from the handlebar.

Handlebar

Route the cables and lines from the handlebar cable guide.

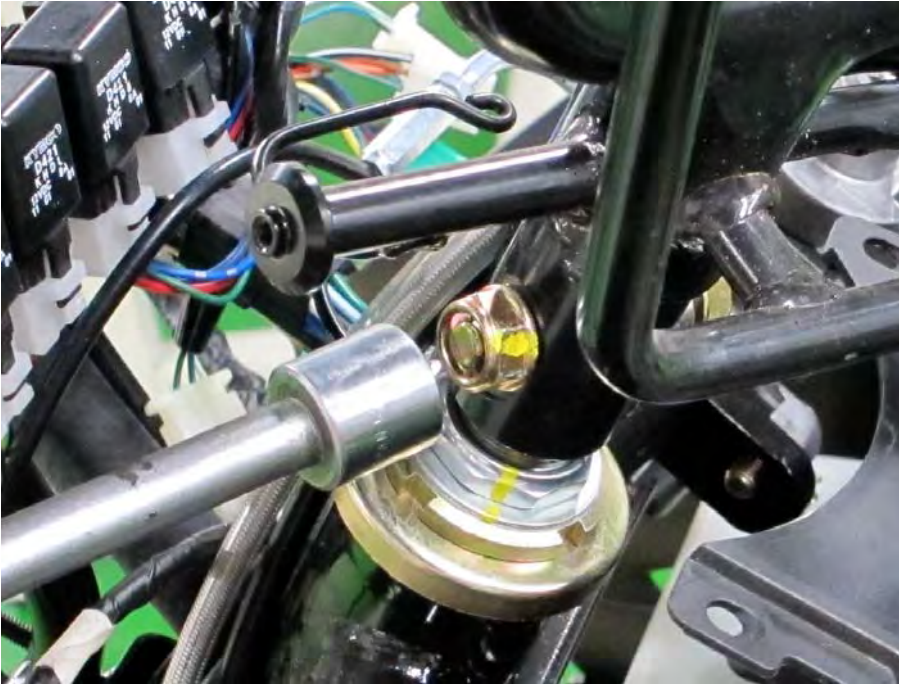
7. Steering > Handlebar

Hold the handlebar lock bolt with a 14 mm wrench and loosen the nut with a 17 mm socket.



Remove the handlebar lock nut and bolt.



Remove the handlebar.

Grips



If you plan to replace the grips you can slice them lengthwise with a razor blade and peel them off. To remove the grips without cutting them use a screwdriver to open a gap between the grip and the handlebar. Spray in contact cleaner to break up the grip cement. Use compressed air to expand the grip so it can be easily slid off the end of the handlebar. Note the relationship between the angle of the grip and the throttle tube so that the new grip can be installed with the correct angle.

NOTE: Always wear safety glasses when using compressed air and never point it directly at yourself or anyone else.

Before installing the grips to either the throttle tube or the handlebar, wipe down the area with a brake or parts cleaner that will dry without leaving a residue. When you are sure the area is dry apply grip cement to the bar or tube. Install the left grip at an angle of your preference. Install the throttle grip onto the tube with the same angle as the original grip.

Installation

Handlebar

7. Steering > Handlebar

Install the handlebar onto the steering stem and align the holes.

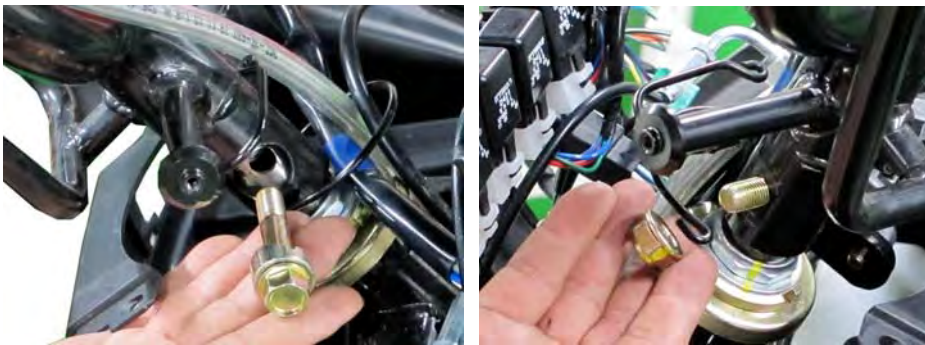

Install the handlebar lock bolt and thread on the nut.

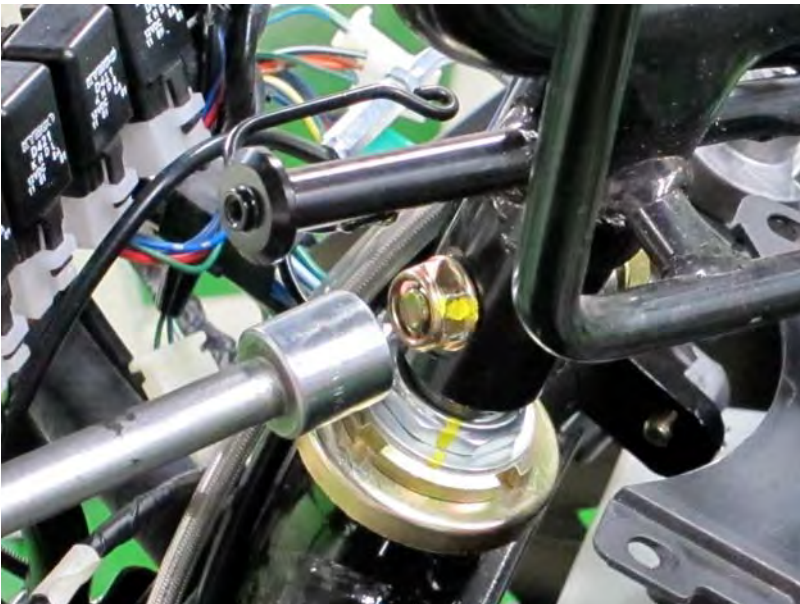

Hold the handlebar lock bolt with a 14 mm wrench and tighten the nut to specification with a 17 mm socket.

Item	Torque	
	N-m	lb-ft
Handlebar Lock Nut	65	46.8

7. Steering > Handlebar



Route the cables and lines through the handlebar cable guide.

Switch Housings and Throttle

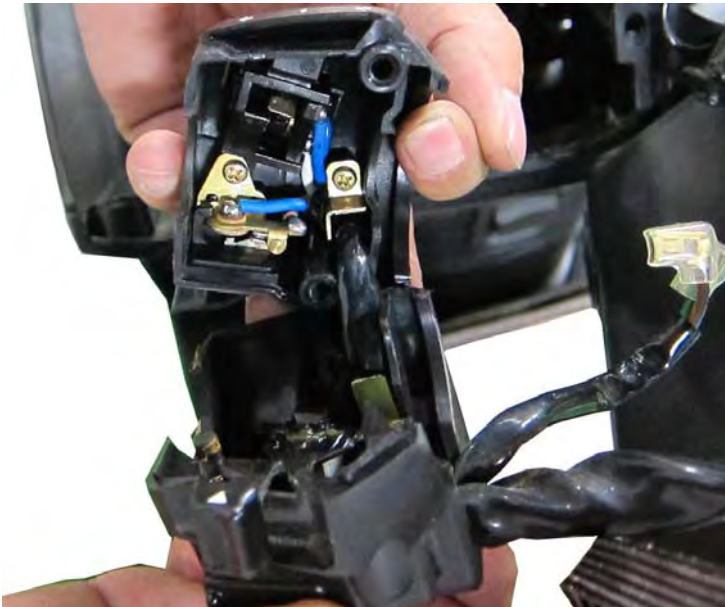

Align the left switch housing and install on the handlebar.



Insert the two housing screws and tighten them securely with a #2 Phillips screwdriver. Connect the switch.

7. Steering > Handlebar

Slide the throttle grip onto the right side of the handlebar.



Install the right switch and throttle housing. The post on the housing should fit into the hole in the bar.



Lubricate the end of the throttle in grease. Fit the ends of the throttle cables into the throttle tube.

7. Steering > Handlebar



Insert the two housing screws and tighten them securely with a #2 Phillips screwdriver. Tighten the front bolt before the rear.

Install the brake master cylinders. See the [Master Cylinders](#) topic for more information.

Bar Ends



Install the bar ends with a 6 mm Allen.

Install the front cover. See the [Front Cover](#) topic for more information.

Install the handlebar covers. See the [Handlebar Covers](#) topic for more information.

Check the throttle free play. See the [Throttle Free Play](#) topic for more information.

Brakes

This chapter covers the location and servicing of the brake system components for the **KYMCO G-Dink 125i**.

- Master Cylinders 2-10
- Front Caliper 11-18
- Discs Brakes 19-25
- Brake Pad Replacement 26-35

GENERAL INSTRUCTIONS

- During servicing, keep oil or grease off the brake pads and brake disk.

TROUBLESHOOTING

Poor brake performance

- Worn brake pads
- Contaminated brake pad surface
- Deformed brake disk
- Air in brake system
- Deteriorated brake fluid
- Worn brake master cylinder piston oil seal
- Clogged brake fluid line
- Unevenly worn brake caliper

Master Cylinders

SAFETY FIRST: Protective gloves and eyewear are recommended at this point.

NOTE: Brake fluid is a corrosive chemical and can damage paints and some plastics. Avoid contact with skin.

Removal

The master cylinders for the front and rear brakes are essentially the same.

Remove the handlebar covers. See the [Handlebar](#) topic for more information.

Drain the brake fluid. See the [Brake Fluid](#) topic for more information.

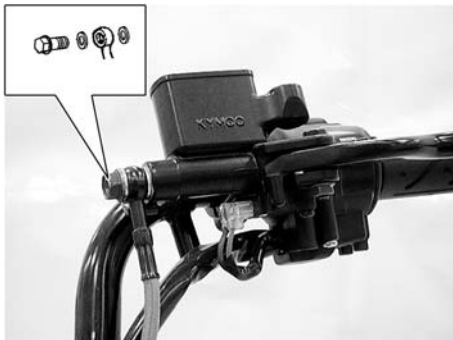

Remove the brake hose banjo bolt from the master cylinder using a 12 mm socket. Discard the sealing washers.



8. Brakes > Master Cylinders

Unplug the brake light switch connector.



Remove the two master cylinder mounting bolts with an 8 mm socket.



Remove the master cylinder clamp.



Remove the master cylinder.

8. Brakes > Master Cylinders

Remove the two master cylinder cover screws with a #2 Phillips head screwdriver.



Remove the master cylinder cover, plastic piece and rubber accordion diaphragm. Pour out any remaining brake fluid.

Disassembly**Brake Levers**

8. Brakes > Master Cylinders

Loosen the brake lever pivot nut with a 10 mm socket and the pivot bolt with a flat blade screwdriver.



Remove the pivot nut and bolt.

8. Brakes > Master Cylinders

Remove the brake lever.

Brake Light Switch

Remove the brake light switch mounting bolt with a #2 Phillips screwdriver. Remove the brake light switch.

Brake Light Switch

Install the brake light switch. Tighten the mounting screw securely with a #2 Phillips screwdriver.

Brake Levers

Install the brake lever.

8. Brakes > Master Cylinders

Apply a light coat of grease to brake lever pivot bolt. Insert the pivot bolt from above and thread on the nut.



Tighten the brake lever bolt with a flat blade screwdriver and then tighten the nut with a 10 mm socket.

Installation

Position the master cylinder on the handlebar.

8. Brakes > Master Cylinders

Install the master cylinder clamp. Be sure to insert the pin on the clamp into the hole on the handlebar.



Install the two master cylinder mounting bolts and tighten them securely with an 8 mm socket.

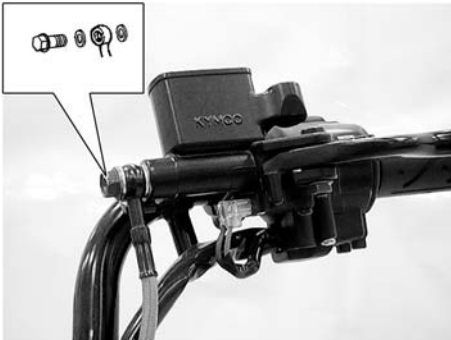

Plug in the brake light switch connector.

8. Brakes > Master Cylinders

Install the brake hose to the master cylinder with the banjo bolt. Use new sealing washers. Tighten the banjo bolt to specification with a 12 mm socket.

Item	Torque	
	N-m	lb-ft
Banjo bolt	35	25.8

Fill the master cylinder reservoir/s with brake fluid and bleed the system. See the [Brake Fluid](#) topic for more information.

Install the handlebar covers. See the [Handlebar](#) topic for more information.

Front Caliper

SAFETY FIRST: Protective gloves and eyewear are recommended at this point.

Removal

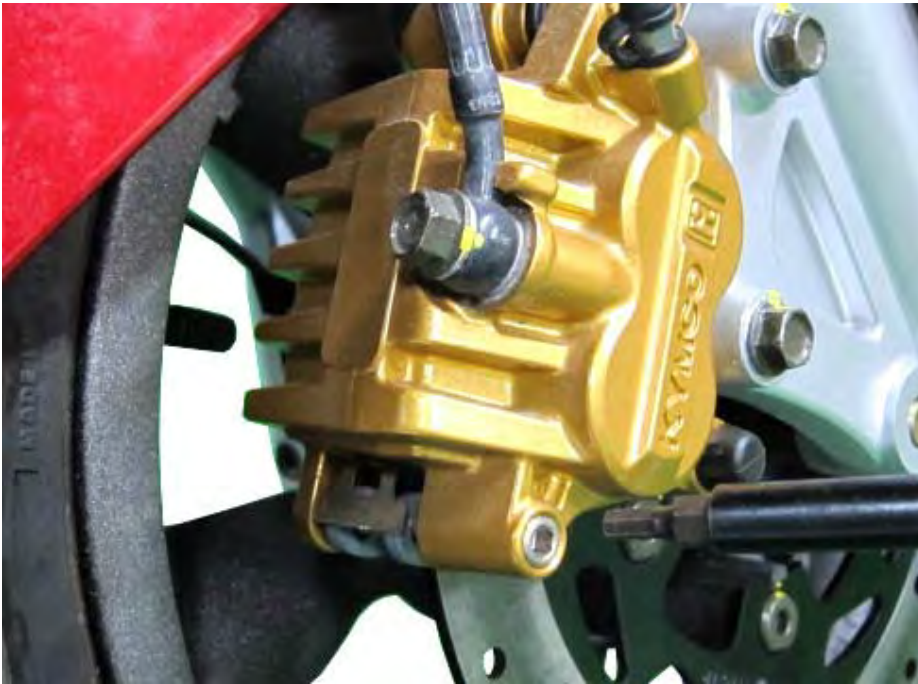

Loosen the brake pad pin with a 5 mm Allen.

Drain the brake fluid if the caliper is to be disassembled. See the [Brake Fluid](#) topic for more information.

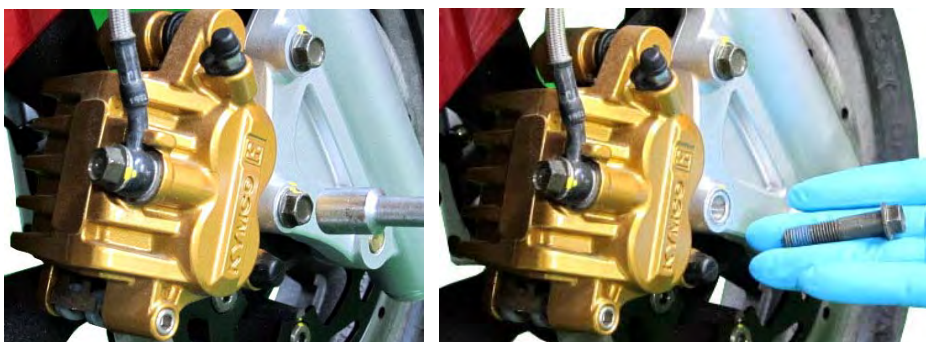

Remove the two caliper mounting bolts with a 12 mm socket.

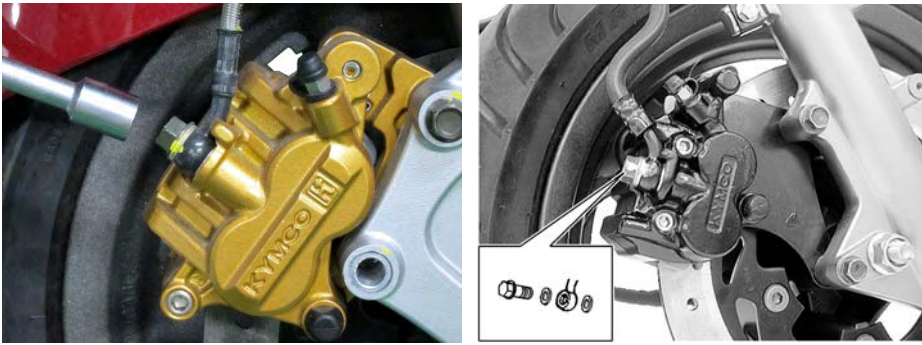
8. Brakes > Front Brake Caliper

Place a suitable container under the banjo bolt to catch any remaining brake fluid. Remove the banjo bolt that holds the brake hose to the caliper using a 12 mm socket. Discard the two sealing washers.

Replace the brake hose banjo bolt sealing washers with new items on assembly.



Remove the front caliper.

8. Brakes > Front Brake Caliper**Brake Pad Removal**

Remove the brake pad pin.

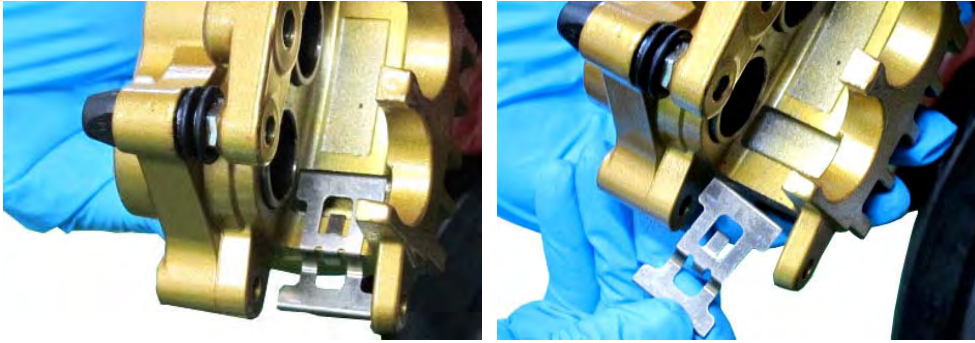

Remove the brake pads. Replace the pads if the brake wear exceeds the wear indicator lines or if the wear is uneven.

8. Brakes > Front Brake Caliper**Disassembly**

Remove the pad spring.

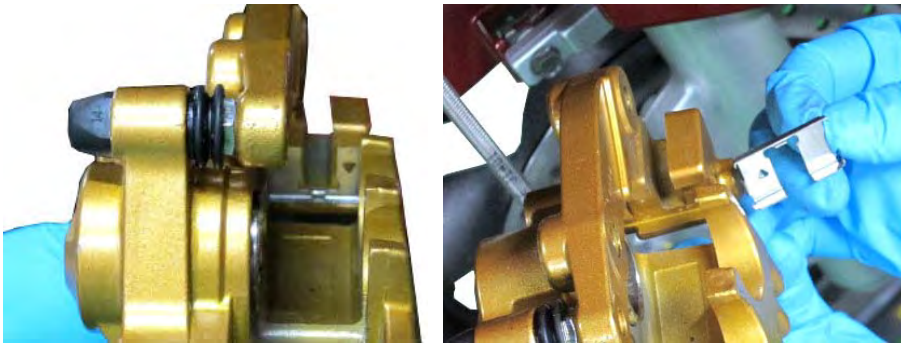

Remove the pad retainer from the brake caliper bracket.



Place a 1/4" thick strip of wood or a shop rag between the caliper pistons and the inside surface of the brake caliper. Blow compressed air into the banjo bolt opening to remove the caliper pistons. The pistons are a tight fit in the brake caliper and will pop out with a lot of force. Do not place your fingers over the caliper pistons while removing them as serious injury could result.

NOTE: Always wear safety glasses when using compressed air and never point it directly at yourself or anyone else.

8. Brakes > Front Brake Caliper

Assembly

NOTE: Brake fluid is a corrosive chemical and can damage paints and some plastics. Avoid contact with skin.

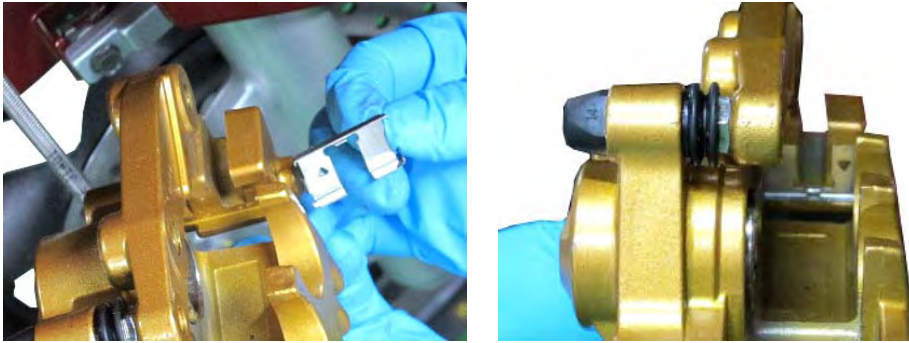

Install the pad retainer clip onto the caliper bracket.

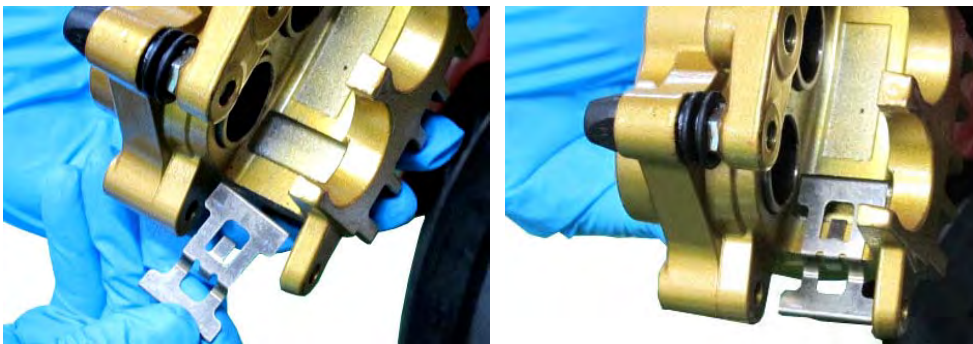

Install the brake pad spring as shown. Note the long middle tab on the spring points toward the caliper pistons.

Brake Pad Installation



Insert the brake pads into the caliper.

8. Brakes > Front Brake Caliper



Fit the ends of the pads into the pad retainer as shown.

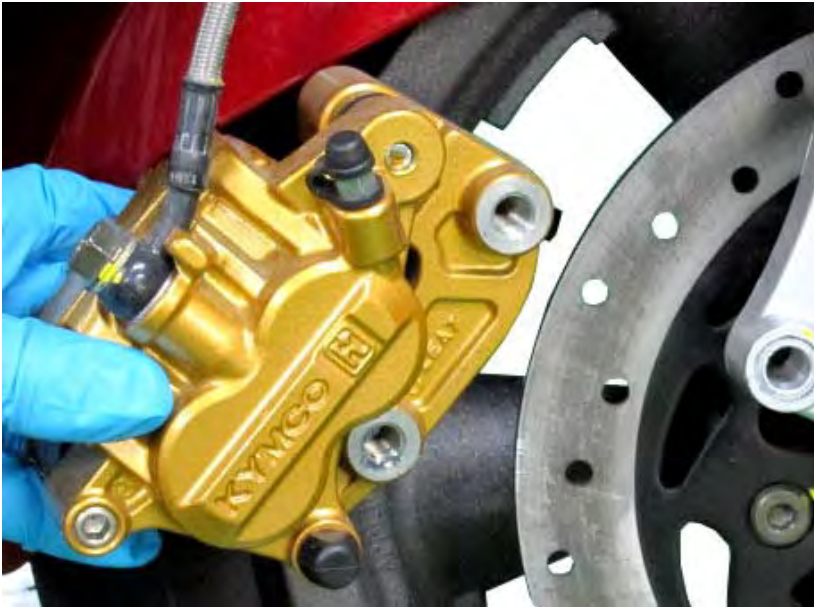

Apply a light coat of waterproof grease to the brake pad pin. Push the pads against the pad spring and insert the brake pad pin.

8. Brakes > Front Brake Caliper
Installation

Install the front caliper. Guide the brake disc between the pads. Line up the caliper bracket mounts with the fork.



Install the two caliper bracket mounting bolts. Tighten the mounting bolts to specification.

Item	Torque	
	N-m	lb-ft
Front/Rear caliper bolt	35	25.8

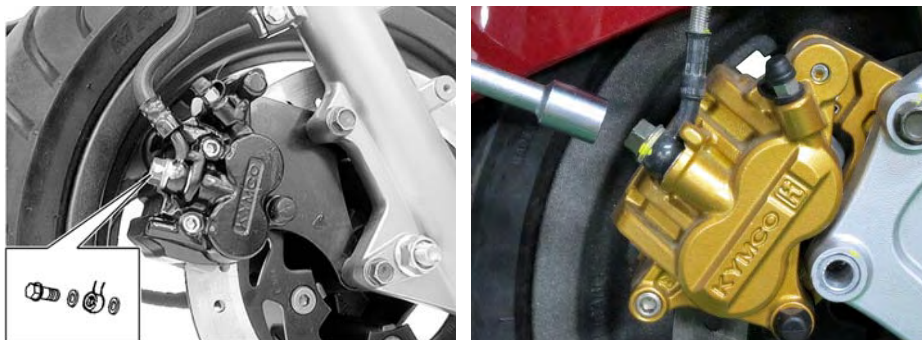

Install the banjo bolt with new sealing washers and tighten to specification with a 12 mm socket.

8. Brakes > Front Brake Caliper

Item	Torque	
	N-m	lb-ft
Banjo bolt	35	25.8

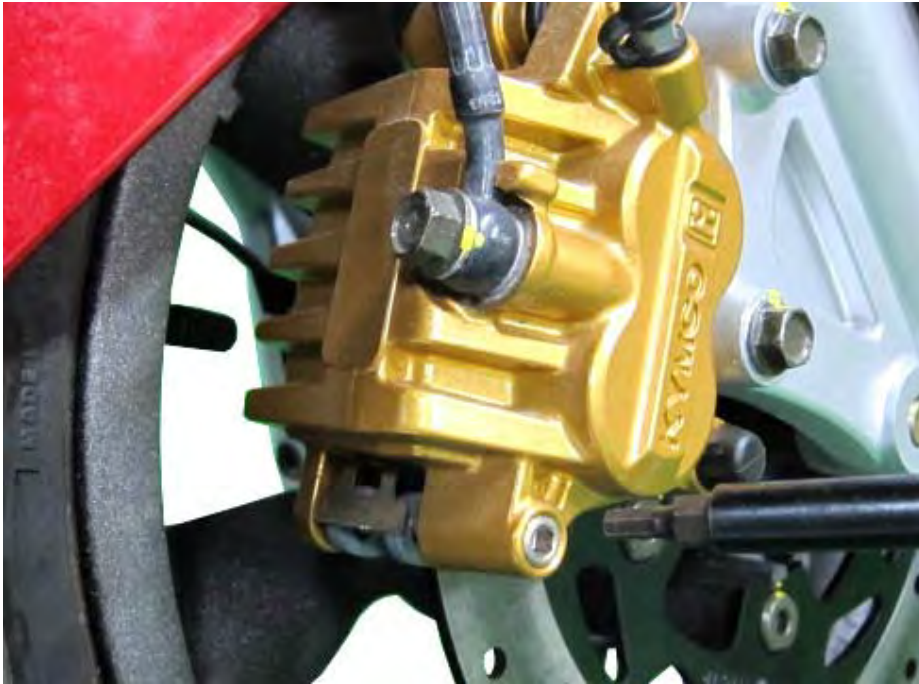

Tighten the brake pad pin securely with a 5 mm Allen.

Refill and bleed the brake fluid. See the [Brake Fluid](#) topic for more information.

Pump the brake lever to seat the caliper pistons against the pads. Check the operation on the brakes before returning the vehicle to service.

Disc Brake

SAFETY FIRST: Protective gloves and eyewear are recommended at this point.

Inspection



Measure the thickness of the brake rotor with a Vernire caliper or micrometer.

ITEM	STANDARD	SERVICE LIMIT
Brake disc thickness	4±0.2mm (0.16±0.008in)	3.7mm (0.15in)

8. Brakes > Brake Disc

Check if the brake rotor runout is within service limit.

Measure the runout of the brake disc with a dial gauge. If the reading is out of specification remove the disc from the wheel and recheck.

Item	Standard (mm)
Rear brake disk runout	max 0.4

Front
Removal

Remove the front wheel. See the [Front Wheel](#) topic for more information.



8. Brakes > Brake Disc

Remove the five brake disc mounting bolts with an Allen wrench.



Remove the front brake disc.

8. Brakes > Brake Disc

Inspect the brake disc for wear and damage. Replace the parts as needed.



Set the front brake disc in place on the front wheel.

Installation

Coat the threads of the disc bolts in a non-permanent thread locking agent. Thread in the bolts and torque them to specification with an Allen socket.

8. Brakes > Brake Disc

Insert the front brake disc mounting bolts. Tighten the bolts to specification with an Allen socket.

Item	Qty	Thread size (mm)	Torque	
			kgf-m	lb-ft
Disk bolt	5	8	3.2-3.8	23.15-27.48

Install the front wheel. See the [Front Wheel](#) topic for more information.

Rear

Removal



8. Brakes > Brake Disc

Remove the five brake disc mounting bolts with an Allen wrench.



Lift the brake disc off of the rear wheel.

8. Brakes > Brake Disc
Installation

Coat the threads of the disc bolts in a non-permanent thread locking agent. Thread in the bolts and torque them to specification with an Allen socket.



Set the rear brake disc in place as shown.



Insert the five rear brake disc mounting bolts and tighten them to specification with an Allen socket.

Item	Qty	Thread size (mm)	Torque	
			kgf-m	lb-ft
Disk bolt	5	8	3.2-3.8	23.15-27.48

Install the rear wheel. See the [Rear Wheel](#) topic for more information.

Brake Pad Replacement

SAFETY FIRST: Protective gloves and eyewear are recommended at this point.



Replace the pads if the brake wear exceeds the wear indicator lines or if the wear is uneven.

Front

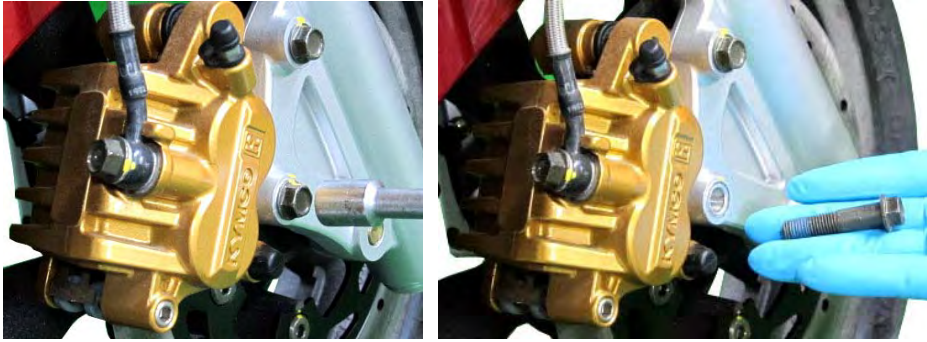

Loosen the brake pad pin with a 5 mm Allen.

8. Brakes > Brake Pad Replacement

Remove the two caliper mounting bolts with a 12 mm socket.

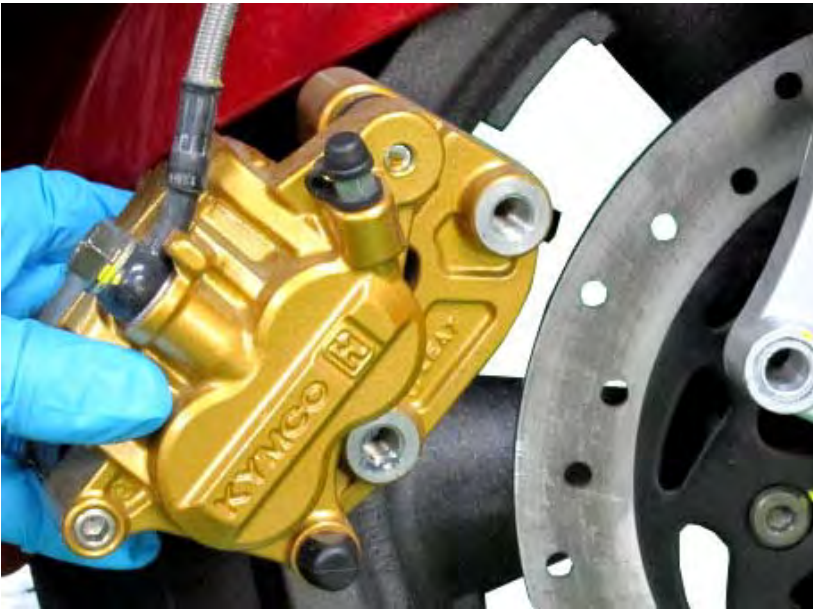

Remove the front caliper.



Remove the brake pad pin.

8. Brakes > Brake Pad Replacement

Remove the brake pads. Replace the pads if the brake wear exceeds the wear indicator lines or if the wear is uneven. Insert new brake pads as needed.



Fit the ends of the pads into the pad retainer as shown.

8. Brakes > Brake Pad Replacement

Apply a light coat of waterproof grease to the brake pad pin. Push the pads against the pad spring and insert the brake pad pin.

It may be necessary to spread the pads and force the pistons back into the caliper in order to allow room for the brake disc to fit between the new pads.

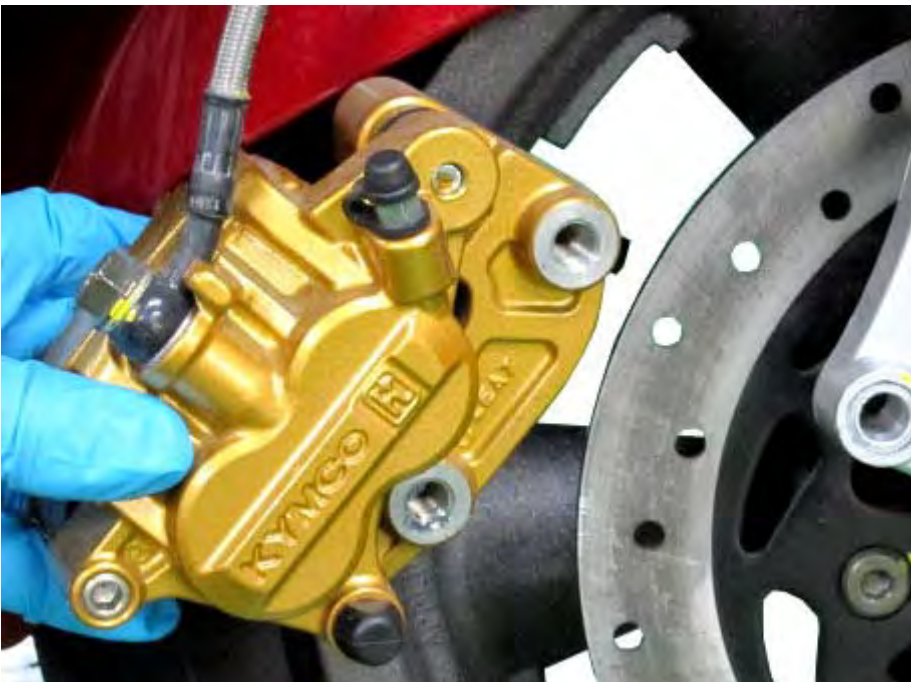

Install the front caliper. Guide the brake disc between the pads. Line up the caliper bracket mounts with the fork.

8. Brakes > Brake Pad Replacement

Install the two caliper bracket mounting bolts. Tighten the mounting bolts to specification.

--	--	--

Item	Torque	
	N-m	lb-ft
Front/Rear caliper bolt	35	25.8

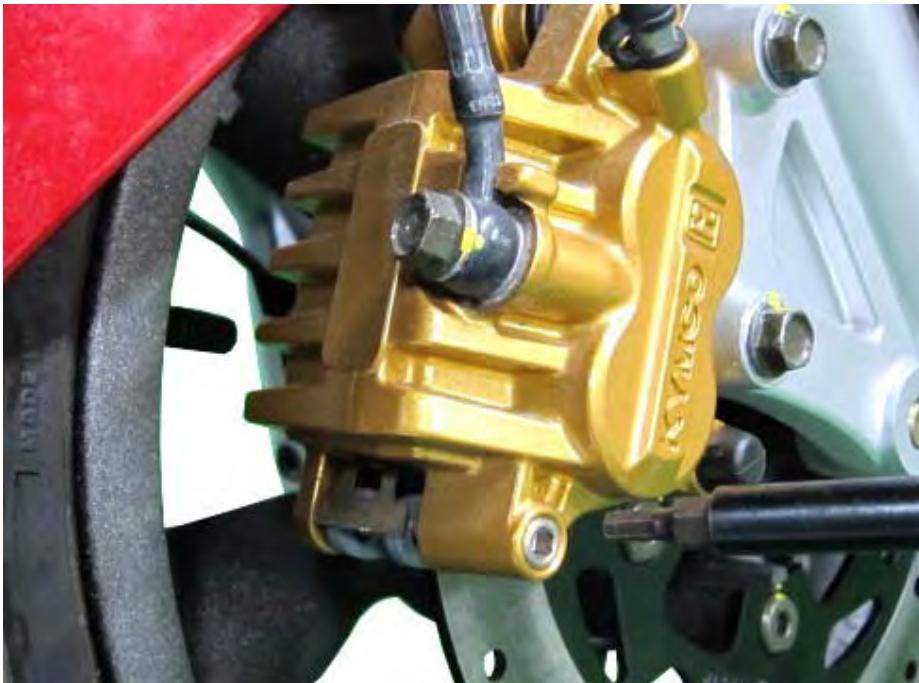

Tighten the brake pad pin securely with a 5 mm Allen.

Pump the brake lever to seat the caliper pistons against the pads.
Check the operation on the brakes before returning the vehicle to service.

8. Brakes > Brake Pad Replacement

Rear

Remove the muffler. See the [Exhaust System](#) topic for more information.

If the caliper is to be disassembled the brake hose must be removed. Drain the rear brake fluid. See the [Brake Fluid](#) topic for more information.

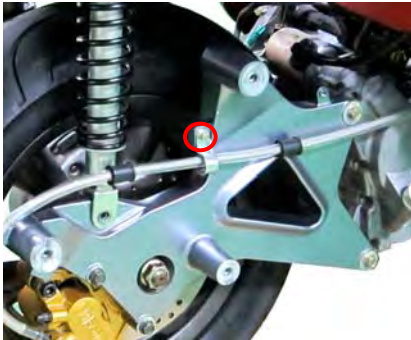

Remove the rear brake hose clamp bolts with a 8 mm socket.

Remove the rear brake hose clamp.

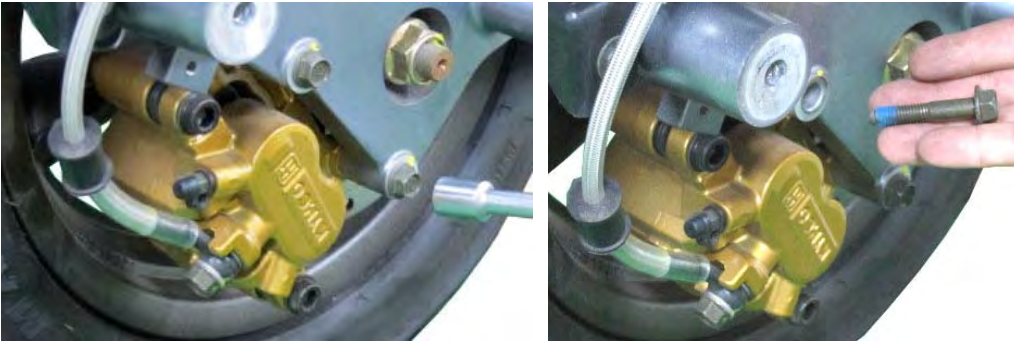

8. Brakes > Brake Pad Replacement

Remove the two rear caliper mounting bolts with a 12 mm socket.



Remove the rear caliper from the swingarm.



One at a time, move the brake pads to the center gap in the pad retainers and lift the pad out. If needed, use the piston side pad to push the pistons in to allow for more room.

8. Brakes > Brake Pad Replacement



Replace the pads if the brake wear exceeds the wear indicator lines or if the wear is uneven.

One at a time, fit the brake pads into the center gap in the pad retainers and then move the pad into the retainer. If needed, use the piston side pad to push the pistons in to allow for more room.

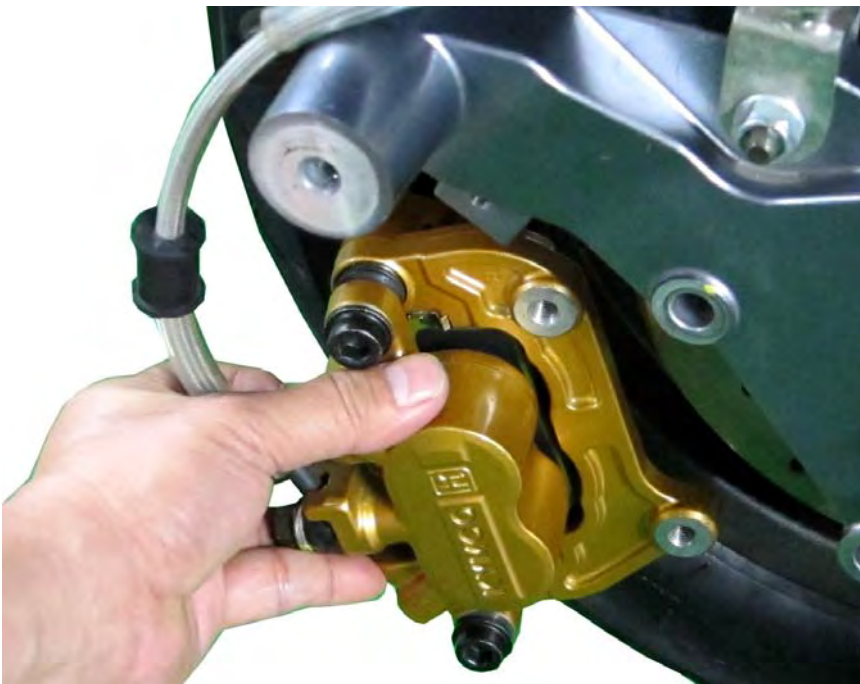

Install the rear caliper onto the swingarm.

8. Brakes > Brake Pad Replacement

Install the two caliper bracket mounting bolts. Tighten the mounting bolts to specification.

Item	Torque	
	N-m	lb-ft
Front/Rear caliper bolt	35	25.8

8. Brakes > Brake Pad Replacement

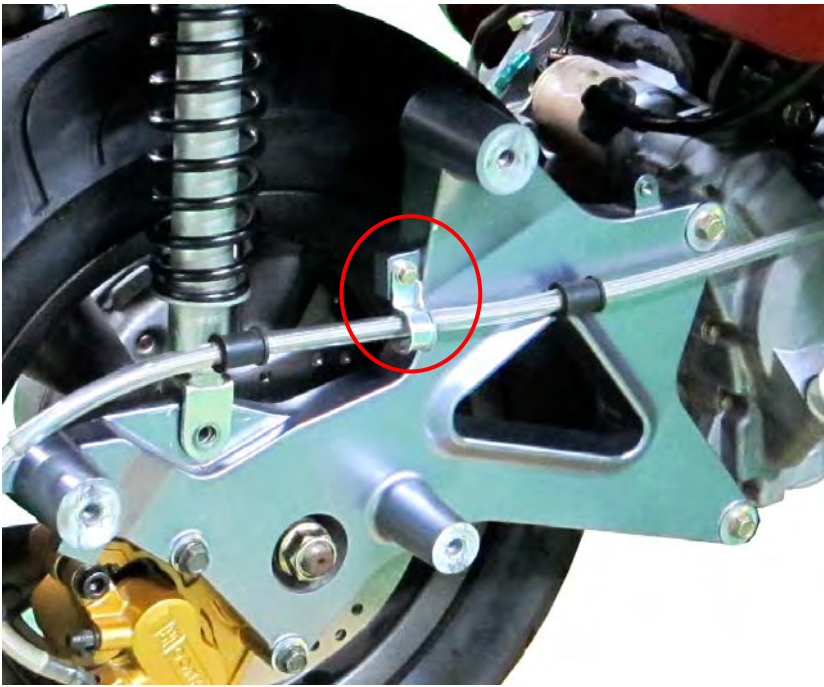

Fit the rear brake hose guide into place.

Insert the rear brake hose clamp bolts and tighten them securely with a 8mm socket.

Fill the rear brake system with fresh brake fluid and bleed out the air. See the [Brake Fluid](#) topic for more information.

Pump the brake lever to seat the caliper pistons against the pads. Check the operation on the brakes before returning the vehicle to service.

Install the muffler. See the [Exhaust System](#) topic for more information.

9. Front Suspension

Front Suspension

This chapter covers the location and servicing of the front fork components for the KYMCO G-Dink 125i.

- Front Fork Removal and Installation 2-5
- Fork Disassembly 6-15
- Fork Assembly 16-22

TROUBLESHOOTING

Soft front shock absorber

- Weak shock springs
- Insufficient damper oil

Front shock absorber noise

- Slider bending
- Loose fork fasteners
- Lack of lubrication

Front Fork Removal and Installation

SAFETY FIRST: Protective gloves and eyewear are recommended at this point.

Removal

Remove the front cover. See the [Front Cover](#) topic for more information.

Remove the front fender. See the [Front Fender](#) topic for more information.



Remove the front brake caliper. See the [Front Caliper](#) topic for more information.

Remove the front wheel. See the [Front Wheel](#) topic for more information.

9. Front Suspension > Front Fork Removal



Loosen the fork clamp pinch bolts with a 12 mm socket. The top bolts must be removed.



Slide the forks legs down and out of the fork clamp using a twisting motion.

To disassemble the forks see the [Front Fork Disassembly](#) topic for more information.

9. Front Suspension > Front Fork Removal

Installation



Slide the fork legs up into fork clamp using a twisting motion.



Install the fork legs so that the upper fork clamp bolt hole lines up with the groove on the inner fork tube. Insert the fork clamp upper bolt.

9. Front Suspension > Front Fork Removal



Tighten the fork clamp bolts securely and evenly with a 12 mm socket.

Install the front wheel. See the [Front Wheel](#) topic for more information.

Install the front brake caliper. See the [Front Caliper](#) topic for more information.

Install the front fender. See the [Front Fender](#) topic for more information.

Install the front cover. See the [Front Cover](#) topic for more information.

Fork Disassembly

SAFETY FIRST: Protective gloves and eyewear are recommended at this point.

Remove the front forks. See the [Front Fork Removal and Installation](#) topic for more information.

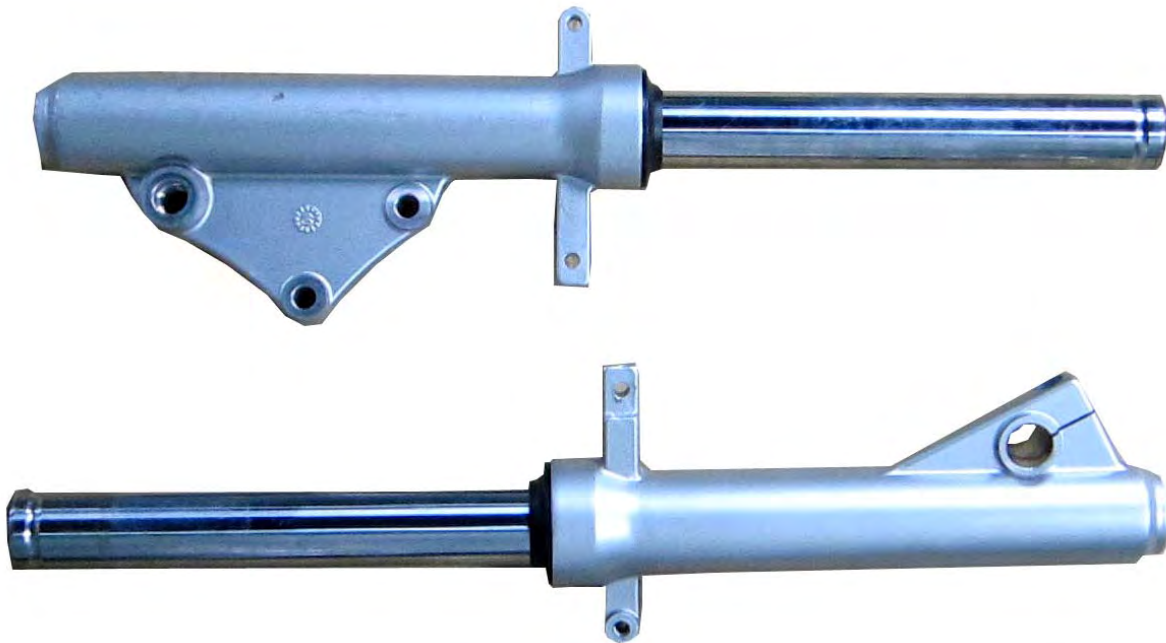

Clean the outside of the forks before disassembly and inspect them for any cracks, dents or other damage.

9. Front Suspension > Fork Disassembly

Remove the rubber fork cap.



Place the fork leg in a soft jawed vice.



Push down on the top plug and remove the snap ring.

9. Front Suspension > Fork Disassembly

Remove the top plug.



Lift out the fork spring.



Dump the fork oil into a suitable container. Pump the fork through its stroke several times to free as much oil as possible. Hold the fork inverted for several minutes to let the oil drain completely.

9. Front Suspension > Fork Disassembly

Use a flat blade screwdriver to pop the dust seal out of the fork slider. Take care to avoid scratching the fork tube.



Use a small flat blade screwdriver to pry out the fork oil seal stopper ring. Take care to avoid scratching the fork tube.



Slide off the stopper ring.

9. Front Suspension > Fork Disassembly



Place the axle holder of the outer fork tube in a soft jawed.



Insert an 8 mm Allen socket into the damper rod. Hold the damper rod and loosen the fork bottom bolt with an 8 mm Allen wrench.



Remove the fork bottom bolt from the bottom of the fork slider. Discard the sealing washer.

9. Front Suspension > Fork Disassembly

Separate the inner and outer fork tubes by pulling them apart using a slide hammer motion.



Remove the oil lock piece. The oil lock piece may come out with the damper rod in the inner fork tube or it may be left in the slider.



Remove the damper rod and rebound spring.

9. Front Suspension > Fork Disassembly

Inspect the oil seal and the bushing in the fork slider.



Place a rag across the top of the fork slider and pry out the oil seal as shown.



Remove the oil seal and spacer from the fork slider.

Inspection

Inspect the top plug O-ring O-ring and replace it if needed.

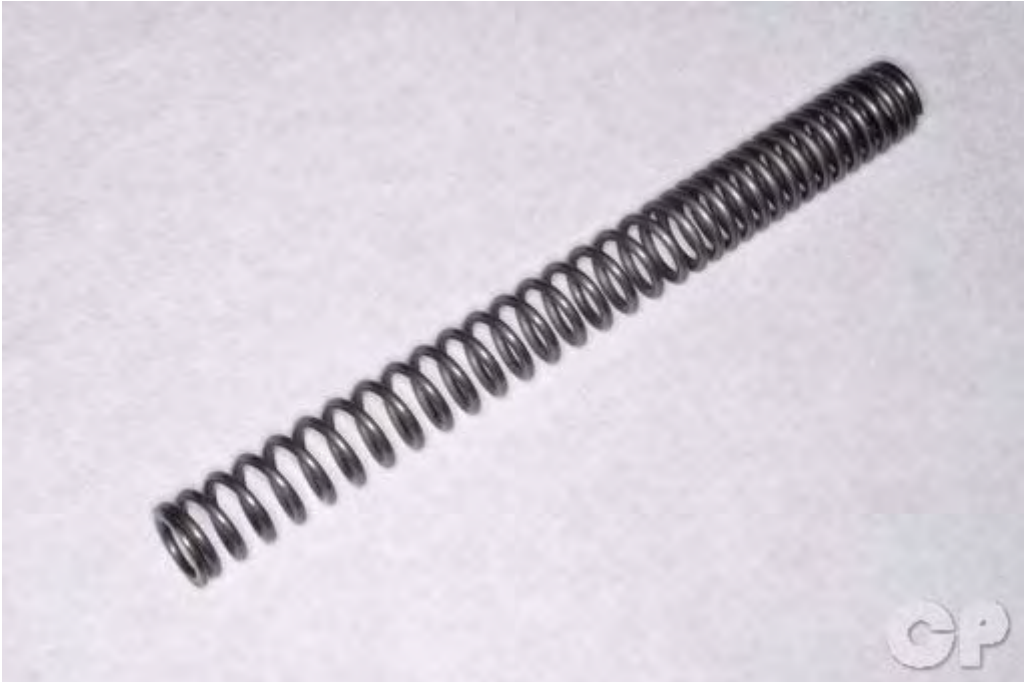

Inspect the slider bushing and replace it as needed.

9. Front Suspension > Fork Disassembly

Inspect the fork springs for signs of fatigue. Replace the fork springs if they vary dramatically in length.



Inspect the damper rod and seal. Replace the components as needed.

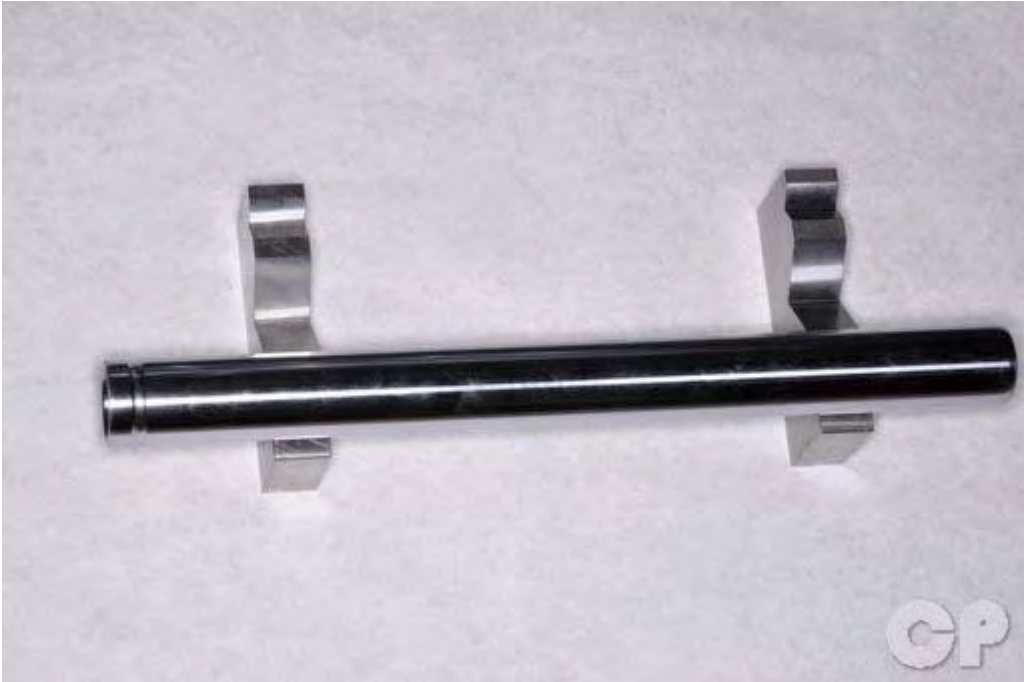

Inspect the inner fork tube for bends and damage. Replace it as needed.

For assembly see the [Fork Assembly](#) topic.

Fork Assembly

SAFETY FIRST: Protective gloves and eyewear are recommended at this point.

Clean all of the fork components with aerosol brake cleaner and a lint free cloth. Coat the bushing and seals with fork oil before installation.



Drive the fork slider bushing into the slider with a suitable driver with the same outside diameter as the bushing.



Insert the damper rod with rebound spring into the inner fork tube. Place the fork oil lock piece on the end of the damper rod.

Slide the dust seal, oil seal stopper ring and oil seal onto the bottom of the inner fork tube.



Place the spacer into the fork slider.



Insert the inner fork tube into the inner fork tube.



Place a new sealing washer on the fork bottom bolt. Insert the fork bottom bolt into the bottom the fork slider and thread it into the damper rod.



Place the axle holder of the outer fork tube in a soft jawed.



Insert an 8 mm Allen socket into the damper rod. Hold the damper rod and tighten the fork bottom bolt securely with an 8 mm Allen wrench.



Drive in the fork oil seal with the fork seal driver.



Insert the stopper ring into its groove.



Install the dust seal securely into the outer fork tube.

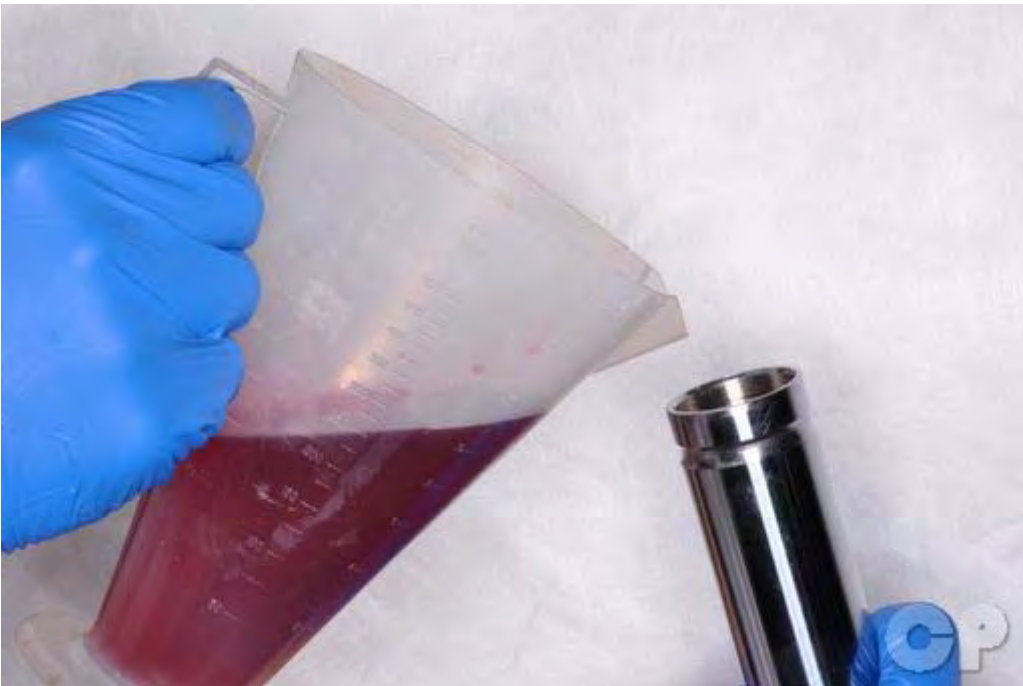

Compress the fork tube all the way. Fill the fork tube with the specified quantity of fork oil 145 ± 1 cc. Use fork oil type SS#8 (10W).

Pump the fork slowly through its stroke several times to release any trapped air.



Fully extend the fork and insert the fork spring with its tightly coiled end facing down towards the axle.



Lubricate the top plug O-ring with fresh fork oil and insert the plug into the top of the inner fork tube as shown.



Push the top plug down against the spring and install the stopper ring into its groove. Release the pressure on the top plug and make sure the plug seats against the ring.



Install the rubber fork cap.



Fit the fork protectors into place so that they face forward.

Install the front fork. See the [Front Fork Removal and Installation](#) topic for more information.

Rear Suspension

This chapter provides information on the rear suspension components of the KYMCO G-Dink 125i.

- Shock Absorbers 2-8
- Swingarm 9-13

TROUBLESHOOTING

Soft rear shock absorber

- Weak shock absorber spring
- Damper oil leaks

Shock Absorbers

SAFETY FIRST: Protective gloves and eyewear are recommended at this point.

Pre-Load Setting



Each shock absorber on the scooter has 5 spring preload adjustment positions for different load or riding conditions.

Position 1 is for light loads and smooth road conditions. Position 3 to 5 increase spring preload for stiffer rear suspension and can be used when the scooters heavily loaded. Be certain to adjust both shock absorbers to the same spring preload positions.

Use a pin spanner to adjust the rear shock spring preload. The shock absorbers are adjustable for pre-load. There are 5 settings. Position 1 is the softest and 5 is the stiffest.

Caution: Always adjust the shock absorber pre-load position in sequence (1-2-3-4-5 or 5-4-3-2-1). Attempting to adjust directly from 1 to 5 or 5 to 1 may damage the shock absorber.

(Pre-Load Standard Setting: Position 2)

10. Rear Suspension > Shock Absorbers

Removal

Place the vehicle on its center stand.

Remove the seat. See the [Seat](#) topic for more information.

Remove the rear carrier. See the [Rear Carrier](#) topic for more information.

Remove the body cover to access the upper shock absorber mounts. See the [Body Cover](#) topic for more information.

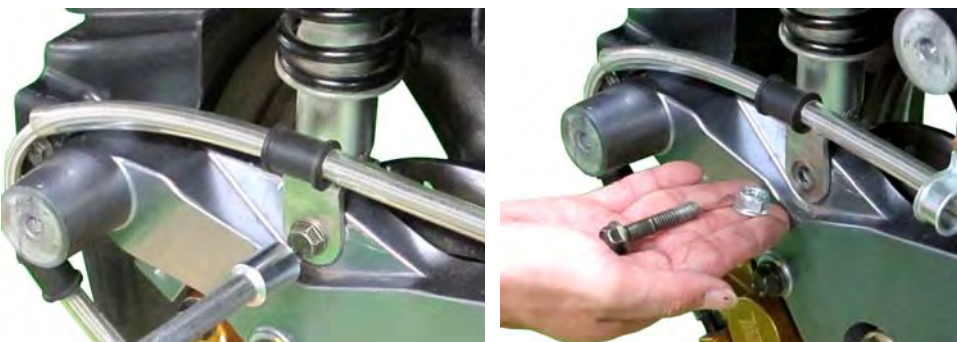

Remove the right side rear shock mounting bolt and nut with a 12 mm socket.

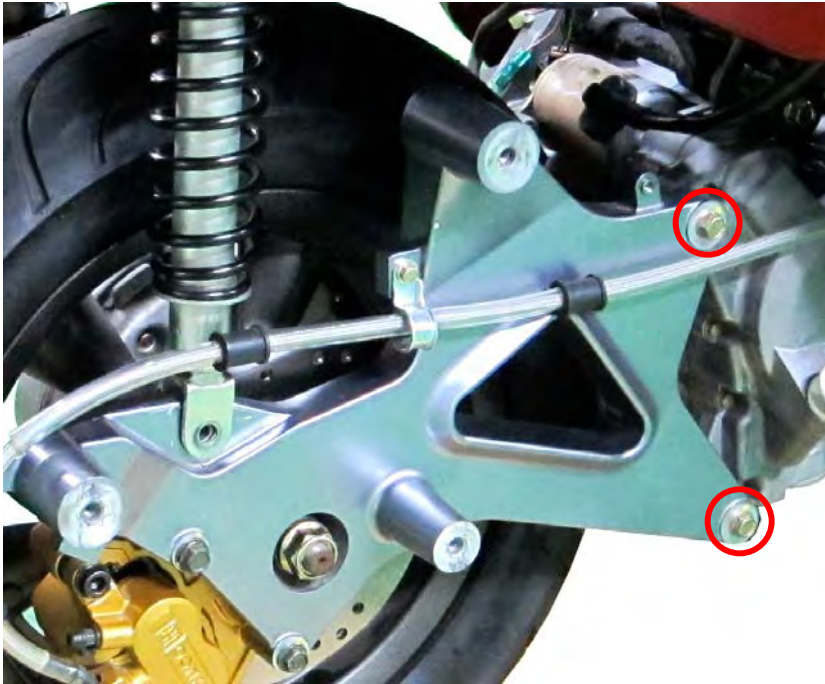
10. Rear Suspension > Shock Absorbers

Remove the two Swingarm mounting bolt with a 12 mm socket.



Remove the upper shock absorber mounting bolt with a 14 mm & 17mm socket. Free the shock absorber from the frame.



10. Rear Suspension > Shock Absorbers



Remove the left shock absorber in the same manner as the right.

Inspect the shock absorbers for wear and damage. Replace the shock absorbers as needed.

Check over the shock absorber for damage and oil leaks. Replace the shock absorber if needed. Do not attempt to disassemble the shock absorber.

Installation



Fit the shock absorber into place. Make sure the preload arrow indicator faces out from the lower mount.

10. Rear Suspension > Shock Absorbers

Install the upper shock absorber mounting bolt&nut and torque it to specification with a 14 mm & 17 mm socket.

Item	Torque	
	kgf-m	lb-ft
Shock absorber mounting bolt	4	28.93

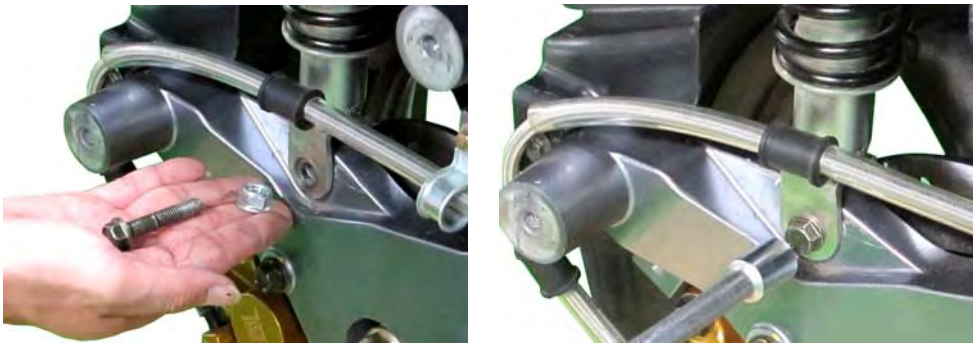

10. Rear Suspension > Shock Absorbers

Install the lower shock absorber mounting bolt&nut and torque it to specification with a 12 mm socket.

Item	Torque	
	kgf-m	lb-ft
Shock absorber mounting bolt	2.7	19.44



Install the other shock absorber in the same manner.

10. Rear Suspension > Shock Absorbers

Install the rear carrier. See the [Rear Carrier](#) topic for more information.

Install the luggage box. See the [Luggage Box](#) topic for more information.

Install the seat. See the [Seat](#) topic for more information.

10. Rear Suspension > Swingarm

Rear Fork

SAFETY FIRST: Protective gloves and eyewear are recommended at this point.

Removal

Place the vehicle on its center stand.

Remove the muffler. See the [Exhaust System](#) topic for more information.

Remove the rear fender. See the [Rear Fender](#) topic for more information.

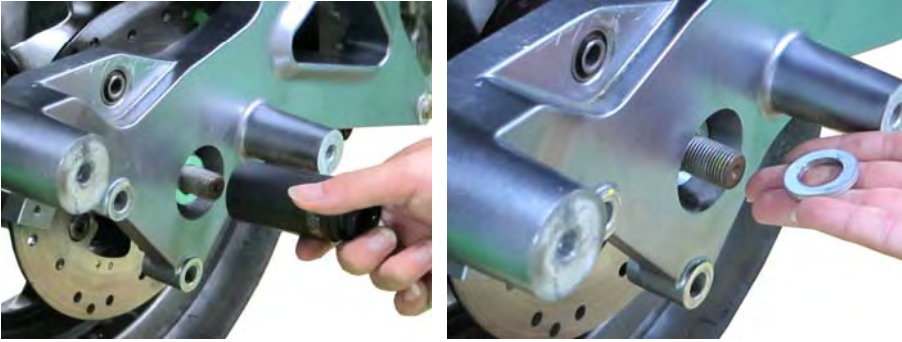

Remove the right side rear shock mounting bolt with a 12 mm socket.

10. Rear Suspension > Swingarm

Hold the rear brake to keep the rear wheel from turning. Remove the rear axle nut with a 24 mm socket.

Remove the rear brake caliper. See the [Rear Brake Caliper](#) topic for more information.

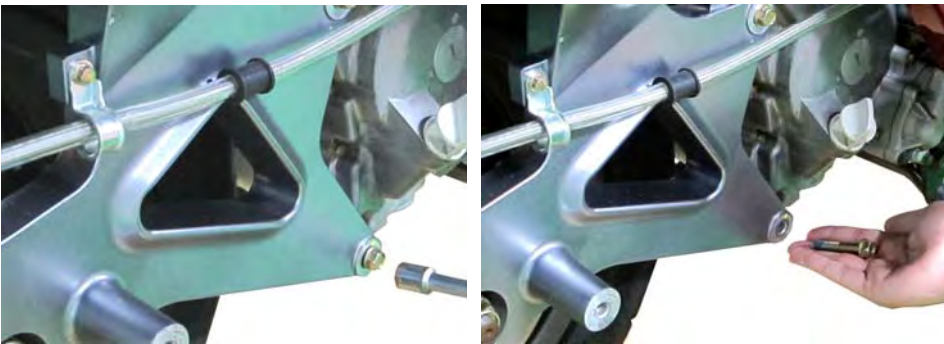

Remove the two rear fork bolts with a 12 mm socket.



Slide the rear fork out and remove it from the right side of the vehicle.

Inspect the rear fork for damage and replace it as needed.

10. Rear Suspension > Swingarm

Installation



Fit the rear fork into place.



Install the two rear fork mounting bolts and tighten them securely with a 12 mm socket.

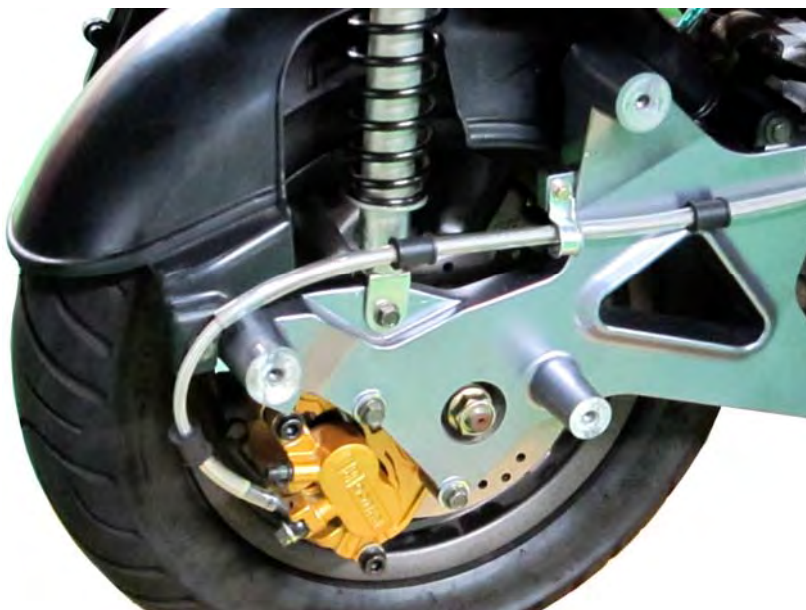

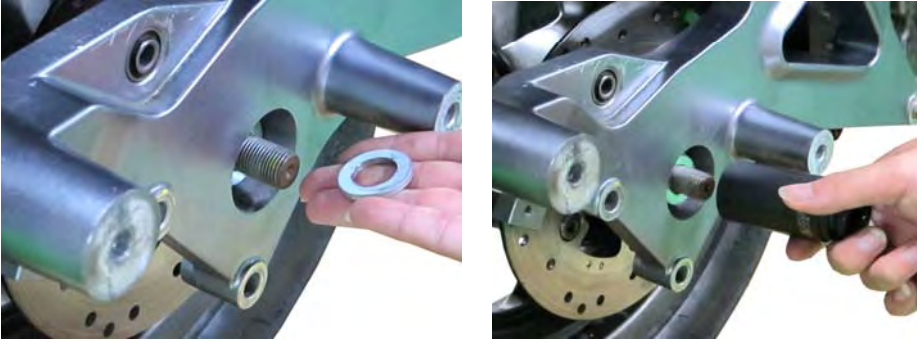
10. Rear Suspension > Swingarm

Install the rear axle nut and tighten it to specification with a 24 mm socket.

Item	Qty	Thread size (mm)	Torque		Remarks
			kgf-m	lb-ft	

10. Rear Suspension > Swingarm

Rear axle nut 1 16 11-13 79.56-94.03 U-nut

Install the rear brake caliper. See the [Rear Brake Caliper](#) topic for more information.



Install the rear fender. See the [Rear Fender](#) topic for more information.

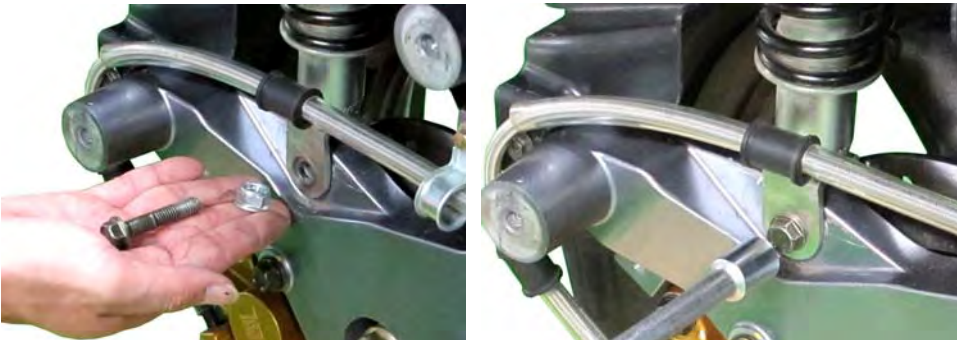

Install the lower shock absorber mounting bolt and torque it to specification with a 12 mm socket.

Item	Torque	
	kgf-m	lb-ft
Shock absorber mounting bolt	4	28.93

Install the muffler. See the [Exhaust System](#) topic for more information.

Electrical Systems

This chapter covers the location and servicing of the electrical systems for the KYMCO G-Dink 125i.

• <u>Battery</u>	6-10
• <u>Charging System</u>	11
• <u>Ignition System</u>	12-15
• <u>Starting System</u>	16-20
• <u>Starter Motor</u>	21
• <u>Fuses</u>	22
• <u>ECU Removal</u>	23-25
• <u>Self-Diagnosis</u>	26-31
• <u>Horn</u>	32
• <u>Lights</u>	33-40
• <u>Relays</u>	41-43
• <u>Switches</u>	44-56
• <u>Electrical Specification</u>	57
• <u>Wiring Diagrams</u>	58-60
• <u>Fuel Injection Diagnostic Report</u>	61

CHARGING SYSTEM AND BATTERY

GENERAL INSTRUCTIONS

- The battery can be charged and discharged repeatedly. If a discharged battery is not used for a long time, its service life will be shortened. Generally, the capacity of a battery will decrease after it is used for 2~3 years. A capacity-decreased battery will resume its voltage after it is recharged but its voltage decreases suddenly and then increases when a load is added.
- When a battery is overcharged, some symptoms can be found. If there is a short circuit inside the battery, no voltage is produced on the battery terminals. If the rectifier won't operate, the voltage will become too high and shorten the battery service life.
- If a battery is not used for a long time, it will discharge by itself and should be recharged every 3 months.
- A new battery filled with electrolyte will generate voltage within a certain time and it should be recharged when the capacity is insufficient. Recharging a new battery will prolong its service life.
- Inspect the charging system according to the sequence specified in the Troubleshooting.
- Do not disconnect and soon reconnect the power of any electrical equipment because the electronic parts in the regulator/rectifier will be damaged. Turn off the ignition switch before operation.
- It is not necessary to check the MF battery electrolyte or fill with distilled water.

11. Electrical Systems

- Check the load of the whole charging system.
- Do not quick charge the battery. Quick charging should only be done in an emergency.
- Remove the battery from the motorcycle for charging.
- When replacing the battery, do not use a traditional battery.
- When charging, check the voltage with an electric tester.

TROUBLESHOOTING

No power

- Dead battery
- Disconnected battery cable
- Fuse burned out
- Faulty ignition switch

Intermittent power

- Loose battery cable connection
- Loose charging system connection
- Loose connection or short circuit in the ignition system

Low power

- Weak battery
- Loose battery connection
- Charging system failure
- Faulty regulator/rectifier

Charging system failure

- Loose, broken or shorted wire or connector
- Faulty regulator/rectifier
- Faulty A.C. generator

IGNITION SYSTEM

GENERAL INSTRUCTIONS

- Some electrical components may be damaged if terminals or connectors are connected or disconnected while the ignition switch is "ON" and current is present.
- When servicing the ignition system, always follow the steps in the troubleshooting on page above.

11. Electrical Systems

- The ignition timing cannot be adjusted since the ignition control module is already adjusted in factory.
- The ignition control module or ECU maybe damaged if dropped or the connector is disconnected when the key is "ON", the excessive voltage may damage the ignition control module or ECU. Always turn off the ignition switch before servicing.
- A faulty ignition system is often related to poor connections. Check those connections before proceeding.
- Make sure the battery is adequately charged. Using the starter motor with weak battery results in a slower engine cranking speed as well as no spark at the spark plug.
- Use a spark plug of the correct heat range. Using spark plug with an incorrect heat range can damage the engine.

TROUBLESHOOTING

No peak voltage

- Short circuit in engine stop switch or ignition switch wire.
- Faulty engine stop switch or ignition switch.
- Loose or poorly connected ignition control module connectors.
- Open circuit or poor connection in ground wire of the ignition control module.
- Faulty crank position sensor.
- Faulty ignition control module.

Peak voltage is normal, but no spark jumps at the plug

- Faulty spark plug or leaking ignition coil secondary current.
- Faulty ignition coil.

Starting System

GENERAL INSTRUCTIONS

- The removal of starter motor can be accomplished with the engine installed.
- After the starter clutch is installed, be sure to add the engine oil and coolant and then bleed air from the cooling system.

TROUBLESHOOTING**Starter motor will not turn**

- Fuse burned out
- Weak battery
- Faulty ignition switch
- Faulty starter clutch or gear
- Faulty front or rear stop switch
- Faulty starter relay
- Poorly connected, broken or shorted wire
- Faulty starter motor

Lack of power

- Weak battery
- Loosed wire or connection
- Foreign matter stuck in starter motor

Starter motor rotates but engine does not start

- Faulty starter pinion
- Starter motor rotates in reverse
- Weak battery

LIGHTS, SWITCHES, AND FUEL PUMP**GENERAL INSTRUCTIONS**

- Note the following when replacing the halogen headlight bulb
 1. Wear clean gloves while replacing the bulb. Do not put finger prints on the headlight bulb, as they may create hot spots on the bulb and cause it to fail.
 2. If you touch the bulb with your bare hands, clean it with a cloth moistened with alcohol to prevent its early failure.
 3. Be sure to install the dust cover after replacing the bulb.
- Check the battery condition before performing any inspection that requires proper battery voltage.
- A continuity test can be made with the switches installed on the scooter.
- Route the wires and cables properly after servicing each component.

11. Electrical Systems

TROUBLESHOOTING

Lights do not come on when ignition switch is "ON"

- Burned bulb
- Faulty switch
- Poorly connected, broken or shorted wire

Temperature gauge does not register correctly

- Faulty temperature gauge
- Faulty thermosensor
- Broken or shorted wire between the temperature gauge and thermosensor

Fuel gauge does not work or shows wrong figures

- Faulty fuel gauge
- Faulty fuel unit
- Poorly connected wire between fuel gauge and fuel unit
- Fuse burned out

Battery

SAFETY FIRST: Protective gloves and eyewear are recommended at this point.

Warning: The battery electrolyte (sulfuric acid) is poisonous and may seriously damage the skin and eyes. Avoid contact with skin, eyes, or clothing. In case of contact, flush with water and get prompt medical attention.

Removal

Remove the seat. See the [Seat](#) topic for more information.

Remove the luggage box. See the [Luggage Box](#) topic for more information.

Screws

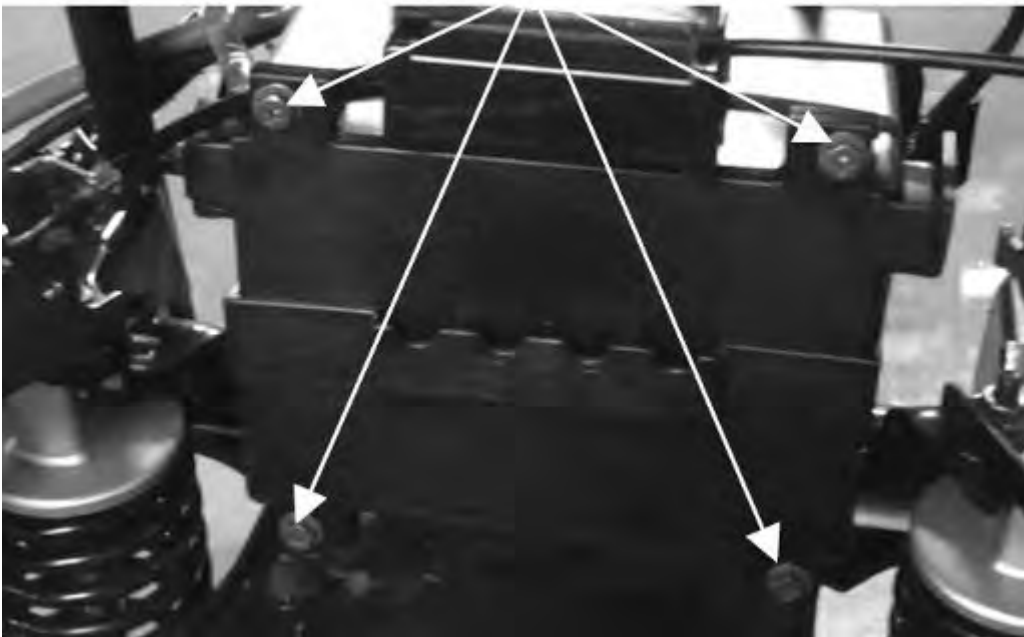

Remove the four battery cover screws. Remove the battery cover.

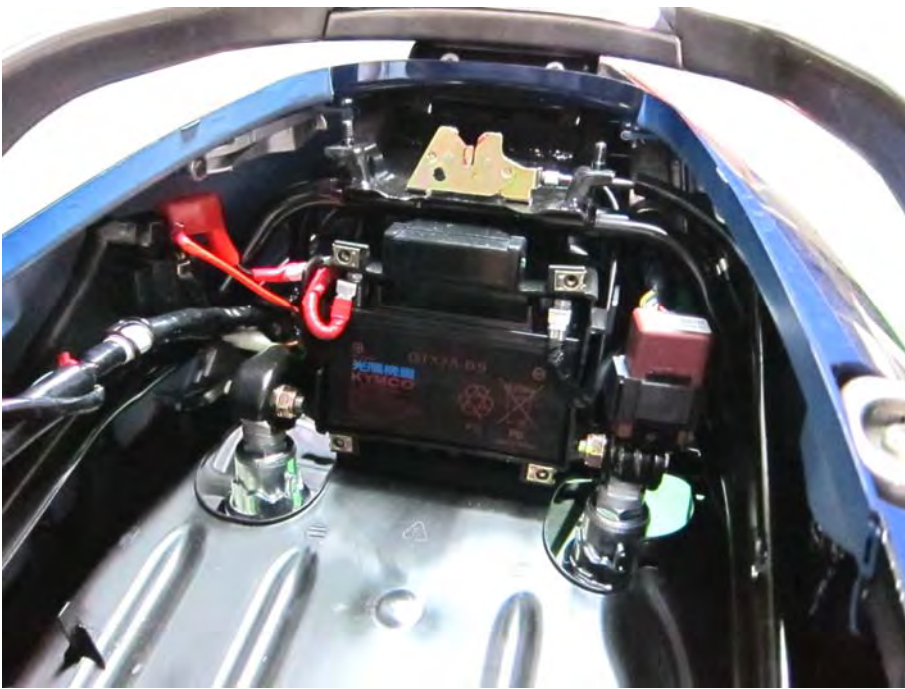
11. Electrical System > Battery

The battery is located in the back of the vehicle.



Remove the negative battery cable bolt with a 10 mm socket or #3 Phillips screwdriver. Free the negative cable from the battery.



Remove the positive battery cable bolt with a 10 mm socket or #3 Phillips screwdriver. Free the positive cable from the battery.

11. Electrical System > Battery

Lift the battery out of the battery tray.

Testing

Check the battery voltage with a multi-meter. Place the positive probe onto the positive battery terminal and the negative probe to the negative battery terminal. If the battery reads under 12.3 V it is undercharged.

Battery Voltage (20°C/68°F)	
Fully Charged	13.0 - 13.2 V

Installation

Only install the specified battery (8Ah).

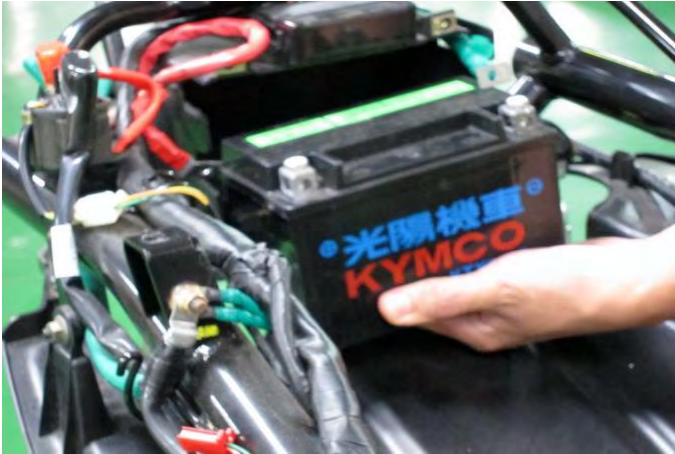
11. Electrical System > Battery

Fit the battery into the battery tray.



Connect the positive battery cable and install the bolt with a 10 mm socket or #3 Phillips screwdriver.



Connect the negative battery cable and install the bolt with a 10 mm socket or #3 Phillips screwdriver.

Screws

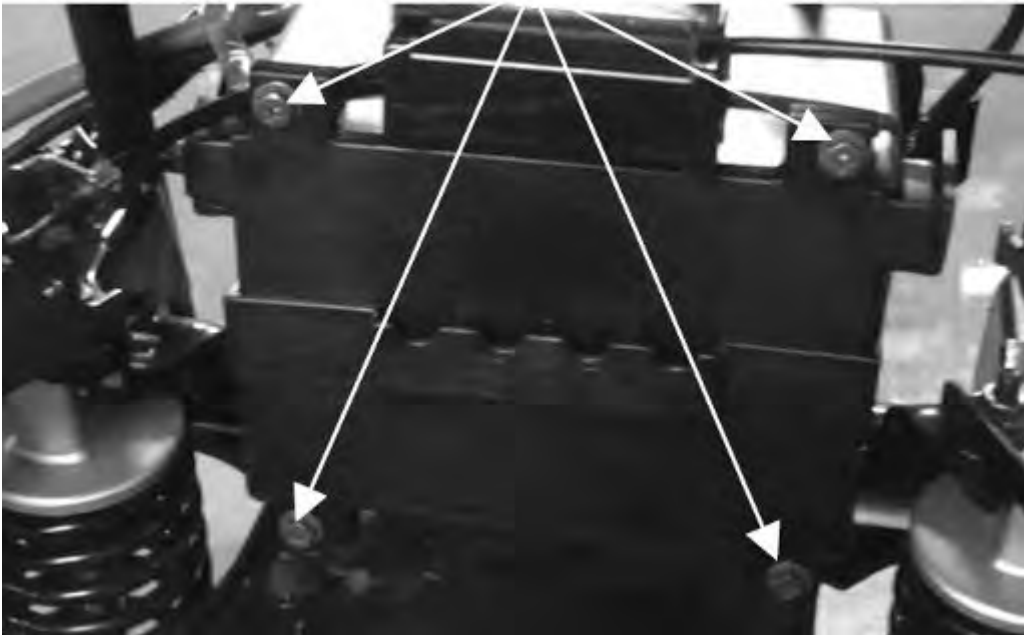

Install the battery cover. Install the four battery cover screws and tighten them securely.

Battery Charging

Charge the battery with a motorcycle specific battery charger at the specified rate. Connect the charger leads to their appropriate battery terminals. Keep open flames away from a charging battery.

Standard Charge	
0.9 Amps	5 - 10 Hours

Note: For battery charging, do not exceed the charging current and time specified on the battery. Using excessive current or extending the charging time may damage the battery.

Install the luggage box. See the [Luggage Box](#) topic for more information.

Install the seat. See the [Seat](#) topic for more information.

Charging System

SAFETY FIRST: Protective gloves and eyewear are recommended at this point.

You will need a digital multimeter to inspect the charging system.

Charging Voltage Inspection

Remove the battery cover. See the [Battery](#) topic for more information.

Note: The battery should be fully charged prior to making charging system checks.



Start the engine and warm it up to the operating temperature; stop the engine. Connect the multimeter between the positive (+) and negative (-) terminals of the battery. To prevent short, make absolutely certain which are the positive (+) and negative (-) terminals or cable.

With the headlight on and turned to the high beam position, restart the engine. Measure the voltage on the multimeter when the engine runs at 5000 rpm.

Battery charging voltage@ 5000 rpm	14 ~ 15V
------------------------------------	----------

Regulator/Rectifier

Remove the seat. See the [Seat](#) topic for more information.

Ignition System

SAFETY FIRST: Protective gloves and eyewear are recommended at this point.

The ignition timing is set at the factory and is not adjustable. Perform the following checks. Before performing any tests make sure the electrical connections are not loose or corroded.

Spark Test

Check the spark plug to see if it is the correct type and gapped properly. If the spark plug is black and fouled, replace it. See the [Spark Plug](#) topic for more information.

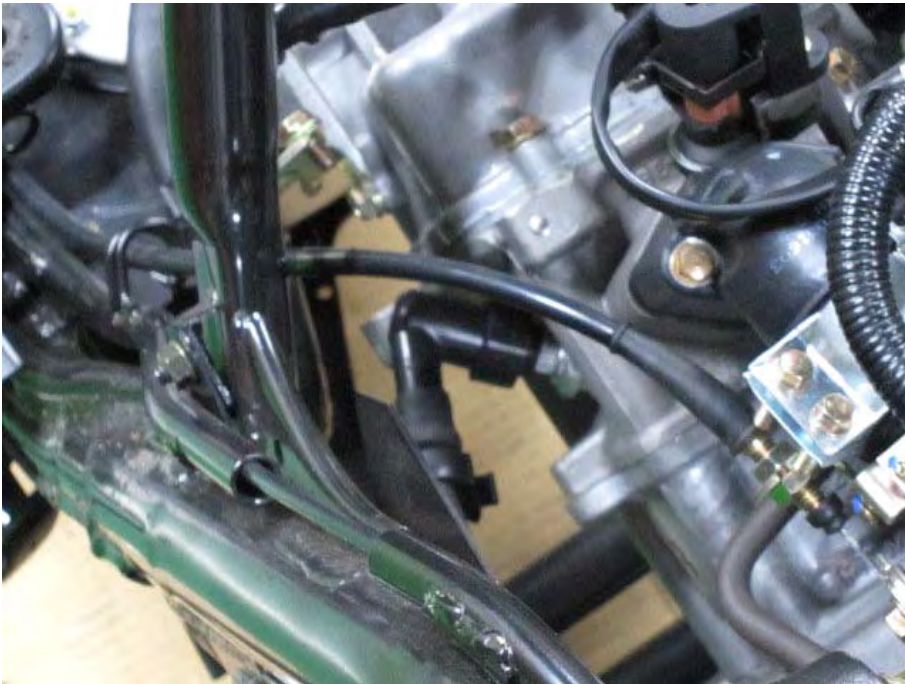

Leave the old spark plug installed. Connect known good spark plug to the coil and ground the plug to the cylinder head.

11. Electrical System > Ignition System

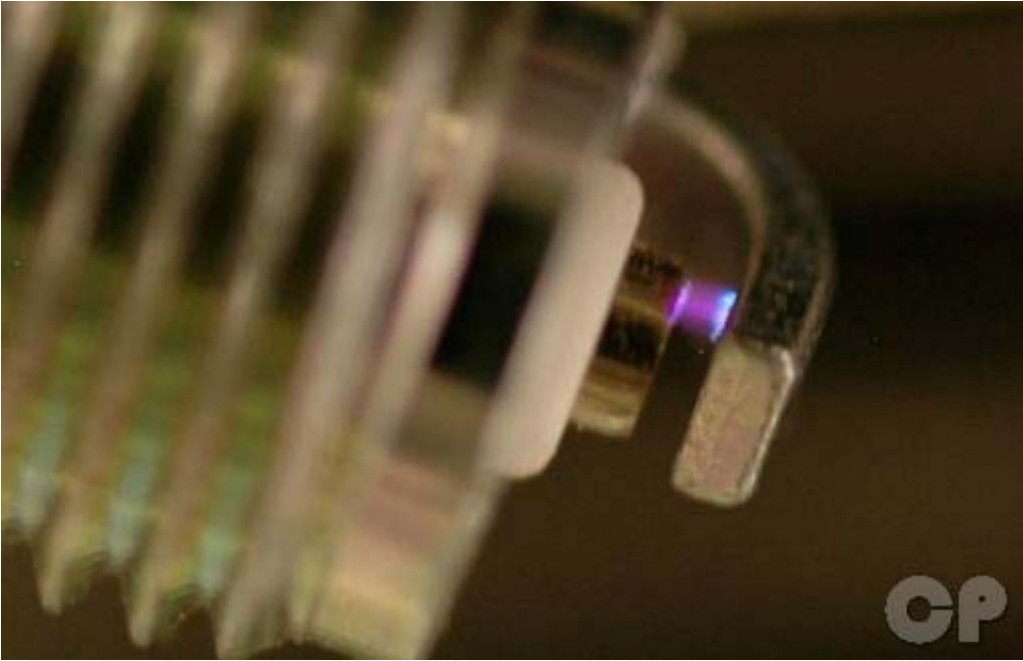

Turn the ignition switch to ON, lift the side stand, hold in one of the brake levers, and push the engine start button. The plug should spark.

Caution: Do not touch the spark plug or spark plug wire while cranking or running the engine as this can result in a severe shock.

Ignition Coil

Removal



11. Electrical System > Ignition System



Remove the ignition coil leads.



Remove the two ignition coil mounting bolts with an 8 mm socket.



Remove the ignition coil.

Ignition Coil Resistance

Primary

Set the multimeter to read ohms of resistance (Ω).

11. Electrical System > Ignition System

Touch the positive and negative meter leads to the ignition coil terminals as shown. Measure the resistance.

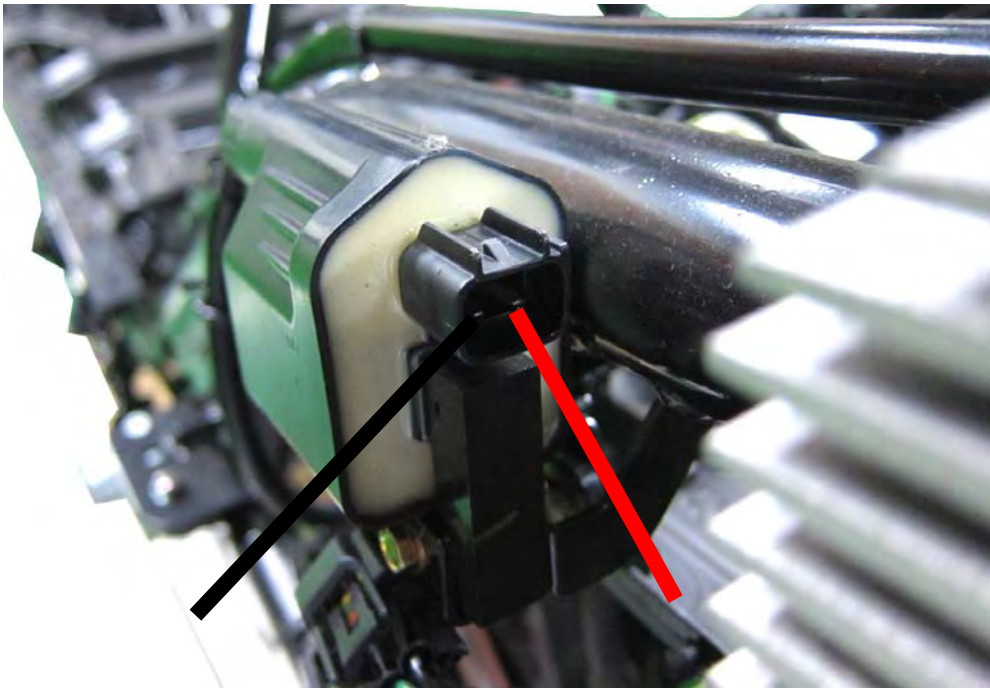

Ignition Coil Primary Resistance	0.55 – 0.75 Ω
----------------------------------	---------------

AC Generator Inspection
Crank Position Sensor Inspection

Note: This test is performed with the stator installed in the engine.

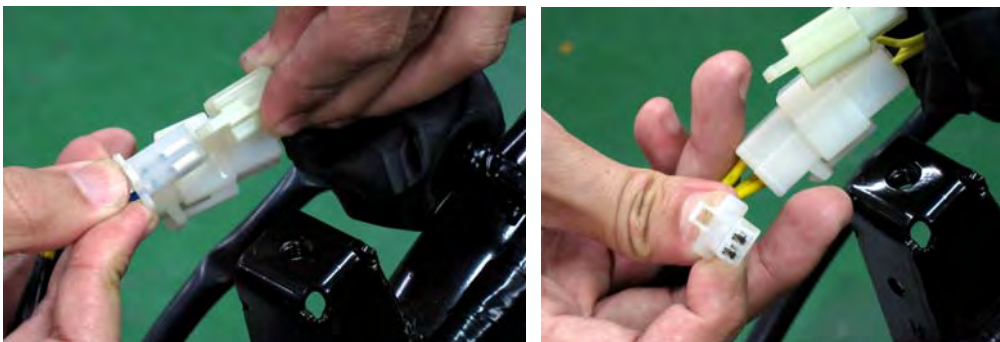

Disconnect the crank position sensor wire coupler. Measure the resistance between the Blue/White and green/white wire terminals.

Resistance	
Blue/White - Green/White	96Ω – 144Ω

Starting System

SAFETY FIRST: Protective gloves and eyewear are recommended at this point.

You will need a digital multimeter to inspect the starting system.

Starter Relay

Inspection

Remove the body cover. See the [Body Cover](#) topic for more information.

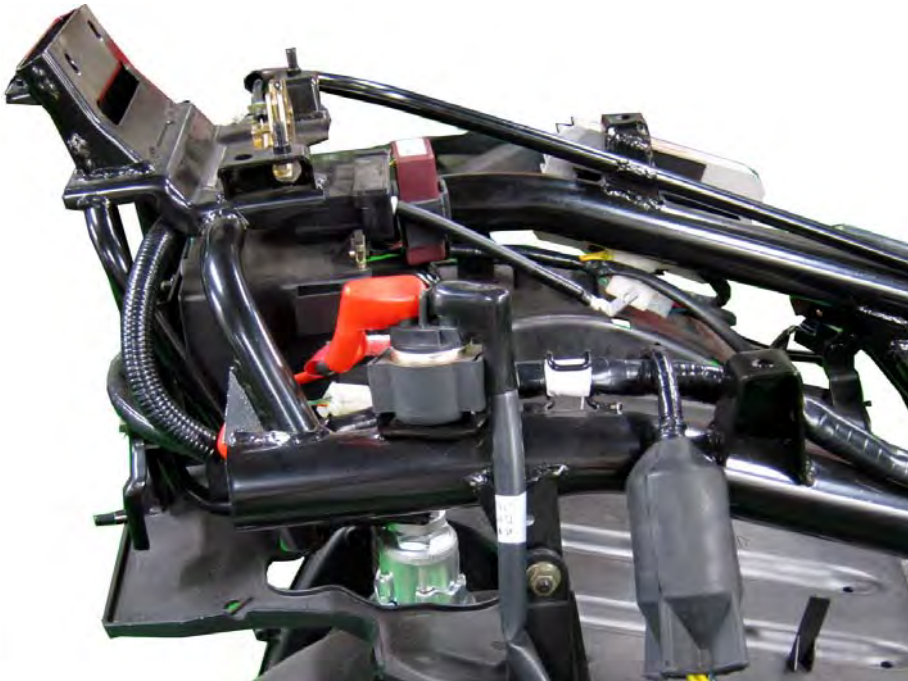

The starter relay is located on the right side of the vehicle.

11. Electrical System > Starting System

Disconnect the starter relay wire connector.



Check for continuity between the yellow/red wire and green/yellow wire. There should be continuity when the starter button is depressed. If there is no continuity, check the starter button for continuity and inspect the wire.

11. Electrical System > Starting System

Operation Test

Remove the battery cover. See the [Battery](#) topic for more information.

Turn the ignition switch to "OFF".



Remove the negative battery cable bolt with a 10 mm socket or #3 Phillips screwdriver. Free the negative cable from the battery.



Remove the two terminal covers.

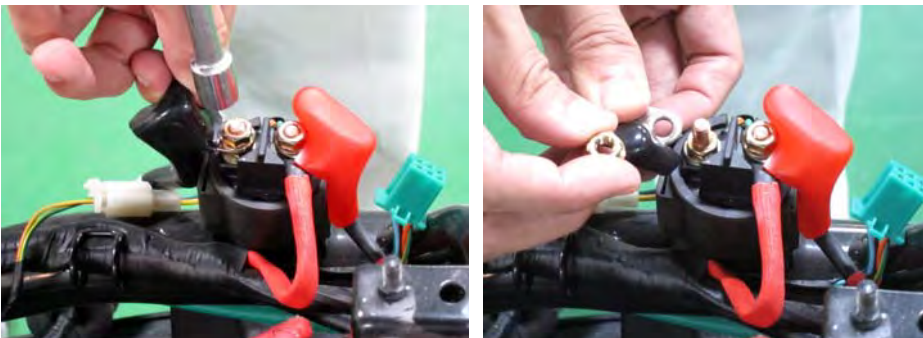

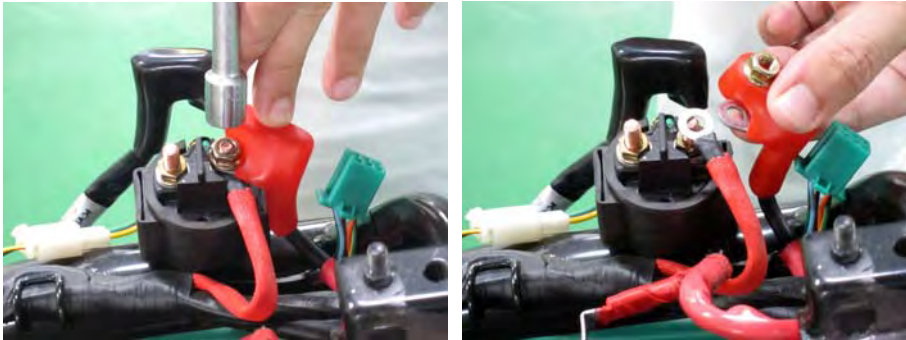
11. Electrical System > Starting System

Remove the nuts that hold the starter motor lead and battery lead wires to the starter relay with a 10 mm socket.

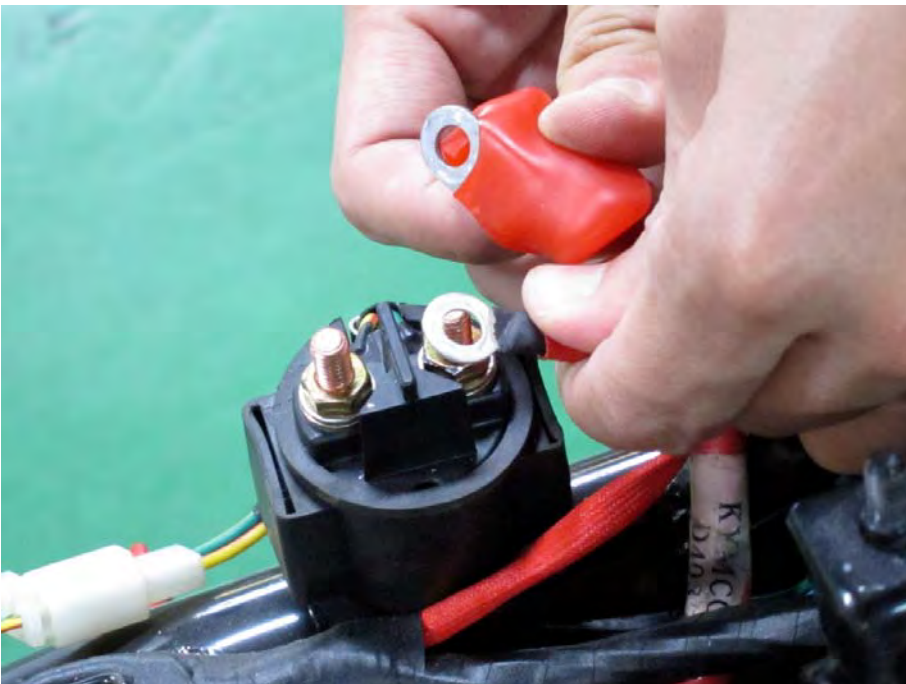

Remove the leads from the starter relay.

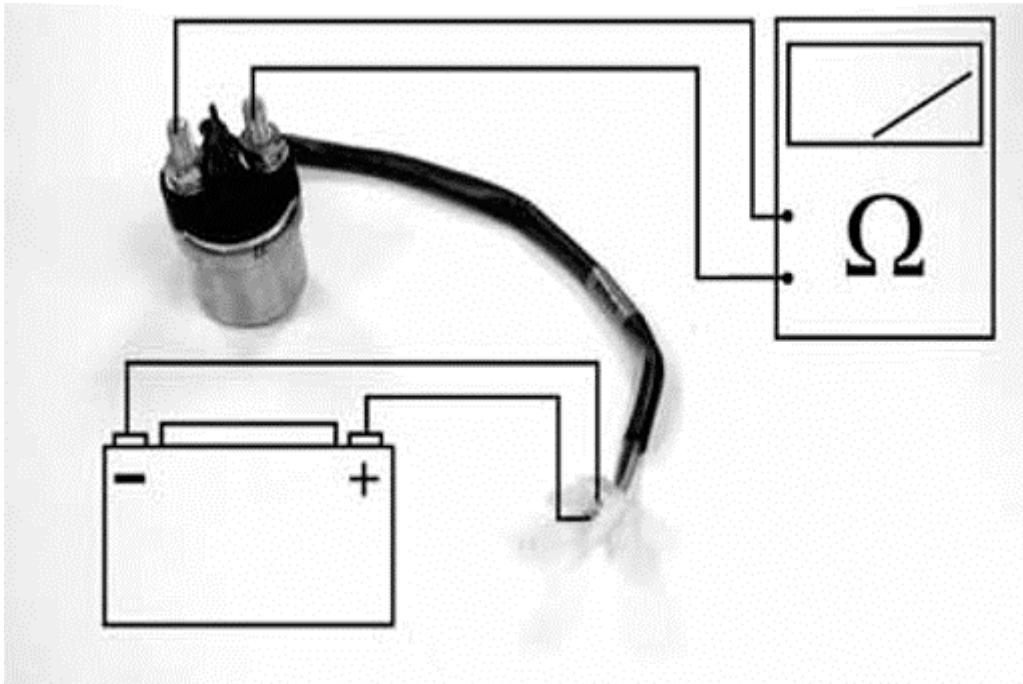

Disconnect the starter relay wire connector.

11. Electrical System > Starting System

Connect the electric meter to the starter relay terminals that connect to the battery positive cable and the starter motor cable. Connect a fully charged battery across the starter relay yellow/red and green/yellow wire terminals. Check for continuity between the starter relay large terminals. The relay is normal if there is continuity and hear sounds.

Warning: Do not apply the battery voltage jump for more than five seconds or the relay may be damaged.

Starter Motor

SAFETY FIRST: Protective gloves and eyewear are recommended at this point.

Removal

Remove the battery cover. See the [Battery](#) topic for more information.

Turn the ignition switch to "OFF".



Remove the negative battery cable bolt with a 10 mm socket or #3 Phillips screwdriver. Free the negative cable from the battery.

Remove the airbox. See the [Airbox](#) topic for more information.



Pull back the rubber starter motor lead cover.

Fuses

SAFETY FIRST: Protective gloves and eyewear are recommended at this point.

Fuse Box

Remove the seat and the luggage box. See the [Seat](#) topic for more information.



The fuse box is located on top of the battery.

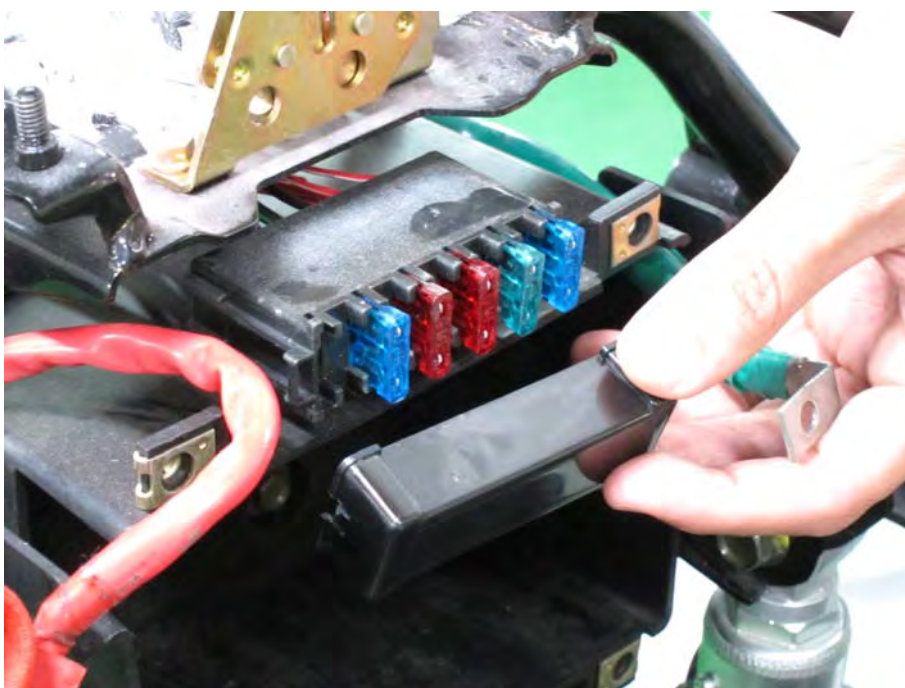

Open the covers to access the fuses.

11. Electrical System > ECU Removal**ECU Removal**

Remove the seat and luggage box. See the [seat and luggage box](#) topic for more information.

Note: The ignition control module or ECU maybe damaged if dropped or the connector is disconnected when the key is "ON" . The excessive voltage may damage the ignition control module or ECU. Always turn off the ignition switch before servicing.



Disconnect the ECU harness.



Loose two nuts attaching to throttle cable with 10mm&12mm sockets, and then remove the throttle cable.

11. Electrical System > ECU Removal

Loose two nuts attaching to the holder intake pipe.

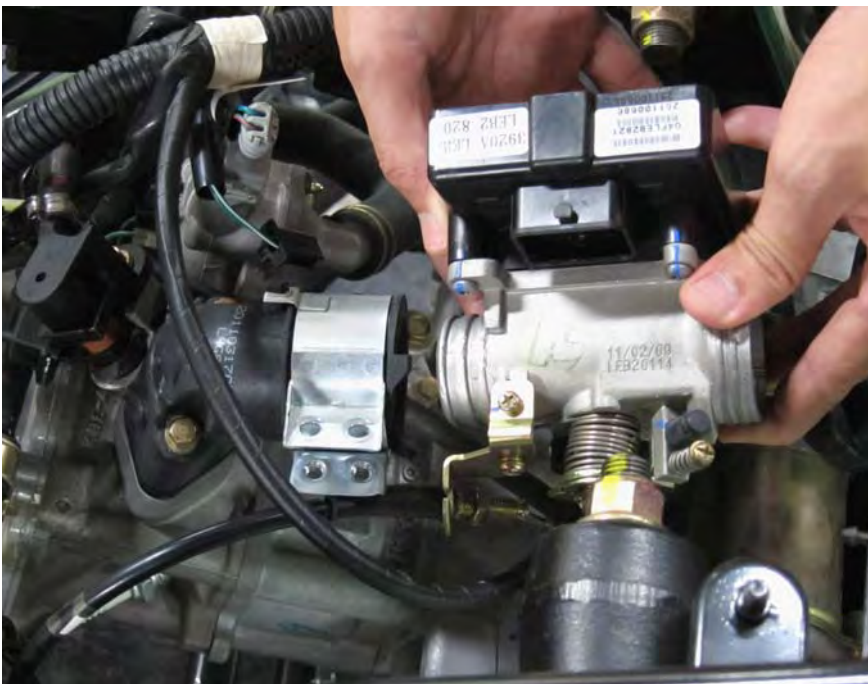

Remove the ECU.

Inspection

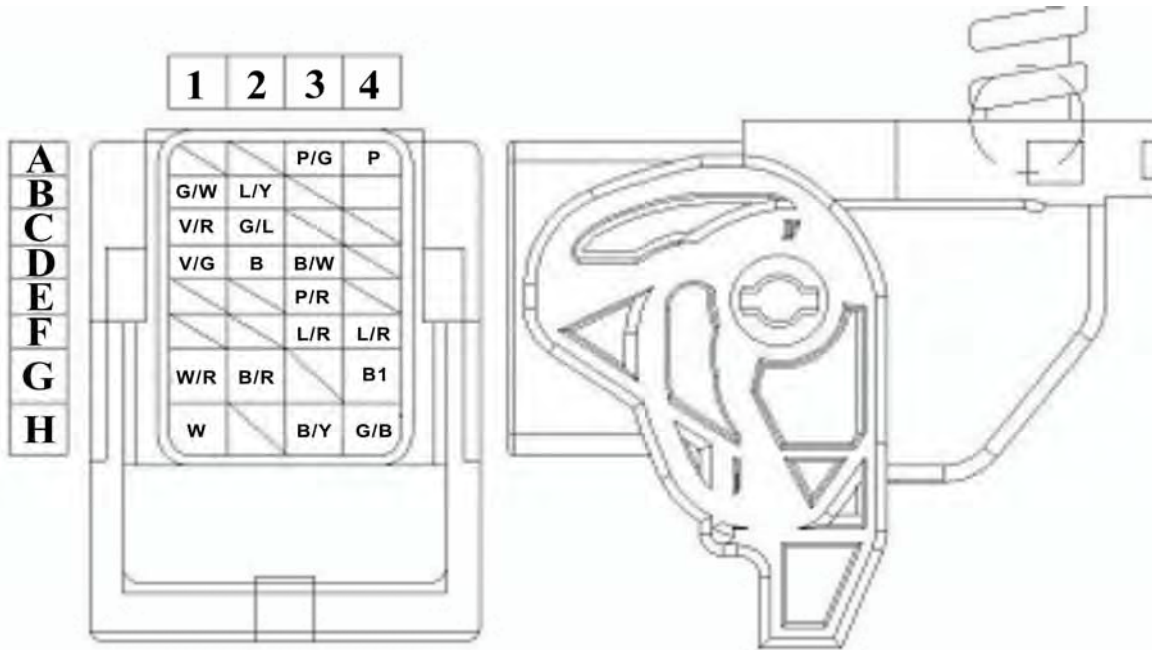
11. Electrical System > ECU Removal

Disconnect and remove the ECU.

Check for continuity between pin H4 of the ECU side connector and body frame. There should be continuity at all times.

Check for continuity between each pin B1 and D1 of the ECU side connector. There should be continuity at all times.

Check for continuity between pin D1 and H4 of the ECU side connector. There should be no continuity at all times.

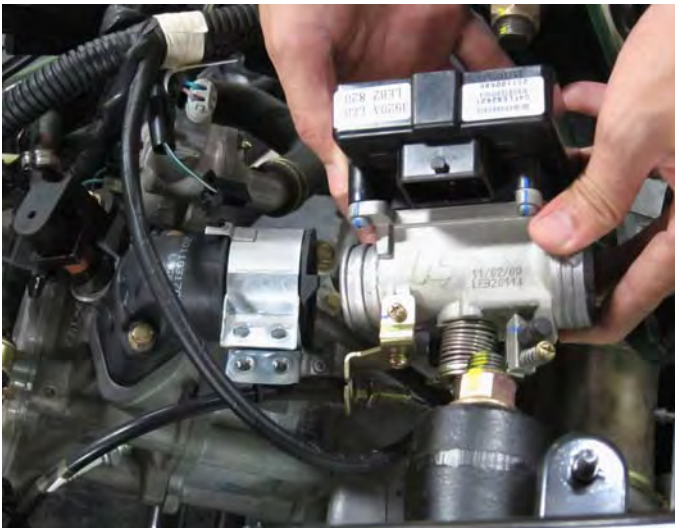
Installation

Connect the ECU harness.

Install the seat and luggage box. See the [seat and luggage box](#) topic for more information.

Self-Diagnosis

SAFETY FIRST: Protective gloves and eyewear are recommended at this point.

Note: No matter when the CELP illuminated while riding condition, should find out the cause of the problem as soon as possible.

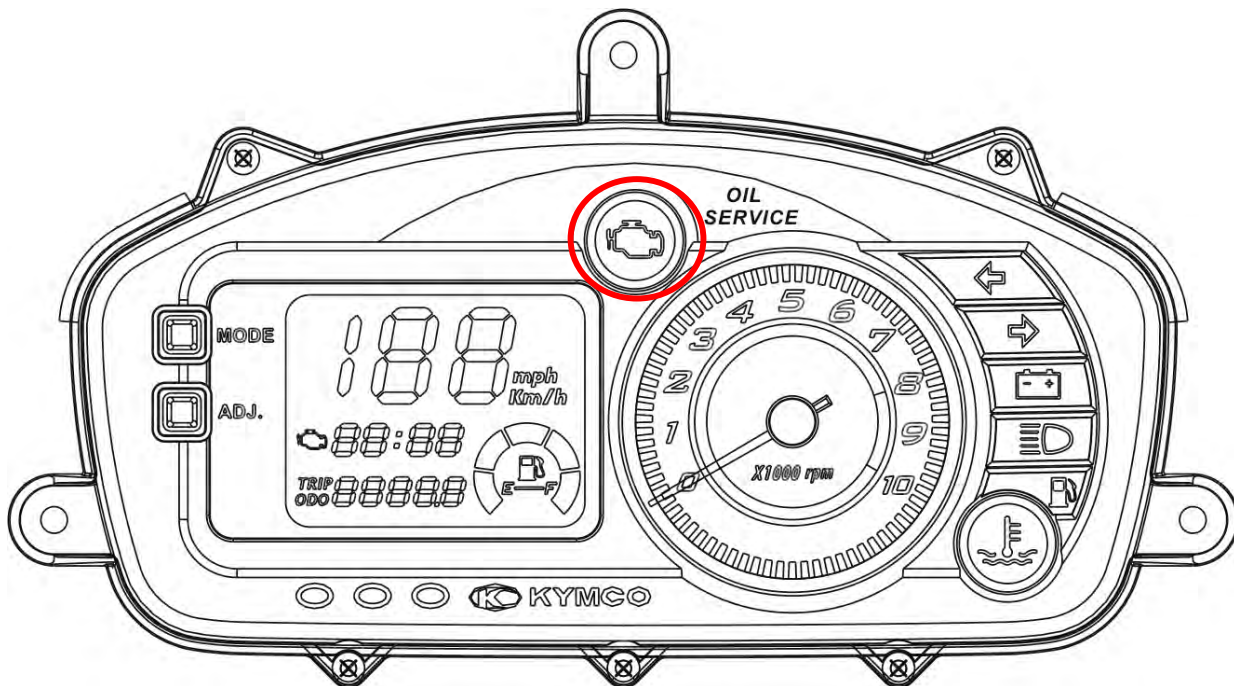

The check engine lamp (CELP) or Fi indicator is located in the center of meter.

If the ECU connectors, or battery leads are disconnected the stored malfunction codes will be lost.

Without Diagnostic Special Tool

SELF-DIAGNOSTIC PROCEDURES

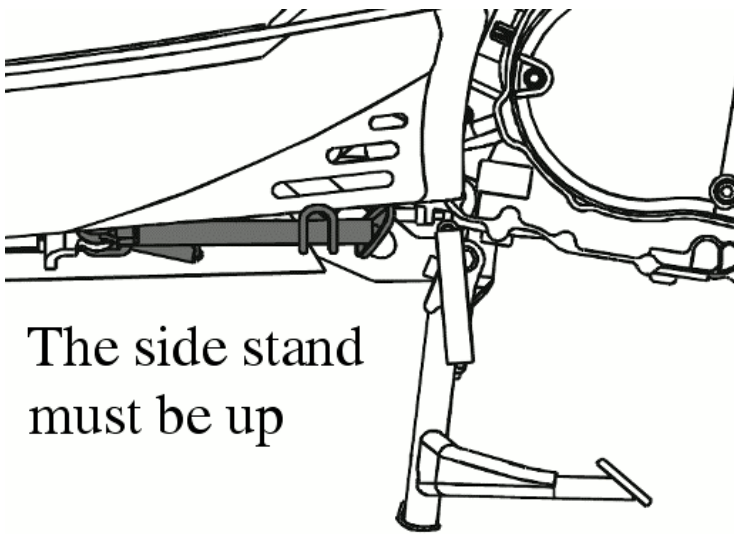
11. Electrical System > Self-Diagnosis

The side stand
must be up

Place the scooter on its main stand and put the side stand up.



Set the engine stop switch to the "RUN" position.

- Turn key to On position.
- The CELP will be lighting for two seconds and then off.
- If the engine has problem, the CELP will blink to show the failure codes.
- There're 23 failure codes for the Synerjet system.

If the vehicle gets more failure codes, the CELP will be blinking from a lower number, then show the higher number after three seconds. All failure codes would be appeared repeatedly. It can be performed without diagnostics program.

11. Electrical System > Self-Diagnosis
EFI SELF-DIAGNOSIS FAILURE CODES

The CELP denotes the failure codes. When the indicator lights for one second that is equal to ten.

For example: one longer blink illumination and two shorter blinks (0.5 second x 2) of the indicator is equal to 12 blinks. Follow code 12.

If more than a damaged part has occurred, the CELP begins blinking in order.

For example: If the indicator blinks six times, then shows one second illumination and two blinks, so there are two failures have occurred. Follow code 6 and 12.

Blinks	Failure Codes	Fault Description	Priority	Fault Management
1	P0217	Engine Overheating	1	1.Stop immediately and check CELP code. 2.Check engine thermo sensor wiring and connections. 3.Check engine lubrication and cooling systems. 4.Check engine ignition and fuel systems. 5.Extended periods of riding can cause engine overheating
2	P0335	Crank Position Sensor (CPS) Fault	2	1.Check Crank Position Sensor(CPS) wiring and connections. 2.Check CPS tp flywheel gap (0.6mm-1.2mm). 3.Check crankshaft runout. 4.Use ohm meter to check circuit resistance (100-130 ohms with engine cool).
3	P1120	Throttle Position Sensor (TPS) Fault	2	1.Use KYMCO AFI Diagnostic Tool to reset code. Ensure TPS is within specs. (With throttle plate closed-0.68 volts +/- 0.03 volts). 2.Check TPS wiring and connections. 3.Ensure that TPS value to be 0% when throttle plate is closed.
4	P1121	Throttle Position Sensor (TPS) output is abnormal	2	1.Check TPS wiring and connections. 2.Use KYMCO AFI Diagnostic Tool to measure voltage (below 0.5 volts). 3.Ensure that TPS screw has not been adjusted unnormally, TPS should be 0% when throttle plate is closed.
5	P1122	Throttle Position Sensor Velocity Fault	2	1.Check TPS wiring and connections. 2.Use KYMCO AFI Diagnostic Tool to measure voltage (below 0.5 volts). 3.Ensure that TPS screw is adjusted to 0% when throttle plate is closed. 4. Replace TPS sensor
6	P0560	Battery Voltage abnormal	1	1.Using volt meter, check battery voltage (12-15 volts). 2.Using volt meter, check stator output (13.5-14.5 volts). 3.Check black, blue, and red wires on ECU for shorts. 4.Check battery condition.
7	P0110	Inlet Air Thermosensor (IAT) Fault	2	1-Check IAT wiring and connections. 2-Using Ohm meter, check IAT resistance (2554-568.9 ohms within 20~60 degree centigrade).
8	P0410	Idle Air Bypass Valve (IABV) Fault	2	1.Check IABV wiring and connections. 2.Using Ohm meter, check IABV resistance (24.7-27.3 ohms). Note-IABV is powered by the battery

11. Electrical System > Self-Diagnosis

Blinks	Failure Codes	Fault Description	Priority	Fault Management
9	P0505	Idle Air Bypass Control Range Fault	2	<ol style="list-style-type: none"> 1-Check idle bypass valve opening is within specs. (brand new: above 35 degree used: <180 degree) 2.Check throttle body for carbon deposits. 3.Check Idle Throttle Valve for sticking and check adjustment of screw. 4. Check intake for air leaks 5. Replace the IABV 6. Note-IABV is powered by the battery
10	P0251	Fuel Injector Fault	2	<ol style="list-style-type: none"> 1.Use ohm meter to measure resistance (13.78-15.23 ohms). 2.Check injector wiring and connections. 3.Check battery wiring and connections. Note-Fuel Injector is powered by battery
11	P0350	Ignition Coil Fault	2	<ol style="list-style-type: none"> 1.Verify ignition is within specs (0.57-0.66 ohms) 2.Check wiring and connections. 3.Check condition of battery wiring and connections.
12	P0230	Fuel Pump Relay Fault	2	<ol style="list-style-type: none"> 1. Check wiring and connections. 2. Listen for relay clicking when ignition is switched on.
13	P0219	Engine Over Speed Condition Fault	2	<ol style="list-style-type: none"> 1. Engine exceeded 10,500 rpm redline. 2. Check belt. 3. Check spark plug. Use resistor plug "R".
14	P1560	Sensor Power Supply Fault	2	<ol style="list-style-type: none"> 1.Use volt meter to check ECU pin 18 (5 volts DC) or use diagnostic tool (5 volts +/- 0.1 volts). 2.Check voltage difference between pin 16 and pin 18 (5 volts DC). 3.Cylinder head Temperature Sensor, Intake Air Temperature Sensor, and TPS use the same power supply. If getting more than three faults, ECU could be faulty.
15	P0700	Engine RPM/CVT Fault	2	<ol style="list-style-type: none"> 1.If engine exceeds 3250 rpm at idle, ECU will lower engine idle speed or shut engine down. 2.When start the engine, Do NOT use throttle 3.Check throttle cables and throttle body for sticking and binding. 4.Check throttle idle voltage (0.68 volts +/- 0.03 volts). 5.Check CVT belt.
16	P0115	Cylinder Head Thermosensor Fault	2	<ol style="list-style-type: none"> 1.Use voltmeter to check resistance (cold 2445.2-5458.3 ohms). 2.Check wiring and connections for ECU pin 9.
18	P0650	Check Engine Light Fault	3	<ol style="list-style-type: none"> 1.Check bulb (1.7w 12 volt DC). 2.Check ECU wiring and connections pin 4.
21	P0105	Atmosphere Pressure Sensor Fault	2	<ol style="list-style-type: none"> 1.Check sensor voltage (5 volts +/- 0.1 volt). 2.Check ECU wiring and connections pin 8. 3.Use Diagnostic Tool to check pressure (101.3 +/- 3 KPA).
22	P1110	Bank Angle Detector Sensor Fault	2	<ol style="list-style-type: none"> 1.Use KYMCO AFI Diagnostic Tool Check sensor voltage (3.5-4.7 volts). 2.Check ECU wiring and connections pin 11. 3.If still getting fault, replace sensor.
23	P0136	O2 Sensor Fault	1	<ol style="list-style-type: none"> 1.Check sensor resistance (Standard: 6.7-9.5Ω @20°C~30 °C). 2.Check ECU wiring and connections pin 10. 3.If still getting fault, replace sensor.
24	P0141	O2 Heater Sensor Fault	2	<ol style="list-style-type: none"> 1. Check ECU wiring and connections pin 14. 2. If still getting fault, replace sensor.
25	P0171	Close loop Fault	1	<ol style="list-style-type: none"> 1. Check wiring and connections pins 10 and 14. 2. If still getting fault, the injector probably injected more fuel or inlet air abnormal. Check if the injector is clogged, if the valve timing is correct or valve leaking, if the piston and ring piston is damaged....and so on.

FAILURE CODES LIST

With Special Tool

See the [Fuel Injection Diagnostic Tool](#) topic.

Self-Diagnosis Reset Procedure

Note: The self-diagnosis cannot be reset when has still problem inside the system.

After excluding trouble, how the DTC can be cleared? Confirm the failure is excluded.

- Turn on the ignition switch but the engine not started and keep the CELP light up for four times. If it is off automatically, it means the historical DTC is cleared automatically.
- Check again to confirm DTC is excluded.
- Turn on the ignition switch again. When there is no residual historical failure code. Starting the engine and if no failure lamp is on or flashing, it is Okay.

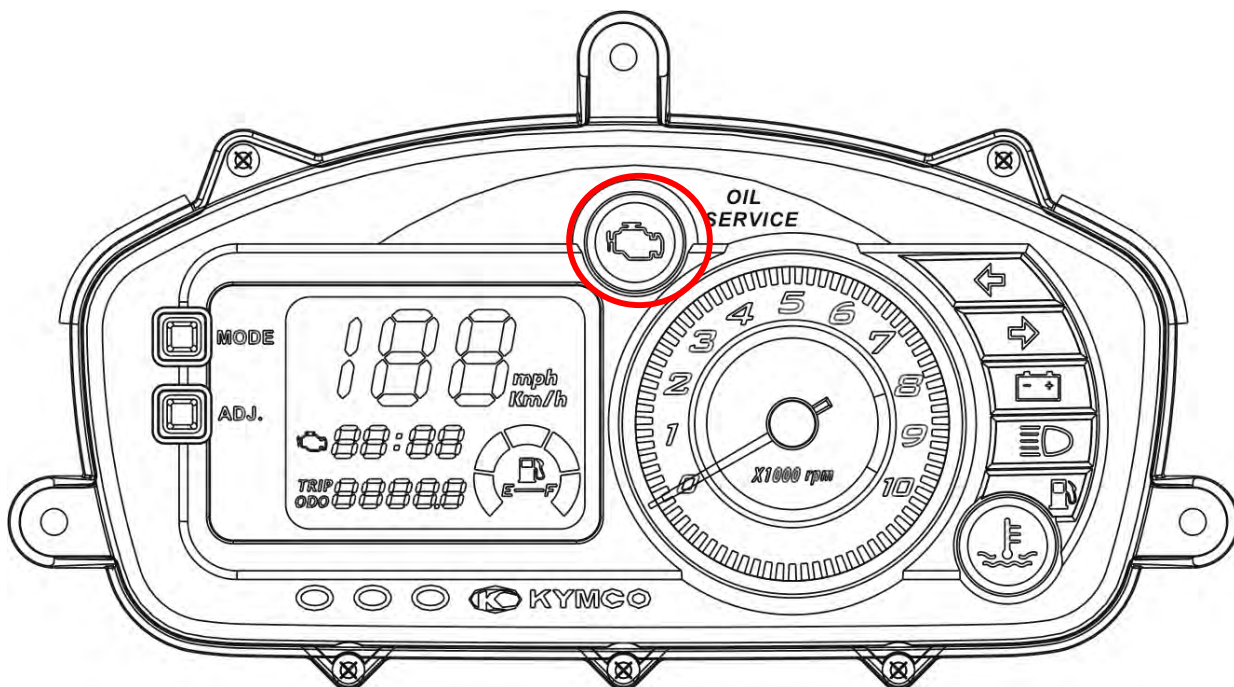

Spark Plug Anti-Flood

When no failure code occurs and pressing starter switch repeatedly can still not start the engine the spark plug maybe fouled be a flooded engine. Perform the spark plug anti-flood to purge the fuel in the engine.

Make sure the battery voltage is greater than 12 V.

1. Close the throttle, turn the ignition switch to ON.
2. Open and hold the throttle fully, pressing starter switch more than 3 seconds.

TPI/ABV Reset

- After replacing throttle body or engine overhauled, It will change the efficiency of air intake so must be do the TPI/ABV initialization process.
- If the throttle cable is being moved when the throttle body is installed it can cause a hard to start engine or incorrect idling speed.
- ABV controls air bypass valve to obtain a smooth idling speed. The ECU may record the incorrect ABV position when the ECU or the throttle body has been reinstalled. It can cause engine stop, hard to start engine or rough idling speed.

The throttle position sensor (TPS) and air bypass valve (ABV) have to be reset when throttle body or ECU have been reinstalled.

TPI/ABV RESET PROCEDURE

- When the vehicle is started, turn off the ignition and Key On again at engine stop working. Use the testing rod or wire clip short Reset (Pink color) wire to touch the negative wire or the body frame to complete TPI/ABV resetting procedure.



Horn

SAFETY FIRST: Protective gloves and eyewear are recommended at this point.

Remove the front cover. See the [Front Cover](#) for more information.



Disconnect the horn connectors from the horn. Connect a 12 V battery to the horn terminals. The horn is normal if it sounds when the 12 V battery is connected across the horn terminals.

To test the horn switch see the [Switches](#) topic.

Lights

SAFETY FIRST: Protective gloves and eyewear are recommended at this point.

For general information and troubleshooting for the lights see the [Electrical Systems](#) chapter landing page.

Headlight

Bulb Replacement

Make sure the machine has been off for several minutes before removing the headlight bulb.

Remove the front cover. See the [Front Cover](#) topic for more information.



Slide back the rubber headlight covers. Remove the clip with a screwdriver.

11. Electrical System > Lights



Remove the headlight bulbs from the lamp.

Unplug the bulb from its connector. Do not touch the bulb with your bare hands if you plan to reuse it.

Do not touch your new bulb with your bare hand. The oils on your hand can cause an early failure of the headlight bulb. If you do touch the bulb with your bare hand wipe off the bulb with a clean shop towel and alcohol.

Plug the connector into the bulb.

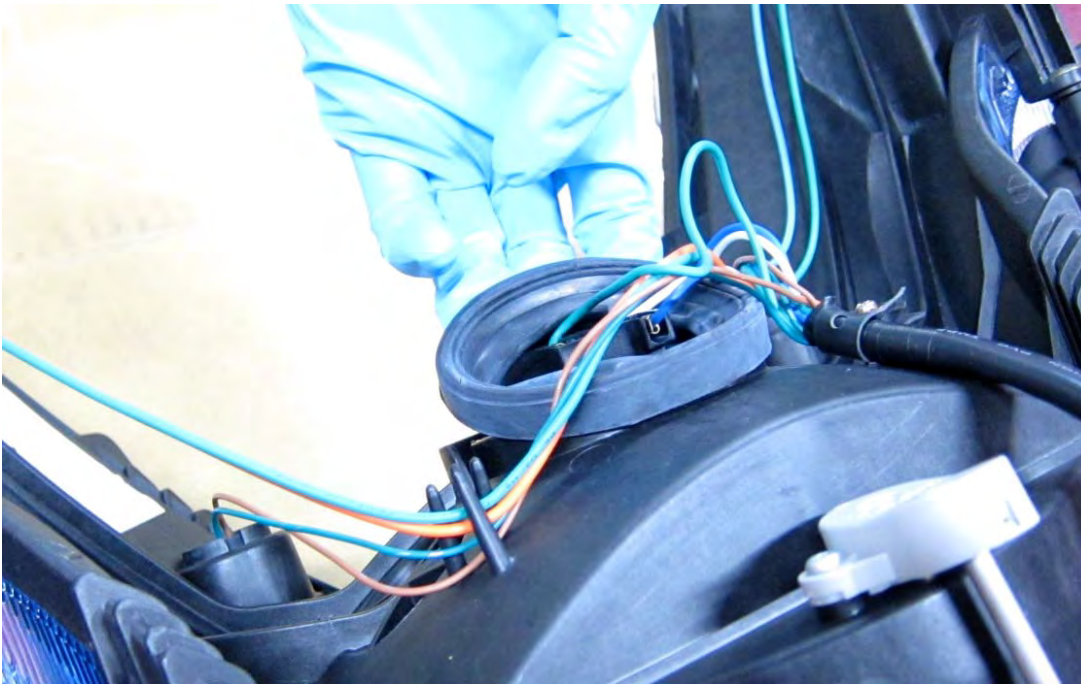

Fit the bulb into the lamp.

11. Electrical System > Lights

Fit the rubber cover into place. Make sure the rubber covers are secured in place.

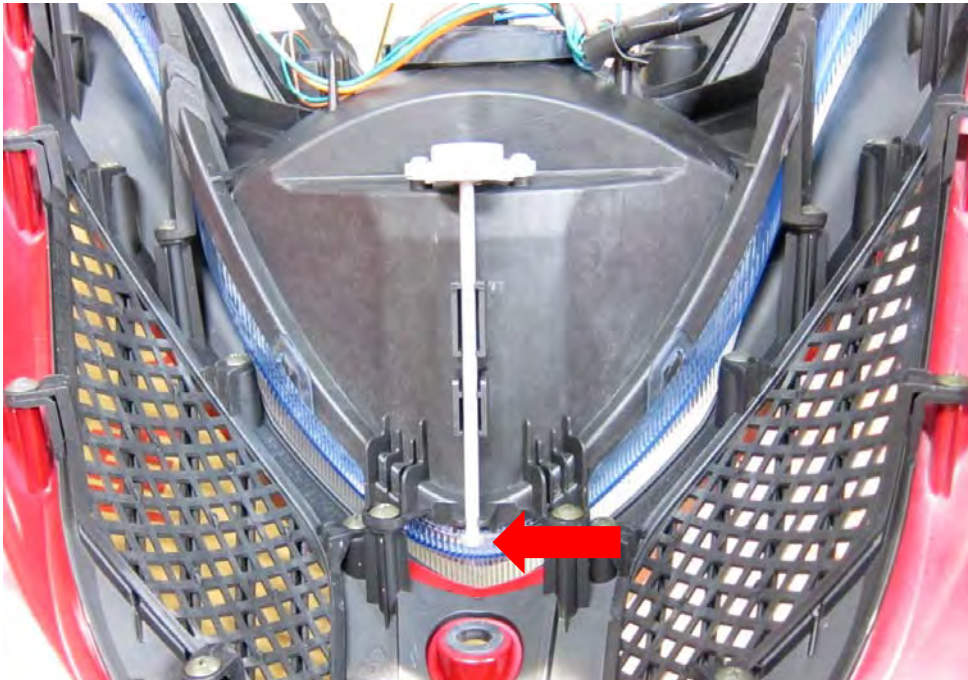
Aim

Turn the screws to adjust the head light aim as needed.

Front Turn Signals

Remove the front cover. See the [Front Cover](#) topic for more information.



Turn the turn signal bulb socket counterclockwise and free it from the lamp.



Push in on the bulb and rotate it clockwise to remove it from the socket. Insert the new bulb. Push down on the bulb and rotate it counterclockwise to lock it into place.

11. Electrical System > Lights



Insert the turn signal bulb and socket into place. Turn the socket clockwise to lock it into place.

Taillights

Bulb Replacement

Lift the seat. See the [Seat](#) topic for more information.

Remove the turn signal sockets with bulbs from the turn signal lamps.

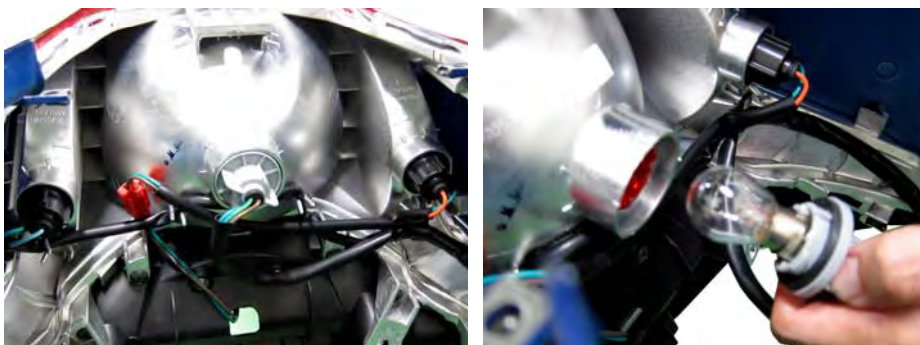

Remove the taillight socket with bulb from the tail light housing by turning it counterclockwise.

11. Electrical System > Lights



Replace the bulbs as needed. Push in and turn the bulbs counterclockwise to remove the and clockwise to install them.



Install the taillight socket into the lamp and turn it clockwise to lock it into place.

11. Electrical System > Lights

Rear Turn Signals

Remove the rear cover. See the [Body Cover](#) topic for more information.



Turn the socket counterclockwise and remove it from the lamp.



Push in the bulb and turn it counterclockwise. Remove the bulb. Insert the new bulb and turn it clockwise to lock it in place.

License Tag Light

Remove the license tag light from the mud flap. See the [Body Cover](#) topic for more information.



Pull the rubber tag light socket out of its housing. Pull the bulb straight out and insert a new one.

Insert the rubber socket into the housing. Install the body cover. See the [Body Cover](#) topic for more information.

Relays

SAFETY FIRST: Protective gloves and eyewear are recommended at this point.

Starter Relay

See the [Starting System](#) topic for more information.

High/Low Beam Relays

Remove the front cover. See the [Front Cover](#) for more information.

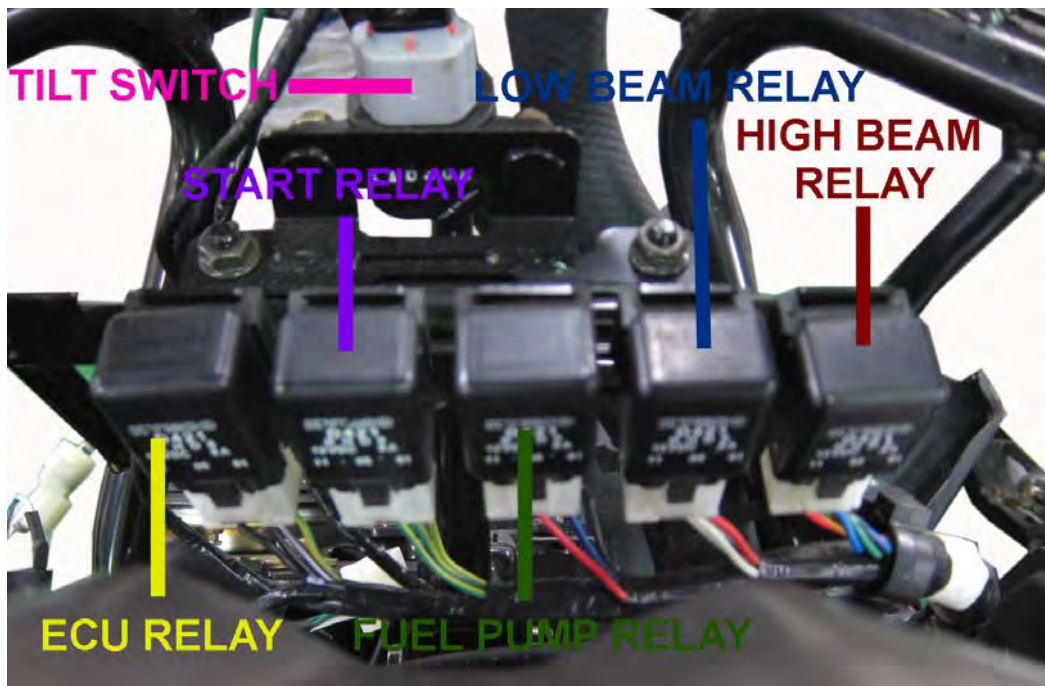

Remove and disconnect the high beam relay. The high beam relay is on the right.

11. Electrical System > Relays

Fuel Pump Relay

Remove the front cover. See the [Front Cover](#) for more information.

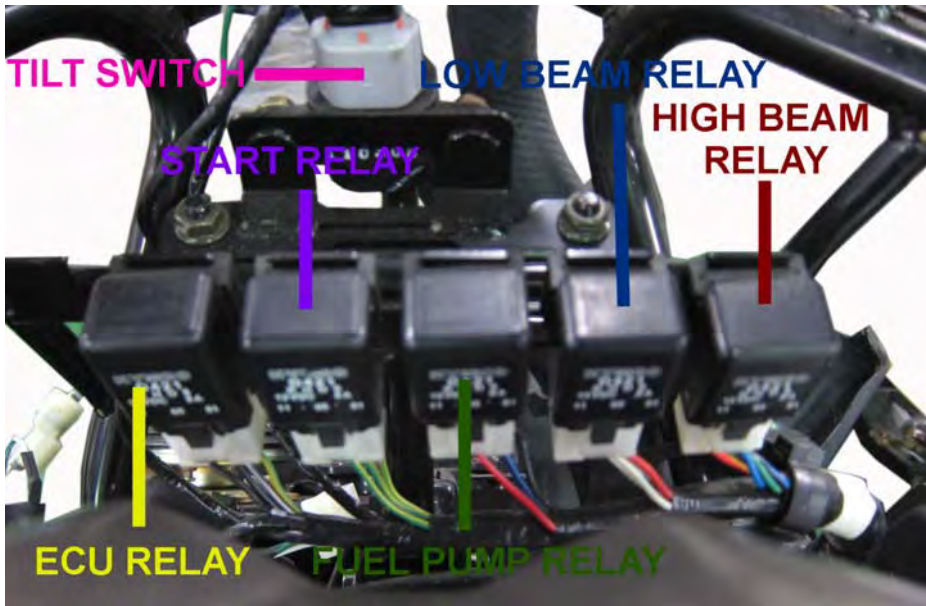

The fuel pump relay is located in the front under the dash panel. Remove and disconnect the fuel pump relay.

Inspection

Use a digital multimeter to inspect the fuel cut-off relay. Set the multimeter to read ohms of resistance.

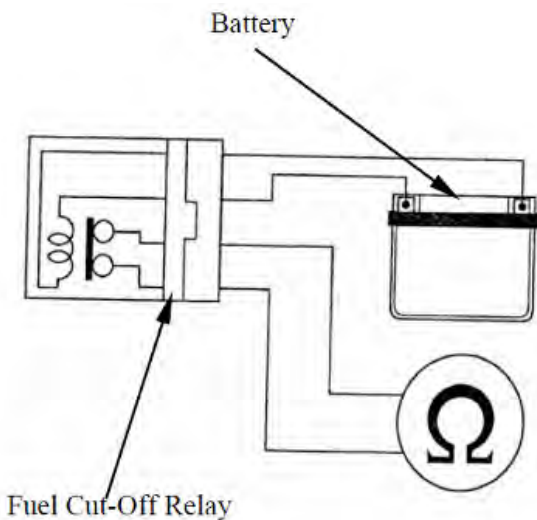

Connect the multimeter to the fuel cut-off relay connector terminals.
Connection: Black/Red - Red/Black

Connect 12 V battery with the fuel cut-off relay connector.
Connection: Blue/Black – Black/Red

There should be continuity only when 12 V battery connected.
If there is not continuity when the 12 V battery is connected, replace the fuel cut-off relay.

ECU Relay

Remove the front cover. See the [Front Cover](#) for more information.

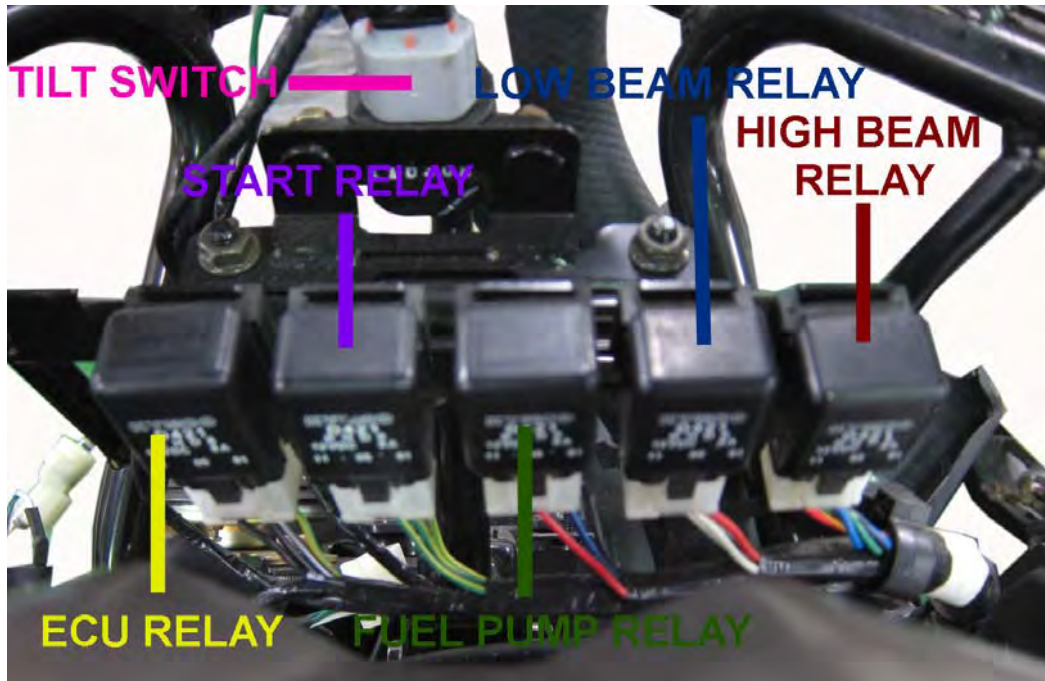

The ECU relay is located in the front under the dash panel, to the left of the start relay. Remove and disconnect the ECU relay. Disconnect the dash if needed. See the [Dash](#) topic for more information.

Switches

SAFETY FIRST: Protective gloves and eyewear are recommended at this point.

You will need a digital multimeter to inspect the switches.

Ignition Switch

Remove the front cover. See the [Front Cover](#) topic for more information.

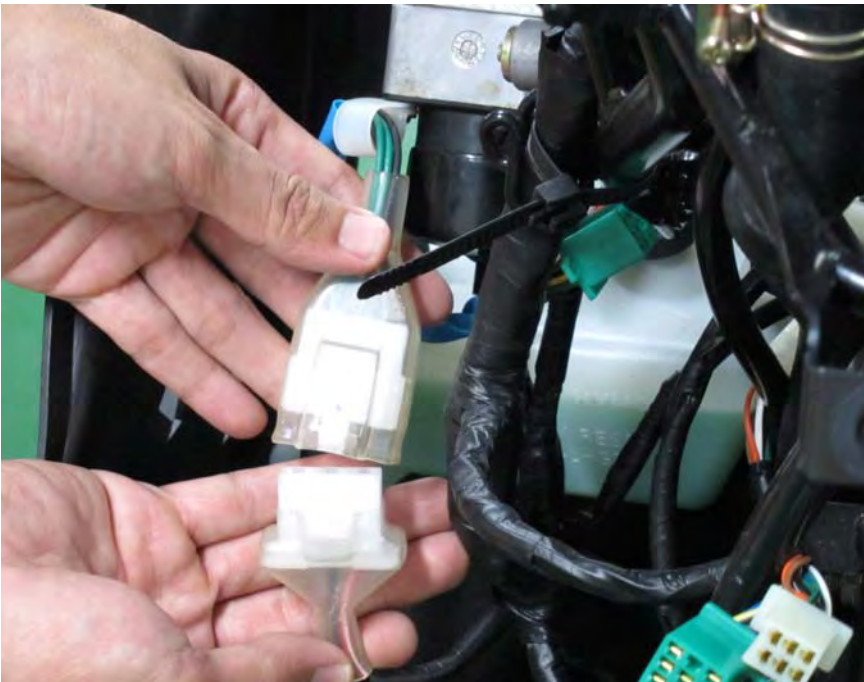

Unplug the white six-pin ignition switch connector.

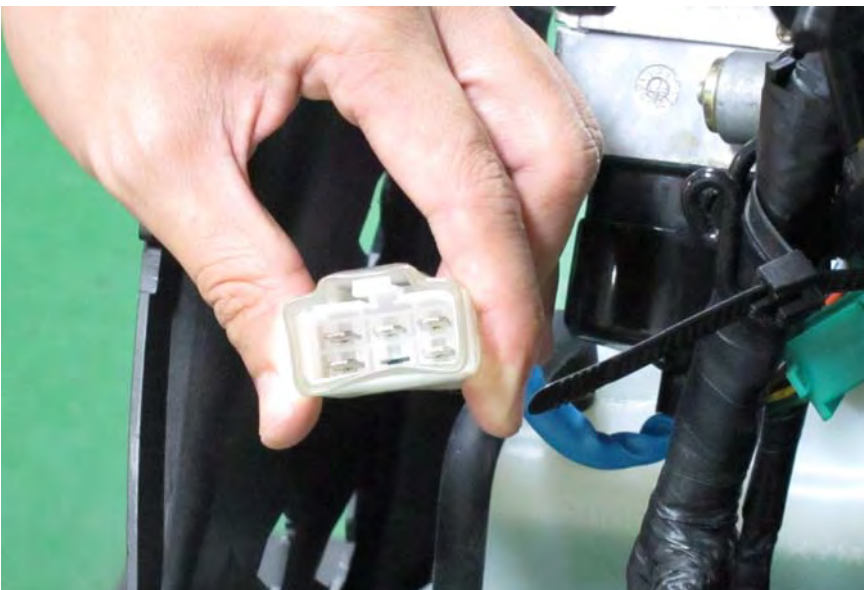

Use a digital multimeter to check for continuity to inspect the ignition switches. Continuity should exist between the wires as indicated.

Ignition Switch

	BAT2	IG	E	BAT1	HA
LOCK		○—○			
OFF		○—○		○—○	
ON	○—			○—○	
COLOR	B	B/W	G	R	B/L

Removal

Remove the front cover. See the [Front Cover](#) topic for more information.

Remove the front center cover. See the [Front Center Cover](#) topic for more information.

Remove the dash. See the [Dash](#) topic for more information.



11. Electrical System > Switches



Remove the seat latch cable cover.



Loosen the seat latch cable screw with a #2 Phillips screwdriver.

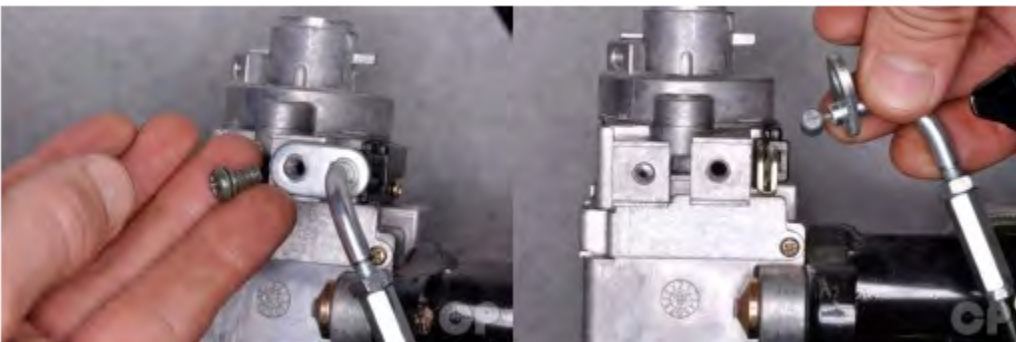

Remove the seat latch cable screw and free the seat latch cable from the ignition switch.

11. Electrical System > Switches



To remove the anti-tamper bolts use a punch and a hammer to strike the bolts so that they rotate loose. Turn the bolts clockwise to loosen them.

Installation

Install new anti-tamper bolts and tighten them securely.



Fit the end of the seat latch cable into the ignition switch.



Install the seat latch cable screw and tighten it securely with a #2 Phillips screwdriver.

11. Electrical System > Switches



Install the seat latch cable cover.

Tilt Switch

Remove the front cover. See the [Front Cover](#) topic for more information.

Remove the front center cover. See the [Front Center Cover](#) topic for more information.

Support the scooter level surface.

Put the side stand up and engine stop switch on "RUN". Turn the ignition switch to "OFF".

Note: Do not disconnect the tilt switch connector during inspection. The capacity of battery must be fully charged.

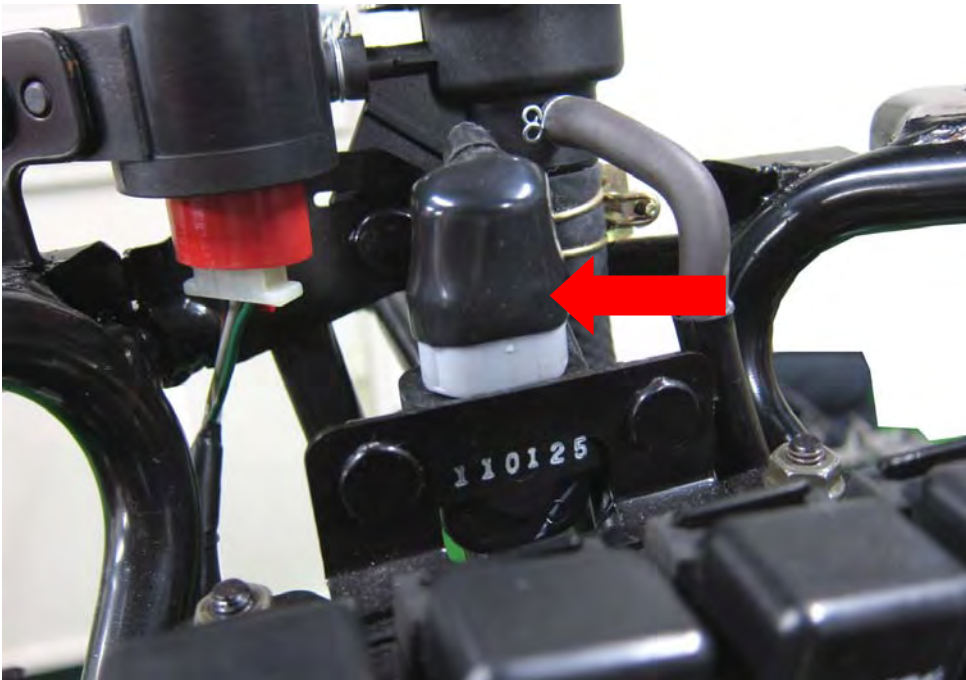

The tilt switch is located in the front near the radiator cap.

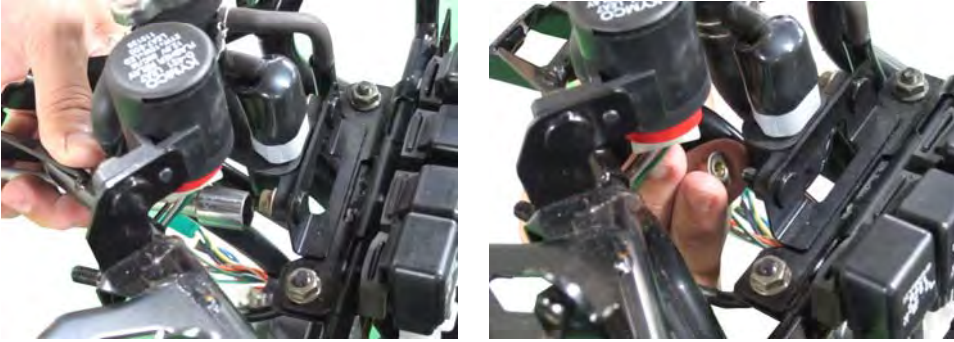
11. Electrical System > Switches

Remove the two tilt switch nuts with a 10mm socket.



Place the tilt switch vertical as shown and the ignition switch "ON". Measure the voltage as below.

Terminal	Standard
Violet/Red (+) ~ Green/Pink (-)	5 V (ECU voltage)
Black/Blue (+) ~ Green/Pink (-)	0.4 - 1.4 V less



Incline the tilt switch 65 ± 10 degrees to the left or right at the ignition switch "ON". Measure the voltage as below.

Terminal	Standard
Violet/Red (+) ~ Green/Pink (-)	5 V (ECU voltage)
Black/Blue (+) ~ Green/Pink (-)	3.7 - 4.4 V

Note: Repeat this test, first turn the ignition switch to "OFF", then turn the ignition switch to "ON".

11. Electrical System > Switches



Disconnect the connector to remove the tilt switch.

Handlebar Switches

Remove the front cover. See the [Front Cover](#) topic for more information.

To remove the handle bar switches see the [Handlebar](#) topic.

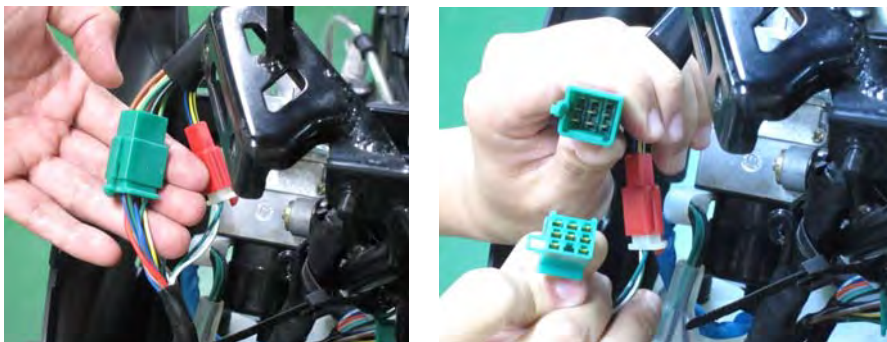

Unplug the green connector for the right handlebar switches.

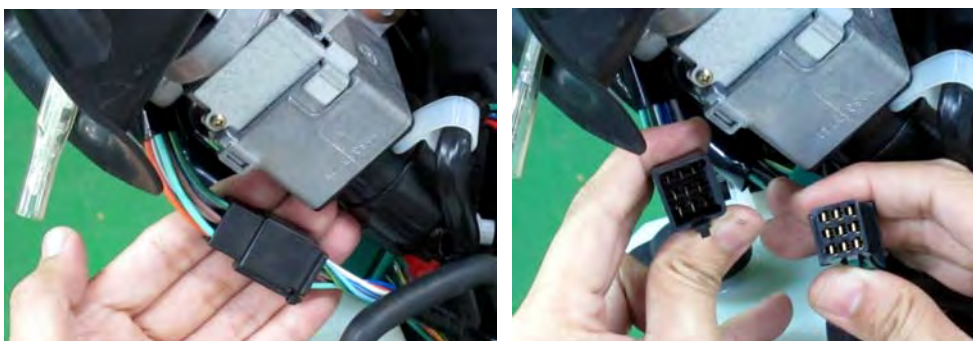

Unplug the black connector for the left handlebar switches.

11. Electrical System > Switches

Right Handlebar Switches



Use a digital multimeter to check for continuity to inspect the handlebar switches. Continuity should exist between the wires as indicated.

Lighting Switch

	BAT3	PO	TL	HL
•				
(N)				
P	○—○—○			
(N)	○—○—○—○			
H	○—		○—○	
COLOR	BR/L	BR/W	BR	W/L

Starter Switch

	E	ST
FREE		
PUSH	○—○	
COLOR	G	Y/R

Engine Stop Switch

	IG	BAT3
OFF		
RUN	○—○	
COLOR	B/W	B/G

Left Handlebar Switches



Use a digital multimeter to check for continuity to inspect the handlebar switches. Continuity should exist between the wires as indicated.

Passing Switch

	BAT4	HI
FREE		
PUSH	○—○	
COLOR	BR/L	L

Horn Switch

	BAT4	HO
FREE		
PUSH	○—○	
COLOR	BR/L	LG

Turn Signal Switch

	WR	R	L
R	○—○		
N			
L	○—○		○
COLOR	GR	SB	O

Dimmer Switch

	HL	HI	LO
LO	○—○		○
(N)	○—○—○		
HI	○—○		
COLOR	W/L	L	W

Luggage Box Switch

Remove the luggage box. See the [Luggage Box](#) topic for more information.

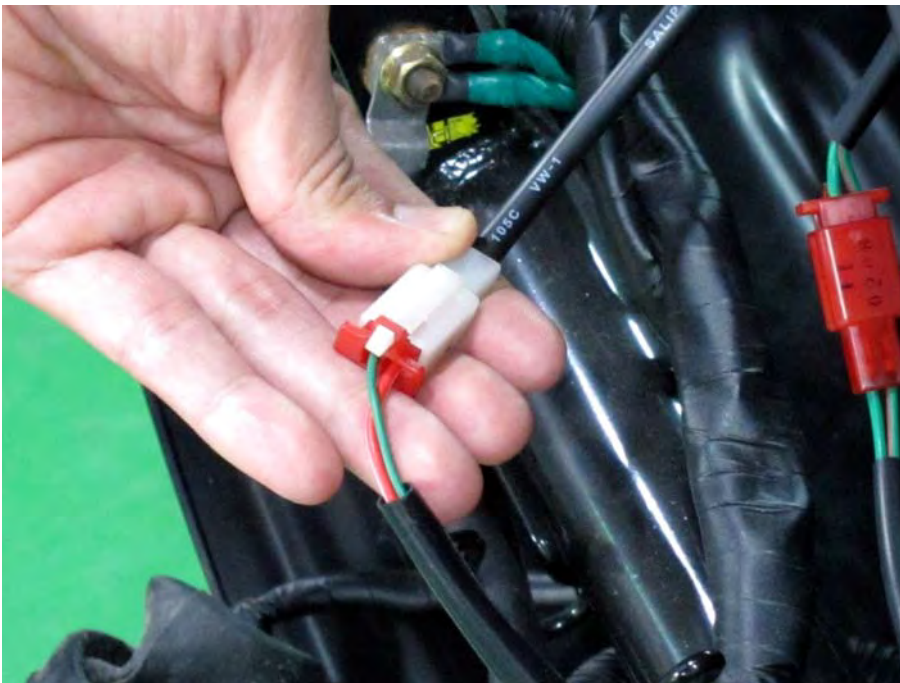

Unplug the two-pin luggage box light switch connector with green and green/red wires.

Side Stand Switch

Remove the luggage box. See the [Luggage Box](#) topic for more information.

Place the vehicle on the center stand.



Unplug the three-pin side stand switch connector.



Use a digital multimeter to check for continuity.

11. Electrical System > Switches

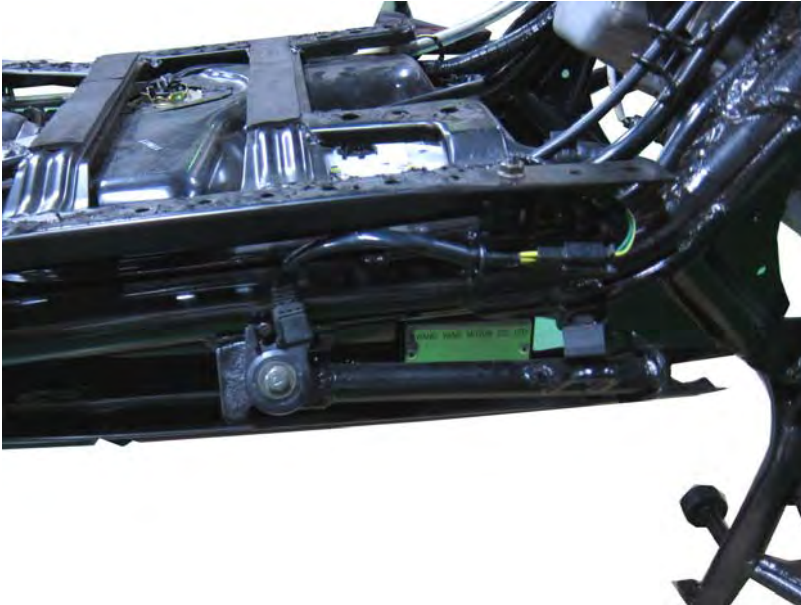

With the side stand retracted there should be continuity between the yellow/green wire and the green wire terminals.



With the side stand extended there should be continuity between the yellow/black wire and the green wire terminals.

To remove the side stand switch see the [Stands](#) topic.

Brake Light Switches

Test the front and rear brake light switches in the same manner. Use a digital multimeter to check for continuity.

Remove the upper handlebar cover. See the [Handlebar Covers](#) topic for more information.

11. Electrical System > Switches

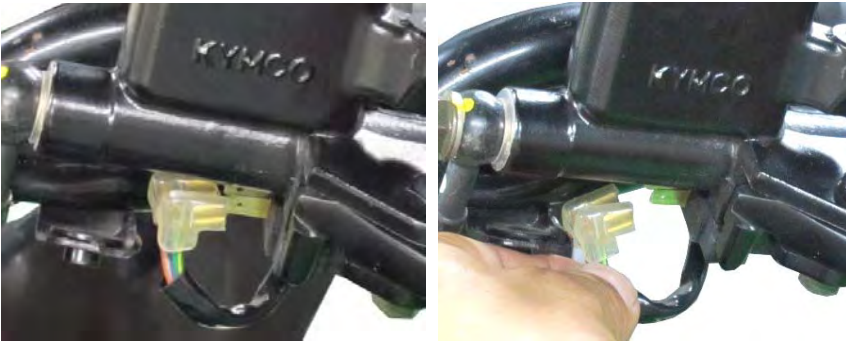

Unplug the brake light switch connectors.



Check for continuity between the brake light switch connectors. There should be continuity when the lever is pulled and none when released.

To remove the brake light switch see the [Master Cylinder](#) topic.

Remove the dash. See the [Dash](#) topic for more information.

Thermostatic Switch

See the [Radiator](#) topic.

KYMCO G-Dink 125i Specifications

General Information

Item	Standard	
Charging voltage of battery	> 12V	
Voltage from the ECU to every sensor	5±0.1V	
Fuel injector resistance (20°C/68°F)	10.6Ω~15.9Ω	
Throttle position sensor voltage	Idle (0°) = 0.23±0.05V Throttle fully (>90°) >3.27V	
O ² Sensor	O ² Sensor heater resistance (two white wires)	
		6.7Ω~9.5Ω
	Voltage	Air/Fuel < 14.7 (Rich)
Air/Fuel > 14.7 (Lean)		< 0.18V
Crank position sensor (Pulser) resistance (20°C/68°F)	96 Ω~144 Ω	
Inductive ignition coil resistance (20°C/68°F)	0.55Ω~0.75Ω (for primary coil)	
Roll sensor voltage	Normal: 0.4V~1.44V Over 65° fall down: 3.7V~4.4V	
Idle speed	1800±100 rpm	
Fuel Pump resistance	1.0 Ω ~ 6.0 Ω	
Fuel Pump Output pressure	2.5 Bar	
Fuel unit resistance (20°C/68°F)	F: about 7 Ω±3Ω	E: about 95 Ω±5Ω
Working Temperature	>80°C	
Water Temperature Sensor resistance (20°C~30°C)	2.075 kΩ±10%	

IGNITION SYSTEM G-DINK 125i

FIGURE 1-134. IGNITION SYSTEM FROM MOTOR OF COOPER
 (ENGINE IS IN POSITION FOR COIL AND PLUGS TO BE ADJUSTED)
 (ENGINE IS IN POSITION FOR PLUGS TO BE ADJUSTED)
 (ENGINE IS IN POSITION FOR PLUGS TO BE ADJUSTED)

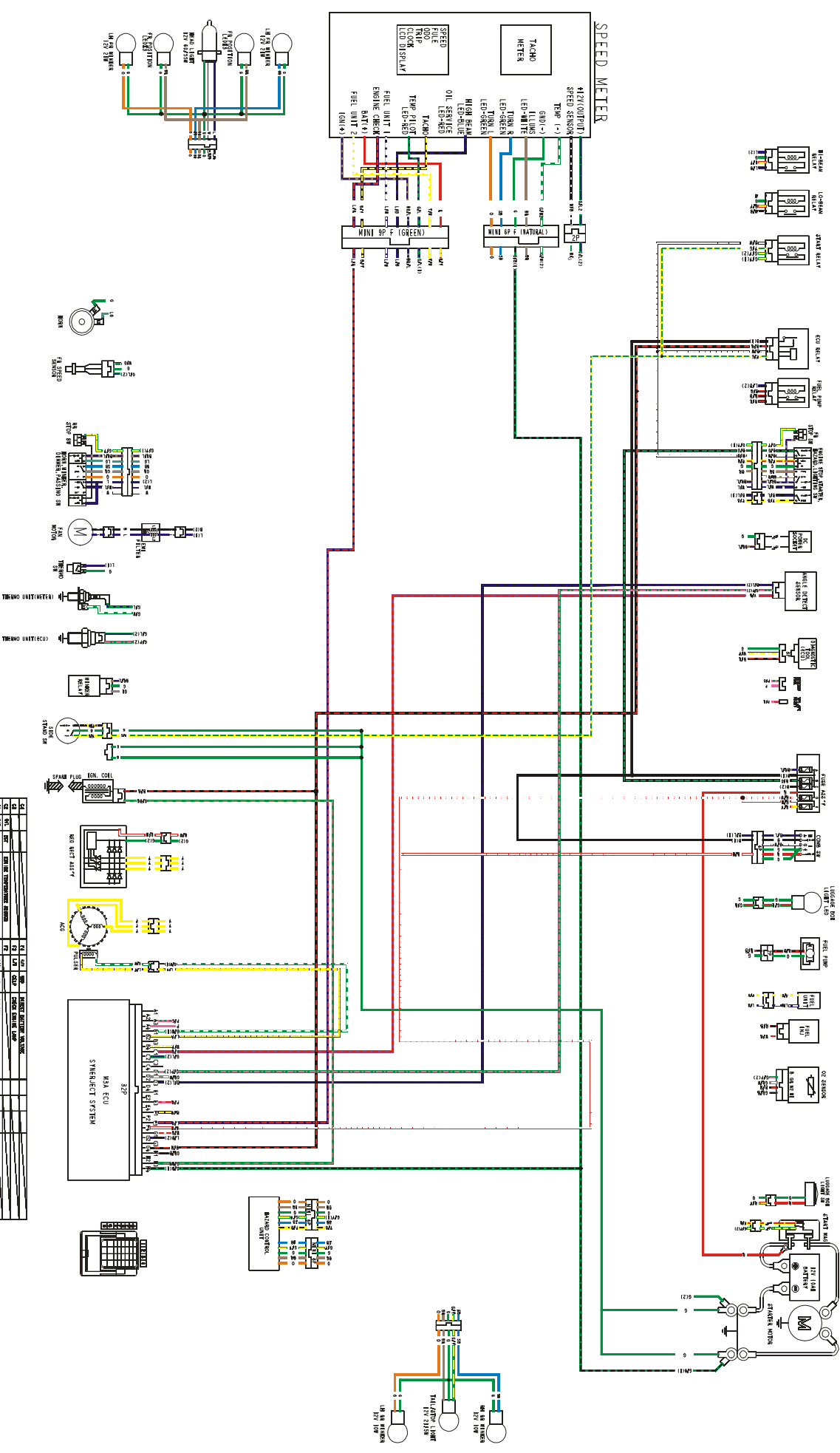

HAZARD SW	PASSING SW	STARTER SW	ENGINE STOP SW	IGNON SW	WINKER SW	DANGER SW	COMP SW	LIGHTING SW
OFF	OFF	OFF	OFF	OFF	OFF	OFF	OFF	OFF
ON	ON	ON	ON	ON	ON	ON	ON	ON
COLOR	COLOR	COLOR	COLOR	COLOR	COLOR	COLOR	COLOR	COLOR

WIRE NO.	WIRE COLOR	WIRE FUNCTION	WIRE NO.	WIRE COLOR	WIRE FUNCTION
1	RED	IGNITION	1	RED	IGNITION
2	GREEN	IGNITION	2	GREEN	IGNITION
3	BLUE	IGNITION	3	BLUE	IGNITION
4	BROWN	IGNITION	4	BROWN	IGNITION
5	BLACK	IGNITION	5	BLACK	IGNITION
6	WHITE	IGNITION	6	WHITE	IGNITION
7	YELLOW	IGNITION	7	YELLOW	IGNITION
8	PINK	IGNITION	8	PINK	IGNITION
9	GRAY	IGNITION	9	GRAY	IGNITION
10	ORANGE	IGNITION	10	ORANGE	IGNITION
11	VIOLET	IGNITION	11	VIOLET	IGNITION
12	SLATE	IGNITION	12	SLATE	IGNITION
13	INDIAN RED	IGNITION	13	INDIAN RED	IGNITION
14	MUSTARD YELLOW	IGNITION	14	MUSTARD YELLOW	IGNITION
15	SIENNA	IGNITION	15	SIENNA	IGNITION
16	SLATE	IGNITION	16	SLATE	IGNITION
17	INDIAN RED	IGNITION	17	INDIAN RED	IGNITION
18	MUSTARD YELLOW	IGNITION	18	MUSTARD YELLOW	IGNITION
19	SIENNA	IGNITION	19	SIENNA	IGNITION
20	SLATE	IGNITION	20	SLATE	IGNITION
21	INDIAN RED	IGNITION	21	INDIAN RED	IGNITION
22	MUSTARD YELLOW	IGNITION	22	MUSTARD YELLOW	IGNITION
23	SIENNA	IGNITION	23	SIENNA	IGNITION
24	SLATE	IGNITION	24	SLATE	IGNITION
25	INDIAN RED	IGNITION	25	INDIAN RED	IGNITION
26	MUSTARD YELLOW	IGNITION	26	MUSTARD YELLOW	IGNITION
27	SIENNA	IGNITION	27	SIENNA	IGNITION
28	SLATE	IGNITION	28	SLATE	IGNITION
29	INDIAN RED	IGNITION	29	INDIAN RED	IGNITION
30	MUSTARD YELLOW	IGNITION	30	MUSTARD YELLOW	IGNITION
31	SIENNA	IGNITION	31	SIENNA	IGNITION
32	SLATE	IGNITION	32	SLATE	IGNITION

KYMCO G-Dink 125i Diagnostic Report

	Item	Standard	Data	Remark
ECU Version	ECU No	---		
	Hardware Ver	---		
	Software Ver	QK0A00		
	Calibration Ver	O4LHG8QKAA		
	Model Name	LHG8		
(Cool Engine) EngineStop	Engine Temp.(Coiling)	environ.temp ± 2 °C		
	Air Temp.(°C)	environ.temp ± 2 °C		
	Atom. Pressure(Kpa)	101.3 ± 3 kPa		The ambient pressure drop about 12 kpa at the altitude every 1000m raised
	Throttle Position(%)	0° / >90°		Full Throttle: >90%
	Throttle Position Voltage (V)	0.23V ± 0.05 / >3.27V		Full Throttle Voltage: >3.27V
	TPI Idle Mean (V)	0.23 ± 0.05 V		
	Battery Voltage(V)	>12 V		
	Idle speed setpoint (rpm)	---		
	ABV Adap Mean (°)	---		
	Roll Sensor State	0.4 ~ 1.44 V(stand)		3.7~4.4V(fall down >65°)
	Accumulated eng. run time (hr)	---		
(Hot Engine) BeforeRepair	EngineSpeed IDLE(rpm)	1800 ± 100 rpm		Following data Engine Temp. > 80°C
	Engine Temp. (°C)	°C		
	Air Temp.(°C)	environ.temp ± 2 °C		
	Intake Pressure(Kpa)	46~57kpa		
	Fuel Inject Interval(ms)	1.5~2.5ms		
	Ignition Timing (°)	5°~17° BTDC		
	ABVAngDurMech (°)	< 140°		The throttle body should be cleaned if ABV opening over 140°
	O2 sensor voltage (V)	0 ~ 1 V		
	O2 sensor heater (OFF/ON)	ON		
	O2 sensor correct	± 20		
	IDLE CO(%)	0.4~1.5%		
	Ign.Dwell duration (ms)	1.5~2.5ms		
(Hot Engine) AfterRepair	EngineSpeed IDLE(rpm)	1800 ± 100 rpm		Following data Engine Temp. > 80°C
	Engine Temp. (°C)	°C		
	Air Temp.(°C)	environ.temp ± 2 °C		
	Intake Pressure(Kpa)	46~57kpa		
	Fuel Inject Interval(ms)	1.5~2.5ms		
	Ignition Timing (°)	5°~17° BTDC		
	ABVAngDurMech (°)	< 140°		The throttle body should be cleaned if ABV opening over 140°
	O2 sensor voltage (V)	0 ~ 1 V		
	O2 sensor heater (OFF/ON)	ON		
	O2 sensor correct	± 20		
	IDLE CO(%)	0.4~1.5%		
	Ign.Dwell duration (ms)	1.5~2.5ms		

Quick Reference

This chapter provides a quick reference source of technical specifications and information for KYMCO G-Dink 125i models.

- G-Dink 125i Specifications _____ 1-3
- Component Location _____ 4-6
- Special Tools _____ 7-9
- Torque Specifications _____ 10-12
- Troubleshooting _____ 13-18
- VIN and Engine Number Location _____ 19

KYMCO G-Dink 125i Specifications

General Information

	ITEM	G-DINK 125i						
SPECIFICATIONS								
	Overall length (mm)	2110						
	Overall width (mm)	775						
	Overall height (mm)	1255						
	Wheelbase (mm)	1450						
	GROUND CLEARANCE (mm)	120						
	Min.Turning radius R/L (mm)	2250 / 2250						
	Handle turning angle (L/R)	45 degree						
CAPACITY LOAD (kg)								
	Dry weight (kg)	157						
	Max.Weight capacity (kg)	25						
	Max. Horsepower (ps/rpm)	10.5 / 9000						
	Max. Speed (1 Person) km/hr	101						
ENGINE								
	Type	OHC, 4 stroke						
	Length* Width*Height (mm)	813.8×418.5×313.2						
	Dry weight (kg)	29.6						
	Valve train	OHC & CENTER PIVOT						
	Bore*Stroke (mm)	φ 54×54.5						
	Actual displacement (cc)	124.8						
	Cylinder arrangement	Single cylinder 2V						
	Cooling system	Liquid cooling						
	Lubrication type	Forced pressure & wet sump						
	Compression ratio	11.7						
	Max. Compressure (kg/cm ²)	15						
	Max.Torque (kg.m/rpm)	1.12 / 7000						
	Starting system	Starting motor						
SPARK PLUG								
	Specification STD.	NGK CR7E						
	Clearance (mm)	0.7						
	Idle speed (rpm)	1800±100						
VALVE TIMING								
	4∞							
	IN(degree) EX(degree)	<table style="margin-left: auto; margin-right: auto;"> <tr> <td style="text-align: center;">8</td> <td style="text-align: center;">6</td> </tr> <tr> <td style="text-align: center;">6.9</td> <td style="text-align: center;">+ 6.7</td> </tr> <tr> <td style="text-align: center;">31</td> <td style="text-align: center;">32</td> </tr> </table>	8	6	6.9	+ 6.7	31	32
8	6							
6.9	+ 6.7							
31	32							
VALVE CLEARANCE								
	4∞							
	IN.VALVE	0.1						
	EX.VALVE	0.1						
	Q'ty of piston ring	3						

	ITEM	G-DINK 125i
FUEL		
	Fuel type	92# nonleaded gasoline
	Air cleaner type	Paper element, wet
	Fuel tank capacity	12.5 L
	Fuel tank reserve capacity	2.2 L
THROTTLE BODY		
	Maker	KYMCO
	Type	THROTTLE BODY
	Number	1
	Size of bore (mm)	27
	Adjust control method	FUEL INJECTOR SYSTEM
	Fuel pump pressure	3.0 Bar Regulator
	Idle air adjust control method (kg/hr)	ABV magnetic valve
ELECTRICAL		
	Ignition timing	ECU controlled
	Ignition type	ECU
STARTER MOTOR		
	Capacity	0.6 KW
BATTERY		
	Type	MF
	Capacity	12V 8AH
	Charge*Time (A)*(HRS)	1.2A / 5~10hr
	Fuse STD. (A)	30A/15A/10A
Generator		
	Generator power	250W / 5000rpm
DRIVE		
TRANSMISSION		
	Type	CVT
	Operation	Non-stage transmission
GEAR RATIO		
	Clutch type	Dry multi-disc clutch
	Primary reduction ratio	0.83~2.2
	Final reduction ratio	10.41
FRAME		
	Type	UNDER BONE
TIRE		
	Type	TUBELESS
	STD.(FR/RR)	FR:120/70-13 RR:140/70-12
	Wheel material	Aluminium
PRESSURE FR/RR (kgf/cm²)		
	1 Person	2.0 / 2.25
	2 Persons	2.0 / 2.25
BRAKE SYSTEM		
	Type (FR/RR)	DISK
	Diameter FR/RR (mm)	FR:240 RR:200
	Disk thickness FR/RR (mm)	4.0 / 5.0

	ITEM	G-DINK 125i
	SUSPENSION	
	Type(FR/RR)	TELESCOPE/ SWING ARM
	Stroke (FR/RR)	110 / 100
	LUBRICATION	
	ENGINE OIL	
	Oil pump type	Inner/outer rotor type
	Capacity type	1100 cc , 15W40
	Exchanging capacity	900 cc
	Oil filter type	Filter
	GEAR OIL	
	Capacity type	0.23L #90
	Exchanging capacity	0.18L
	LIGHT	
	HEAD LIGHT	
	Type High/Low	12V 60W/55W
	LICENCE LIGHT	
	Type	12V / 5W
	TURN SIGNAL LIGHT	
	Type	12V Front 21W / Rear 10W
	TAIL LIGHT	
	Type	12V 21W / 5W
	STOP LIGHT	
	Type	12V / 21W
	POSITION LIGHT	
	Type	12V 0.6W / 12V 5W

12. Quick Reference > Component Location**Component Location**

- Winker Relay (Turn Signal Relay)



- Horn
- DC Power Socket

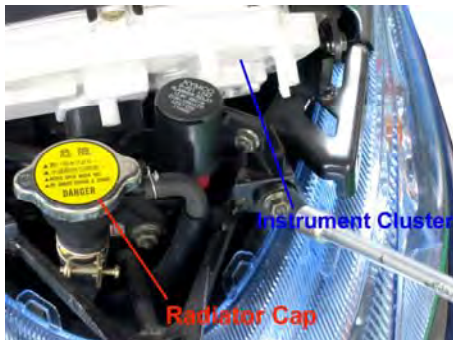

- Instrument Cluster
- Radiator Cap

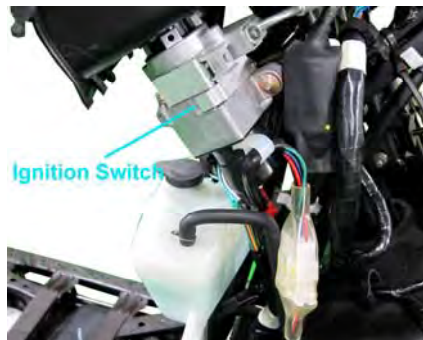

- Ignition Switch

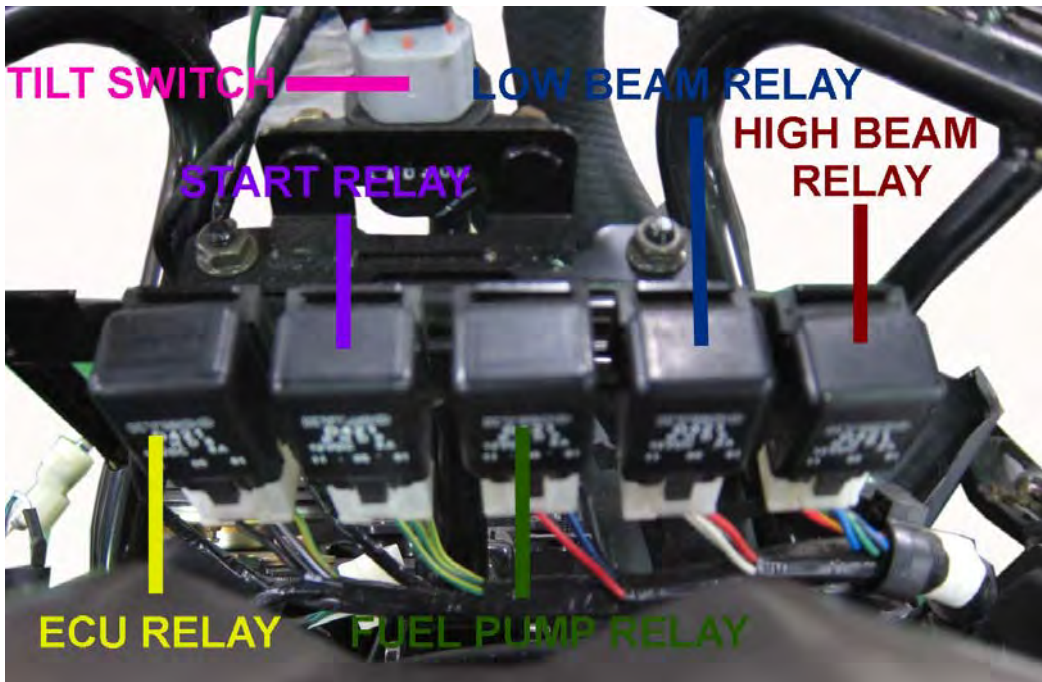
12. Quick Reference > Component Location

- Fuel Pump Relay
- Tilt Switch
- ECU Relay
- High Beam Relay
- Low Beam Relay
- Start Relay

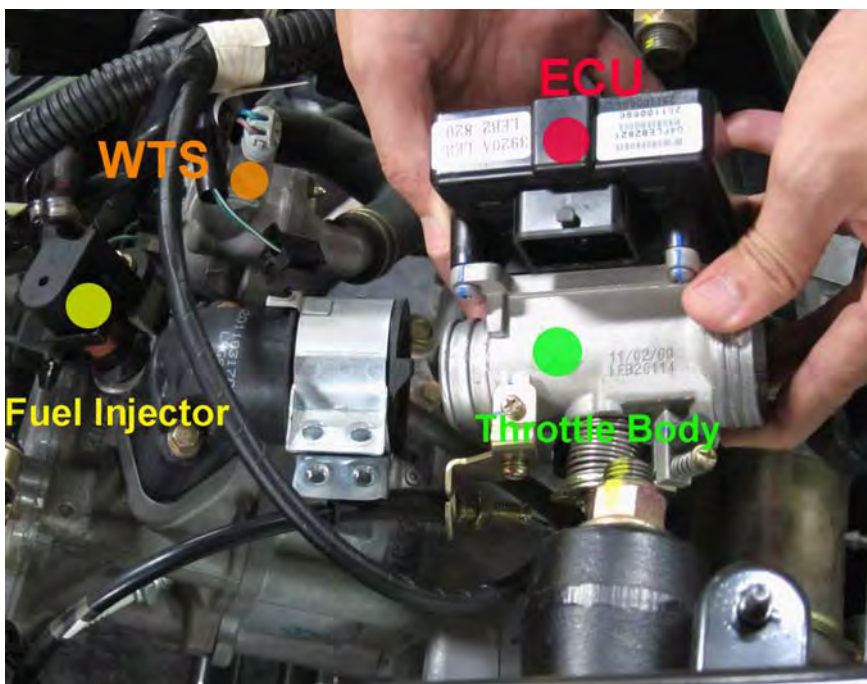

- Throttle Body
- ECU
- Fuel Injector
- WTS

12. Quick Reference > Component Location

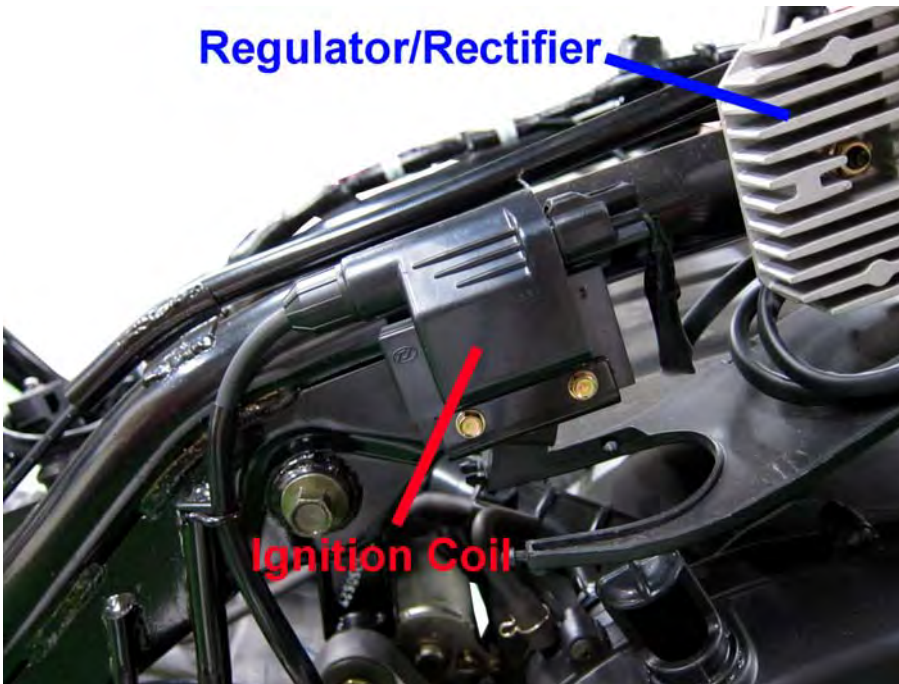

- Regulator/Rectifier
- Ignition Coil



- Starter Relay



- Oxygen Sensor (O² sensor)

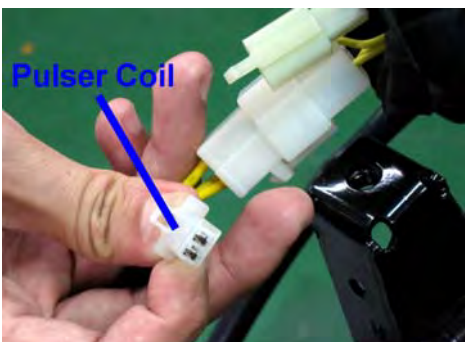

- Stator and Crank Pulse Sensor (Pulser Coil)

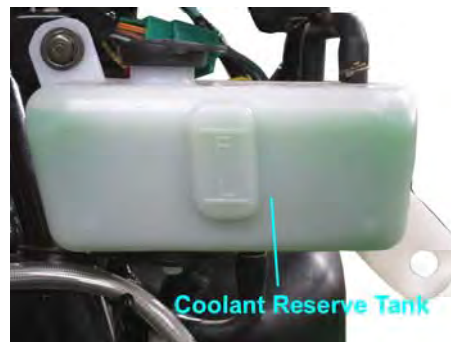

- Coolant Reserve Tank

Special Tools

Description	Tool No.	Photo
Flywheel puller	A120E00003	
Oil seal and bearing installer	A120E00014	
Universal holder	A120E00017	
Flywheel holder	A120E00021	
Clutch spring compressor	A120E00034	
Valve adjuster	A120E00036	
Bearing puller	A120E00037	
Cylinder Compression Gauge	A120E00039	

Description	Tool No.	Photo
Valve spring compressor	A120E00040	
Fuel Pressure Gauge	A120E00048	
INJECTOR CLEANER for Synerjet	A120E00075	
Wires Injector Connector	A120E00090	
Lock nut wrench	A120F00002	
Lower/Upper Race Remover & Installer	A120F00008	
Steering Stem Top Thread Wrench (shoter type)	A120F00024	
Steering Stem Top Thread Wrench	A120F00029	
Band Remover/Installer	A120F00030	
Pliers Fuel Pipe	A120F00031	

Description	Tool No.	Photo
Electric Repair Kit	A120F00032	

Torque Specifications

Engine Torque Specifications

No.	ITEM	THREAD SIZE AND TYPE	TORQUE		PR VALUES N·m	REMARKS	THREAD DWG. NO.
			N·m	kgf·m			
1	BOLT, A STUD 8X218	M8X1.25	6.9~10.8	0.7~1.1	8.9	STUD SIDE	90031-KBED-9000
2	BOLT, B STUD 8X210	M8X1.25	6.9~10.8	0.7~1.1	8.9	STUD SIDE	90032-KBED-9000
3	TAPPET ADJ HOLE CAP	M30X1.5	9.8~19.6	1.0~2.0	14.7		12361-035-0006
4	L COVER	SHF M6X1.0	9.8~13.7	1.0~1.4	11.8		96001-06040
5	BREATHER TUBE CLAMPER	TAPPING SCREW 5mm	3.5~4.9	0.35~0.50	4.2		93904-35380
6	CYLINDER HEAD	STUD M6X1.0	6.9~10.8	0.7~1.1	8.9	INLET PIPE AREA EX PIPE AREA	96001-06040
		STUD M8X1.25	6.9~10.8	0.7~1.1	8.9		90033-GY6-9000
7	CAM SHAFT HOLDER	N.F. M8X1.25	17.7~21.6	1.8~2.2	19.7	APPLY OIL	94050-08000
8	TAPPET ADJ NUT	M5X0.5	6.9~10.8	0.7~1.1	8.9	APPLY OIL	90206-001-0007
9	CAM CHAIN TENSIONER PIVOT	SPECIAL BOLT M8X1.25	11.8~15.7	1.2~1.6	9.8		14531-KJ9-0000
10	TENSIONER LIFTER	SHF M6X1.0	9.8~13.7	1.0~1.4	11.8		91001-06022
11	CAM CHAIN ADJUST BOLT	SPECIAL M8X1.25	3.9~6.9	0.4~0.7	5.4		14552-KS4-0030
12	OIL PUMP	SCR. PAN M3X0.5	1.0~2.9	0.1~0.3	2.0		93500-03010-1A
13	MISSION CASE	FB M6X1.0	9.8~13.7	1.0~1.4	11.8		91001-06040
		FB M6X1.0	9.8~13.7	1.0~1.4	11.8		90004-KN7-0710
14	MISSION CHECK /DRAIN BOLT	FB 10X12	9.8~14.7	1.0~1.5	12.8		95701-10012-00
	DRIVE FACE	M12X1.25	53.9~63.7	5.5~6.5	58.8		94001-12200-08
15	CLUTCH OUTER	N.F. M12X1.25	49~58.9	5.0~6.0	54		90201-PB8-0001
16	DRIVE PLATE COMP	M28X1.0	49~58.9	5.0~6.0	54		90202-KN7-6701
17	ONE WAY CLUTCH	BOLT SOCKET M6X1.0	9.8~13.7	1.0~1.4	11.8	APPLY THREAD LOCK	90001-KN7-6700
18	ACG FLYWHEEL	N.F. M14	49~58.9	5.0~6.0	54		90201-KR8-7510
19	OTHERS	SH BOLT	7.8~11.8	0.8~1.2	9.8		

General Torque Specifications

ITEM	N·m	kgf·m	ITEM	N·m	kgf·m
5 mm bolt and nut	4.4~6	0.45~0.6	5mm screw	3.4~5	0.35~0.5
6 mm bolt and nut	8~12	0.8~1.2	6mm screw and flange bolt(SH TYPE)	7~11	0.7~1.1
8 mm bolt and nut	18~25	1.8~2.5	6mm flange bolt and nut	10~14	1.0~1.4
10 mm bolt and nut	29~39	3.0~4.0	8 mm flange bolt and nut	24~29	2.4~3.0
12 mm bolt and nut	49~59	5.0~6.0	10 mm flange bolt and nut	34~44	3.5~4.5

Frame Torque Specifications

No.	ITEM	THREAD SIZE AND TYPE	TORQUE		PRM Kgf-m	REMARK	THREAD DWG NO.
			Kgf-m	N-m			
1	STEERING						
	HANDLE POST	M10x1.25	6.0~7.0	60~70	6.5	U NUT	90106-GEN5-9000
	BRIDGE BOLT	M8x1.25	2.4~3.0	24~30	2.7	—	95801-08040-08
	STEM LOCK	BC1	6.0~6.5	60~65	6.3	—	50306-1F96-0010
	RACE NUT(HEAD)	BC1	1.8~2.2	18~22	2.0	—	53220-LBA2-E000
2	WHEEL						
	FR.AXLE	M14x1.5	1.5~2.5	15~25	2.0	—	44301-LLJ3-E000
	RR.AXLE NUT	M16x1.5	11~13	110~130	12	U NUT	90305-KFW6-9120-M1
3	SUSPENSION						
	FR FORK BOLT	M8x1.25	2.0~2.6	20~26	2.3	—	96600-08025-06
	RR. CUSH. UP	M10x1.25	3.5~4.5	35~45	4.0	U NUT	90304-GHE8-0040
	RR. CUSH. LWR	M8x1.25	2.4~3.0	24~30	2.7	—	95801-08030-06
4	BRAKE						
	FR CALIPER R	M10x1.25	3.0~4.0	30~40	3.5	—	90122-LEA7-E000
	RR CALIPER	M10x1.25	3.0~4.0	30~40	3.5	—	90122-LEA7-E000
	BRK OIL BOLT	M10x1.25	3.0~4.0	30~40	3.5	—	90145-MS9-6120-M1
	M/C HOLDER	M6x1.0	1.0~1.4	10~14	1.2	—	96001-06028-06
	M/C CAP SCREW	M4x0.7	0.12~0.2	1.2~2.0	0.16	—	96000-04012-1A
	C/P BLEEDER	M8x1.25	0.4~0.7	4.0~7.0	0.55	—	43352-5H68-0040
	DISK BOLT	M8x1.25	3.2~3.8	32~38	3.5	—	90105-KCR3-0010
	C/P PIN BOLT	M12x1.25	3.4~4.6	34~46	4.0	—	45131-LDHI-E000
5	ENG HANGER						
	FRAME SIDE	M14x1.5	6.0~7.0	60~70	6.5	U NUT	90305-LBD4-9000
	ENG SIDE	M10x1.25	4.5~5.5	45~55	5.0	U NUT	90304-GLW0-9020-M1
6	MUFFLER						
	EXH. PIPE	M8x1.25	1.8~2.2	18~22	2.0	—	90033-GFY6-9000
	MUFF. BRKT/RR FORK	M8x1.25	3.0~3.6	30~36	3.3	—	95801-08042-06
7	RR FORK/ENG CASE	M8x1.25	2.4~3.0	24~30	2.7	—	90131-KFAF-9000
8	OTHER						
	IGN COIL	M6x1.0	0.25~0.35	2.5~3.5	0.3	—	94050-06080
	O2 SENSOR	M12x1.25	2.0~3.0	20~30	2.5	—	—
	START RELAY	M6x1.0	0.25~0.35	2.5~3.5	0.3	—	94050-06080
	RR CARRIER	M8x1.25	2.0~2.8	20~28	2.4	—	90106-KKC4-9000
	SW ASSY THERMO	M16x1.5	2.0~2.5	20~25	2.25	—	37760-LBB5-E000

12. Quick Reference > Torque Specifications
General Torque Specifications

ITEM	TORQUE		ITEM	TORQUE	
	Kgf-m	N-m		Kgf-m	N-m
5mm bolt and nut	0.45~0.6	4.5~6	4mm screw	0.05~0.15	0.5~1.5
6mm bolt and nut	0.8~1.2	8~12	4mm screw	0.20~0.40	2~4
8mm bolt and nut	1.8~2.5	18~25	5mm screw	0.10~0.30	1~3
10mm bolt and nut	3.0~4.0	30~40	5mm screw	0.35~0.5	3.5~5
12mm bolt and nut	5.0~6.0	50~60	6mm screw and flange bolt (SH TYPE)	0.7~1.1	7~11
			6mm flange bolt and nut	1.0~1.4	10~14
			8mm flange bolt and nut	2.4~3.0	24~30
			10mm flange bolt and nut	3.5~4.5	35~45

12. Troubleshooting

Troubleshooting

Vehicle can not be started

Preliminary 6 Step Inspection

1. Is the battery fully charged (12 V or higher). See the [Battery](#) topic for more information.
2. Key-On and listen for any action with Fuel Pump / Fuel Pump Relay (It will turn off automatically in 5-10 seconds)
3. Key-On to check for any failure lamp light up on dashboard. See the [Self-Diagnosis](#) topic for more information.
4. Is the Idle screw of Throttle Valve being changed or loose?
5. Has the vehicle under regular service? Is the gas station a good one?
6. Is the spark plug the correct model of specified by the vehicle builder? See the [SparkPlug](#) topic for more information.

Troubleshooting by section

- [Brakes](#)
- [Cooling System](#)
- [CVTContinuouslyVariable Transmission](#)
- [Electrical Systems](#)
- [Engine](#)
- [FinalDrive](#)
- [FrontSuspension](#)
- [FuelInjectionSystem](#)
- [Rear Suspension](#)
- [Steering](#)
- [Wheels](#)

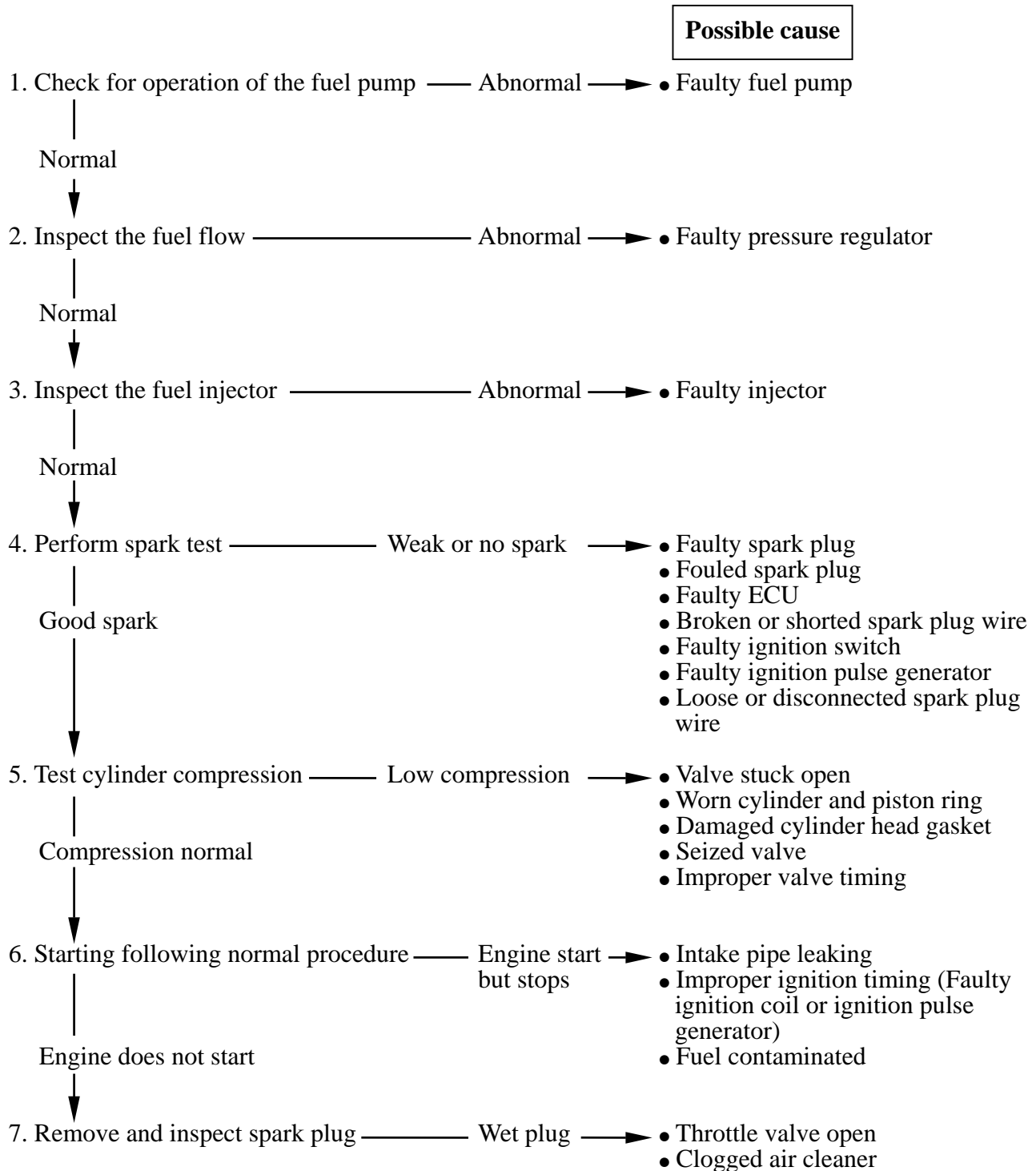
12. Troubleshooting
General Troubleshooting
ENGINE WILL NOT START OR IS HARD TO START

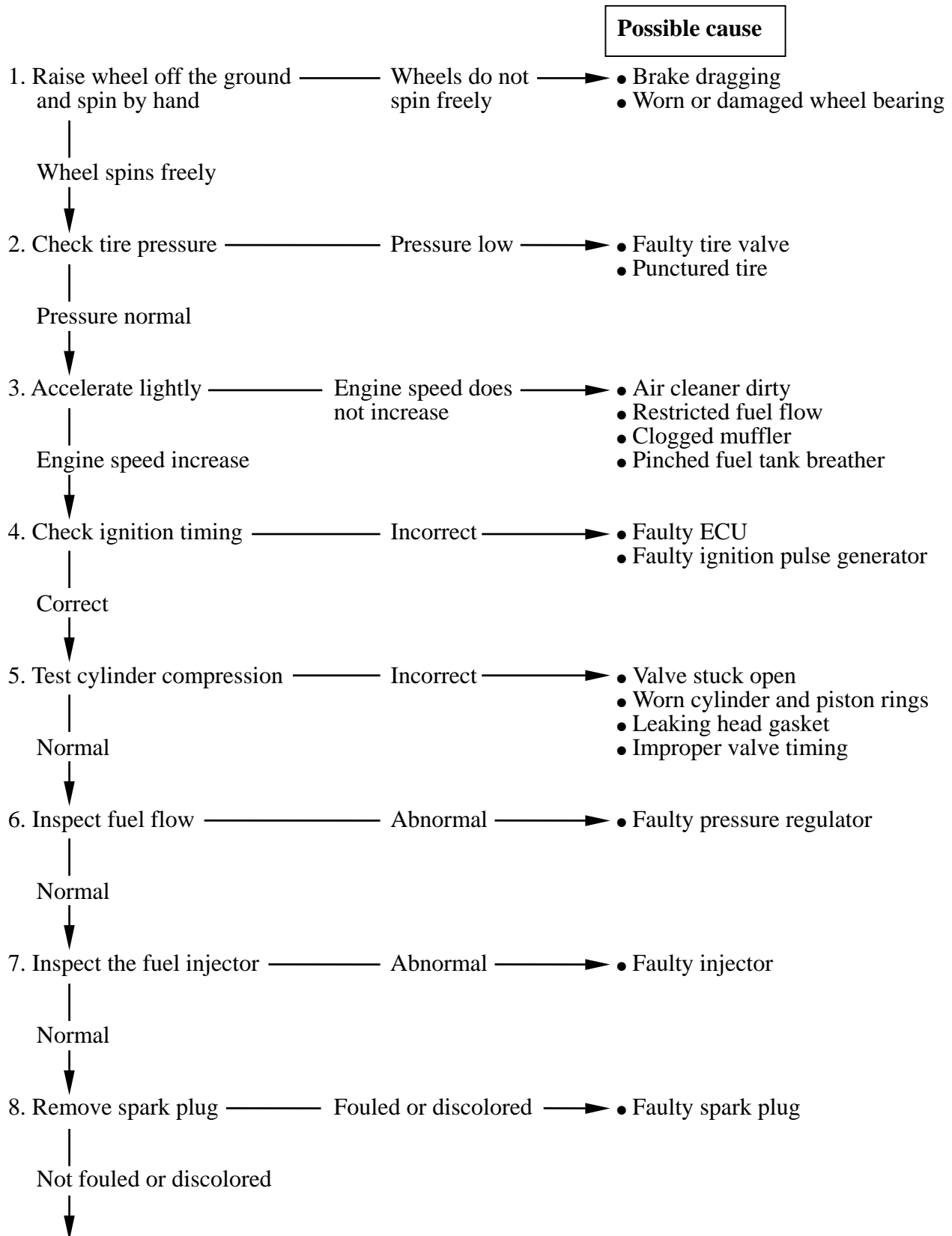
12. Troubleshooting
ENGINE LACKS POWER

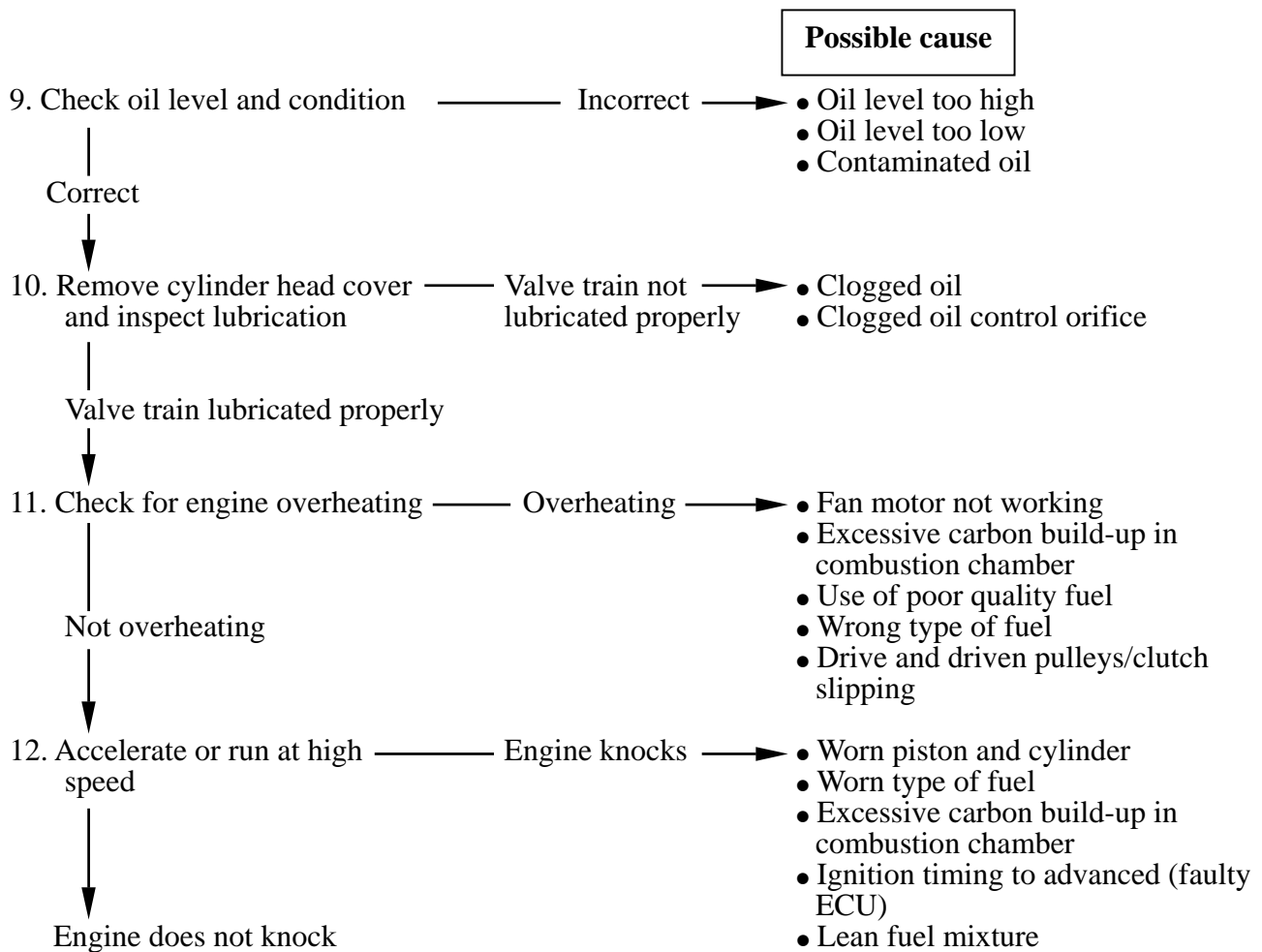
12. Troubleshooting

12. Troubleshooting**POOR PERFORMANCE AT LOW AND IDLE SPEED**

Possible cause

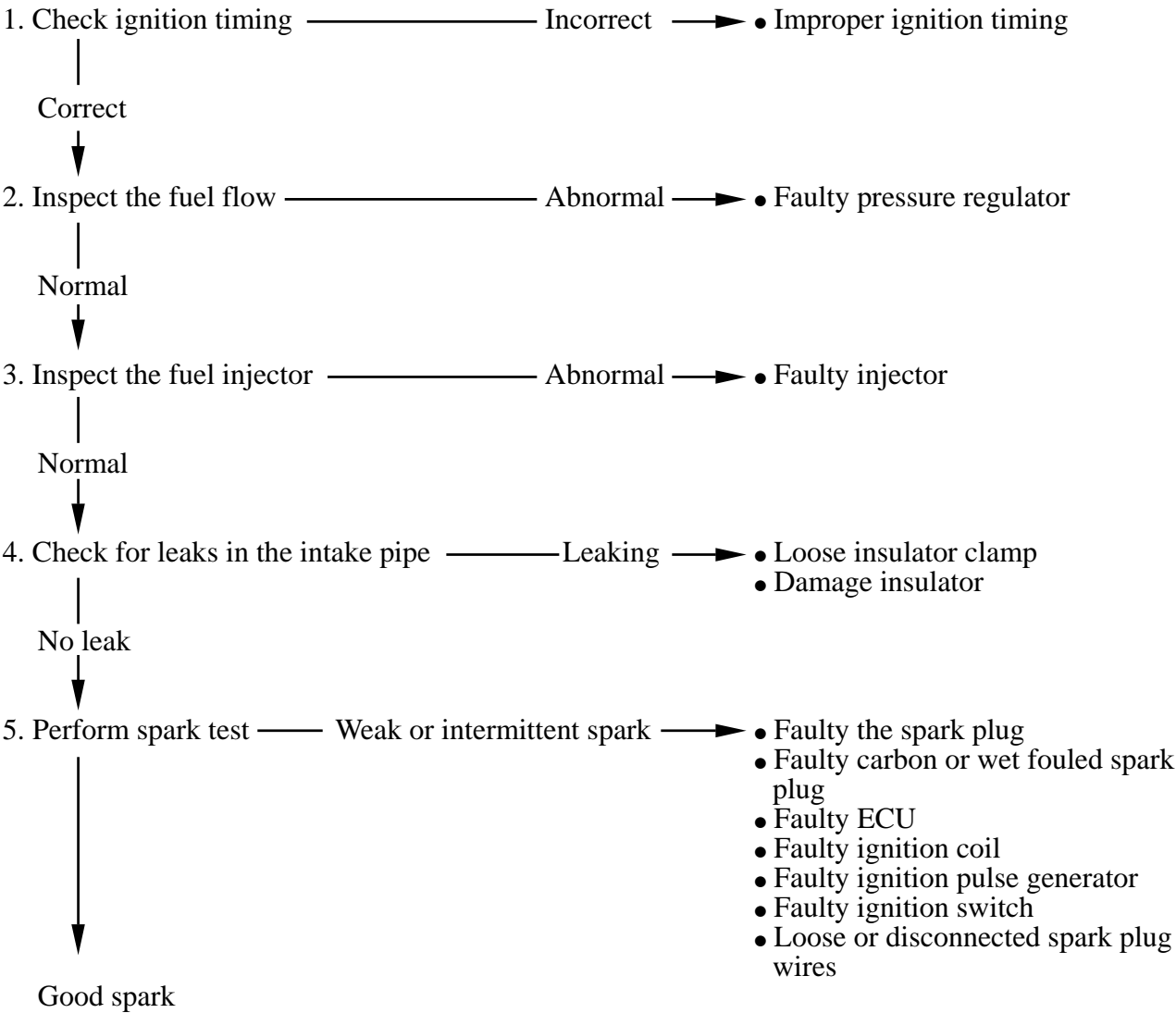

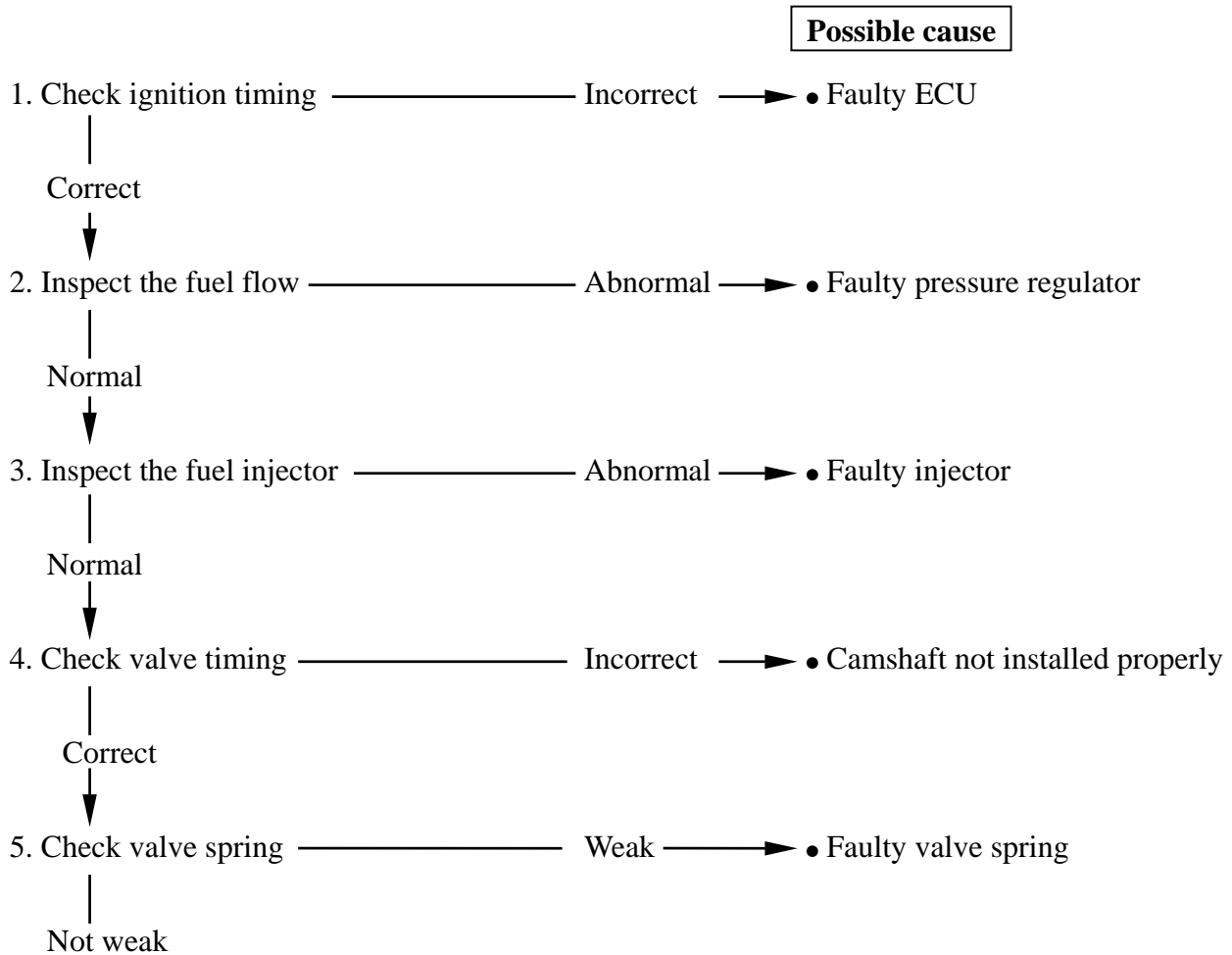
12. Troubleshooting
POOR PERFORMANCE AT HIGH SPEED

POOR HANDLING

		Possible cause
1. If steering is heavy	→	<ul style="list-style-type: none"> • Steering stem adjusting nut too tight • Damaged steering head bearings
2. If either wheel is wobbling	→	<ul style="list-style-type: none"> • Excessive wheel bearing play • Bent rim • Improper installed wheel hub • Swing arm pivot bearing excessively worn • Bent frame
3. If the motorcycle pulled to one side	→	<ul style="list-style-type: none"> • Faulty the shock absorber • Front and rear wheel not aligned • Bent fork • Bent swing arm • Bent axle

12. Quick Reference > VIN and Engine Number Location**VIN and Engine Number Location**

The VIN is stamped on the body frame under the luggage box.



The engine serial number is stamped on bottom of the left crankcase.