

**By KWANG YANG Motor Co., Ltd.
1st Edition, ,Mar. 2012
All rights reserved. Any reproduction or
unauthorized use without the written
permission of KWANG YANG Motor Co., Ltd.
is expressly prohibited.
T300-LHG7-A1**

PREFACE

This Service Manual describes the technical features and servicing procedures for the KYMCO **G-DINK 300i**.

Section 1 contains the precautions for all operations stated in this manual. Read them carefully before any operation is started.

Section 2 is the removal/installation procedures for the frame covers which are subject to removal/installation frequency during maintenance and servicing operations.

Section 3 describes the inspection/adjustment procedures, safety rules and service information for each part, starting from periodic maintenance.

Sections 5 to 12 give instructions for disassembly, assembly and adjustment of engine parts. Section 13 is the AFI system. Section 14 to 15 is the removal/ installation of chassis. Section 16 to 19 states the testing and measuring methods of electrical equipment.

Most sections start with an assembly or system illustration and troubleshooting for the section. The subsequent pages give detailed procedures for the section.

The information and contents included in this manual may be different from the motorcycle in case specifications are changed.

TABLE OF CONTENTS

ENGINE	GENERAL INFORMATION	1
	EXHAUST MUFFLER/FRAME COVERS	2
	INSPECTION/ADJUSTMENT	3
	LUBRICATION SYSTEM	4
	ENGINE REMOVAL/INSTALLATION	5
	CYLINDER HEAD/VALVES	6
	CYLINDER/PISTON	7
	DRIVE AND DRIVEN PULLEYS/V-BELT	8
	FINAL REDUCTION	9
	A.C. GENERATOR/STARTER CLUTCH	10
	CRANKCASE/CRANKSHAFT	11
	COOLING SYSTEM	12
	FUEL INJECTION SYSTEM	13
CHASSIS	STEERING HANDLEBAR/FRONT WHEEL/FRONT BRAKE/FRONT SHOCK ABSORBER/FRONT FORK	14
	REAR BRAKE/REAR FORK/REAR WHEEL/REAR SHOCK ABSORBER	15
ELECTRICAL EQUIPMENT	BATTERY/CHARGING SYSTEM	16
	IGNITION SYSTEM	17
	STARTING SYSTEM	18
	LIGHTS SWITCHES / FUEL PUMP	19

KWANG YANG MOTOR CO., LTD.
QUALITY TECHNOLOGY DEPT.
EDUCATION SECTION

1. GENERAL INFORMATION



GENERAL INFORMATION

SERIAL NUMBER	1-1
SPECIFICATION	1-2
SERVICE PRECAUTIONS	1-5
TORQUE VALUES	1-9
SPECIAL TOOLS	1-11
LUBRICATION POINTS	1-12
CABLE & HARNESS ROUTING	1-14
TROUBLESHOOTING	1-15

1. GENERAL INFORMATION

Identification Numbers Record

Identification Numbers Record

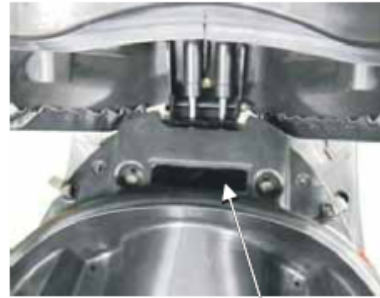

①

②

③

1. VEHICLE IDENTIFICATION NUMBER (VIN)**2. ENGINE SERIAL NUMBER (ESN)****3. FRAME SERIAL NUMBER (VIN)**

Record the Vehicle Identification Number ①, Engine Serial Number ② and Frame Serial Number ③ in the boxes above for future reference (to assist you in ordering parts from your authorized KYMCO dealer or for reference in case the vehicle is stolen).

1. GENERAL INFORMATION

SPECIFICATIONS

Oil filter type	Full-flow filtration	
Oil capacity	1.1 liter	
Exchanging capacity	0.9 liter	
Fi injection system		
Air cleaner type & No	Paper element, wet	
Fuel capacity	9 liters	
Brand	Keihin	
Throttle Body	Butterfly type	
Venturi diameter (mm)	32	
Fuel pump pressure	3 bar	
Electrical system		
Ignition type	ECU	
Ignition timing	9° BTDC / idle 36° / 6500min	
Spark plug	DPR6EA	
Spark plug gap	0.9mm	
Battery Capacity	12V10AH	
Transmission system		
Clutch type	Dry multi-disc	
Transmission type	CVT	
Operation type	Auto centrifugal	
Reduction gear type	Two-stage reduction	
Reduction ratio	1 st	0.72 ~ 2.24
	2 nd	7.222
Moving device		
Tire type	Tubeless	
Tire spec.	Front wheel	120/70-13
	Rear wheel	140/70-12
Tire pressure (kg/cm ²)	Front wheel	1.75
	Rear wheel	2.0
Wheel material	Aluminium	
Turning angle	Left	40°
	Right	40°
Brake type	Front	Disk brake
	Rear	Disk brake
Damping Device		
Suspension type	Front	Telescope
	Rear	Swing arm
Shock absorber stroke	Front	95 mm
	Rear	90 mm

Name	G-DINK 300i	
Model No.	SH60AA	
Overall length	2090 mm	
Overall width	770 mm	
Overall height	1360 mm	
Wheel base	1450 mm	
Engine type	4 stroke O.H.C.	
Displacement	270.6 cc	
Fuel Used	92# nonleaded gasoline above	
Curb weight (kg)	Front wheel	61
	Rear wheel	99
	Total	160
Max. weight capacity (kg)	Front wheel	105
	Rear wheel	228
	Total	333
Ground clearance (mm)	140	
Braking distance (m)	7.9m / 40 km/hr	
Min. turning radius (mm)	2350	
Engine part		
Starting system	Starting motor	
Type	Gasoline 4-cycle	
Cylinder arrangement	Single cylinder	
Combustion chamber type	Semi-sphere	
Valve arrangement	O.H.C.-4V	
Bore x stroke (mm)	φ 72.7 * 65.2	
Compression ratio	10.6:1	
Compression pressure (kg/cm ²)	15	
Max. output (ps/rpm)	22.8 / 8000	
Max. torque (kg-m/rpm)	22.5 / 6500	
Intake Timing	Open	9° BTDC
	Close	36° BTDC
Exhaust Timing	Open	42° BTDC
	Close	7° BTDC
Valve clearance	Intake	0.10
	Exhaust	0.10
Idle speed (rpm)	1600±100 rpm	
Cooling Type	Liquid cooling	
Lubrication type	Forced pressure & wet sump	
Oil pump type	Inner/outer rotor	

1. GENERAL INFORMATION

SERVICE PRECAUTIONS

- Make sure to install new gaskets, O-rings, circlips, cotter pins, etc. when reassembling.

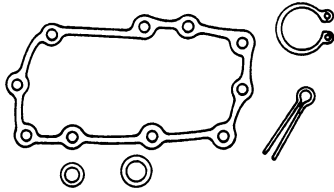

- When tightening bolts or nuts, begin with larger-diameter to smaller ones at several times, and tighten to the specified torque diagonally.

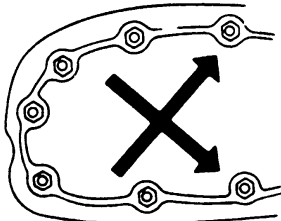

- Use genuine parts and lubricants.

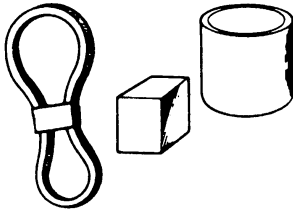

- When servicing the motorcycle, be sure to use special tools for removal and installation.



- After disassembly, clean removed parts. Lubricate sliding surfaces with engine oil before reassembly.

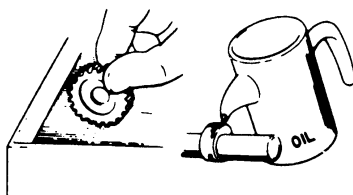

- Apply or add designated greases and lubricants to the specified lubrication points.

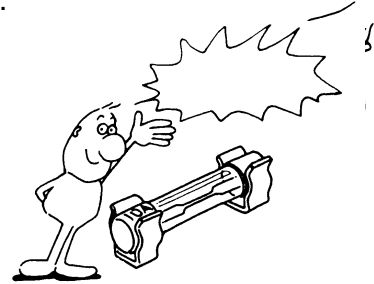

- When two persons work together, pay attention to the mutual working safety.

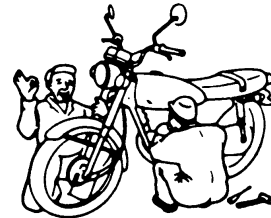

- Disconnect the battery negative (-) terminal before operation.
- When using a spanner or other tools, make sure not to damage the motorcycle surface.

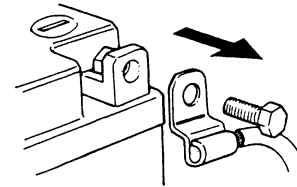

- After operation, check all connecting points, fasteners, and lines for proper connection and installation.
- When connecting the battery, the positive (+) terminal must be connected first.
- After connection, apply grease to the battery terminals.
- Terminal caps shall be installed securely.

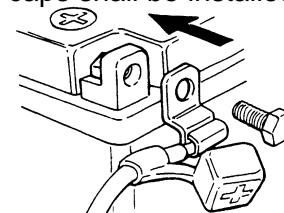

- If the fuse is burned out, find the cause and repair it. Replace it with a new one according to the specified capacity.

1. GENERAL INFORMATION

- After operation, terminal caps shall be installed securely.

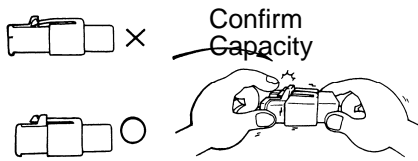

- When taking out the connector, the lock on the connector shall be released before operation.

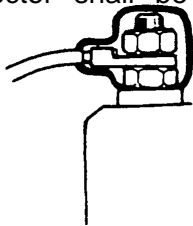

- Hold the connector body when connecting or disconnecting it.
- Do not pull the connector wire.

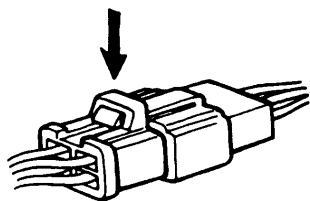

- Check if any connector terminal is bending, protruding or loose.



- The connector shall be inserted completely.
- If the double connector has a lock, lock it at the correct position.
- Check if there is any loose wire.

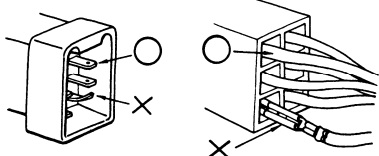

- Before connecting a terminal, check for damaged terminal cover or loose negative terminal.

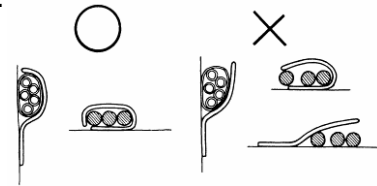

- Check the double connector cover for proper coverage and installation.

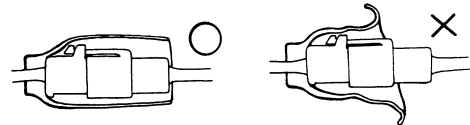

- Insert the terminal completely.
- Check the terminal cover for proper coverage.
- Do not make the terminal cover opening face up.

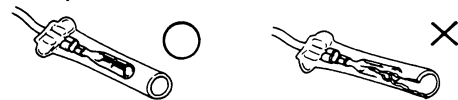

- Secure wire harnesses to the frame with their respective wire bands at the designated locations. Tighten the bands so that only the insulated surfaces contact the wire harnesses.

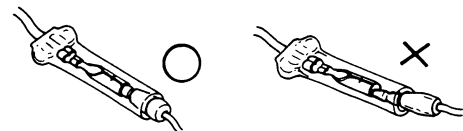

- After clamping, check each wire to make sure it is secure.

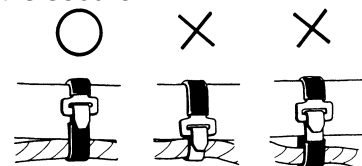

1. GENERAL INFORMATION

- Do not squeeze wires against the weld or its clamp.

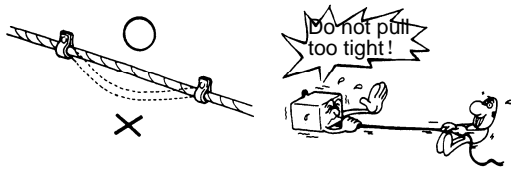

- After clamping, check each harness to make sure that it is not interfering with any moving or sliding parts.



- When fixing the wire harnesses, do not make it contact the parts that will generate high heat.

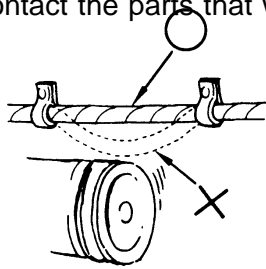

- Route wire harnesses to avoid sharp edges or corners. Avoid the projected ends of bolts and screws.
- Route wire harnesses passing through the side of bolts and screws. Avoid the projected ends of bolts and screws.

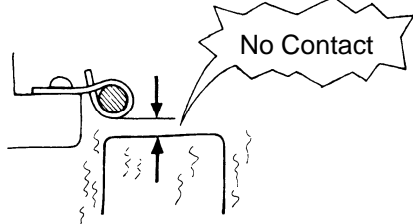

- Route harnesses so they are neither pulled tight nor have excessive slack.

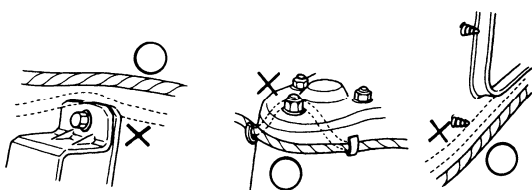

- Protect wires and harnesses with electrical tape or tube if they contact a sharp edge or corner.

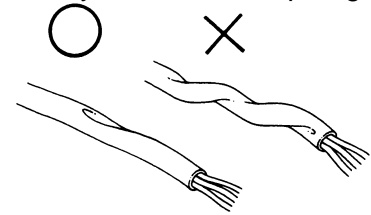

- When rubber protector cover is used to protect the wire harnesses, it shall be installed securely.

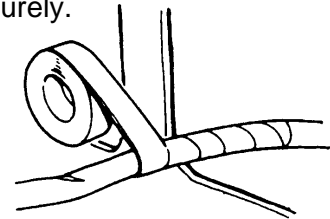

- Do not break the sheath of wire.
- If a wire or harness is with a broken sheath, repair by wrapping it with protective tape or replace it.

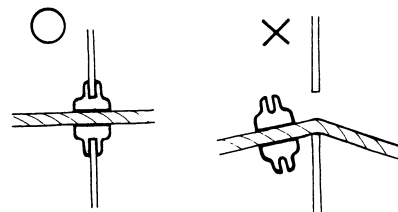

- When installing other parts, do not press or squeeze the wires.

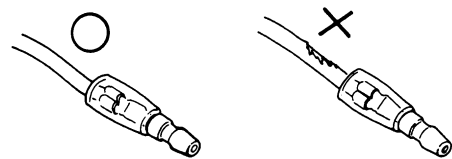

- After routing, check that the wire harnesses are not twisted or kinked.

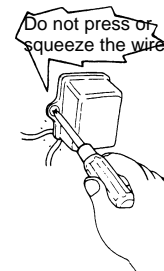

1. GENERAL INFORMATION

- Wire harnesses routed along with handlebar should not be pulled tight, have excessive slack or interfere with adjacent or surrounding parts in all steering positions.

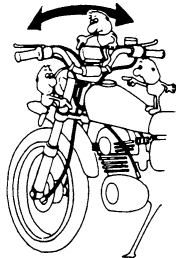

- When a testing device is used, make sure to understand the operating methods thoroughly and operate according to the operating instructions.

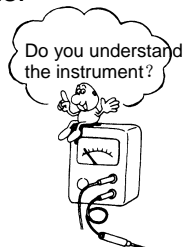

- Be careful not to drop any parts.

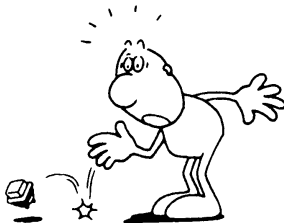

- When rust is found on a terminal, remove the rust with sand paper or equivalent before connecting.



1. GENERAL INFORMATION

■ Symbols:

The following symbols represent the servicing methods and cautions included in this service manual.



: Apply engine oil to the specified points. (Use designated engine oil for lubrication.)



: Apply grease for lubrication.



: Transmission Gear Oil (90#)



: Use special tool.



: Caution



: Warning

1. GENERAL INFORMATION

G-DINK 300i

TORQUE VALUES

STANDARD TORQUE VALUES

Item	Torque (kgf-m)	Item	Torque (kgf-m)
5mm bolt, nut	0.45~0.6	5mm screw	0.45~0.6
6mm bolt, nut	0.8~1.2	6mm screw, SH bolt	0.7~1.1
8mm bolt, nut	1.8~2.5	6mm flange bolt, nut	1.0~1.4
10mm bolt, nut	3.0~4.0	8mm flange bolt, nut	2.4~3.0
12mm bolt, nut	5.0~6.0	10mm flange bolt, nut	3.0~4.5

ENGINE

Item	Q'ty	Thread dia.(mm)	Torque N•m (kgf•m, lbf•ft)	Remarks
MAINTENANCE:				
Valve adjusting lock nut	2	5	9 (0.9, 6.5)	Apply oil
Spark plug	1	10	12 (1.2, 9)	
Transmission oil drain bolt	1	12	20 (2, 15)	
Transmission oil check/fill bolt	1	8	20 (2, 15)	
Crank case oil drain bolt	1	12	25 (2.5, 18)	
Oil filter screen cap	1	30	15 (1.5, 10.8)	Apply oil
LUBRICATION SYSTEM:				
Oil pump screw	1	3	2 (0.2, 1.4)	
COOLING SYSTEM:				
Water pump impeller	1	7	12 (1.2, 8.6)	Left screw
CYLINDER HEAD:				
Cylinder head cap nut	4	8	25 (2.5, 18)	Apply oil
Tensioner lifter bolt	1	6	4 (0.4, 3)	
Cylinder head cover bolt	4	6	12 (1.2, 8.6)	
Cam chain tensioner bolt	2	6	12 (1.2, 8.6)	

1. GENERAL INFORMATION

TORQUE VALUES

Item	Q'ty	Thread dia. (mm)	Torque N•m (kgf•m, lbf•ft)	Remarks
DRIVE/DRIVEN PULLEY:				
Drive face nut	1	14	93 (9.3, 67)	Apply oil
Clutch outer nut	1	12	54 (5.4, 39)	
Clutch drive plate nut	1	28	54 (5.4, 39)	
Left crankcase cover bolt	6	6	12 (1.2, 8.6)	
ALTERNATOR				
A.C.G. stator	5	5	9 (0.9, 6.5)	
Flywheel nut	1	14	55 (5.5, 40)	
FINAL REDUCTION:				
Transmission case cover bolt	9	8	20 (2, 14.4)	
CRANKCASE:				
Cam chain guide bolt	1	6	10 (1, 7)	
SWITCH:				
Oil pressure switch	1	PT 1/8	22 (2.2, 16)	Apply seal

1. GENERAL INFORMATION

TORQUE VALUES

FRAME

No.	ITEM	THREAD SIZE AND TYPE	TORQUE		PR Kgf-m	REMARK	THREAD DWG NO.	Imp t
			Kgf-m	N-m				
1	STEERING							
	HANDLE POST	M10x1.25	6.0~7.0	60~70	6.5	U NUT	90106-GEN5-9000	A
	BRIDGE BOLT	M8x1.25	2.4~3.0	24~30	2.7	—	95801-08040-08	A
	STEM LOCK	BC1	6.0~6.5	60~65	6.3	—	50306-1F96-0010	A
	RACE NUT(HEAD)	BC1	1.8~2.2	18~22	2.0	—	53220-LBA2-E000	B
2	WHEEL							
	FR.AXLE	M14x1.5	1.5~2.5	15~25	2.0	—	44301-LLJ3-E000	A
	RR.AXLE NUT	M16x1.5	11~13	110~130	12	U NUT	90305-KFW6-9120-MI	A
3	SUSPENSION							
	FR FORK BOLT	M8x1.25	2.0~2.6	20~26	2.3	—	96600-08025-06	A
	RR. CUSH. UP	M10x1.25	3.5~4.5	35~45	4.0	U NUT	90304-GHE8-0040	A
	RR. CUSH. LWR	M10x1.25	3.5~4.5	35~45	4.0	—	95801-10035-06	A
4	BRAKE							
	FR CALIPER R	M10x1.25	3.0~4.0	30~40	3.5	—	90122-LEA7-E000	A
	RR CALIPER	M10x1.25	3.0~4.0	30~40	3.5	—	90122-LEA7-E000	A
	BRK OIL BOLT	M10x1.25	3.0~4.0	30~40	3.5	—	90145-MS9-6120-MI	A
	M/C HOLDER	M6x1.0	1.0~1.4	10~14	1.2	—	96001-06028-06	C
	M/C CAP SCREW	M4x0.7	0.12~0.2	1.2~2.0	0.16	—	96000-04012-1A	B
	C/P BLEEDER	M8x1.25	0.4~0.7	4.0~7.0	0.55	—	43352-5H68-0040	B
	DISK BOLT	M8x1.25	3.2~3.8	32~38	3.5	—	90105-KCR3-0010	A
	C/P PIN BOLT	M12x1.25	3.4~4.6	34~46	4.0	—	45131-LDHI-E000	B
5	ENG HANGER							
	FRAME SIDE	M14x1.5	6.0~7.0	60~70	6.5	U NUT	90305-LBD4-9000	A
	ENG SIDE	M10x1.25	4.5~5.5	45~55	5.0	U NUT	90304-GLW0-9020-MI	A
6	MUFFLER							
	EXH. PIPE	M8x1.25	1.8~2.2	18~22	2.0	—	90033-GFY6-9000	B
	MUFF. BRKT/RR FORK	M8x1.25	3.0~3.6	30~36	3.3	—	95801-08042-06	A
	MUFF. BRKT/RR FORK	M10x1.25	3.2~3.8	32~38	3.5	—	95801-10070-06	A
7	RR FORK/ENG CASE	M8x1.25	2.4~3.0	24~30	2.7	—	90131-KFAF-9000	A
8								
	IGN COIL	M6x1.0	0.25~0.35	2.5~3.5	0.3	—	94050-06080	B
	O2 SENSOR	M12x1.25	2.0~3.0	20~30	2.5	—	—	B
	START RELAY	M6x1.0	0.25~0.35	2.5~3.5	0.3	—	94050-06080	C
	RR CARRIER	M8x1.25	2.0~2.8	20~28	2.4	—	90106-KKC4-9000	C

1. GENERAL INFORMATION

SPECIAL TOOLS

Tool Name	Tool No.	Remarks	Ref. Page
Flywheel puller	E003	A.C. generator flywheel removal	4.10
One way clutch puller	E006	One way clutch removal	9
Tappet adjuster	E012	Tapper adjustment	3.7
Oil seal & bearing installer	E014	Oil seal & bearing install	9.10.11
Flywheel holder	E021	A.C. generator flywheel holding	4.10
Clutch spring compressor	E027	Clutch disassembly	9
Thread protector	E029	Protect the crankshaft's thread	10
Bearing puller 10,12,15,18mm	E037	Bearing removal	10
Valve cotter installer	E051	Valve cotter installation	7
Lock nut socket wrench	F002	Steering stem removal or install	12

1. GENERAL INFORMATION

LUBRICATION POINTS

FRAME

The following is the lubrication points for the frame.

Use grease for parts not listed.

Apply engine oil or grease to cables and movable parts not specified. It will avoid abnormal noise and damage the durability of the motorcycle.

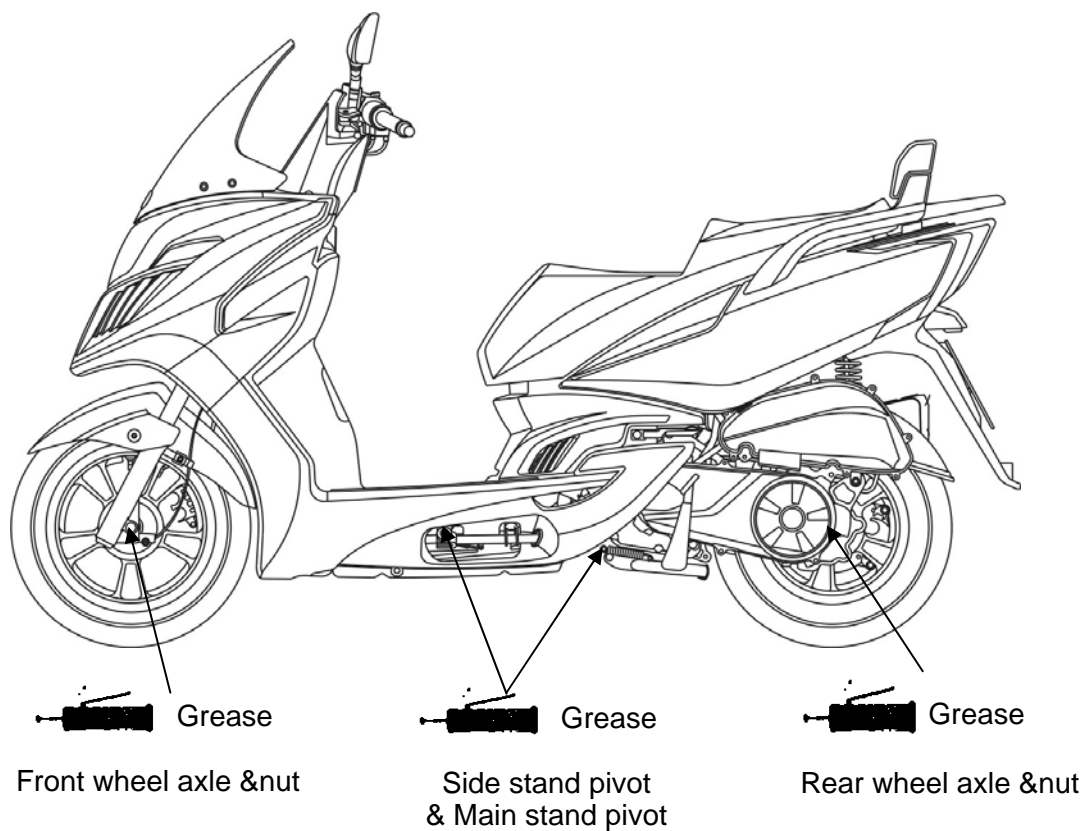

1. GENERAL INFORMATION

CABLE & HARNESS ROUTING

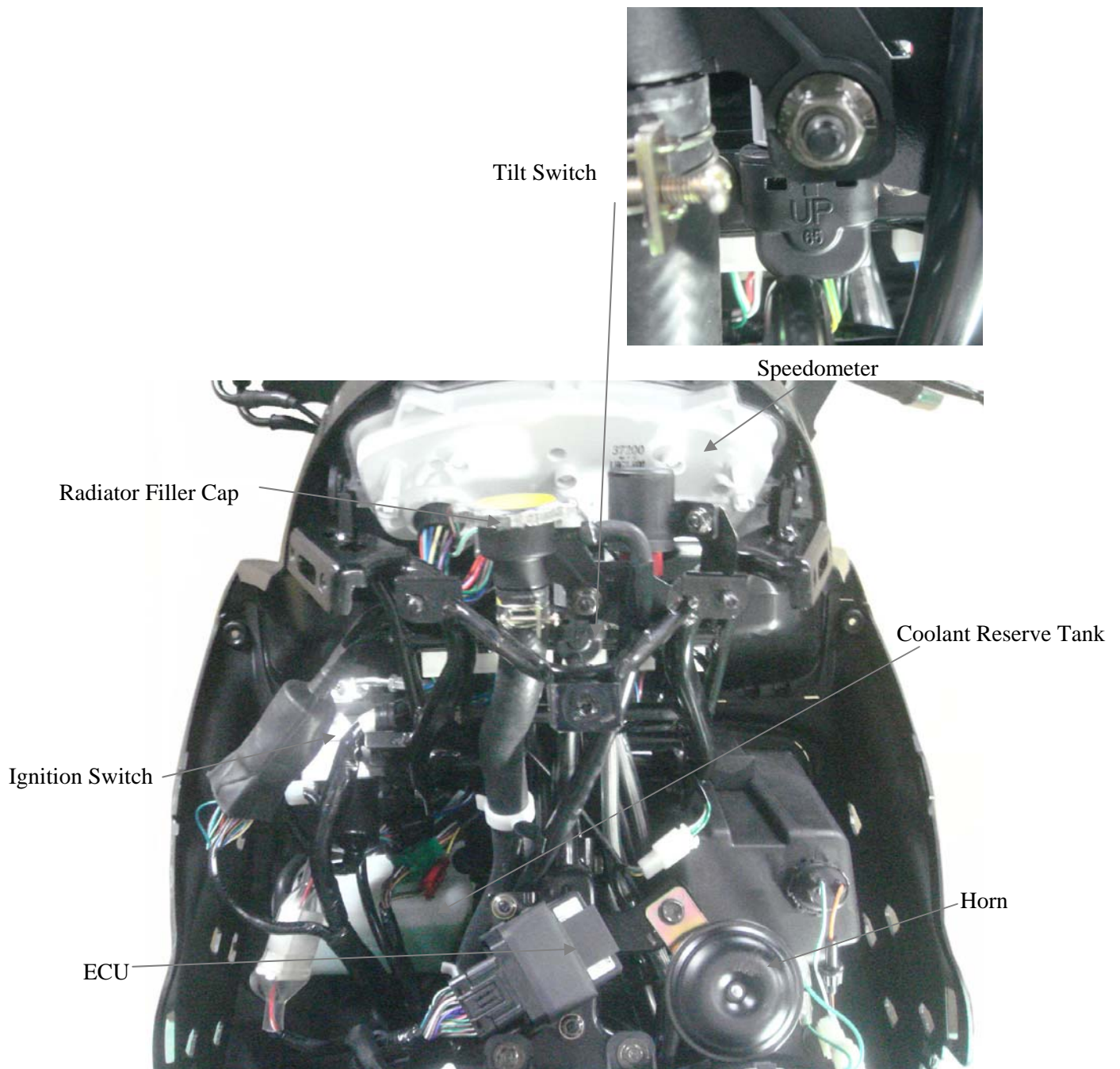

1. GENERAL INFORMATION

CABLE & HARNESS ROUTING

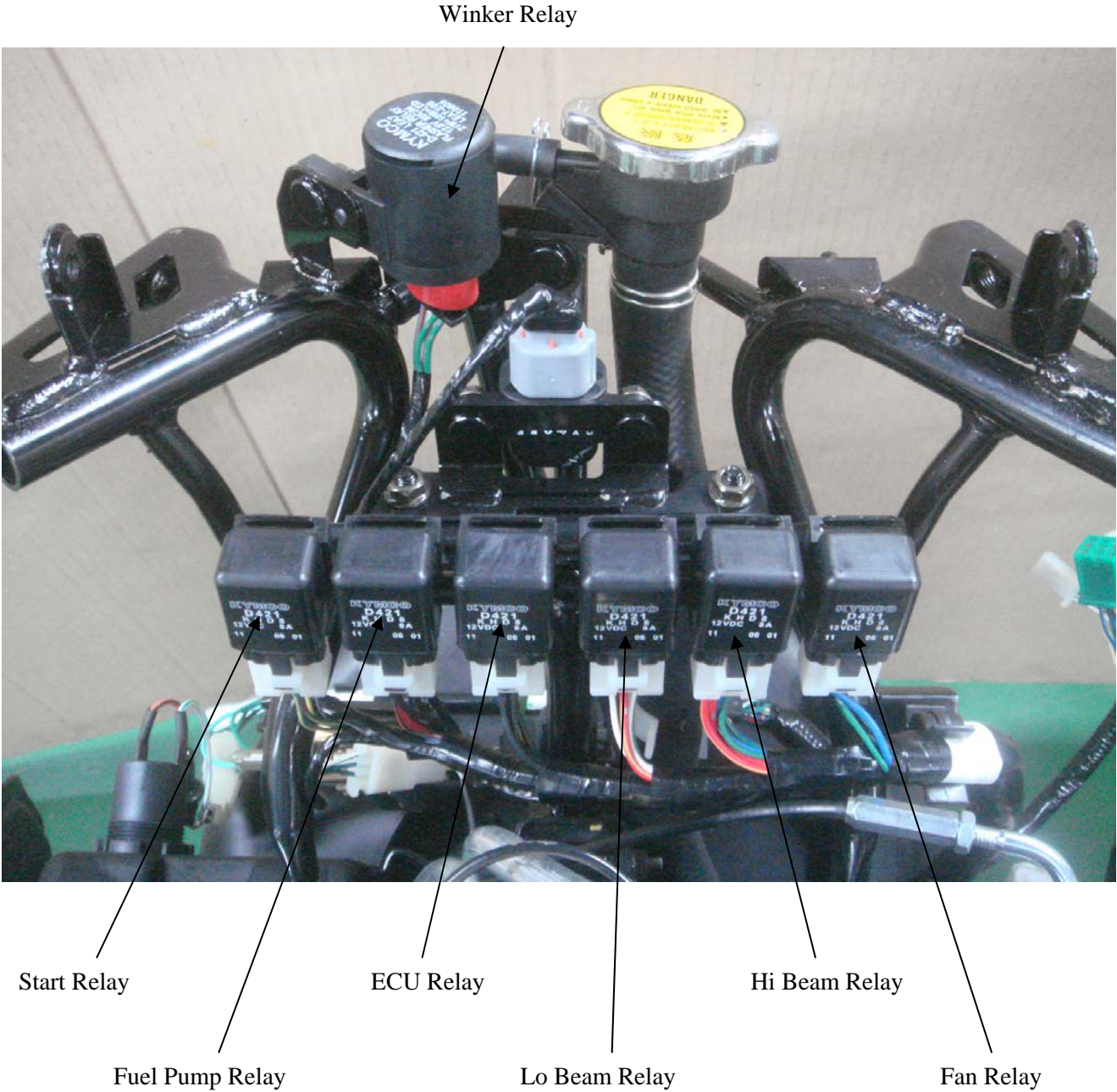

1. GENERAL INFORMATION

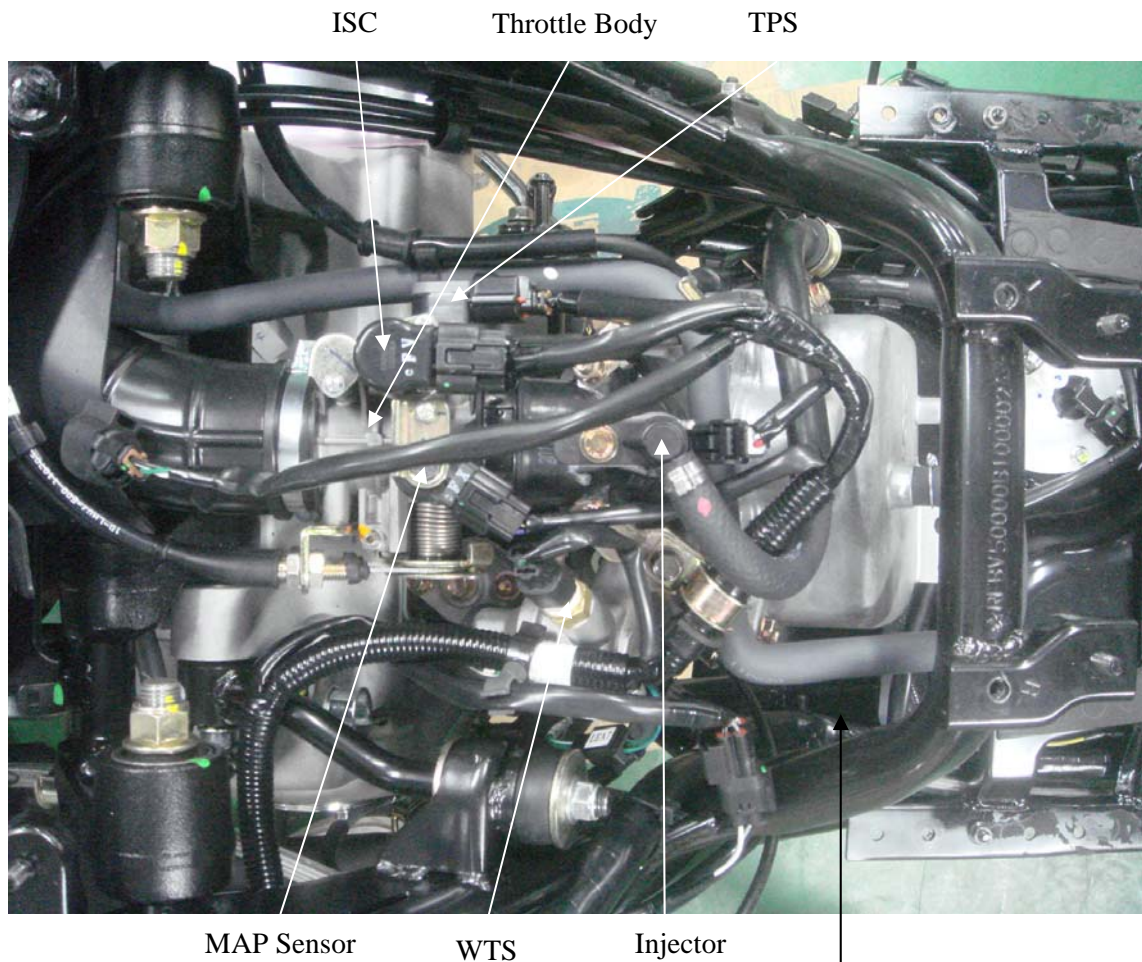

1. GENERAL INFORMATION

Ignition Coil Regulator/Rectifier Hazard Control Unit

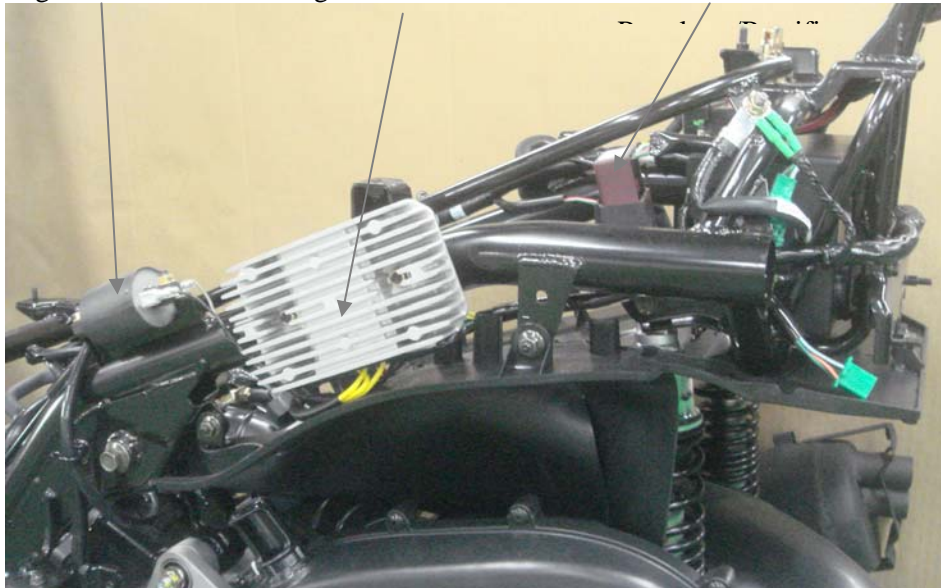

Starter Relay



Crank Position Sensor



1. GENERAL INFORMATION

TROUBLESHOOTING

ENGINE WILL NOT START OR IS HARD TO START

Possible cause

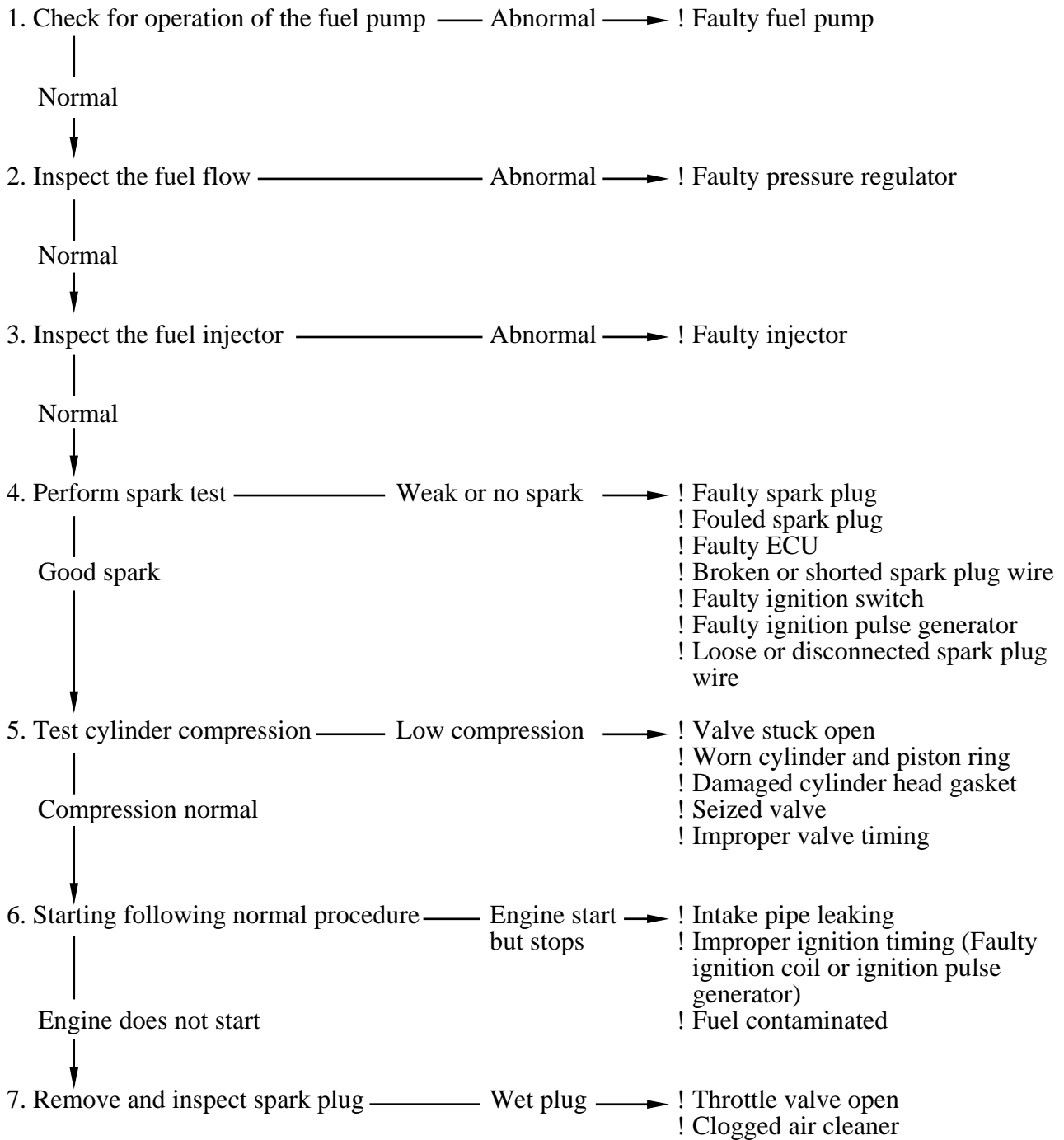

1. GENERAL INFORMATION

ENGINE LACKS POWER

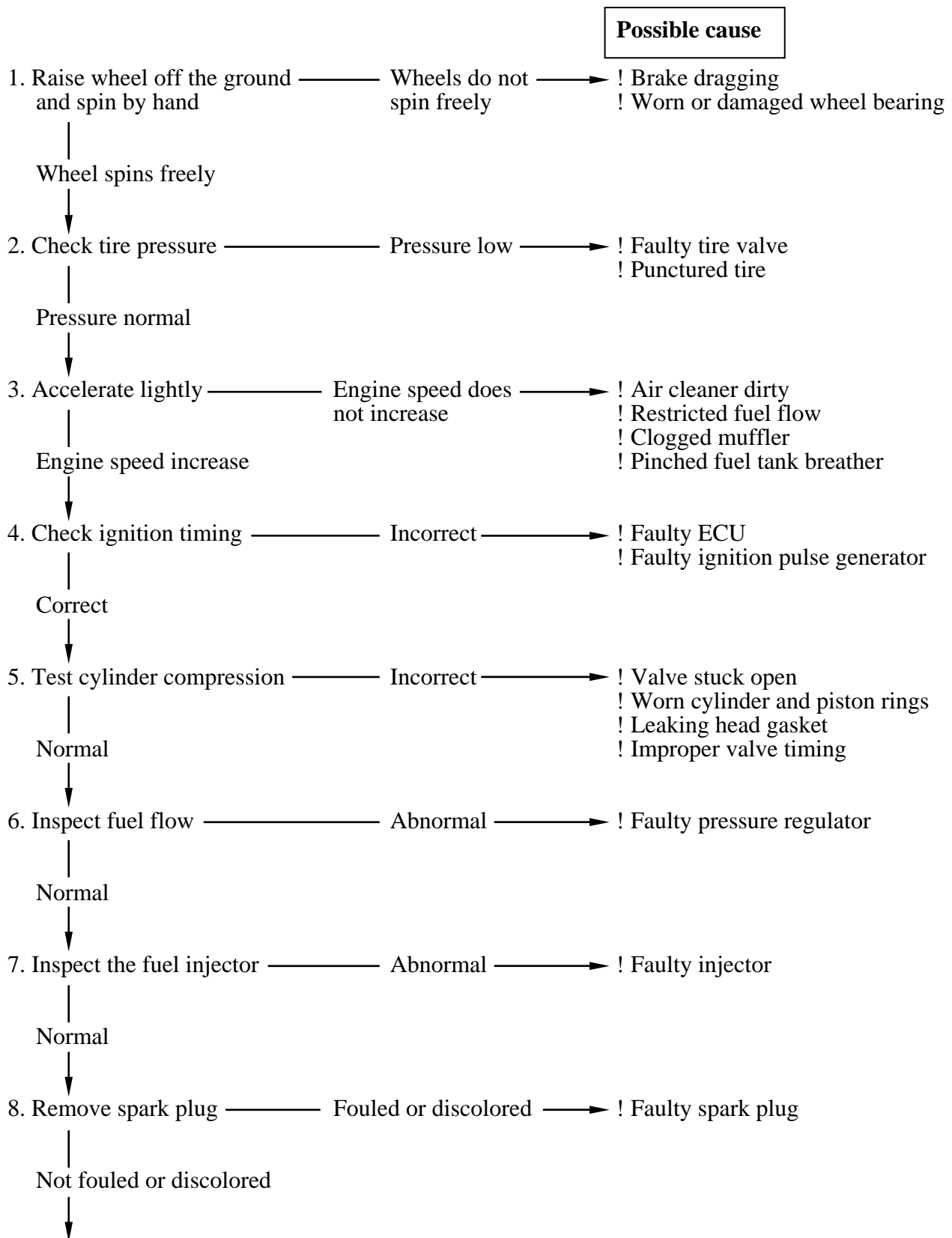

1. GENERAL INFORMATION

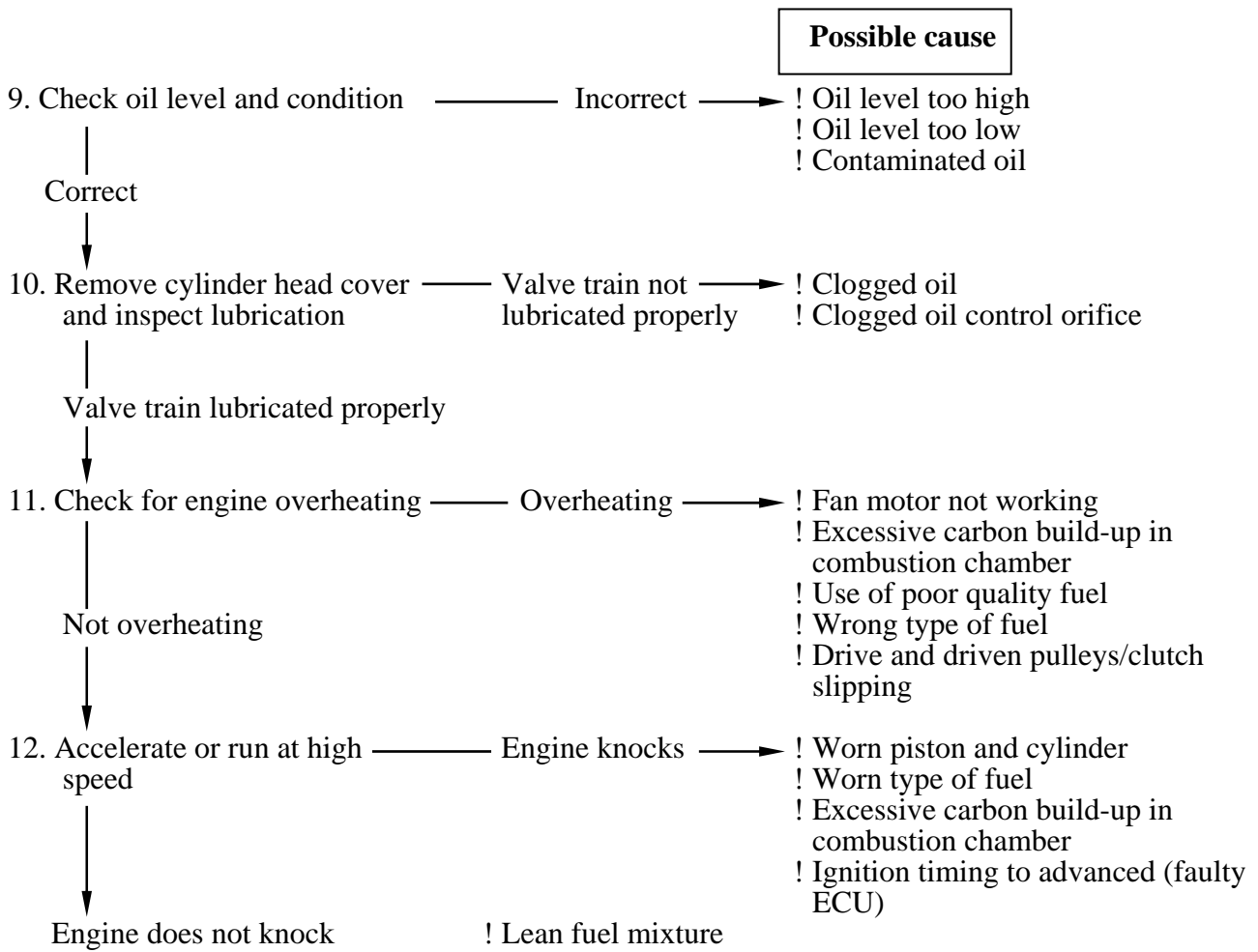

1. GENERAL INFORMATION

POOR PERFORMANCE AT LOW AND IDLE SPEED

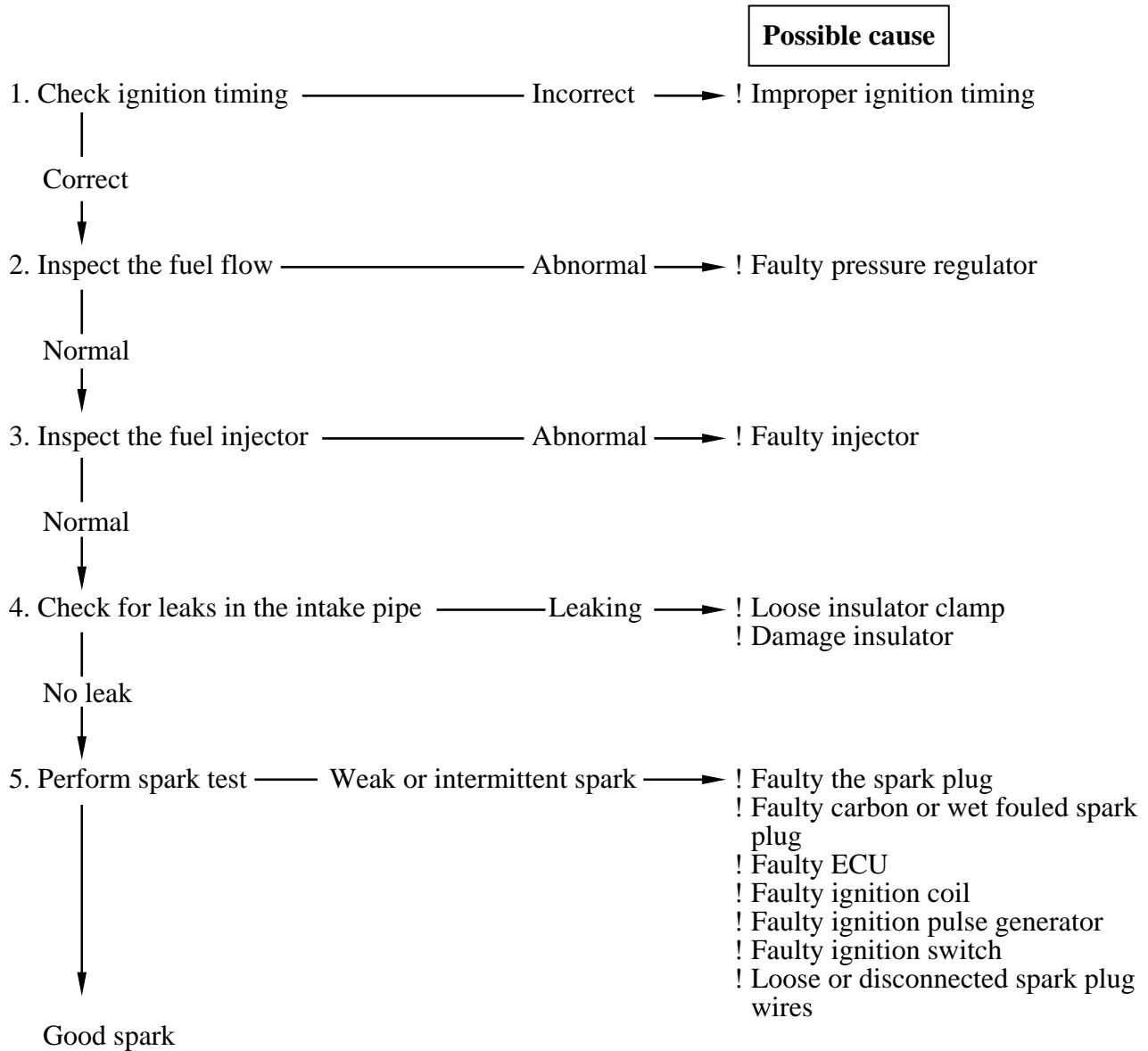

1. GENERAL INFORMATION

POOR PERFORMANCE AT HIGH SPEED

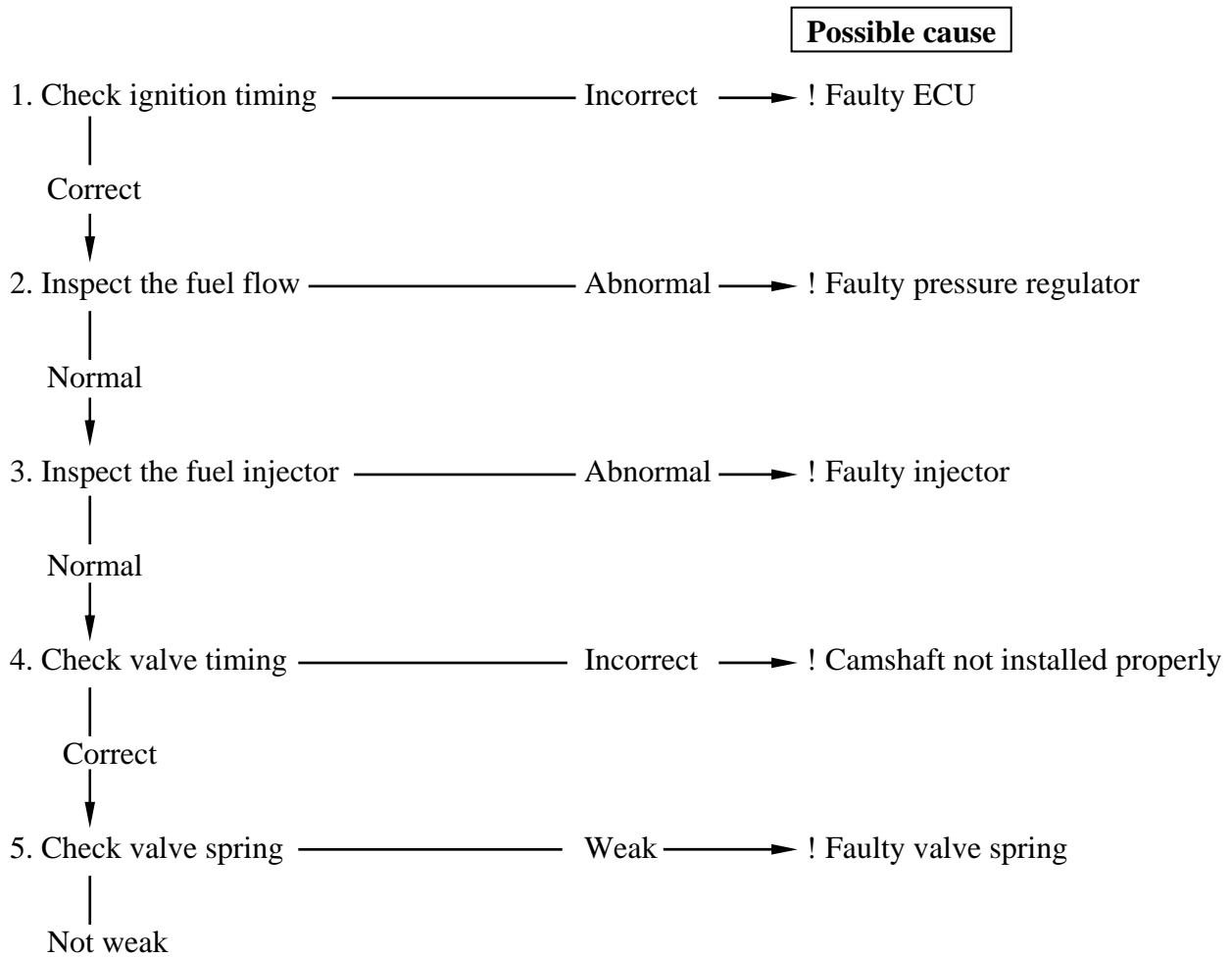

POOR HANDLING

			Possible cause
1. If steering is heavy		→	! Steering stem adjusting nut too tight ! Damaged steering head bearings
2. If either wheel is wobbling		→	! Excessive wheel bearing play ! Bent rim ! Improper installed wheel hub ! Swing arm pivot bearing excessively worn ! Bent frame
3. If the motorcycle pulled to one side		→	! Faulty the shock absorber ! Front and rear wheel not aligned ! Bent fork ! Bent swing arm ! Bent axle

2. EXHAUST MUFFLER/FRAME COVERS

2

EXHAUST MUFFLER/FRAME COVERS

SERVICE INFORMATION-----	2- 1
TROUBLESHOOTING-----	2- 1
FASTENER REMOVAL AND REINSTALLATION-----	2- 2
FRAME COVERS REMOVAL/INSTALLATION-----	2- 3
EXHAUST MUFFLER -----	2-14

2. EXHAUST MUFFLER/FRAME COVERS

SERVICE INFORMATION

GENERAL INSTRUCTIONS

- When removing frame covers, use care not to pull them by force because the cover joint claws may be damaged.
- Make sure to route cables and harnesses according to the Cable & Harness Routing.

TORQUE VALUES

Exhaust muffler pipe nuts	1.8~2.2 kgf-m
Exhaust muffler brake /RR Fork	3.2~3.8 kgf-m
RR fork/Engine case	2.4~3.0 kgf-m

TROUBLESHOOTING

Noisy exhaust muffler

- Damaged exhaust muffler
- Exhaust muffler joint air leaks

Lack of power

- Caved exhaust muffler
- Clogged exhaust muffler
- Exhaust muffler air leaks

2. EXHAUST MUFFLER/FRAME COVERS

FASTENER REMOVAL AND REINSTALLATION

REMOVAL

Depress the head of fastener center piece ←.
Pull out the fastener.

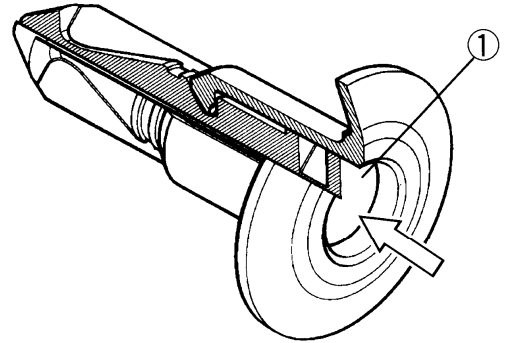

INSTALLATION

Let the center piece stick out toward the head
so that the pawls ↑ close.
Insert the fastener into the installation hole.

* To prevent the pawl ↑ from damage,
insert the fastener all the way into the
installation hole

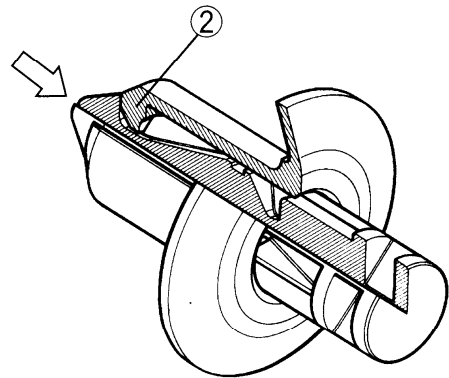

Push in the head of center piece until it
becomes flush with the fastener outside face.

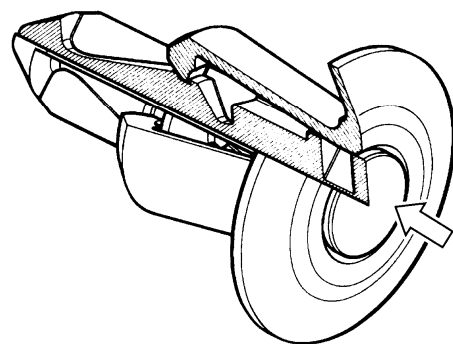

2. EXHAUST MUFFLER/FRAME COVERS

FRAME COVERS REMOVAL/ INSTALLATION

LUGGAGE BOX

Unlock the seat with the ignition key.
Open the seat.

Remove 2 bolts, 2 screws and 4 nuts on the
luggage box.



SEAT

Unlock the seat with the ignition key.
Open the seat.

Remove the two nuts and the seat.

Nuts

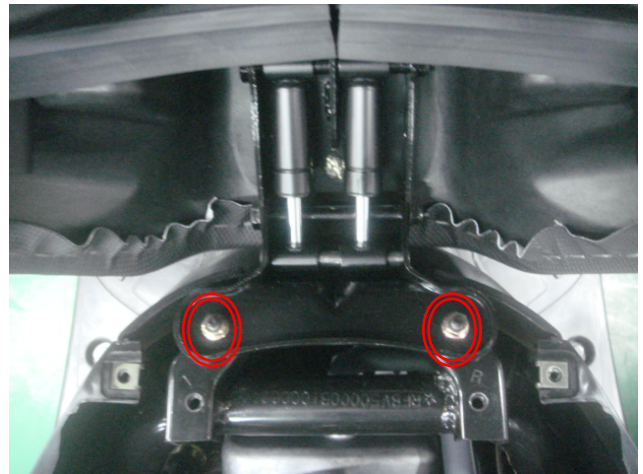

Luggage Box Light Connector

Disconnect the luggage box light connector,
then remove the luggage box.

Installation is in the reverse order of removal.

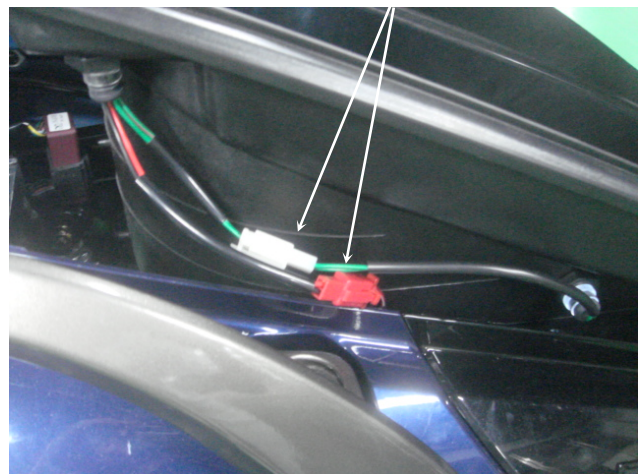

2. EXHAUST MUFFLER/FRAME COVERS

CENTER COVER

Remove the luggage box and seat.

Remove the center cover.

* During removal, do not pull the joint claws forcedly to avoid damage.

Installation is in the reverse order of removal.

Center Cover



REAR CARRIER

Remove 4 bolts and rear carrier

Bolts

Rear carrier

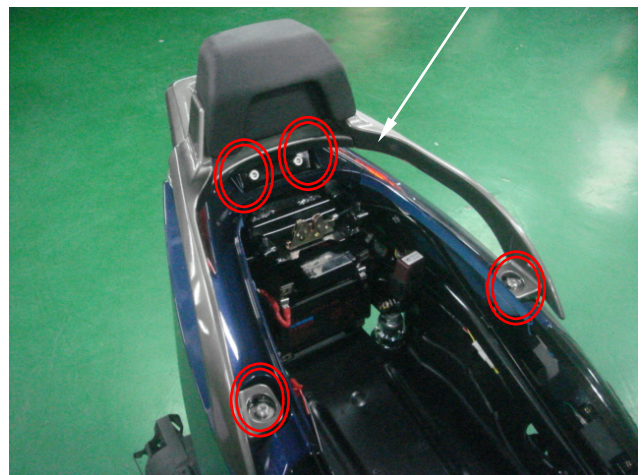

REAR CENTER COVER

Remove two screws to remove the rear center cover.

Screws

Rear center cover

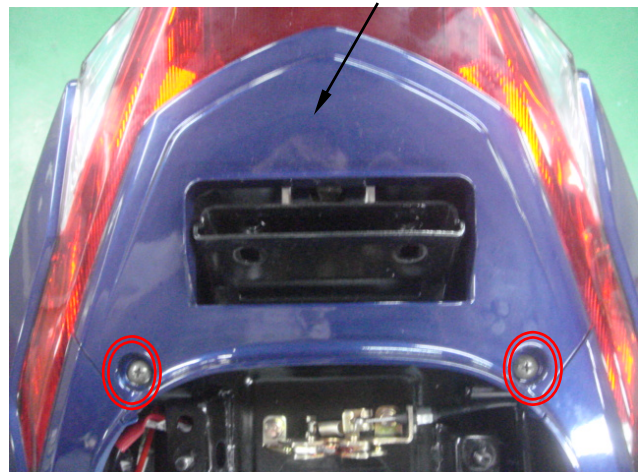

2. EXHAUST MUFFLER/FRAME COVERS

BODY COVER SET

Remove the screws, bolts, nuts and connector to remove the body cover set.

Screws

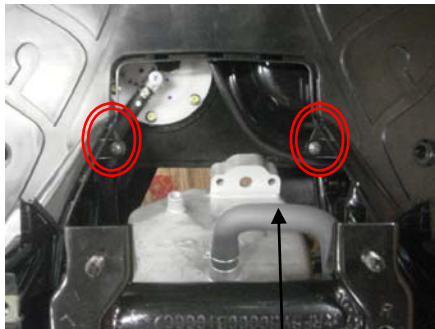

Bolt



Body cover set

Screw



Nuts



Screw



Connector



Dismantle Direction

2. EXHAUST MUFFLER/FRAME COVERS

FRONT SIDE MOLD

Remove the fasteners to remove the right and left of front side molds.

Fastener



Front side mold



Remove the mat leg shield.

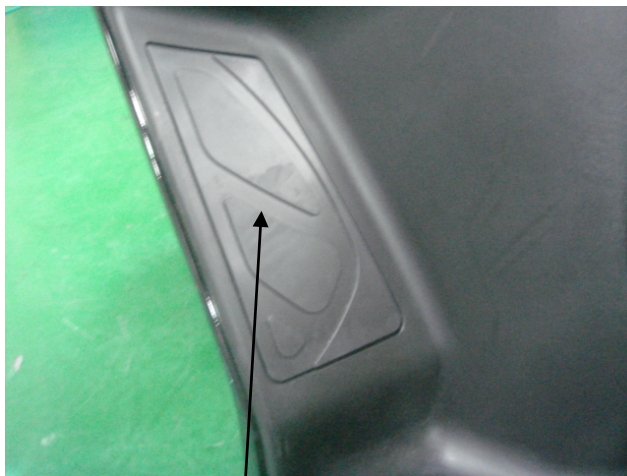

Mat leg shield



Fasteners

UNDER COWL

Remove the fasteners and under cowl.

Under cowl

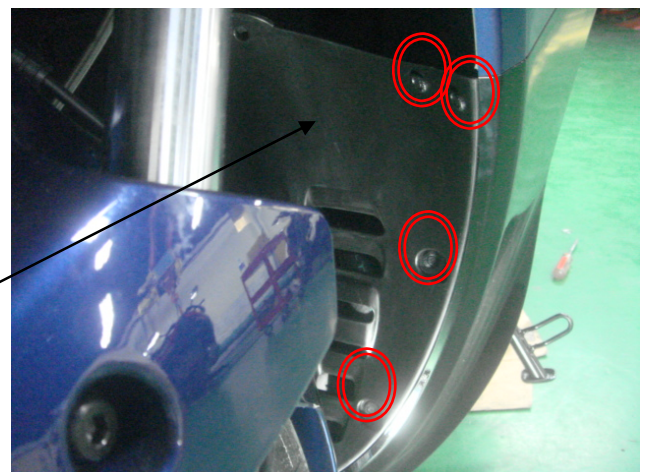

2. EXHAUST MUFFLER/FRAME COVERS

SKIRT SET

Remove the screws and fasteners to remove the right and left skirt sets.

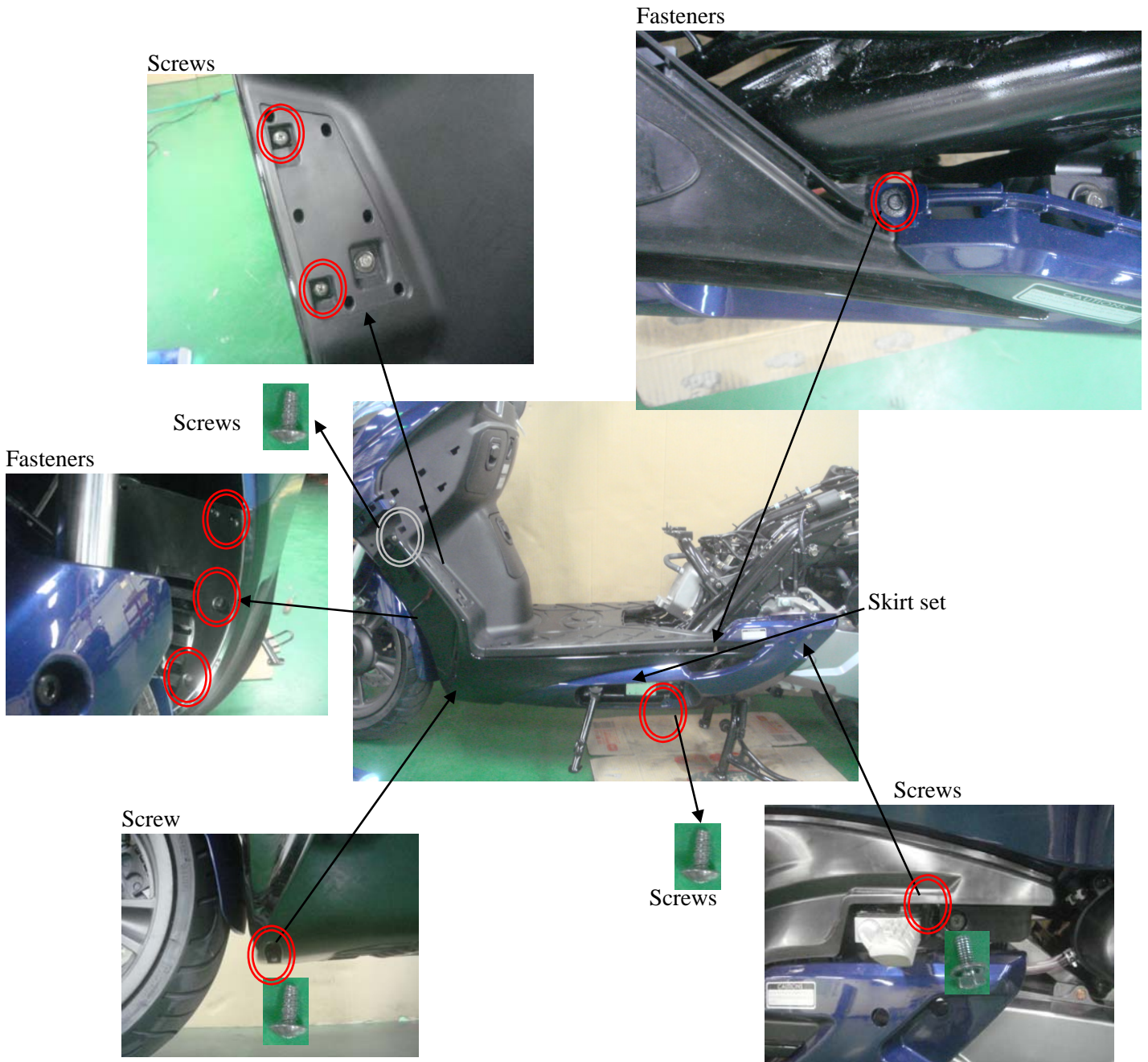

2. EXHAUST MUFFLER/FRAME COVERS

PANEL FLOOR

Remove the bolts and panel floor.

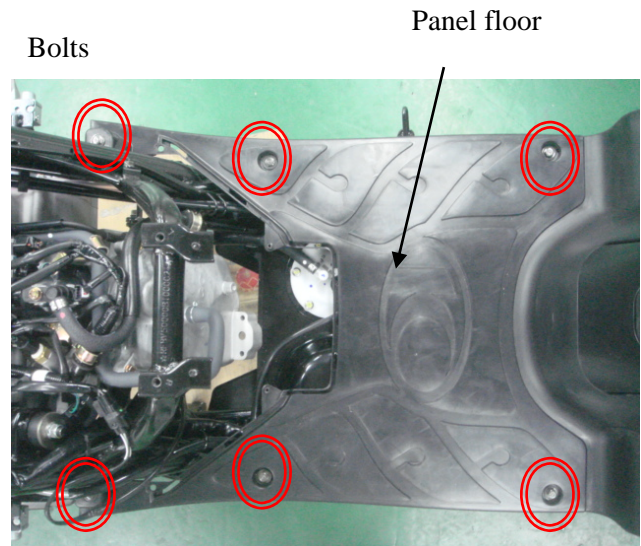

2. EXHAUST MUFFLER/FRAME COVERS

HANDLE UP COVER

Remove screws and bolts to remove the handle up cover.

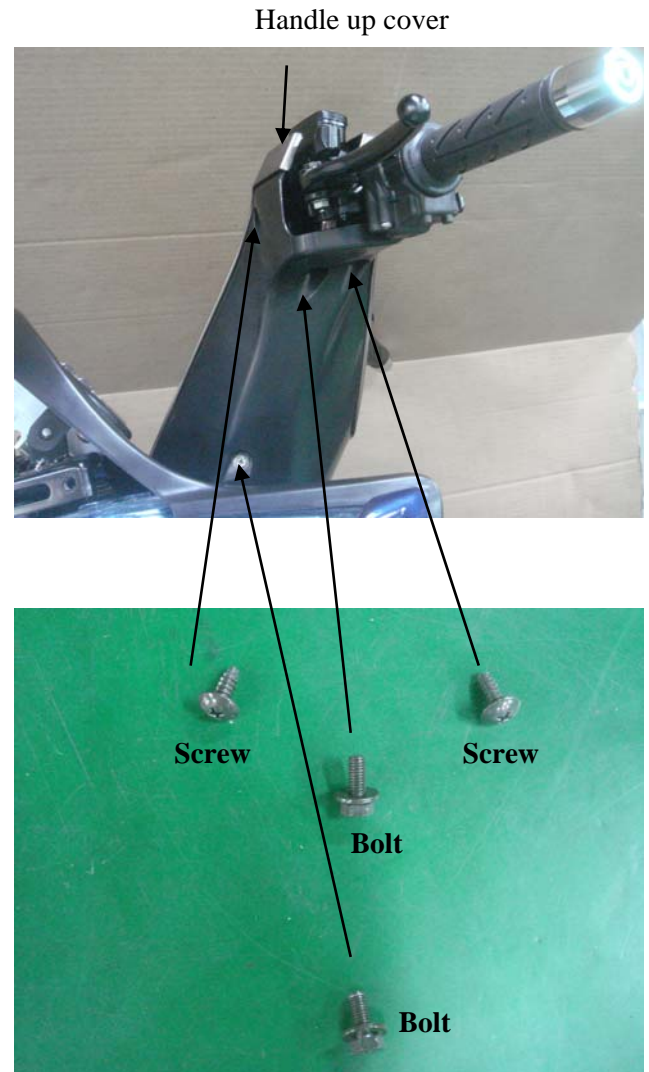

HANDLE LOW COVER

Remove throttle cables to remove the handle low cover.



2. EXHAUST MUFFLER/FRAME COVERS

WINDSHIELD

Remove five bolts and windshield.

Handle up cover



FRONT METER COVER SET

Remove the front meter cover.



Front meter cover set.

2. EXHAUST MUFFLER/FRAME COVERS

FRONT COVER SET

Remove the screws, nuts, fasteners and connector to remove the front cover set.

Screws



Nuts

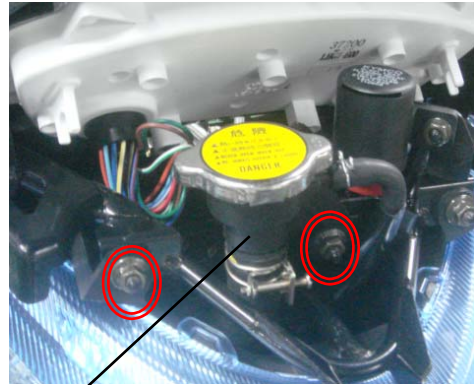

Front cover set

Connector



Fastener

Dismantle
Direction

2. EXHAUST MUFFLER/FRAME COVERS

REAR METER COVER SET

Remove the fasteners, main switch lid, bolts and connectors to remove the rear meter cover set.

Fasteners

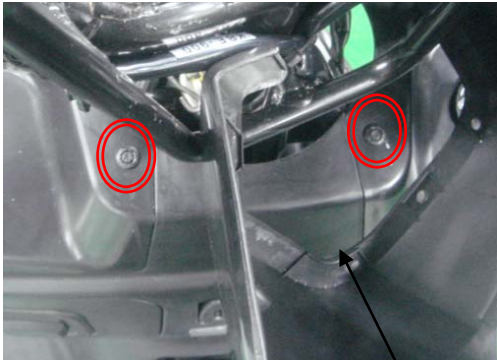

Rear meter cover set

Main switch lid

Bolts

Connectors



2. EXHAUST MUFFLER/FRAME COVERS

LEG SHIELD SET

Remove the screws, bolt, center clip, connector and fuel filler cap to remove the leg shield.

Connector



Bolt



Screws

Center clip

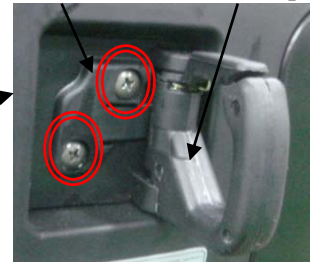

Bolt



Leg shield set

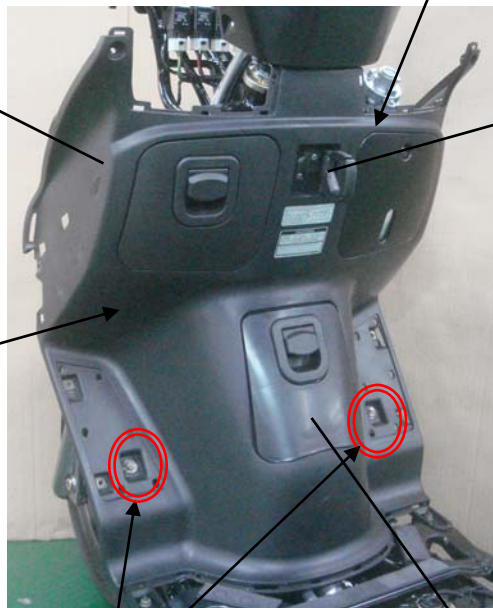

Bolts

Fuel filler cap



2. EXHAUST MUFFLER/FRAME COVERS

FRONT INNER FENDER

Remove the bolts, fasteners to remove the front inner fender.

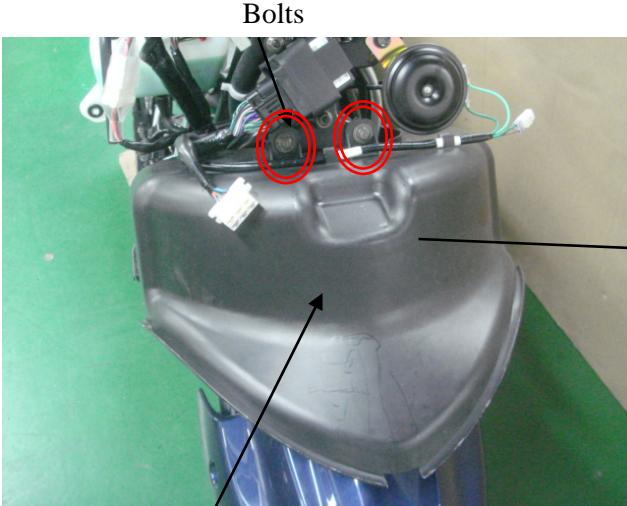

Leg shield set

FRONT FENDER

Remove the bolts to remove the front fender.

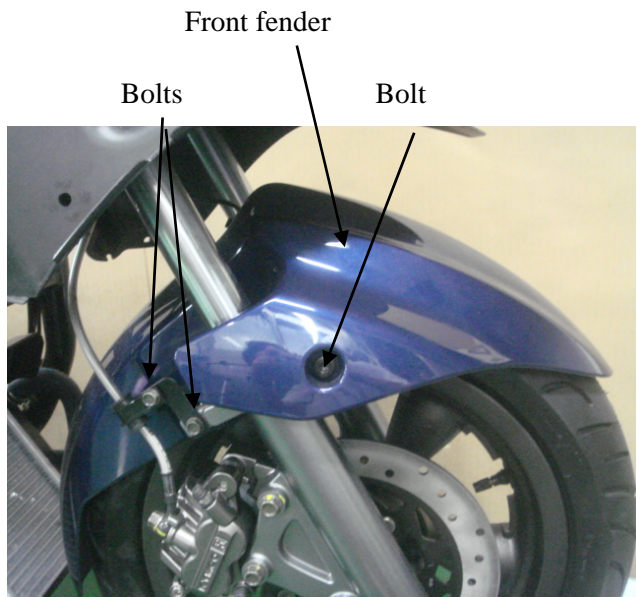
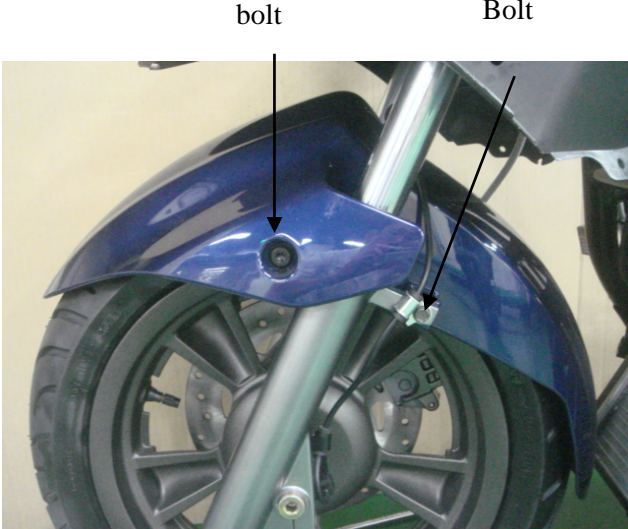

2. EXHAUST MUFFLER/FRAME COVERS

EXHAUST MUFFLER

REMOVAL

Disconnect the connector with O2 heater/O2 sensor.

Remove the bolts and nuts to remove the muffler.

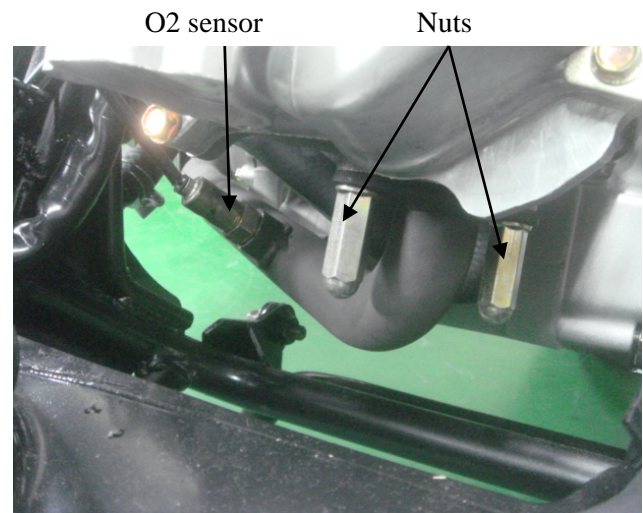
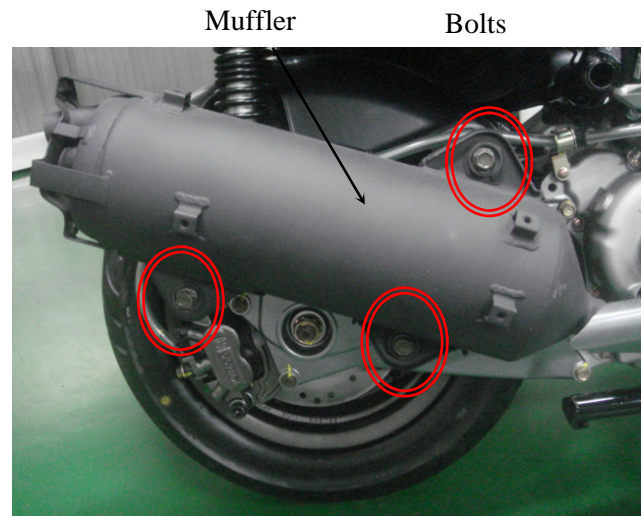

Installation is in the reverse order of removal.

3. INSPECTION/ADJUSTMENT

3

INSPECTION / ADJUSTMENT

SERVICE INFORMATION-----	3- 1
MAINTENANCE SCHEDULE-----	3- 2
THROTTLE OPERATION -----	3- 3
ENGINE OIL -----	3- 4
RESERVE TANK -----	3- 5
AIR CLEANER -----	3- 6
SPARK PLUG -----	3- 6
VALVE CLEARANCE-----	3- 7
CYLINDER COMPRESSION -----	3- 7
FINAL REDUCTION GEAR OIL -----	3- 8
DRIVE BELT -----	3- 8
BRAKE SYSTEM -----	3- 9
CLUTCH SHOE WEAR -----	3-10
SUSPENSION-----	3-10
NUTS/BOLTS/FASTENERS-----	3-11
WHEELS/TIRES -----	3-11
STEERING HANDLEBAR -----	3-11
SIDE STAND -----	3-12

3. INSPECTION/ADJUSTMENT

SERVICE INFORMATION

GENERAL

! WARNING

- Before running the engine, make sure that the working area is well ventilated. Never run the engine in a closed area. The exhaust contains poisonous carbon monoxide gas, which may cause death to people.
- Gasoline is extremely flammable and is explosive under some conditions. The working area must be well ventilated and do not smoke or allow flames or sparks near the working area or fuel storage area.

SPECIFICATIONS

ENGINE

- Throttle grip free play : 2~6 mm
- Spark plug : DPR6EA
- Spark plug gap : 0.6 mm ~ 0.7 mm
- Valve clearance : IN: 0.10 mm EX: 0.10 mm
- Idle speed : 1600±100 rpm

Engine oil capacity:

- Cylinder compression: 16±2 kg/cm²
- At disassembly : 1.1 Liter
- At change : 0.9 Liter
- Ignition timing : ECU
- Coolant type : Water Cooling

Gear oil capacity :

- At disassembly : 0.23 Liter
- At change : 0.18 Liter

TIRE

	1 Rider	2 Riders
Front	1.75 kg/cm ²	1.75 kg/cm ²
Rear	2.0 kg/cm ²	2.25 kg/cm ²

TIRE SPECIFICATION

- Front : 120/70-13
- Rear : 140/70-12

TORQUE VALUES

- Front axle nut : 2 kg-m
- Rear axle nut : 12 kg-m

SPECIAL TOOL

- Tappet Adjuster E012

3. INSPECTION/ADJUSTMENT

MAINTENANCE SCHEDULE

MAINTENANCE SCHEDULE

Perform the pre-ride inspection (see page 19) at each scheduled maintenance period.

This interval should be judged by odometer reading or months, whichever comes first.

I: INSPECT AND CLEAN, ADJUST, LUBRICATE OR REPLACE IF NECESSARY

C: CLEAN R: REPLACE A: ADJUST L: LUBRICATE

The following maintenance schedule specifies all maintenance required to keep your scooter in peak operating condition. Maintenance work should be performed in accordance with standards and specifications of KYMCO by properly trained and equipped technicians. Your KYMCO dealer meets all of these requirements.

* Should be serviced by your KYMCO dealer, unless the owner has the proper tools and service data and is mechanically qualified.

** In the interest of safety, we recommend these items be serviced only by your KYMCO dealer. KYMCO recommends that your KYMCO dealer should road test your scooter after each periodic maintenance is carried out.

NOTE:

- 1 At higher odometer readings, repeat at the frequency interval established here.
- 2 Service more frequently if the scooter is ridden in unusually wet or dusty areas.
- 3 Service more frequently when riding in rain or at full throttle.
- 4 Clean every 2000 km (1200 mi) after replacement and replace every 5000 km (3000 mi).
- 5 Replace every 1 year, or every 4000km (2400mi), whichever comes first. Replacement requires mechanical skill.
- 6 Replace every 10000 km (6000 mi), or once a year it at every 5000 km (3000 mi). Replacement requires mechanical skill.
- 7 Replace every 2 years. Replacement requires mechanical skill.

ITEM	FREQUENCY	WHICHEVER COMES FIRST	ODOMETER READING [NOTE (1)]								REFER TO PAGE
			X 1000 km	0.3	1	3	5	7	9	11	
			X 1000 mi	0.2	0.6	1.8	3	4.2	5.4	6.6	
	NOTE	MONTH									
* AIR CLEANER		NOTE 2			I	R	I	R	I	R	31
SPARK PLUGS		NOTE 4					R				32
* THROTTLE OPERATION						I		I			31
* VALVE CLEARANCE			A		A		A		A		-
* FUEL LINE						I		I			-
CRANKCASE BREATHER		NOTE 3		C	C	C	C	C	C	C	-
ENGINE OIL			R	R	R	R	R	R	R	R	27
* ENGINE OIL STRAINER SCREEN			C		C		C		C		-
* ENGINE IDLE SPEED					I		I		I		-
RADIATOR COOLANT		NOTE 6				R					-
* COOLING SYSTEM						I		I			-
* SECONDARY AIR SUPPLY SYSTEM						I		I			-
* TRANSMISSION OIL		NOTE 5	R		R		R		R		30
* DRIVE BELT							I				-
** CLUTCH SHOE WEAR							I				-
BRAKE FLUID		NOTE 7			I	I	I	R	I		35
BRAKE PAD WEAR				I	I	I	I	I	I		36
BRAKE SYSTEM				I	I	I	I	I	I		-
* BRAKE LIGHT SWITCH						I		I			-
SIDE STAND						I		I			-
* SUSPENSION						I		I			-
* HEADLIGHT AIM						I		I			-
* NUTS, BOLTS, FASTENERS			I			I		I			-
** WHEELS/TIRES				I	I	I	I	I	I		38
** STEERING BEARINGS			I			I		I			-

3. INSPECTION/ADJUSTMENT

THROTTLE OPERATION

Check the throttle grip for smooth movement.
Measure the throttle grip free play.

Free Play: 2~6 mm

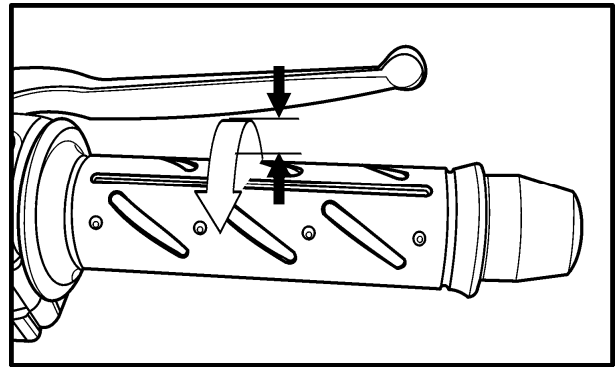

Major adjustment of the throttle grip free play is made with the adjusting nut at the throttle body side. Adjust by loosening the lock nut and turning the adjusting nut.



Adjusting Nut

Lock Nut

Minor adjustment is made with the adjusting nut at the throttle grip side. Slide the rubber cover(1) out and adjust by loosening the lock nut(3) and turning the adjusting nut(2).

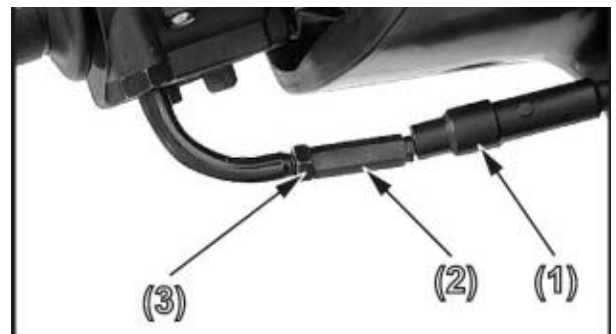

3. INSPECTION/ADJUSTMENT

ENGINE OIL

OIL LEVEL INSPECTION

Stop the engine and support the scooter upright on the level ground.
 Wait for 2~3 minutes and check the oil level with the dipstick. Do not screw in the dipstick when checking the oil level.



Dipstick

OIL CHANGE

Remove the oil drain bolt to drain the engine oil.
 Install the aluminum washer and tighten the oil drain bolt.



Oil Drain Bolt

Torque: 2.5 kg-m

- * • Replace the aluminum washer with a new one if it is deformed or damaged.

Pour the recommended oil through the oil filler hole.

OIL CAPACITY

Engine oil capacity: 1.1 L
 Engine oil exchanging capacity: 0.9 L
 Engine Oil Viscosity : SAE 10W40

OIL FILTER SCREEN INSPECTION

Drain the engine oil.
 Remove the oil filter screen attaching the left-under crankcase.
 Clean the oil filter screen.
 Install the oil filter screen and filter screen cap.
 Fill the engine with recommended engine oil.

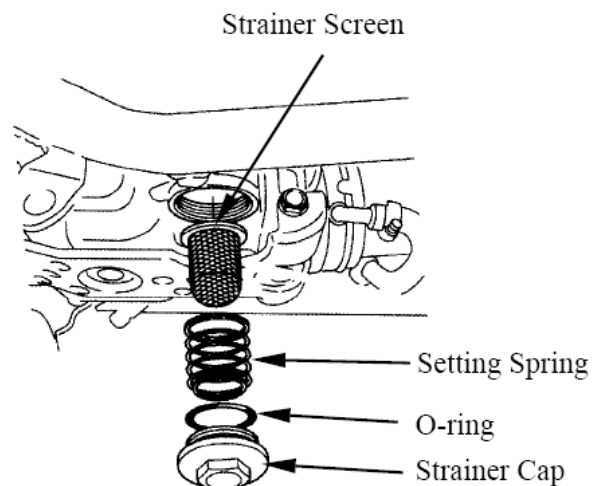

OIL FILTER REPLACEMENT

Remove the oil filler cap attaching the right-under crankcase cover.

3. INSPECTION/ADJUSTMENT

The spring will come out when the filter cap is removed.
 Let the engine oil drain out.
 Check that the O-ring is in good condition.

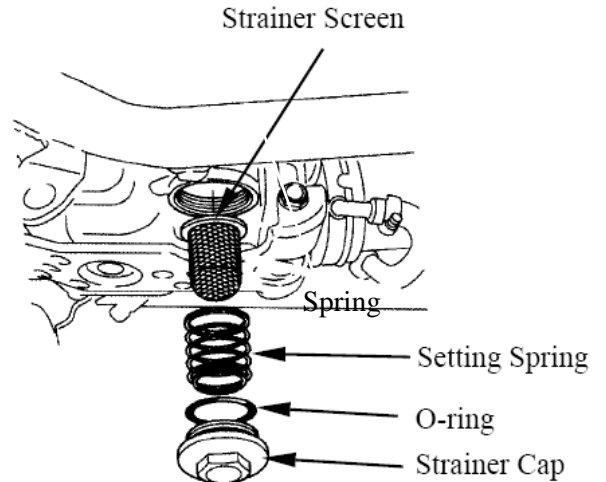

Install a new oil filter.

* Make sure the rubber seal on the oil filter facing the left crankcase.

Coolant level inspection

The reserve tank is behind the leg shield.
 Check the coolant level through the inspection window ① while the engine is at the normal operating temperature, with the scooter in an upright position.

If the coolant level is below the LOWER level mark ②, remove the cover reserve tank, remove the lid screw, and then the reserve tank cap ④ to add coolant mixture until it reaches the upper level mark.

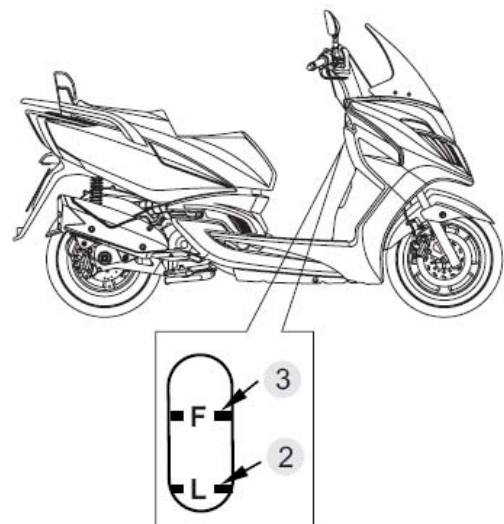
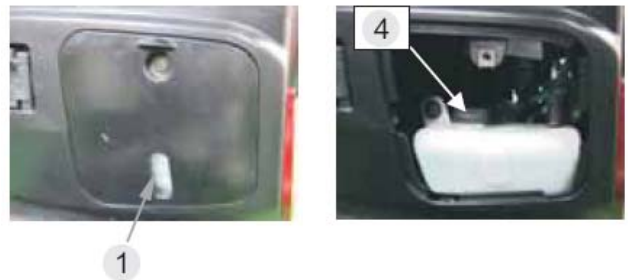

⚠ WARNING
 Add coolant to the reserve tank only. Do not attempt to add coolant by removing the radiator cap. Coolant in the radiator is under pressure and is very hot and can cause serious burns.

3. INSPECTION/ADJUSTMENT

AIR CLEANER

AIR FILTER REPLACEMENT

Remove screws attaching to remove air cleaner cover.
 Remove screws attaching to remove filter.
 Check the filter and replace it if it is excessively dirty or damaged.



Air Cleaner Filter

CHANGE INTERVAL

More frequent replacement is required when riding in unusually dusty or rainy areas.

- *
 • The air cleaner element has a viscous type paper element. Do not clean it with compressed air.
 • Be sure to install the air cleaner element and cover securely.

SPARK PLUG

Remove the spark plug cap and spark plug.
 Check the spark plug for wear and fouling deposits.
 Clean any fouling deposits with a spark plug cleaner or a wire brush.

Specified Spark Plug: NGK-CR7E

Measure the spark plug gap.

Spark Plug Gap: 0.6 – 0.7 mm

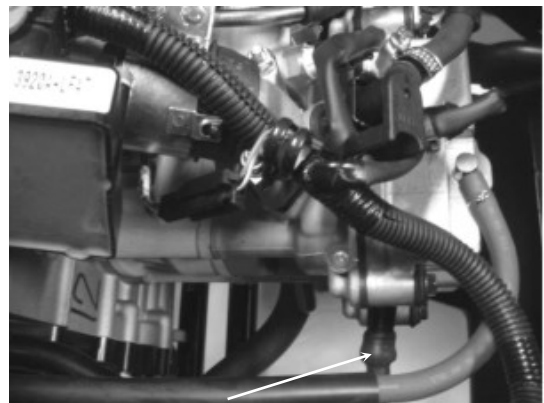

Spark Plug

- *
 • When installing, first screw in the spark plug by hand and then tighten it with a spark plug wrench.

Torque: 17.2 N-m

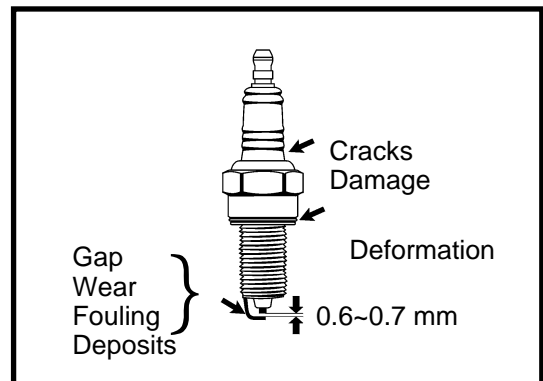

3. INSPECTION/ADJUSTMENT

VALVE CLEARANCE

- *
 - Inspect and adjust valve clearance while the engine is cold (below 35°C).

Remove the seat assy and luggage box.
Remove the four bolts and then cylinder head cover.

Turn the A.C. generator flywheel to the top dead center (TDC) on the compression stroke so that the "T" mark on the flywheel aligns with the index mark on the left crankcase cover.

Inspect and adjust valve clearance.

Valve Clearance: IN: 0.10 mm
EX: 0.10 mm

Loosen the lock nut and adjust by turning the adjusting nut

Special

Valve Adjuster E012
Feeler Gauge

- *
 - Check the valve clearance again after the lock nut is tightened.

Index Mark

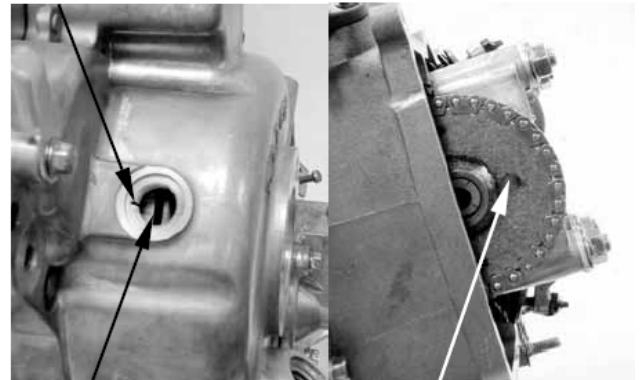

"T" Mark

Punch Mark

Valve Wrench

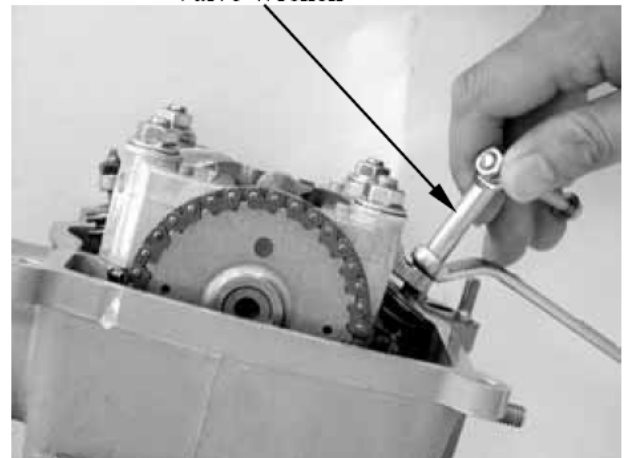

CYLINDER COMPRESSION

Warm up the engine before compression test.

Remove the center cover and luggage box.

Remove the spark plug.

Insert a compression gauge.

Open the throttle fully and push the starter button to test the compression.

Max. Compression: 16±2 kg/cm² - 570 rpm

If the compression is low, check for the following:

- Leaky valves
- Valve clearance too small
- Leaking cylinder head gasket
- Worn piston rings
- Worn piston/cylinder

If the compression is high, it indicates that carbon deposits have accumulated on the combustion chamber and the piston head.

3. INSPECTION/ADJUSTMENT

FINAL REDUCTION GEAR OIL

- * • Place the scooter on its main stand on level ground.

Remove the transmission fluid drain bolt.
Remove the transmission fluid filler bolt, then slowly rotate the rear wheel to drain the fluid.
Fill the transmission with the recommend fluid to the capacity listed below.

Transmission fluid type: SAE 90

Transmission fluid capacity: 0.23 L

Transmission fluid exchanging capacity: 0.18 L

Install the transmission filler bolt and tighten it to the specified torque.

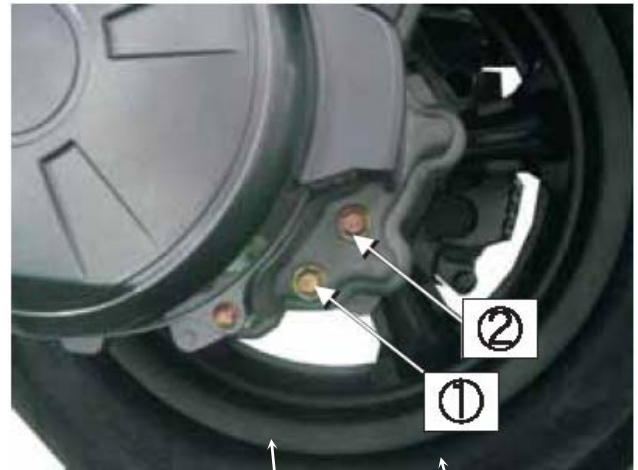

DRIVE BELT

Remove the left crankcase cover.
Inspect the drive belt for cracks or excessive wear.
Replace the drive belt with a new one if necessary and in accordance with the Maintenance Schedule.

3. INSPECTION/ADJUSTMENT

BRAKE DISK/BRAKE PAD

Check the brake disk surface for scratches, unevenness or abnormal wear.
Check if the brake disk runout is within the specified service limit.
Check if the brake pad wear exceeds the wear indicator line.

* Keep grease or oil off the brake disk to avoid brake failure.

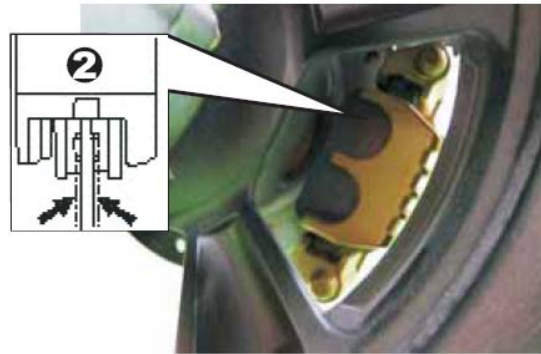
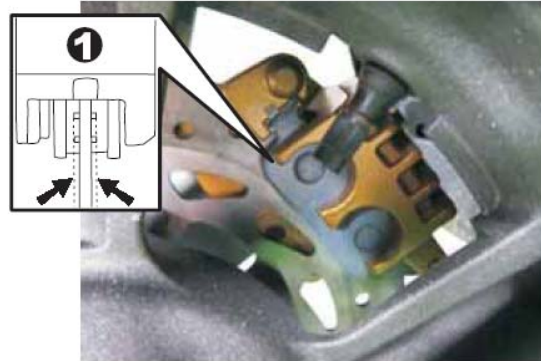

BRAKE FLUID

Turn the steering handlebar upright and check if both brake fluid levels is at the upper limit. If the brake fluid is insufficient, fill to the upper limit.

Specified Brake Fluid: DOT-4

* The brake fluid level will decrease if the brake pads are worn.



3. INSPECTION/ADJUSTMENT

CLUTCH SHOE WEAR

Start engine and check the clutch operation by increasing the engine speed gradually. If the motorcycle tends to creep or the engine stop, check the clutch shoes for wear and replace if necessary.

SUSPENSION

FRONT

Check the action of the front shock absorbers by compressing them several times.

Check the entire shock absorber assembly for oil leaks, looseness or damage.

REAR

Each shock absorber(4) on your scooter has 5 spring preload adjustment positions for different load or riding conditions.

Use a pin spanner(5) to adjust the rear shock spring preload. Position 1 is for light loads and smooth road conditions. Position 3 to 5 increase spring preload for a stiffer rear suspension and can be used when the scooter is heavily loaded.

Be certain to adjust both shock absorbers to the same spring preload positions.

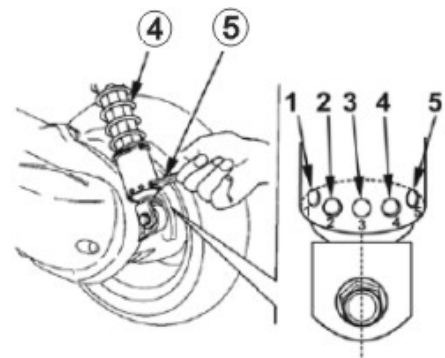

3. INSPECTION/ADJUSTMENT

NUTS/BOLTS/FASTENERS

Check all important chassis nuts and bolts for looseness.

Tighten them to their specified torque values if any looseness is found.

WHEELS/TIRES

Check the tires for cuts, imbedded nails or other damages.

Check the tire pressure.

- * • Tire pressure should be checked when tires are cold.

Tire Pressure

	1 Rider	1 Rider (with passenger)
Front	1.75 kg/cm ²	1.75 kg/cm ²
Rear	2.0 kg/cm ²	2.25 kg/cm ²

Tire Size:

Front 120/70-14
Rear 10/70-13

Check the front axle nut for looseness.
Check the rear axle nut for looseness.
If the axle nuts are loose, tighten them to the specified torques.

Torque:

Front axle nut 2 kg-m
Rear axle nut 12 kg-m

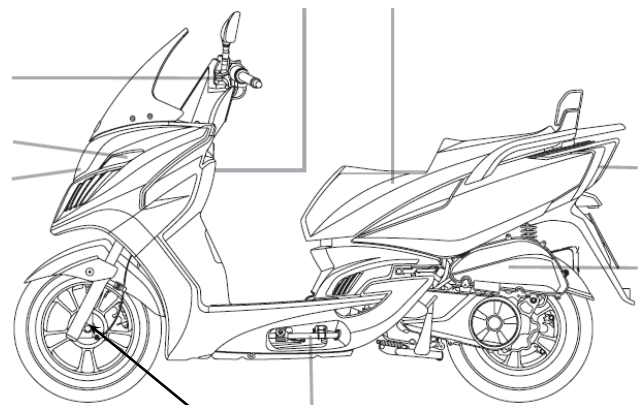
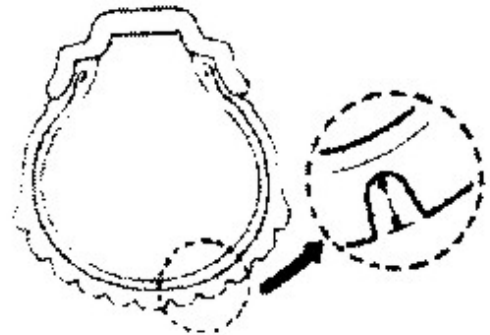

Front Axle Nut

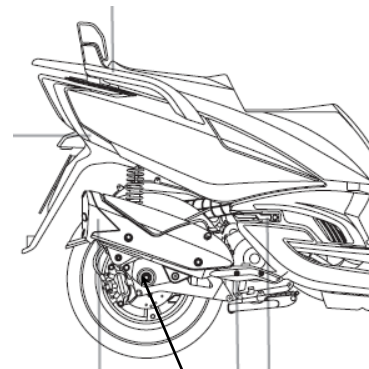

Rear Axle Nut

STEERING HANDLEBAR

Raise the front wheel off the ground and check that the steering handlebar rotates freely.

If the handlebar moves unevenly, binds, or has vertical movement, adjust the steering head bearing.

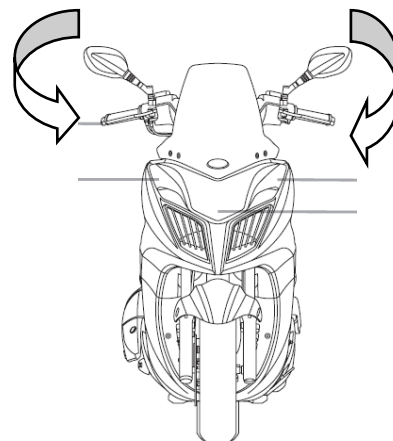

3. INSPECTION/ADJUSTMENT

SIDE STAND

Your scooter's side stand is not only necessary when you park, but it contains an important safety feature. This feature cuts-off the ignition if you try to ride the scooter when the side stand is down. Perform the following side stand inspection.

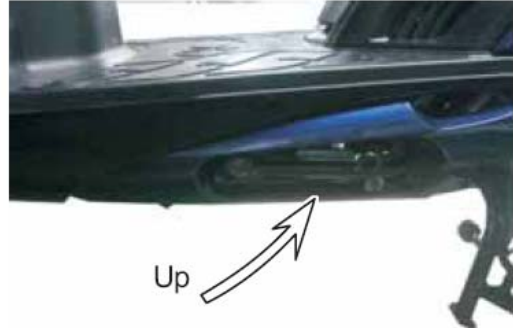

INTERLOCK FUNCTION CHECK

Check the side stand ignition cut-off system,

1. Place the scooter on its center stand.
2. Put the side stand up and start the engine.
3. Lower the side stand. The engine should stop as you put the side stand down.



* If the side stand system does not operate as described, see your KYMCO dealer for service.

4. LUBRICATION SYSTEM



LUBRICATION SYSTEM

LUBRICATION SYSTEM	4-1
SERVICE INFORMATION.....	4-2
TROUBLESHOOTING	4-2
ENGINE OIL/OIL FILTER	4-3
OIL PUMP	4-5

4. LUBRICATION SYSTEM

LUBRICATION

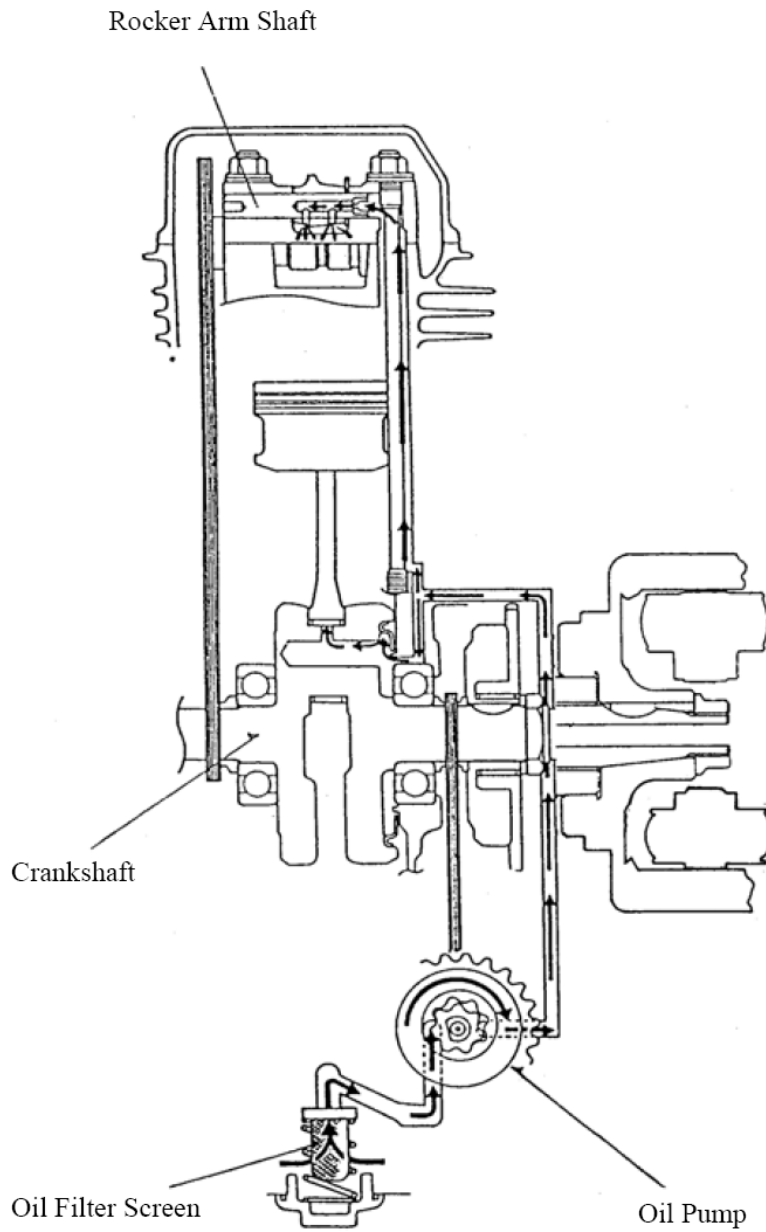

4. LUBRICATION SYSTEM

SERVICE INFORMATION

GENERAL INSTRUCTIONS

- The maintenance of lubrication system can be performed with the engine installed on the frame.
- Drain the coolant before starting any operations.
- Carefully when removing and installing the oil pump not to allow dust and foreign matters to enter the engine and oil line.
- Do not attempt to disassemble the oil pump. The oil pump must be replaced as a set when it reaches its service limit.
- After the oil pump is installed, check each part for oil leaks.

SPECIFICATIONS

ENGINE OIL

Engine Oil Capacity	At disassembly: 1.1 liter At change: 0.9 liter
Recommended Oil	SAE5W50# API: SJ

TROUBLESHOOTING

Oil level too low

- Natural oil consumption
- Oil leaks
- Worn piston rings
- Worn valve guide
- Worn valve guide seal

Poor lubrication pressure

- Oil level too low
- Clogged oil filter or oil passage
- Faulty oil pump

Oil contamination

- Oil not changed often enough
- Faulty cylinder head gasket
- Loose cylinder head bolts

4. LUBRICATION SYSTEM

ENGINE OIL/OIL FILTER

- *
 - Place the scooter upright on level ground for engine oil level check.
 - Run the engine for 2~3 minutes and check the oil level after the engine is stopped for 2~3 minutes.

Remove the oil dipstick and check the oil level with the oil dipstick.
If the level is near the lower level, fill to the upper level with the recommended engine oil.



OIL CHANGE

- *
 - The engine oil will drain more easily while the engine is warm.

Remove the oil drain bolt located at the left side of the engine to drain the engine oil.
After the oil has been completely drained, install the aluminum washer and tighten the oil drain bolt.

Pour the recommended oil through the oil filler hole.



OIL FILTER SCREEN

Drain the engine oil.
Remove the oil filter screen cap.
Remove the oil filter screen and spring.
Check the oil filter screen for clogging or damage and replace if necessary. Check the filter screen O-ring for damage and replace if necessary.
Install the oil filter screen, spring, O-ring and filter screen cap.

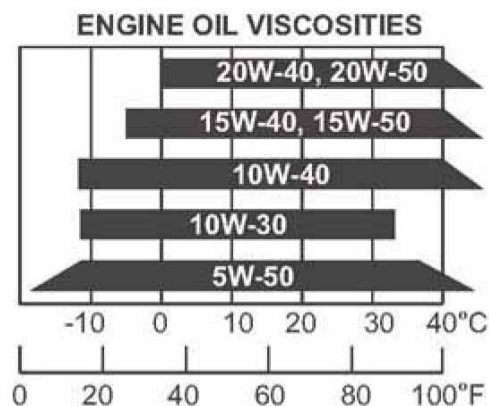

Recommended Oil: SAE5W50# API: SJ

Oil Capacity:

At disassembly: 1.1 liter

At change: 0.9 liter

Start the engine and check for oil leaks.
Start the engine and let it idle for few minutes, then recheck the oil level.

4. LUBRICATION SYSTEM

OIL FILTER REPLACEMENT

Remove the oil filler cap attaching the right-under crankcase cover.



The spring will come out when the filter cap is removed.

Let the engine oil drain out.

Check that the O-ring is in good condition.

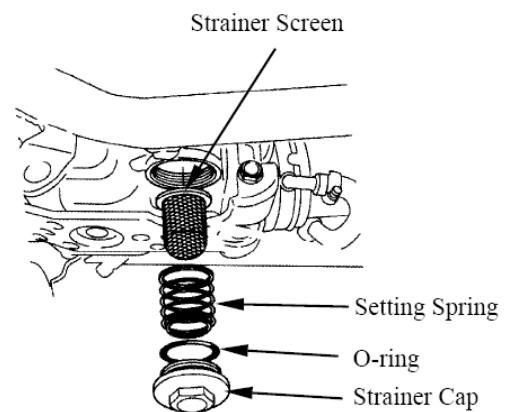

Install a new oil filter.

* Make sure the rubber seal on the oil filter facing the left crankcase

4. LUBRICATION SYSTEM

OIL PUMP

REMOVAL

Remove the flywheel.

Remove the attaching bolt and oil separator cover.

* When removing and installing the oil pump, use care not to allow dust or dirt to enter the engine.

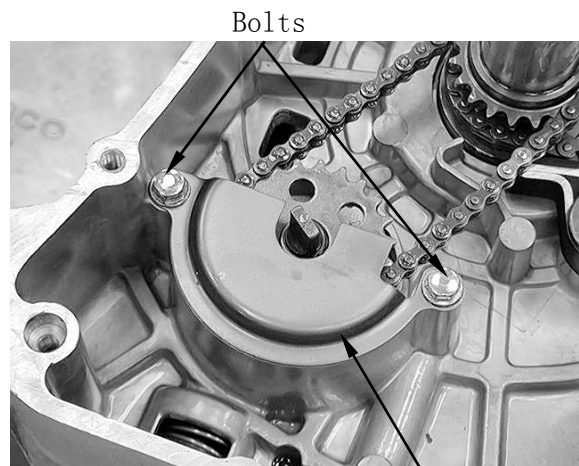

Bolts

Oil Separator Cover

Remove snap ring.

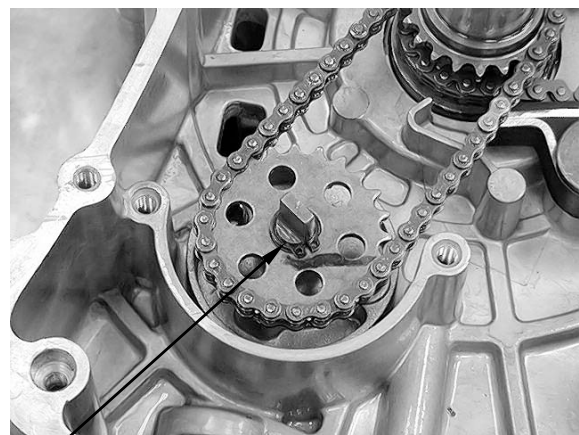

Snap Ring

Remove the oil pump driven gear, then remove the oil pump drive chain.

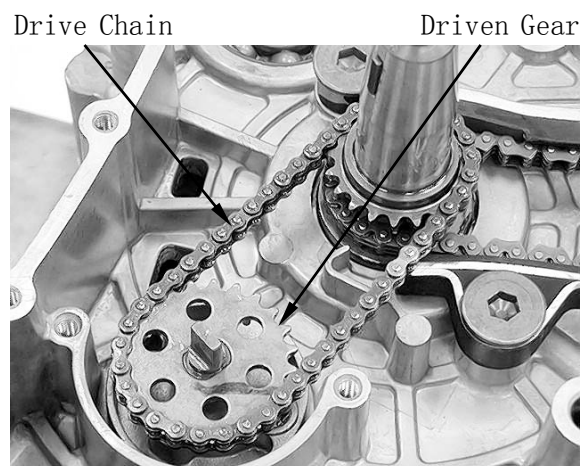

Drive Chain

Driven Gear

4. LUBRICATION SYSTEM

Remove the two oil pump bolts to remove the oil pump.

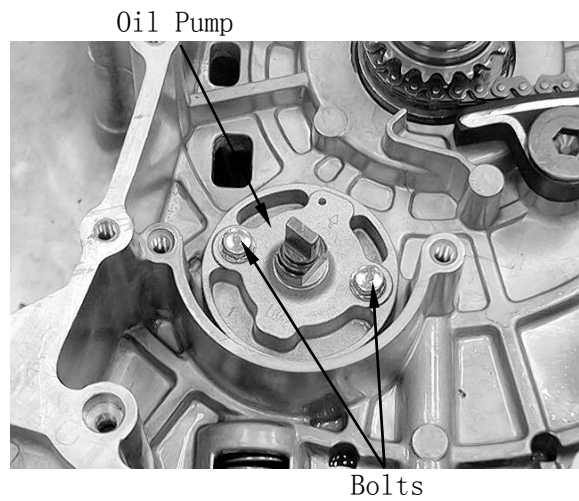

DISASSEMBLY

Remove the screw and oil pump cover.

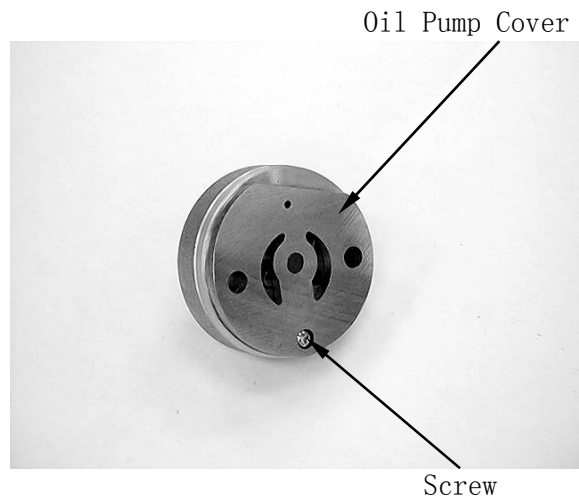

Remove the dowel pin, oil pump shaft, oil pump outer rotor and inner rotor.

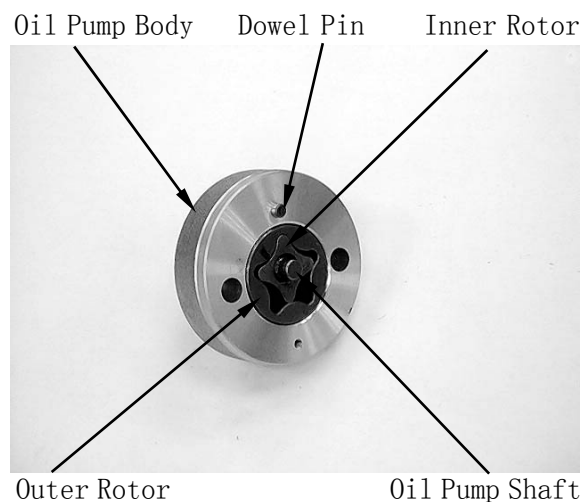

4. LUBRICATION SYSTEM

INSPECTION

Temporarily install the oil pump shaft.
Install the outer and inner rotors into the oil pump body.

Measure the tip clearance.

Service limit: 0.2 mm (0.008 in)

* Measure at several points and use the largest reading to compare the service limit.

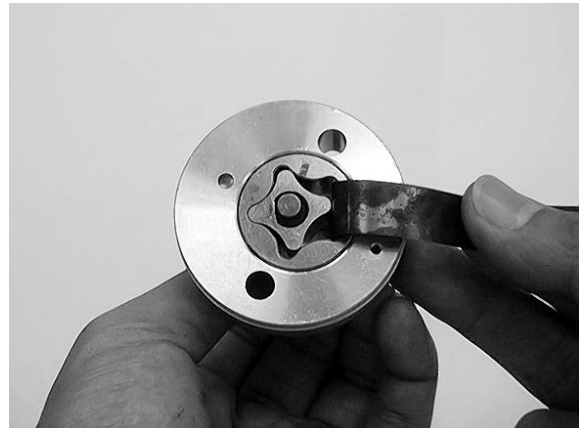

Measure the pump body clearance.

Service limit: 0.25 mm (0.01 in)

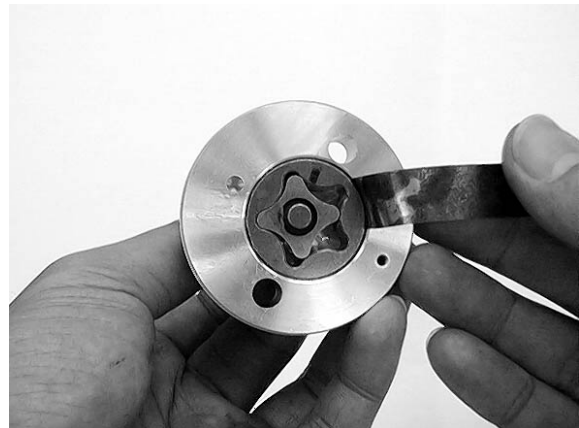

Measure the side clearance with the straight edge and feeler gauge.

Service limit: 0.12 mm (0.0048 in)

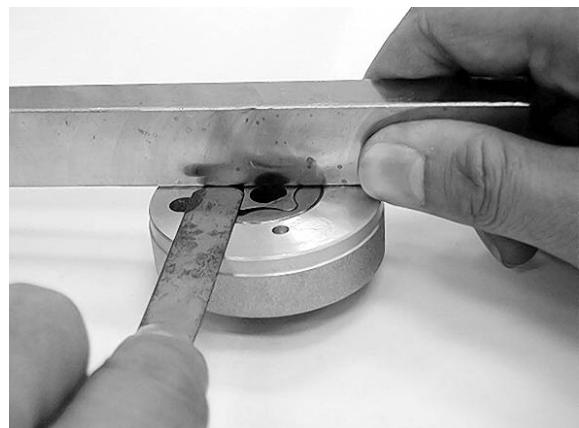

4. LUBRICATION SYSTEM

ASSEMBLY

Dip all parts in clean engine oil.

Install the outer rotor into the oil pump body.

Install the inner rotor into the outer rotor.

Install the oil pump shaft.

Install the dowel pin onto the oil pump body.

Install the oil pump cover onto the oil pump body by aligning the dowel pin.

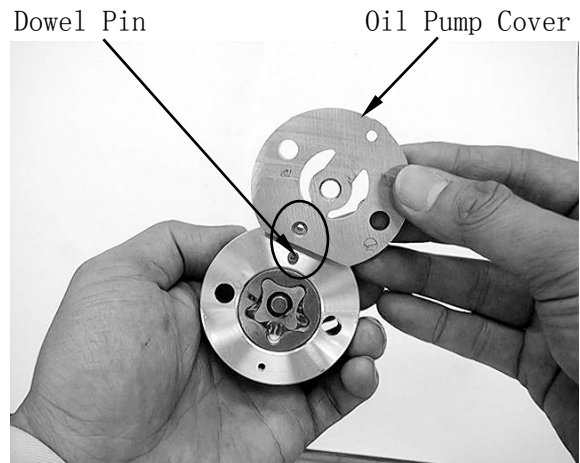

Install and tighten the screw to the specified torque.

Torqur: 3 N•m (0.3kgf•m, 2 lbf•ft)

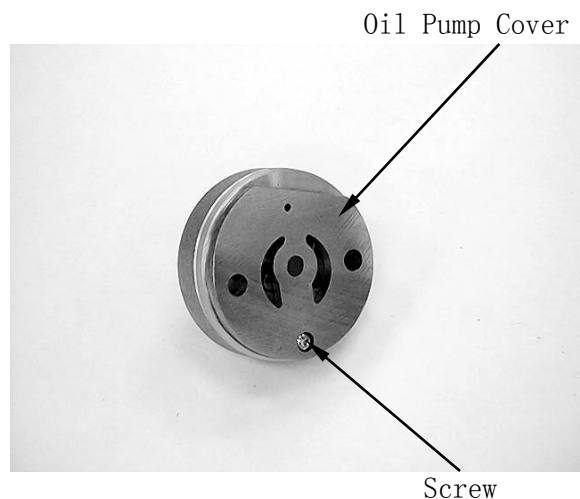

INSTALLATION

Install the oil pump and tighten the two bolts securely.

* Make sure the pump shaft rotates freely and arrow on the oil pump is

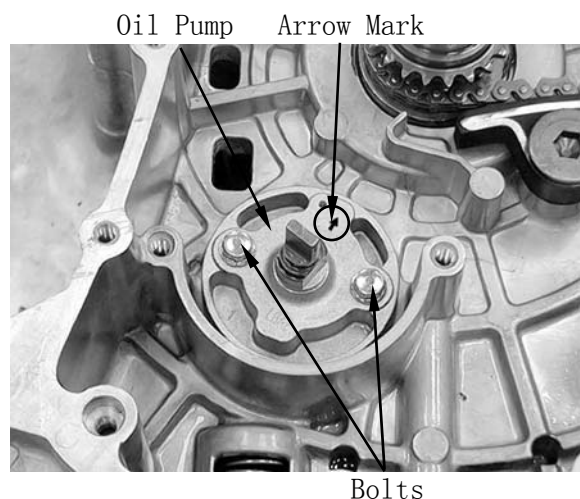

4. LUBRICATION SYSTEM

Install the oil pump driven sprocket and drive chain.

Install the snap ring.

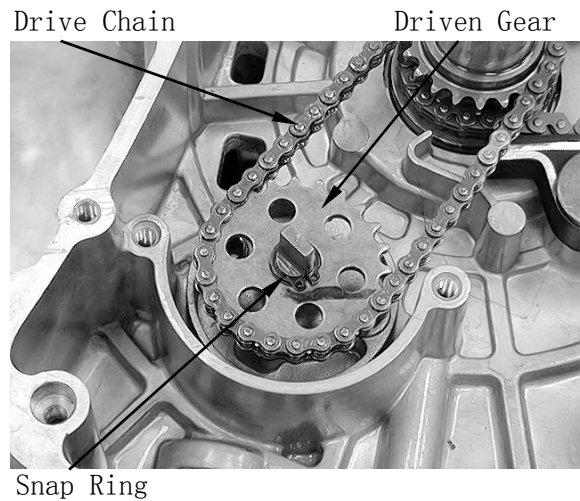

Install the oil separator cover properly and tighten two bolts securely as shown.

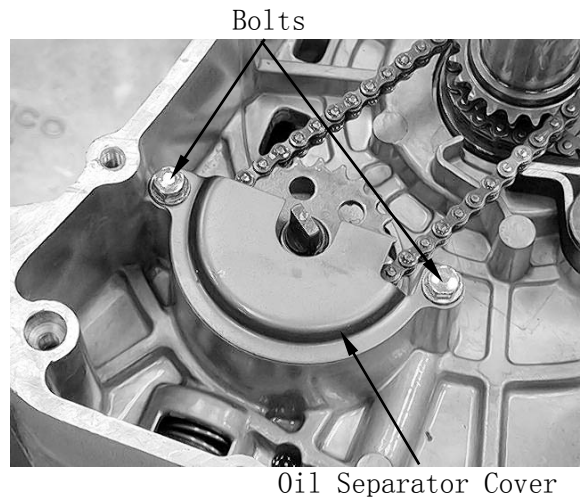

5. ENGINE REMOVAL/INSTALLATION



ENGINE REMOVAL/INSTALLATION

SERVICE INFORMATION-----	5-1
ENGINE REMOVAL/INSTALLATION-----	5-2
ENGINE HANGER -----	5-6

5. ENGINE REMOVAL/INSTALLATION

SERVICE INFORMATION

GENERAL INSTRUCTIONS

- A floor jack or other adjustable support is required to support and maneuver the engine. Be careful not to damage the scooter body, cables and wires during engine removal.
- Use shop towels to protect the scooter body during engine removal.
- Drain the coolant before removing the engine.
- After the engine is installed, fill the cooling system with coolant and be sure to bleed air from the water jacket. Start the engine to check for coolant leaks.
- Before removing the engine, the rear brake caliper must be removed first. Be careful not to bend or twist the brake fluid tube.

SPECIFICATIONS

Engine oil capacity:

At disassembly: 1.1 L

At change: 0.9 L

TORQUE VALUES

Engine hanger (Engine side)	4.5~5.5 kgf-m
Engine hanger (Frame side)	6~7 kgf-m
Rear fork mount bolts	2.4~3.0 kgf-m
Rear axle nut	11~13 kgf-m
Rear cushion lower/upper mount bolts	3.5~4.5 kgf-m

5. ENGINE REMOVAL/INSTALLATION

ENGINE REMOVAL/INSTALLATION

REMOVAL

Remove the air cleaner

Disconnect the connector including of ISC, Throttle body, TPS, WTS, MAP sensor and injector.

Disconnect the O2 sensor connector.

Disconnect the throttle cables.

Disconnect the Regulator/Rectifier connector.

Disconnect the starter relay wire from starter motor.

Remove a bolt from fuel hose guide.

Disconnect the fuel hose from fuel injector.



Disconnect the input water hose.

Disconnect the air bleed hose.



Water hose

5. ENGINE REMOVAL/INSTALLATION

Remove the muffler.

Remove the rear fork mounting bolts attaching to the crankcase.

Torque: 3.5 kgf-m (35 N-m)

Remove the rear axle nut .

Torque: 12.0 kgf-m (120 N-m)

Remove bolts attaching to the rear brake caliper.

Torque: 3.2 kgf-m (32 N-m)

Bolt

Nut

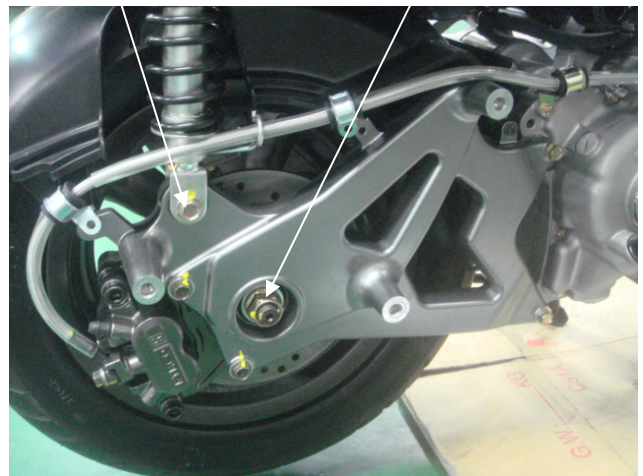

Disconnect the alternator connector .

Disconnect the ignition pulse generator connector.

Connector



Release the rubber cap and remove the terminal screw to disconnect the start motor cable from the start motor.

Remove the bolt and engine ground cable.



5. ENGINE REMOVAL/INSTALLATION

Remove the spark plug cap.



Spark Plug Cap

Disconnect the radiator hose.

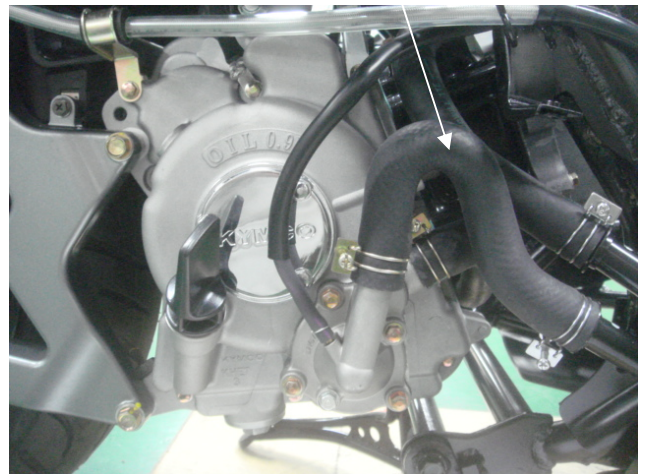

Radiator Hose

Remove the right and left rear cushion lower mount bolts.

Torque: 4.0 kgf-m (40N-m)

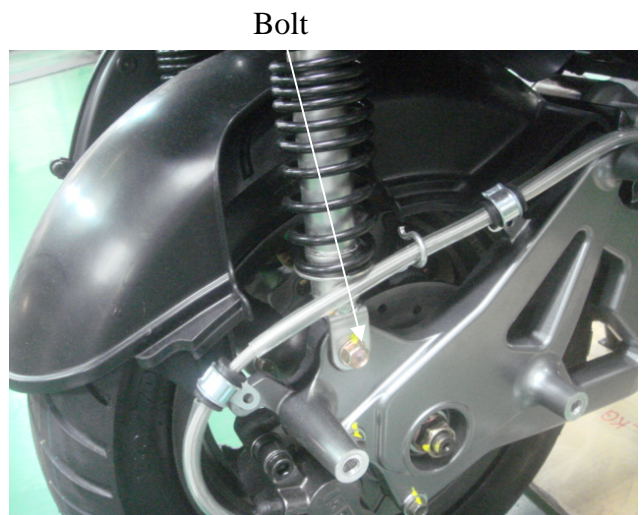

Bolt

5. ENGINE REMOVAL/INSTALLATION

Remove the engine mount nut and pull it out.
Remove the engine from the frame.

* At removing the engine, be careful not to catch your hand or finger between the engine hanger and crankcase.

Torque: 6.5 kgf-m (65 N-m)



Mount Nut

INSTALLATION

Installation is in the reverse order of removal.

After installation, inspect and adjust the following:

- Throttle grip free play
- Fill the cooling system with coolant and start the engine to bleed air from the system.

API/ABV Reset.

5. ENGINE REMOVAL/INSTALLATION

ENGINE HANGER

REMOVAL

Remove the engine mount nut and pull it out.

* Be careful to put the engine down.

Remove the left/right engine hanger mount bolt.

Remove the engine from frame.

INSTALLATION

Installation is in the reverse order of removal.

Tighten the engine hanger mount bolts to the specified torque.

Torque: 6.5 kgf-m (65 N-m)

Mount Nut

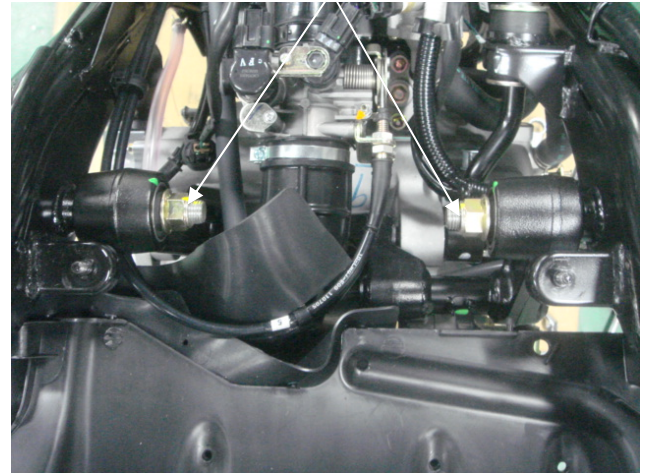

6. CYLINDER HEAD/VALVES

CYLINDER HEAD/VALVES

SCHEMATIC DRAWING -----	6- 1
SERVICE INFORMATION-----	6- 2
TROUBLESHOOTING-----	6- 3
CYLINDER COMPRESSION TEST -----	6- 4
CYLINDER HEAD COVER -----	6- 5
CAMSHAFT -----	6- 6
ROCKER ARMS -----	6- 9
CYLINDER HEAD-----	6-10

6. CYLINDER HEAD/VALVES

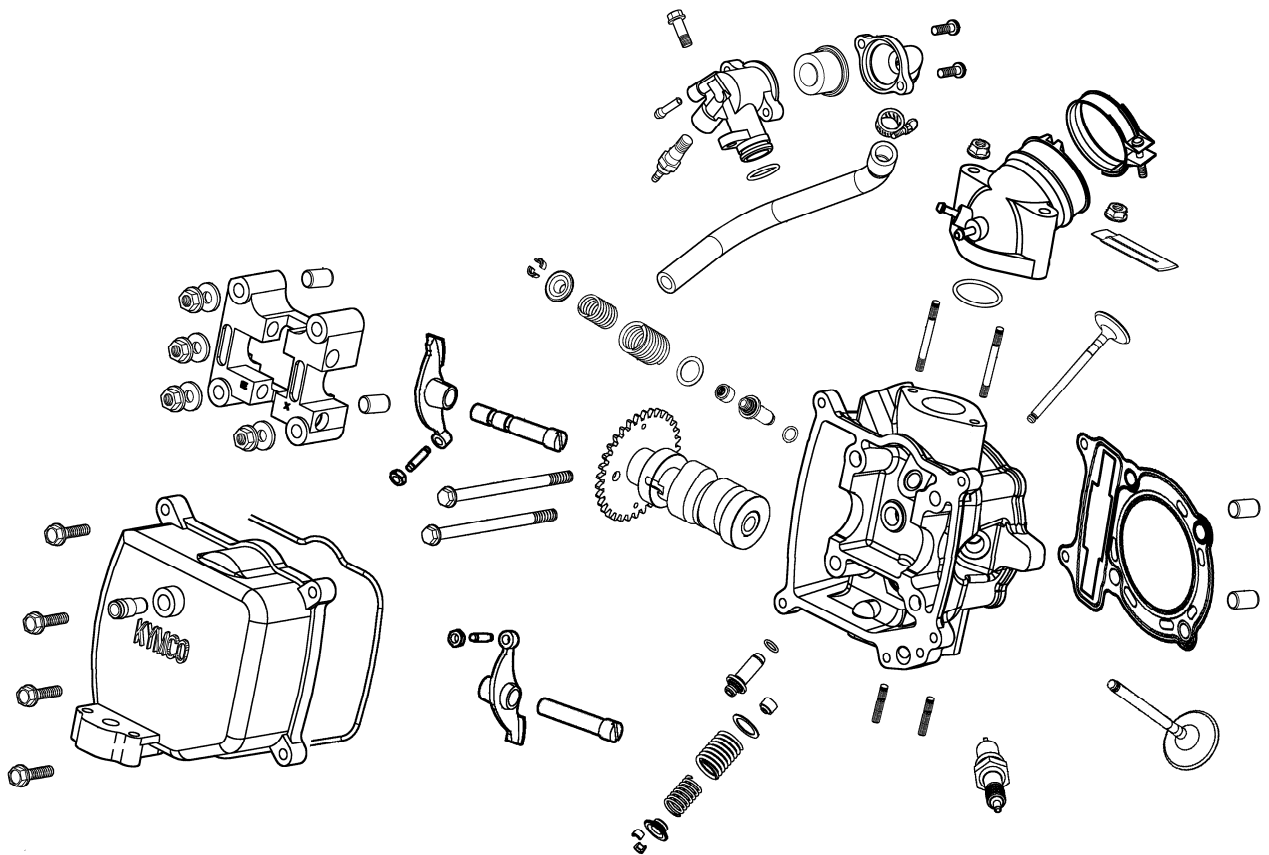

6. CYLINDER HEAD/VALVES

SERVICE INFORMATION

GENERAL INSTRUCTIONS

- The cylinder head can be serviced with the engine installed in the frame. Coolant in the radiator and water jacket must be drained first.
- When assembling, apply molybdenum disulfide grease or engine oil to the valve guide movable parts and valve arm sliding surfaces for initial lubrication.
- The valve rocker arms are lubricated by engine oil through the cylinder head engine oil passages. Clean and unclog the oil passages before assembling the cylinder head.
- After disassembly, clean the removed parts and dry them with compressed air before inspection.
- After removal, mark and arrange the removed parts in order. When assembling, install them in the reverse order of removal.

SPECIFICATIONS

Unit: mm (in)

Item		Standard	Service Limit
Valve clearance (cold)	IN	0.1 mm (0.004 in)	—
	EX	0.1 mm (0.004 in)	—
Cylinder head compression pressure		15 kg/cm ² (213 psi, 1500 kPa)	—
Cylinder head warpage		—	0.05 (0.002)
Camshaft cam height	IN	34.2987 (1.371948)	34.14 (1.3656)
	EX	34.1721 (1.366884)	34.02 (1.3608)
Valve rocker arm I.D.	IN	10 (0.4)~10.015 (0.4006)	10.1 (0.404)
	EX	10 (0.4)~10.015 (0.4006)	10.1 (0.404)
Valve rocker arm shaft O.D.	IN	9.972 (0.399)~9.987 (0.3995)	9.9 (0.396)
	EX	9.972 (0.399)~9.987 (0.3995)	9.9 (0.396)
Valve stem O.D.	IN	4.975 (0.199)~4.99 (0.1996)	4.925 (0.197)
	EX	4.955 (0.1982)~4.97 (0.1988)	4.915 (0.1966)
Valve guide I.D.	IN	5 (0.2)~5.012 (0.2005)	5.03 (0.2012)
	EX	5 (0.2)~5.012 (0.2005)	5.03 (0.2012)
Valve stem-to-guide clearance	IN	0.01 (0.004)~0.037 (0.0015)	0.08 (0.0032)
	EX	0.03 (0.0012)~0.057 (0.0023)	0.1 (0.004)

TORQUE VALUES

Cylinder head cap nut	25 N•m (2.5 kgf•m, 18 lbf•ft)	Apply engine oil to threads
Valve clearance adjusting nut	9 N•m (0.9 kgf•m, 6.5 lbf•ft)	Apply engine oil to threads
Cylinder head cover bolt	12 N•m (1.2 kgf•m, 8.6 lbf•ft)	

SPECIAL TOOLS

Valve spring compressor	A120E00040
-------------------------	------------

6. CYLINDER HEAD/VALVES

TROUBLESHOOTING

- The poor cylinder head operation can be diagnosed by a compression test or by tracing engine top-end noises.

Poor performance at idle speed

- Compression too low

Compression too low

- Incorrect valve clearance adjustment
- Burned or bent valves
- Incorrect valve timing
- Broken valve spring
- Poor valve and seat contact
- Leaking cylinder head gasket
- Warped or cracked cylinder head
- Poorly installed spark plug

Compression too high

- Excessive carbon build-up in combustion chamber

White smoke from exhaust muffler

- Worn valve stem or valve guide
- Damaged valve stem oil seal

Abnormal noise

- Incorrect valve clearance adjustment
- Sticking valve or broken valve spring
- Damaged or worn camshaft
- Worn cam chain tensioner
- Worn camshaft and rocker arm

6. CYLINDER HEAD/VALVES

CYLINDER COMPRESSION TEST

Warm up the engine to normal operating temperature.
Stop the engine and remove the spark plug cap and remove the spark plug.



Park Plug Cap

Install a compression gauge into the spark plug hole.

Open the throttle all the way and crank the engine with the starter motor until the gauge reading stops rising.

The maximum reading is usually reached 4 – 7 seconds.

*

To avoid discharging the battery, do not operate the starter motor for more than seven seconds.

Compression pressure:

15 kg/cm² (213 psi, 1500 kPa)

Low compression can be caused by:

- ♦ Blown cylinder head gasket
- ♦ Improper valve adjustment
- ♦ Valve leakage
- ♦ Worn piston ring or cylinder

High compression can be caused by:

- ♦ Carbon deposits in combustion chamber or on piston head

6. CYLINDER HEAD/VALVES

CYLINDER HEAD COVER

DISASSEMBLY

Remove the floorboard
Disconnect the crankcase breather hose from
the cylinder head cover.

Remove the four bolts and two nuts, then
remove cylinder head cover.

Remove the cylinder head cover O-ring.

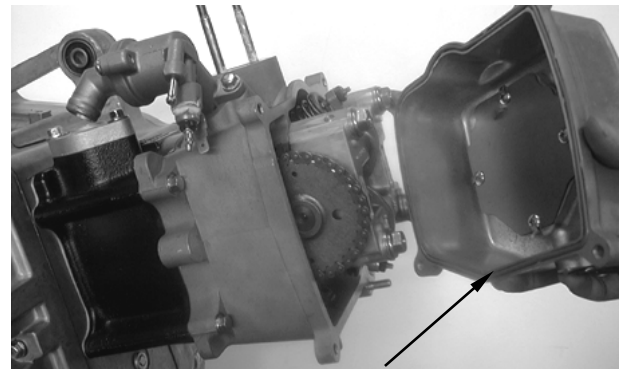

O-ring

6. CYLINDER HEAD/VALVES

CAMSHAFT

REMOVAL

Turn the A.C. generator flywheel so that the "T" mark on the flywheel aligns with the index mark on the right crankcase cover

Hold the round hole on the camshaft gear facing up and the location is the top dead center on the compression stroke.
Remove the cam chain tensioner lifter sealing bolt.

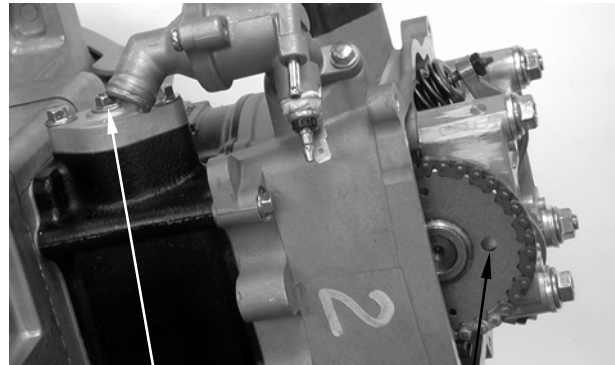

Cam Chain Tensioner

Round Hole

Turn the cam chain tensioner screw clockwise to pull the tensioner rod all the way in.

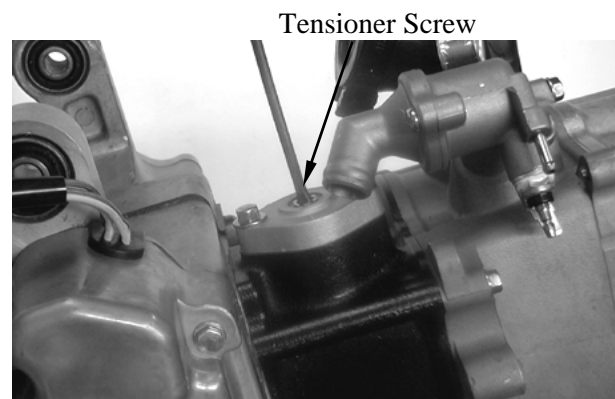

Tensioner Screw

Remove the four cap nuts attaching the camshaft holder.

- * • Diagonally loosen the cylinder head cap nuts in 2 or 3 times.

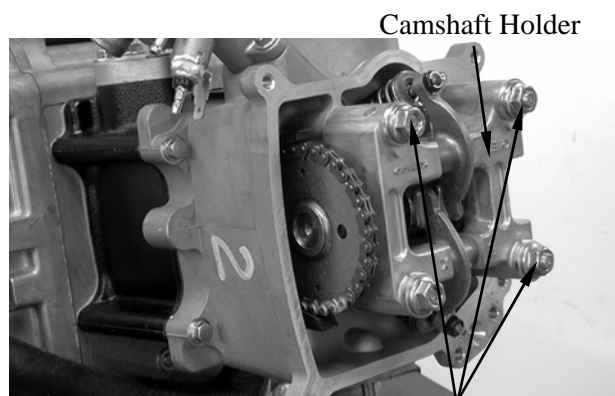

Camshaft Holder

Cap Nuts

6. CYLINDER HEAD/VALVES

Remove the camshaft holder and dowel pins.

Camshaft Holder/Dowel Pins

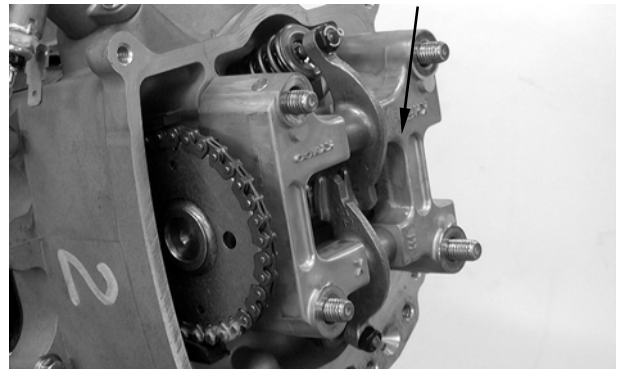

Remove the camshaft gear from the cam chain to remove the camshaft.

Cam Chain

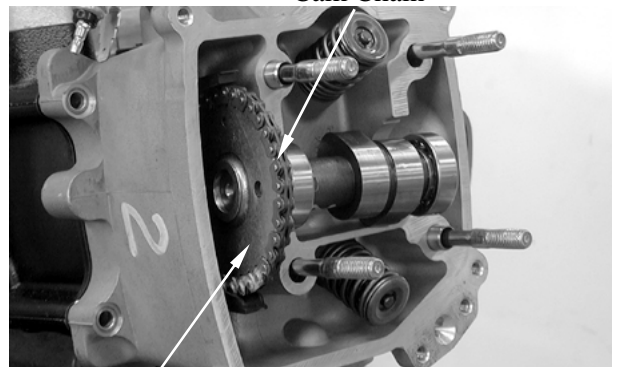

Camshaft Gear

6. CYLINDER HEAD/VALVES

INSPECTION

Camshaft

Check each cam lobe for wear or damage.
Measure the cam lobe height.

Service Limits: IN : 34.14 mm (1.3656 in)
EX: 34.02 mm (1.3608 in)

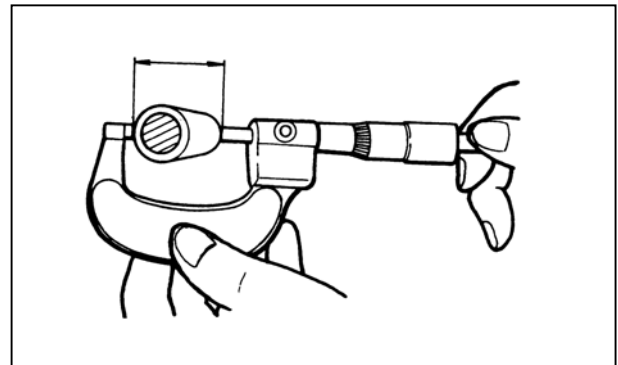

Check each camshaft bearing for play or damage. Replace the camshaft assembly with a new one if the bearings are noisy or have excessive play.

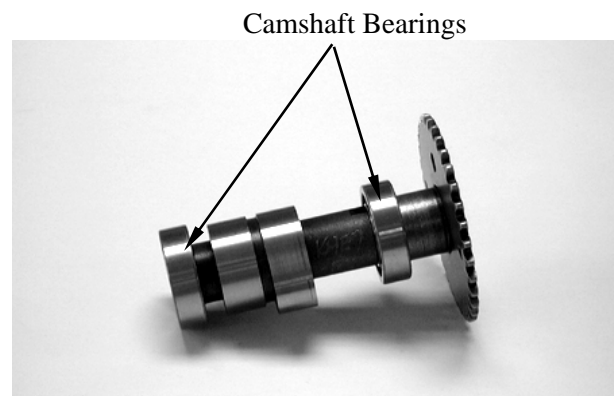

6. CYLINDER HEAD/VALVES

ROCKER ARMS

REMOVAL

Remove the camshaft.

Remove the rocker arm shafts and then remove the rocker arms.

INSPECTION

Camshaft holder

Inspect the bearing surface of camshaft holder for scoring, scratches, or evidence of insufficient lubrication.

Rocker arm shaft

Inspect the rocker arm shaft for blue discoloration or grooves.

If any defects are found, replace the rocker arm shaft with a new one, then inspect lubrication system.

Measure each rocker arm shaft O.D.
 Measure the I.D. of each rocker arm.
 Measure arm to shaft clearance.
 Replace as a set if out of specification.

Service limits: 0.1 mm (0.004 in)

Inspect the rocker arm bore, cam lobe contact surface and adjuster surface for wear/pitting/scratches/blue discoloration.

If any defects are found, replace the rocker arm shaft with a new one, then inspect lubrication system.

Measure each rocker arm shaft O.D.
 Measure the I.D. of each rocker arm.
 Measure arm to shaft clearance.
 Replace as a set if out of specification.

Service limits: 0.1 mm (0.004 in)

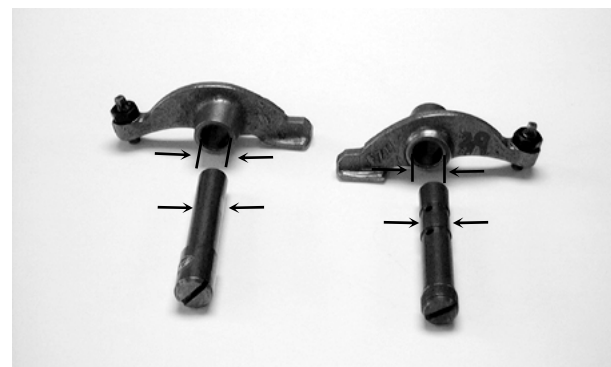
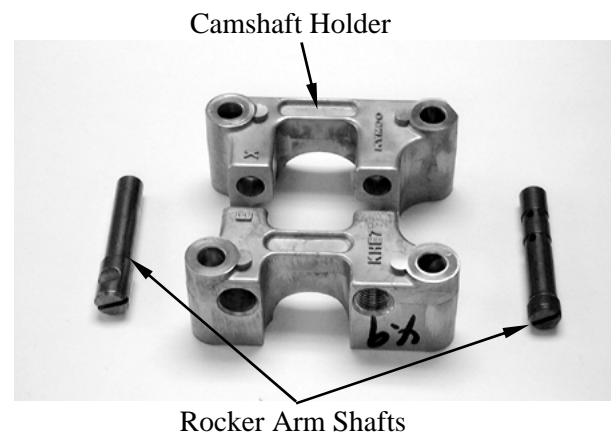
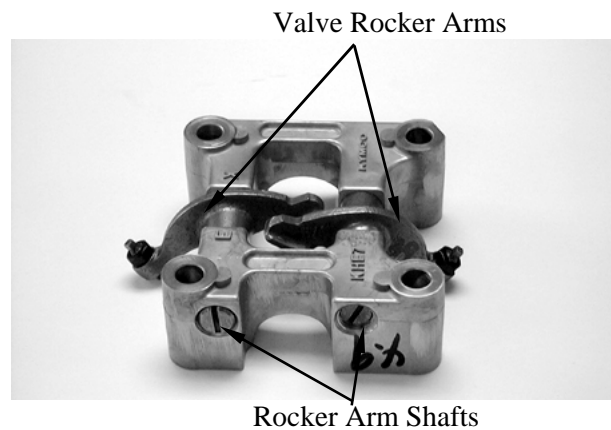

6. CYLINDER HEAD/VALVES

CYLINDER HEAD

First drain the coolant from the radiator and water jacket, then remove the thermostat water hose.

Remove the camshaft.

Remove the carburetor and intake pipe.

Remove the two cylinder bolts.

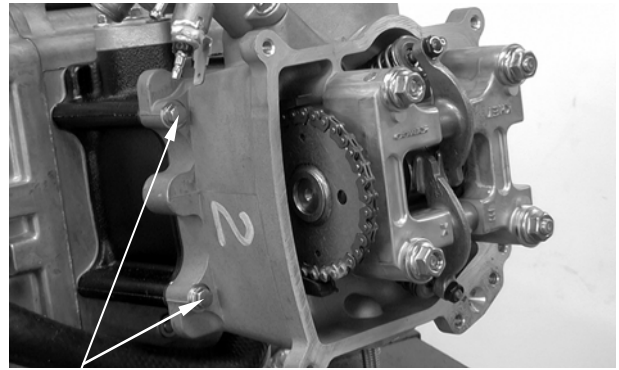

Cylinder Bolts

Remove the bolt attaching the thermostat housing and the thermostat housing.
Remove the cylinder head.

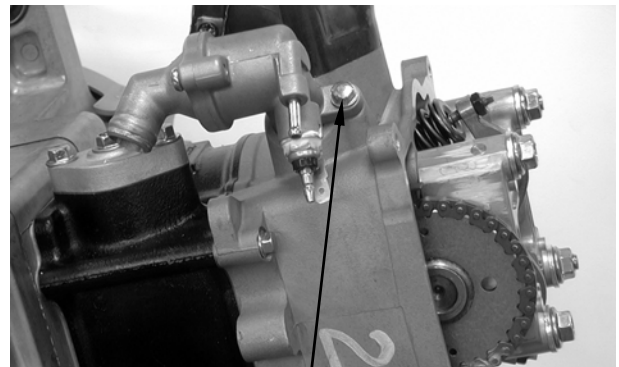

Bolt

Remove the dowel pins and cylinder head gasket.
Remove the cam chain guide.
Remove all gasket material from the cylinder head mating surface.

* Be careful not to drop any gasket material into the engine.

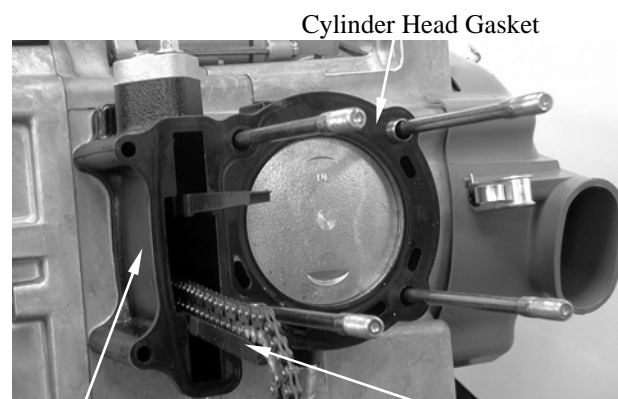

Cylinder

Cam Chain Tensioner Slipper

6. CYLINDER HEAD/VALVES

CYLINDER HEAD DISASSEMBLY

Remove the valve spring cotters, retainers, springs, spring seats, oil seals and valves using a valve spring compressor.

*

- Be sure to compress the valve springs with a valve spring compressor.
- Mark all disassembled parts to ensure correct reassembly.

Special tool:

Valve Spring Compressor A120E00040

Valve Spring Compressor

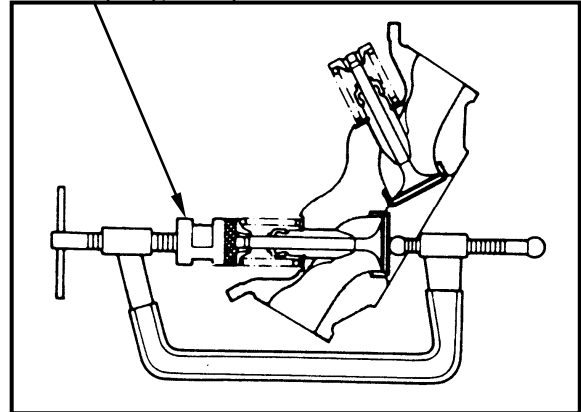

6. CYLINDER HEAD/VALVES

VALVE /VALVE GUIDE INSPECTION

Inspect each valve for bending, burning, scratches or abnormal stem wear.
If any defects are found, replace the valve with a new one.

Check valve movement in the guide.

Measure each valve stem O.D.

Measure each valve guide I.D.

Subtract each valve stem O.D. from the corresponding guide I.D. to obtain the stem-to-guide clearance.

Service limits:

IN: 0.08 mm (0.0032 in)

EX: 0.1 mm (0.004 in)

* If the stem-to-guide clearance exceeds the service limits, replace the cylinder head is necessary.

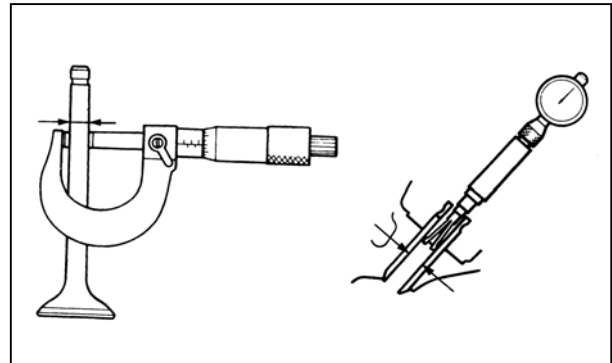

CYLINDER HEAD INPECTION

Check the spark plug hole and valve areas for cracks.

Check the cylinder head for warpage with a straight edge and feeler gauge.

Service Limit: 0.05 mm (0.002 in)

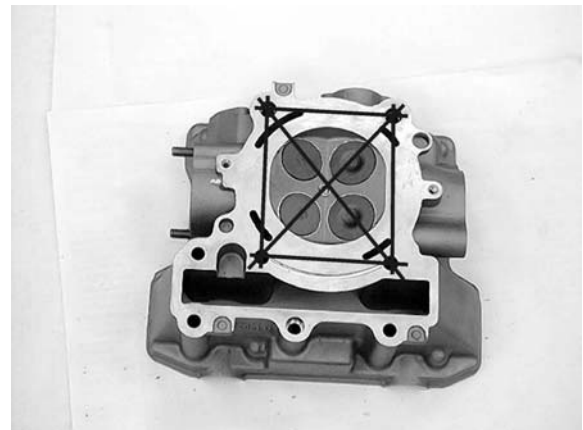

VALVE SPRING INSPECTION

Measure the free length of the inner and outer valve springs.

Service Limit:

Inner: 29.1 mm (1.164 in)

Outer: 39.2 mm (1.568 in)

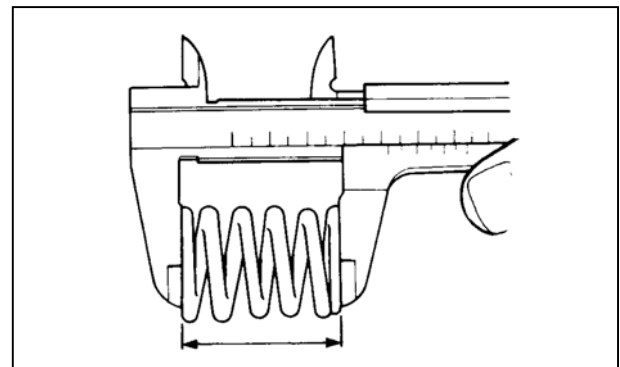

6. CYLINDER HEAD/VALVES

Measure compressed force (valve spring) and installed length.

Replace if out of specification.

Standard:

Inner: 2.95 kg (at 26.6 mm, 1.064 in)

Outer: 10.45 kg (at 29.6 mm, 1.184 in)

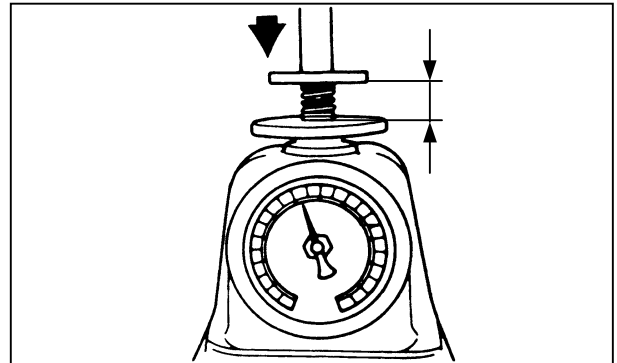

Measure the spring tilt.

Replace if out of specification.

Standard:

Inner: 0.81 mm (0.0324 in)

Outer: 1.07 mm (0.0428 in)

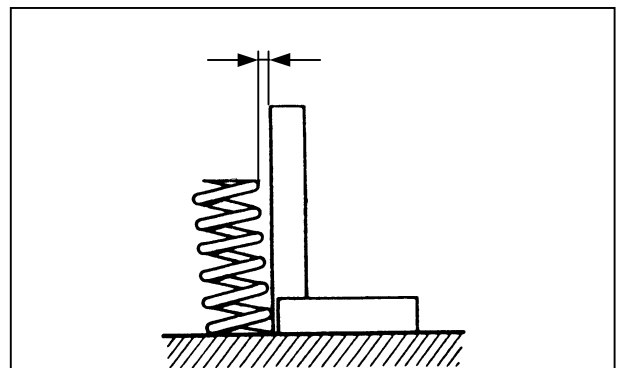

ASSEMBLY

Install the valve spring seats and oil seal.

* Be sure to install new oil seal.

Lubricate each valve with engine oil and insert the valves into the valve guides. Install the valve springs and retainers. Compress the valve springs using the valve spring compressor, then install the valve cotters.

* • When assembling, a valve spring compressor must be used.
• Install the cotters with the pointed ends facing down from the upper side of the cylinder head.

Valve Spring Compressor

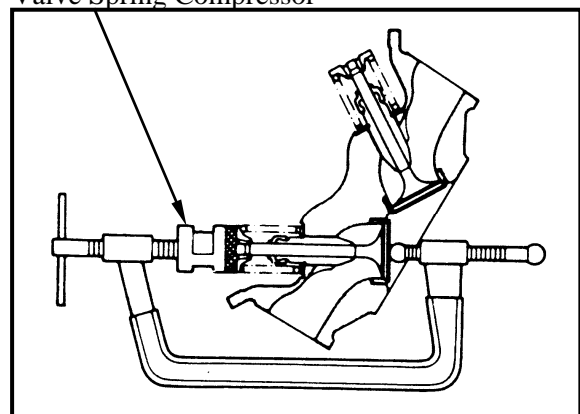

Special tool:

Valve Spring Compressor A120E00040

6. CYLINDER HEAD/VALVES

INSTALLATION

Install the cam chain guide.

Install the dowel pins and a new cylinder head gasket.

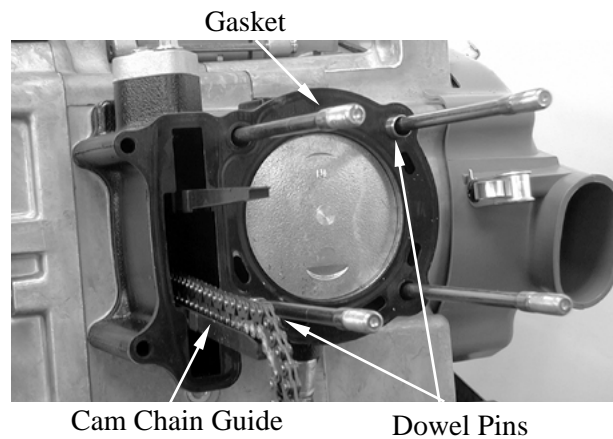

Install the cylinder head and take out the cam chain

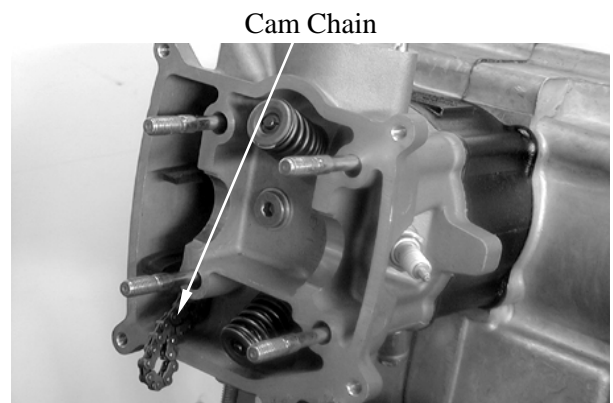

Assemble the camshaft holder.
First install the intake and exhaust valve rocker arms; then install the rocker arm shafts.

- *
 - Install the exhaust valve rocker arm shaft on the “EX” side of the camshaft holder and the exhaust rocker arm shaft is shorter.
 - Clean the intake valve rocker arm shaft off any grease before installation.
 - Align the cutout on the exhaust valve rocker arm shaft with the bolt of the camshaft holder.

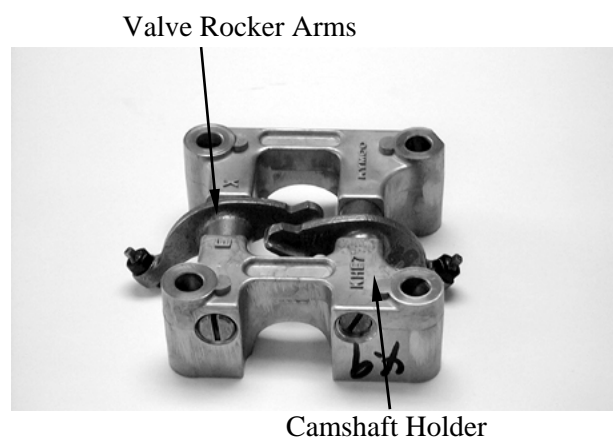

6. CYLINDER HEAD/VALVES

Turn the A.C. generator flywheel so that the “T” mark on the flywheel aligns with the index mark on the right crankcase cover. Keep the round hole on the camshaft gear facing up and align the punch marks on the camshaft gear with the cylinder head surface (Position the intake and exhaust cam lobes down.) and install the cam chain over the camshaft gear.

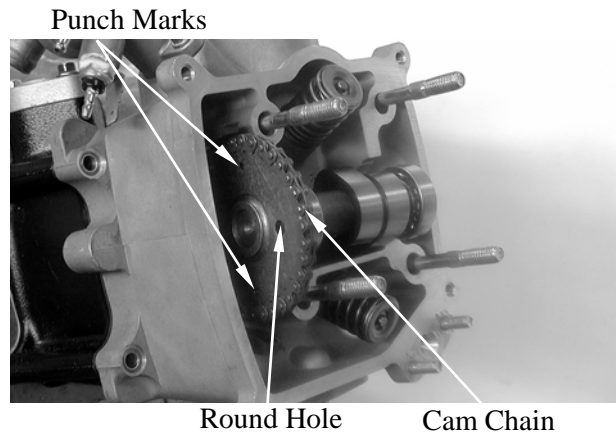

Install the dowel pins.

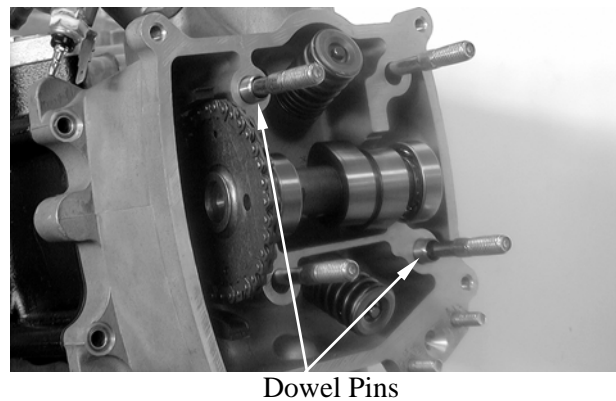

Install the camshaft holder, washers and nuts on the cylinder head. Tighten the four cylinder head cap nuts and two cylinder bolts to the specified torque.

Torque:

Cylinder head cap nut:

25 N•m (2.5 kgf•m, 18 lbf•ft)

Apply engine oil to threads

Cylinder bolt: 10 N•m (1 kgf•m, 7 lbf•ft)

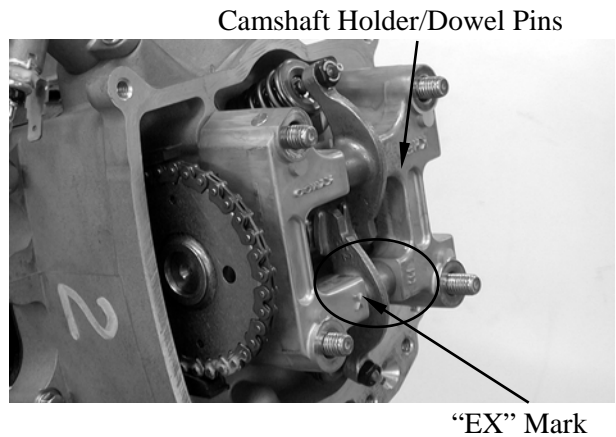

- *
 - Install the camshaft holder with the “EX” mark face exhaust valve side.
 - Apply engine oil to the threads of the cylinder head cap nuts.
 - Diagonally tighten the cylinder head cap nuts in 2~3 times.
 - First tighten the cylinder head cap nuts and then tighten the cylinder bolts to avoid cracks.

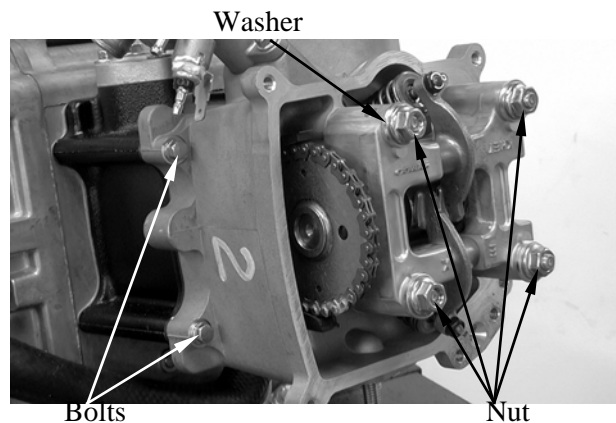

6. CYLINDER HEAD/VALVES

Turn the cam chain tension screw counterclockwise to release it.

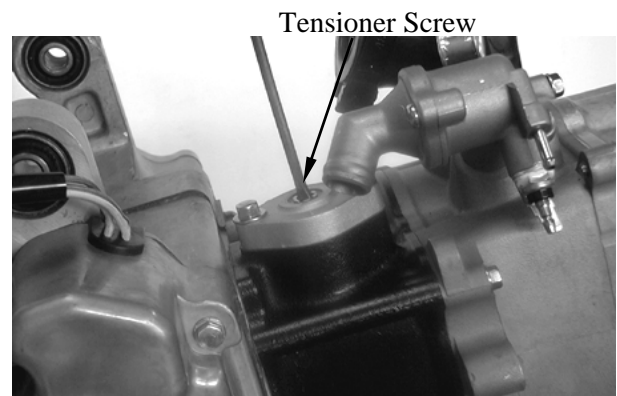

Apply engine oil to a new O-ring and install it.

Tighten the cam chain tension cap screw.

* Be sure to install the gasket into the groove properly.

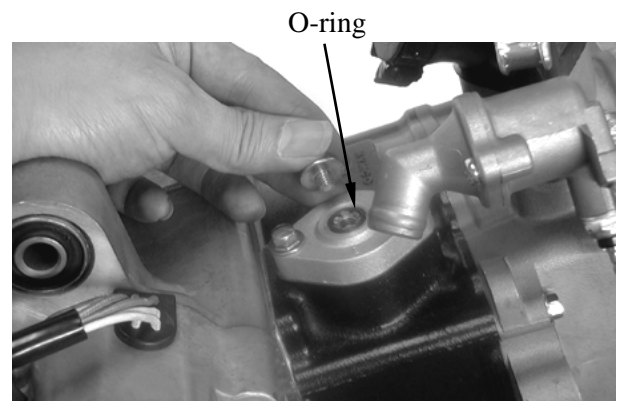

Adjust the valve clearance.

Install a new cylinder head cover O-ring and install the cylinder head cover.

* Be sure to install the O-ring into the groove properly.

Install and tighten the cylinder head cover bolts.

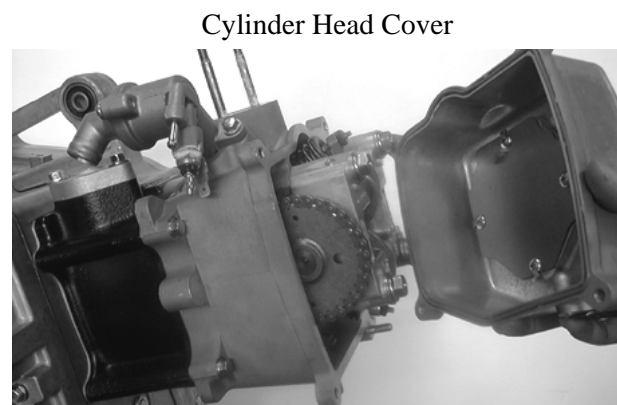

Torque: 10 N•m (1 kgf•m, 7 lbf•ft)

7. CYLINDER/PISTON

CYLINDER/PISTON

SCHEMATIC DRAWING	7- 1
SERVICE INFORMATION.....	7- 2
TROUBLESHOOTING.....	7- 2
CYLINDER/PISTON	7- 3



7. CYLINDER/PISTON

SCHEMATIC DRAWING

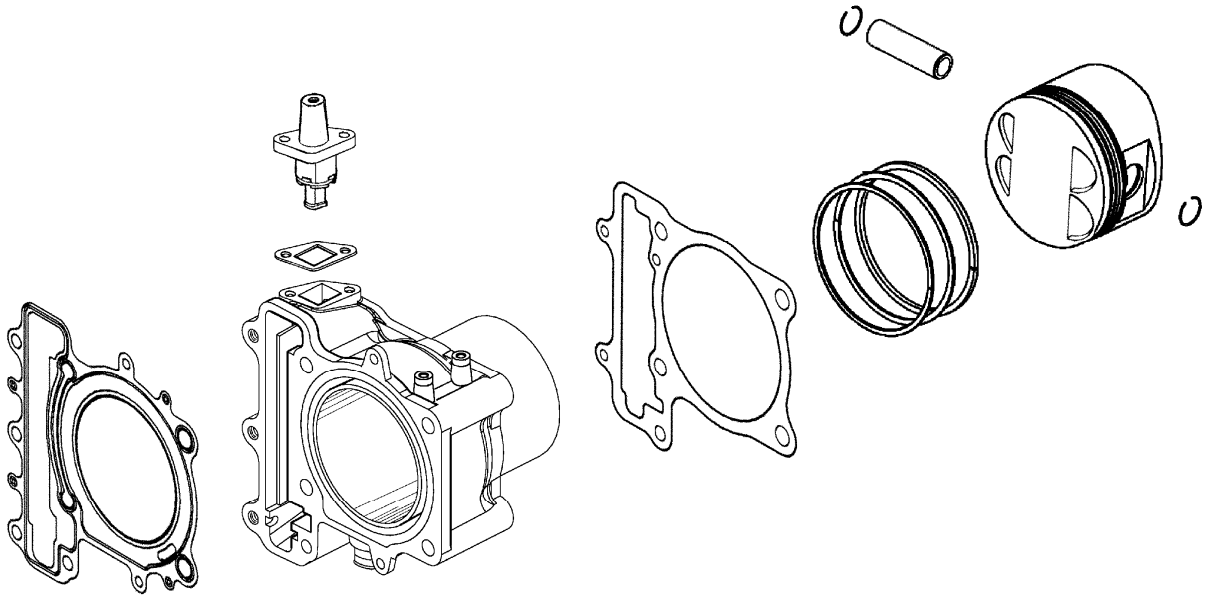

7. CYLINDER/PISTON

SERVICE INFORMATION

GENERAL INSTRUCTIONS

- The cylinder and piston can be serviced with the engine installed in the frame.
- When installing the cylinder, use a new cylinder gasket and make sure that the dowel pins are correctly installed.
- After disassembly, clean the removed parts and dry them with compressed air before inspection.

SPECIFICATIONS

Unit: mm (in)

Item		Standard	Service Limit	
Cylinder	I.D.	72.75 (2.91)~72.7015 (2.90806)	72.8 (2.912)	
	Warpage	0.01 (0.0004)	0.05 (0.002)	
	Cylindricity	0.01 (0.0004)	0.1 (0.004)	
	True roundness	0.01 (0.0004)	0.1 (0.004)	
Piston, piston ring	Ring-to-groove clearance	top	0.03 (0.0012)~0.065 (0.0026)	0.08 (0.003)
		Second	0.015 (0.0006)~0.05 (0.002)	0.65 (0.0026)
	Ring end gap	top	0.15 (0.006)~0.3 (0.012)	0.5 (0.02)
		Second	0.03 (0.012)~0.45 (0.018)	0.65 (0.026)
		Oil side rail	0.2 (0.008)~0.7 (0.028)	1 (0.04)
	Piston O.D.	72.67 (2.9068)~72.69 (2.9076)	72.6 (2.904)	
	Piston O.D. measuring position	9 mm from bottom of skirt	—	
	Piston-to-cylinder clearance	0.01 (0.0004)~0.045 (0.0018)	0.1 (0.004)	
Piston pin hole I.D.	17.002 (0.68008)~17.008 (0.68032)	17.04 (0.6816)		
Piston pin O.D	16.994 (0.67976)~17 (0.68)	16.96 (0.6784)		
Piston-to-piston pin clearance	0.002 (0.0001)~0.014 (0.0006)	0.02 (0.001)		
Connecting rod small end I.D. bore	17.016 (0.68064)~17.034 (0.68136)	17.06 (0.6824)		

TROUBLESHOOTING

- When hard starting or poor performance at low speed occurs, check the crankcase breather for white smoke. If white smoke is found, it means that the piston rings are worn, stuck or broken.

Compression too low or uneven compression

- Worn or damaged cylinder and piston rings
- Worn, stuck or broken piston rings

Compression too high

- Excessive carbon build-up in combustion chamber or on piston head

Excessive smoke from exhaust muffler

- Worn or damaged piston rings
- Worn or damaged cylinder and piston

Abnormal noisy piston

- Worn cylinder, piston and piston rings
- Worn piston pin hole and piston pin
- Incorrectly installed piston

7. CYLINDER/PISTON

CYLINDER/PISTON

REMOVAL

Remove the cylinder head.

Remove the water hose from the cylinder.
Remove the cylinder head gasket and dowel pine.

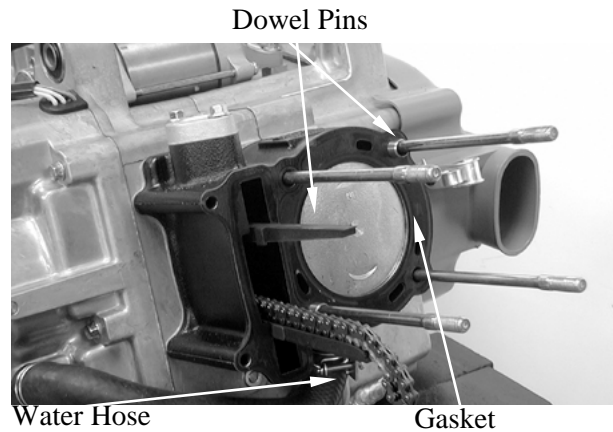

Remove the cam chain guide.
Remove the cylinder.

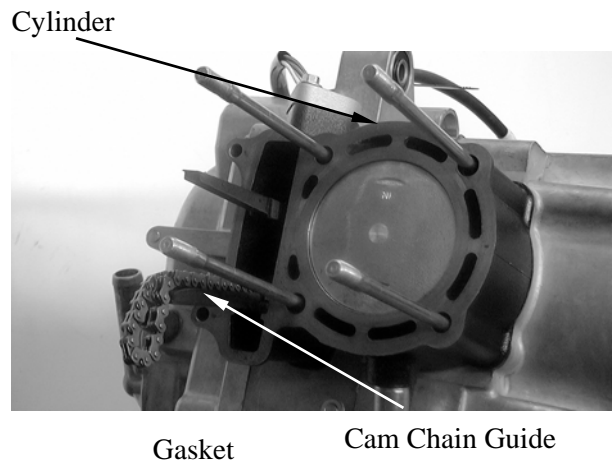

Remove the cylinder gasket and dowel pins.
Clean any gasket material from the cylinder surface.

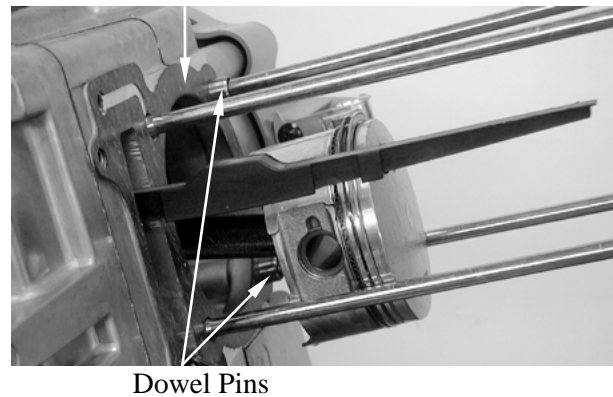

Remove the piston pin clip.

* Place a clean shop towel in the crankcase to keep the piston pin clip from falling into the crankcase.

Press the piston pin out of the piston and remove the piston.

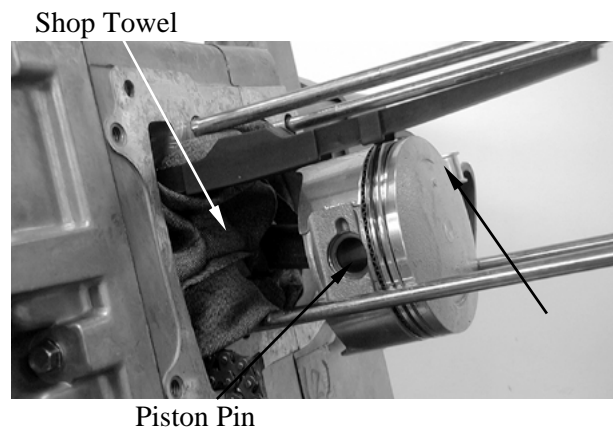

7. CYLINDER/PISTON

PISTON RING REMOVAL

Spread each piston ring and remove it by lifting up at a point opposite the gap

- * Do not damage the piston ring by spreading the ends too far.

Clean carbon deposits from the piston ring grooves.

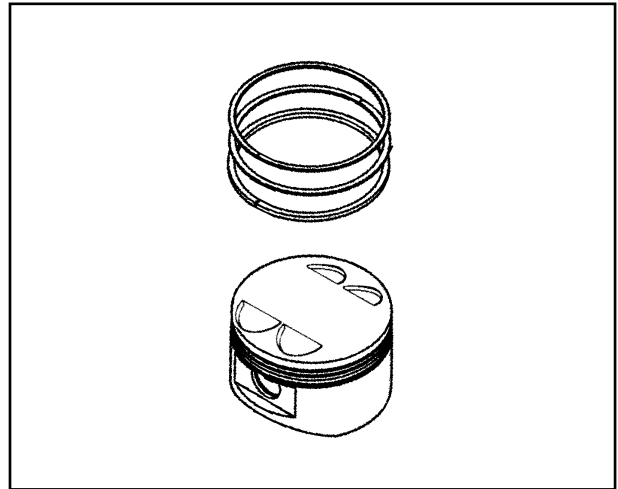

INSPECTION

Piston ring

Inspect the piston rings for movement by rotating the rings. The rings should be able to move in their grooves without catching.

Push the ring until the outer surface of the piston ring is nearly flush with the piston and measure the ring-to-groove clearance.

Service Limits: Top: 0.08 mm (0.003 in)
2nd: 0.065 mm (0.0026 in)

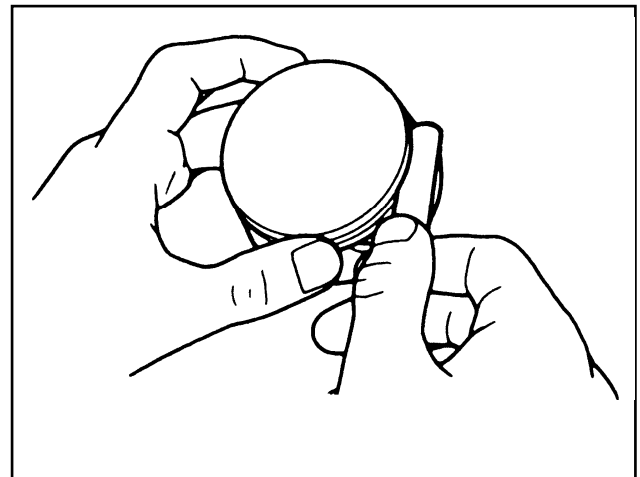

Insert each piston ring into the bottom of the cylinder squarely.

- * Use the piston head to push each piston ring into the cylinder.

Measure the piston ring end gap.

Service Limit:

Top: 0.5 mm (0.02 in)
2nd: 0.65 mm (0.026 in)
Oil ring: 1 mm (0.04 in)

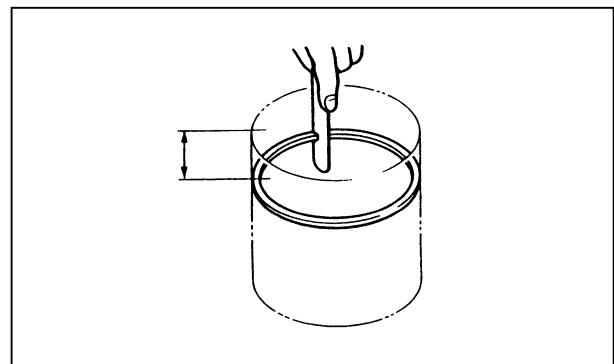

7. CYLINDER/PISTON

Piston/Piston pin

Measure the piston O.D. at the point (A) from the bottom and 90° to the piston pin hole.

Service Limit:

72.6 mm (2.904 in) at (A): 9 mm

Calculate the cylinder-to-piston clearance

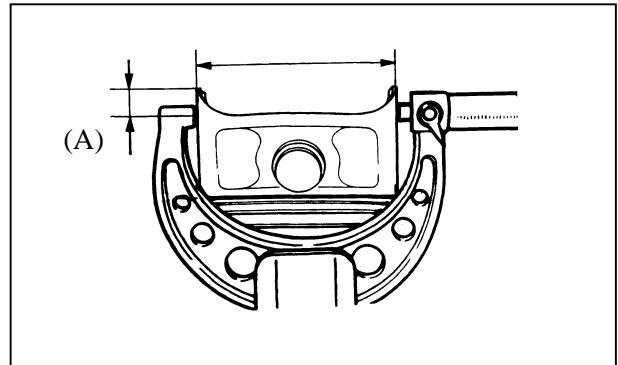

Measure the piston pin hole. Take the maximum reading to determine the I.D..

Service Limit:

17.04 mm (0.6816 in)

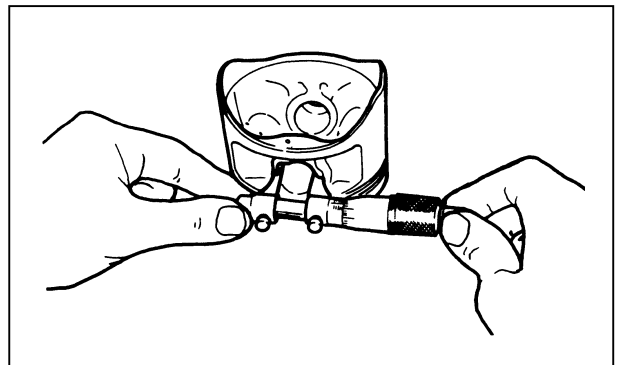

Measure the piston pin O.D. at piston and connecting rod sliding areas.

Service Limit:

16.96 mm (0.6784 in)

Measure the piston-to-piston pin clearance.

Service Limit: 0.002 mm (0.0001 in)

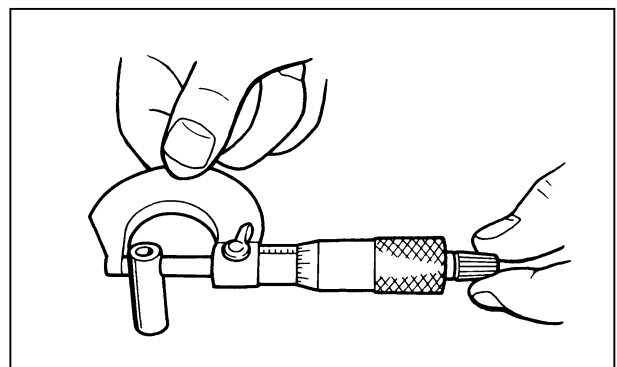

7. CYLINDER/PISTON

Cylinder

Check the cylinder for warpage with a straight edge and feeler gauge in the directions shown.

Service Limit: 0.05 mm (0.002 in)



Check the cylinder wall for wear or damage. Measure and record the cylinder I.D. at three levels in an X and Y axis. Take the maximum reading to determine the cylinder wear.

Service Limit:

72.8 mm (2.912 in)

Calculate the piston-to-cylinder clearance. Take a maximum reading to determine the clearance.

Service Limit: 0.1 mm (0.004 in)

Calculate the taper and out-of-round at three levels in an X and Y axis. Take the maximum reading to determine them.

Service Limit:

Taper: 0.1 mm (0.004 in)

Out-of-round: 0.1 mm (0.004 in)

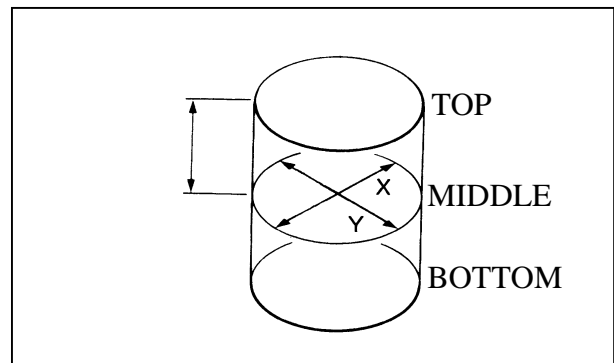

7. CYLINDER/PISTON

Measure the connecting rod small end I.D..

Service Limit:

17.06 mm (0.6824 in)

Calculate the connecting rod-to-piston pin clearance.

Service Limit: 0.06 mm (0.002 in)

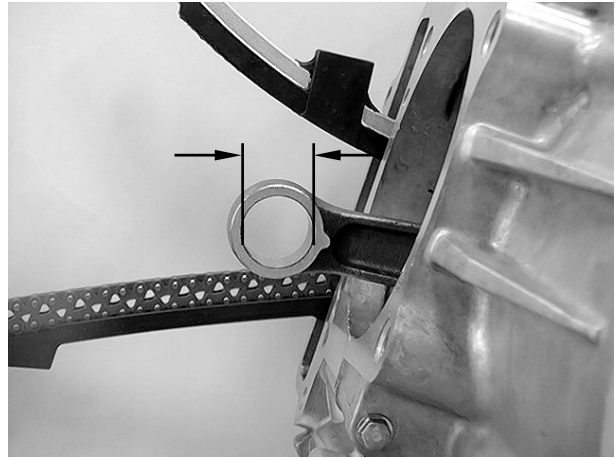

PISTON RING INSTALLATION

Carefully install the piston rings into the piston ring grooves with the markings facing up.

* Be careful not to damage the piston and rings.

- ♦ Do not confuse the top and second rings.
- ♦ To install the oil ring, install the oil ring, then install the side rails.

Stagger the piston ring end gaps 120° degrees apart from each other.

Stagger the side rail end gaps as shown.

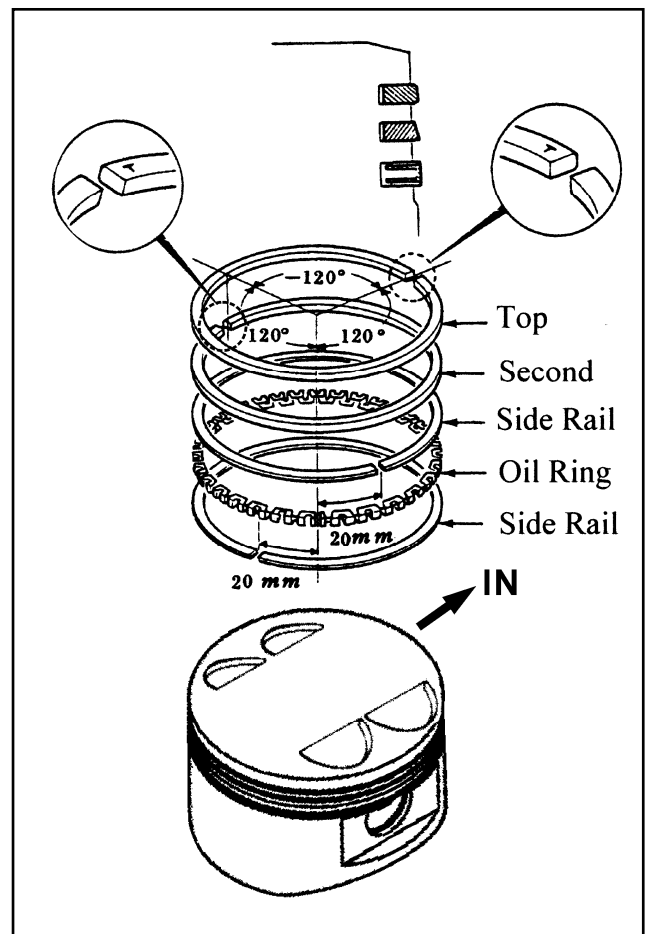

7. CYLINDER/PISTON

CYLINDER/PISTON INSTALLATION

Remove any gasket material from the crankcase surface.

- *
 - Be careful not to drop foreign matters into the crankcase.



Install the piston, piston pin and a new piston pin clip.

- *
 - Position the piston "IN" mark on the intake valve side.
 - Place a clean shop towel in the crankcase to keep the piston pin clip from falling into the crankcase.

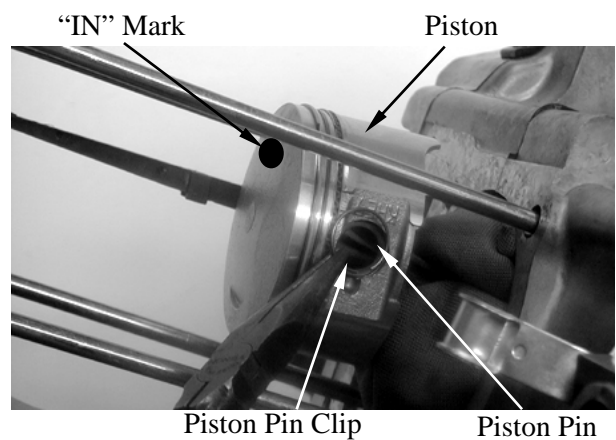

Install the dowel pins and a new cylinder gasket on the crankcase.

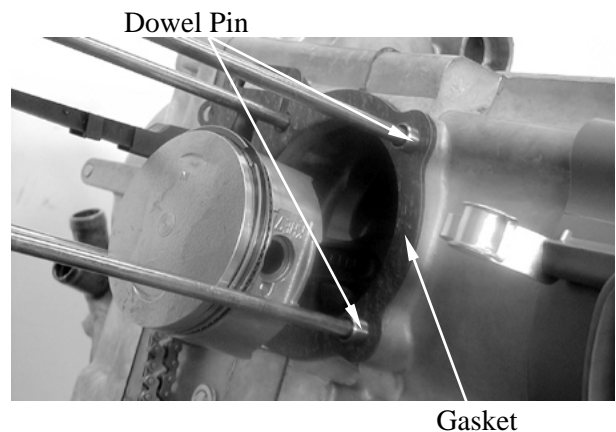

Coat the cylinder bore, piston and piston rings with clean engine oil. Carefully lower the cylinder over the piston by compressing the piston rings.

- *
 - Be careful not to damage or break the piston rings.
 - The piston ring end gaps should not be parallel with or at 90° to the piston pin.

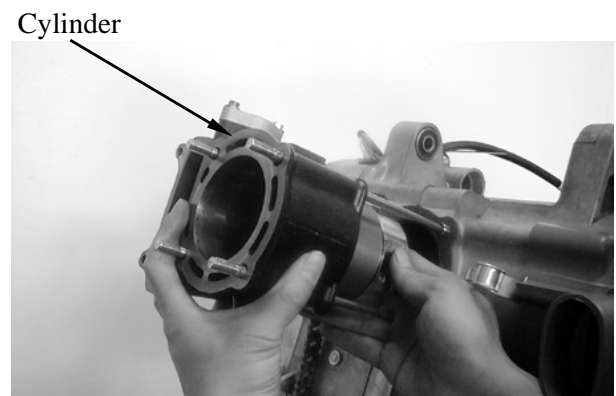

7. CYLINDER/PISTON

Install the cam chain guide.

- * **Insert the tab on the cam chain guide into the cylinder groove.**

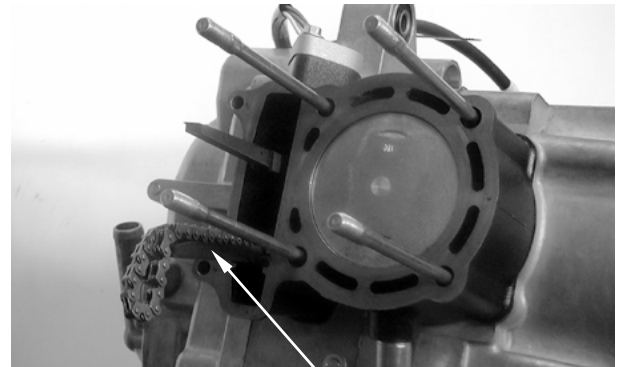

Cam Chain Guide

Install the cylinder gasket and dowel pins.
Connect the water hose to the cylinder.

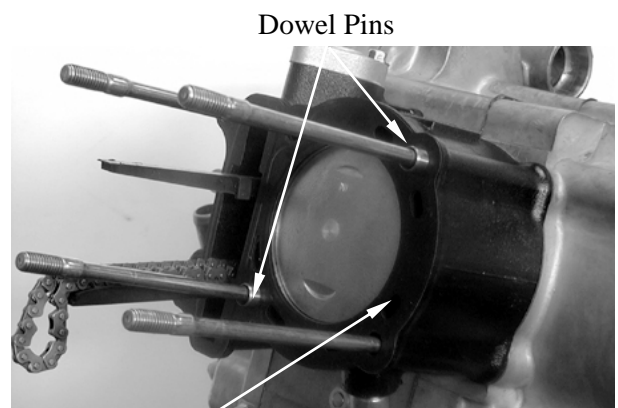

Gasket

DRIVE AND DRIVEN PULLEY

SERVICE INFORMATION-----	8- 1
TROUBLESHOOTING-----	8- 2
LEFT CRANKCASE COVER-----	8- 3
DRIVE PULLEY -----	8- 4
CLUTCH/DRIVEN PULLEY-----	8-10

SERVICE INFORMATION

GENERAL INSTRUCTIONS

- The drive pulley, clutch and driven pulley can be serviced with the engine installed.
- Avoid getting grease and oil on the drive belt and pulley faces. Remove any oil or grease from them to minimize the slipping of drive belt and drive pulley.
- Do not apply grease to the movable drive face and weight rollers.

SPECIFICATIONS

Unit: mm (in)

Item	Standard	Service Limit
Movable driven face bushing I.D.	40 (1.6)~40.025 (1.601)	40.06 (1.6024)
Driven face collar O.D.	39.965 (1.5986)~39.985 (1.5994)	39.94 (1.5976)
Drive belt width	23.6 (0.944)~24.4 (0.976)	
Clutch lining thickness	4 (0.16)	1 (0.04)
Clutch outer I.D.	153 (6.12)~153.2 (6.128)	153.5 (6.14)
Drive pulley collar O.D.	26.96 (1.0784)~26.974 (1.07896)	26.9 (1.076)
Weight roller O.D.	22.92 (0.9168)~23.08 (0.9232)	22 (0.88)

TORQUE VALUES

Drive face nut	93 N•m (9.3 kgf•m, 67 lbf•ft)	Apply oil to the threads
Clutch outer nut	54 N•m (5.4 kgf•m, 39 lbf•ft)	
Clutch drive plate nut	54 N•m (5.4 kgf•m, 39 lbf•ft)	

SPECIAL TOOLS

Universal holder	A120E00017
Clutch spring compressor	A120E00034
Oil seal & bearing install	A120E00014

TROUBLESHOOTING

Engine starts but motorcycle won't move

- Worn drive belt
- Broken ramp plate
- Worn or damaged clutch lining
- Broken driven face spring

Engine stalls or motorcycle creeps

- Broken clutch weight spring

Lack of power

- Worn drive belt
- Weak driven face spring
- Worn weight roller
- Faulty driven face

LEFT CRANKCASE COVER

REMOVAL

Remove the left crankcase cover bolts and left crankcase covers.

Bolts

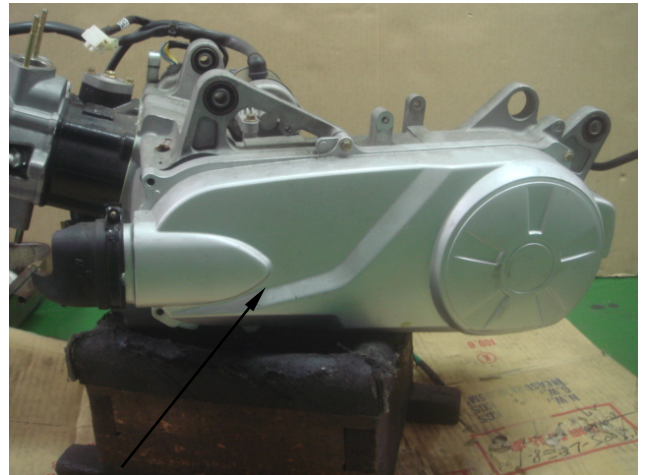

Left Crankcase Cover

Remove the seal gasket and dowel pins.

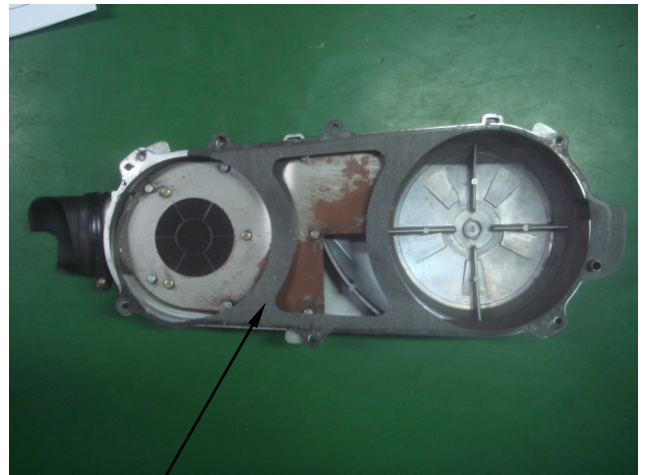

Gasket

DRIVE PULLEY REMOVAL

Remove the left crankcase cover

Hold the drive pulley face with the special tool and loosen the drive pulley face nut.

Special tool:

Universal holder A120E00017

Remove the nut, washer and drive pulley face.

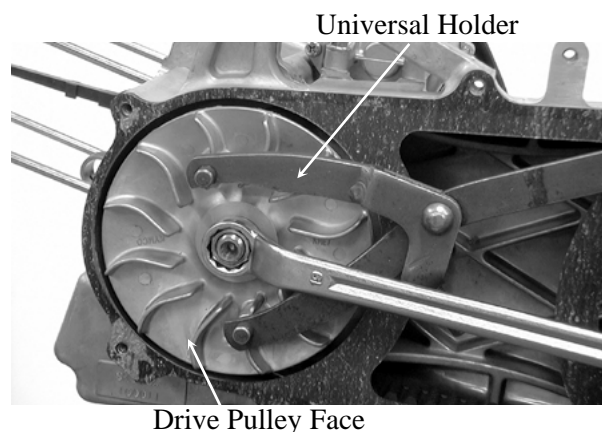

Hold the clutch outer with the special tool as shown.

Special tool:

Universal holder A120E00017

Remove the nut, and clutch outer.

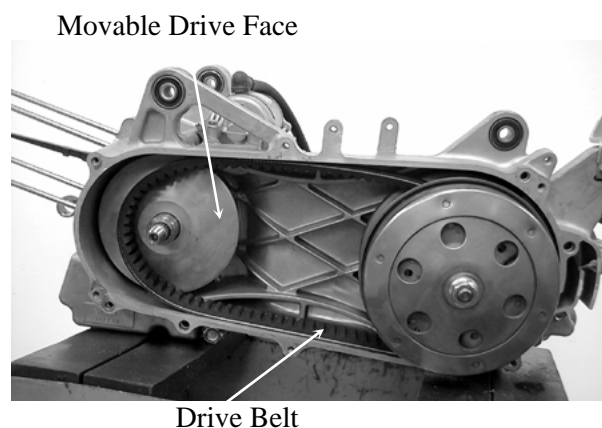

Remove the clutch/driven pulley assembly and drive belt.

11. DRIVE AND DRIVEN PULLEY

Remove the movable drive face assembly while holding the back of the face (ramp plate).

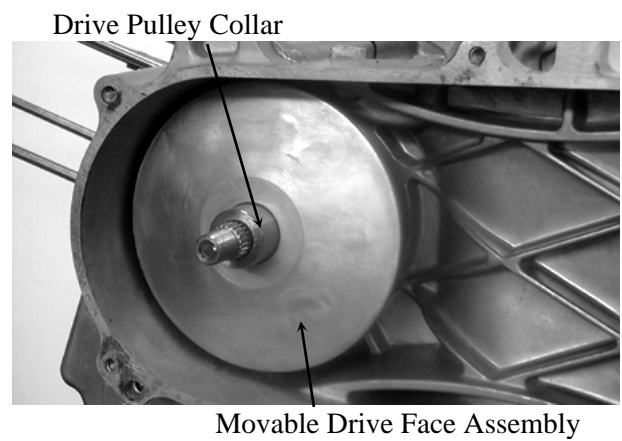

11. DRIVE AND DRIVEN PULLEY

DISASSEMBLY

Drive pulley

Remove the ramp plate and slide pieces.

Ramp Plate



Remove the weight rollers.

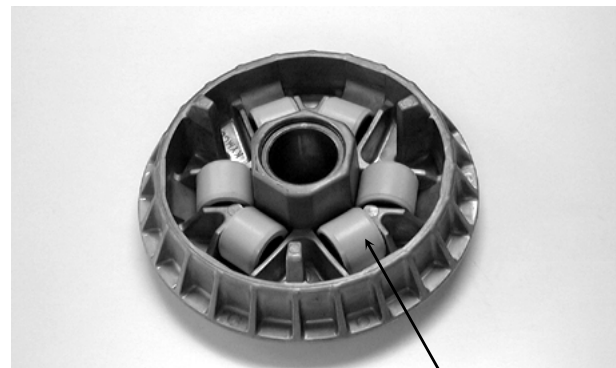

Weight Roller

INSPECTION

Movable Drive Face

Check the drive face boss for wear or damage.

Measure the boss O.D..

Service limit:

26.9 mm (1.076 in)

Measure the face bushing I.D..

Service limit:

27.13 mm (1.058 in)

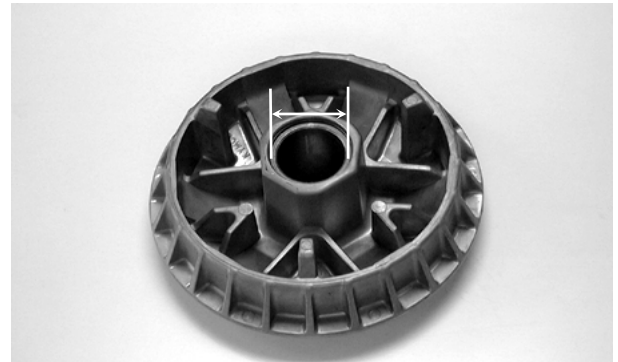

Weight Roller

Check each roller for wear or damage.

Measure the weight roller O.D..

Service limit:

22 mm (0.888 in)

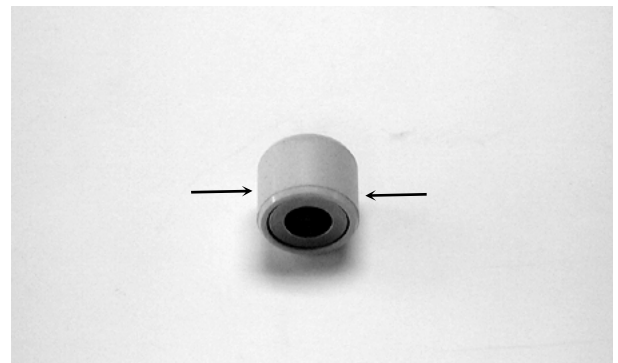

11. DRIVE AND DRIVEN PULLEY

ASSEMBLY

Clean any oil and grease from the pulley faces and weight rollers.

Install the drive face boss into the movable drive face.

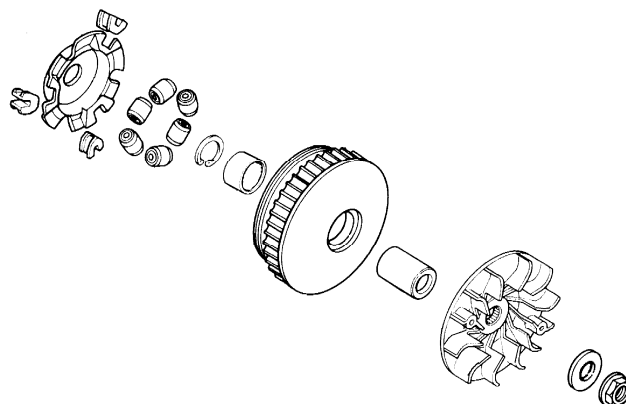

Install the weight rollers to the movable drive face.

* The direction of all weight rolls is the same. The thin side is towards to clockwise.



Weight Roller

Install the slide pieces to ramp plate.
Install the ramp plate to the movable drive face.



Ramp Plate

11. DRIVE AND DRIVEN PULLEY

Hold the clutch outer with the special tool as shown.

Special tool:
Universal holder A120E00017

Install the nut.

Tighten the nut to the specified torque.

Torque:

54 N•m (5.4 kgf•m, 36 lbf•ft)

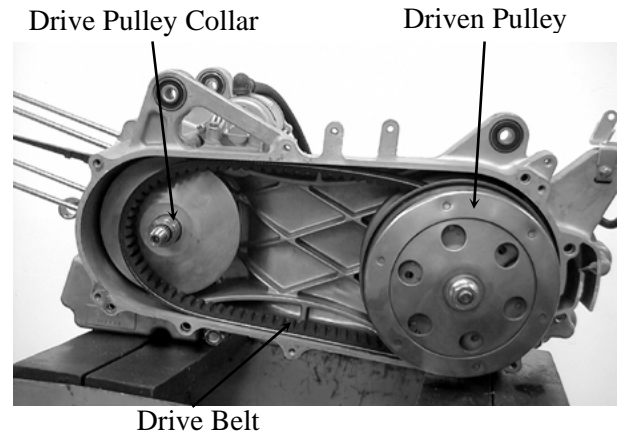

Install the drive pulley face and washer.
Apply oil to the drive pulley face nut threads and seating surface and install the nut.

Hold the drive face with the special tool and tighten the bolt to the specified torque.

Special tool:
Universal holder A120E00017

Torque:

93 N•m (9.3 kgf•m, 67 lbf•ft)

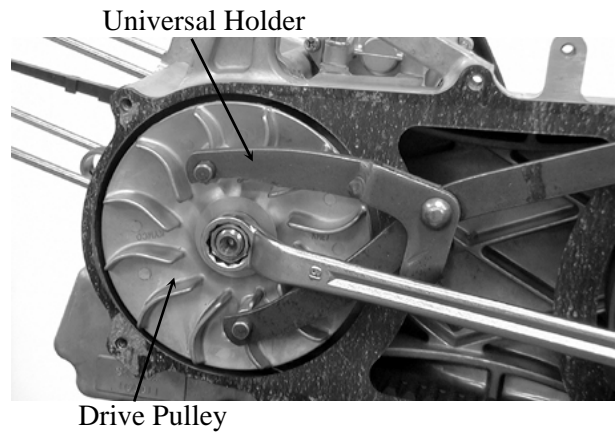

CLUTCH/DRIVEN PULLEY

REMOVAL

Remove the left crankcase cover.

Hold the drive pulley face with the special tool and loosen the drive pulley face nut.

Special tool:

Universal holder A120E00017

Remove the nut, washer and drive pulley face.

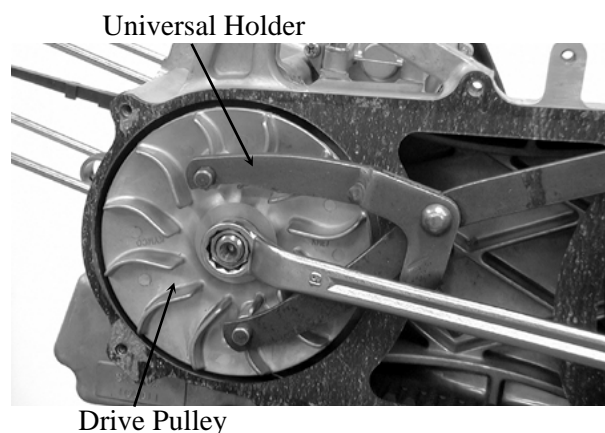

Hold the clutch outer with the special tool as shown.

Special tool:

Universal holder A120E00017

Remove the nut, and clutch outer.

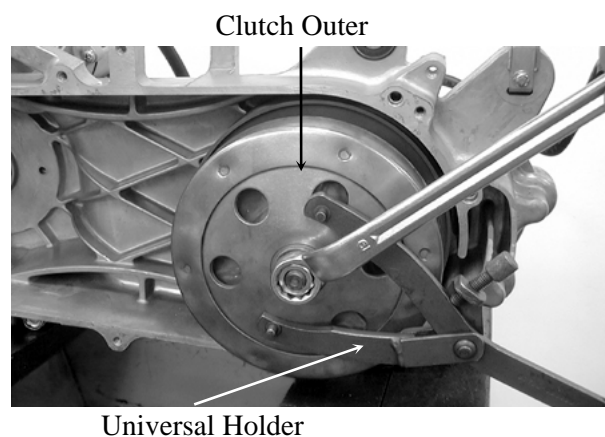

Remove the clutch/driven pulley assembly and drive belt.

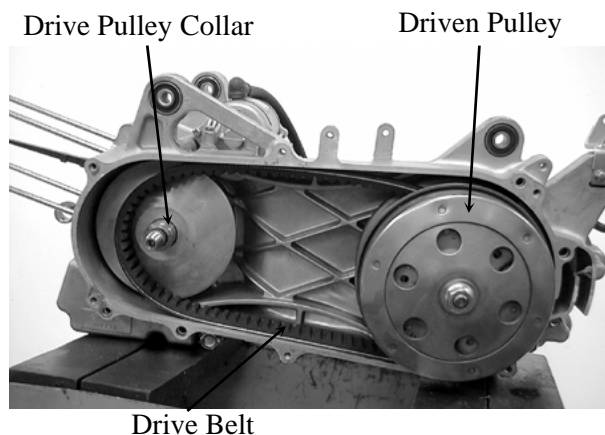

11. DRIVE AND DRIVEN PULLEY

DISASSEMBLY Clutch/Driven Pulley

Hold the clutch/driven pulley assembly with the clutch spring compressor.

* Be sure to use a clutch spring compressor to avoid spring damage.

Special tool:

Clutch Spring Compressor A120E00034

Set the tool in a vise and remove the clutch drive plate nut.

Remove the spring compressor and disassemble the following:

- Clutch assembly
- Driven face spring
- Driven pulley

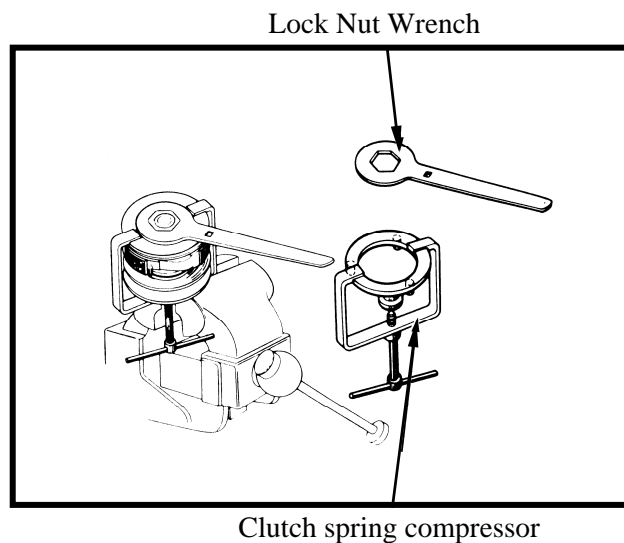

11. DRIVE AND DRIVEN PULLEY

Remove the guide roller pins, guide rollers and the movable driven face.

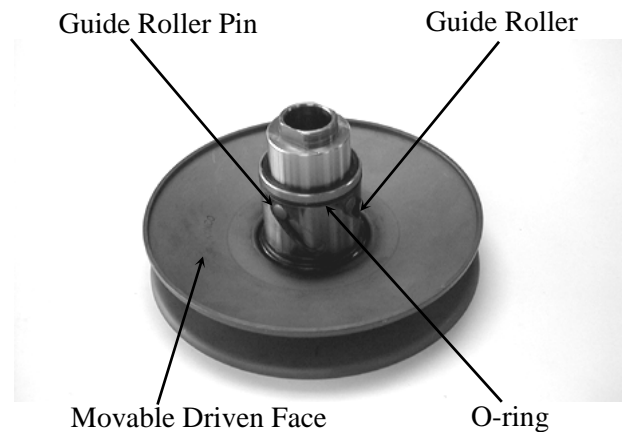

Remove the O-rings and oil seals from the movable driven face.

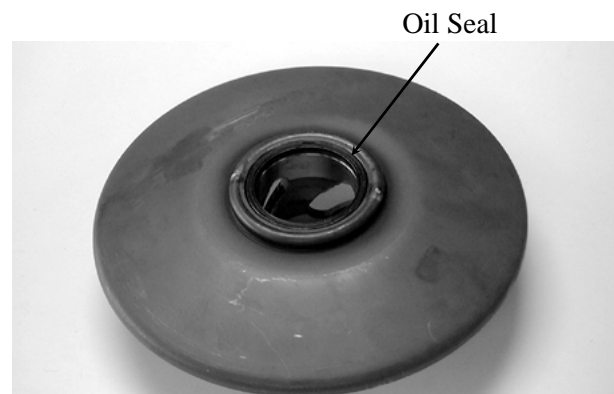

Driven Face Bearing Replacement

Remove the driven face needle bearing.

Remove the snap ring, then remove the ball bearing.

Apply grease to new ball bearing.

Install the ball bearing into the driven face. Install the snap ring to groove in the driven face securely.

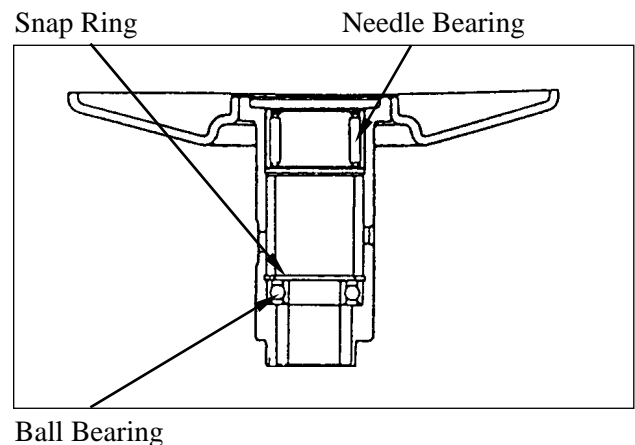

11. DRIVE AND DRIVEN PULLEY

Filling 25 g of grease to the driven face inner surface.

Apply grease to new needle bearing.
Press the needle bearing into the driven.

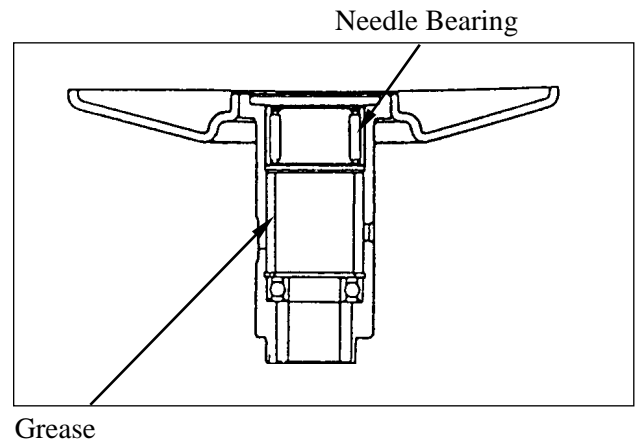

INSPECTION

Clutch Outer

Check the clutch outer for wear or damage.
Measure the clutch outer I.D..

Service limit:

153.5 mm (6.14 in)



Clutch Shoe Lining

Check the clutch shoe for wear or damage.
Measure the thickness of each shoe.

Service limit: 1 mm (0.04 in)



Driven Face Spring

Measure the driven face spring free length.

Service limit:

130.5 mm (5.22 in)

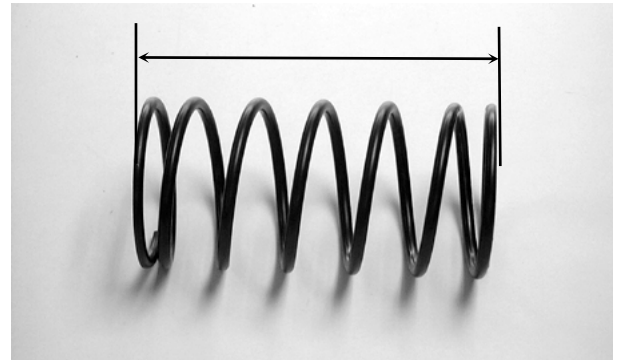

Driven Face

Check the driven face for scratches, scoring or damage.

Measure the driven face boss O.D..

Service limit:

XCITING 250/250 AFI:

39.94 mm (1.5976 in)

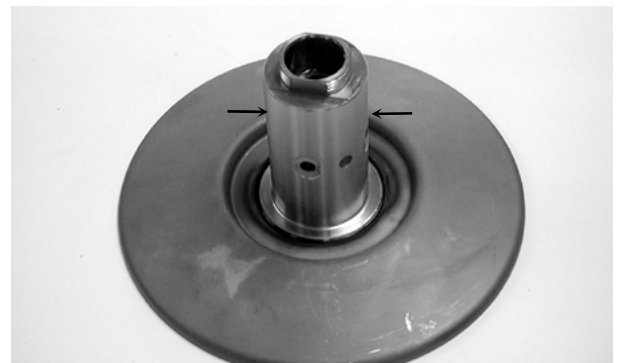

Movable Driven Face

Check the movable driven face for scratches, scoring or damage.

Check the guide grooves for stepped wear or damage.

Measure the movable driven face I.D..

Service limit:

40.06 mm (1.6024 in)

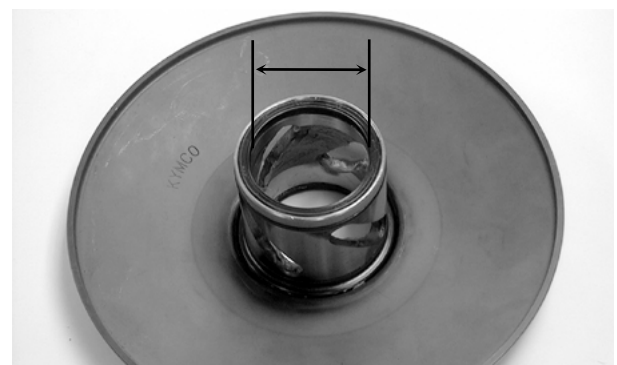

9. FINAL REDUCTION

FINAL REDUCTION

SCHEMATIC DRAWING -----	9-1
SERVICE INFORMATION-----	9-2
TROUBLESHOOTING-----	9-2
FINAL REDUCTION DISASSEMBLY -----	9-3
FINAL REDUCTION INSPECTION-----	9-3
FINAL REDUCTION ASSEMBLY -----	9-6



9. FINAL REDUCTION

SCHEMATIC DRAWING

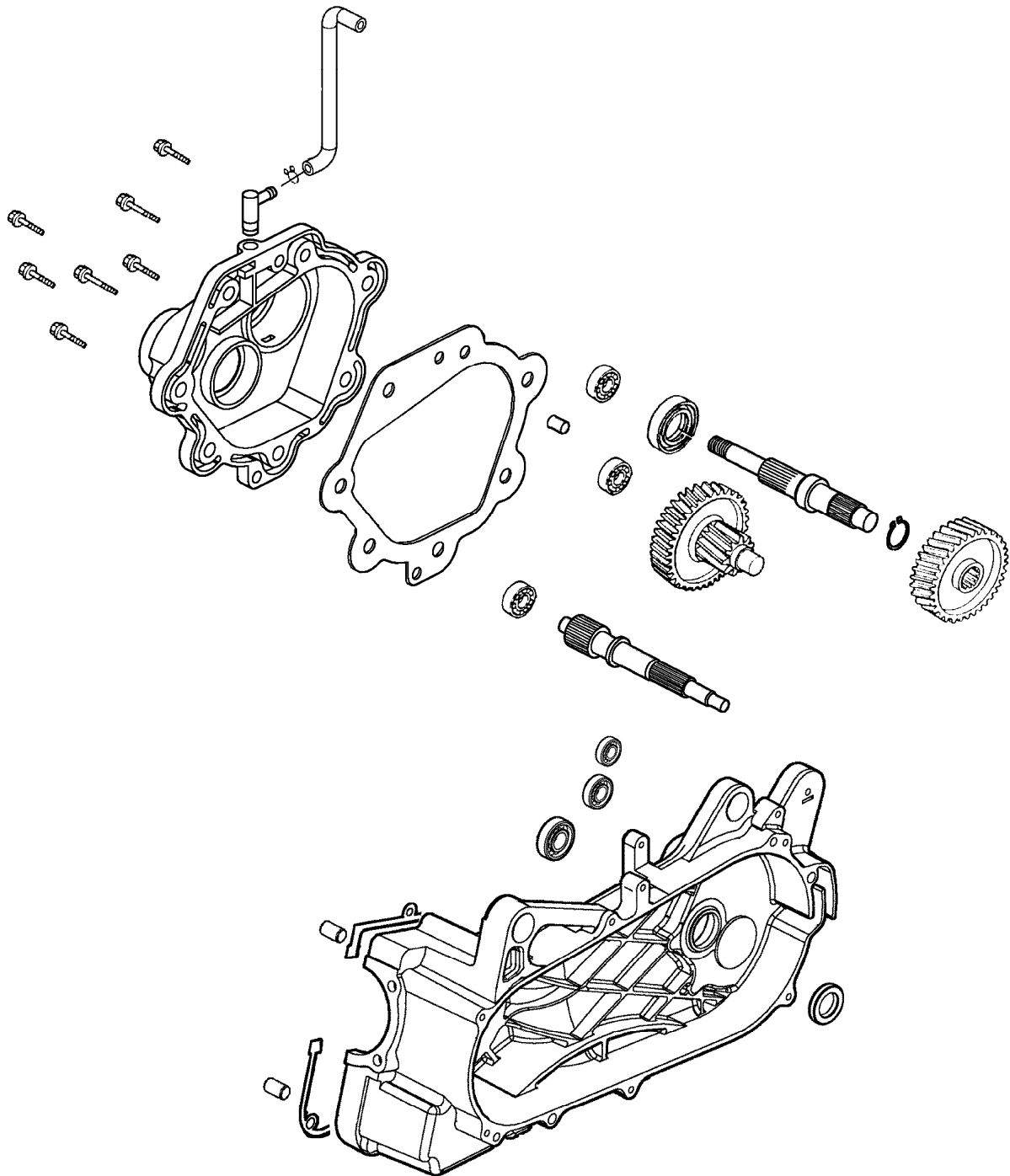

9. FINAL REDUCTION

SERVICE INFORMATION

GENERAL INSTRUCTIONS

- The servicing operations of this section can be made with the engine installed.
- When replacing the drive shaft, use a special tool to hold the bearing inner race for this operation.

SPECIFICATIONS

Specified Oil: SAE 90#

Oil Capacity:

At disassembly : 0.2 liter

At change : 0.18 liter

TORQUE VALUES

Transmission case cover bolt 17.7~21.6N-m

Oil check bolt 7.8~11.8N-m

SPECIAL TOOLS

Bearing remover, 12mm

Bearing remover, 15mm

Pilot, 12mm

Pilot, 15mm

TROUBLESHOOTING

Engine starts but motorcycle won't move

- Damaged transmission
- Seized or burnt transmission

Abnormal noise

- Worn, seized or chipped gears
- Worn bearing

Oil leaks

- Oil level too high
- Worn or damaged oil seal

9. FINAL REDUCTION

FINAL REDUCTION DISASSEMBLY

Remove the exhaust muffler.
Remove the rear brake caliper.
Remove the right rear shock absorber.

Remove the rear fork.
Remove the rear wheel.
Remove the left crankcase cover.
Remove the clutch/driven pulleys.
Drain the transmission gear oil into a clean container.
Remove the transmission case cover attaching bolts.

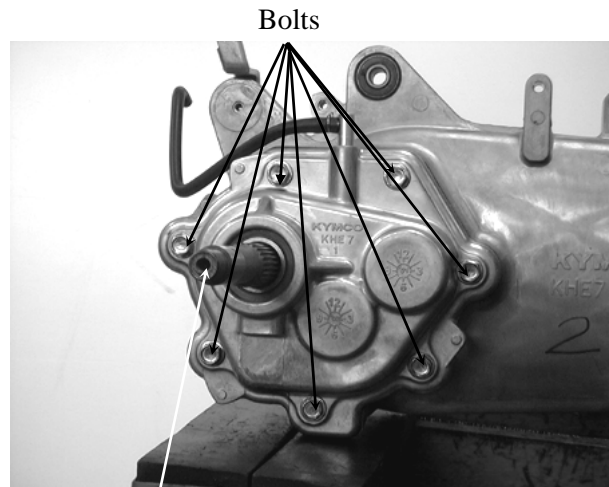

Final Shaft

Remove the transmission case cover.
Remove the gasket and dowel pins.
Remove the final gear and countershaft.

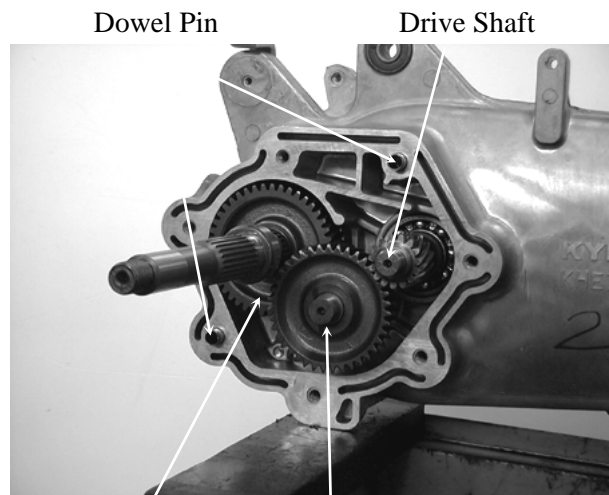

Final Gear Countershaft

FINAL REDUCTION INSPECTION

Inspect the countershaft and gear for wear or damage.



Countershaft

9. FINAL REDUCTION

Inspect the final gear and final shaft for wear, damage or seizure.



Check the left crankcase bearings for excessive play and inspect the oil seal for wear or damage.

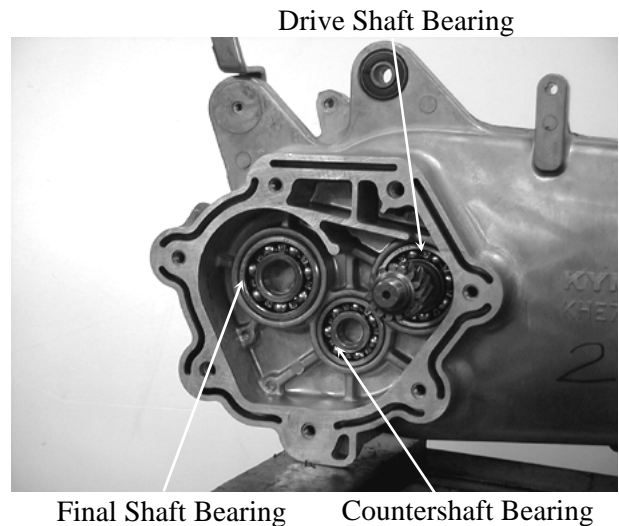

Inspect the drive shaft and gear for wear or damage.
Check the transmission case covers bearings for excessive play and inspect the final shaft bearing oil seal for wear or damage.

* Do not remove the transmission case cover except for necessary part replacement. When replacing the drive shaft, also replace the bearing and



9. FINAL REDUCTION

BEARING REPLACEMENT (TRANSMISSION CASE COVER)

Remove the transmission case cover bearings using the bearing remover.
Remove the final shaft oil seal.

Bearing Remover, 15mm

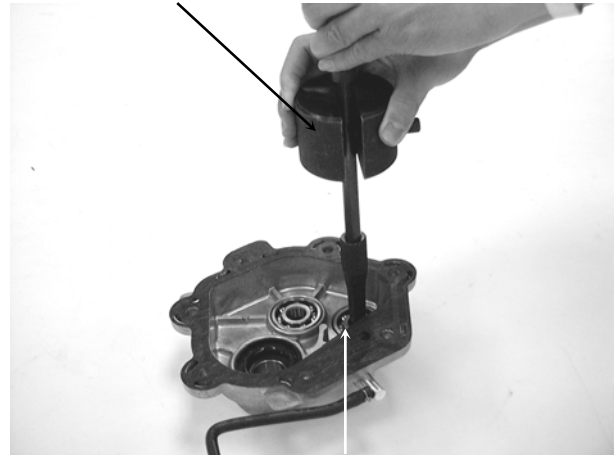

Drive Shaft Bearing

Drive new bearings into the transmission case cover.

Pilot, 15mm

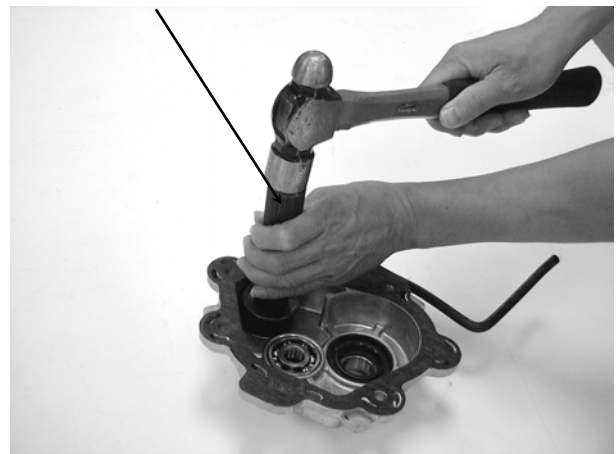

BEARING REPLACEMENT (LEFT CRANKCASE COVER)

Remove the drive shaft.
Remove the drive shaft oil seal.
Remove the left crankcase bearings using the bearing remover.

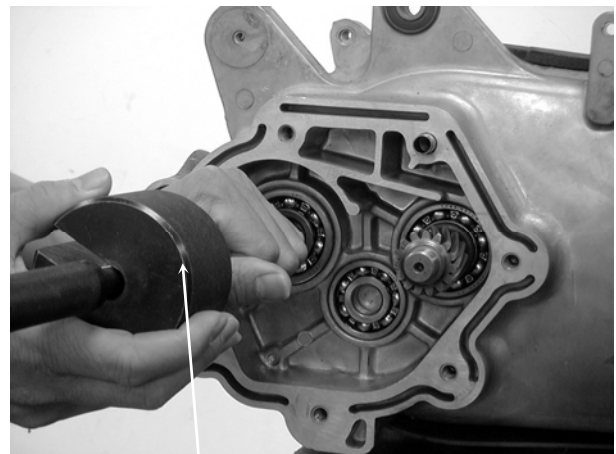

Bearing Remover

9. FINAL REDUCTION

Drive new bearings into the left crankcase.
Install a new drive shaft oil seal.

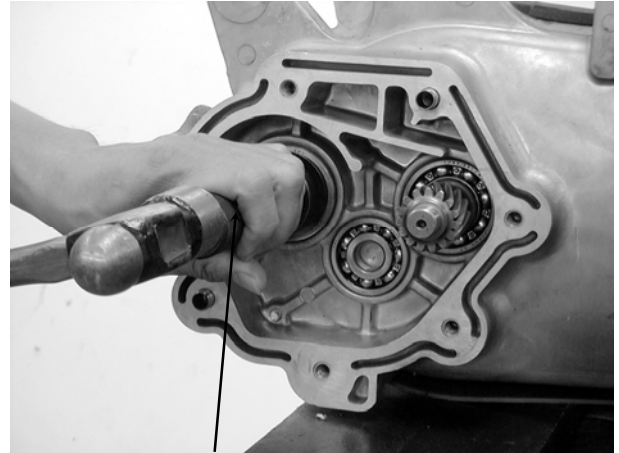

Pilot

FINAL REDUCTION ASSEMBLY

Install the drive shaft into the left crankcase.

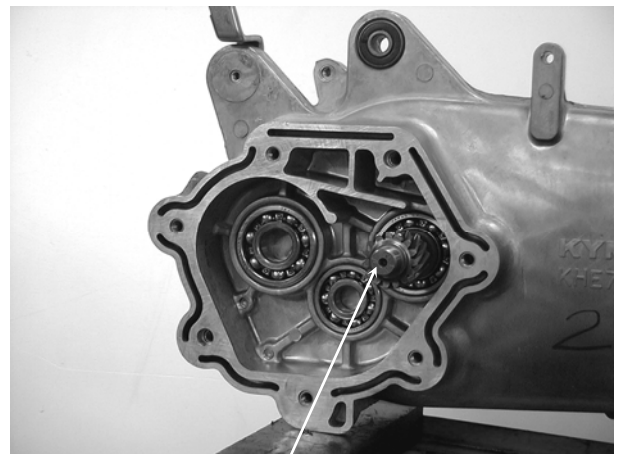

Drive Shaft

Install the final gear and final shaft into the left crankcase.

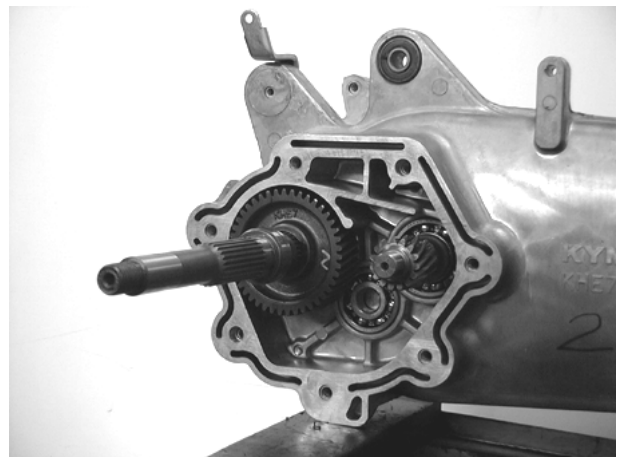

9. FINAL REDUCTION

Install the countershaft and gear into the left crankcase.
Install the resin washer onto the counter-shaft.
Install the dowel pins and a new gasket.

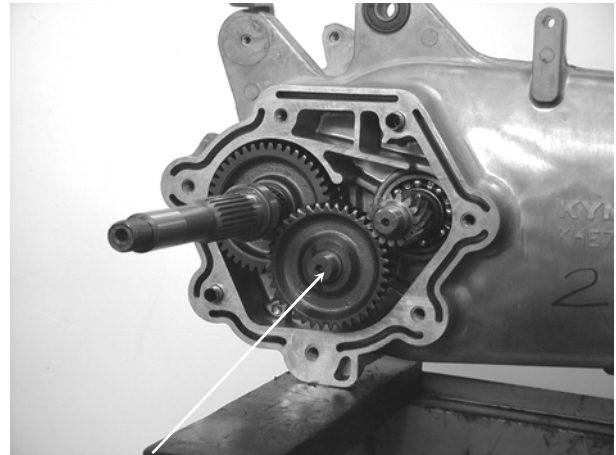

Countershaft

Install the transmission case cover.

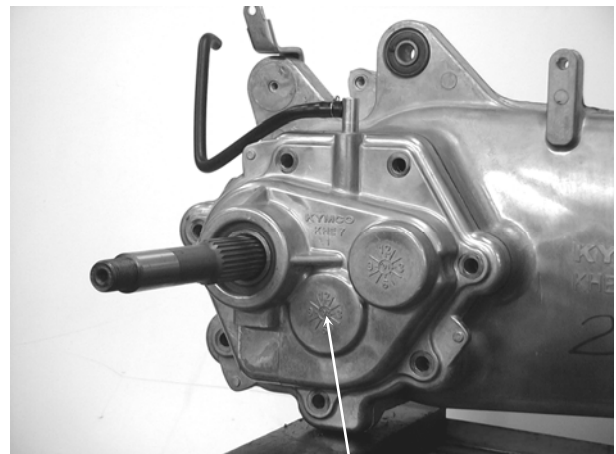

Transmission Case Cover

Install and tighten the transmission case cover bolts.
Install the clutch/driven pulley.
Install other removed parts in the reverse order of removal.

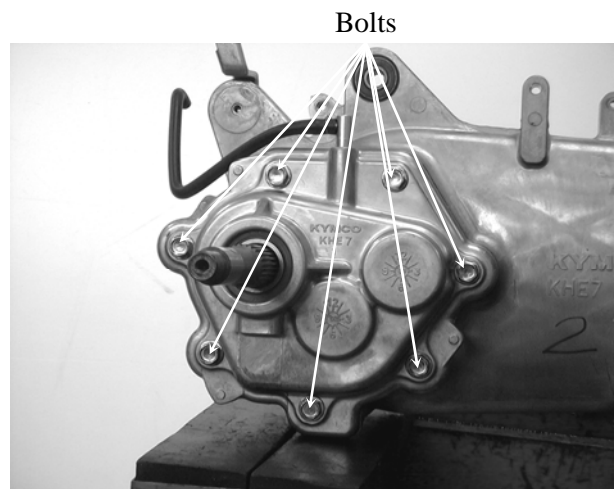

Bolts

9. FINAL REDUCTION

After installation, fill the transmission case with the specified oil.

*

- Place the motorcycle on its main stand on level ground.
- Check the oil-sealing washer for wear or damage.

Specified Gear Oil: SAE90#

Oil Capacity:

At disassembly : 0.2 liter

At change : 0.18 liter

Install and tighten the oil check bolt.

Torque: 7.8~11.8N-m

Start the engine and check for oil leaks.

Check the oil level from the oil check bolt hole and add the specified oil to the proper level if the oil level is low.

Oil Check Bolt Hole/Oil Filler

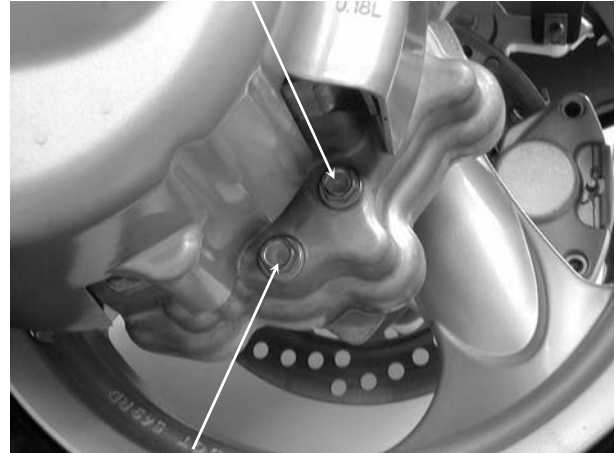

Drain Bolt

10. A.C. GENERATOR/STARTER CLUTCH

A.C. GENERATOR/STARTER CLUTCH

SCHEMATIC DRAWING -----	10-1
SERVICE INFORMATION-----	10-2
TROUBLESHOOTING-----	10-2
RIGHT CRANKCASE COVER REMOVAL -----	10-3
STATOR REMOVAL-----	10-3
FLYWHEEL REMOVAL -----	10-3
STARTER CLUTCH-----	10-4
FLYWHEEL INSTALLATION -----	10-5
STATOR INSTALLATION-----	10-6
RIGHT CRANKCASE COVER INSTALLATION -----	10-6

10

10. A.C. GENERATOR/STARTER CLUTCH

SCHEMATIC DRAWING

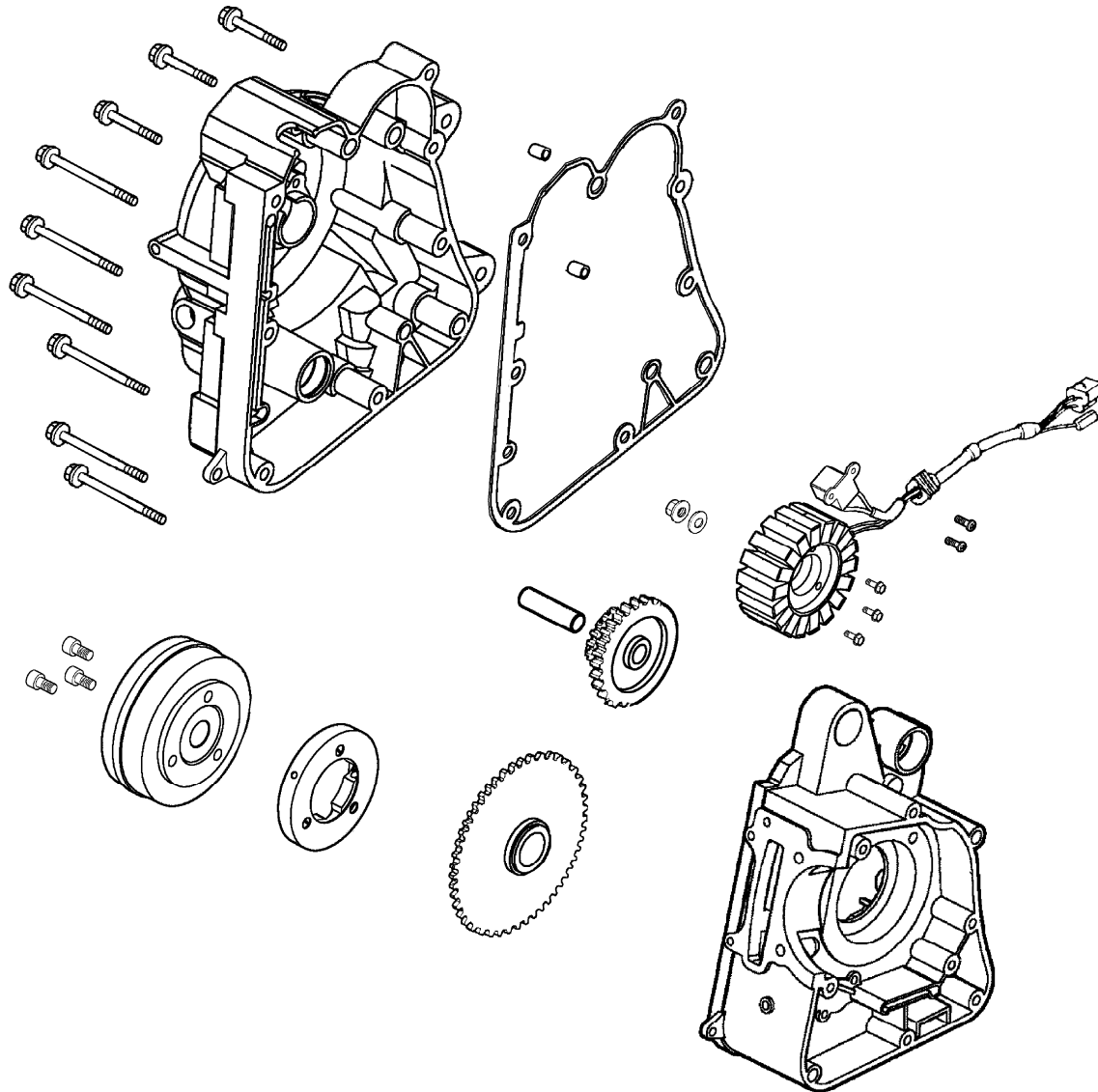

10. A.C. GENERATOR/STARTER CLUTCH

SERVICE INFORMATION

GENERAL INSTRUCTIONS

- All servicing operations and inspections in this section can be made with the engine installed.
- Drain the coolant before removing the right crankcase cover.
- Be careful not to drain the coolant when the engine temperature is high. (Perform this operation when the engine is cold.)
- Drain the coolant into a clean container.
- Drain the engine oil into a clean container before removing the right crankcase cover.
- When the right crankcase cover is installed, fill with the recommended engine oil and coolant. Then, bleed air from the water jacket.

SPECIAL TOOLS

Flywheel puller
Flywheel holder

SPECIFICATIONS

Item	Standard (mm)	Service Limit (mm)
Starter driven gear I.D.	22.026~22.045	22.15mm
Starter driven gear O.D.	42.195~42.208	41.5mm

TORQUE VALUES

Flywheel nut : 53.9~63.7N-m

TROUBLESHOOTING

Starter motor rotates but engine does not start

- Faulty starter clutch
- Starter motor rotates reversely
- Weak battery

10. A.C. GENERATOR/STARTER CLUTCH

RIGHT CRANKCASE COVER REMOVAL

Disconnect the water hoses from the right crankcase cover.
Remove the nine bolts attaching the right crankcase cover and the cover.

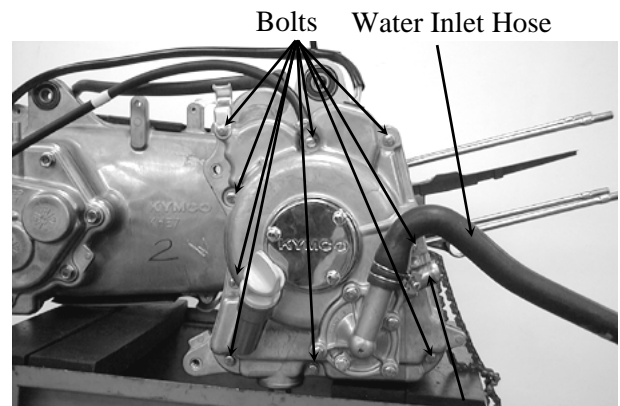

Bolts Water Inlet Hose

Water Outlet Hose

STATOR REMOVAL

Remove the two pulser coil attaching screws and the pulser coil.
Remove the three A.C. generator stator bolts and the stator.

* When removing the pulser coil and stator, be careful not to damage them to avoid shorted or broken wire.

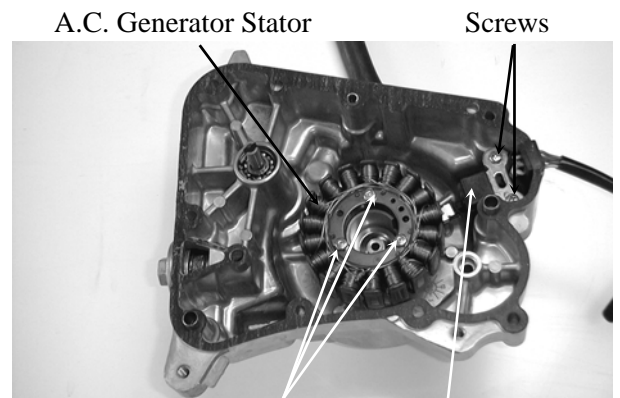

A.C. Generator Stator

Screws

Bolts

Pulser Coil

FLYWHEEL REMOVAL

Hold the flywheel with a flywheel holder and remove the flywheel nut.

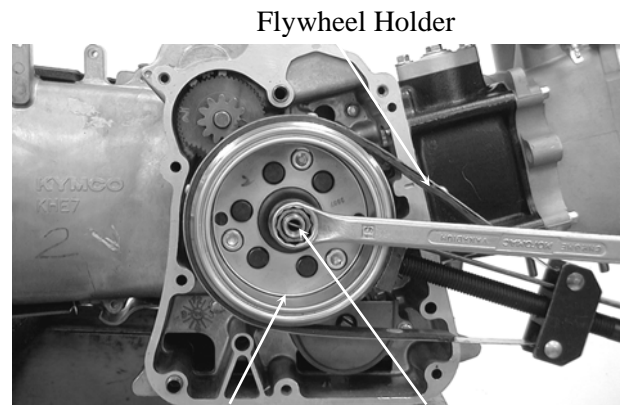

Flywheel Holder

Flywheel

Nut

Remove the flywheel with a flywheel puller.

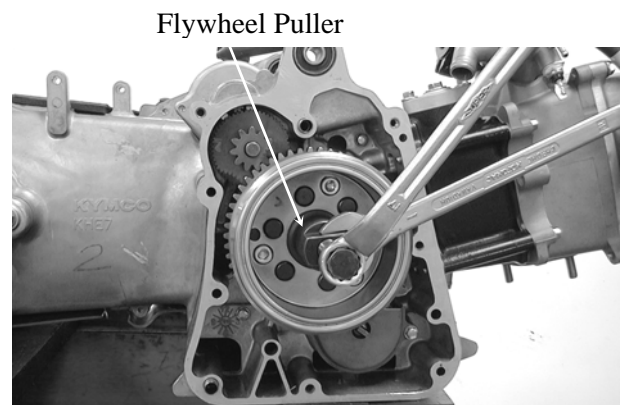

Flywheel Puller

10. A.C. GENERATOR/STARTER CLUTCH

STARTER CLUTCH

REMOVAL

Remove the starter driven gear.

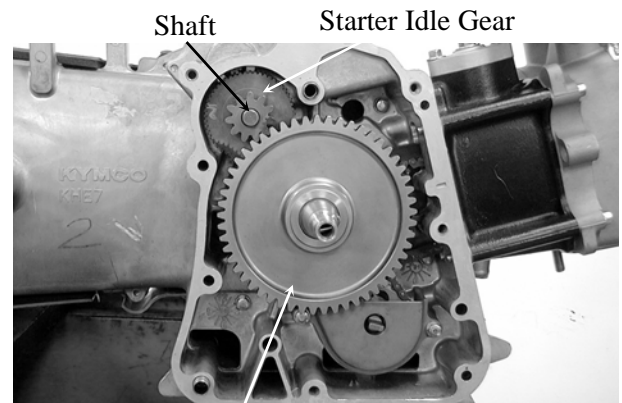

Starter Driven Gear

Remove the starter idle gear and shaft.

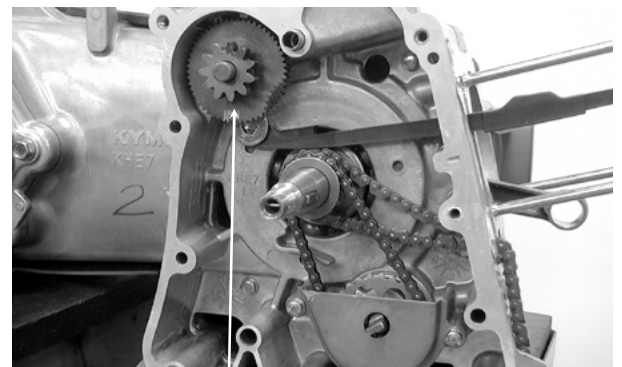

Starter Idle Gear

INSPECTION

Inspect the starter driven gear for wear or damage.

Measure the starter driven gear I.D. and O.D.

Service Limits:

I.D. : 22.15mm replace if over

O.D. : 41.50mm replace if below

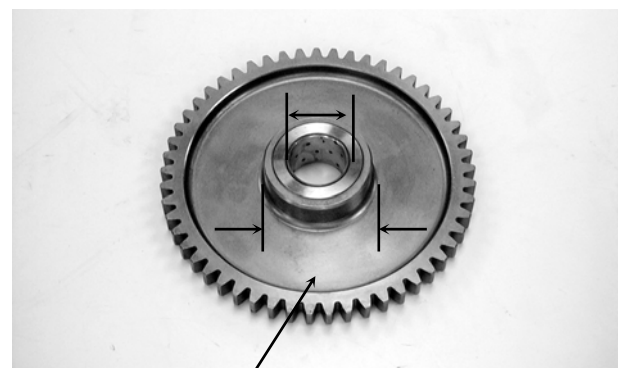

Starter Driven Gear

Inspect the starter idle gear and shaft for wear or damage.

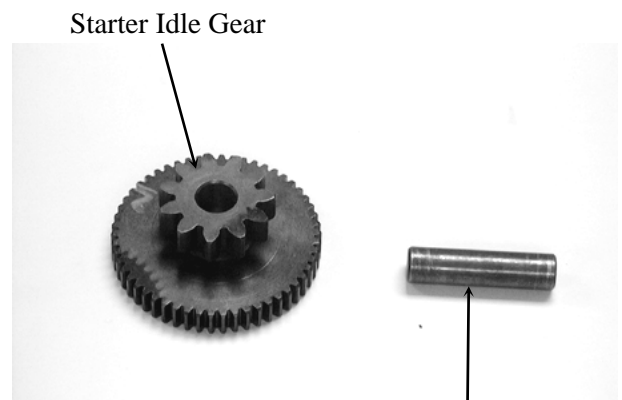

Shaft

10. A.C. GENERATOR/STARTER CLUTCH

Remove the starter one-way clutch rollers, plungers and springs.



INSTALLATION

Install the starter driven gear onto the crankshaft.

Install the starter idle gear and shaft.

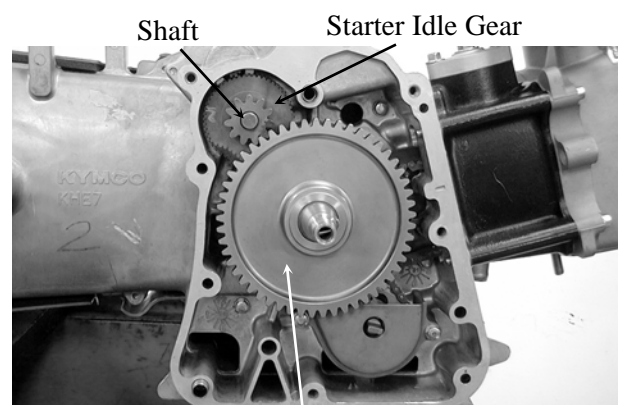

Starter Driven Gear

FLYWHEEL INSTALLATION

Install the flywheel onto the crankshaft by aligning the key on the crankshaft with the groove in the flywheel.

- *
 - Before installation, check and make sure that the inside of the flywheel is not contaminated.

Hold the flywheel with the flywheel holder and tighten the flywheel nut.

Torque: 53.9~63.7N-m

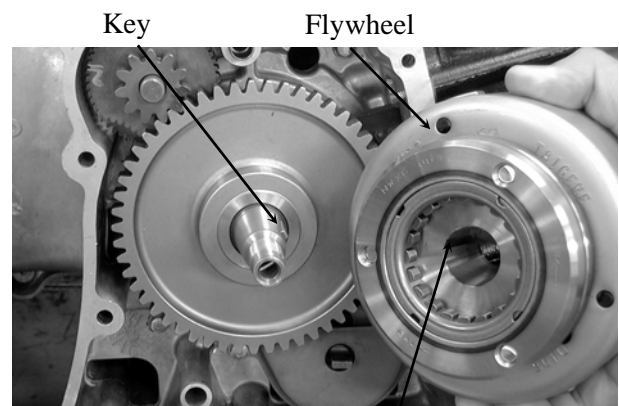

Groove

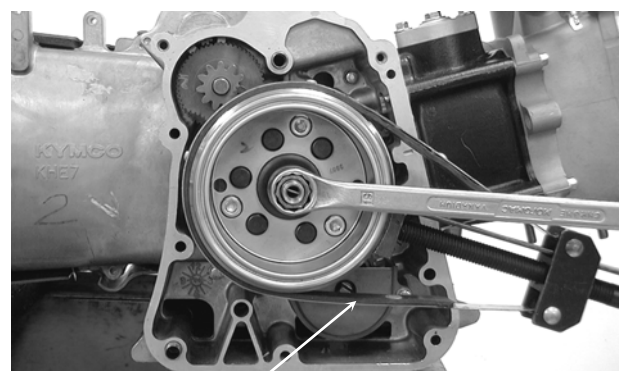

Flywheel Holder

10. A.C. GENERATOR/STARTER CLUTCH

STATOR INSTALLATION

Install the A.C. generator stator on the right crankcase cover and secure it with the three bolts.

Install the pulser coil on the right crankcase cover and secure it with the two screws.

Install the wire grommet in the groove in the right crankcase cover securely.

- * Be sure to route the stator wire under the pulser coil.

A.C. Generator Stator

Screws

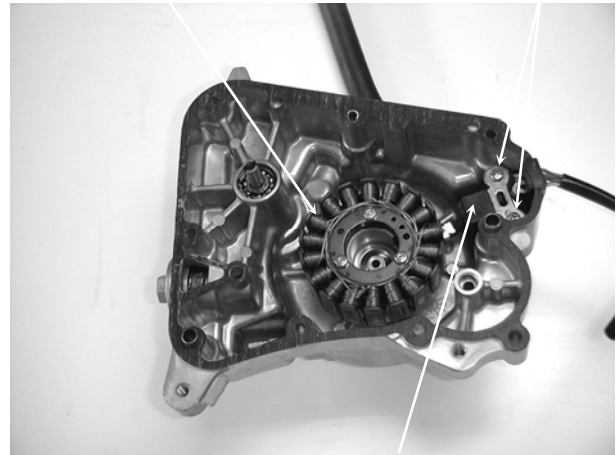

Pulser Coil

RIGHT CRANKCASE COVER INSTALLATION

Install the two dowel pins and a new gasket.

Dowel Pins

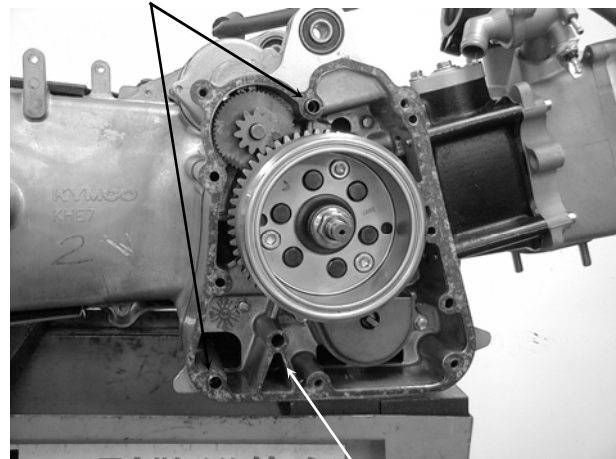

Gasket

Install the right crankcase cover over the crankcase, aligning the water pump shaft groove with the oil pump shaft.

Tighten the nine right crankcase cover bolts.

Connect the water hoses to the right crankcase cover.

Add the recommended engine oil.

Fill the cooling system with the specified coolant.

- * Be sure to bleed air from the water jacket after filling the coolant.

Right Crankcase Cover

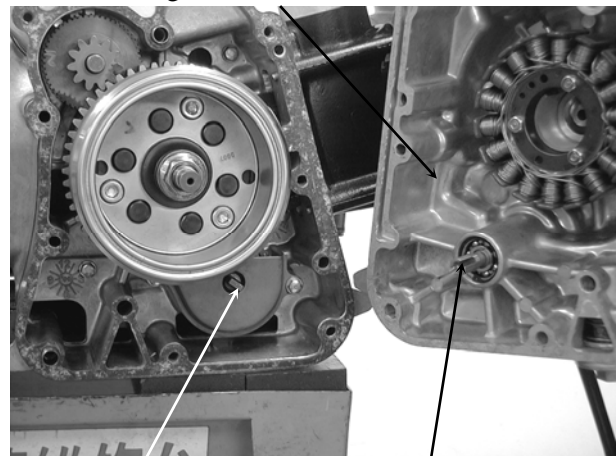

Oil Pump Shaft

Water Pump Shaft

11. CRANKCASE/CRANKSHAFT



CRANKCASE/CRANKSHAFT

SCHEMATIC DRAWING -----	11-1
SERVICE INFORMATION-----	11-2
TROUBLESHOOTING-----	11-2
CRANKCASE SEPARATION -----	11-3
CRANKSHAFT INSPECTION-----	11-4
CRANKCASE ASSEMBLY -----	11-5

11. CRANKCASE/CRANKSHAFT

SCHEMATIC DRAWING

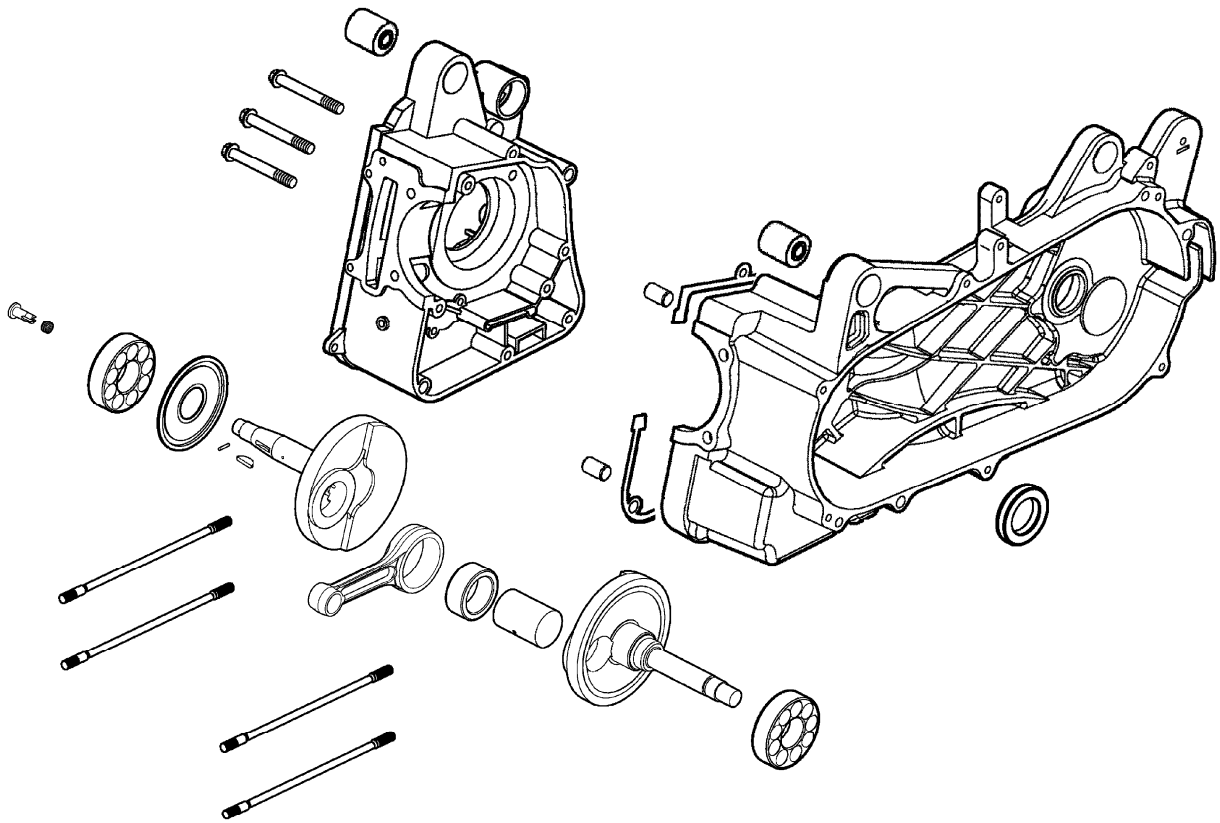

11. CRANKCASE/CRANKSHAFT

SERVICE INFORMATION

GENERAL INSTRUCTIONS

- This section covers crankcase separation to service the crankshaft. The engine must be removed for this operation.
- When separating the crankcase, never use a driver to pry the crankcase mating surfaces apart forcibly to prevent damaging the mating surfaces.
- When installing the crankcase, do not use an iron hammer to tap it.
- The following parts must be removed before separating the crankcase.

Cylinder head

Cylinder/piston

Right crankcase cover/drive and driven pulley

A.C. generator/starter clutch

Rear wheel/rear shock absorber

Starter motor

Oil pump

SPECIFICATIONS

	Item	Standard (mm)	Service Limit (mm)
Crankshaft	Connecting rod big end side clearance	0.15~0.35	0.6
	Connecting rod big end radial clearance	0.~0.008	0.05
	Runout	—	0.10

TORQUE VALUES

Crankcase bolt	7.8~10.8N-m
Cam chain tensioner slipper bolt	7.8~11.8N-m

SPECIAL TOOL

Gear remover

TROUBLESHOOTING

Excessive engine noise

- Excessive bearing play
- Excessive crankpin bearing play
- Worn piston pin and piston pin hole

11. CRANKCASE/CRANKSHAFT

CRANKCASE SEPARATION

Remove the cam chain tensioner slipper bolt.
Remove the cam chain tensioner slipper and cam chain.
Remove the three right crankcase attaching bolts.

Cam Chain Tensioner Slipper

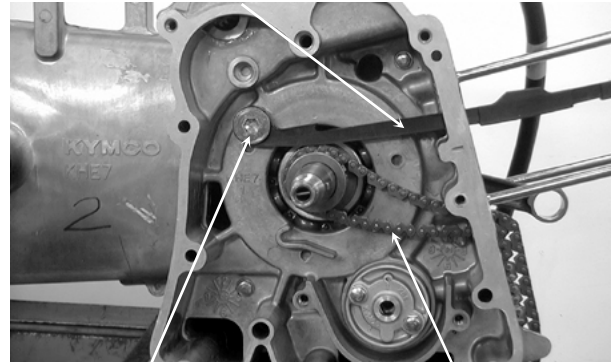

Bolt

Cam Chain

Remove the left crankcase.

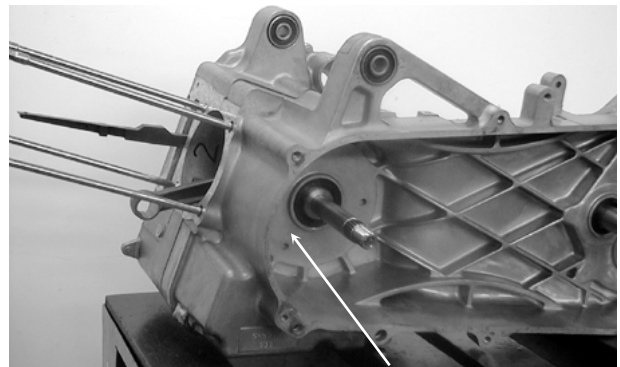

Left Crankcase

Place the crankcase with the left crankcase down and remove the right crankcase from the left crankcase.

- * • Never use a driver to pry the crankcase mating surfaces apart.

Remove the gasket and dowel pins.

Right Crankcase

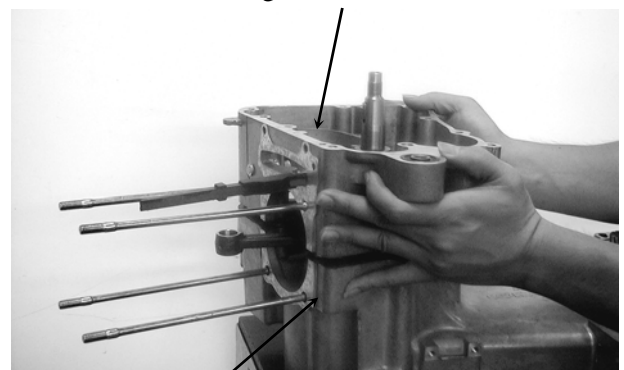

Left Crankcase

Remove the crankshaft from the left crankcase.

Crankshaft

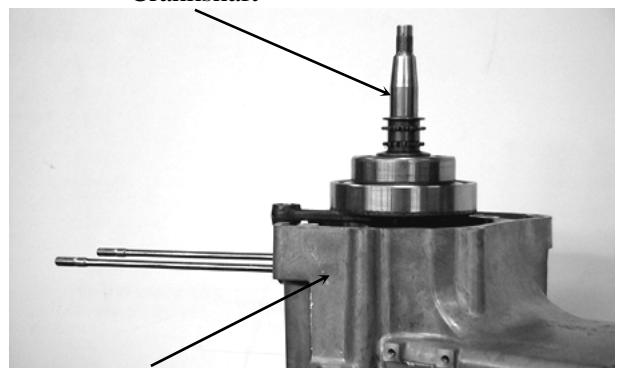

Left Crankcase

11. CRANKCASE/CRANKSHAFT

Remove the oil seal from the left crankcase.

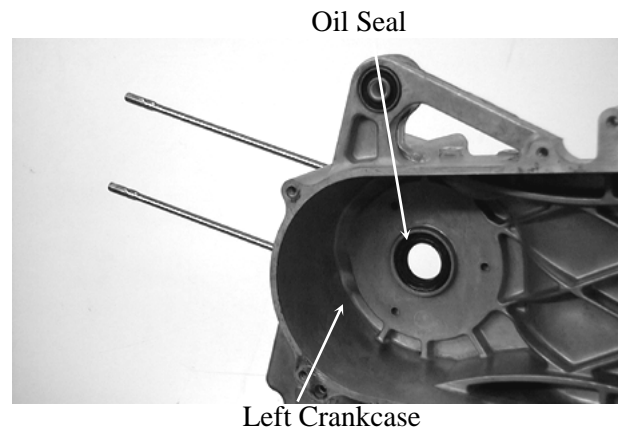

CRANKSHAFT INSPECTION

Measure the connecting rod big end side clearance.

Service Limit: 0.6mm replace if over

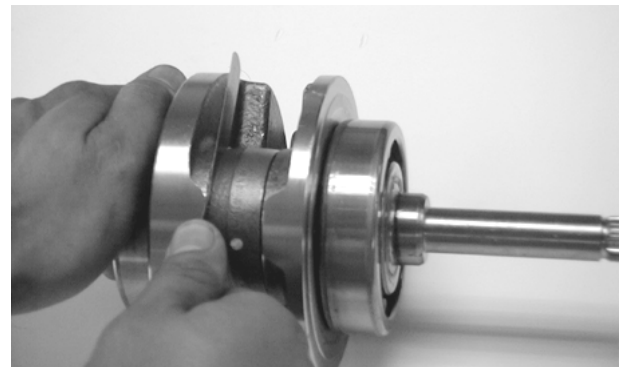

Measure the connecting rod small end I.D.

Service Limit: 17.06mm replace if over

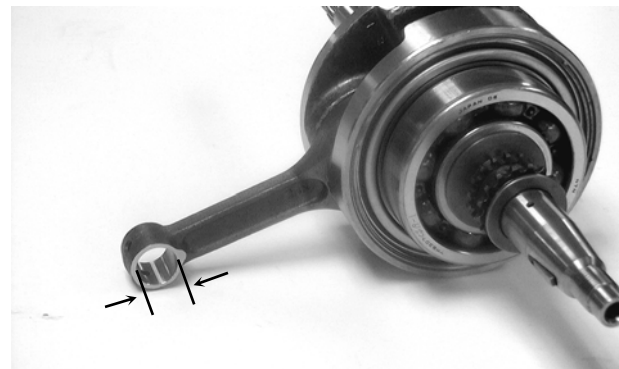

11. CRANKCASE/CRANKSHAFT

Measure the crankshaft runout.

Service Limit: 0.10mm replace if over

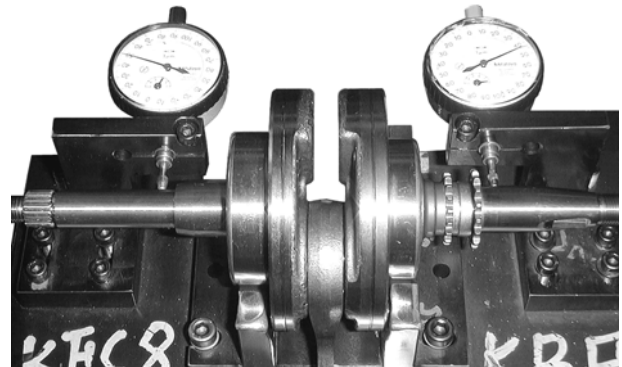

Measure the crankshaft bearing play.

Service Limits:

Axial : 0.20mm replace if over

Radial: 0.05mm replace if over

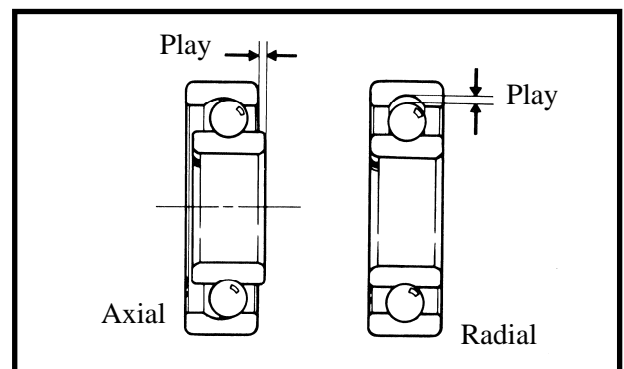

CRANKCASE ASSEMBLY

Clean off all gasket material from the crankcase mating surfaces.

- * • Avoid damaging the crankcase mating surfaces.



Install a new oil seal into the left crankcase.

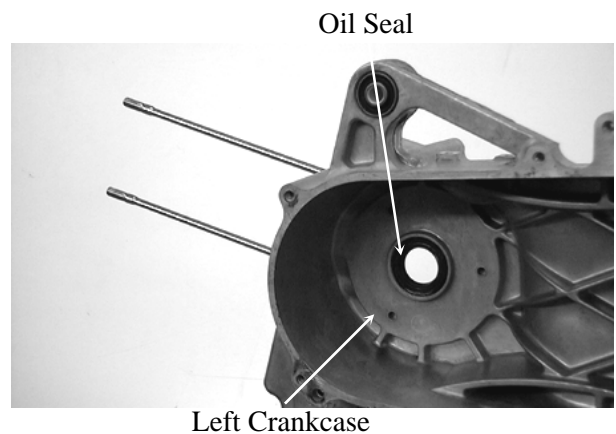

11. CRANKCASE/CRANKSHAFT

Place the left crankcase down and install the crankshaft into the left crankcase.

- *
 - Avoid damaging the oil seal.
 - Apply grease to the lip of the oil seal.



Install the two dowel pins and a new gasket.

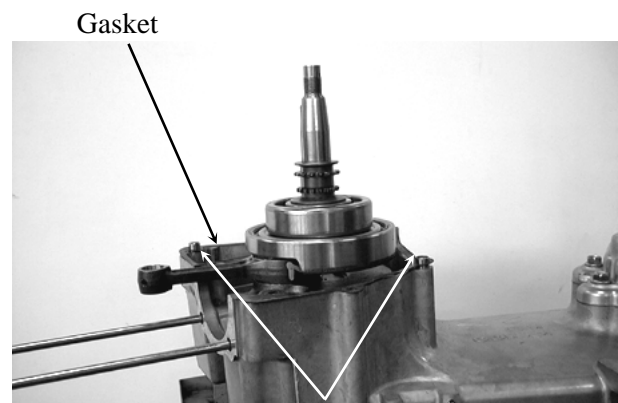

Dowel Pins

Place the right crankcase over the crankshaft and onto the left crankcase.

- *
 - Install the right crankcase squarely and do not tap it with an iron or plastic hammer.

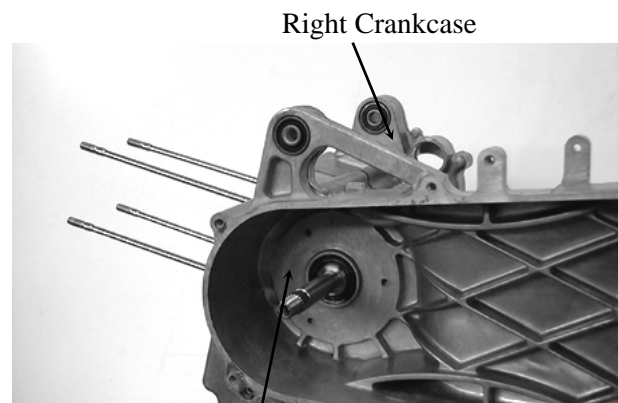

Left Crankcase

Install and tighten the right and left crankcase attaching bolts.

Torque: 7.8~10.8N-m

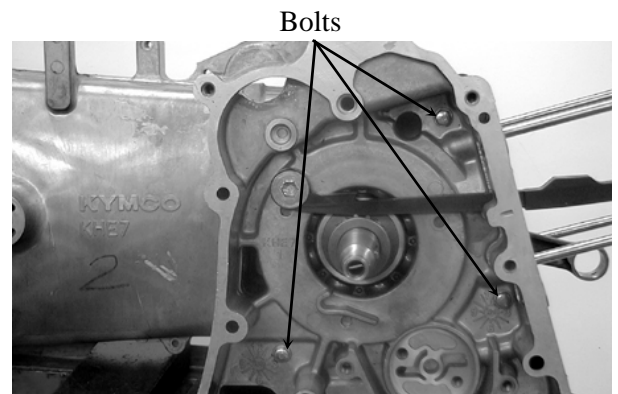

Bolts

11. CRANKCASE/CRANKSHAFT

Install the cam chain.
Install the cam chain tensioner slipper.
Install and tighten the cam chain tensioner slipper bolt.

Torque: 7.8~11.8N-m

Cam Chain Tensioner Slipper

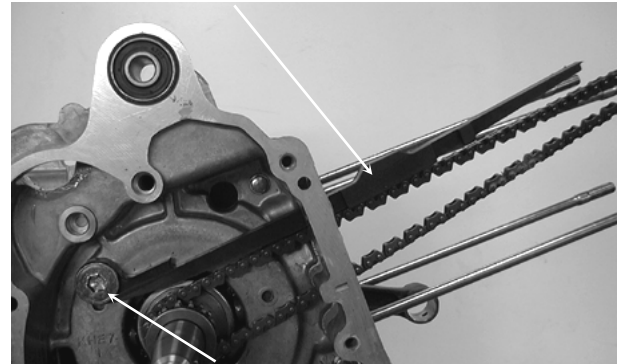

Bolt

12. COOLING SYSTEM

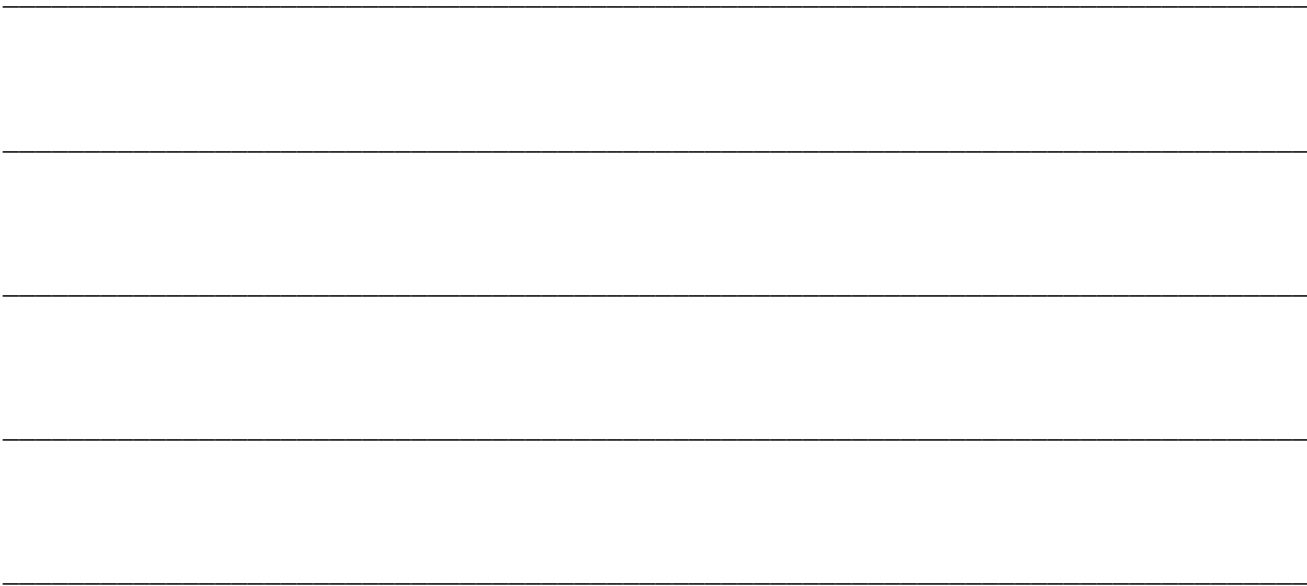

COOLING SYSTEM

SCHEMATIC DRAWING-----	12- 1
SERVICE INFORMATION-----	12- 2
TROUBLESHOOTING -----	12- 2
COOLING SYSTEM TESTING-----	12- 3
RADIATOR -----	12- 3
WATER PUMP -----	12- 7
THERMOSENSOR -----	12-10
THERMOSTAT -----	12-11

12. COOLING SYSTEM

SCHEMATIC DRAWING

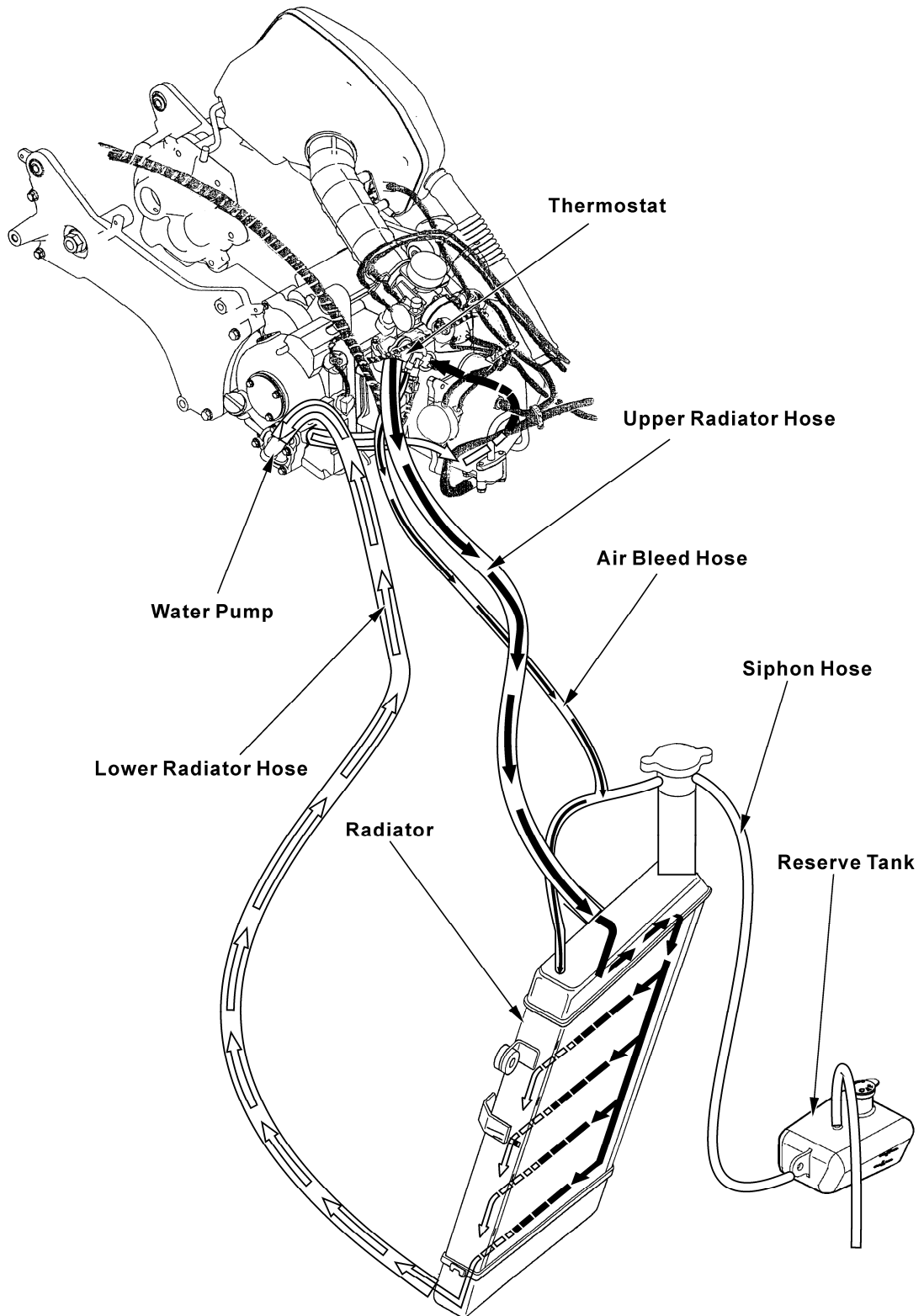

12. COOLING SYSTEM

SERVICE INFORMATION

GENERAL INSTRUCTIONS

- The water pump must be serviced after removing the engine. Other cooling system service can be done with the engine installed in the frame.
- The engine must be cool before servicing the cooling system.
When the coolant temperature is over 100°C, never remove the radiator cap to release the pressure because the boiling coolant may cause danger.
- Avoid spilling coolant on painted surfaces because the coolant will corrode the painted surfaces. Wash off any spilled coolant with fresh water as soon as possible.
- After servicing the system, check for leaks with a cooling system tester.

TORQUE VALUES

Water pump impeller	1.0~1.4 kgf-m (11.8 N-m)
Water pump cover bolt	1.0~1.4 kgf-m (11.8 N-m)

TROUBLESHOOTING

Engine temperature too high

- Faulty temperature gauge or thermosensor
- Faulty radiator cap
- Faulty thermostat
- Insufficient coolant
- Passages blocked in hoses or water jacket
- Clogged radiator fins
- Passages blocked in radiator
- Faulty water pump

Coolant leaks

- Faulty pump mechanical (water) seal
- Deteriorated O-rings
- Damaged or deteriorated water hoses

Temperature gauge shows the wrong temperature

- Faulty temperature gauge or thermosensor
- Faulty thermostat

SPECIFICATIONS

ITEM		SPECIFICATIONS
Coolant capacity	Radiator and engine	1 liter (1.1 US qt, 0.88 lmp qt)
	Reserve tank	0.37 liter (0.4 US qt, 0.33 lmp qt)
Radiator cap relief pressure		90 kPa (0.9 kgf/cm ² , 12.8 psi)
Thermostat	Begin to open	80 - 82°C (176 - 180°F)
	Fully open	90°C (198°F)
	Valve lift	3.5 mm (0.14 in) minimum
Standard coolant concentration		1:1 mixture with soft water

12. COOLING SYSTEM

COOLING SYSTEM TESTING

RADIATOR CAP INSPECTION

Install the radiator cap onto the radiator tester and apply specified pressure to it. It must hold specified pressure for at least six seconds.

- * Apply water to the sealing cap surface before testing.

Radiator Cap Relief Pressure:

$0.9 \pm 0.15 \text{ kg/cm}^2$

Install the radiator tester onto the radiator and apply specified pressure to it. It must hold specified pressure for at least six seconds.

Check the water hoses and connectors for leaks.

- * The test pressure should not exceed 1.05 kg/cm^2 . Excessive pressure can damage the radiator and its hose connectors.

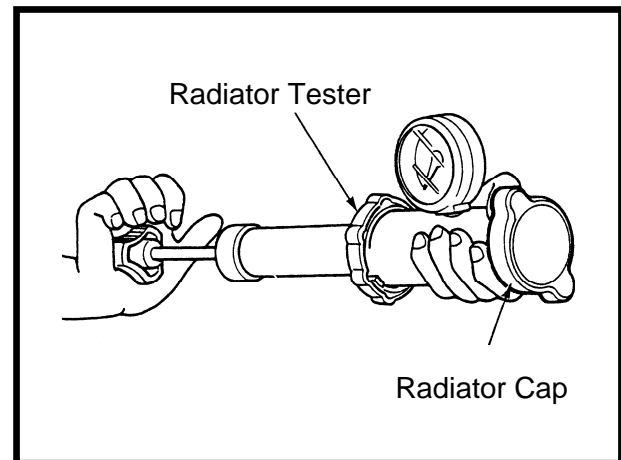

RADIATOR

RADIATOR INSPECTION

Remove the front cover.

Remove the radiator coolant panel screw



12. COOLING SYSTEM

Inspect the radiator soldered joints and seams for leaks.

Blow dirt out from between core fins with compressed air. If insects are clogging the radiator, wash them off. Carefully straighten any bent fins.



RADIATOR REMOVAL

Drain the coolant.

Disconnect the outlet tube of the reserve tank.

Remove the overflow tube clamp and disconnect the overflow tube.

Disconnect the air vent tube from the radiator filler.

Disconnect the fan motor wire coupler.



Loosen the hose band and disconnect the upper hose and lower hose from the radiator.

Disconnect the thermostatic switch wire coupler.



Thermostatic Switch

12. COOLING SYSTEM

Remove three bolts/nuts on the radiator.
Remove the radiator.



RADIATOR DISASSEMBLY

Remove bolts and then remove the fan rubber from the radiator.

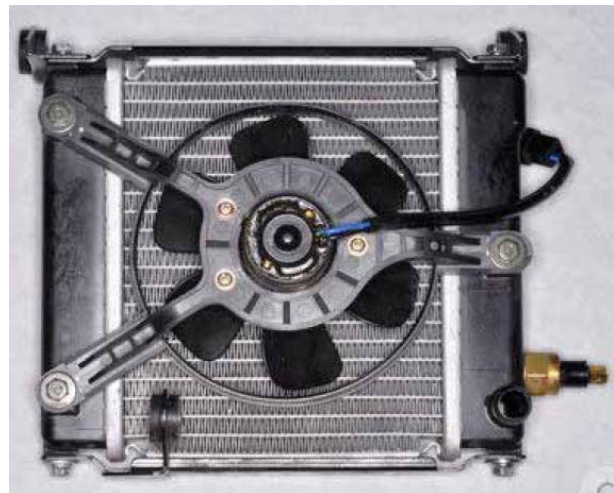

Check fan motor by battery.



12. COOLING SYSTEM

THERMOSTATIC SWITCH

When the coolant temperature is lower than 85 °C, the thermostatic switch OFF.

When coolant temperature is over 90 °C, the thermostatic switch ON.



Thermostatic Switch

RADIATOR INSTALLATION

Install the fan rubber on the radiator with three bolts.

Install the radiator on the radiator bracket with three bolts/nuts.

Connect the upper and lower hoses and secure them with hose bands.

Connect the thermostatic switch wire.

Connect the fan motor wire couplers.

Connect the overflow tube and secure with the tube clamp.

Fill the radiator with coolant.

Connect the vent tube to the radiator filler.

After installation, check for coolant leaks.

Connect the outlet tube of the reservoir and secure with the tube clamp.



- * If you want to refill the coolant, the following procedure must be checked.
1. Please make the radiator filler and the air vent tube to be separated.
 2. Start the engine, filled in the coolant till the coolant flowed out from the air vent tube.

12. COOLING SYSTEM

WATER PUMP

MECHANICAL SEAL (WATER SEAL) INSPECTION

Inspect the telltale hole for signs of mechanical seal coolant leakage.

If the mechanical seal is leaking, remove the right crankcase cover and replace the mechanical seal.

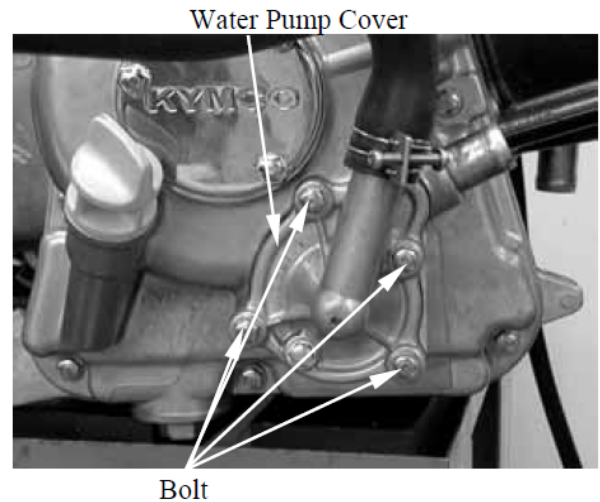

WATER PUMP/IMPELLER REMOVAL

Remove the coolant inlet hose and outlet hose.

Remove four bolts and the water pump cover, gasket and 2 dowel pins.
Remove the water pump impeller.

* The impeller has left hand threads.

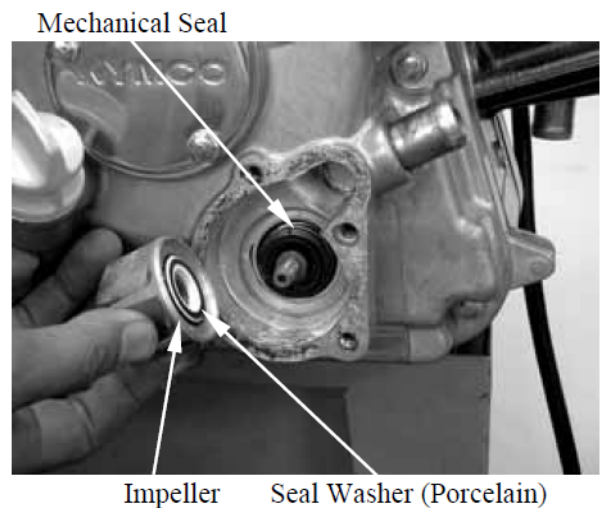

Inspect the mechanical (water) seal and seal washer if wear or damage.

* The mechanical seal and seal washer must be replaced as a set.

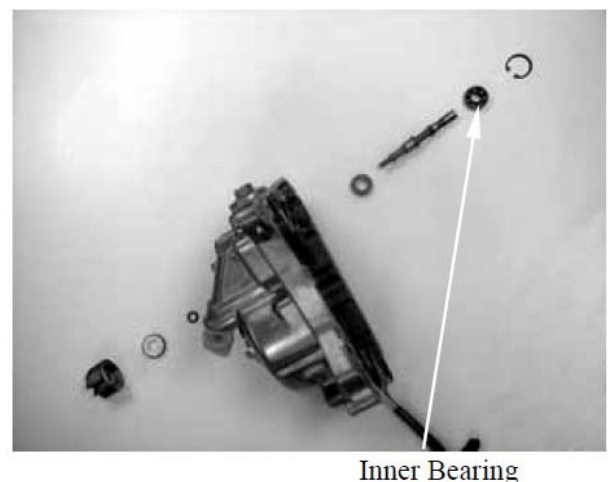

12. COOLING SYSTEM

WATER PUMP SHAFT REMOVAL

Disconnect the water hose from the right crankcase cover.

Remove bolts attaching the right crankcase cover.

Remove the water pump bearing snap ring from the water pump assembly.

Remove the water pump shaft and inner bearing.

Remove the water pump shaft outer bearing.

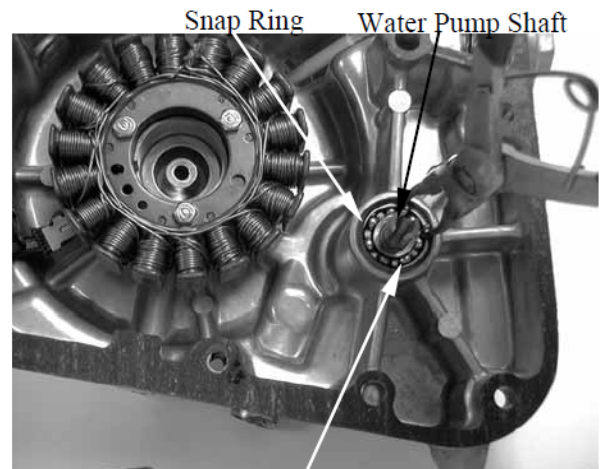

Inner Bearing

MECHANICAL SEAL REPLACEMENT

Drive the mechanical seal out of the water pump assembly from the inside.

* Apply sealant to the right crankcase cover of a new mechanical seal and then drive in the mechanical seal.

WATER PUMP SHAFT INSTALLATION

Drive a new water pump shaft outer bearing into the water pump assembly from the inside.

Install the water pump shaft and shaft inner bearing into the water pump assembly.

Install the snap ring to secure the inner bearing properly.

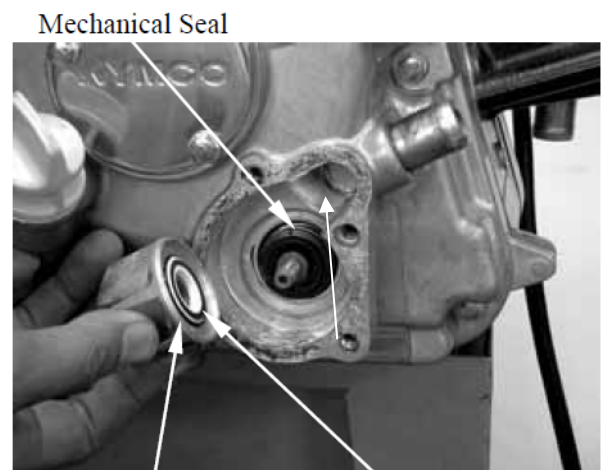

Impeller Seal Washer (Porcelain)

12. COOLING SYSTEM

Install the dowel pins and a new gasket and then install the water pump assembly to the right crankcase cover.

Tighten 12 bolts to secure the right crankcase cover.

* When installing the water pump assembly, aligning the groove on the water pump shaft with the tab on the oil pump shaft.

WATER PUMP/IMPELLER INSTALLATION

When the mechanical seal is replaced, a new seal washer must be installed to the impeller.

Install the impeller onto the water pump shaft.

Torque: 1.0~1.4 kgf-m (11.8 N-m)

* The impeller has left hand threads.

Install two dowel pins and a new gasket.

Install the water pump cover and tighten the 4 bolts.

Torque: 1.0~1.4 kgf-m (11.8 N-m)

Mechanical Seal

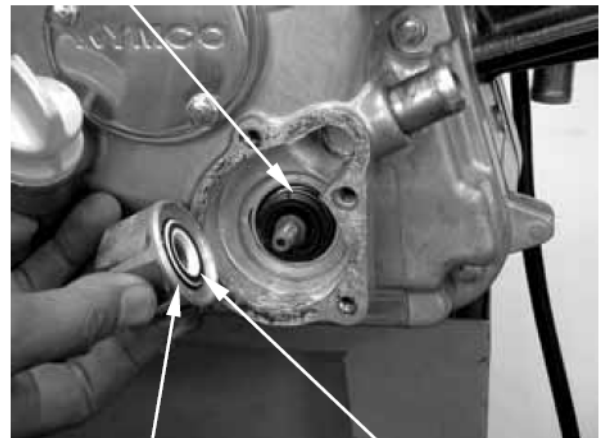

Impeller Seal Washer (Porcelain)

12. COOLING SYSTEM

THERMOSENSOR

THERMOSENSOR REMOVAL

Remove the met-in box and carrier.
Remove the body cover, center cover and rear fender cover A.

Drain the coolant.

Disconnect the thermosensor wire.

Remove the thermosensor.

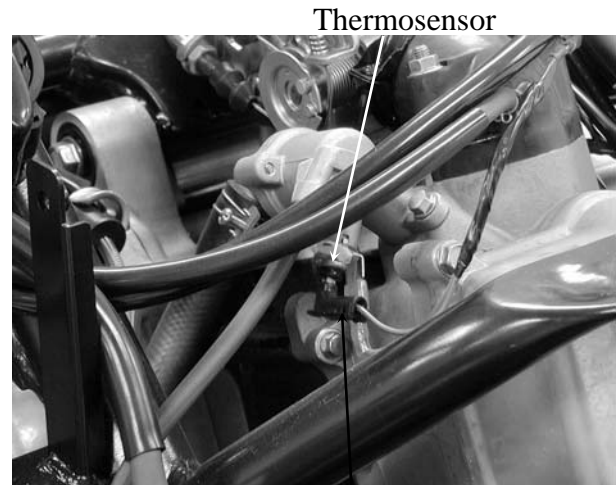

Thermosensor Wire

THERMOSENSOR INSPECTION

Suspend the thermosensor in a pan of water over a burner and measure the resistance through the sensor as the water heats up.

Temperature(°C)	50	80	100	120
Resistance(Ω)	154	52	27	16

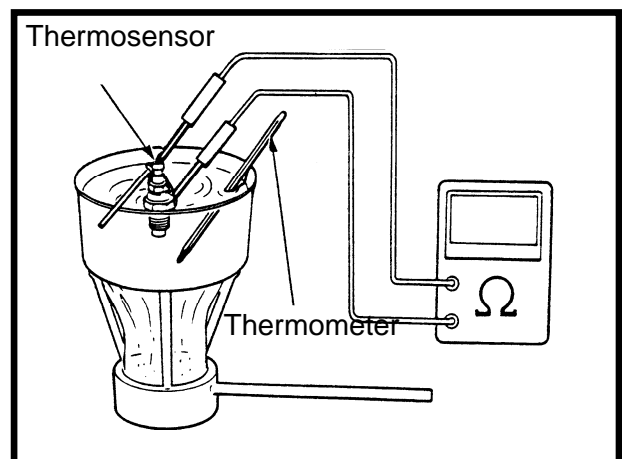

12. COOLING SYSTEM

THERMOSTAT

THERMOSTAT REMOVAL

Remove the met-in box and carrier.
Remove the body cover, center cover and rear fender cover A.

Drain the coolant.

Disconnect the thermosensor wire from the thermosensor.

Disconnect the water hose from the thermostat housing.

Disconnect the air vent tube from the thermostat housing.

Remove the mounting bolt and the thermostat housing from the cylinder head.

Thermosensor



Remove two bolts and separate the thermostat housing halves.

Remove the thermostat from the thermostat housing.

THERMOSTAT INSPECTION

Suspend the thermostat in a pan of water over a burner and gradually raise the water temperature to check its operation.

Technical Data

Begins to open	71 °C
Full-open	80 °C
Valve lift	3.5~4.5mm

- * Do not make the thermostat touch the pan as it will give a false reading.
- Replace the thermostat if the valve stays open at room temperature.
 - Test the thermostat after it is opened for about 5 minutes and holds the temperature at 70°C.

THERMOSTAT INSTALLATION

- * Replace the O-ring with a new one and apply grease to it.

Fill the cooling system with the specified coolant.

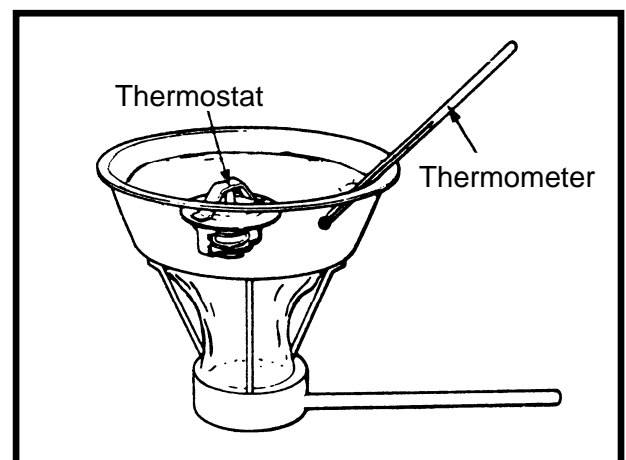

FUEL INJECTION SYSTEM

SERVICE INFORMATION-----	13- 1
SPECIFICATIONS -----	13- 2
INJECTION SYSTEM DIAGRAM -----	13- 3
PARTS LOCATION -----	13- 4
TROUBLESHOOTING-----	13- 8
SELF-DIAGNOSTIC PROCEDURES WITHOUT DIAGNOSTIC TOOL -----	13- 9
EFI SELF-DIAGNOSIS CHECK ENGINE LAMP (CELP) FAILURE CODES-----	13- 10
SELF-DIAGNOSIS RESET PROCEDURE -----	13- 11
CELP FAILURE CODES LIST-----	13-12
TPS/ISC RESET -----	13-15
FUEL PUMP -----	13-16
FUEL CUT-OFF RELAY -----	13-18
TILT SWITCH -----	13-19
ELECTRONIC CONTROL UNIT (ECU)-----	13-20
FUEL INJECTOR -----	13-22
WTS SENSOR -----	13-24
O ² SENSOR -----	13-25
THROTTLE BODY/MAP/ISC/TPS -----	13-26
DIAGNOSTIC TOOL CONNECTOR-----	13-29
DIAGNOSTIC TOOL OPERATION INSTRUCTIONS -----	13-30
VEHICLE CAN NOT BE STARTED -----	13-42
MANUAL TROUBLE SHOOTING PROCEDURE-----	13-43

SERVICE INFORMATION

GENERAL INSTRUCTIONS

- Scooter services can be done with the engine installed in the frame.
- Be sure to relieve the fuel pressure before fuel pump or fuel hose removal.
- Bending or twisting the control cables will affect operation and could cause the cables to stick or bind, resulting in loss of vehicle control.
- Work in a fully ventilated area. Smoking or allowing flames or sparks in the work area or where gasoline is stored can cause a fire or explosion.
- Do not apply the Carburetor Cleaners to the inside of the throttle body, which is coated with molybdenum.
- Do not snap the throttle valve from fully open to fully close after the throttle cable has been removed; it may cause incorrect idle speed.
- Do not loosen or tighten the painted bolts and screws of the throttle body. Loosening or tightening them can cause throttle and idle valve synchronization failure.
- Seal the cylinder head intake ports with tape or a clean towel to prevent dirt and debris from entering the intake ports after the throttle body has been removed.
- Do not damage the throttle body. It may cause incorrect throttle and idle valve synchronization.
- Do not take the fuel pump on the ground downward.
- Always replace the packing when the fuel pump is removed.
- The electronic fuel injection system is equipped with the self-diagnostic system. If the Check Engine Lamp “CELP” illuminate while riding, follow the self-diagnostic procedures to solve the problem.
- A faulty AFI problem is often related to poorly connected or corroded connectors. Check those connections before proceeding.
- When disassembling the fuel injection parts, note the location of the O-rings. Replace them with new ones upon reassembly.
- Do not disconnect the battery negative (-) or positive (+) cable while engine is running, it may cause ECU damage.
- **Do not disconnect or connect the ECU connector during the ignition switch “ON”; it may cause the ECU damage.**

13. FUEL INJECTION SYSTEM



G-DINK 300i

SPECIFICATIONS

ITEM		SPECIFICATIONS
Throttle body identification number		LHG7
Idle speed		1600±100 rpm
Throttle grip free play		2~6 mm (1/16~1/4 in)
Fuel injector resistance (at 20°C/68°F)		11.7±0.6 Ω
Fuel pump resistance (at 20°C/68°F)	Float at full position	1100±33 Ω
	Float at empty position	100±3 Ω
Fuel pump standard pressure (at 40 L/Hr)		294±6 kPa (3 Bar)
Water temperature sensor resistance	At -20°C/-4°F	18.8 KΩ
	At 40°C/104°F	1.136 KΩ
	At 100°C/212°F	0.1553 KΩ
Intake pressure sensor (MAP) pressure (at 1~4.2 V)		13.332 kPa (0.13332 kgf/cm ² , 1.89 psi)~ 119.99 kPa (1.1999 kgf/cm ² , 17.04 psi)
Inductive ignition coil		Primary: 3.57~4.83 Ω Secondary: 10.42~14.49K Ω
Throttle position sensor (TPS) resistance (at 20°C/68°F)		3500~6500 Ω
Crank position sensor voltage (at 200 rpm)		100~130 Ω
O ² heater sensor resistance (at 20°C/68°F)		6.7~9.5 Ω (engine warming condition)
Tilt switch voltage	Standard	0.4~1.4 V
	Over 65° (fall down)	3.7~4.4 V

INJECTION SYSTEM DIAGRAM

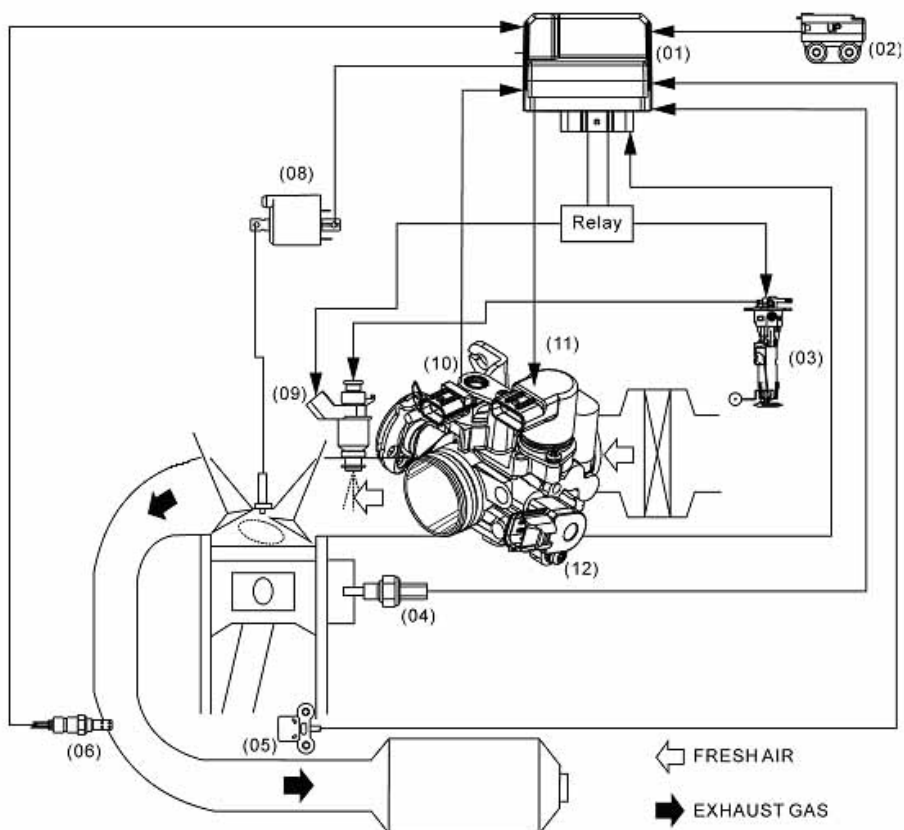

No.	FULL NAME	ABBREVIATIONS
(01)	Electronic control unit	ECU
(02)	Tilt switch (Angle detect sensor)	ROLL
(03)	Fuel pump/Fuel level unit	FP
(04)	Water temperature sensor	WTS sensor
(05)	Crank position sensor (Pulser)	CPS
(06)	Oxygen/Oxygen heater sensor	O ² /O ² Heat sensor
(08)	Inductive ignition coil	IG
(09)	Fuel injector (Nozzle)	INJ
(10)	Intake pressure sensor	MAP sensor
(11)	Idle air bypass valve	ISC
(12)	Throttle position sensor	TPS

PARTS LOCATION

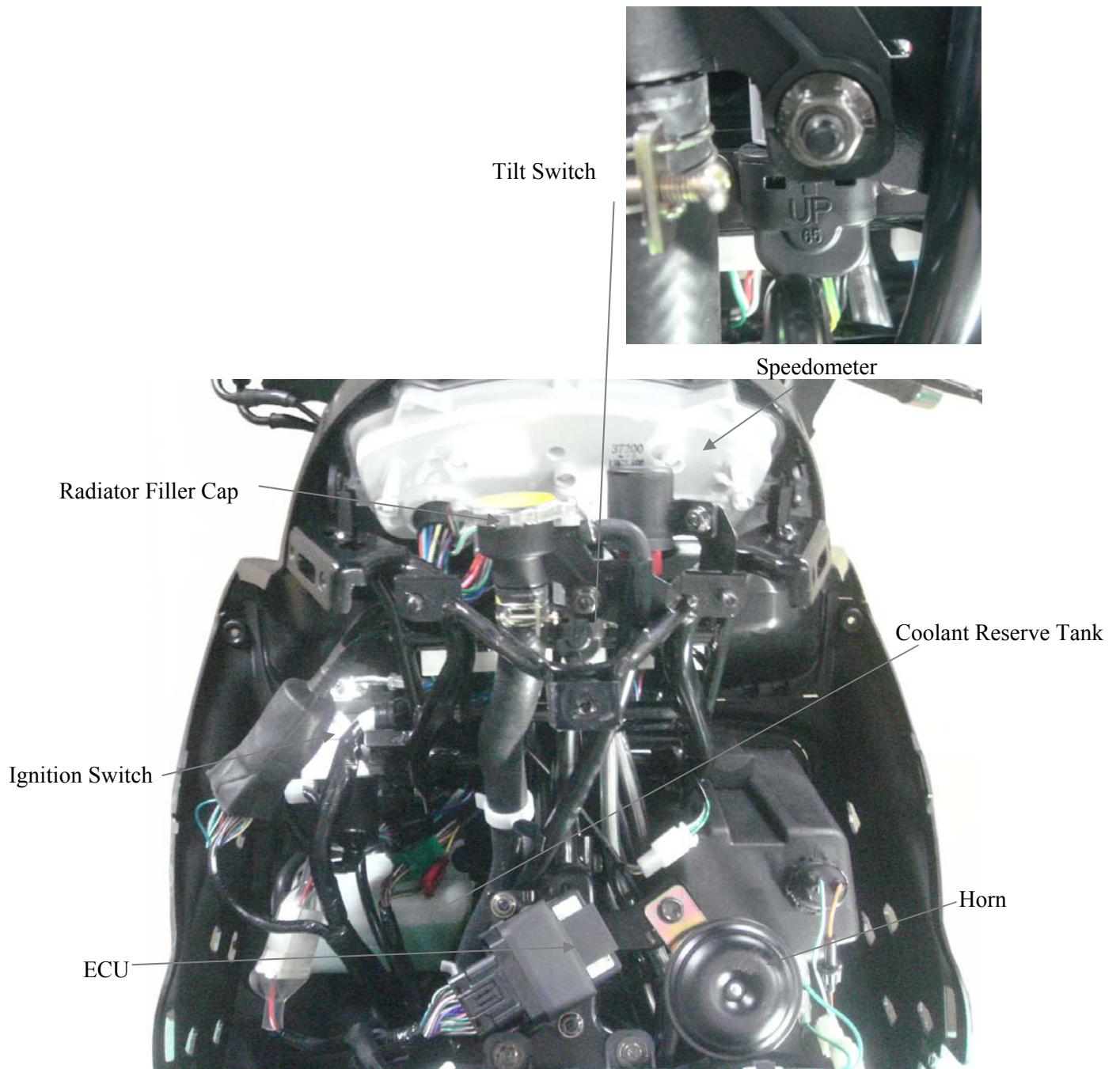

CABLE & HARNESS ROUTING

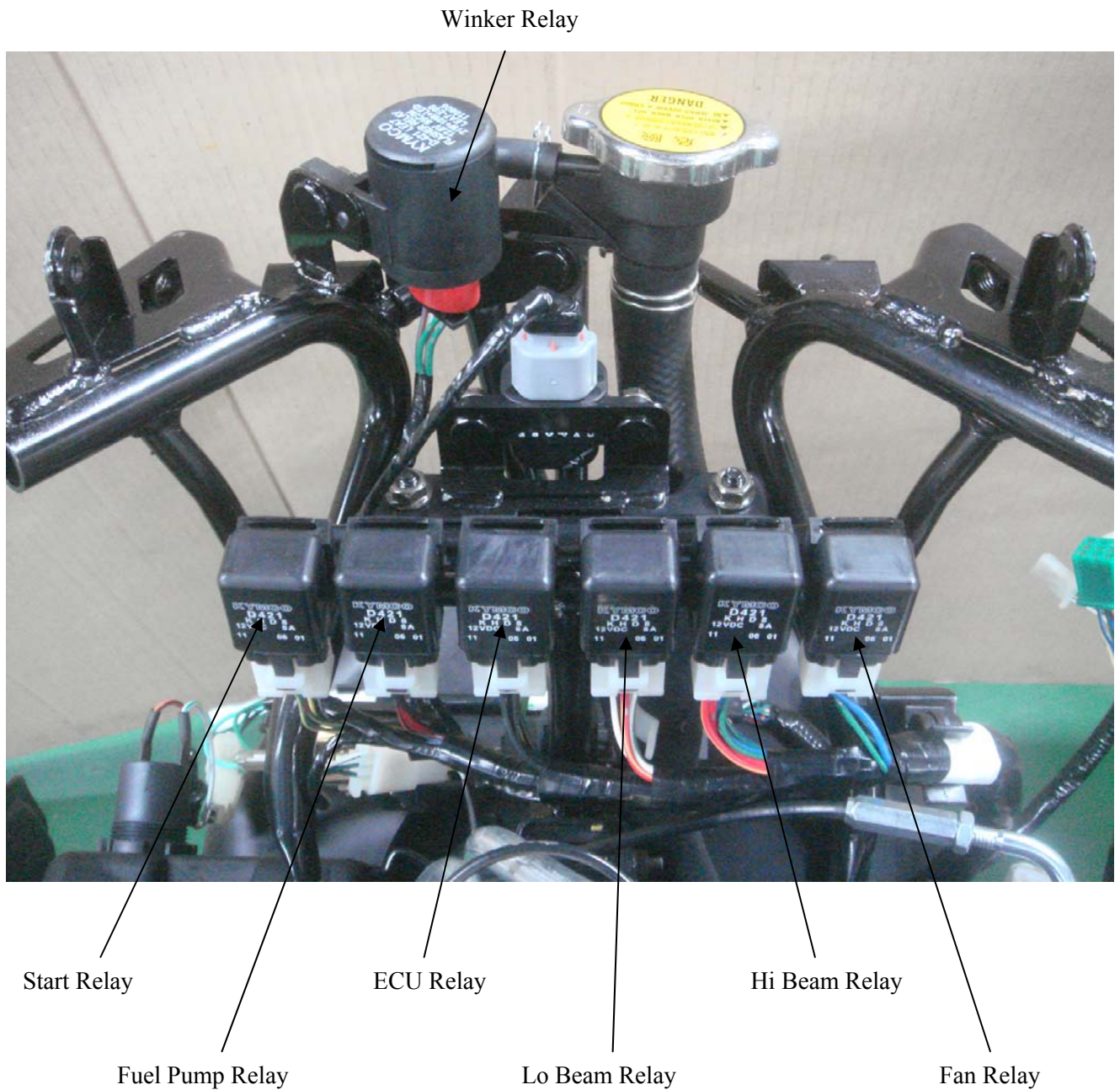

13. FUEL INJECTION SYSTEM

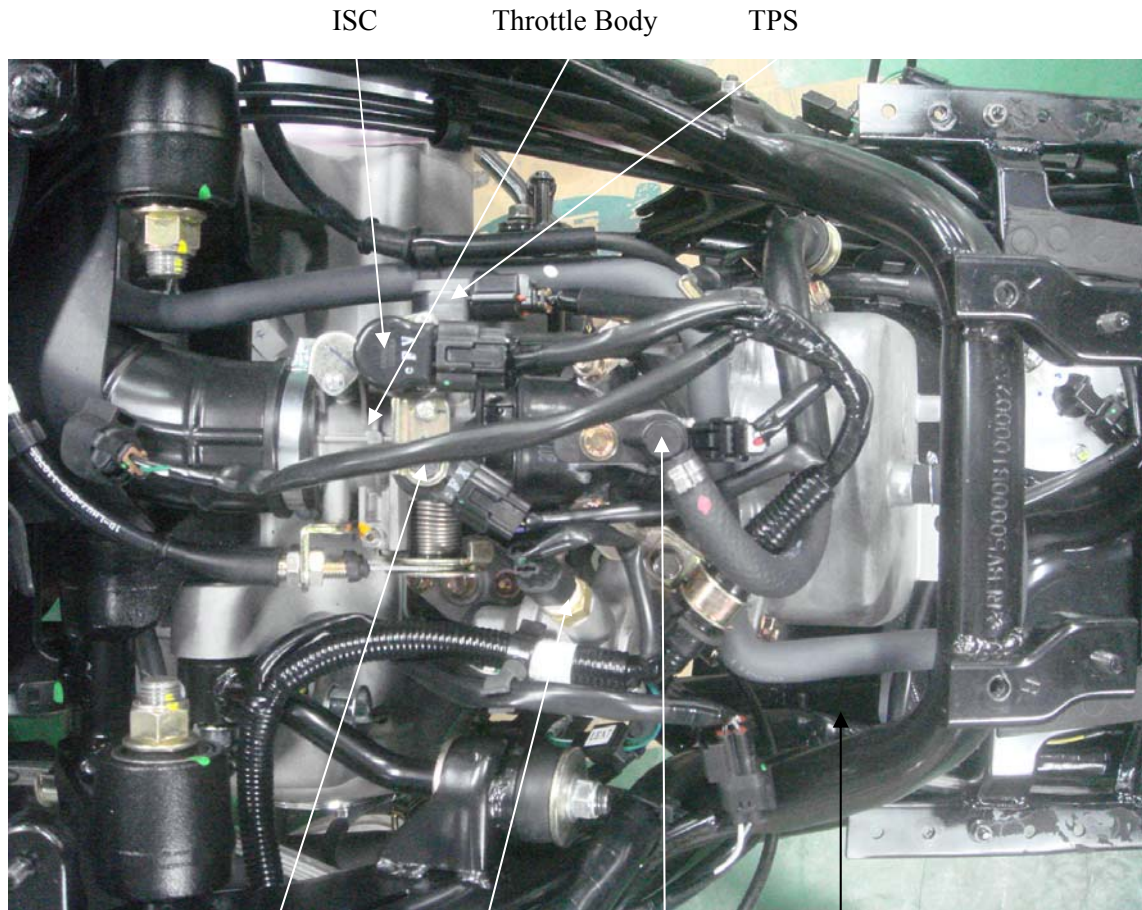

MAP Sensor

WTS

Injector



O2 Sensor

13. FUEL INJECTION SYSTEM

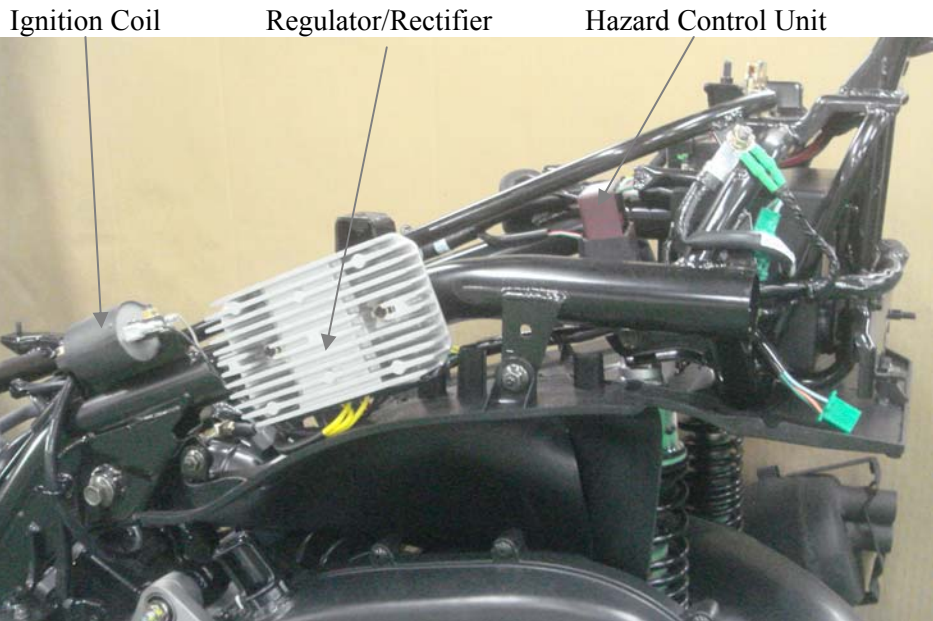

Starter Relay



Crank Position Sensor



13. FUEL INJECTION SYSTEM

TROUBLESHOOTING

Engine fail to start

- Intake manifold air leak
- Fuel contaminated/deteriorated
- Pinched or clogged fuel hose
- Faulty fuel pump
- Clogged fuel filter, throttle body
- Sticking fuel injector needle
- Faulty fuel pump operating system
- Carbon deposit stayed on the fuel injector
- Spark plug dirty
- Fuel pressure incorrect

Engine stall, hard to start, rough idling

- Intake air leak
- Fuel contaminated/deteriorated
- Pinched or clogged fuel hose
- Idle speed fail to adjust
- Fail to perform PTS/ISC reset

Backfiring or misfiring during acceleration

- Ignition system malfunction

Poor performance (drive ability) and poor fuel economy

- Pinched or clogged fuel hose
- Faulty injector

SELF-DIAGNOSTIC PROCEDURES WITHOUT DIAGNOSTIC TOOL

SELF-DIAGNOSTIC PROCEDURES

* It can be performed without diagnostics program.

Place the scooter on its main stand.
Put the side stand up and the engine stop switch is at "RUN".

- Turn key to On position.
- The CELP will be lighting for two seconds and then off.
- If the engine has problem, the CELP will blink to show the failure codes.
- There're 11 failure codes for the KEHIN system.

If the vehicle gets more failure codes, the CELP will be blinking from a lower number, then show the higher number after three seconds. All failure codes would be appeared repeatedly.

* No matter when the "CELP" illuminated while riding condition, should find out the cause of the problem as soon as

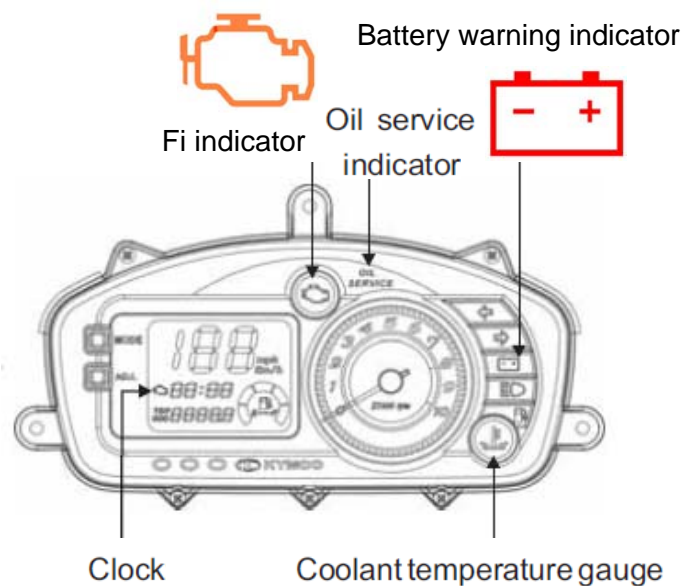

EFI SELF-DIAGNOSIS CHECK ENGINE LAMP (CELP) FAILURE CODES

The “CELP” denotes the failure codes. When the indicator lights for one second that is equal to ten.

For example: one longer blink illumination and two shorter blinks (0.5 second x 2) of the indicator is equal to 12 blinks. Follow code 12.

If more than a damaged part has occurred, the “CELP” begins blinking in order.

For example: If the indicator blinks six times, then shows one second illumination and two blinks, so there are two failures have occurred. Follow code 6 and 12.

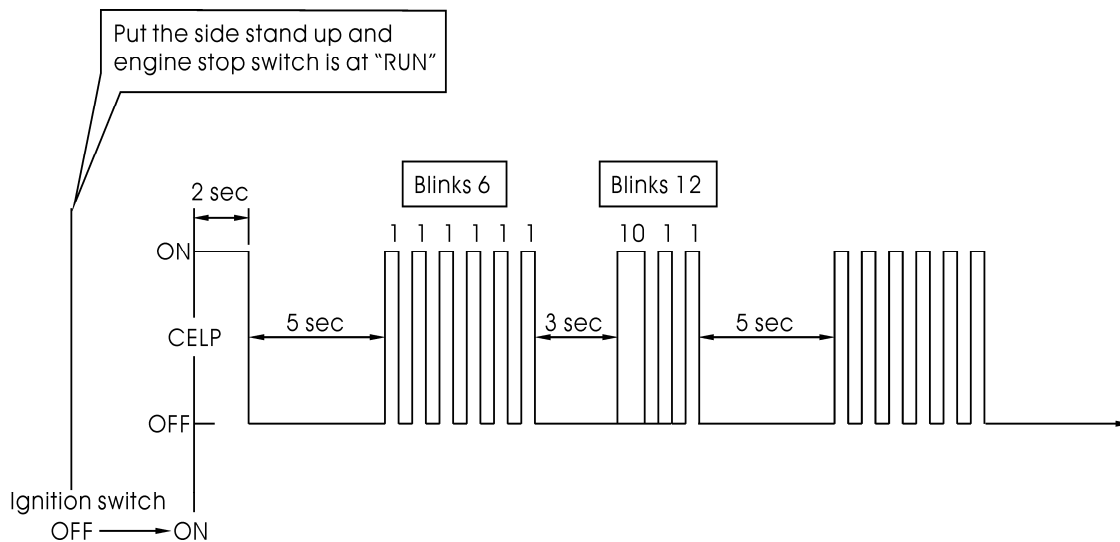

SELF-DIAGNOSIS RESET PROCEDURE

1. Put the side stand up and engine stop switch is at "RUN".
2. Turn the key to the ON position and wait for ten seconds.
3. Fully open the throttle and wait for ten seconds.
4. Release the throttle.
5. The indicator will blink twice (0.5 second) after five seconds quickly.
6. Self-diagnosis memory data is disappeared after the CELP lamp is off.

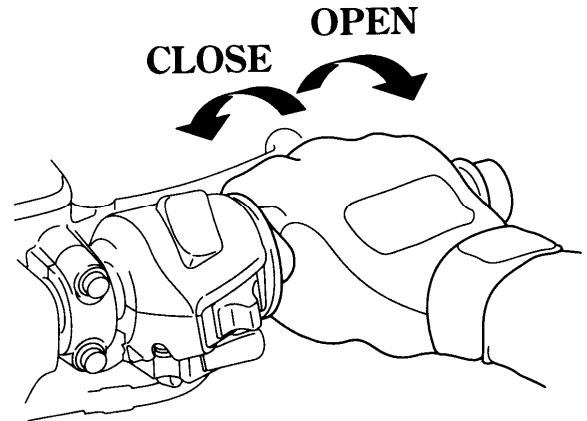

* The self-diagnosis can not be reset when has still problem inside the system.

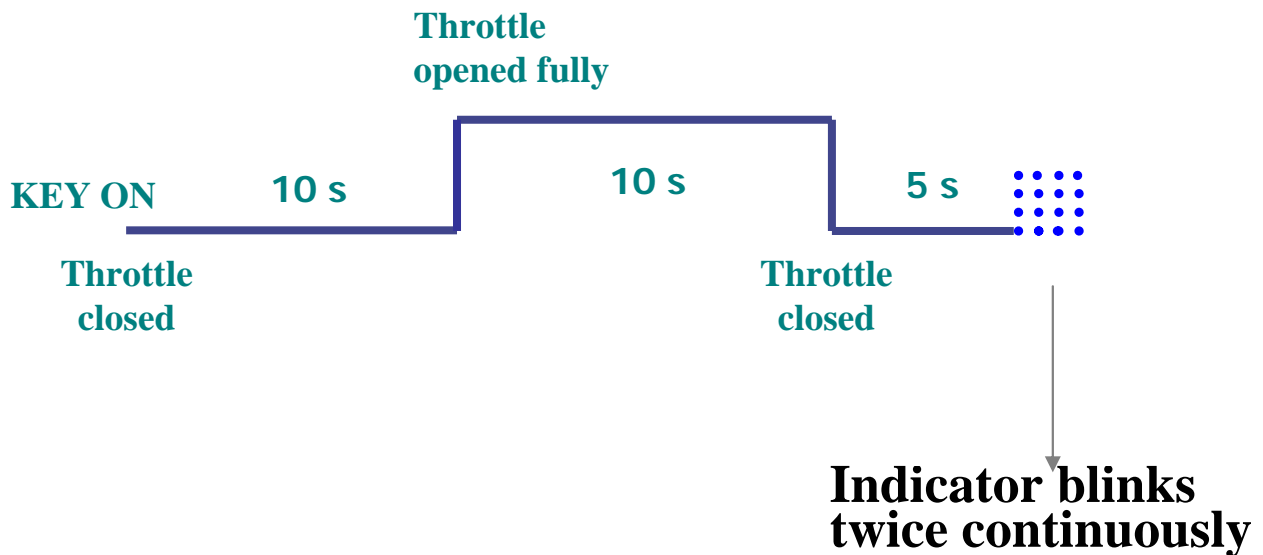

CELP FAILURE CODES LIST

Blinks	Failure Codes (diagnostic tool)	Contents	Causes	Symptoms
06	P0120	Faulty TPS	<ul style="list-style-type: none"> ● Faulty TPS voltage range (0.3~4.5 V) ● Loose or poor connection on TPS Sensor ● Open or short circuit on the TPS wire ● Faulty TPS itself. 	Engine operates normally
09	P0105	Faulty MAP	<ul style="list-style-type: none"> ● Faulty MAP voltage range (1~4.2 V) ● Loose or poor connection on MAP Sensor ● Open or short circuit on MAP wire ● Faulty MAP itself 	Engine operates normally
12	P0115	Faulty WTS (water temperature)	<ul style="list-style-type: none"> ● Faulty ECT Ω range (-20°C: 18.8 Ω/40°C: 1.136 Ω/100°C: 0.1553 Ω) ● Loose or poor connection on ECT ● Open or short circuit on ECT wire ● Faulty ECT 	Engine operates normally
15	P1630	Faulty Tilt switch (Roll)	<ul style="list-style-type: none"> ● Faulty Tilt switch voltage range (inclined angle <65°: 0.4~1.4 V/ Inclined angle >65°: 3.7~4.4 V) ● Loose or poor connection on Tilt switch ● Open or short circuit in Tilt switch wire ● Faulty tilt switch 	Engine operates normally
17	P0130	Faulty O ² sensor	<ul style="list-style-type: none"> ● Faulty O² sensor voltage range (A/F below 14.7: > 0.7V/ A/F over 14.7: < 0.18 V) ● Loose or poor connection on O² sensor ● Open or short circuit on O² sensor wire ● Faulty O² sensor 	Engine operates normally
33	P0201	Faulty injector (Nozzle)	<ul style="list-style-type: none"> ● Faulty Fuel injector Ω range (9.945~13.5 Ω) ● Loose or poor connection on injector ● Open or short circuit on injector wire ● Faulty fuel injector 	Engine fail to be operated

Blinks	Failure Codes (diagnostic tool)	Contents	Causes	Symptoms
37	P0351	Faulty inductive ignition coil	<ul style="list-style-type: none"> ● Faulty Inductive ignition coil Ω range ($4.2 \Omega \pm 15\%$) ● Loose or poor connection on inductive ignition coil ● Open or short circuit on inductive ignition coil wire ● Faulty inductive ignition coil 	Engine fail to be operated
41	P0230	Faulty fuel pump	<ul style="list-style-type: none"> ● Faulty Fuel pump Ω range (F: $1100 \pm 33 \Omega$ E: $100 \pm 3 \Omega$) ● Loose or poor connection on fuel pump ● Open or short circuit on fuel pump wire ● Faulty fuel pump 	Engine fail to be operated
45	P0135	Faulty O ² sensor heater	<ul style="list-style-type: none"> ● Faulty O² sensor heater Ω range ($6.7 \Omega \sim 9.5 \Omega$) ● Loose or poor connection on O² sensor heater ● Open or short circuit on O² sensor heater wire ● Faulty O² sensor heater 	Engine starts normally but not smooth
49	P1505	Faulty ISC	<ul style="list-style-type: none"> ● Loose or poor contacts on ISC ● Open or short circuit in ISC wire ● Faulty ISC 	Engine operates normally
66	P0335	Faulty CPS	<ul style="list-style-type: none"> ● Loose or poor connection on CPS sensor ● Open or short circuit on CPS wire ● Faulty CPS sensor 	Engine starts normally but not smooth

SPARK PLUG ANTI-FLOOD

When have not failure code occurs and pressing starter switch repeatedly, can still not start the engine, maybe the spark plug is wet by fuel, perform the spark plug anti-flood to purge the fuel in the engine.

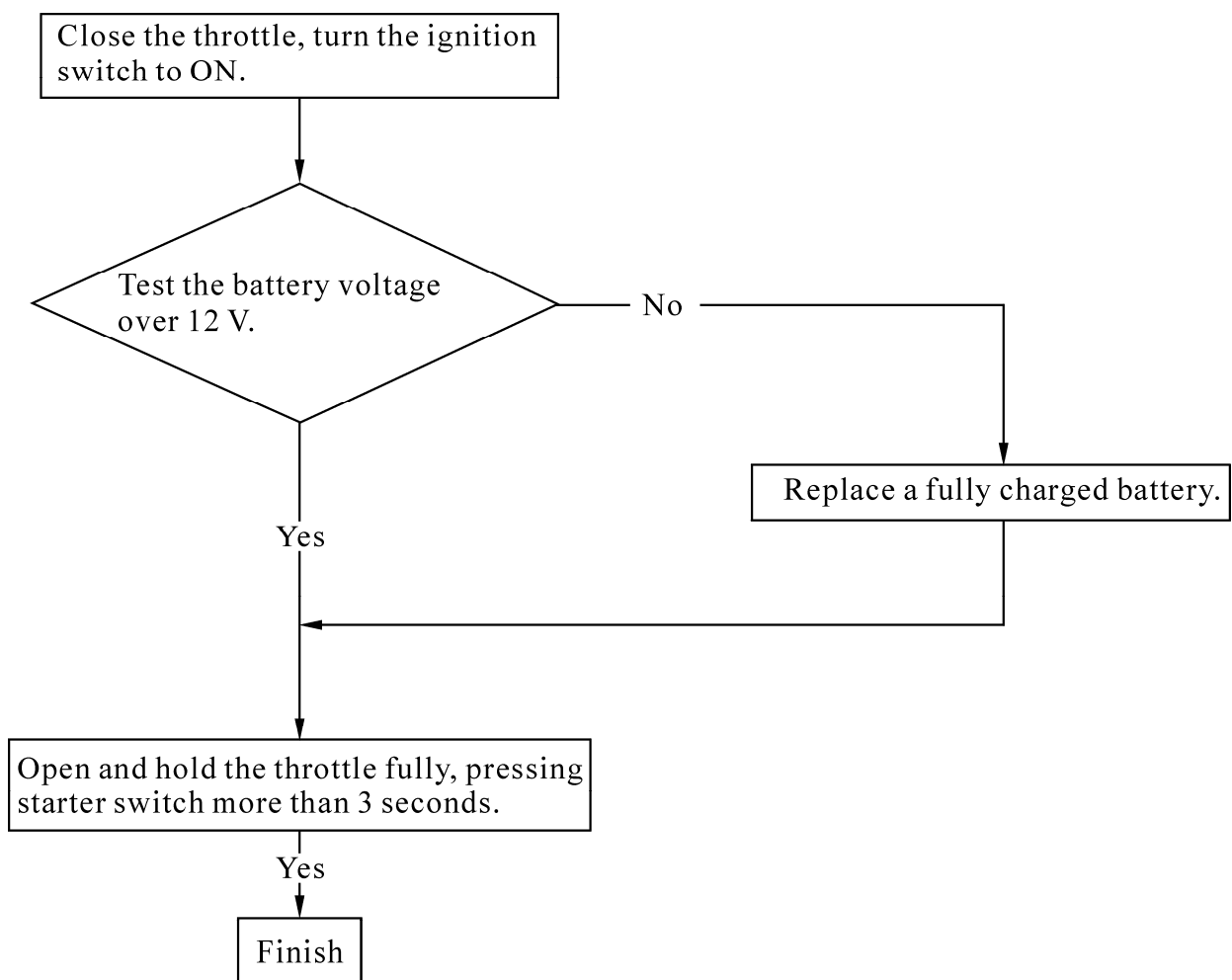

TPS/ISC RESET

- If close or open the throttle grip randomly, the ECU may record the incorrect TPS when the ECU or the throttle body has been reinstalled. It can cause hard to start engine or idling speed is not smooth when engine installation.
- ISC has a motor inside, which controls ISC valve to obtain smooth idling speed. The ECU may record the incorrect ISC position during the engine speed isn't working when the ECU or the throttle body has been reinstalled. It can cause engine stop, hard to start engine or rough idling speed.

The throttle position sensor (TPS) and idle air bypass valve (ISC) have to be reset when throttle body, MAP, TPS, ISC or ECU has been reinstalled.

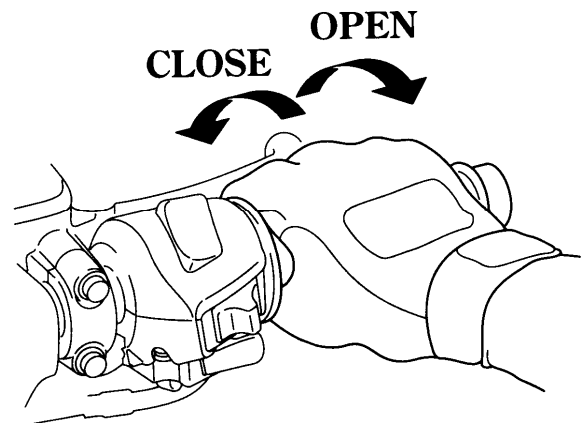

TPS/ISC RESET PROCEDURE

1. Put the side stand up and engine stop switch is at "RUN".
2. Turn the key to the OFF position.
3. Fully open the throttle.
4. Turn the key to the ON position.
5. Release the throttle after waiting for eight seconds.
6. Turn the key to the OFF position.
7. Turn the key to the ON position.
8. TPS and ISC have been reset successfully.

If fail to reset, repeat the steps from 1 to 8.

FUEL PUMP

INSPECTION

Put the side stand up and the engine stop switch is at "RUN"

Disconnect the fuel pump/fuel unit connector.

Connect the multimeter (+) probe to the Red/Black terminal and the multi-meter (-) probe to the Green terminal.

Turn the ignition switch to "ON" and measure the voltage between the terminals.

It should be shown the current battery voltage for a few seconds.

If there is still battery voltage, replace the fuel pump.

If there is not any battery voltage, inspect the following:

- Fuse B (10 A)
- Fuel cut-off relay
- ECU

Measure the resistance between the Red/Black and Green terminals of the fuel pump side connector.

Standard (at 20°C/68°F): 1.9±0.3 Ω

Fuel level sensor inspection

Measure the resistance between the Yellow/White and Green terminals of the fuel pump side connector.

Standard (at 20°C/68°F):

Float at full position	1100±33 Ω
Float at empty position	100±3 Ω

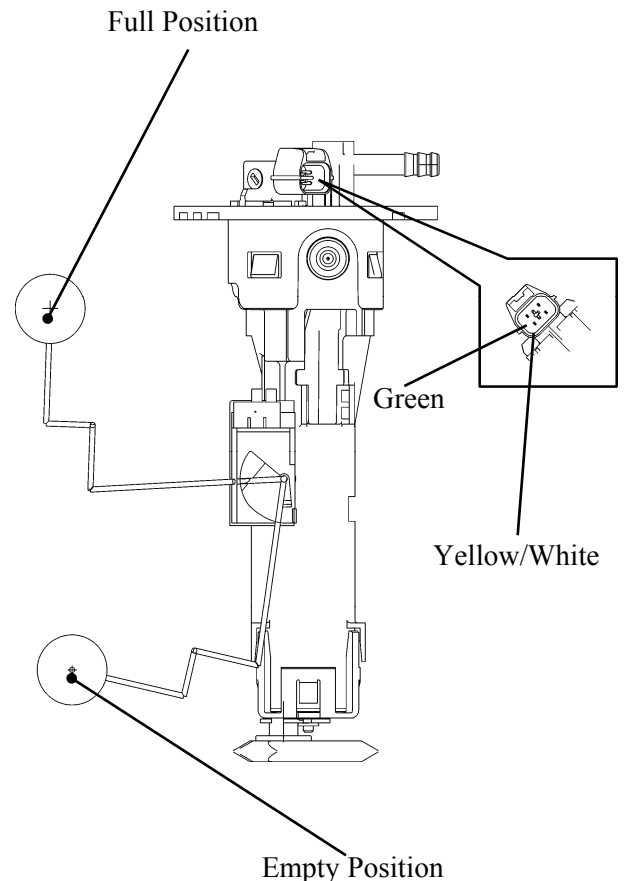

REMOVAL

Disconnect the connector and fuel band from the fuel pump.

Remove the six screws onto the fuel pump.

Remove the fuel pump and O-ring.

INSTALLATION

Replace a new O-ring on the fuel tank.

Don't damage the fuel pump wire and ensure the connector rearward carefully.

Torque: 0.35 kgf-m (3.5 N-m, 2.5 lbf-ft)

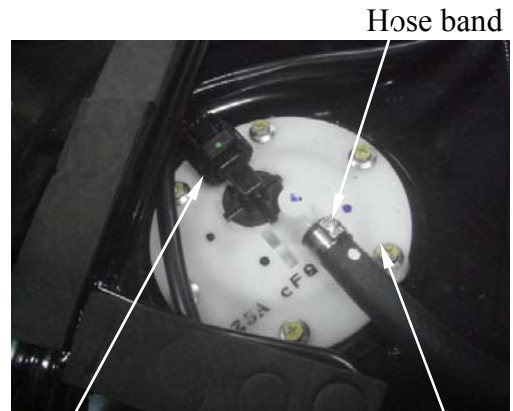

Connector

Screw

FUEL OUTPUT PRESSURE INSPECTION

Turn the key to the OFF position.

Use the fuel hose clamp.

Disconnect the fuel hose from the fuel injector.

Connect the fuel pressure gauge.

Turn the key to the ON position.

Check the fuel pressure.

Standard:3.0 Bar

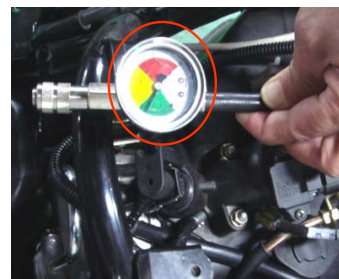

* **If the fuel output pressure is less than 3.0 bar, may fail to start the engine or in trouble in case of riding.**

FUEL PUMP RELAY

INSPECTION

Remove the fuel pump relay.
Connect the ohmmeter to the fuel pump relay connector terminals.

Connection: Black – Red/Black

Connect 12 V battery with the fuel pump relay connector.

Connection: Blue/Black – Black

There should be continuity only when 12 V battery connected.

If there is not continuity when the 12 V battery is connected, replace a fuel pump relay.

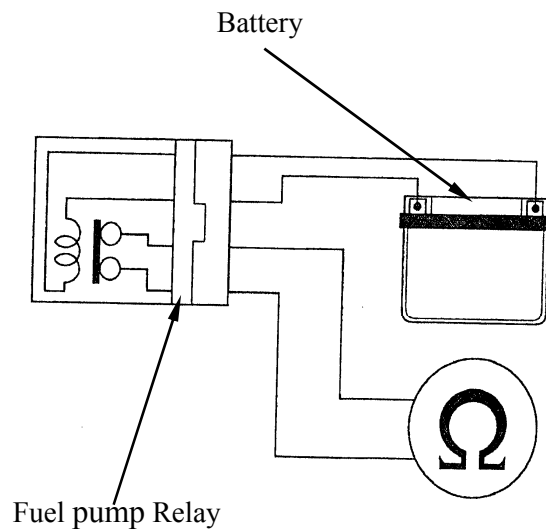

REMOVAL

Disconnect the fuel pump relay connector and remove it from frame.

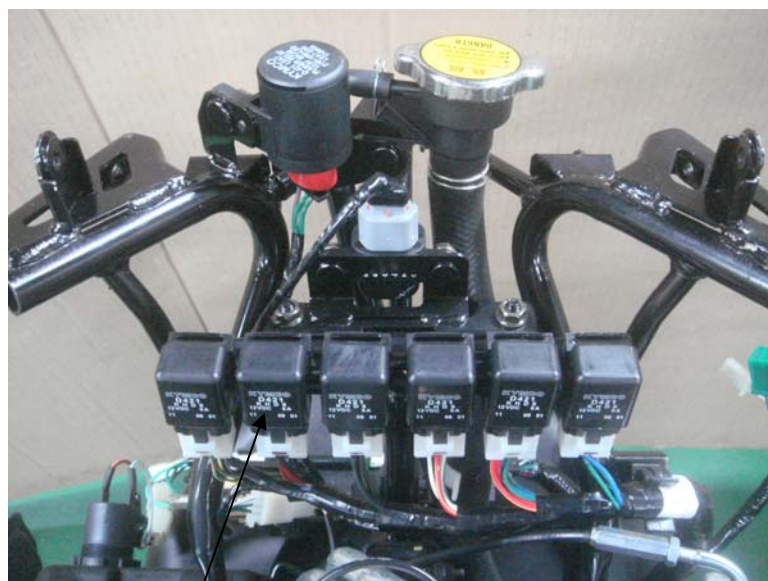

Fuel pump Relay

TILT SWITCH

INSPECTION

Support the scooter level surface.

Put the side stand up and engine stop switch is at "RUN".

Turn the ignition switch to "OFF"

Remove the screws, washers and tilt switch.

* Do not disconnect the tilt switch connector during inspection.

Place the tilt switch vertical as shown, and turn the ignition switch to "ON".

Measure the voltage between the following terminals of the tilt switch connector with the connector connected.

Terminal	Normal
Violet/Red (+) – Green/Pink (-)	5 V (ECU voltage)
Black/Blue (+) – Green/Pink (-)	0.4~1.4 V

Incline the tilt switch 65±10 degrees to the left or right with the ignition switch turned to "ON".

Measure the voltage between the following terminals of the tilt switch connector with the connector connected.

Terminal	Normal
Violet/Red (+) – Green/Pink (-)	5 V (ECU voltage)
Black/Blue (+) – Green/Pink (-)	3.7~4.4 V

If repeat this test, first turn the ignition switch to "OFF", then turn the ignition switch to "ON".

REMOVAL/INSTALLATION

Disconnect the connector and remove two screws.

Remove the Tilt switch.

Installation is in the reverse order of removal.

* Install the tilt switch with its "UP" mark facing up.

Tighten the mounting screws securely.

Tilt Switch "UP" Mark

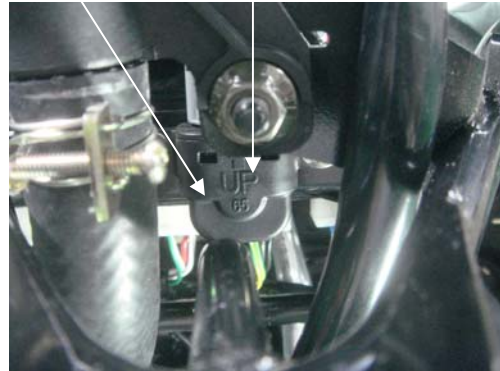

Tilt Switch Connector



ELECTRIC CONTROL UNIT (ECU)

REMOVAL/INSTALLATION

- * • Do not disconnect or connect the ECU connector during the ignition switch “ON”; it may cause the ECU damaged.
- The throttle position sensor (TPS) and idle air bypass valve (ISC) have to be reset when throttle body, MAP, TPS, ISC or ECU has been reinstalled.

Disconnect the ECU connector and remove the ECU from the frame.

Installation is in the reverse order of the removal.

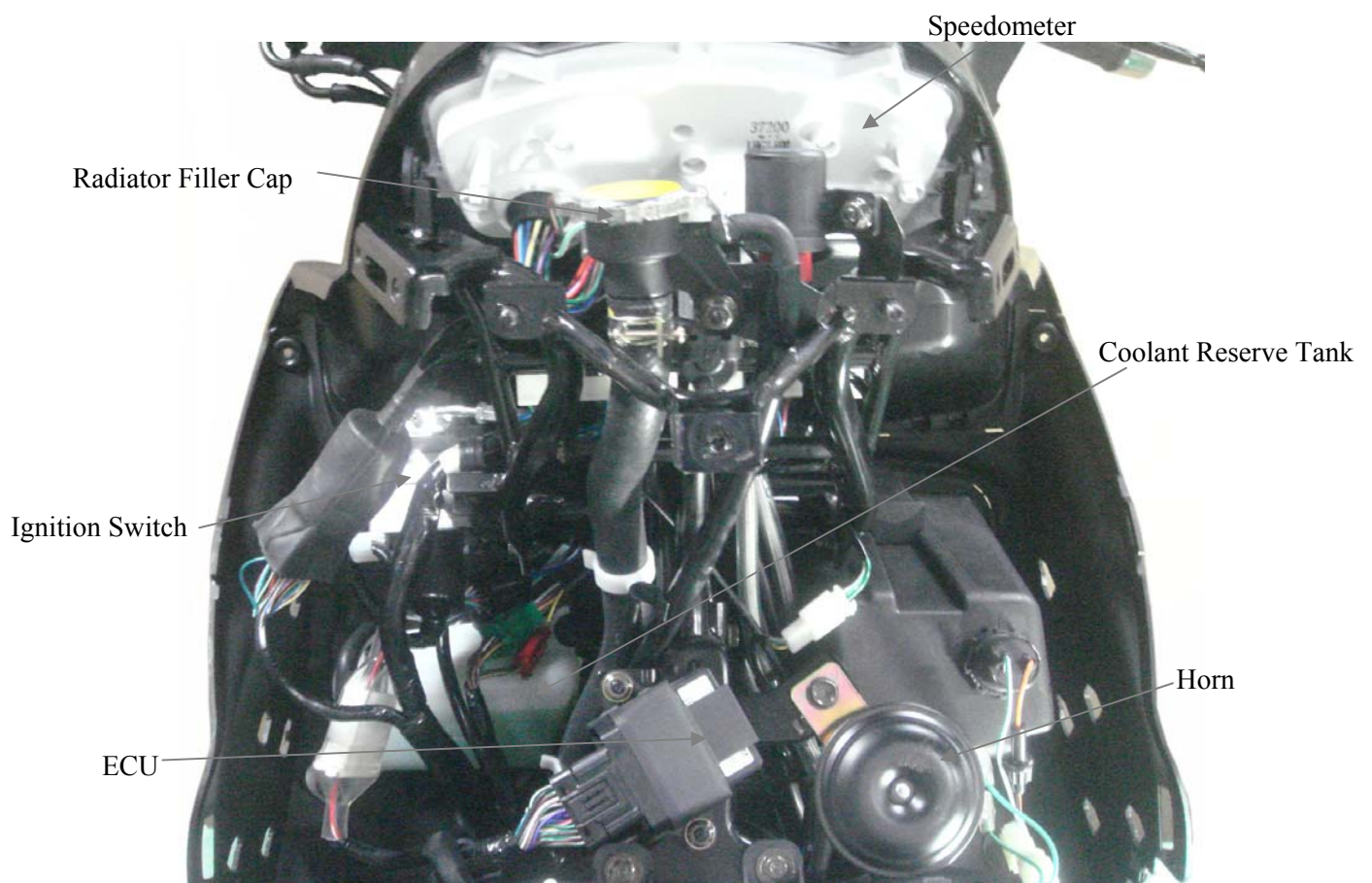

INSPECTION

Disconnect and remove the ECU from the frame.

Check for continuity between pin 9 and 10 of the ECU side connector.

There should be continuity at all times.

Check for continuity between each pins 2, 4 and 23 of the ECU side connector.

There should be continuity at all times.

Check for continuity between pin 24 and 10 of the ECU side connector.

There should be no continuity at all times.

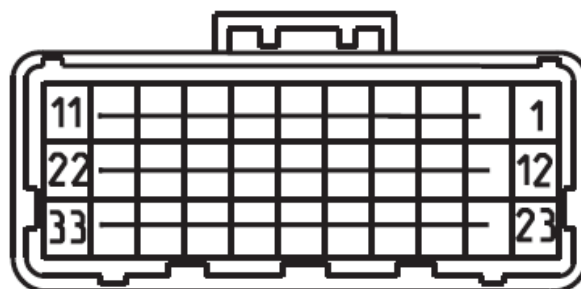

ECU PIN FUNCTION

PIN NO.	NAME	FUNCTION	PIN NO.	NAME	FUNCTION
01	IGP	IGNITION POWER	19	FLPR	FUEL PUMP RELAY
02	LGI	LOGIC GROUND 1	20	ISCBP	IDEL SPEED CONTROL B
03	HEGO	HEGO SENSOR	21	ISCAP	IDEL SPEED CONTROL A
04	SG	SENSOR GROUND	22	HEGO HT	HEGO SENSOR HTATER
05	TH	THROTTLE POSITION SENSOR	23	CRK-M	CRANK PULSE SENSOR GND
06	VCC	SENSOR POWER OUTPUT(+5V)	24	TW	WATER TEMP. SENSOR
07	BATT	BATTERY	25	-	-
08	FAN	FAN RELAY	26	ROLL	ROLL SENSOR
09	PG1	POWER GROUND 1	27	PM	MANIFOLD PRESSURE SENSOR
10	PG2	POWER GROUND 2	28	SOL	-
11	IG	IGNITION COIL	29	-	-
12	CRK-P	CRANK PULSE SENSOR	30	K-LINE	DIAGNOSTIC TOOL
13	-	-	31	ISCBN	IDEL SPEED CONTROL / B
14	-	-	32	ISCAN	IDLE SPEED CONTROL / A
15	TEST	-	33	NE	METER
16	INJ	INJECTION			
17	-	-			
18	MIL	MULTI INDICATOR LAMP			

FUEL INJECTOR

INSPECTION

Disconnect the fuel injector connector.
Measure the resistance between 2 pins of the fuel injector connector.

Standard: $11.7 \pm 0.6 \Omega$ (at 20°C/68°F)

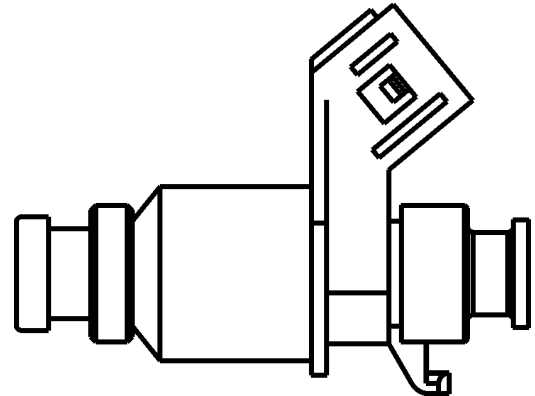

REMOVAL

Disconnect the connector from the fuel injector.
Remove the bolt of the fuel injector.
Take out of the fuel pipe and fuel injector from the Inlet pipe.
Remove the fuel injector from the fuel pipe.



Bolt

Connector

*

Ensure the fuel pipe without any pressure, then remove the fuel injector.
STEP 1: Disconnect the fuel pump relay or fuel pump connector.
STEP 2: Turn the key to the ON position. Starting the engine till the engine stop working.

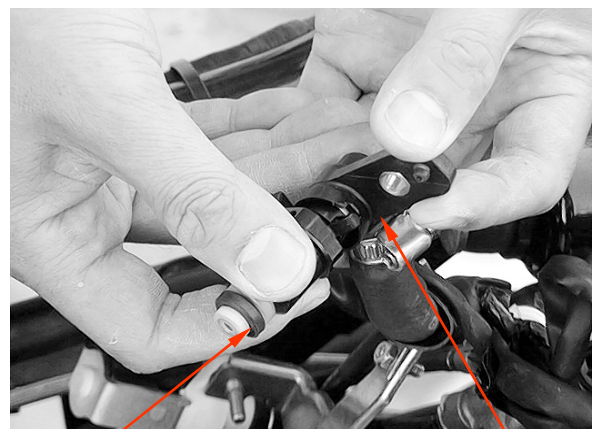

O-ring

Fuel Injector

INSTALLATION

Apply the engine oil to a new O-ring.
Install the fuel injector into the fuel pipe.
Ensure the tab of the fuel injector inserted into the groove of the fuel pipe.

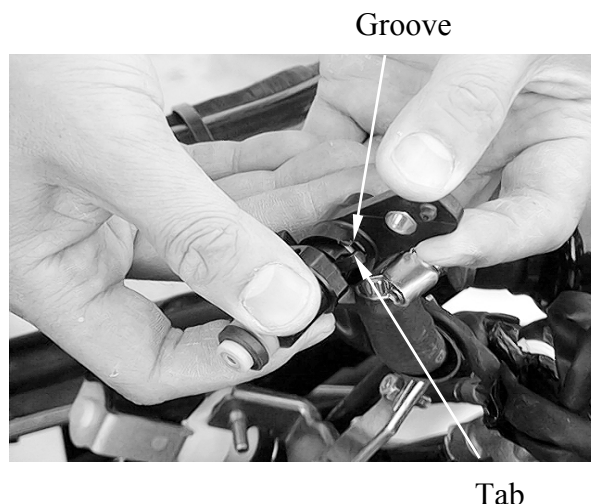

Install the fuel pipe into the intake manifold by aligning the dowel pin.
Be careful not to damage the O-ring.
Tighten the fuel pipe mounting bolt.

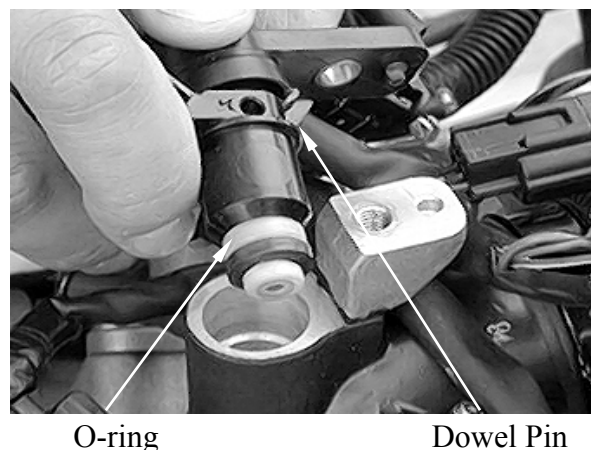

FUEL INJECTOR CLEANING

PROBLEM

1. Fuel Injector cannot output the fuel.
2. The Injector injection time (ms) is shorter or longer.

Standard: < 1.6ms

ANALYSIS

Injector block (With some carbons).

TROUBLESHOOTING

1. Use the specified injector cleaner.
2. Pouring the liquid of carburetor cleaner until half container.
3. Connect the battery as picture.
4. The injector cleaner with the flash relay.
5. Keeping the fuel Injector operation.
6. Waiting for 20~30 minutes.
7. Cleaning the carbons completely.

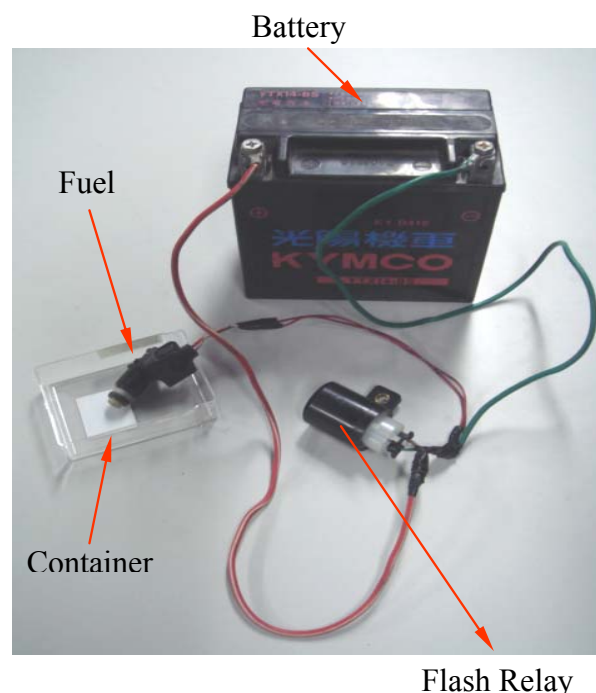

WTS SENSOR (Water Temperature Sensor)

REMOVAL / INSTALLATION

Drain the coolant from the cooling system.
 Disconnect the WTS sensor connector from the sensor.
 Remove the WTS sensor and O-ring.



Install a new O-ring and WTS sensor.

* Always replace an O-ring with a new one.

Tighten the WTS sensor to the specified torque.

Torque: 1.2 kgf-m (12 N-m, 8.6 lbf-ft)

Connect the WTS sensor connector.

Fill the cooling system with the recommended coolant.

INSPECTION

Measure the resistance at the WTS sensor terminals.

STANDARD

°C	-20	40	100
KΩ	18.8	1.136	0.1553

WTS Sensor

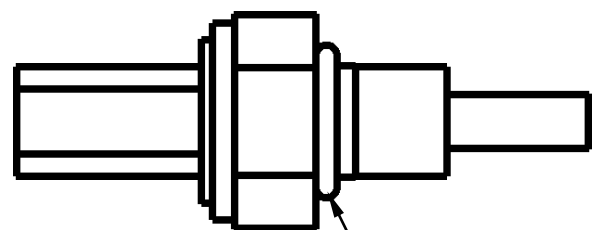

O-ring

O² SENSOR

The O² sensor issues signal to ECU when the temperature is over 350°C during the engine is working.

The temperature is up to 350°C earlier than the muffler for O² heater sensor. So the O² sensor begins performance.

The function of O² sensor only controls the fuel injector operation.

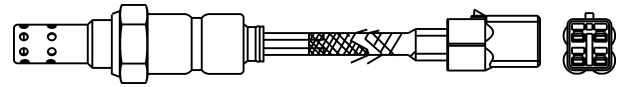

INSPECTION

Disconnect the O² sensor connector.

Measure the resistance between each White wire terminals of the O² sensor side connector.

Standard: 7.7±1.2 Ω (at 20°C/68°F)

REMOVAL/INSTALLATION

Disconnect the O² sensor connector and then remove it from exhaust muffler.

Installation is in the reverse order of removal.

*

Apply anti-seize compound on the surface of thread area before O² sensor

Tighten the O² sensor to specified torque.

Torque: 2.5 kgf-m (25 N-m, 18 lbf-ft)

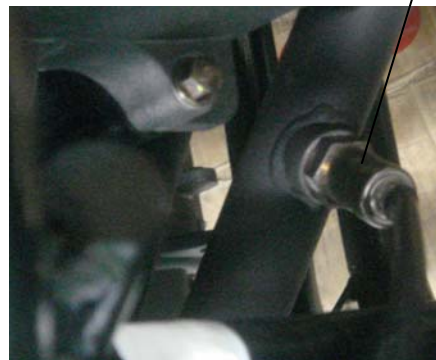

O2 Sensor

THROTTLE BODY/MAP/ISC/TPS

- Turn off the ignition switch while replacement.
- Check and confirm if the voltage is over 12V by a voltmeter after replacement.
- Check and confirm if the other connectors are installed correctly after replacement.
- Do not damage the throttle body, it may cause the throttle and idle valve isn't synchronization.
- The throttle body is preset in KYMCO factory, do not disassemble it by a wrong way.
- Do not loosen or tighten the painted bolts and screws for the throttle body. Loosen or tighten them can cause the throttle and idle valve to synchronization failure.
- **TPS and ISC have to be reset after the throttle body MAP, TPS, ISC or ECU has been reinstalled.**

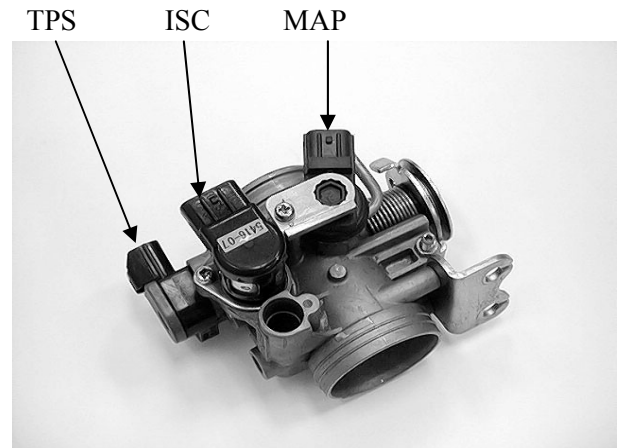

MAP INSPECTION

Support the scooter on a level surface.
Put the side stand up and engine stop switch is at "RUN".

Turn the ignition switch to "ON" position.

Measure if the ECU voltage outputs to the MAP between the following terminals of the MAP connector.

Terminal	Normal
Violet/Red (+) – Green/Pink (-)	5 V

TPS INSPECTION

Support the scooter on a level surface.
 Put the side stand up and engine stop switch is at "RUN".
 Turn the ignition switch to "ON".
 Measure if the ECU voltage outputs to TPS between the following terminals of the TPS connector.

Terminal	Normal
Violet/Red (+) – Green/Pink (-)	5 V

Throttle position sensor (TPS) resistance (at 20°C/68°F) 3500~6500 Ω

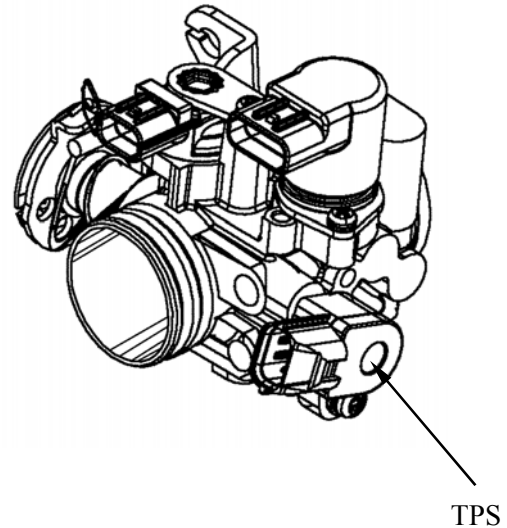

REMOVAL

Loosen the throttle cables with the adjusting nuts.
 Disconnect the throttle cable ends from throttle seat.

Cable Ends



Adjusting Nuts

ISC Sensor TPS Sensor

Disconnect the TPS, ISC and MAP sensor connectors.
 Loosen the air cleaner connecting hose band screw.
 Loosen the intake manifold band screw.
 Remove the throttle body, MAP sensor, TPS sensor and ISC sensor as a set.



MAP Sensor

DISASSEMBLY

* _____

The throttle position sensor (TPS) and idle air bypass valve (ISC) have to be reset when the throttle body MAP, TPS, ISC or ECU has been reinstalled.

Remove the screw and then remove the ISC and set plate.

Remove the screw and set plate.

Remove the MAP

Remove the screw AND then remove the TPS.

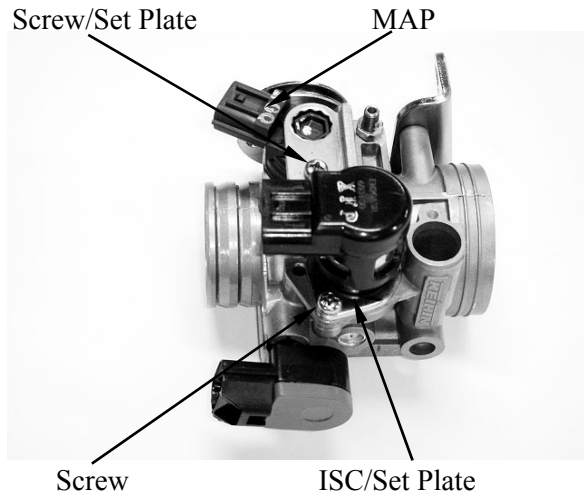

ASSEMBLY

* _____

The throttle position sensor (TPS) and idle air bypass valve (ISC) have to reset when the throttle body MAP, TPS, ISC or ECU has been reinstalled.

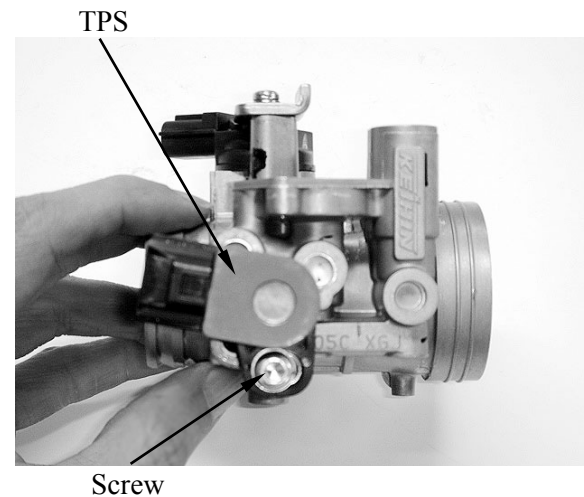

Apply oil onto a new O-ring.

When install the TPS onto the throttle body, being careful not to damage the O-ring.

Install and tighten the screw securely.

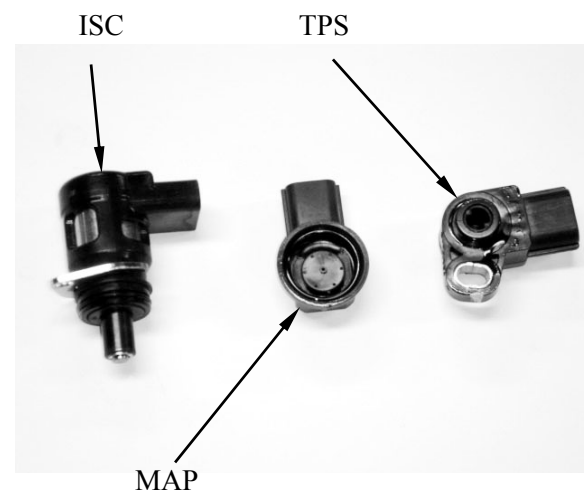

Apply oil onto a new O-ring.

When install the MAP onto the throttle body, being careful not to damage the O-ring.

* Always replace an O-ring with a new one.

Install the set plate and tighten the screw securely.

Apply oil onto a new O-ring.

When install the ISC and set plate onto the throttle body, being careful not to damage the O-ring.

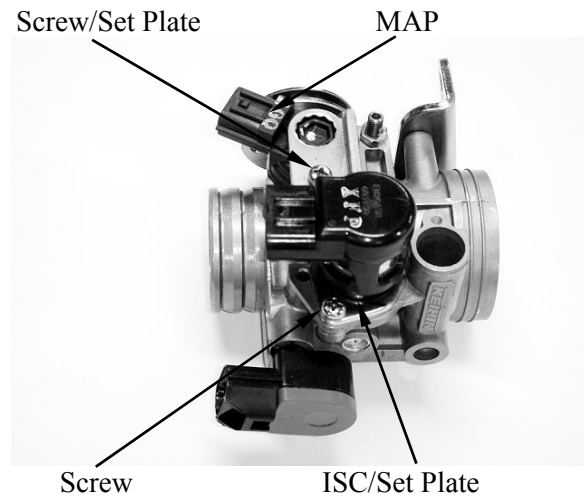
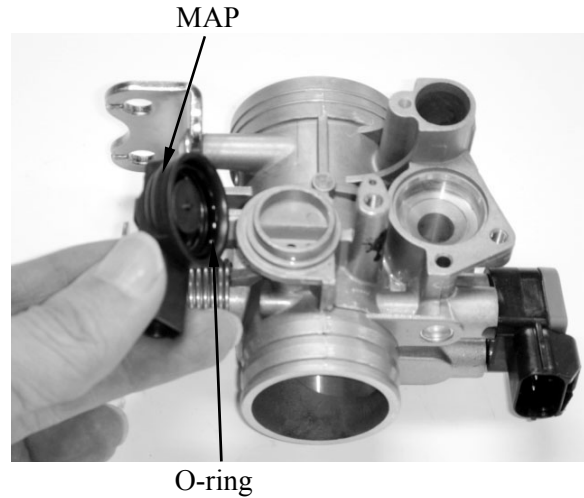

DIAGNOSTIC TOOL CONNECTOR

INSPECTION

Put the side stand up and engine stop switch is at "RUN".

Turn the ignition switch to "ON"

Measure the voltage between the following terminals of the diagnostic tool connector with PDA tester.

Terminal	Normal
Black (+) – Green (-)	Battery voltage
White/Yellow (+) – Green (-)	Battery voltage - 1 V

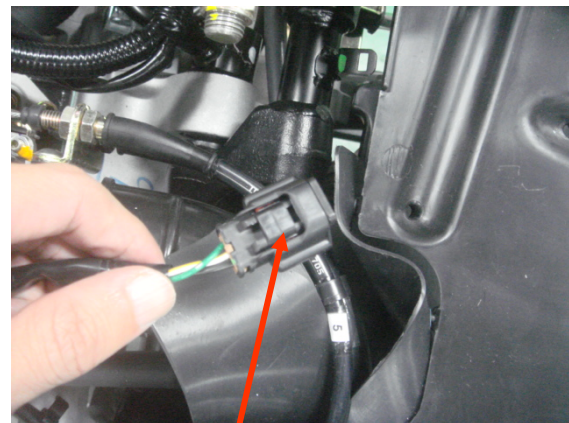

Diagnostic Connector



FI DIAGNOSTIC TOOL OPERATION INSTRUCTIONS 3620A-LEB2-E00

1. FI DIAGNOSTIC TOOL

- This tool is developed by KYMCO and for KYMCO vehicle only.
- Please refer to the specification when serving this vehicle.
- This tool is without battery inside. The power is provided from vehicle.
- This software can be updated with computer for new model through the USB cable. The power required of tool is connected with 12V battery.
- For connection, please connect this tool with the connector of ECU. It's available when turning on the ignition switch.
- The side stand must be upward when serving the diagnostic procedure.
- The function includes ECU version, model name, data analysis and reset.
 - ECU version: includes model name, ECU number, identifications number and software version.
 - Failure codes: DTC reading, DTC clearing and troubleshooting.
 - Data analysis: For ECU's software inspection.
 - Reset: For the setting function adjustment.



13. FUEL INJECTION SYSTEM

2. DTC INSPECTION PROCEDURE

Showing four functions on the screen when switching on power.



LHG7 is for G-Dink 300i

A). ECU version: Including of model name, ECU number, identifications number and software version.

Press the " Enter " button

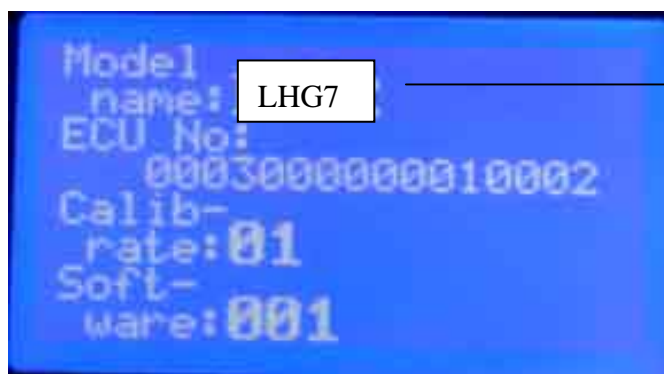

LHG7 is for G-Dink 300i

B). Press the " Down " button and then turn to the first page.



LHG7 is for
G-Dink 300i

C). Press the " Enter " button to check the DTC failure code



LHG7 is for
G-Dink 300i

13. FUEL INJECTION SYSTEM

D). Press the " Enter " button

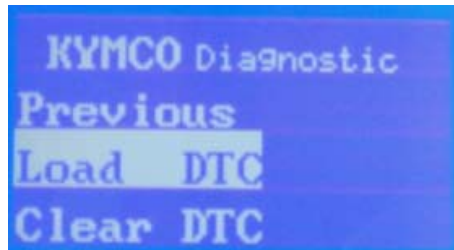

E). Press the " Enter " button

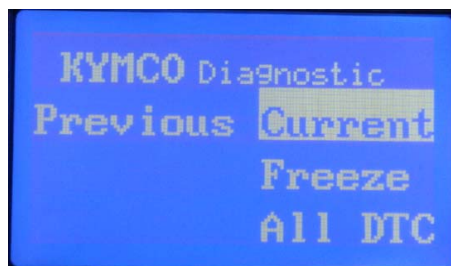

F). Display what's DTC number on this DTC-List.

Press the " Enter " button and then turn to the previous page



13 . FUEL INJECTION SYSTEM

G). Press the " UP " button

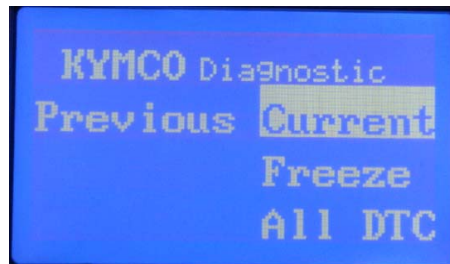

H). Press the " Enter " button and then turn to the previous page with red color.

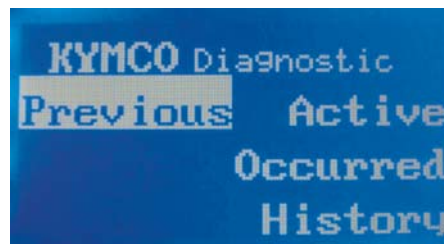

I). Press the " UP " button

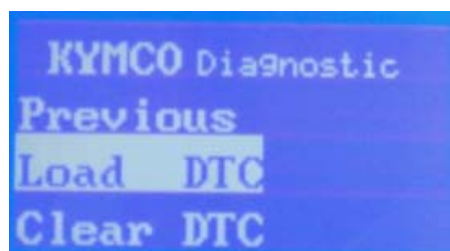

13. FUEL INJECTION SYSTEM

J). Press the " Enter " button and then turn to the first page.

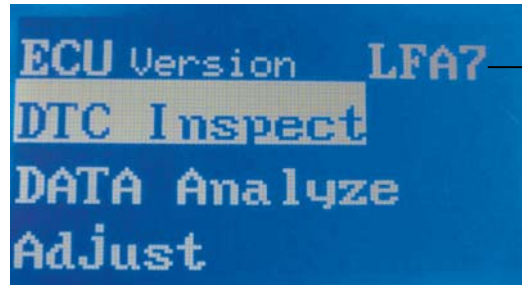

LHG7 is for
G-Dink 300i



LHG7 is for
G-Dink 300i

13. FUEL INJECTION SYSTEM

3. DTC CLEAR PROCEDURE

A). Check the DTC



LHG7 is for
G-Dink 300i

B). Press the " Enter " button



LHG7 is for
G-Dink 300i

C). Choose " Load DTC "
Press the " Down " button

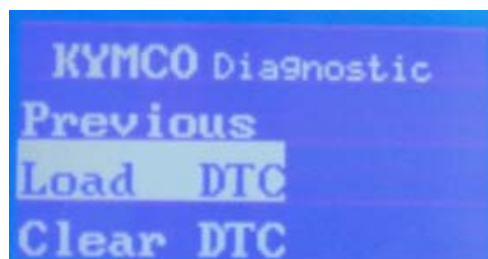

13. FUEL INJECTION SYSTEM

D). Press the " Enter " button and the indicator is lighting.

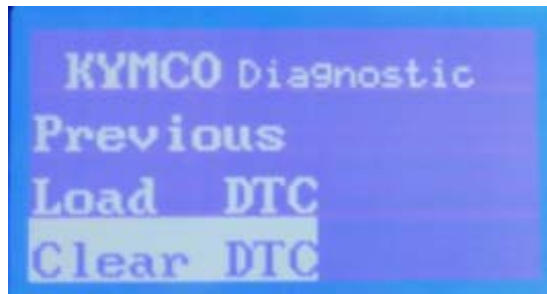

E). Clearing DTC completed if the indicator is off.

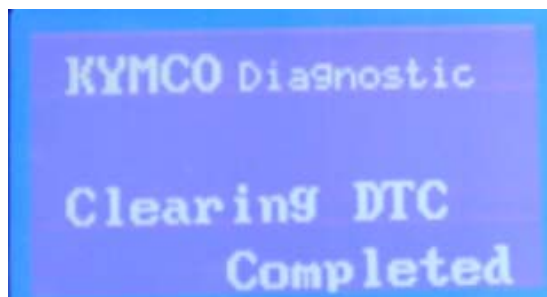

13. FUEL INJECTION SYSTEM

4. DATA ANALYSIS PROCEDURE

A). Press the " Down " twice



LHG7 is for
G-Dink 300i

B). Choose " Data Analyze"

Press the " Enter " button to enter page 01

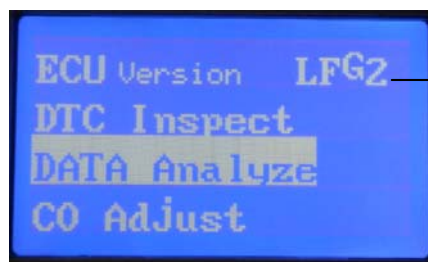

LHG7 is for
G-Dink 300i

C). Down-page 01

The measure figures including of Engine speed, Battery voltage and DTC number.

Press the " Down " button to enter page 02.



13 . FUEL INJECTION SYSTEM

D). Down-page 02

The measure figures including of TPS position, Intake pressure and Intake air temperature.

Press the “ Down” button to enter page 03.



E). Down-page 03

The measure figures including of Atmosphere pressure, Fuel Injector interval and Ignition advance timing.

Press the “ Down” button to enter page 04.

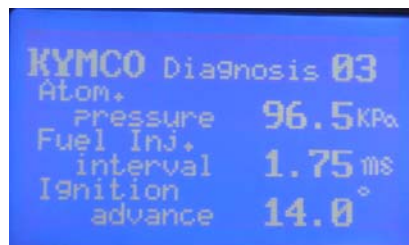

F). Down-page 04

The measure figures including of Engine temperature, O2 sensor voltage and O2 heater activation.

Press the “ Down” button to enter page 05.



13 FUEL INJECTION SYSTEM

G). Down-page 05

The measure figures including of ISC target, ISC step and ISC learn step.

Press the " Down" button to enter page 06.



H). Down-page 06

The measure figures including of ISC motor state.

Press the " Down" button to enter page 07.



I). Down-page 07

The measure figures including of Cut Out voltage.



J). Press the " UP " to the previous page.

5. Vehicle can not be started – Handling method (Steps)

Preliminary Checking: 6 basic inspection

1. Is the battery with voltage (12 V or higher)
2. Key-On and listen for any action with Fuel Pump / Fuel Pump Relay (It will turn off automatically in 5-10 seconds)
3. Key-On to check for any failure lamp light up on dashboard.
4. Is the Idle screw of Throttle Valve being changed or loose?
5. Has the vehicle under regular service? Is the gas station a good one?
6. Is the spark plug the correct model of specified by the vehicle builder?

Vehicle can not be started?

Check for any Failure code. (Failure Lamp on / How to tell the Failure code?)

Turn on power to see if the engine inspection / failure lamp off?

If it flashes continuously or light up for long time, the vehicle is at failure -> read the Failure Code?

Methods:

1. Reading DTC from speedometer, if PDA or diagnosis tool is not available.
2. Reading DTC from Diagnosis tool, if it is available.

6. Manual Trouble Shooting Procedure

How to read DTC from speedometer?

New Phase 5 Fuel Injection Engine Vehicle DTC Reading:

Automatic indication – ECU upgrade version (with Oxygen sensor):
Reading DTC from speedometer directly.

Key On → light off in 2 seconds. When the engine inspection lamp is light up again, it starts to deliver failure code. If no show, there is without any failure.

Note:

1. The “CELP” denotes the failure codes. When the indicator lights for 1 second it is equivalent 10 blinks. For example, a 1 second illumination and two blinks (0.5 second x 2) of the indicator equals 12 blinks. Refer to DTC 12.
2. If more than one failure occurs, the “CELP” shows the blinks in the occurred order. For example, if the indicator blinks 6 times, then shows one second illumination and two blinks, two failures have occurred. Refer to DTC 6 and DTC 12.

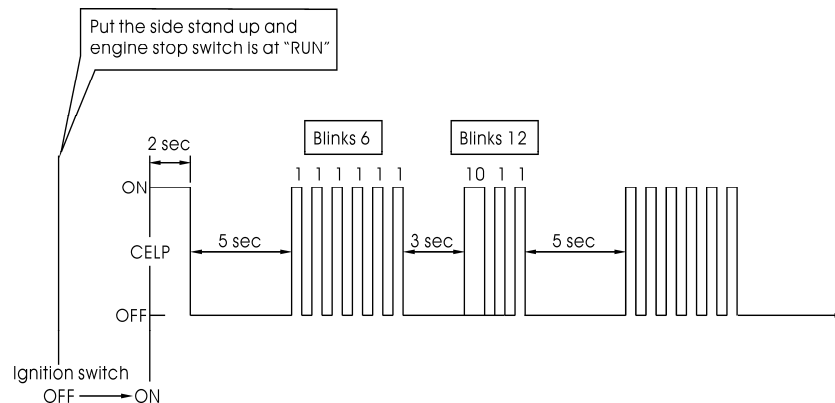

After excluding trouble, how the DTC can be cleared? Confirm the failure is excluded.

- Turn on power but maintain not started and keep the engine inspection lamp light up for 4 cycles. If it is off automatically, it means the historical DTC is cleared automatically.
- Use PDA or diagnosis tool: clear Historical Failure code
- Check again to confirm DTC is excluded.
Turn on power again. When there is no residual historical failure cod. Start the engine and if no failure lamp is on or flashing, it is Okay.

**HANDLEBAR/FRONT WHEEL/FRONT BRAKE/
FRONT SHOCK ABSORBER/STEERING STEM**

SERVICE INFORMATION-----	14- 1
TROUBLESHOOTING-----	14- 2
HANDLEBAR -----	14- 3
FRONT WHEEL -----	14- 6
FRONT BRAKE FLUID-----	14- 9
FRONT BRAKE PAD -----	14-11
BRAKE DISC INSPECTION -----	14-12
FRONT SHOCK ABSORBER-----	14-13
STEERING STEM-----	14-14

SERVICE INFORMATION

GENERAL INSTRUCTIONS

- Remove the motorcycle frame covers before removing the front wheel, steering handlebar, front shock absorber and front fork. Jack the motorcycle front wheel off the ground and be careful to prevent the motorcycle from falling down.
- During servicing, keep oil or grease off the brake pads and brake disk.

TORQUE VALUES

Handlebar post	6.0~7.0 kgf-m
Steering stem lock nut	6.0~6.5 kgf-m
Front axle	1.5~2.5 kgf-m
Brake caliper mounting bolt	3~4 kgf-m
Brake caliper bleed screw	0.4~0.7 kgf-m

TROUBLESHOOTING

Hard steering (heavy)

- Excessively tightened steering stem top cone race
- Broken steering balls
- Insufficient tire pressure

Steers to one side or does not track straight

- Uneven front shock absorbers
- Bent front fork
- Bent front axle or uneven tire

Poor brake performance

- Worn brake pads
- Contaminated brake pad surface
- Deformed brake disk
- Air in brake system
- Deteriorated brake fluid
- Worn brake master cylinder piston oil seal
- Clogged brake fluid line
- Unevenly worn brake caliper

Front wheel wobbling

- Bent rim
- Loose front axle
- Bent spoke plate
- Faulty tire
- Improperly tightened axle nut

Soft front shock absorber

- Weak shock springs
- Insufficient damper oil

Front shock absorber noise

- Slider bending
- Loose fork fasteners
- Lack of lubrication

HANDLEBAR

REMOVAL

Remove the lower handlebar cover and front cover.

Remove two bolts and disconnect the brake light switch wire, then remove the rear brake master cylinder.

Remove the two bolts and disconnect the brake light switch wire, then remove the front brake master cylinder.

Remove the inner cover.



Remove the handlebar lock nut and take out the bolt.
Remove the handlebar.

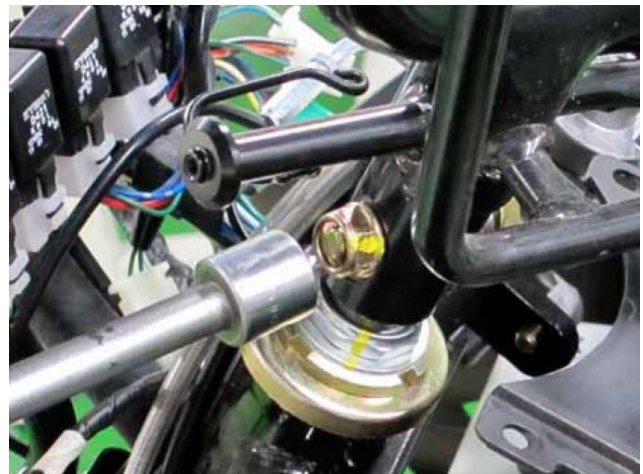

INSTALLATION

Install the handlebar onto the steering stem and install the handlebar, lock nut and bolt. Tighten the bolt to the specified torque.

Torque: 4.5 kgf-m (45 N-m, 32 lbf-ft)

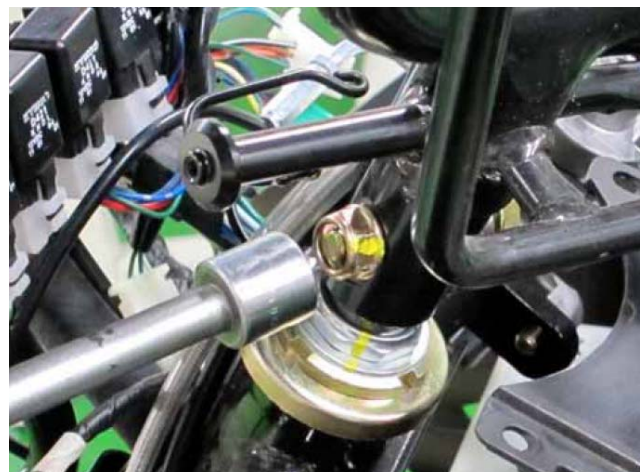

Install the front and rear master cylinders and connect the brake light switch wires.



DISASSEMBLY

Remove two screws attaching to the right handlebar switch.



Disconnect the throttle cable from the throttle grip.
Remove the right handlebar switch.

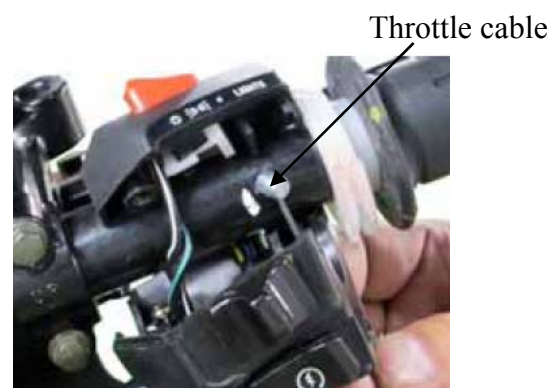

Remove two screws and then remove the left handlebar switch.



ASSEMBLY

Install the left handlebar switch.

* Align the pin on the left handlebar switch with the hole on the handlebar.

Install and tighten the two screws securely.

Install the right handlebar switch.

* Align the pin on the right handlebar switch with the hole on the handlebar.



Lubricate the throttle grip front end with grease and then connect the throttle cable to the throttle grip.

Install and tighten the two screws.

FRONT WHEEL

REMOVAL

Jack the scooter front wheel off the ground.
Remove the bolt and then pull out the axle.
Remove the front wheel and collar.



AXLE RUNOUT INSPECTION

Set the axle in V blocks and measure the runout using a dial gauge.

The actual runout is 1/2 of the total indicator reading.

Service Limit: 0.2 mm (0.008 in)

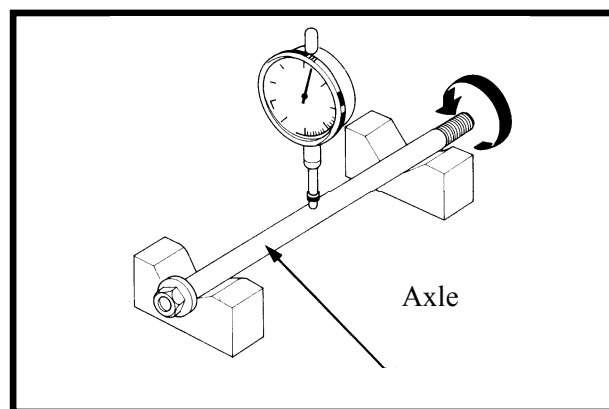

WHEEL RIM INSPECTION

Check the wheel rim runout.

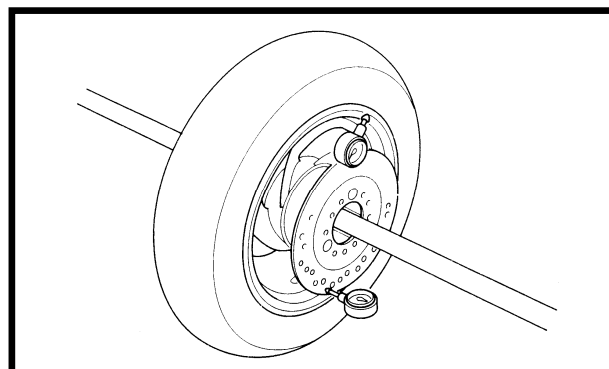

INSTALLATION

Apply grease to the collar, then install the collar onto the wheel.



Dust Seal

DISASSEMBLY

Remove the side collar and dust seal.

Turn the inner race of each bearing with your finger to see if they turn smoothly and quietly. Also check if the outer race fits tightly in the hub.

Replace the bearings if the races do not turn smoothly, quietly, or if they fit loosely in the hub.

Remove the front wheel bearing.



Remove the distance collar from wheel.

FRONT BRAKE FLUID

**FLUID REPLACEMENT/AIR
BLEEDING**

- * —————
- A contaminated brake disc or pad reduces stopping power. Discard contaminated pads and clean a contaminated disc with a high quality brake degreasing agent.
 - Do not allow foreign material to enter the system when filling the reservoir.
 - Avoid spilling brake fluid on painted, plastic or rubber parts. Place a rag over these parts whenever the system is serviced.



BRAKE FLUID DRAINING

Make sure that the master cylinder parallel to the ground before removing the reservoir cover.

Remove two screws.

Remove the reservoir cover, diaphragm plate and diaphragm.

Connect a bleed hose to the bleed valve.



Loosen the bleed valve and apply the brake lever.

Stop operating the brake when no more fluid flows out of the bleed valve.

BRAKE FLUID FILLING/AIR BLEEDING

* Do not mix different types of fluid since they are not compatible.

Fill the master cylinder with DOT 4 to the upper level.

Connect a commercially available brake bleeder to the front caliper bleed valve.

Check the fluid level often while bleeding the brake to prevent air from being pumped into the system.

Pump the brake bleeder and loosen the front caliper bleed valve. Add fluid when the fluid level in the master cylinder is low to prevent drawing air into the system.

Repeat the above procedures until no air bubbles appear in the plastic hose.

Close the front caliper bleeding valve and operate the front brake lever.

If it's still spongy, bleeding the system again.

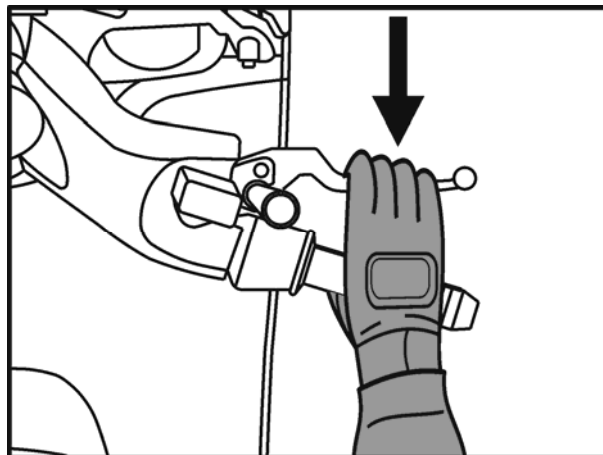

If the brake bleeder is not available, perform the following procedure.

Pump up the system pressure with the brake lever until there are no air bubbles in the fluid flowing out of the reservoir small hole and lever resistance is felt.

1. Pump the brake lever several times, then squeeze the brake lever all the way and loosen the bleed valve 1/4 turn. Wait several seconds and close the bleed valve.

* Do not release the brake lever until the bleed valve has been closed.

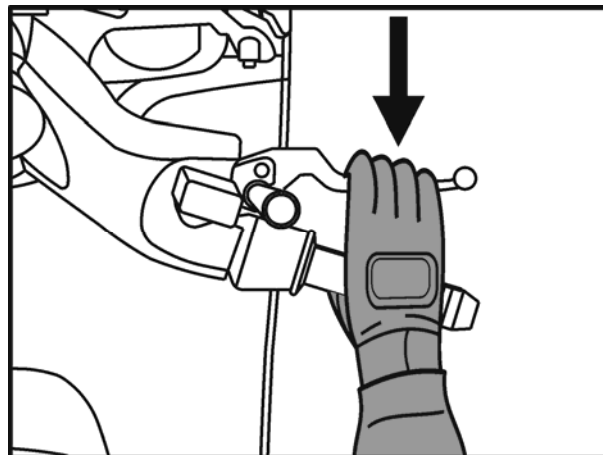

2. Release the brake lever slowly until the bleed valve has been closed. Add fluid when the fluid level in the master cylinder is low to prevent drawing air into the system.
3. Repeat the steps 1 - 2 until there are no air bubbles in the bleed hose.



After bleeding air completely, tighten the bleed valve to the specified torque.

Torque: 6 N-m (0.6 kgf-m, 4.3 lbf-ft)

Fill the reservoir to the casting ledge with DOT 4 to the upper level.

Install the diaphragm, set plate and reservoir cover and tighten the screws to the specified torque.

Torque: 2 N-m (0.2 kgf-m, 1.1 lbf-ft)

FRONT BRAKE PAD

BRAKE PAD REPLACEMENT

Remove the caliper mounting bolts, then remove the caliper.



Brake Pads

Remove the brake pads.



* Always replace the brake pads in pairs to ensure even disc pressure.

14.HANDLEBAR/FRONT WHEEL/FRONTBRAKE/ FRONT SHOCK ABSORBER/STEERING STEM

Install new pads so that their ends rest on the pad retainer on the brake properly.

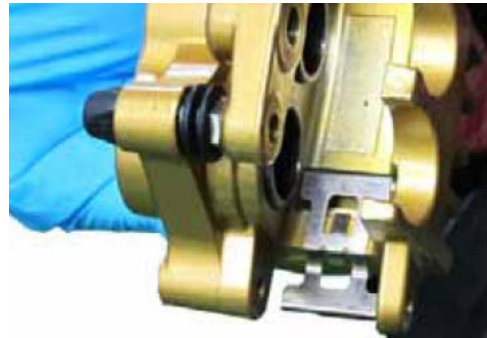

Install the front caliper onto the fork leg and then install and tighten the new two caliper mounting bolts to the specified torque.

Torque: 35 N-m (3.5 kgf-m)

Tighten the pad pins to the specified torque.

Torque: 18 N-m (1.8 kgf-m, 13 lbf-ft)



BRAKE DISC INSPECTION

ITEM		STANDARD	SERVICE LIMIT
Brake disc thickness	Front	5±0.1mm (0.2±0.004in)	4.0mm (0.16in)
	Rear	4±0.2mm (0.16±0.004in)	3.5mm (0.14in)



FRONT SHOCK ABSORBER

REMOVAL

Remove the front cover and front fender.
Remove the front brake caliper
Remove the front wheel
Remove the speed wheel sensor bolt and then remove the brake hose guide from right front shock absorber.
Remove two mounting bolts and then remove the right/left front shock absorber.



INSTALLATION

Installation is in the reverse order of removal.

- * Tighten the shock absorber mounting bolt to the specified torque.
- Torque: 2.7 kgf-m (27 N-m, 19.5 lbf-ft)**

INSPECTION

Inspect the following items and replace if necessary.

- Front shock absorber tube bending, damage or wear
- Weak front shock absorber spring
- Damper and damper rod bending
- Oil seal damage or wear



STEERING STEM

REMOVAL

Remove the steering handlebar.
Remove the front brake hose and speed wheel sensor connector from the guide.

Hold the steering stem top cone race and remove the steering stem lock nut by using the special tool.

Special tool:

Lock nut wrench F00002



Lock Nut Wrench



Remove the top cone race and washer.
Remove the steering stem.



14. HANDLEBAR/FRONT WHEEL/FRONT BRAKE/ FRONT SHOCK ABSORBER/STEERING STEM

Inspect the ball races, cone races and steel balls for wear or damage. Replace if necessary.

Remove the top balls.

Remove the upper ball race by using a chisel if necessary.

Ball

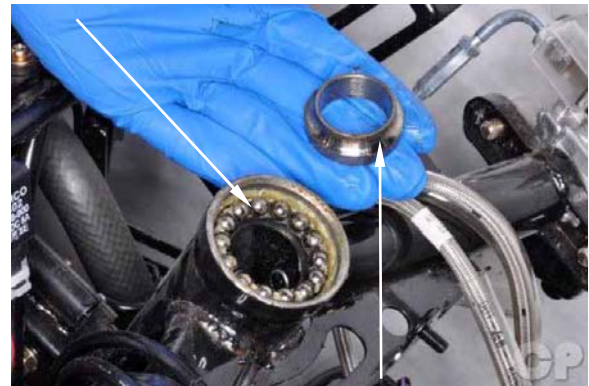

Top Ball Cone Race

Remove the bottom balls.

Remove the bottom ball race.



Remove the bottom cone race by using a chisel if necessary.

* Be careful not to damage the steering stem.



Install with reverse operation.

15. REAR BRAKE/REAR FORK/REAR WHEEL/REAR SHOCK ABSORBER



G-DINK 300i

REAR BRAKE/REAR FORK/REAR WHEEL/ REAR SHOCK ABSORBER

SCHEMATIC DRAWING-----	15-1
SERVICE INFORMATION-----	15-2
TROUBLESHOOTING-----	15-2
REAR BRAKE-----	15-3
REAR FORK-----	15-6
REAR WHEEL-----	15-7
REAR SHOCK ABSORBER-----	15-7

15. REAR BRAKE/REAR FORK/REAR WHEEL/REAR SHOCK ABSORBER



G-DINK 300i

SCHEMATIC DRAWING

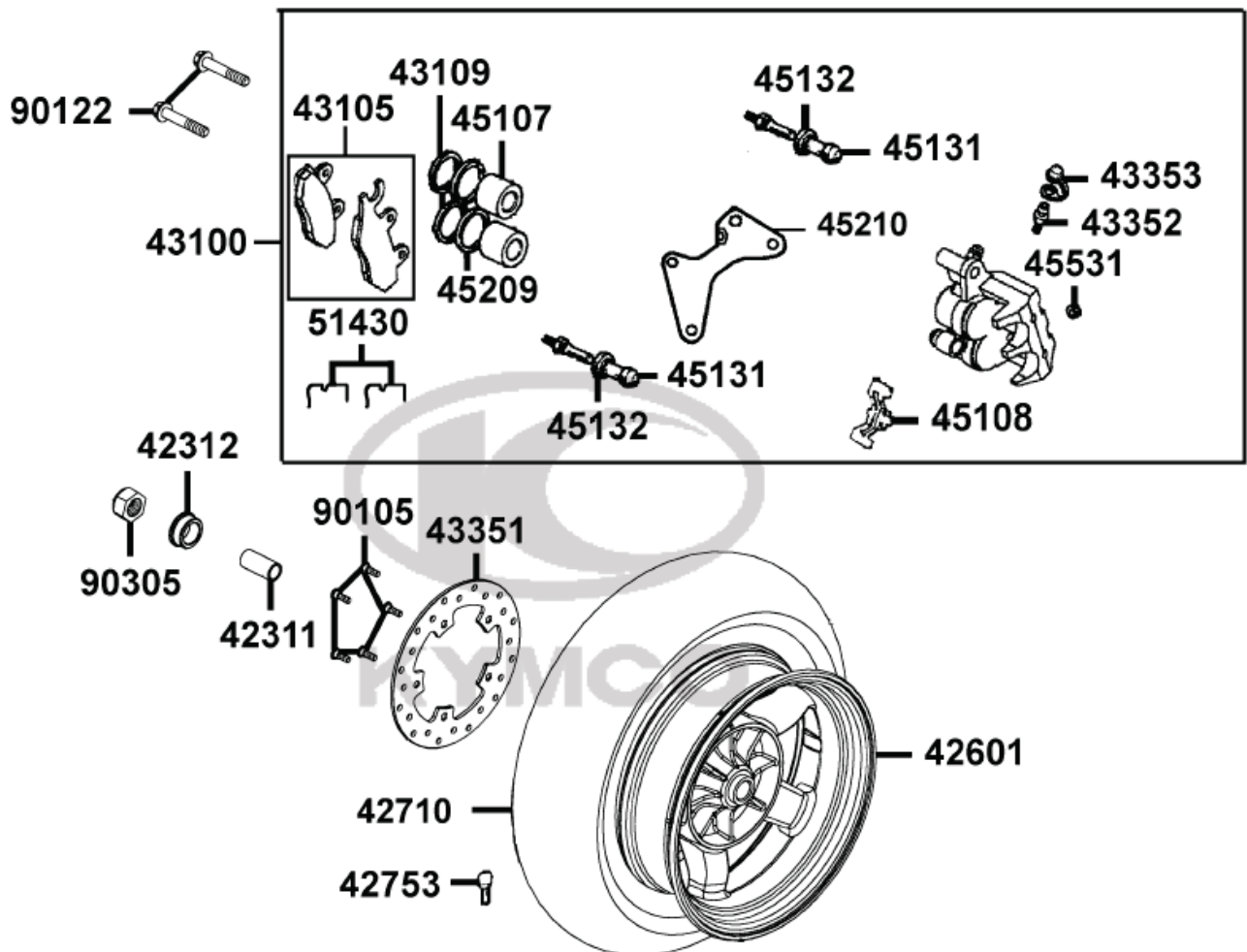

15. REAR BRAKE/REAR FORK/REAR WHEEL/REAR SHOCK ABSORBER



G-DINK 300i

SERVICE INFORMATION

GENERAL INSTRUCTIONS

- When performing the services stated in this section, the engine and exhaust muffler must be cold to avoid scalding.
- During servicing, keep oil or grease off the brake pads and brake disk.

SPECIFICATIONS

Item	Standard (mm)	Service Limit (mm)
Rear wheel rim runout	—	
Rear brake disk thickness	4.0	
Rear brake disk runout	—	

TORQUE VALUES

Exhaust muffler pipe nuts	1.8~2.2 kgf-m
Exhaust muffler brake /RR Fork	3.2~3.8 kgf-m
RR fork/Engine case	2.4~3.0 kgf-m

TROUBLESHOOTING

Rear wheel wobbling

- Bent rim
- Faulty tire
- Axle not tightened properly

Soft rear shock absorber

- Weak shock absorber spring
- Damper oil leaks

Rear wheel noise

- Worn rear wheel axle bearings
- Worn rear fork bearings
- Deformed rear fork

Poor brake performance

- Air in brake system
- Deteriorated brake fluid
- Contaminated brake pad surface
- Worn brake pads
- Clogged brake fluid line
- Deformed brake disk
- Unequal worn brake caliper

15. REAR BRAKE/REAR FORK/REAR WHEEL/REAR SHOCK ABSORBER

REAR BRAKE

REAR BRAKE CALIPER REMOVAL

First remove the exhaust muffler.
Remove the rear brake fluid tube bolt and disconnect the brake fluid tube.
Remove two bolts attaching the rear brake caliper.
Remove the rear brake caliper.

* When removing the brake fluid tube, use shop towels to cover plastic parts and coated surfaces to avoid damage.

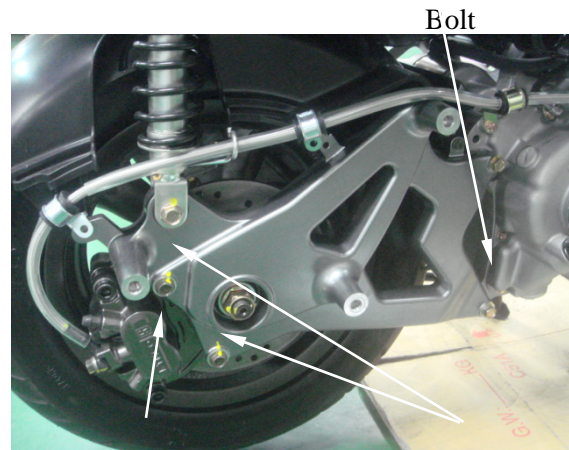

Brake Caliper

Bolts

INSPECTION

Inspect the brake pads and brake disk.

Measure the brake disk thickness.

Visually check the brake pad thickness

Brake Disk



DISASSEMBLY

Remove two brake pads dowel pins and three bolts from the brake caliper.

Remove the brake pads.

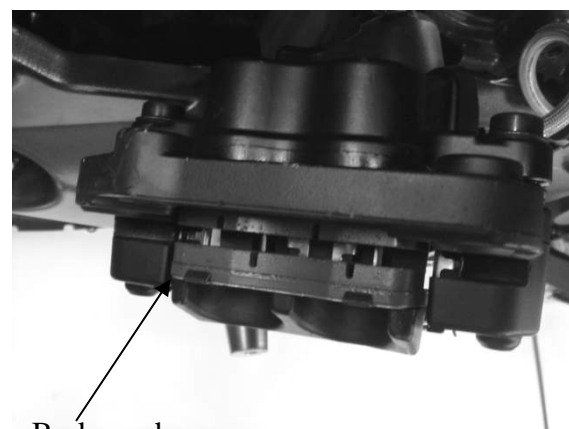

Brake pads

15. REAR WHEEL/REAR BRAKE/ REAR SUSPENSION

Remove the piston from the brake caliper.
If necessary, use compressed air to squeeze out the piston through the brake fluid inlet opening and place a towel under the caliper to avoid contamination caused by the removed piston.
Check the piston cylinder for scratches or wear and replace if necessary.

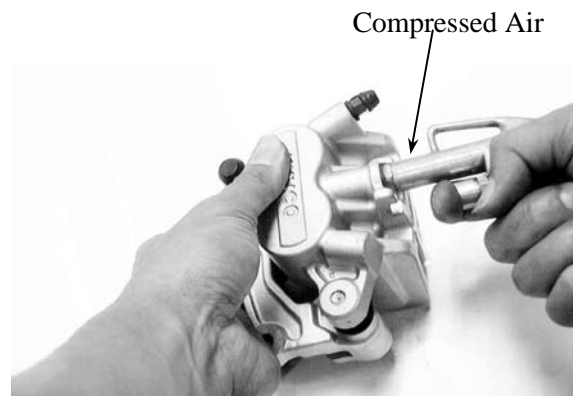

Check the caliper cylinder for scratches or wear and measure the cylinder bore.



ASSEMBLY

Install the two spring plates onto the groove of the caliper.



15. REAR WHEEL/REAR BRAKE/ REAR SUSPENSION

* Make sure the spring plate next to the brake pad dowel pin orientation.

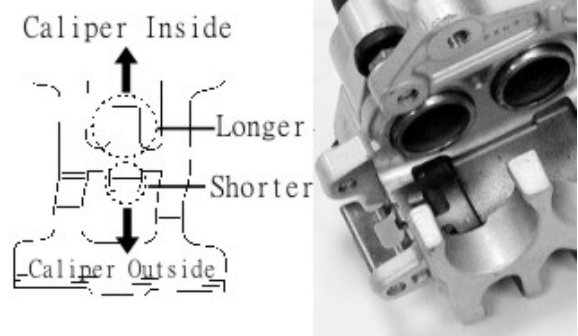

Install two brake pads.

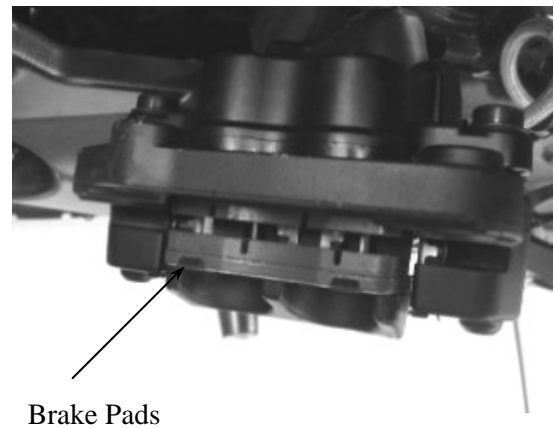

INSTALLATION

Install the brake caliper to the rear fork and tighten the two bolts.

Connect the brake fluid tube to the brake caliper and install fluid tube bolt, copper washers and tighten the fluid tube bolt.

Fill the brake reservoir with the specified brake fluid and bleed air from the brake system.

* When installing the brake fluid tube, be sure to install the two copper sealing washers.

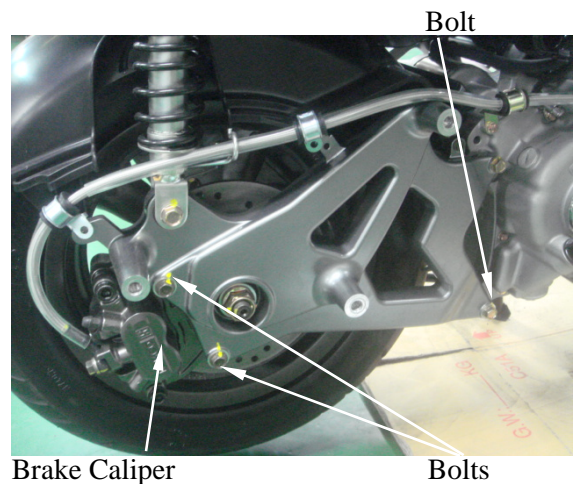

15. REAR WHEEL/REAR BRAKE/ REAR SUSPENSION

REAR FORK

REMOVAL

Remove the exhaust muffler.

Remove the rear brake caliper.

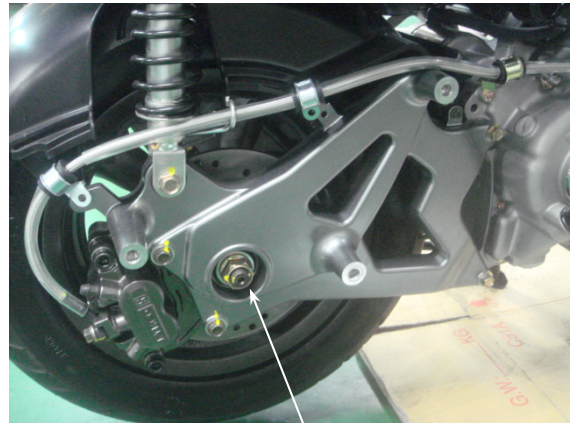

Bear Axle Nut

Bolt

Remove the right rear shock absorber lower mount bolt.

Remove the rear axle nut and remove the collar.

Remove the rear fork.

The installation sequence is the reverse of removal.

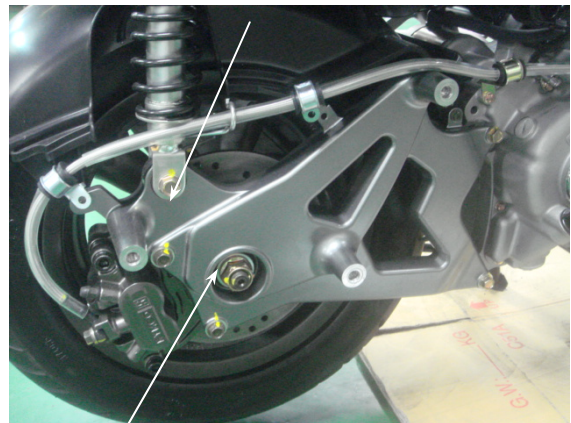

Bear Axle Collar

15. REAR WHEEL/REAR BRAKE/ REAR SUSPENSION

REAR WHEEL REMOVAL

- Remove the exhaust muffler.
- Remove the rear brake caliper.
- Remove the rear fork.
- Remove the rear axle collar.
- Remove the rear wheel.

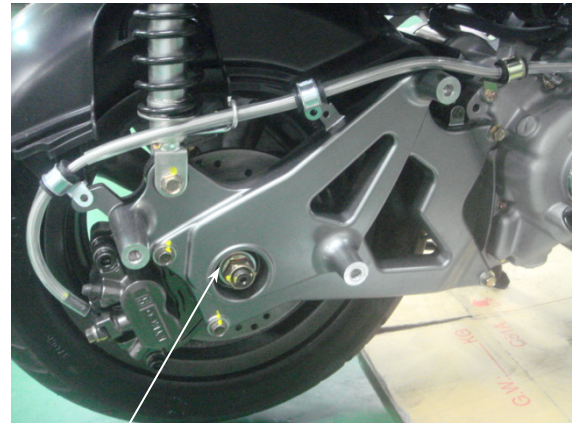

Bear Axle Collar

INSTALLATION

The installation sequence is the reverse of removal.

Torque:

- Rear shock absorber lower mount bolt: 40 N-m (4 kgf-m)
- Rear axle nut 120 N-m (12 kgf-m)

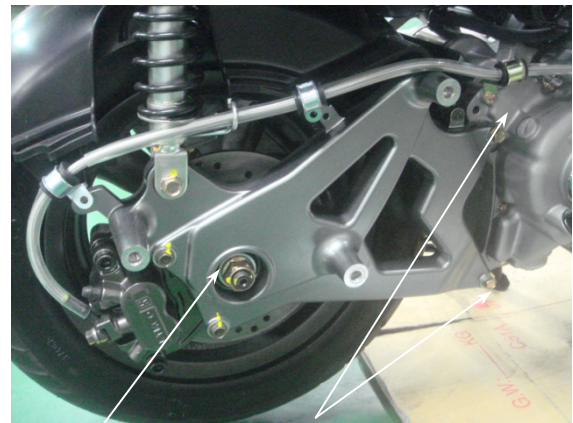

Bear Axle Collar Bolts

REAR SHOCK ABSORBER REMOVAL

- Remove the met-in box and carrier.
- Remove the body cover, center cover and rear fender A together.
- Remove the right/left rear shock absorber upper and lower mount bolts.
- Remove the right and left rear shock absorbers.

INSTALLATION

Install the rear suspension in the reverse order of removal.

Torque:

- Upper Mount Bolt: 40 N-m (4 kgf-m)
- Lower Mount Bolt: 40 N-m (4 kgf-m)



Bolts

15. REAR WHEEL/REAR BRAKE/ REAR SUSPENSION

Suspension

Each shock absorber ⑨ on your scooter has 5 spring preload adjustment positions for different load or riding conditions.

Use a pin spanner ⑩ to adjust the rear shock spring preload. Position 1 is for light loads and smooth road conditions. Position 3 to 5 increase spring preload for a stiffer rear suspension and can be used when the scooter is heavily loaded. Be certain to adjust both shock absorbers to the same spring preload positions.

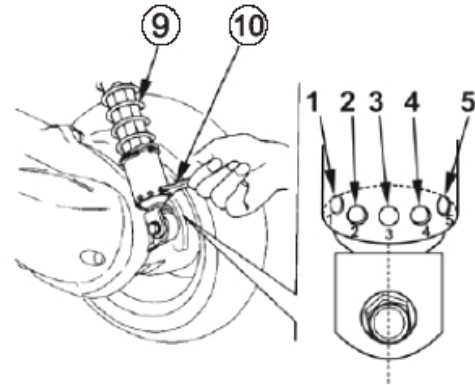

Standard spring preload position: 3

CAUTION

Always adjust the shock absorber pre-load position in sequence (1-2-3-4-5 or 5-4-3-2-1). Attempting to adjust directly from 1 to 5 or 5 to 1 may damage the shock absorber.

16. BATTERY/CHARGING SYSTEM

16

BATTERY/CHARGING SYSTEM

CHARGING SYSTEM LAYOUT	16-1
CHARGING CIRCUIT	16-1
SERVICE INFORMATION.....	16-2
TROUBLESHOOTING.....	16-3
BATTERY CHARGING	16-4
CHARGING SYSTEM	16-6
REGULATOR/RECTIFIER	16-6

16. BATTERY/CHARGING SYSTEM

CHARGING SYSTEM LAYOUT

BATTERY

REGULATOR/RECTIFIER

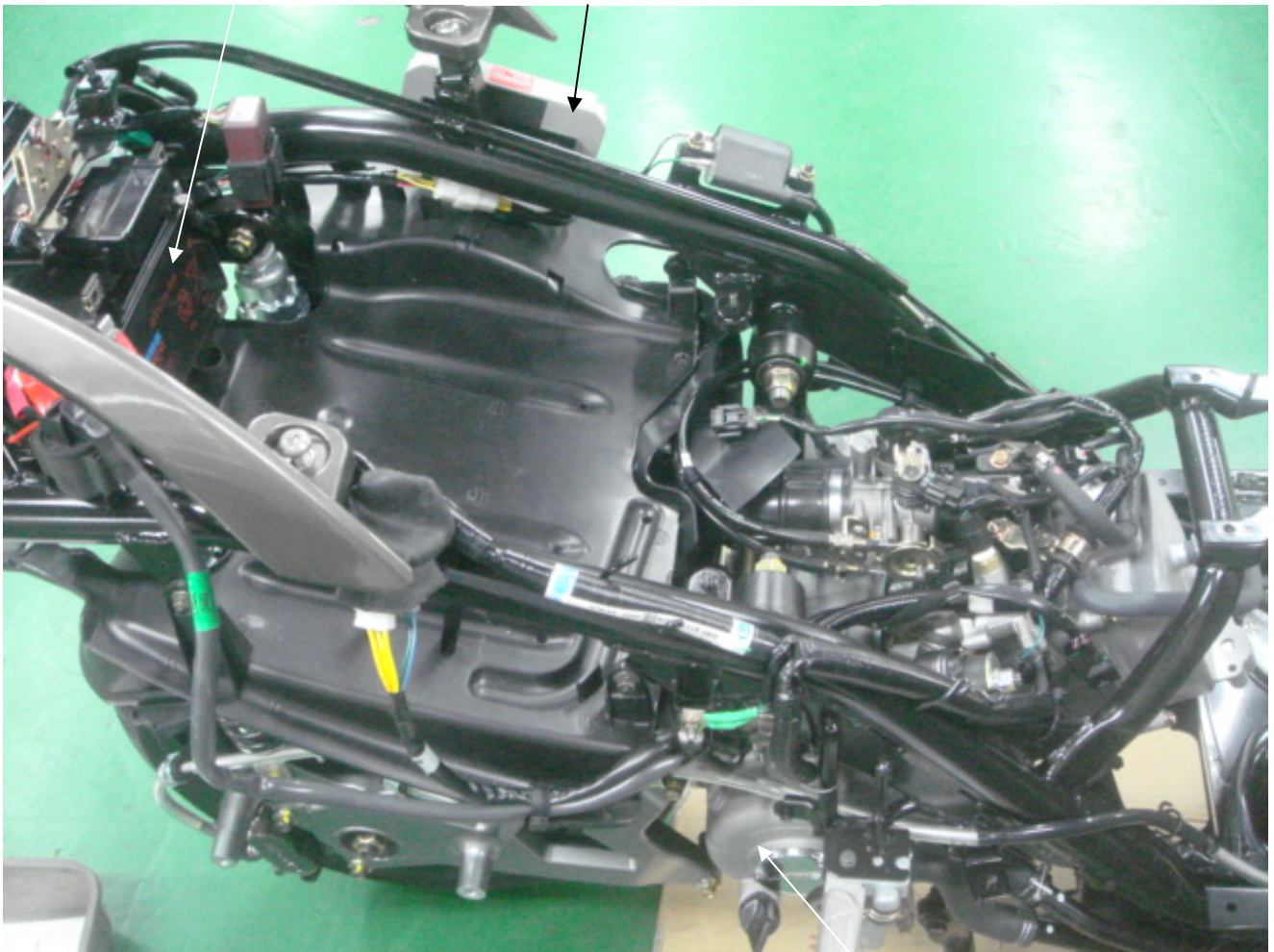

ACG

16. BATTERY/CHARGING SYSTEM

SERVICE INFORMATION

GENERAL INSTRUCTIONS

* The battery electrolyte (sulfuric acid) is poisonous and may seriously damage the skin and eyes. Avoid contact with skin, eyes, or clothing. In case of contact, flush with water and get prompt medical attention

- The battery can be charged and discharged repeatedly. If a discharged battery is not used for a long time, its service life will be shortened. Generally, the capacity of a battery will decrease after it is used for 2~3 years. A capacity-decreased battery will resume its voltage after it is recharged but its voltage decreases suddenly and then increases when a load is added.
- When a battery is overcharged, some symptoms can be found. If there is a short circuit inside the battery, no voltage is produced on the battery terminals. If the rectifier won't operate, the voltage will become too high and shorten the battery service life.
- If a battery is not used for a long time, it will discharge by itself and should be recharged every 3 months.
- A new battery filled with electrolyte will generate voltage within a certain time and it should be recharged when the capacity is insufficient. Recharging a new battery will prolong its service life.
- Inspect the charging system according to the sequence specified in the Troubleshooting.
- Do not disconnect and soon reconnect the power of any electrical equipment because the electronic parts in the regulator/rectifier will be damaged. Turn off the ignition switch before operation.
- It is not necessary to check the MF battery electrolyte or fill with distilled water.
- Check the load of the whole charging system.
- Do not quick charge the battery. Quick charging should only be done in an emergency.
- Remove the battery from the motorcycle for charging.
- When replacing the battery, do not use a traditional battery.
- When charging, check the voltage with an electric tester.

SPECIFICATIONS

		Item	Standard
Battery	Capacity		12V10AH
	Voltage (20°C)	Fully charged	13.2V
		Insufficient charged	< 12.3V
	Charging current		1.2A* 5~10H

16. BATTERY/CHARGING SYSTEM

TROUBLESHOOTING

No power

- Dead battery
- Disconnected battery cable
- Fuse burned out
- Faulty ignition switch

Low power

- Weak battery
- Loose battery connection
- Charging system failure
- Faulty regulator/rectifier

Intermittent power

- Loose battery cable connection
- Loose charging system connection
- Loose connection or short circuit in ignition system

Charging system failure

- Loose, broken or shorted wire or connector
- Faulty regulator/rectifier
- Faulty A.C. generator

16. BATTERY/CHARGING SYSTEM

BATTERY

REMOVAL

The battery is in the battery box below seat.

1. Remove the seat.
2. Remove the met-in box
3. Remove four screws then the battery retainer.

4. Pull battery out to expose the terminal leads
5. Disconnect the negative (-) terminal lead from the battery first, then disconnect the positive (+) terminal lead.
6. Remove the battery from the battery box.

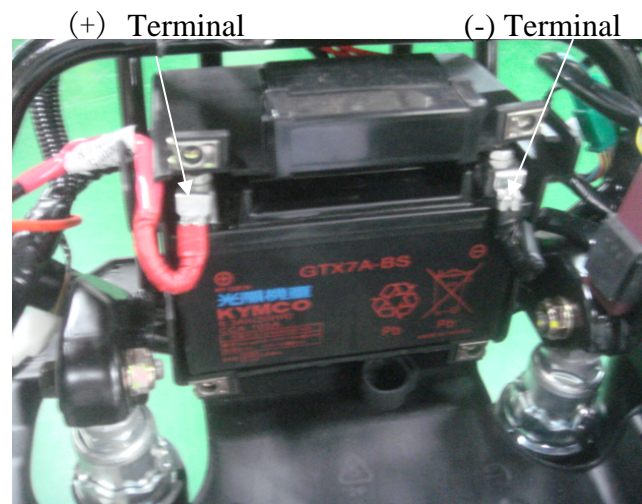

BATTERY INSTALLATION

Install in the reverse order of the removal.

* When install the battery, first connect the positive (+) cable and then negative (-) cable to avoid short circuit.

VOLTAGE INSPECTION

Remove the battery cover.

Measure the battery voltage by using a commercially available digital multimeter.

Voltage (20°C/68°F):

Fully charged: 13.0 ~ 13.2 V

Insufficient charged: < 12.3 V

16. BATTERY/CHARGING SYSTEM

BATTERY CHARGING

Remove the battery

Connect the charger positive (+) cable to the battery positive (+) terminal.

Connect the charger negative (-) cable to the battery negative (-) terminal.

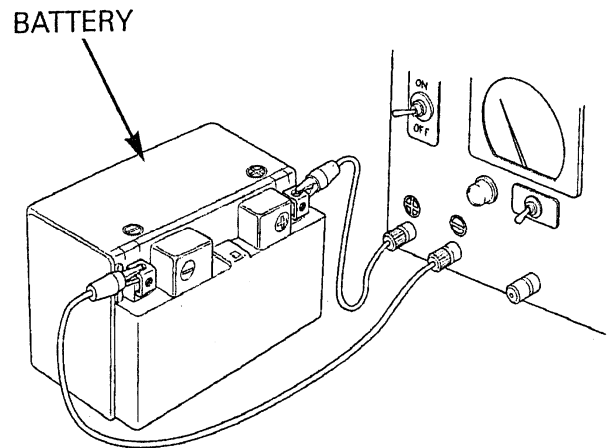

* Turn the power ON/OFF at the charger, not at the battery terminals.

CHARGING CURRENT:

Standard: 1.2A / 5~10 Hours

For battery charging, do not exceed the charging current and time specified on the battery. Using excessive current or extending the charging time may damage the battery.

CHARGING VOLTAGE INSPECTION

Be sure that the battery is in good condition before performing this test.

* Do not disconnect the battery or any cable in the charging system without first switching off the ignition switch. Failure to follow this precaution can damage the tester or electrical



Start the engine and warm it up to the operating temperature; stop the engine.

Connect the multimeter between the positive (+) and negative (-) terminals of the battery.

To prevent short, make absolutely certain which are the positive (+) and negative (-) terminals or cable.

With the headlight on and turned to the high beam position, restart the engine.

Measure the voltage on the multimeter when the engine runs at 5000 rpm.

Standard:

Battery charging voltage 14 ~ 15V

16. BATTERY/CHARGING SYSTEM

REGULATOR/RECTIFIER

WIRE HARNESS INSPECTION

Remove the luggage box
Disconnect the regulator/rectifier connectors.
Check the connectors for loose contacts of corroded terminals.

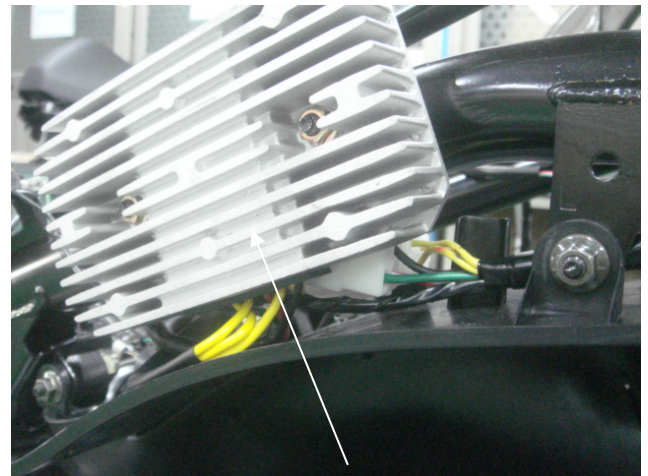

Regulator/Rectifier

BATTERY WIRE

Measure the voltage between the Red/White wire terminal and ground.
There should be battery voltage at all times.



GROUND WIRE

Check the continuity between the Green wire terminal and ground.
There should be continuity at all times.



16. BATTERY/CHARGING SYSTEM

CHARGING COIL WIRE

Measure the resistance between each Yellow wire terminals.

Standard: 0.4 ~ 0.6 Ω (20°C/68°F)

Disconnect the regulator/rectifier connector.
Check for continuity between each Yellow wire terminal regulator/rectifier side and ground.

There should be no continuity.



Regulator/Rectifier

REMOVAL/INSTALLATION

Remove the side body cover.

Disconnect the regulator/rectifier connectors.

Remove the two bolts, regulator/rectifier.

Installation is in the reverse order of removal.

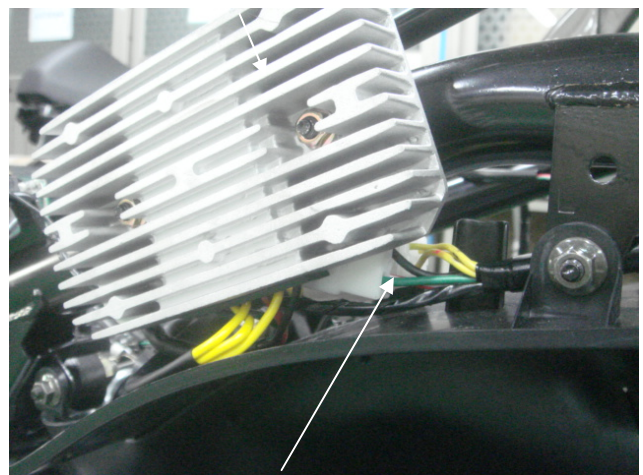

Connectors

17. IGNITION SYSTEM

17

IGNITION SYSTEM

IGNITION SYSTEM LAYOUT	17-1
SERVICE INFORMATION.....	17-2
TROUBLESHOOTING	17-2
SPARK PLUG	17-3
IGNITION COIL INSPECTION	17-3
A.C. GENERATOR INSPECTION.....	17-4
TILT SWITCH INSPECTION	17-4

17. IGNITION SYSTEM

G-DINK 300i

IGNITION SYSTEM LAYOUT

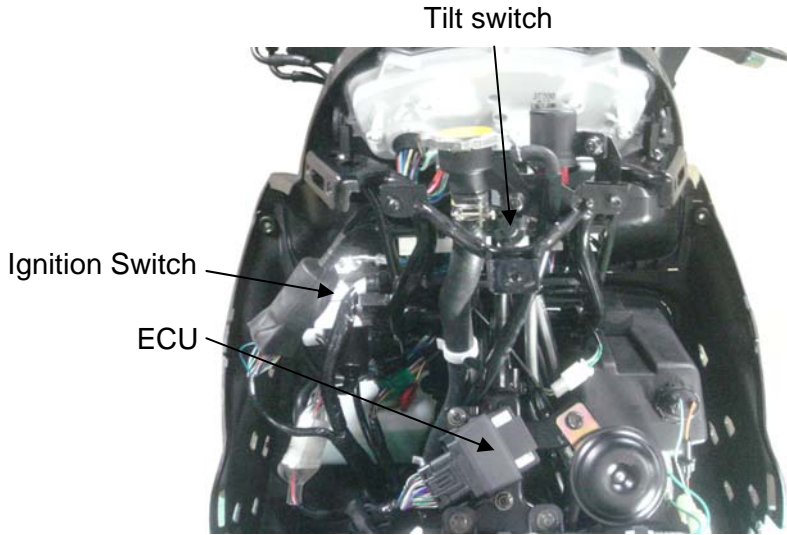

Crank Position Sensor

A.C. Generator

IGNITION CIRCUIT

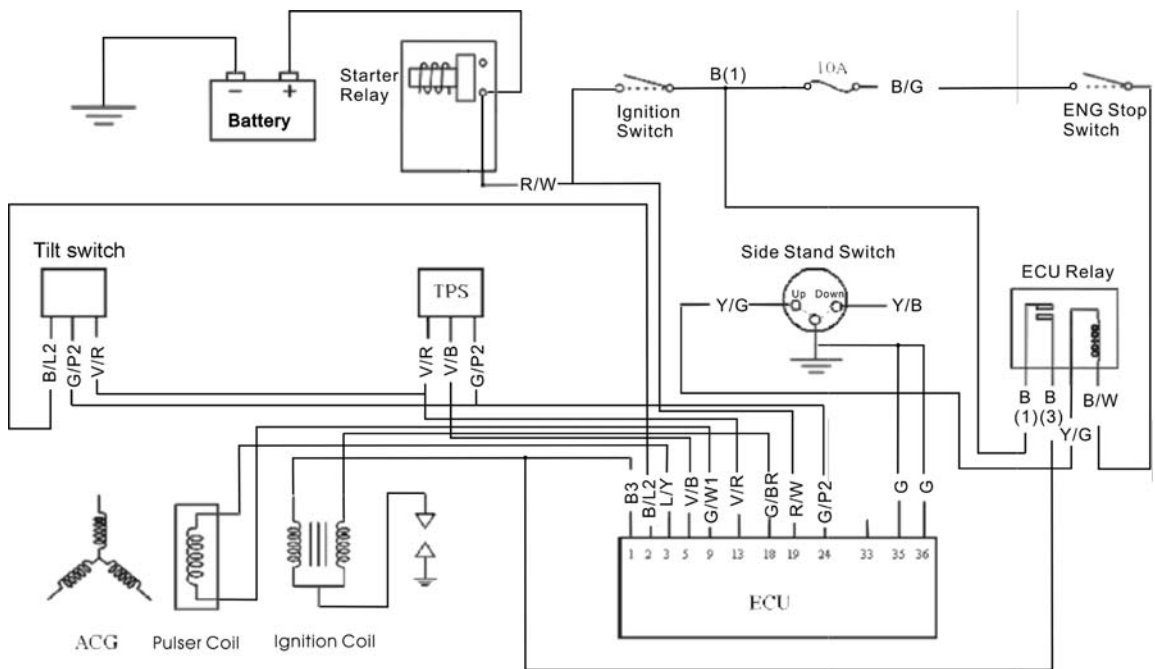

17. IGNITION SYSTEM

SERVICE INFORMATION

GENERAL INSTRUCTIONS

- Some electrical components may be damaged if terminals or connectors are connected or disconnected while the ignition switch is "ON" and current is present.
- When servicing the ignition system, always follow the steps in the troubleshooting on page 17-2.
- The ignition timing cannot be adjusted since the ignition control module is already adjusted in factory.
- The ignition control module or ECU maybe damaged if dropped or the connector is disconnected when the key is " ON " , the excessive voltage may damage the ignition control module or ECU. Always turn off the ignition switch before servicing.
- A faulty ignition system is often related to poor connections. Check those connections before proceeding.
- Make sure the battery is adequately charged. Using the starter motor with weak battery results in a slower engine cranking speed as well as no spark at the spark plug.
- Use a spark plug of the correct heat range. Using spark plug with an incorrect heat range can damage the engine.

SPECIFICATIONS

Item		Standard
Spark plug	Standard type	DPR6EA
Spark plug gap		0.6 ~ 0.7 mm
Inductive Ignition Coil	Primary coil	3.57~4.83 Ω
	Secondary coil without plug cap	10.42~14.49 K Ω
Throttle Position Sensor		3500~6500 Ω
Fuel Pump		1.9 Ω about
Fuel Injector		11.7±0.6 Ω
Water Temperature Sensor		2.076K Ω ±10% (25℃)
Oxygen Sensor (engine warming condition)		6.7 Ω ~9.5 Ω
Crank Position Sensor		115 Ω ±15 Ω
Tilt Switch		0.4V~1.4V(normal) 3.7V~4.4V (fall down)

TROUBLESHOOTING

No peak voltage

- Short circuit in engine stop switch or ignition switch wire.
- Faulty engine stop switch or ignition switch.
- Loose or poorly connected ignition control module connectors.
- Open circuit or poor connection in ground wire of the ignition control module.
- Faulty crank position sensor.
- Faulty ignition control module.

Peak voltage is normal, but no spark jumps at the plug

- Faulty spark plug or leaking ignition coil secondary current.
- Faulty ignition coil.

17. IGNITION SYSTEM

SPARK PLUG

For spark plug inspection and adjustment, refer to page 3-5.

IGNITION COIL INSPECTION

Remove the seat and met-in box. (⇒2-6)
Remove the ignition coil.

IGNITION COIL CONTINUITY TEST

Inspect the continuity of the ignition coil, primary coil and secondary coil.

* This is a general test. Accurate ignition coil test must be performed with an ignition unit tester.

Measure the ignition coil resistances at 20°C.

Primary coil	3.57~4.83 Ω
Secondary coil with plug cap	15 ~ 19 K Ω
Secondary coil without plug cap	10 ~14 K Ω

Ignition Coil



Primary Coil



Secondary Coil with plug cap



Secondary Coil without plug cap



17. IGNITION SYSTEM

A .C. GENERATOR INSPECTION

CRANK POSITION SENSOR INSPECTION

* This test is performed with the stator installed in the engine.

Remove the seat and met-in box.
 Disconnect the Crank Position Sensor Wire Coupler.
 Measure the resistance between the blue/white and green/white wire terminals.



Crank Position Sensor Wire Coupler

Blue/Yellow~Green/White	115 Ω ± 15 Ω
-------------------------	--------------

TILT SWITCH INSPECTION

Support the scooter level surface.
 Put the side stand up and engine stop switch is at "RUN".
 Turn the ignition switch to "OFF".
 Remove the screws, washers and tilt switch.

* Do not disconnect the tilt switch connector during inspection.
 The capacity of battery must be fully charged.

Place the tilt switch vertical as shown at the ignition switch "ON". Measure the voltage as below.



Terminal	Standard
Violet/Red (+) – Green/Pink (-)	5 V (ECU voltage)
Black/Blue (+) – Green/Pink (-)	0.4~1.4 V less

Incline the tilt switch 65±10 degrees to the left or right at the ignition switch "ON". Measure the voltage as below.

Terminal	Standard
Violet/Red (+) – Green/Pink (-)	5 V (ECU voltage)
Black/Blue (+) – Green/Pink (-)	3.7~4.4 V

If repeat this test, first turn the ignition switch to "OFF", then turn the ignition switch to "ON".

Tilt Switch Connector



17. IGNITION SYSTEM

REMOVAL/INSTALLATION

Disconnect the connector and remove two screws, then remove tilt switch.

Installation is in the reverse order of removal.

- * Install the tilt switch with its “up” mark facing up.

Tighten the mounting screws securely.

Tilt Switch “UP” Mark

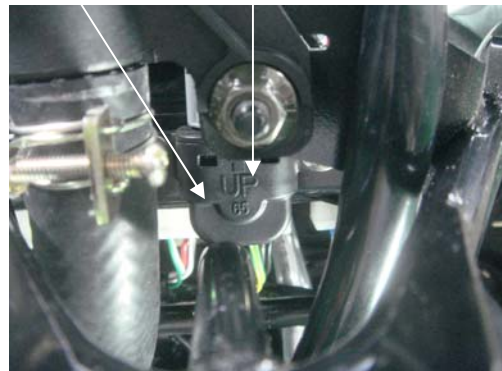

18. STARTING SYSTEM

STARTING SYSTEM

STARTING SYSTEM LAYOUT	18-1
SERVICE INFORMATION.....	18-2
TROUBLESHOOTING	18-2
STARTER MOTOR.....	18-3
STARTER RELAY INSPECTION.....	18-4

18. STARTING SYSTEM

STARTING SYSTEM LAYOUT

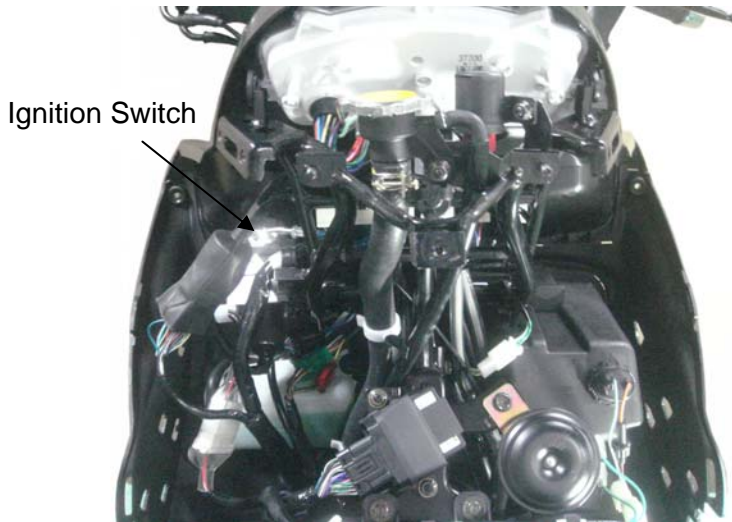

Starter Relay



STARTING CIRCUIT

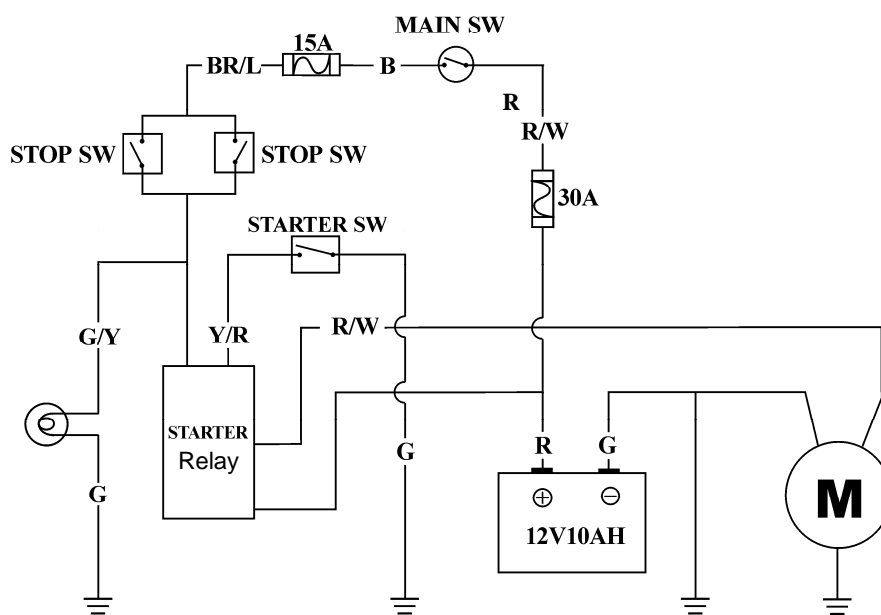

18. STARTING SYSTEM

SERVICE INFORMATION

GENERAL INSTRUCTIONS

- The removal of starter motor can be accomplished with the engine installed.
- After the starter clutch is installed, be sure to add the engine oil and coolant and then bleed air from the cooling system.

SPECIFICATIONS

Item	Standard (mm)	Service Limit (mm)
Starter motor brush length	12.5mm	8.5mm

SPECIAL TOOLS

Flywheel holder	E021
Flywheel puller	E003

TROUBLESHOOTING

Starter motor won't turn

- Fuse burned out
- Weak battery
- Faulty ignition switch
- Faulty starter clutch
- Faulty front or rear stop switch
- Faulty starter relay
- Poorly connected, broken or shorted wire
- Faulty starter motor

Lack of power

- Weak battery
- Loosed wire or connection
- Foreign matter stuck in starter motor or gear

Starter motor rotates but engine does not start

- Faulty starter pinion
- Starter motor rotates reversely
- Weak battery

18. STARTING SYSTEM

STARTER MOTOR

REMOVAL

* Before removing the starter motor, turn the ignition switch OFF and remove the battery ground. Then, turn on the ignition switch and push the starter button to make sure the starter motor can't operate securely.

Remove the seat, met-in box and carrier.
Remove the body cover, center cover and rear fender A together.
Remove the nut goes to the starter relay and relax cable band to disconnect the starter motor cable.

Remove two start motor mounting bolts and the motor.

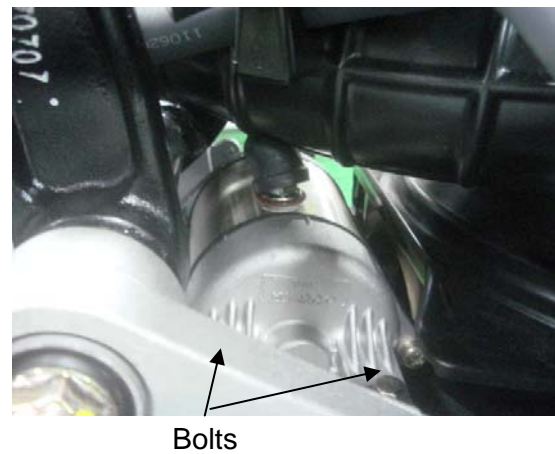

18. STARTING SYSTEM

INSTALLATION

Connect the starter motor cable.

Check the O-ring for wear or damage and replace if necessary.

Apply grease to the O-ring and install it to the starter motor.

Tighten the two mounting bolts.

Starter Motor Cable



STARTER RELAY INSPECTION

Disconnect the starter relay wire connector.

Check for continuity between the yellow/red wire and green/yellow wire.

There should be continuity when the starter button is depressed.

If there is no continuity, check the starter button for continuity and inspect the wire.



OPERATION TEST

Connect the electric meter to the starter relay terminals that connect to the battery positive cable and the starter motor cable.

Connect a fully charged battery across the starter relay yellow/red and green/yellow wire terminals.

Check for continuity between the starter relay large terminals. The relay is normal if there is continuity and hear sounds.

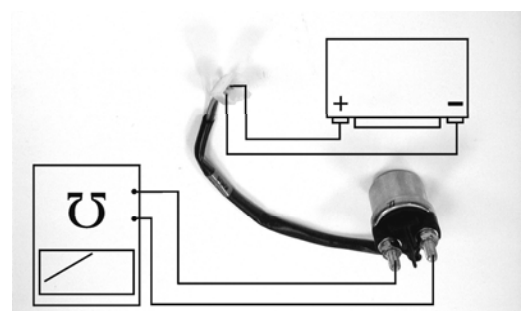

Starter Relay test chart

LIGHTS/METERS/SWITCHES

SERVICE INFORMATION-----	19- 1
BULB REPLACEMENT -----	19- 2
BRAKE LIGHT SWITCH-----	19- 6
IGNITION SWITCH -----	19- 6
HANDLEBAR SWITCH -----	19- 7
LUGGAGE BOX LIGHT SWITCH -----	19- 8
SIDE STAND SWITCH -----	19- 9
HORN -----	19-10

19. LIGHTS SWITCHES/ FUEL PUMP

SERVICE INFORMATION

GENERAL

*

A halogen head light bulb becomes very hot while the head light is on, and remains for a while after it is turned off. Be sure to let it cool down before servicing.

- Note the following when replacing the halogen headlight bulb
 - ™ Wear clean gloves while replacing the bulb. Do not put finger prints on the headlight bulb, as they may create hot spots on the bulb and cause it to fail.
 - ™ If you touch the bulb with your bare hands, clean it with a cloth moistened with alcohol to prevent its early failure.
 - ™ Be sure to install the dust cover after replacing the bulb.
- Check the battery condition before performing any inspection that requires proper battery voltage.
- A continuity test can be made with the switches installed on the scooter.
- Route the wires and cables properly after servicing each component.

TROUBLESHOOTING

Lights do not come on when ignition switch is "ON"

- Burned bulb
- Faulty switch
- Poorly connected, broken or shorted wire

Temperature gauge does not register correctly

- Faulty temperature gauge
- Faulty thermosensor
- Broken or shorted wire between the temperature gauge and thermosensor

Fuel gauge does not work or wrong show figures

- Faulty fuel gauge
- Faulty fuel unit
- Poorly connected wire between fuel gauge and fuel unit
- Fuse burned out

SPECIFICATIONS

Fuse	10A,15A,30A
Headlight bulb	12V 60W/55W
Turn signal light bulb	12V 21W(Front) / 10W(Rear)
Stoplight/taillight	12V 21/5W

19. LIGHTS SWITCHES/ FUEL PUMP

BULB REPLACEMENT

LICENSE LIGHT

Remove the seat assembly and luggage box.
Remove the body covers.
Disconnect the license bulb socket.
Remove the bulb and replace with a new one.

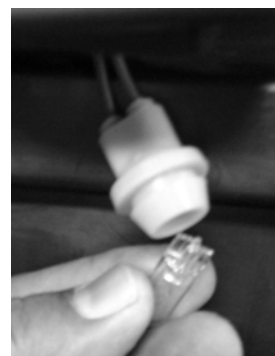
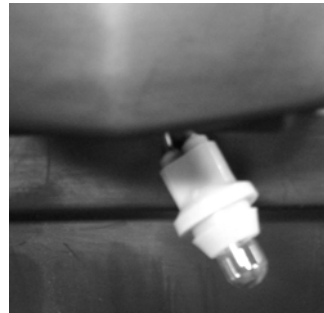

19. LIGHTS/METERS/SWITCHES

HEADLIGHT

* A halogen headlight bulb becomes hot while the headlight is ON and remains for a while after it is turned OFF. Be sure to let it cool down before servicing.

Remove the front cover
Disconnect the headlight cover
Disconnect the headlight connector from the headlight bulb.

Connector

Headlight Bulb

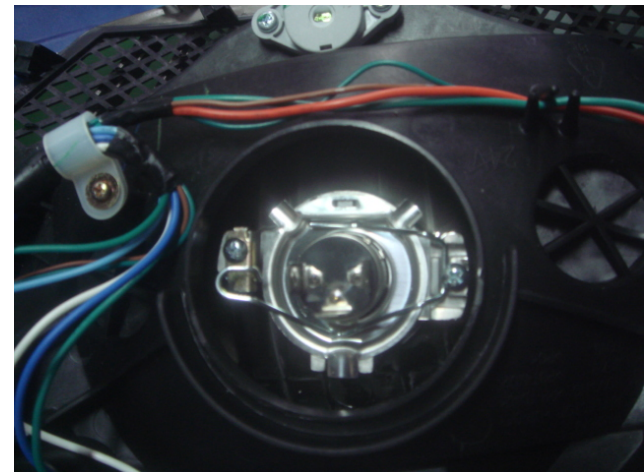
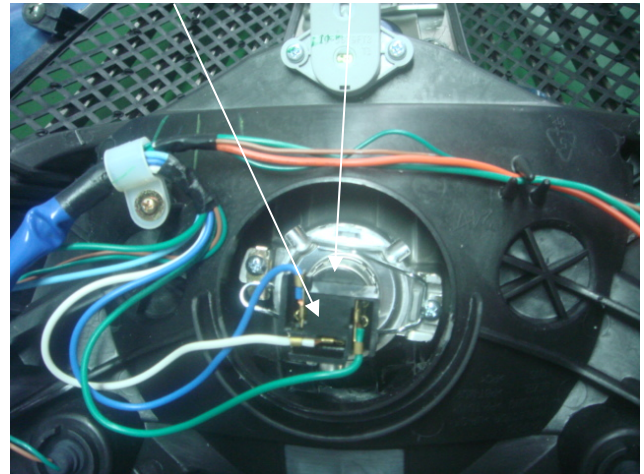

Install a new bulb into the headlight case.
Install the headlight and connect the headlight connector

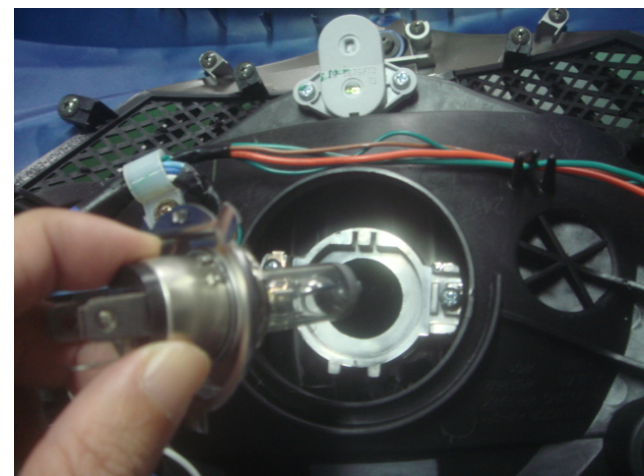

19. LIGHTS/METERS/SWITCHES

FRONT TURN SIGNAL LIGHT

Remove the front cover.
Turn the bulb socket, then remove the front turn signal light.

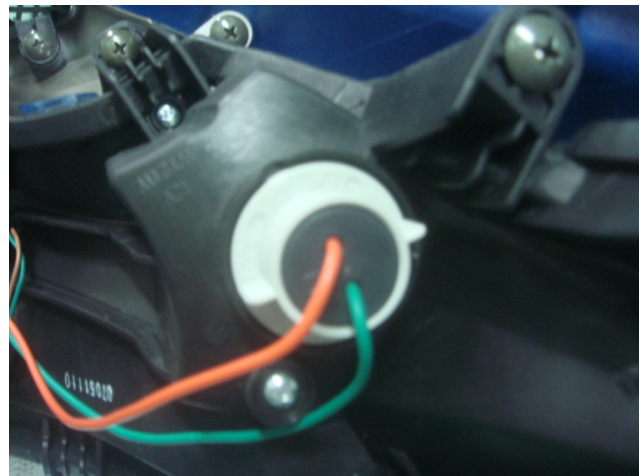

Push and turn the bulb counterclockwise to remove it, then replace with a new one.

Installation is in the reverse order of removal.



TAILLIGHT/BRAKE LIGHT/REAR TURN SIGNAL LIGHT

Remove the seat and met-in, then remove the taillight bulb socket.

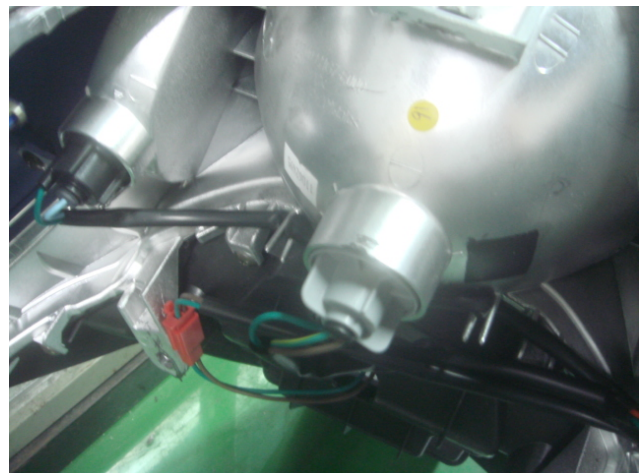

19. LIGHTS/METERS/SWITCHES

REAR TURN SIGNAL LIGHT

Push and turn the bulb counterclockwise to remove it, then replace with a new one.

Installation is in the reverse order of removal.



Rear Turn Signal Light

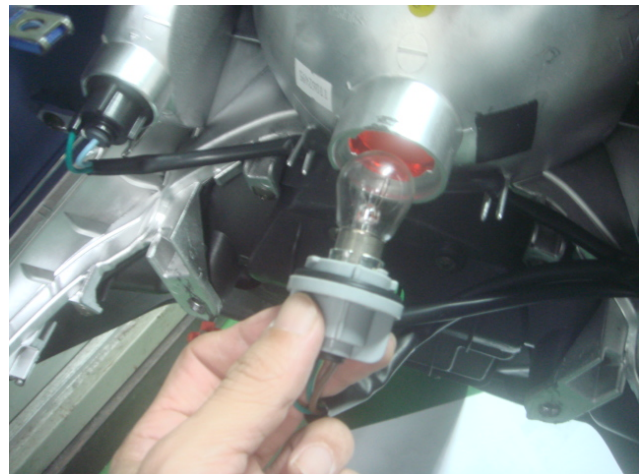

Taillight/Brake Light

19. LIGHTS/METERS/SWITCHES

BRAKE LIGHT SWITCH

Remove the upper handlebar cover.
 Disconnect front or rear brake light switch connectors and check for continuity between the switch terminals.
 There should be continuity with the front or rear brake lever squeezed, and there should be no continuity with the front or rear brake lever is released.

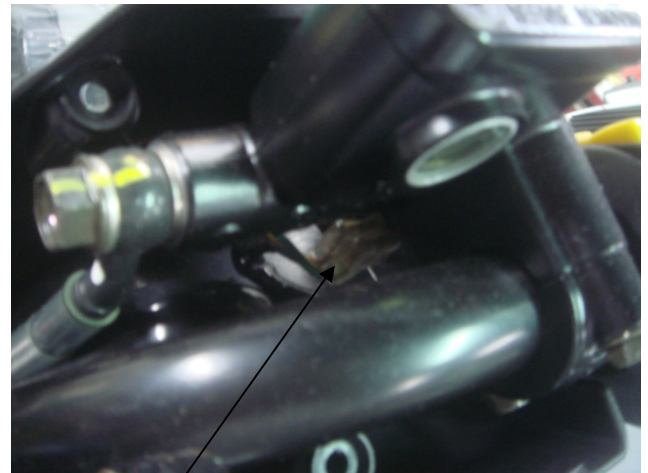

Front Brake Light Switch

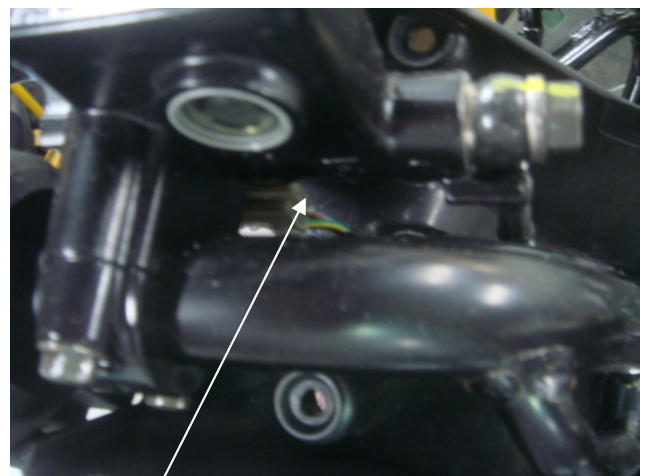

Rear Brake Light Switch

IGNITION SWITCH

INSPECTION

Remove the front cover.
 Disconnect the ignition switch connector and check the ignition switch for continuity at the switch side connector terminals.
 Continuity should exist between the color code wires as follows:

COMB SW

	BAT2	IG	E	BAT1	HA
LOCK		○—○			
OFF		○—○		○—○	
ON	○—			○—○	
COLOR	B	B/W	G	R	B/L



19. LIGHTS/METERS/SWITCHES

RIGHT HANDLEBAR SWITCH

INSPECTION

Remove the front cover

Disconnect the right handlebar switch connector and check for continuity at switch side connector terminals.

Continuity should exist between the color code wires as follows:

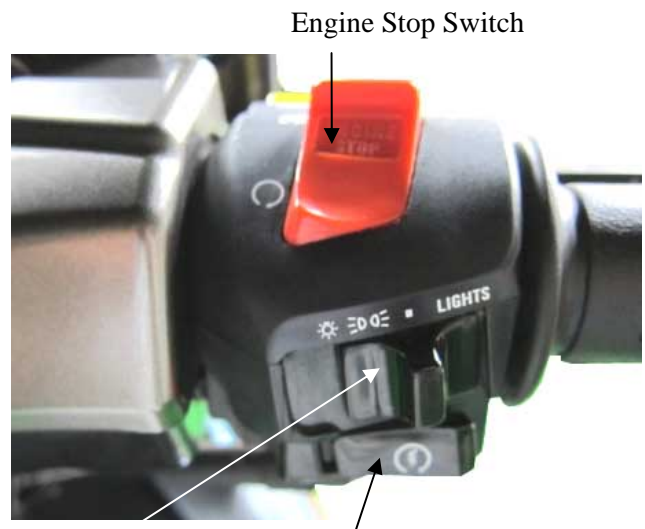

Lighting Switch

Starter Switch

LIGHTING SW

	BAT3	PO	TL	HL
•				
(N)				
P	○	○	○	
(N)	○	○	○	○
H	○		○	○
COLOR	BR/L	BR/W	BR	W/L

STARTER SW

	E	ST
FREE		
PUSH	○	○
COLOR	G	Y/R

ENGINE STOP SW

	IG	BAT3
OFF		
RUN	○	○
COLOR	B/W	B/G

19. LIGHTS/METERS/SWITCHES

LEFT HANDLEBAR SWITCH

INSPECTION

Disconnect the left handlebar switch connector and check for continuity at switch side connector terminals.

Continuity should exist between the color code wires as follows:

WINKER SW

	WR	R	L
R	○	○	
N			
L	○		○
COLOR	GR	SB	○

HORN SW

	BAT6	HO
FREE		
PUSH	○	○
COLOR	BR/L	LG

DIMMER SW

	HL	HI	LO
LO	○		○
(N)	○	○	○
HI	○	○	
COLOR	W/L	L	W

PASSING SW

	BAT4	HI
FREE		
PUSH	○	○
COLOR	BR/L	L

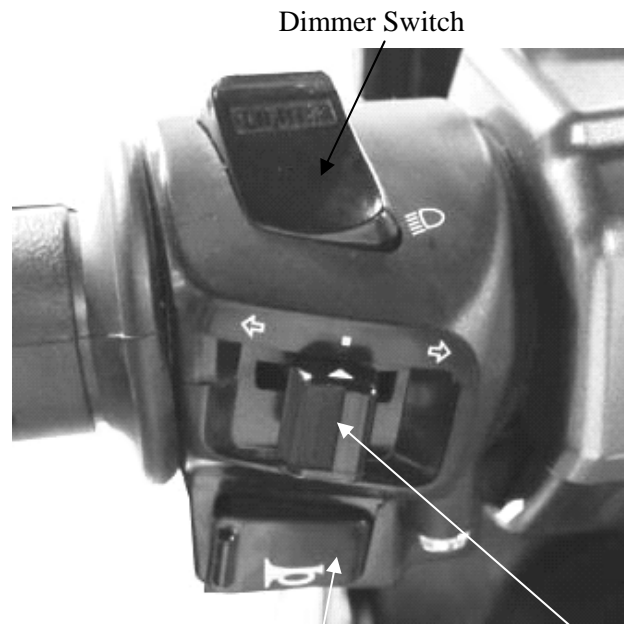

Horn Switch Turn Signal light Switch

Passing Switch



LUGGAGE BOX LIGHT SWITCH

INSPECTION

Remove the luggage box

Disconnect the luggage box light switch connector and check the luggage box light switch for continuity between the switch terminals.

There should be no continuity with the luggage box light switch pushed, and there should be continuity with the luggage box light switch is released.

Luggage box light switch Connector



19. LIGHTS/METERS/SWITCHES

SIDE STAND SWITCH

INSPECTION

Remove the luggage box.

Side stand switch is located on side stand.

Disconnect the side stand switch connector.

There should be continuity between the Yellow/Green and Green with the side stand is up.

There should be continuity between the Yellow/Black and Green with the side stand is down.

Connector

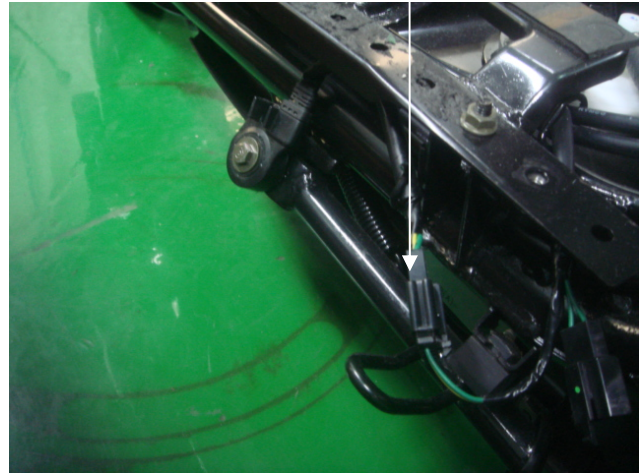

19. LIGHTS/METERS/SWITCHES

HORN

INSPECTION

Remove the front cover.

Disconnect the horn connectors from the horn.

Connect a 12 V battery to the horn terminals.

The horn is normal if it sounds when the 12 V battery is connected across the horn terminals.

