FOREWORD

This KYMCO Service Manual contains service, maintenance, and troubleshooting information for the 2010 KYMCO **MXU 450i**. This complete manual is designed to aid service personnel in service-oriented applications.

This manual is divided into sections. Each section covers a specific ATV component or system and, in addition to the standard service procedures, includes disassembling, inspecting, and assembling instructions. When using this manual as a guide, the technician should use discretion as to how much disassembly is needed to correct any given condition.

The service technician should become familiar with the operation and construction of each component or system KYMCO. This manual will assist the service technician in becoming more aware of and efficient with servicing procedures. Such efficiency not only helps build consumer confidence but also saves time and labor.

All KYMCO ATV publications and decals display the words Warning, Caution, Note, and At This Point to emphasize important information.

The symbol **⚠ WARNING** identifies personal safety-related information.

Be sure to follow the directive because it deals with the possibility of severe personal injury or even death. The symbol **⚠ CAUTION** identifies unsafe practices which may result in ATV-related damage. Follow the directive because it deals with the possibility of damaging part or parts of the ATV. The symbol **■ NOTE:** identifies supplementary information worthy of particular attention. The symbol **Ⓞ AT THIS POINT** directs the technician to certain and specific procedures to promote efficiency and to improve clarity.

At the time of publication, all information, photographs, and illustrations were technically correct. Some photographs used in this manual are used for clarity purposes only and are not designed to depict actual conditions. Because KYMCO Inc. constantly refines and improves its products, no retroactive obligation is incurred.

All materials and specifications are subject to change without notice. Keep this manual accessible in the shop area for reference.

KYMCO Inc.

SECTION 1 - GENERAL INFORMATION/ SPECIFICATIONS

TABLE OF CONTENTS

General Specifications	1-2
Torque Specifications	1-2
Tightening Torque (Frame parts)	1-3
Tightening Torque (Engine parts)	1-4
Break-In Procedure	1-5
Gasoline - Oil - Lubricant	1-5
Genuine Parts	1-5
Preparation For Storage	1-6
Preparation After Storage	1-6

General Specifications*

ENGINE AND DRIVE

Type	Four-Cycle/Liquid Cooled
Bore x Stroke	89mm*71.2mm (3.56*2.80in.)
Displacement	442.9 cc (26.57 cu in.)
Ignition Type	ECU
Spark Plug Type	NGK CR7E
Spark Plug Gap	0.7 - 0.8 mm (0.028 - 0.032 in.)
Brake Type	Hydraulic with Parking Brake & Foot Brake
Fuel Delivery	Electronic Fuel Injection (EFI)

CHASSIS

Length (Overall)	211 cm (83 in.)
Height (Overall)	118.5cm (47 in.)
Width (Overall)	110 cm (43 in.)
Suspension Travel	19 cm (7.5in.)
Wheelbase	121.7cm (48 in.)
Tire Size (Front)	24*8-12
Tire Size (Rear)	24*10-12
Tire Inflation Pressure	0.29 kg/cm2 (4 psi)

MISCELLANEOUS

Dry Weight (Approx)	277.5 kg (611lb)
Gas Tank Capacity (Rated)	15 L (3.75 U.S. Gal.)
Differential Capacity	270 ml (9.1 fl oz)
Rear Drive Capacity	250 ml (8.5 fl oz)
Engine Oil Capacity	2.85 L (3.02 U.S. qt)
Engine Oil Changed Capacity	2.2 L (2.3 U.S. qt)
Engine Oil Changed Capacity with Oil Filter Changed	2.4 L (2.5 U.S. qt)
Gasoline (Recommended)	87 Octane Regular Unleaded
Engine Oil (Recommended)	SAE 5W-30
Differential/Rear Drive Lubricant	SAE 80W-90 Hypoid
Taillight/Brakelight	12V/5W/21W
Headlight	12V/35W

* Specifications subject to change without notice.

Standard Torque (frame Parts)

NO	ITEM	THREAD SIZE AND TYPE	TORQUE		PR-E Kgfm	AC TORQUE SPEC (FT-LBS)	THREAD DWG NO
			Kgfm	Nm			
1	STEERING						
	HANDLEBAR END AND HANDLEBAR GRIP	M8X1.25	0.9~1.3	9~13	1.1	8	90185-PWB1-9000
	HANDLEBAR AND STEERING POST	M8X1.25	2.4~3.2	24~32	2.8	20	95801-08055-08
	UPPER/LOWER HOUSING AND FRAME	M8X1.25	2.4~3.2	24~32	2.8	20	95801-PWB1-9000
	STEERING KNUCKLE AND TIE-ROD	M10X1.25	3.5~4.8	35~48	4.2	30	90304-PWB1-9000
	STEERING STEM AND TIE-ROD	M10X1.25	3.5~4.8	35~48	4.2	30	90304-PWB1-9000
	TIE-ROD NUT	M10X1.25	2.0~3.0	20~30	2.5		94001-PWB1-9000
	TIE-ROD NUT LH	M10X1.25	2.0~3.0	20~30	2.5		94001-PWB1-9000
	STEERING POST LOWER PIVOT	M10X1.25	5.0~6.1	50~61	5.5	40	95701-10020-08
	FLANGE, BEARING AND FRAME	M8X1.25	2.4~3.2	24~32	2.8	20	95701-08016-08
2	WHEEL						
	FRONT WHEEL AND FRONT HUB	M10X1.25	5.0~6.1	50~61	5.5	40	90301-PWB1-9000
	REAR WHEEL AND REAR HUB	M10X1.25	5.0~6.1	50~61	5.5	40	90301-PWB1-9000
	FRONT WHEEL HUB AND FRONT HALFSHAFT(CVJ)	M22X1.5	27~30	270~300	28	200 (MIN)	94011-PWB1-9000
	REAR WHEEL HUB AND REAR HALFSHAFT(CVJ)	M22X1.5	27~30	270~300	28	200 (MIN)	94011-PWB1-9000
	FRONT WHEEL HUB AND STUD AXLE(2WD ONLY)	M22X1.5	27~30	270~300	28	200 (MIN)	94011-PWB1-9000
3	FR SUSPENSION						
	FRONT SHOCK UPPER JOINT AND FRAME	M10X1.25	4.1~5.6	41~56	4.8	35	90304-GLW0-9020-M1 (U NUT)
	FRONT UPPER/LOWER ARM AND FRAME	M10X1.25	4.1~5.6	41~56	4.8	35	90304-GLW0-9020-M1
	FRONT SHOCK JOINT AND FRONT UPPER ARM	M10X1.25	4.1~5.6	41~56	4.8	35	90304-GLW0-9020-M1
	FRONT KNUCKLE AND FRONT UPPER/LOWER ARM	M10X1.25	4.1~5.6	41~56	4.8	35	95801-10035-06
4	RR SUSPENSION						
	REAR SHOCK UPPER JOINT AND FRAME	M10X1.25	4.1~5.6	41~56	4.8	35	90304-GLW0-9020-M1 (U NUT)
	REAR UPPER/LOWER ARM AND FRAME	M10X1.25	4.1~5.6	41~56	4.8	35	90304-GLW0-9020-M1
	REAR SHOCK JOINT AND REAR LOWER ARM	M10X1.25	4.1~5.6	41~56	4.8	35	90304-GLW0-9020-M1
	REAR KNUCKLE AND REAR UPPER/LOWER ARM	M10X1.25	4.1~5.6	41~56	4.8	35	95801-10035-06
5	BRAKE						
	FRONT BRAKE DISC AND FRONT HUB	M6X1.0	1.7~2.5	17~25	2	15	90106-PWB1-9000
	REAR BRAKE DISC AND REAR HUB	M6X1.0	1.7~2.5	17~25	2	15	90106-PWB1-9000
	FRONT/REAR CALIPER AND BRAKE HOSE END	M10X1.25	2.4~3.2	24~32	2.8	20	90145-MKS9-6120-M1
	MASTER CYLINDER AND BRAKE HOSE END	M10X1.25	2.4~3.2	24~32	2.8	20	90145-MKS9-6120-M1
	SECONDARY MASTER CYLINDER AND FRAME	M6X1.0	0.9~1.3	9~13	1.1	8	96001-06035-08
	TREE-WAY JUNCTION AND BRAKE HOSE END	M10X1.25	3.0~4.0	30~40	3.5		90145-LBA2-E000
	SWITCH-BRAKE PRESSURE-BANJO AND MASTER CYLINDER	-	2.4~3.2	24~32	2.8	20	35340-PWB1-9000
	LEVER, FOOT BRAKE AND FRAME PIVOT	M8X1.25	2.4~3.2	24~32	2.8	20	95701-08016-08
	CALIPER AND FR/RR KNUCKLE	M8X1.25	2.4~3.2	24~32	2.8	20	90131-LDB5-E000
	MASTER CYLINDER CLAMP	M6X1.0	0.7~0.9	7~9	0.8	5~6.7	-
	MASTER CYLINDER COVER	#8-32 UNC-3A	0.07~0.09	0.7~0.9	0.08	0.5~0.66	-
	MECHANICAL CALIPER AND RR KNUCKLE	M8X1.25	2.4~3.2	24~32	2.8	20	90131-LFA5-E000
6	FRAME						
	FOOTREST AND FRAME	M8X1.25	2.4~3.2	24~32	2.8	20	95701-08016-08
	SKID PLATE	-	0.5~0.6	5~6	0.55	4	93903-PWB1-9000
	FR BUMPER AND PLASTIC,BUMPER	M6X1.0	0.9~1.3	9~13	1.1	8	95701-06016-08
	FR BUMPER AND FRAME	M8X1.25	2.4~3.2	24~32	2.8	20	95701-08016-06
	FR BUMPER AND FRAME	M10X1.25	4.1~5.6	41~56	4.8	35	95701-10020-08
	ENGINE ASSY AND FRAME	M10X1.25	5.0~6.1	50~61	5.5	40	95801-10185-06
	MUFFLER EXH AND HEAD	M8X1.25	2.4~3.2	24~32	2.8	20	95701-08020-06
	OIL COOLER AND FRAME	M6X1.0	1.4~2.0	14~20	1.7	12	19031-PWB1-9000
	OIL COOLER AND FRAME	M6X1.0	1.4~2.0	14~20	1.7	12	94050-06060 (NUT)
	SHAFT FLANGE AND ENG OUTPUT FLANGE	M8X1.25	2.4~3.2	24~32	2.8	20	95701-08020-06
	MUFFLER PROTECTOR AND FRAME	M6X1.0	0.9~1.3	9~13	1.1	8	96001-06010-06
	OIL HOSE AND JOINT	-	0.3~0.4	3~4	0.35	2.5	19504-LBA2-E000
	GEARCASE AND FRAME	M10X1.25	4.5~6.1	45~61	5.3	38	95801-10110-06
	FUEL VALVE AND TANK	M6X1.0	0.6~0.8	6~8	0.7	4.5~5.4	94050-PWA2-9000
	SHIFT ASSY AND FRAME	M8X1.25	2.4~3.2	24~32	2.8	20	95701-08012-06
	FWD/REV SHIFT ASSY	M8X1.25	0.9~1.3	9~13	1.1	8	95701-08020-06
	KNOB,FUEL ROTATE AND FUEL VALVE	M4X0.7	0.1~0.2	1 ~ 2	0.15	1.1	93500-04010-07

Standard Torque (engine Parts)

NO	ITEM	THREAD SIZE AND TYPE	TORQUE		PR VALUES N·m	REMARKS	THREAD DWG. NO.
			N·m	kg·m			
1	CRANKCASE/ COVER SET	M6x1.0	8.8~12.8	0.9~1.3	10.8		95701-06045-08
		M6x1.0	8.8~12.8	0.9~1.3	10.8		95701-06070-08
		M8x1.25	28±5%	2.9±5%	28	APPLY OIL	95701-08050-08
		M8x1.25	28±5%	2.9±5%	28	APPLY OIL	95701-08060-08
		M8x1.25	28±5%	2.9±5%	28	APPLY OIL	95701-06085-08
2	CYLINDER HEAD	BOLT UBS M10x170	37.3±5%	3.8±5%	37.3	APPLY OIL	90031-PWB1-9000
		BOLT UBS M10x180	37.3±5%	3.8±5%	37.3	APPLY OIL	90032-PWB1-9000
		BOLT M6X1.0	10.8±1	1.1±0.1	10.8		96001-06110-06
		BOLT M6X1.0	10.8±1	1.1±0.1	10.8		96001-06060-08
		BOLT M6X1.0	10.8±1	1.1±0.1	10.8	APPLY OIL	96001-06030-02
		NUT M6X1.0	10.8±1	1.1±0.1	10.8		96001-06020-00
3	HEAD COVER	M6x1.0	9.8±1	1.0±0.1	9.8		96001-06020-06
4	SPARK PLUG	M10x1.0	9.8~13.7	1.0~1.4	11.8		98059-57916-00
5	TAPPET ADJ. NUT	M5x0.5	6.9~10.8	0.7~1.1	8.9		90206-001-0010
6	TENSIONER LIFTER	SHF M6x1.0	9.8~13.7	1.0~1.4	11.8		96001-06018-06
7	SHAFT ROCKER ARM	SPECIAL SCREW M14x1.5	33.4±5%	3.4±5%	33.4	THREAD LOCK	90020-PWB1-9000
8	CAM CHAIN TENSIONER PIVOT	SPECIAL BOLT M8x1.25	14~16	1.4~1.6	15		14531-PWB1-9000
9	ACG ONE WAY	BOLT SOCKET M8x1.25	17.7~21.6	1.8~2.2	19.7	THREAD LOCK	90205-LDB5-E000
10	SPROCKET CAMSHAFT	M6x1.0	14.7±1	1.5±0.1	14.7	THREAD LOCK	90083-KED9-9000
11	ACG FLYWHEEL	M16X1.5	145±5%	14.5±5%	145		90205-LDB5-E000
12	OIL FILTER	M20x1.5	7.8~11.8	0.8~1.2	9.8		1541A-PWB1-9000
13	OIL PUMP DRIVE GEAR	M10X1.25	49.0±5%	5±5%	49.0	THREAD LOCK	95701-PWB1-9000
14	NUT, FINAL SHAFT	M16.1.5	98±5%	10±5%	98.0	THREAD LOCK	90204-PWB1-9000
15	R CASE OIL DRAIN PLUG	M14X1.25	26.5±5%	2.7±5%	26.5		90036-PWB1-9000
16	WET CLUTCH	M18x1.5	200±5%	20.4±5%	200	THREAD LOCK	94052-PWB1-9000
17	DRIVE FACE	M16x1.5	115±5%	11.7±5%	115	THREAD LOCK	94001-PWB1-9000
18	PULLEY, DRIVEN	M16x1.5	115±5%	11.7±5%	115	THREAD LOCK	94001-PWB1-9000
19	OIL, FITTING	M6X1.0	7.8±1	0.8±0.1	7.8	APPLY OIL	96001-06012-08
20	BEVEL GEAR, DRIVE	M20x1.0	98.0±5%	10±5%	98.0	APPLY OIL	90202-PWB1-9000
21	BEVEL GEAR, DRIVEN	M22x1.0	137.2±5%	14±5%	137.2	APPLY OIL	90203-PWB1-9000
22	PLUG BY OIL FILTER ON THE LEFT CASE	M14X1.5	27±5%	2.7±5%	27		90081-0E35-0010

Break-In Procedure

A new ATV and an overhauled ATV engine require a "break-in" period. The first 10 hours (or 200 miles) are most critical to the life of this ATV. Proper operation during this break-in period will help assure maximum life and performance from the ATV.

During the first 10 hours (or 200 miles) of operation, always use less than 1/2 throttle. Varying the engine RPM during the break-in period allows the components to "load" (aiding the mating process) and then "unload" (allowing components to cool). Although it is essential to place some stress on the engine components during break-in, care should be taken not to overload the engine too often. Do not pull a trailer or carry heavy loads during the 10-hour break-in period.

When the engine starts, allow it to warm up properly. Idle the engine several minutes until the engine has reached normal operating temperature. Do not idle the engine for excessively long periods of time.

During the break-in period, a maximum of 1/2 throttle is recommended; however, brief full-throttle accelerations and variations in driving speeds contribute to good engine break-in.

After the completion of the break-in period, the engine oil and oil filter should be changed. Other maintenance after break-in should include checking of all pre-scribed adjustments and tightening of all fasteners.

Gasoline - Oil - Lubricant

RECOMMENDED GASOLINE

The recommended gasoline to use is 87 minimum octane regular unleaded. In many areas, oxygenates (either ethanol or MTBE) are added to the gasoline. Oxygenated gasolines containing up to 10% ethanol, 5% methane, or 5% MTBE are acceptable gasolines.

When using ethanol blended gasoline, it is not necessary to add a gasoline antifreeze since ethanol will prevent the accumulation of moisture in the fuel system.

RECOMMENDED ENGINE/ TRANSMISSION OIL

CAUTION

Any oil used in place of the recommended oil could cause serious engine damage. Do not use oils which contain graphite or molybdenum additives. These oils can adversely affect clutch operation. Also, not recommended are racing, vegetable, non-detergent, and castor-based oils.

The recommended oil that using of any API certified SM 5W-50 oil is acceptable.

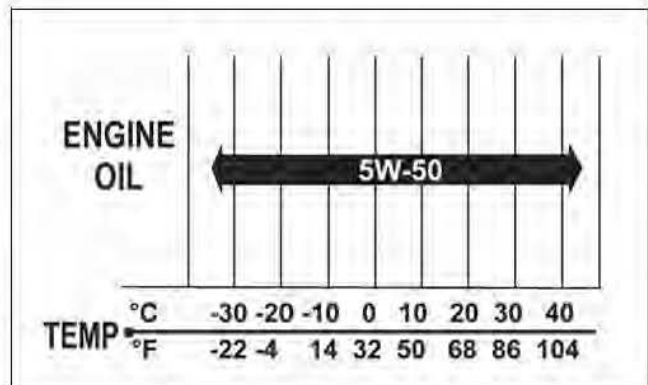

RECOMMENDED FRONT DIFFERENTIAL/REAR DRIVE LUBRICANT

The recommended lubricant is KYMCO Gear Lube or an equivalent gear lube which is SAE approved 80W-90 hypoid. This lubricant meets all of the lubrication requirements of the KYMCO ATV front differentials and rear drives.

CAUTION

Any lubricant used in place of the recommended lubricant could cause serious front differential/rear drive damage.

FILLING GAS TANK

WARNING

Always fill the gas tank in a well-ventilated area. Never add fuel to the ATV gas tank near any open flames or with the engine running. DO NOT SMOKE while filling the gas tank.

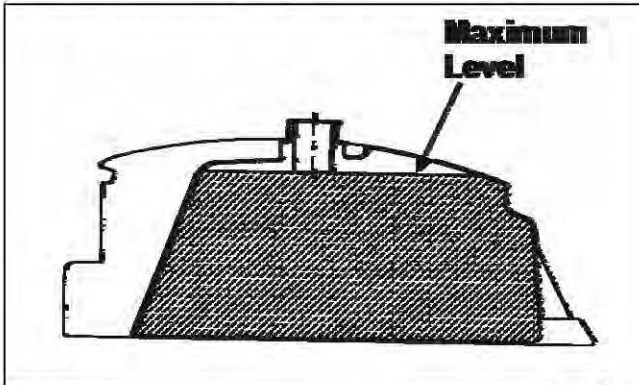

ATV0049B

Since gasoline expands as its temperature rises, the gas tank must be filled to its rated capacity only. Expansion room must be maintained in the tank particularly if the tank is filled with cold gasoline and then moved to a warm area.

WARNING

Do not overflow gasoline when filling the gas tank. A fire hazard could materialize. Always allow the engine to cool before filling the gas tank.

Tighten the gas tank cap securely after filling the tank.

WARNING

Do not over-fill the gas tank.

Genuine Parts

When replacement of parts is necessary, use only genuine KYMCO ATV parts. They are precision-made to ensure high quality and correct fit. Refer to the appropriate Illustrated Parts Manual for the correct part number, quantity, and description.

Preparation For Storage

CAUTION

Prior to storing the ATV, it must be properly serviced to prevent rusting and component deterioration.

KYMCO recommends the following procedure to prepare the ATV for storage.

1. Clean the seat cushion (cover and base) with a damp cloth and allow it to dry.
2. Clean the ATV thoroughly by washing dirt, oil, grass, and other foreign matter from the entire ATV. Allow the ATV to dry thoroughly. DO NOT get water into any part of the engine or air intake.
3. Either drain the gas tank or add Fuel Stabilizer to the gas in the gas tank. Remove the air filter housing cover and air filter. Start the engine and allow it to idle; then using KYMCO Engine Storage Preserver, rapidly inject the preserver into the air filter opening for a period of 10 to 20 seconds; then stop the engine. Install the air filter and housing cover.

CAUTION

If the interior of the air filter housing is dirty, clean the area before starting the engine.

4. Empty the fuel in the fuel tank.
5. Plug the exhaust outlet on the muffler with a clean cloth.
6. Apply light oil to the upper steering post bushing and plungers of the shock absorbers.
7. Tighten all nuts, bolts, cap screws, and screws. Make sure rivets holding components together are tight. Replace all loose rivets. Care must be taken that all calibrated nuts, cap screws, and bolts are tightened to specifications.
8. Disconnect the battery cables; then remove the battery, clean the battery posts and cables, and store in a clean, dry area.
9. Store the ATV indoors in a level position.

CAUTION

Avoid storing outside in direct sunlight and avoid using a plastic cover as moisture will collect on the ATV causing rusting.

Preparation After Storage

Taking the ATV out of storage and correctly preparing it will assure many miles and hours of trouble-free riding. KYMCO recommends the following procedure to prepare the ATV.

1. Clean the ATV thoroughly.
2. Clean the engine. Remove the cloth from the muffler.

3. Check all control cables for signs of wear or fraying. Replace if necessary.
4. Change the engine/transmission oil and filter.
5. Charge the battery; then install. Connect the battery cables.

CAUTION

The ignition switch must be in the OFF position prior to installing the battery or damage may occur to the ignition system.

CAUTION

Connect the positive battery cable first, then the negative.

6. Check the entire brake systems (fluid level, pads, etc.), all controls, lights, and headlight aim; adjust or replace as necessary.
7. Tighten all nuts, bolts, cap screws, and screws making sure all calibrated nuts, cap screws, and bolts are tightened to specifications.
8. Check tire pressure, Inflate to recommended pressure as necessary.
9. Make sure the steering moves freely and does not bind.
10. Check the spark plug. Clean or replace as necessary.

SECTION 2 - PERIODIC MAINTENANCE

TABLE OF CONTENTS

Periodic Maintenance Chart	2-2
Periodic Maintenance	2-3
Lubrication Points	2-3
Battery	2-3
Fuses	2-4
Air Filter	2-4
Valve/Tappet Clearance (Feeler Gauge Procedure)	2-6
Valve/Tappet Clearance (Valve Adjuster Procedure)	2-6
Testing Engine Compression	2-7
Spark Plug	2-8
Muffler/Spark Arrester	2-8
Adjusting Throttle Cable	2-9
Engine/Transmission Oil - Filter - Strainer	2-9
Front Differential/Rear Drive Lubricant	2-11
Tires	2-12
Steering Components	2-12
Driveshaft/Coupling	2-12
Suspension/Shock Absorbers/Bushings	2-12
Nuts/Bolts/Cap Screws	2-12
Lights	2-13
Shift Lever	2-15
Frame/Welds/Racks	2-15
Electrical Connections	2-15
Hydraulic Brake Systems	2-15
Burnishing Brake Pads	2-17
Checking/Replacing V-Belt	2-17

Periodic Maintenance Chart

A = Adjust I = Inspect
 C = Clean L = Lubricate
 D = Drain R = Replace
 T = Tighten

Item	Initial Service After Break-In (First Mo or 100 Mi)	Every Day	Every Month or Every 100 Miles	Every 3 Months or Every 300 Miles	Every 6 Months or Every 500 Miles	Every Year or Every 1500 Miles	As Needed
Battery	I		I				C
Fuses				I			R
Air Filter/Drain Tube	I	I	C*				R
Valve/Tappet Clearance	I				I		A
Engine Compression						I	
Spark Plug	I			I			R (4000 Mi or 18 Mo)
Muffler/Spark Arrester					C		R
Gas/Vent Hoses	I	I					R (2 Yrs)
Throttle Cable	I	I			C-L		A-R
Coolant / Cooling System	I		I				R (2 Yrs)
Engine-Transmission Oil Level		I					A
Engine-Transmission Oil/Filter	R			R*			R
Oil Strainer	I				I		C
Front Differential/Rear Drive Lubricant	I		I				R (4 Yrs)
Tires/Air Pressure	I	I					R
Steering Components	I	I		I			R
V-Belt	I				I		R
Suspension (Ball joint boots, drive axle boots front and rear, tie rods, differential and rear drive bellows)	I	I					R
Nuts/Cap Screws/Screws	I		T				A
Throttle Body/EMS Sensor	I				I		C
Lights	I	I					R
Switches	I	I					R
Shift Lever					I		A-L
Handlebar Grips		I					R
Handlebars	I	I					R
Gauges/Indicators	I	I					R
Frame/Welds/Racks	I				I		
Electrical Connections	I				I		C
Complete Brake System (Hydraulic & Auxiliary)	I	I		C			L-R
Brake Pads	I			I*			R
Brake Fluid	I			I			R (2 Yrs)
Brake Hoses	I			I			R (4 Yrs)

* Service/Inspect more frequently when operating in adverse conditions.

Periodic Maintenance

This section has been organized into sub-sections which show common maintenance procedures for the KYMCO ATV.

- **NOTE:** KYMCO recommends the use of new gaskets, lock nuts, and seals and lubricating all internal components when servicing the engine/transmission.
- **NOTE:** Some photographs and illustrations used in this section are used for clarity purposes only and are not designed to depict actual conditions.
- **NOTE:** Critical torque specifications are located in Section 1.

SPECIAL TOOLS

A number of special tools must be available to the technician when performing service procedures in this section.

Description	p/n
Compression Tester Kit	
Oil Filter Wrench	E052
Tachometer	
Valve Clearance Adjuster	E012

- **NOTE:** Special tools are available from the KYMCO Spare Parts Department.

Lubrication Points

It is advisable to lubricate certain components periodically to ensure free movement. Apply light oil to the components using the following list as reference.

- A. Throttle Lever Pivot/Cable Ends
- B. Brake Lever Pivot/Cable Ends
- C. Auxiliary Brake Cable Ends
- D. Shift Lever Cable End

Battery

After being in service, batteries require regular cleaning and recharging in order to deliver peak performance and maximum service life. The following procedure is recommended for cleaning and maintaining lead-acid batteries. Always read and follow instructions provided with battery chargers and battery products.

WARNING

Anytime service is performed on a battery, the following must be observed: keep sparks, open flame, cigarettes, or any other flame away. Always wear safety glasses. Protect skin and clothing when handling a battery. When servicing battery in enclosed space, keep the area well-ventilated.

1. Remove the battery hold-down; then disconnect the battery cables (negative cable first).
2. Remove the battery from the battery compartment;
3. then thoroughly wash the battery and battery compartment with soap and water.

- **NOTE:** If battery posts, cable ends, or the battery case has a build-up of white/green powder residue, apply water and baking soda to neutralize acid; then flush off with warm soapy water.

4. Using a wire brush, clean the battery posts and cable ends removing all corrosive buildup. Replace damaged cables or cable ends.

WARNING

Battery acid is harmful if it contacts eyes, skin, or clothing. Care must be taken whenever handling a battery.

CAUTION

Never use electrolyte (sulfuric acid) to "top off" the battery. Use only distilled water or severe battery damage may occur.

5. Using a multimeter, test the battery voltage. The meter must read 12.5 or more DC Volts for a fully charged battery.

- **NOTE:** At this point, if the meter reads as specified, the battery may be returned to service (see step 10).

6. If the meter reads less than specified voltage, charge the battery using the following guidelines.

- A. When using an automatic battery charger, always follow the charger manufacturer's instructions.
- B. When using a constant-current battery charger, use the following Battery Charging Chart.

⚠ CAUTION		
Never exceed the standard charging rate.		
⚠ WARNING		
An overheated battery could explode causing severe injury or death. Always monitor charging times and charge rates carefully. Stop charging if the battery becomes very warm to the touch. Allow it to cool before resuming charging.		
Battery Charging Chart (Constant-Current Charger)		
Battery Voltage (DC)	Charge State	Charge Time Required (at 1.5-2.0 Amps)
12.5 or more	100%	None
12.2-12.4	75%-99%	3-6 hours
12.0-12.2	50%-74%	5-11 hours
11.0-11.9	25%-49%	13 hours (minimum)
11.5 or less	0-24%	20 hours (minimum)

■NOTE: If the battery voltage is 11.5 DC Volts or less, some chargers may "cut off" and fail to charge. If this occurs, connect a fully charged booster battery in parallel (positive to positive and negative to negative) for a short period of time with the charger connected. After 10-15 minutes, disconnect the booster battery leaving the charger connected and the charger should continue to charge. If the charger "cuts off," replace the battery.

8. After charging the battery for the specified time, remove the battery charger and allow the battery to sit for 1-2 hours.
 9. Connect the multimeter and test the battery voltage. The meter should read 12.5 or more DC Volts. If the voltage is as specified, the battery is ready for service.
- NOTE: If voltage in step 9 is below specifications, charge the battery an additional 1-5 hours; then retest.
10. Place the battery in the battery compartment; then coat the battery posts and cable ends with a light coat of multi-purpose grease.

⚠ CAUTION
Before installing the battery, make sure the ignition switch is in the OFF position.

11. Connect the battery cables (positive cable first); then install the battery hold-down.

⚠ CAUTION
Connecting cables in reverse (positive to negative and negative to positive) can cause serious damage to the electrical system.

Fuses

The fuses are located in a power distribution module in front of the steering post. In addition, there is a 30 amp fuse on the starter relay under the seat next to the battery.

If there is any type of electrical system failure, always check the fuses first.

■NOTE: To remove a fuse, compress the locking tabs on either side of the fuse case and lift out.

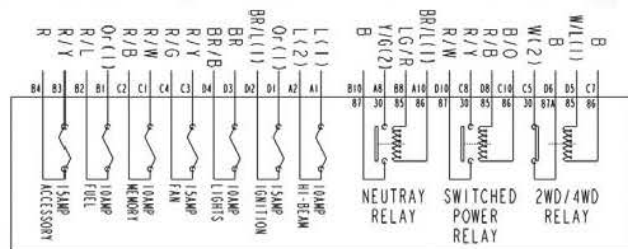

⚠ CAUTION
Always replace a blown fuse with a fuse of the same type and rating.

Air Filter

Use the following procedure to remove the filter and inspect and/or clean it.

CLEANING AND INSPECTING FILTER

1. Rotate the three locking tabs free of the lugs on the air filter cover; then rotate the cover forward and away from the filter housing.

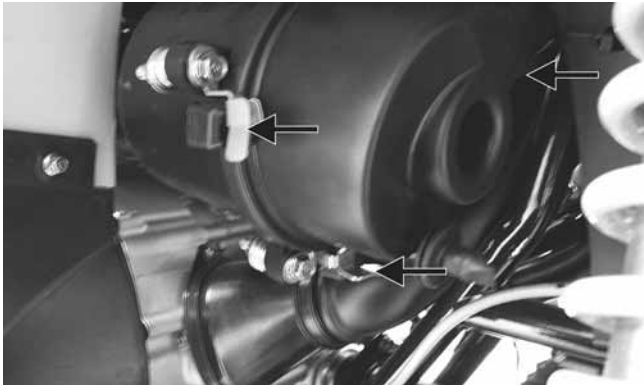

KC0056A



KC147

2. Remove the foam filter element from the air filter housing and separate the foam element from the spring.



KC148

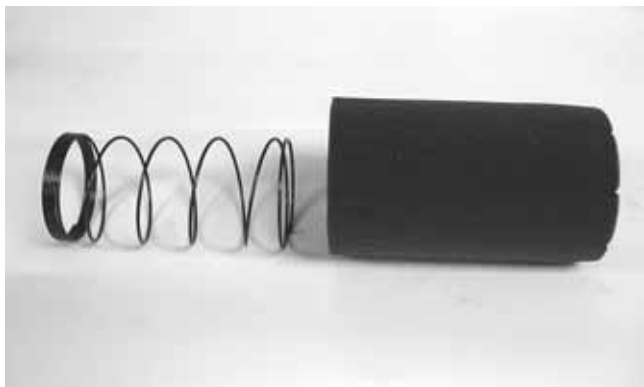

KC143

3. Fill a wash pan larger than the element with a non-flammable cleaning solvent; then dip the element in the solvent and wash it.

4. Dry the element.

5. Put the element in a plastic bag; then pour in air filter oil and work the oil into the element. Insert the forming spring into the element with the closely wrapped end of the spring toward the open end of the element.

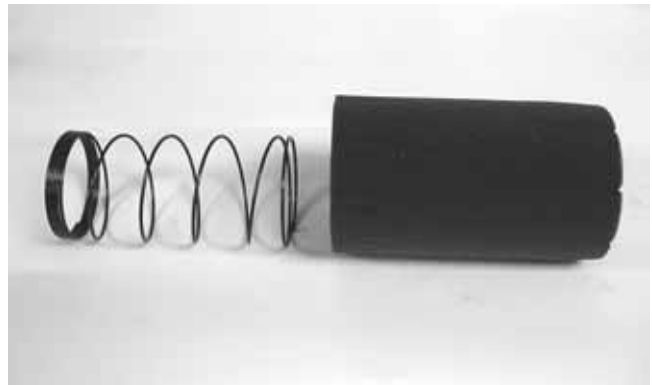

KC143

CAUTION

A torn air filter element can cause damage to the ATV engine. Dirt and dust may get inside the engine if the element is torn. Carefully examine the element for tears before and after cleaning it. Replace the element with a new one if it is torn.

6. Clean any dirt or debris from inside the air cleaner. Be sure no dirt enters the carburetor (if equipped).

7. Place the filter assembly in the air filter housing making sure it is properly positioned and properly seated with the filter element straight in the housing.



KC147

CAUTION

Failure to properly seat and align the filter element may cause severe engine damage.

8. Install the air filter housing cover and secure with the locking tabs.



KC123

CHECKING AND CLEANING DRAIN

1. Inspect the drain on the filter housing cover and clean out any dirt or debris.



KC0056C

2. Replace any drain that is cracked or shows any signs of hardening or deterioration.
3. Wipe any accumulation of oil or gas from the filter housing and drain.

Valve/Tappet Clearance (Feeler Gauge Procedure)

To check and adjust valve/tappet clearance, use the following procedure.

■NOTE: The seat, left-side and right-side engine covers, and gas tank must be removed for this procedure.

1. Remove the timing inspection plug and spark plug; then remove the tappet covers (for more detailed information, see Section 3 - Servicing Top-Side Components).
2. Rotate the crankshaft to the TDC position on the compression stroke.

■NOTE: At this point, the rocker arms and adjuster screws must not have pressure on them.

3. Using a feeler gauge, check each valve/tappet clearance. If clearance is not within specifications, loosen the jam nut and rotate the tappet adjuster screw until the clearance is within specifications. Tighten each jam nut securely after completing the adjustment.

⚠ CAUTION

The feeler gauge must be positioned at the same angle as the valve and valve adjuster for an accurate measurement of clearance. Failure to measure the valve clearance accurately could cause valve component damage.

VALVE/TAPPET CLEARANCE

Intake	0.10 mm
Exhaust	0.17 mm



CC007DC

4. Install the timing inspection plug.
5. Place the two tappet covers with O-rings into position; then tighten the covers securely.
6. Install the spark plug; then install the timing inspection plug.

Valve/Tappet Clearance (Valve Adjuster Procedure)

To check and adjust valve/tappet clearance, use the following procedure.

■NOTE: The seat, left-side and right-side engine covers, and gas tank must be removed for this procedure.

1. Remove the timing inspection plug and spark plug; then remove the tappet covers (for more detailed information, see Section 3 - Servicing Top-Side Components).



CF005

2. Rotate the crankshaft to the TDC position on the compression stroke.

■NOTE: At this point, the rocker arms and adjuster screws must not have pressure on them.

■NOTE: Use Valve Clearance Adjuster for this procedure.

3. Place the valve adjuster onto the jam nut securing the tappet adjuster screw; then rotate the valve adjuster dial clockwise until the end is seated in the tappet adjuster screw.
4. While holding the valve adjuster dial in place, use the valve adjuster handle and loosen the jam nut; then rotate the tappet adjuster screw clockwise until friction is felt.
5. Align the valve adjuster handle with one of the marks on the valve adjuster dial.
6. While holding the valve adjuster handle in place, rotate the valve adjuster dial counterclockwise until proper valve/tappet clearance is attained.

■NOTE: Refer to the appropriate specifications in Feeler Gauge Procedure sub-section for the proper valve/tappet clearance.

■NOTE: Rotating the valve adjuster dial counterclockwise will open the valve/tappet clearance by 0.05 mm (0.002 in.) per mark.

7. While holding the adjuster dial at the proper clearance setting, tighten the jam nut securely with the valve adjuster handle.
8. Place the two tappet covers with O-rings into position; then tighten the covers securely.
9. Install the spark plug; then install the timing inspection plug.

Testing Engine Compression

To test engine compression, use the following procedure.

1. Remove the high tension lead from the spark plug.
2. Using compressed air, blow any debris from around the spark plug.

⚠ WARNING

Always wear safety glasses when using compressed air.

3. Remove the spark plug; then attach the high tension lead to the plug and ground the plug on the cylinder head well away from the spark plug hole.

4. Attach the Compression Tester Kit.

■NOTE: The engine must be warm and the battery must be fully charged for this test.

5. While holding the throttle lever in the full-open position, crank the engine over with the electric starter until the gauge shows a peak reading of 170-227 psi (five to 10 compression strokes).
6. If compression is abnormally low, inspect the following items.
 - A. Verify starter cranks engine over at normal speed (approximately 400 RPM).
 - B. Gauge functioning properly.
 - C. Throttle lever in the full-open position.
 - D. Valve/tappet clearance correct.
 - E. Valve not bent or burned.
 - F. Valve seat not burned.

■NOTE: To service valves, see Section 3.

7. Pour 29.5 ml (1 fl oz) of oil into the spark plug hole, reattach the gauge, and retest compression.
8. If compression is now evident, service the piston rings (see Section 3).

Spark Plug

A light brown insulator indicates that a plug is correct. A white or dark insulator indicates that the engine may need to be serviced or the carburetor may need to be adjusted. To maintain a hot, strong spark, keep the plug free of carbon.

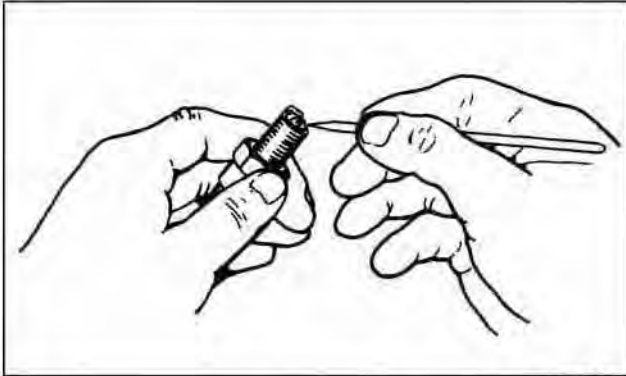

ATV-0051

CAUTION

Before removing a spark plug, be sure to clean the area around the spark plug. Dirt could enter engine when removing or installing the spark plug.

Adjust the gap to 0.7-0.8 mm (0.028-0.032 in.) for proper ignition. Use a feeler gauge to check the gap.

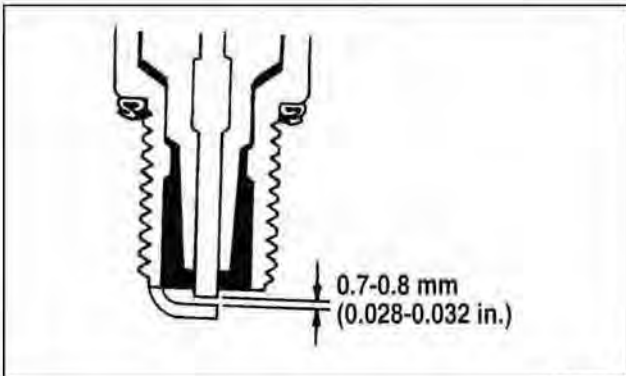

ATV0052C

When installing the spark plug, be sure to tighten it securely. A new spark plug should be tightened 1/2 turn once the washer contacts the cylinder head. A used spark plug should be tightened 1/8 - 1/4 turn once the washer contacts the cylinder head.

Muffler/Spark Arrester

At the intervals shown in the Periodic Maintenance Chart, clean the spark arrester using the following procedure.

WARNING

Wait until the muffler cools to avoid burns.

1. Remove the cap screws securing the spark arrester assembly to the muffler; then loosen and remove the arrester.



2. Using a suitable brush, clean the carbon deposits from the screen taking care not to damage the screen.

■NOTE: If the screen or gasket is damaged in any way, it must be replaced.

3. Install the spark arrester assembly with gasket; then secure with the cap screws. Tighten to 48 in.-lb.



KC145

Adjusting Throttle Cable

To adjust the throttle cable free-play, follow this procedure.

1. Slide the rubber boot away, then loosen the jam nut from the throttle cable adjuster.



AL611D

2. Turn the adjuster until the throttle cable has proper free-play of 3-6 mm (1/8-1/4 in.) at the lever.

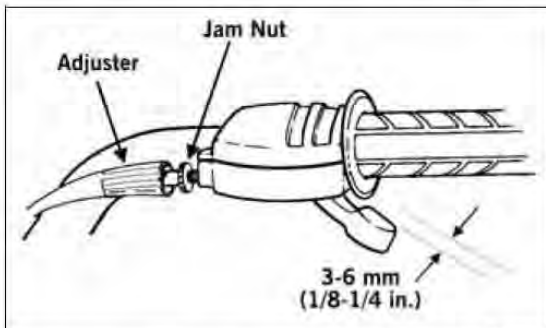

ATV-0047

3. Tighten the jam nut against the throttle cable adjuster securely, then slide the rubber boot over the adjuster.

Engine/Transmission Oil - Filter - Strainer

OIL - FILTER

The engine should always be warm when the oil is changed so the oil will drain easily and completely.

1. Park the ATV on level ground.
2. Remove the seat and left-side engine cover.
3. Remove the oil level stick/filler plug.

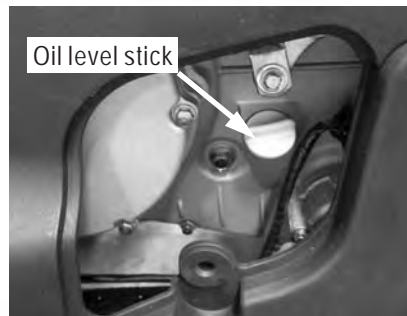

4. Remove the drain plug from the bottom of the engine and drain the oil into a drain pan.

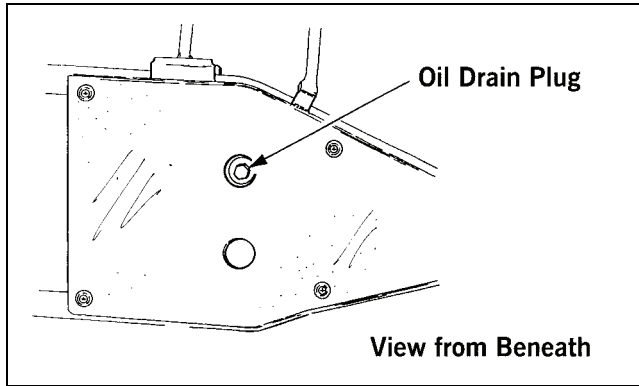

733-441A

5. Remove the oil filter plug from the filter mounting boss (located on the front side of the transmission case) and allow the filter to drain completely. Install the plug and tighten securely.
6. Using the adjustable Oil Filter Wrench and a suitable wrench, remove the old oil filter.

■NOTE: Clean up any excess oil after removing the filter.

7. Apply oil to a new filter seal ring and check to make sure it is positioned correctly; then install the new oil filter. Tighten securely.
8. Install the engine drain plug and tighten to 20 ft-lb. Pour the specified amount of the recommended oil in the filler hole. Install the oil level stick/filler plug.

⚠ CAUTION

Any oil used in place of the recommended oil could cause serious engine damage. Do not use oils which contain graphite or molybdenum additives. These oils can adversely affect clutch operation. Also, not recommended are racing, vegetable, non-detergent, and castor-based oils.

9. Start the engine (while the ATV is outside on level ground) and allow it to idle for a few minutes.
10. Turn the engine off and wait approximately one minute.
11. Remove the oil level stick and wipe it with a clean cloth.
12. Install the oil level into engine case.

■NOTE: The oil level stick should be threaded into the case for checking purposes.

13. Remove the oil level stick; the engine oil level should be above the illustrated "L" mark but not higher than the illustrated "F" mark.

⚠ CAUTION

Do not over-fill the engine with oil. Always make sure that the oil level is above the "L" mark but not higher than the "F" mark.

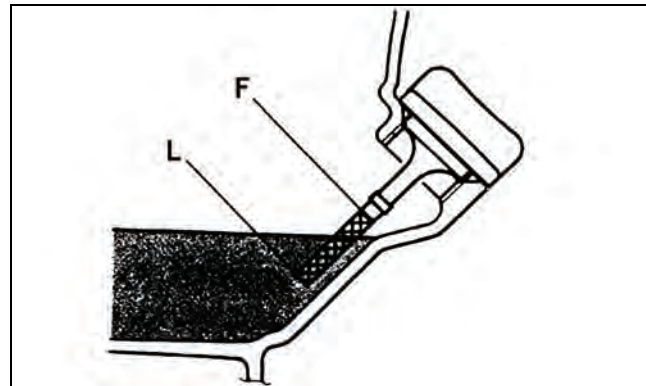

ATV-0100AA

14. Inspect the area around the drain plug and oil filter for leaks.
15. Install the left-side engine cover and the seat.

STRAINER

1. Remove the belly panel.
2. Remove the cap screws securing the oil strainer cap; then remove the cap. Account for the O-ring.



CC091D

3. Remove the two cap screws securing the strainer; then remove the strainer.

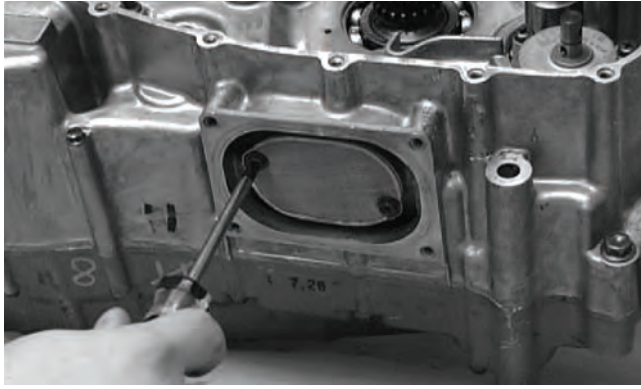

CC163D

AT THIS POINT

To check/service oil strainer, see Section 3.

4. Place the oil strainer into position beneath the crankcase and secure with the cap screws. Tighten securely.
5. Place the strainer cap into position on the strainer making sure the O-ring is properly installed; then secure with the cap screws. Tighten securely.



CC091D

6. Install the belly panel.

Front Differential/Rear Drive Lubricant

When changing the lubricant, use approved SAE 80W-90 hypoid gear lube.

To check lubricant, remove the rear drive filler plug; the lubricant level should be 1 in. below the threads of the plug. If low, add SAE approved 80W-90 hypoid gear lubricant as necessary.

To change the lubricant, use the following procedure.

1. Place the ATV on level ground.
2. Remove each oil fill plug.

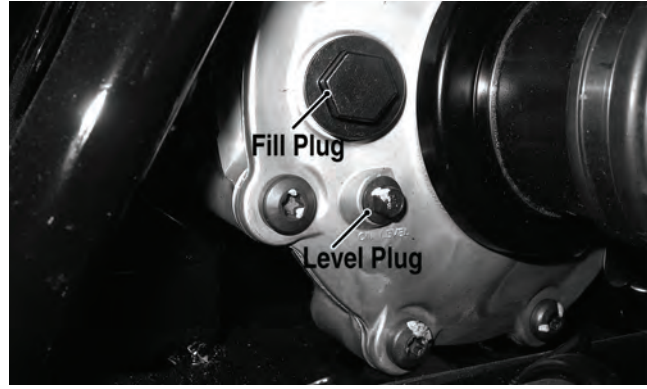

KC0077A

3. Drain the oil into a drain pan by removing the drain plug from each.

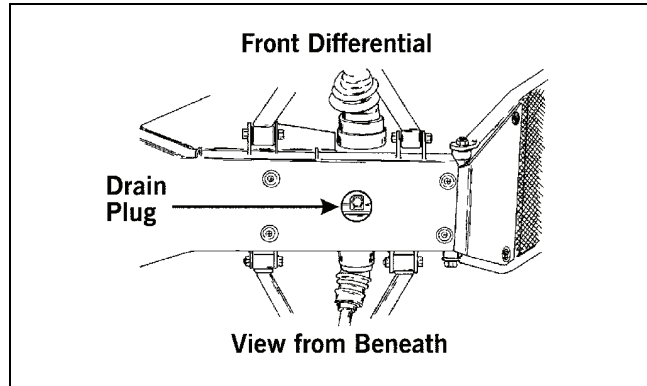

ATV0082A

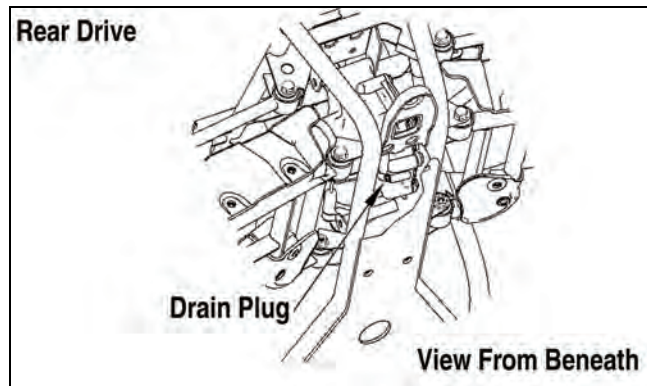

737-651B

4. After all the oil has been drained, install the drain plugs and tighten to 45 in.-lb.
5. Pour the appropriate amount of approved SAE 80W-90 hypoid gear lubricant into the filler hole.
6. Install the fill plugs.

■ **NOTE:** If the differential/rear drive oil is contaminated with water, inspect the drain plug, filler plug, and/or bladder.

CAUTION

Water entering the outer end of the axle will not be able to enter the rear drive unless the seals are damaged.

2

Tires

TIRE SIZES

The ATV is equipped with low-pressure tubeless tires of the size and type listed (see Section 1). Do not under any circumstances substitute tires of a different type or size.

 **WARNING**

**Always use the size and type of tires specified.
Always maintain proper tire inflation pressure.**

TIRE INFLATION PRESSURE

Front and rear tire inflation pressure should be 0.28 kg-cm² (4.0 psi).

Steering Components

The following steering components should be inspected periodically to ensure safe and proper operation.

- A. Handlebar grips not worn, broken, or loose.
- B. Handlebar not bent, cracked, and has equal and complete full-left and full-right capability.
- C. Steering post bearing assembly/bearing housing not broken, worn, or binding.
- D. Ball joints not worn, cracked, or damaged.
- E. Tie rods not bent or cracked.
- F. Knuckles not worn, cracked, or damaged.
- G. Cotter pins not damaged or missing.

Driveshaft/Coupling

The following drive system components should be inspected periodically to ensure proper operation.

- A. Spline lateral movement (slop).
- B. Coupling cracked, damaged, or worn.

Suspension/Shock Absorbers/Bushings

The following suspension system components should be inspected periodically to ensure proper operation.

- A. Shock absorber rods not bent, pitted, or damaged.
- B. Rubber damper not cracked, broken, or missing.
- C. Shock absorber body not damaged, punctured, or leaking.
- D. Shock absorber eyelets not broken, bent, or cracked.
- E. Shock absorber eyelet bushings not worn, deteriorated, cracked, or missing.
- F. Shock absorber spring not broken or sagging.

Nuts/Bolts/Cap Screws

Tighten all nuts, bolts, and cap screws. Make sure rivets holding components together are tight. Replace all loose rivets. Care must be taken that all calibrated nuts, bolts, and cap screws are tightened to specifications.

Lights

Rotate the ignition switch to the lights position; the headlights and taillights should illuminate. Test the brakelights by compressing the brake lever. The brakelights should illuminate.

HEADLIGHTS

■NOTE: The bulb portion of a headlight is fragile. HANDLE WITH CARE. When replacing a headlight bulb, do not touch the glass portion of the bulb. If the glass is touched, it must be cleaned with a dry cloth before installing. Skin oil residue on the bulb will shorten the life of the bulb.

⚠ WARNING

Do not attempt to remove a bulb when it is hot. Severe burns may result.

To replace the headlight bulb, use the following procedure.

1. Remove the protective rubber boot from the rear of the headlight housing; then remove the wiring harness connector from the back of the headlight bulb.



2. Press in and release the spring retainer and pull rearward clear of the bulb assembly.



KC163A

3. Remove the headlight bulb assembly from the headlight housing.
4. Install the new headlight bulb into the headlight housing being careful not to get fingerprints or other contaminants on the glass; then secure with the spring.

2



KC163B

5. Connect the wiring harness connector to the bulb; then install the protective rubber boot making sure it seals completely on the headlight harness.



TAILLIGHTS-BRAKELIGHTS

To replace a taillight-brakelight bulb, use the following procedure.

1. Turn the bulb socket assembly counterclockwise and remove from the housing.



2. Press in and turn the bulb counterclockwise to remove. Press in and turn clockwise to install the bulb.
3. Insert the bulb socket assembly into the housing and turn it clockwise to secure.

RUNNING LIGHTS/BACK-UP LIGHTS

The running lights are located outboard of the headlights, and the back-up lights are outboard of the tail-lights/brakelights. To replace the bulbs, use the following procedure.

1. Rotate the bulb socket counterclockwise to release from light housing; then press in on the bulb and turn counterclockwise to release from the socket.

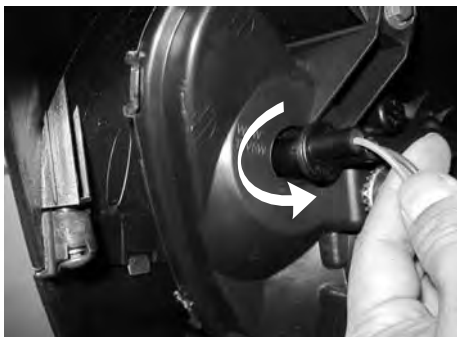

2. Install a new bulb and press in rotating clockwise to secure; then place the socket into the light housing and turn clockwise to secure.



CHECKING/ADJUSTING HEADLIGHT AIM

The headlights can be adjusted vertically and horizontally. The geometric center of the HIGH beam light zone is to be used for vertical and horizontal aiming.

1. Position the ATV on a level floor so the headlights are approximately 6.1 m (20 ft) from an aiming surface (wall or similar aiming surface).

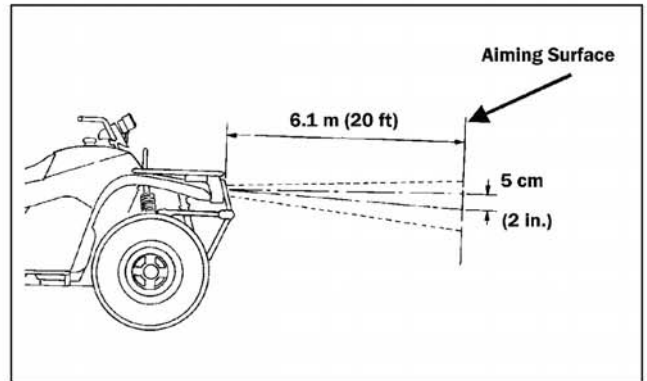

ATV-0070C

■NOTE: There should be an average operating load on the ATV when adjusting the headlight aim.

2. Measure the distance from the floor to the mid-point of each headlight.
3. Using the measurements obtained in step 2, make horizontal marks on the aiming surface.
4. Make vertical marks which intersect the horizontal marks on the aiming surface directly in front of the headlights.
5. Switch on the lights. Make sure the HIGH beam is on. DO NOT USE LOW BEAM.
6. Observe each headlight beam aim. Proper aim is when the most intense beam is centered on the vertical mark 5 cm (2 in.) below the horizontal mark on the aiming surface.
7. To **raise** a headlight beam, turn the adjusting bolt in direction (a).
To **lower** a headlight beam, turn the adjusting bolt in direction (b).
To **inner** a headlight beam, turn the adjusting bolt in direction (c).
To **outer** a headlight beam, turn the adjusting bolt in direction (d).

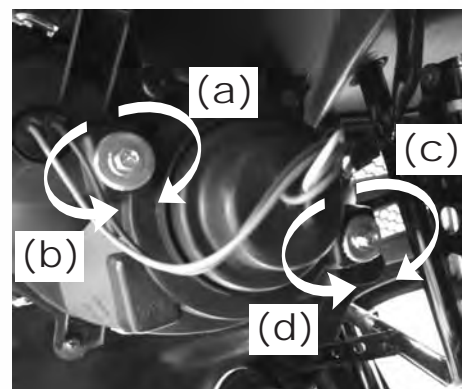

Shift Lever

CHECKING ADJUSTMENT



Low range High range Neutral Reverse

With the engine stopped and the brake lever lock engaged, turn the ignition switch to the ON position; then shift the transmission into each of the gear positions and note that the gear position indicated on the LCD corresponds to the gear position selected by the lever.

If the indicator does not correspond to the selected gear, it will be necessary to test drive the ATV to determine if the gear shift position switch is faulty or the shift lever needs adjustment.

If the ATV functions in the gear selected by the shift lever, troubleshoot the gear shift position switch (see Section 5).

If the ATV functions but the shift lever does not correspond with the gear indicated on the LCD, adjust the shift linkage. To adjust, proceed to ADJUSTING.

ADJUSTING

1. Remove the seat; then remove the left-side engine cover.
2. With the ignition switch in the ON position, loosen jam nut (A) (left-hand threads); then loosen jam nut (C) and with the shift lever in the reverse position, adjust the coupler (B) until the transmission is in reverse and the "R" icon appears on the LCD.

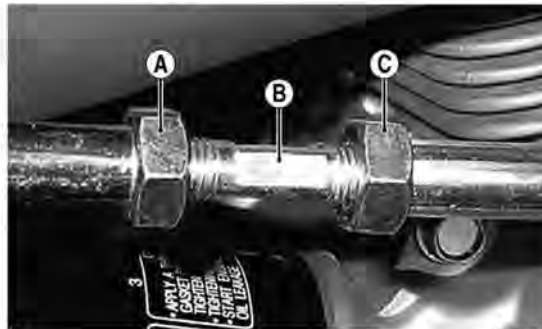

KC194A

3. Tighten the jam nuts securely; then shift the transmission to each position and verify correct adjustment.
4. Install the left-side engine cover and seat making sure the seat locks securely in place.

2

Frame/Welds/Racks

The frame, welds, and racks should be checked periodically for damage, bends, cracks, deterioration, broken components, and missing components. If replacement or repair constitutes removal, see Section 8.

Electrical Connections

The electrical connections should be checked periodically for proper function. In case of an electrical failure, check fuses, connections (for tightness, corrosion, damage), and/or bulbs. If an electrical component needs to be tested for proper function, see Section 5.

Hydraulic Brake Systems

CHECKING/BLEEDING

The hydraulic brake systems have been filled and bled at the factory. To check and/or bleed a hydraulic brake system, use the following procedure.

1. With the master cylinder in a level position, check the fluid level in the reservoir. On the hand brake if the level in the reservoir is adequate, the sight glass will appear dark. If the level is low, the sight glass will appear clear. On the auxiliary brake the level must be between the MIN and MAX lines on the reservoir.

Brake Fluid Sight Window

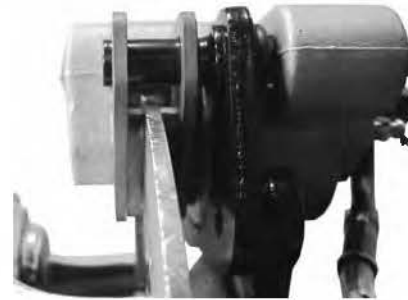

Bleeder Screw

2. Compress the brake lever/pedal several times to check for a firm brake. If the brake is not firm, the system must be bled.
3. To bleed the brake system, use the following procedure.
 - A. Remove the cover and fill the reservoir with DOT 4 Brake Fluid.
 - B. Install and secure the cover; then slowly compress the brake lever several times.
 - C. Remove the protective cap, install one end of a clear hose onto one FRONT bleeder screw, and direct the other end into a container; then while holding slight pressure on the brake lever, open the bleeder screw and watch for air bubbles. Close the bleeder screw before releasing the brake lever. Repeat this procedure until no air bubbles are present.



AF637D

■NOTE: During the bleeding procedure, watch the reservoir sight glass very closely to make sure there is always a sufficient amount of brake fluid. When the sight glass changes from dark to light, refill the reservoir before the bleeding procedure is continued. Failure to maintain a sufficient amount of fluid in the reservoir will result in air in the system.

- D. Repeat step C until the brake lever is firm.
 - E. At this point, perform step B, C, and D on the other FRONT bleeder screw; then move to the REAR bleeder screw and follow the same procedure.
4. Carefully check the entire hydraulic brake system that all hose connections are tight, the bleed screws are tight, the protective caps are installed, and no leakage is present.

CAUTION

Brake fluid that has been drained or bled from the brake system must NEVER be re-used or severe brake system corrosion and damage may occur. Always discard used brake fluid in an appropriate manner.

CAUTION

This hydraulic brake system is designed to use DOT 4 brake fluid only. If brake fluid must be added, care must be taken as brake fluid is very corrosive to painted surfaces.

INSPECTING HOSES

Carefully inspect the hydraulic brake hoses for cracks or other damage. If found, the brake hoses must be replaced.

CHECKING/REPLACING PADS

The clearance between the brake pads and brake discs is adjusted automatically as the brake pads wear. The only maintenance that is required is replacement of the brake pads when they show excessive wear. Check the thickness of each of the brake pads as follows.

1. Remove a front wheel.
2. Measure the thickness of each brake pad.
3. If thickness of either brake pad is less than 1.0 mm (0.039 in.), the brake pads must be replaced.

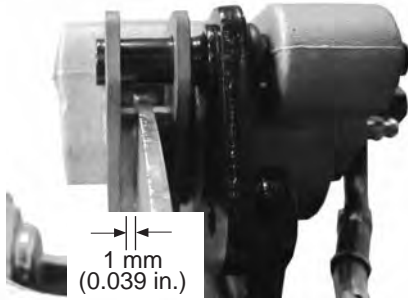

■NOTE: The brake pads should be replaced as a set.

4. To replace the brake pads, use the following procedure.
 - A. Remove the wheel.
 - B. Remove the cap screws securing the caliper holder to the knuckle; then remove the pads.



- C. Install the new brake pads.
- D. Secure the caliper to the knuckle and/or axle housing with the cap screws. Tighten to 20 ft-lb.

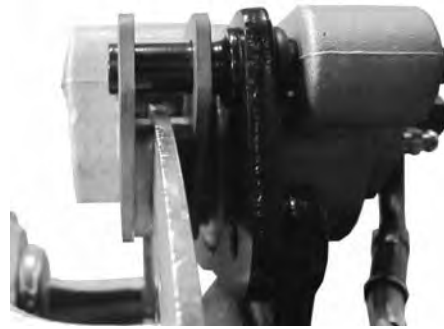

- E. Install the wheel. Tighten to 40 ft-lb.
5. Burnish the brake pads (see Burnishing Brake Pads in this section).

2

Burnishing Brake Pads

Brake pads (both main and auxiliary) must be burnished to achieve full braking effectiveness. Braking distance will be extended until brake pads are properly burnished. To properly burnish the brake pads, use the following procedure.

⚠ WARNING

Failure to properly burnish the brake pads could lead to premature brake pad wear or brake loss. Brake loss can result in severe injury.

1. Choose an area large enough to safely accelerate the ATV to 30 mph and to brake to a stop.
2. Accelerate to 30 mph; then compress brake lever or apply the auxiliary brake to decelerate to 0-5 mph.
3. Repeat procedure on each brake system five times.
4. Adjust the auxiliary brake (if necessary).
5. Verify that the brakelight illuminates when the hand lever is compressed or the brake pedal is depressed.

Checking/Replacing V-Belt

REMOVING

1. Remove the seat and right-side engine cover; then remove the cap screw securing the auxiliary brake pedal to the frame. Account for a flat washer.



KC149A

- Slide the auxiliary brake pedal part way off the pivot stud but do not remove; then remove the cap screws from the V-belt housing and remove the cover. Account for two alignment pins and a gasket.

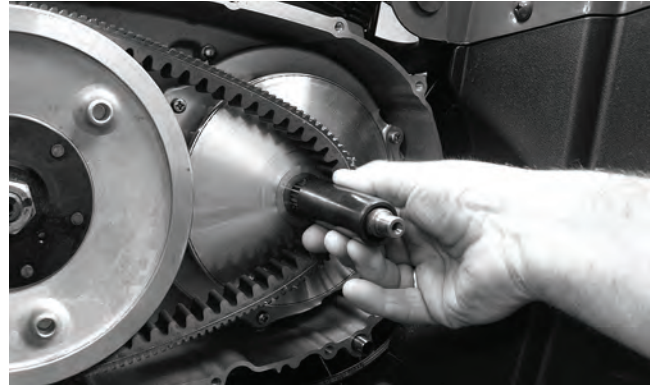

KC128

- Thread a cap screw from the V-belt cover into the driven pulley fixed face and push the movable face open allowing the V-belt to drop down between the pulley faces approximately 3/4 in.

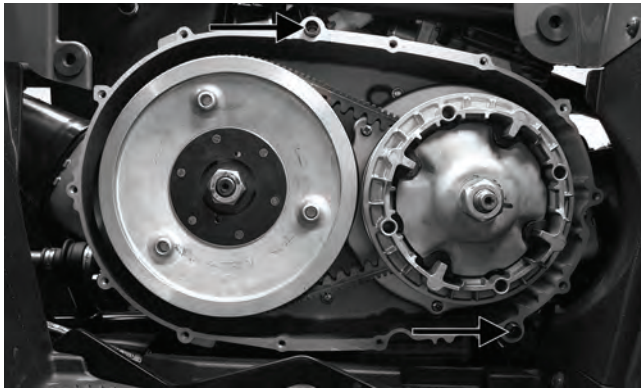

KC142A

- Remove the nut securing the movable drive face to the clutch shaft; then remove the movable drive face assembly being careful not to let the roller fall out. Account for a bushing.



KC137

- Pinching the V-belt together in front of the driven pulley, pull it forward and outward off the clutch shaft; then remove it from the driven pulley.

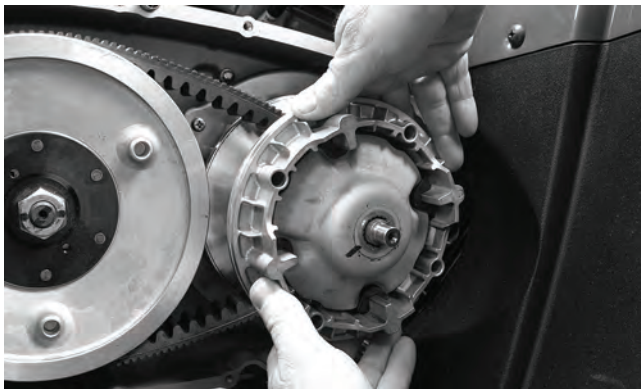

KC127

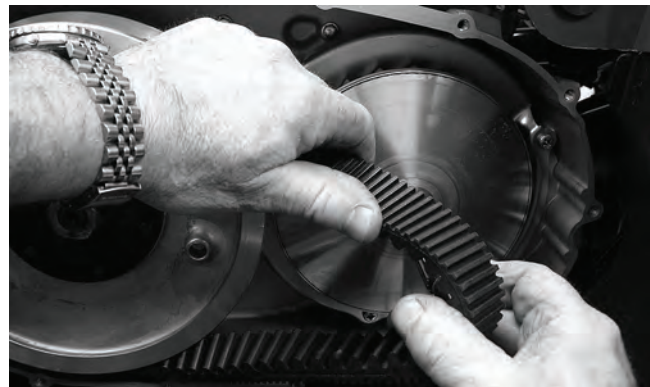

KC136

- Inspect the faces of the drive and driven pulleys for scoring, pitting, cracks, or grooving; then clean any dirt and debris from the V-belt housing and cover.

INSTALLING

- Place the V-belt onto the driven pulley making sure the arrows point in the direction of rotation; then pinch the belt together in front of the driven pulley and place it over the clutch shaft.

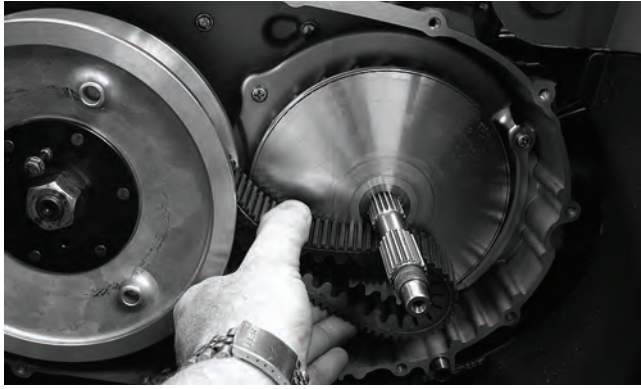

KC135

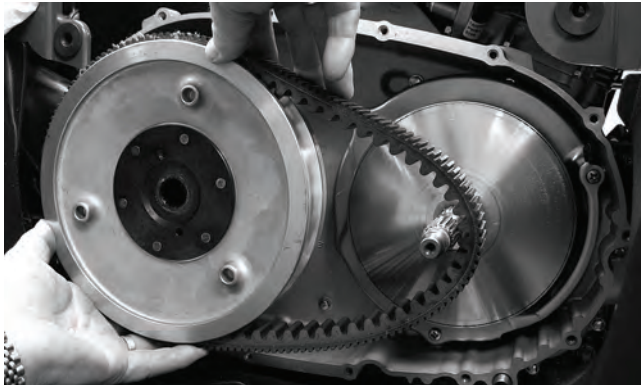

KC131

2. Install the bushing over the clutch shaft; then install the movable drive face assembly on the clutch shaft.

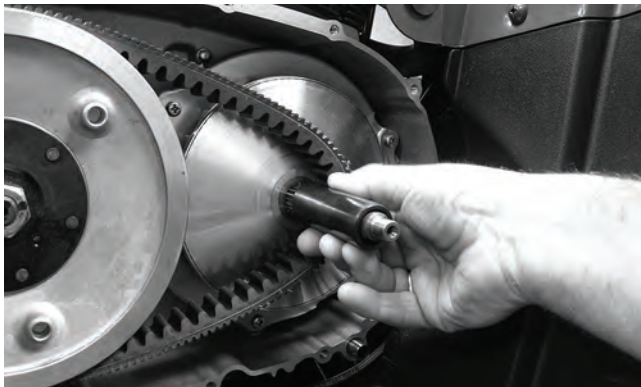

KC128



KC138

3. With two drops of red Loctite #271 on the threads and with the splines of the clutch shaft protruding through the movable drive face, install the nut and tighten to 147 ft-lb.

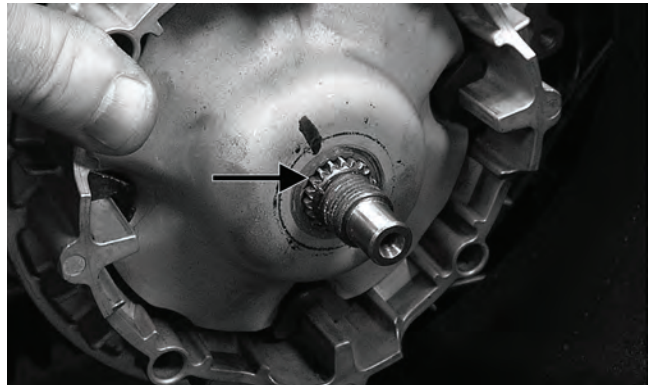

KC152A

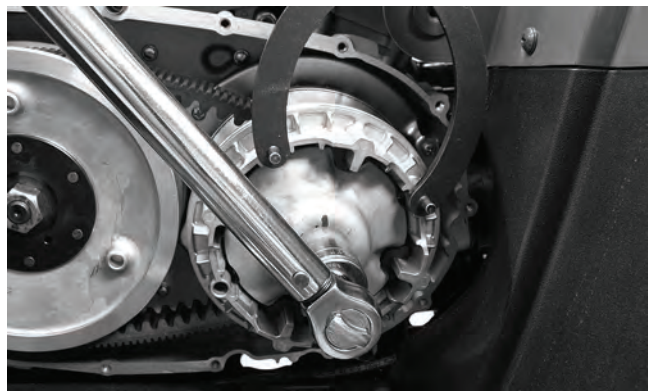

KC141

4. Remove the cap screw from the fixed driven face; then rotate the pulleys counterclockwise until the driven pulley faces are together.
5. With the two alignment pins installed in the V-belt housing and a new V-belt cover gasket in place, install the V-belt cover. Using the pattern shown, secure with the cap screws tightened to 8 ft-lb.

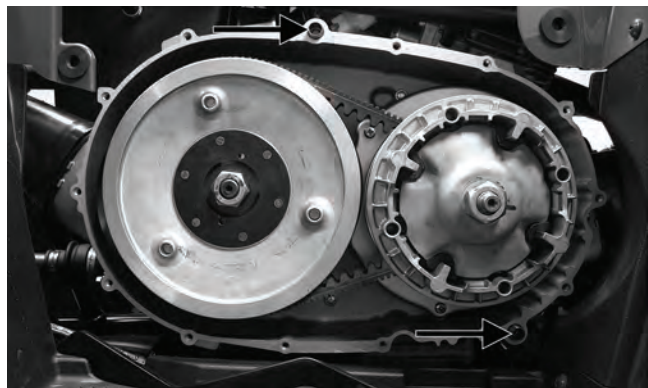

KC142A

2



KC149A

6. Slide the auxiliary brake pedal fully onto the pivot stud engaging the master cylinder; then secure with the flat washer and cap screw and tighten to 20 ft-lb.

SECTION 3 - ENGINE/TRANSMISSION

TABLE OF CONTENTS

Engine/Transmission	3-2
Specifications	3-3
Troubleshooting	3-4
Table of Contents	3-7

Engine/Transmission

This section has been organized into sub-sections which show a progression for the complete servicing of the KYMCO ATV engine/transmission.

To service the center crankcase halves, the engine/transmission must be removed from the frame.

To service top-side, left-side, and right-side components, the engine/transmission does not have to be removed from the frame.

■ **NOTE:** KYMCO recommends the use of new gaskets, lock nuts, and seals and lubricating all internal components when servicing the engine/transmission.

■ **NOTE:** Some photographs and illustrations used in this section are used for clarity purposes only and are not designed to depict actual conditions.

■ **NOTE:** Critical torque specifications are located in Section 1.

SPECIAL TOOLS

A number of special tools must be available to the technician when performing service procedures in this section.

Description	p/n
Clutch Sleeve Hub Holder	E017
Connecting Rod Holder	
Crankcase Separator/Crankshaft Remover	E026
Magneto Rotor Remover	E073
Oil Filter Wrench	E052
Piston Pin Puller	
Side Case Puller	
Spanner Wrench	
Surface Plate	
Valve Clearance Adjuster	E012
V Blocks	

■ **NOTE:** Special tools are available from the KYMCO Spare Parts Department.

Specifications*

VALVES AND GUIDES		
Valve Face Diameter	(intake) (exhaust)	30.6 mm (1.20 in.) 27.0 mm (1.06 in.)
Valve/Tappet Clearance (cold engine)	(intake) (exhaust)	0.10 mm (0.004 in.) 0.17 mm (0.007 in.)
Valve Guide/Stem Clearance (max)	(intake) (exhaust)	0.04 mm (0.0016 in.) 0.06 mm (0.0024 in.)
Valve Guide/Valve Stem Deflection (wobble method)	(max)	0.35 mm (0.014 in.)
Valve Guide Inside Diameter		5.000-5.015 mm (0.1969-0.1974 in.)
Valve Stem Outside Diameter	(intake) (exhaust)	4.975-4.990 mm (0.1959-0.1965 in.) 4.955-4.970 mm (0.1951-0.1957 in.)
Valve Stem Runout	(max)	0.05 mm (0.002 in.)
Valve Head Thickness	(intake) (exhaust)	2.03 mm (0.08 in.) 2.28 mm (0.09 in.)
Valve Face/Seat Width (min)	(intake) (exhaust)	2.25 mm (0.089 in.) 2.55 mm (0.100 in.)
Valve Seat Angle	(intake/exhaust)	45°
Valve Face Radial Runout	(max)	0.03 mm (0.001 in.)
Valve Spring Free Length	(min)	42.8 mm (1.69 in.)
Valve Spring Tension @ 32.5 mm (1.28 in.)	(outer)	18.6-21.4 kg (41-47 lb)
CAMSHAFT AND CYLINDER HEAD		
Cam Lobe Height (min)	(intake/exhaust)	13.46 mm (0.530 in.)
Camshaft Journal Oil Clearance	(max)	0.081 mm (0.003 in.)
Camshaft Journal Holder Inside Diameter	(right & center) (left)	22.01-22.04 mm (0.8665-0.8677 in.) 17.51-17.54 mm (0.6893-0.6905 in.)
Camshaft Journal Outside Diameter	(right & center) (left)	21.959-21.980 mm (0.8645-0.8654 in.) 17.466-17.480 mm (0.6876-0.6882 in.)
Camshaft Runout	(max)	0.03 mm (0.0012 in.)
Rocker Arm Inside Diameter		12.000-12.018 mm (0.472-0.473 in.)
Rocker Arm Shaft Outside Diameter		11.975-11.987 mm (0.4715-0.4719 in.)
Cylinder Head Distortion	(max)	0.05 mm (0.002 in.)
Cylinder Head Cover Distortion	(max)	0.05 mm (0.002 in.)

CYLINDER, PISTON, AND RINGS		
Piston Skirt/Cylinder Clearance	0.060-0.073 mm (0.0024-0.0029 in.)	
Piston Diameter 15 mm (0.6 in.) from Skirt End	88.96 - 88.98 (3.558 - 3.559 in.)	
Piston Ring Free End Gap (min)	(1st) (2nd)	8.0 mm (0.3150 in.) 8.3 mm (0.3268 in.)
Bore x Stroke	89 * 71.2 mm (3.56 * 2.80 in.)	
Cylinder Trueness	(max)	0.01 mm (0.0004 in.)
Piston Ring End Gap - Installed		0.15-0.30 mm (0.006-0.012 in.)
Piston Ring to Groove Clearance (max)	(1st/2nd)	0.06 mm (0.002 in.)
Piston Ring Groove Width	(1st) (2nd) (oil)	1.01-1.03 mm (0.0398-0.0406 in.) 1.21-1.23 mm (0.0476-0.0484 in.) 2.01-2.03 mm (0.0791-0.0799 in.)
Piston Ring Thickness	(1st) (2nd)	1.01 - 1.03 mm (0.0404 - 0.0412 in.) 1.17 - 1.19 mm (0.0468 - 0.0476 in.)
Piston Pin Bore	(max)	20.008 mm (0.7877 in.)
Piston Pin Outside Diameter	(min)	19.994 mm (0.7872 in.)
CRANKSHAFT		
Connecting Rod (small end inside diameter)	(max)	20.021 mm (0.7882 in.)
Connecting Rod (big end side-to-side)		0.10-0.55 mm (0.004-0.022 in.)
Connecting Rod (big end width)		21.95-22.00 mm (0.8642-0.8661 in.)
Connecting Rod (small end deflection)	(max)	0.3 mm (0.012 in.)
Crankshaft (web-to-web)		60.8-60.9 mm (2.393-2.397 in.)
Crankshaft Runout	(max)	0.03 mm (0.001 in.)

* Specifications subject to change without notice.

Troubleshooting

Problem: Engine will not start or is hard to start (Compression too low)	
Condition	Remedy
1. Valve clearance out of adjustment	1. Adjust clearance
2. Valve guides worn	2. Replace cylinder head
3. Valves mistimed	3. Adjust valve timing
4. Piston rings worn excessively	4. Replace rings
5. Cylinder bore worn	5. Replace - rebore cylinder
6. Spark plug seating poorly	6. Tighten plug
7. Starter motor cranks too slowly - does not turn	7. Check - replace starter motor
Problem: Engine will not start or is hard to start (No spark)	
Condition	Remedy
1. Spark plug fouled	1. Clean - replace plug
2. Spark plug wet	2. Clean - dry plug
3. Magneto defective	3. Replace magneto
4. ECU defective	4. Replace ECU unit
5. Ignition coil defective	5. Replace ignition coil
6. High-tension lead open - shorted	6. Replace high tension lead
Problem: Engine will not start or is hard to start (No fuel reaching the carburetor/fuel injector)	
Condition	Remedy
1. Gas tank vent hose obstructed	1. Clean vent hose
2. Throttle body obstructed	2. Clean Throttle body
3. Fuel hose obstructed	3. Clean - replace hose
4. Fuel filter obstructed	4. Clean - replace fuel filter
5. Fuel pump defective	5. Replace fuel pump
Problem: Engine stalls easily	
Condition	Remedy
1. Spark plug fouled	1. Clean plug
2. Magneto defective	2. Replace magneto
3. ECU unit defective	3. Replace ECU unit
4. Throttle Body obstructed	4. Clean Throttle Body
5. Valve clearance out of adjustment	5. Adjust clearance
Problem: Engine noisy (Excessive valve chatter)	
Condition	Remedy
1. Valve clearance too large	1. Adjust clearance
2. Valve spring(s) weak - broken	2. Replace spring(s)
3. Rocker arm - rocker arm shaft worn	3. Replace arm - shaft
4. Camshaft worn	4. Replace camshaft
5. Valve tappets worn	5. Replace tappets
Problem: Engine noisy (Noise seems to come from piston)	
Condition	Remedy
1. Piston - cylinder worn	1. Replace - service piston - cylinder
2. Combustion chamber carbon buildup	2. Clean chamber
3. Piston pin bore worn	3. Replace piston
4. Piston pin worn	4. Replace piston pin
5. Piston rings - ring groove(s) worn	5. Replace rings - piston

Problem: Engine noisy (Noise seems to come from timing chain)	
Condition	Remedy
1. Chain stretched 2. Sprockets worn 3. Tension adjuster malfunctioning	1. Replace chain 2. Replace sprockets 3. Repair - replace adjuster
Problem: Engine noisy (Noise seems to come from crankshaft)	
Condition	Remedy
1. Bearing worn - burned 2. Lower rod-end bearing worn - burned 3. Connecting rod side clearance too large	1. Replace bearing 2. Replace crankshaft 3. Replace crankshaft
Problem: Engine noisy (Noise seems to come from transmission)	
Condition	Remedy
1. Gears worn - rubbing 2. Splines worn 3. Primary gears worn - rubbing 4. Bearings worn 5. Bushing worn	1. Replace gears 2. Replace shaft(s) 3. Replace gears 4. Replace bearings 5. Replace bushing
Problem: Engine noisy (Noise seems to come from secondary bevel gear and final driven shaft)	
Condition	Remedy
1. Drive - driven bevel gears damaged - worn 2. Backlash excessive 3. Tooth contact improper 4. Bearing damaged 5. Gears worn - rubbing 6. Splines worn 7. Final driven shaft thrust clearance too large	1. Replace gears 2. Adjust backlash 3. Adjust contact 4. Replace bearing 5. Replace gears 6. Replace shaft(s) 7. Replace thrust washer(s)
Problem: Engine idles poorly	
Condition	Remedy
1. Valve clearance out of adjustment 2. Valve seating poor 3. Valve guides defective 4. Rocker arms - arm shaft worn 5. Magneto defective 6. ECU unit defective 7. Spark plug fouled - gap too wide 8. Ignition coil defective 9. Fuel Pump defective 10. Fuel injector obstructed 11. CO screw setting improper 12. Fuel injector obstructed	1. Adjust clearance 2. Replace - service seats - valves 3. Replace cylinder head 4. Replace arms - shafts 5. Replace magneto 6. Replace ECU unit 7. Adjust gap - replace plug 8. Replace ignition coil 9. Replace Fuel Pump 10. Clean Fuel injector 11. CO screw can't allowed to be adjusted 12. Replace fuel injector

Problem: Engine runs poorly at high speed	
Condition	Remedy
<ol style="list-style-type: none"> 1. High RPM “cut out” against RPM limiter 2. Valve springs weak 3. Valve timing out of adjustment 4. Cams - rocker arms - tappets worn 5. Spark plug gap too narrow 6. Ignition coil defective 7. Fuel Injector obstructed 8. Air cleaner element obstructed 9. Fuel hose obstructed 10. Fuel pump defective 	<ol style="list-style-type: none"> 1. Shift into higher gear - decrease speed 2. Replace springs 3. Adjust timing 4. Replace cams - arms - tappets 5. Adjust gap 6. Replace ignition oil 7. Clean Fuel Injector 8. Clean element 9. Clean or replace hose 10. Replace fuel pump
Problem: Exhaust smoke dirty or heavy	
Condition	Remedy
<ol style="list-style-type: none"> 1. Oil (in the engine) overfilled - contaminated 2. Piston rings - cylinder worn 3. Valve guides worn 4. Cylinder wall scored - scuffed 5. Valve stems worn 6. Stem seals defective 	<ol style="list-style-type: none"> 1. Drain excess oil - replace oil 2. Replace - service rings - cylinder 3. Replace cylinder head 4. Replace - service cylinder 5. Replace valves 6. Replace seals
Problem: Engine lacks power	
Condition	Remedy
<ol style="list-style-type: none"> 1. Valve clearance incorrect 2. Valve springs weak 3. Valve timing incorrect 4. Piston ring(s) - cylinder worn 5. Valve seating poor 6. Spark plug fouled 7. Rocker arms - shafts worn 8. Spark plug gap incorrect 9. Fuel Injector obstructed 10. Fuel Pump defective 11. Air cleaner element obstructed 12. Oil (in the engine) overfilled - contaminated 13. Intake manifold leaking air 14. Cam chain worn 	<ol style="list-style-type: none"> 1. Adjust clearance 2. Replace springs 3. Re-time valve gear 4. Replace - service rings - cylinder 5. Repair seats 6. Clean - replace plug 7. Replace arms - shafts 8. Adjust gap - replace plug 9. Clean Fuel Injector 10. Replace Fuel Pump 11. Clean element 12. Drain excess oil - change oil 13. Tighten - replace manifold 14. Replace cam chain
Problem: Engine overheats	
Condition	Remedy
<ol style="list-style-type: none"> 1. Carbon deposit (piston crown) excessive 2. Oil low 3. Octane low - gasoline poor 4. Oil pump defective 5. Oil circuit obstructed 6. Engine Coolant too low 7. Intake manifold leaking air 8. Fan malfunctioning 9. Fan switch malfunctioning 	<ol style="list-style-type: none"> 1. Clean piston 2. Add oil 3. Drain - replace gasoline 4. Replace pump 5. Clean circuit 6. Fill Engine Coolant to the upper limit 7. Tighten - replace manifold 8. Check fan fuse - replace fan 9. Replace fan switch

Table of Contents

Removing Engine/Transmission.....	3-7
Top-Side Components.....	3-9
Removing Top-Side Components	3-9
Servicing Top-Side Components.....	3-13
Installing Top-Side Components	3-21
Left-Side Components	3-25
Removing Left-Side Components	3-26
Installing Left-Side Components	3-28
Right-Side Components	3-29
Removing Right-Side Components.....	3-29
Servicing Right-Side Components	3-33
Installing Right-Side Components.....	3-33
Center Crankcase Components.....	3-36
Separating Crankcase Halves.....	3-37
Disassembling Crankcase Half.....	3-37
Servicing Center Crankcase Components.....	3-39
Assembling Crankcase Half.....	3-42
Joining Crankcase Halves.....	3-44
Installing Engine/Transmission.....	3-44

Removing Engine/ Transmission

Many service procedures can be performed without removing the engine/transmission from the frame. Closely observe the note introducing each sub-section for this important information.

AT THIS POINT

If the technician's objective is to service Top-Side Components, Left-Side Components, or Right-Side Components, the engine/transmission does not have to be removed from the frame.

AT THIS POINT

If the technician's objective is to service/replace left-side cover oil seals or the oil strainer (from beneath the engine/transmission), the engine/transmission does not have to be removed from the frame.

Secure the ATV on a support stand to elevate the wheels.

WARNING

Make sure the ATV is solidly supported on the support stand to avoid injury.

1. Remove the front rack, left and right footwells, and front body panel (see Section 8); then disconnect the negative battery cable from the battery.

2. Remove the heat shield; then remove the gas tank (see Section 4).
3. Disconnect the water temperature sensor connector. Remove the water hose to thermostat.

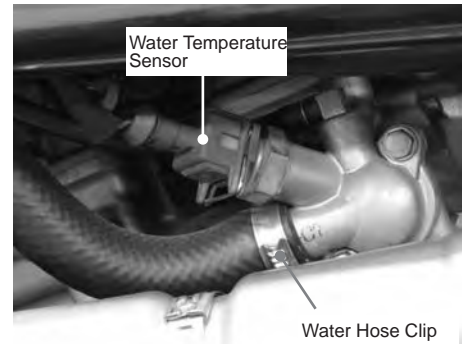

4. Disconnect the water hose with the water pump. Disconnect the water hose with the thermostat.

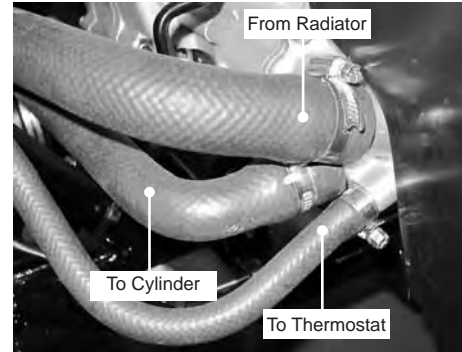

5. Disconnect the speedometer sensor; then remove the E-clip securing the shift rod to the shift arm and disconnect the shift rod. Account for a bushing and flat washer.



KC255

4. Remove the inlet air duct, air filter housing, and air silencer duct; then remove the carburetor and set aside leaving the throttle cable attached.



KC235



KC236

5. Remove the cap screws securing the exhaust pipe to the cylinder head; then disconnect the exhaust pipe to muffler springs and remove the exhaust pipe. Account for a grafoil seal and seal ring.



KC170



6. Disconnect the gear shift position switch, starter cable, and engine ground cable; then disconnect the trigger coil and stator coil connectors.

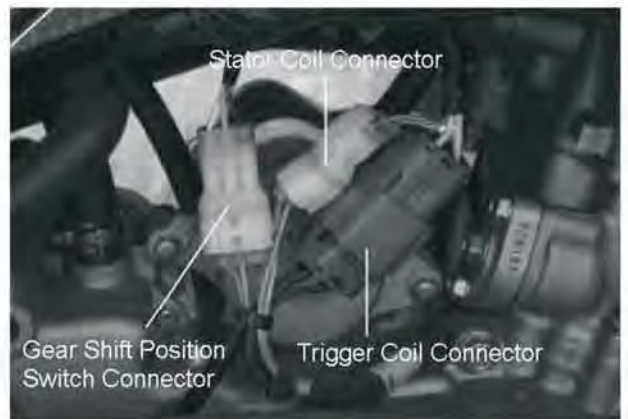

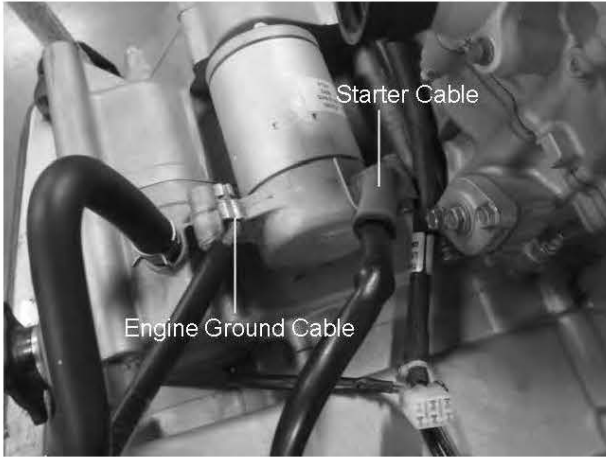

8. Remove the front and rear V-belt cooling boots from the V-belt housing.
9. Remove the cap screws from the front and rear output flanges; then remove the front and rear engine mounting through-bolts.

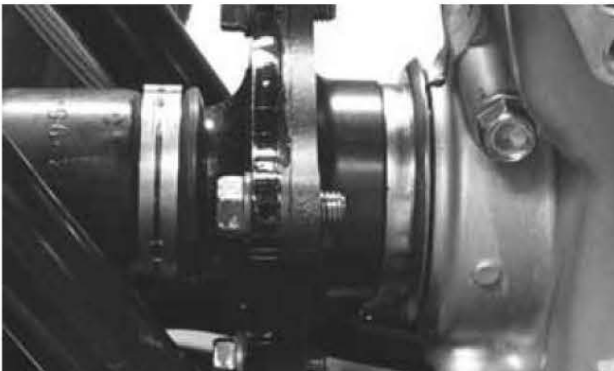

KC242

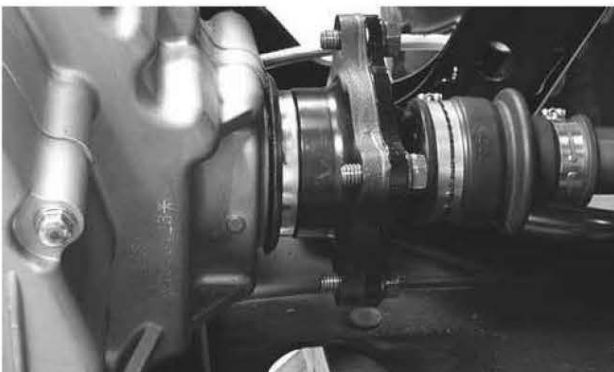

KC243

10. Lift the rear of the engine/transmission and swing to the right; then tilt the assembly sufficiently to remove through the right-side frame opening.

Top-Side Components

■ **NOTE:** For efficiency, it is preferable to remove and disassemble only those components which need to be addressed and to service only those components. The technician should use discretion and sound judgment.

AT THIS POINT

To service any one specific component, only limited disassembly of components may be necessary. Note the AT THIS POINT information in each sub-section.

■ **NOTE:** The engine/transmission does not have to be removed from the frame for this procedure.

Removing Top-Side Components

3

- A. Valve Cover/Rocker Arms
- B. Cylinder Head/Camshaft

■ **NOTE:** Remove the spark plug, timing inspection plug, and outer magneto cover; then using an appropriate wrench, rotate the crankshaft to top-dead-center of the compression stroke.

■ **NOTE:** KYMCO recommends the use of new gaskets, lock nuts, and seals and lubricating all internal components when servicing the engine/transmission.

1. Remove the cap screws securing the two tappet covers. Remove the two tappet covers. Account for the O-rings.

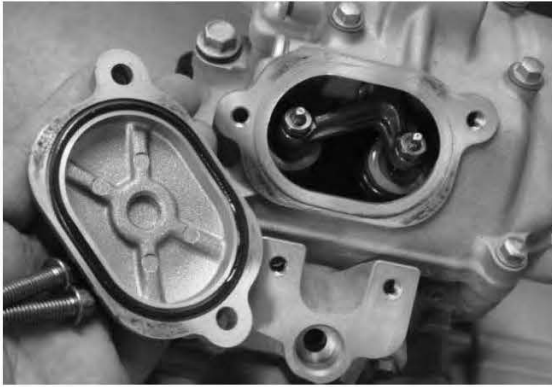

■NOTE: Keep the mounting hardware with the covers for assembly purposes.

2. Remove the valve cover cap screws. Note the rubber washers on the four top-side cap screws; remove the valve cover. Note the orientation of the cylinder head plug and remove it. Note the location of the two alignment pins.

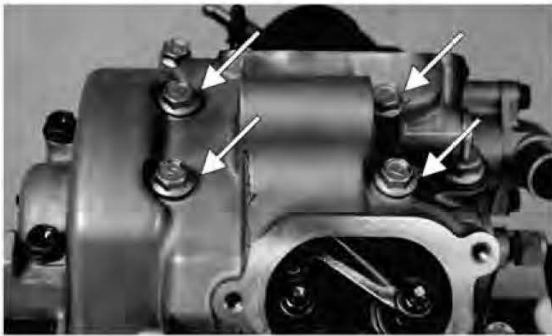

CF007A

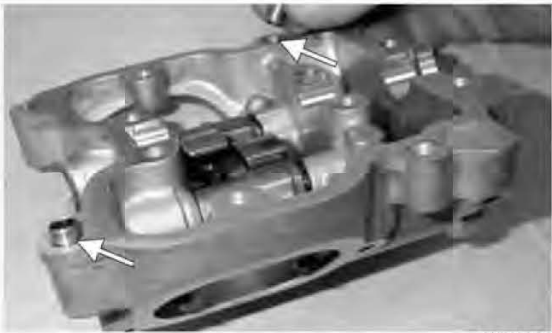

MD1354A

3. Loosen the cap screw on the end of the cam chain tensioner; then remove the two cap screws securing the cam chain tensioner assembly. Remove the tensioner assembly and gasket.

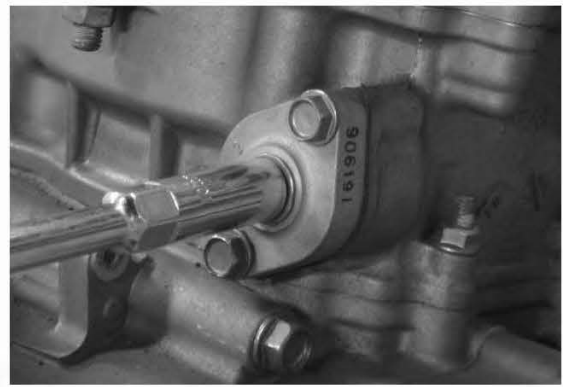

4. Remove the cam chain tensioner pivot cap screw and washer.



5. Bend the washer tabs and remove the two cap screws securing the sprocket to the camshaft.

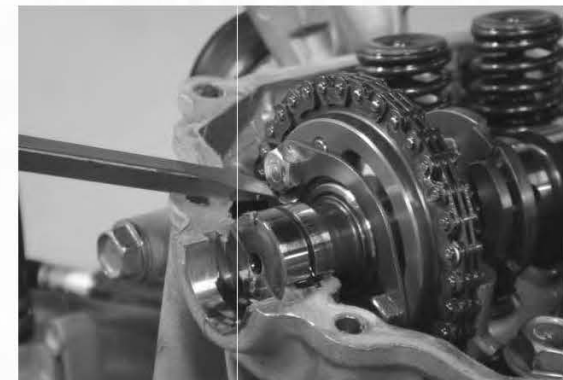

- Using an awl, rotate the C-ring in its groove until it is out of the cylinder head; then remove the C-ring.

■NOTE: Care should be taken not to drop the C-ring down into the crankcase.



- Noting the timing marks for installing purposes, drop the sprocket off the camshaft. While holding the cam chain, slide the sprocket and camshaft out of the cylinder head. Account for an alignment pin.

■NOTE: Loop the chain over the cylinder and secure it with a wire to keep it from falling into the crankcase.



- Remove the cam chain tensioner by lifting it from the chain cavity; then remove the two lower nuts securing the cylinder head to the cylinder, one in front and one in rear.

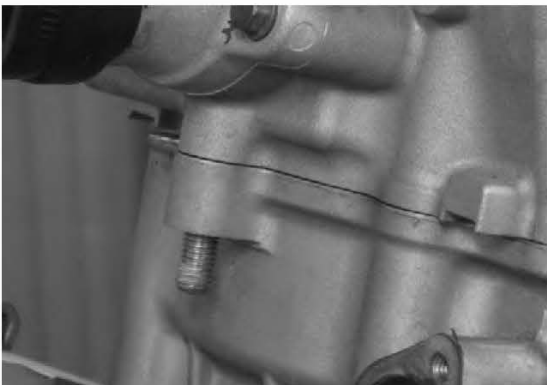

- Remove the four cylinder head cap screws and washers. Note that the two cap screws on the right side of the cylinder head nearest the cam sprocket are longer than the two cap screws on the left (spark plug) side.



CD211

- Remove the cylinder head from the cylinder, remove the gasket, and account for two alignment pins.



3

⚠ AT THIS POINT

To service valves and cylinder head, see Servicing Top-Side Components sub-section.

- Remove the cam chain guide.

⚠ AT THIS POINT

To inspect cam chain guide, see Servicing Top-Side Components sub-section.



C. Cylinder
D. Piston

■NOTE: Steps 1-11 in the preceding sub-section must precede this procedure.

12. Remove the two nuts securing the right side of the cylinder to the right-side crankcase half.

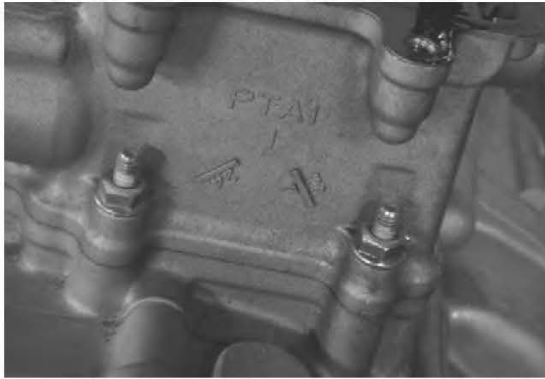

13. Lift the cylinder off the crankcase taking care not to allow the piston to drop against the crankcase. Account for the gasket and two alignment pins.

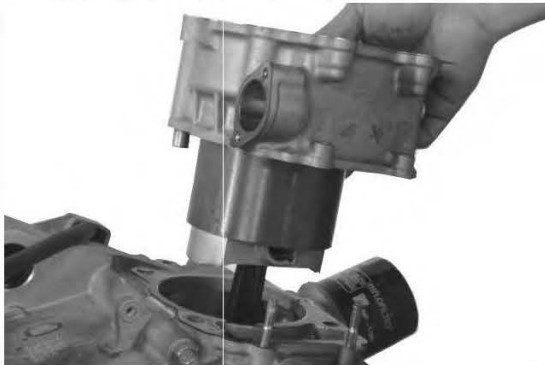

AT THIS POINT

To service cylinder, see Servicing Top-Side Components sub-section.

CAUTION

When removing the cylinder, be sure to support the piston to prevent damage to the crankcase and piston.

14. Using an awl, remove one piston-pin circlip. Take care not to drop it into the crankcase.



MD1213

15. Using Piston Pin Puller, remove the piston pin. Account for the opposite-side circlip. Remove the piston.

■NOTE: It is advisable to remove the opposite-side circlip prior to using the puller.



MD1219

■NOTE: Support the connecting rod with rubber bands to avoid damaging the rod or install a connecting rod holder.

CAUTION

Do not allow the connecting rod to go down inside the crankcase. If the rod is down inside the crankcase and the crankshaft is rotated, severe damage will result.

■NOTE: If the existing rings will not be replaced with new rings, note the location of each ring for proper installation. When replacing with new rings, replace as a complete set only. If the piston rings must be removed, remove them in this sequence.



- A. Starting with the top ring, slide one end of the ring out of the ring-groove.
- B. Remove each ring by working it toward the dome of the piston while rotating it out of the groove.

⚠ AT THIS POINT
To service piston, see Servicing Top-Side Components sub-section.
⚠ AT THIS POINT
To service center crankcase components only, proceed to Removing Left-Side Components.

Servicing Top-Side Components

■NOTE: Whenever a part is worn excessively, cracked, or damaged in any way, replacement is necessary.

VALVE ASSEMBLY

When servicing valve assembly, inspect valve seats, valve stems, valve faces, and valve stem ends for pits, burn marks, or other signs of abnormal wear.

■NOTE: Whenever a valve is out of tolerance, it must be replaced.

Cleaning/Inspecting Valve Cover

■NOTE: If the valve cover cannot be trued, the cylinder head assembly must be replaced.

1. Wash the valve cover in parts-cleaning solvent.

2. Place the valve cover on the Surface Plate covered with #400 grit wet-or-dry sandpaper. Using light pressure, move the valve cover in a figure eight motion. Inspect the sealing surface for any indication of high spots. A high spot can be noted by a bright metallic finish. Correct any high spots before assembly by continuing to move the valve cover in a figure eight motion until a uniform bright metallic finish is attained.

⚠ CAUTION
Do not remove an excessive amount of the sealing surface or damage to the camshaft will result. Always check camshaft clearance when resurfacing the valve cover.



CC130D

⚠ CAUTION
Water or parts-cleaning solvent must be used in conjunction with the wet-or-dry sandpaper or damage to the sealing surface may result.

Removing Valves

■NOTE: Keep all valves and valve components as a set. Note the original location of each valve set for use during installation. Return each valve set to its original location during installation.

1. Using a valve spring compressor, compress the valve springs and remove the valve keepers. Account for an upper spring retainer.



3

2. Remove the valve seal and the lower remaining spring seat. Discard the valve seal.

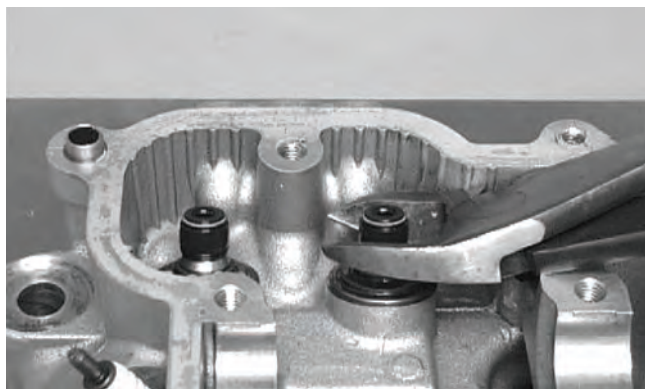

CC134D

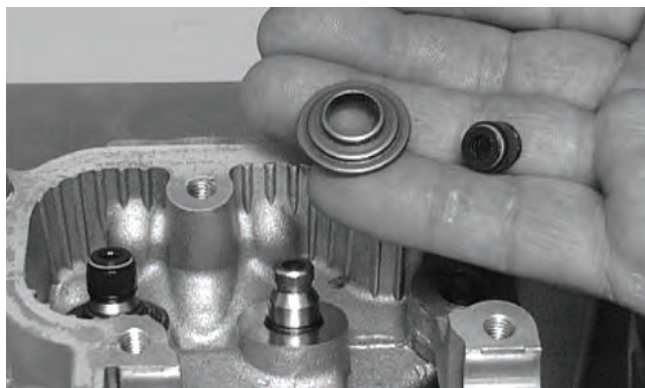

CC136D

■NOTE: The valve seals must be replaced.

3. Remove the valve springs; then invert the cylinder head and remove the valves.

Measuring Valve Stem Runout

1. Support each valve stem end with the V Blocks; then check the valve stem runout using a dial indicator.

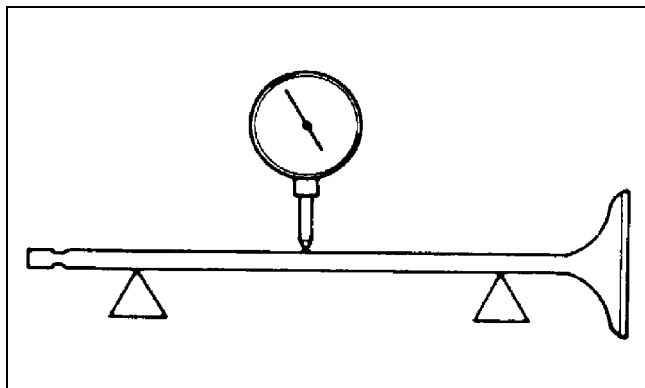

ATV-1082

2. Maximum runout must not exceed specifications.

Measuring Valve Stem Outside Diameter

1. Using a micrometer, measure the valve stem outside diameter.

2. Acceptable diameter range (intake valve) must be within specifications.
3. Acceptable diameter range (exhaust valve) must be within specifications.

Measuring Valve Face/Seat Width

1. Using a micrometer, measure the width of the valve face.

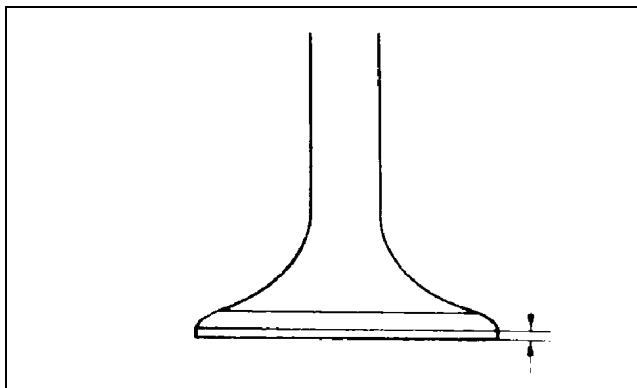

ATV-1004

2. Acceptable width must be at or above specifications.

Measuring Valve Face Radial Runout

1. Mount a dial indicator on the surface plate; then place the valve stem on a set of V blocks.
2. Position the dial indicator contact point on the outside edge of the valve face; then zero the indicator.

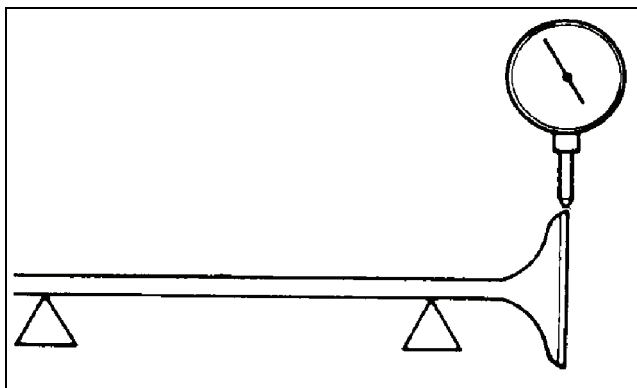

ATV1082A

3. Rotate the valve in the V blocks.
4. Maximum runout must not exceed specifications.

Measuring Valve Guide/Valve Stem Deflection (Wobble Method)

1. Mount a dial indicator and base on the surface plate; then place the cylinder head on the surface plate.
2. Install the valve into the cylinder head; then position the dial indicator contact point against the outside edge of the valve face. Zero the indicator.



CC131D

3. Push the valve from side to side; then from top to bottom.
4. Maximum "wobble" deflection must not exceed specifications.

Measuring Valve Guide (Inside Diameter)

1. Insert a snap gauge 1/2 way down into each valve guide bore; then remove the gauge and measure it with a micrometer.
2. Acceptable inside diameter range must be within specifications.
3. If a valve guide is out of tolerance, the cylinder head must be replaced.

Servicing Valves/Valve Guides/Valve Seats

If valves, valve guides, or valve seats require servicing or replacement, Arctic Cat recommends that the components be taken to a qualified machine shop for servicing.

CAUTION

If valves are discolored or pitted or if the seating surface is worn, the valve must be replaced. Do not attempt to grind the valves or severe engine damage may occur.

Measuring Rocker Arm (Inside Diameter)

1. Using a dial calipers, measure the inside diameter of the rocker arm.
2. Acceptable inside diameter range must be within specifications.

Measuring Rocker Arm Shaft (Outside Diameter)

1. Using a micrometer, measure the outside diameter of the rocker arm shaft.
2. Acceptable outside diameter range must be within specifications.

Installing Valves

1. Apply grease to the inside surface of the valve seals; then place a lower spring seat and valve guide seal over each valve guide.



CC144D

2. Insert each valve into its original valve location.
3. Install the valve springs with the painted end of the spring facing away from the cylinder head.

■NOTE: If the paint is not visible, install the ends of the springs with the closest wound coils toward the head.

3

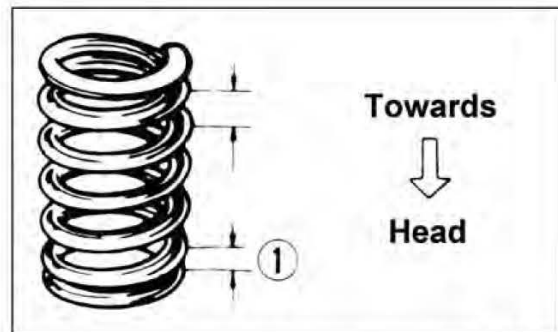

ATV-1011A

4. Place a spring retainer over the valve springs; then using the valve spring compressor, compress the valve springs and install the valve keepers.



PISTON ASSEMBLY

■NOTE: Whenever a piston, rings, or pin are out of tolerance, they must be replaced.

Cleaning/Inspecting Piston

1. Using a non-metallic carbon removal tool, remove any carbon buildup from the top of the piston.
2. Inspect the piston for cracks in the piston pin, boss, top, and skirt areas.
3. Inspect the piston for seizure marks or scuffing. If piston is scored or galled, replace it with a new one.
4. Inspect the perimeter of each piston for signs of "blowby" indicated by dark discoloration. "Blowby" is caused by worn piston rings, excessive carbon in ring grooves, or an out-of-round cylinder.

Removing Piston Rings

1. Starting with the top ring, slide one end of the ring out of the ring-groove.



2. Remove each ring by working it toward the top of the piston while rotating it out of the groove.

■NOTE: If the existing rings will not be replaced with new ones, note the location of each ring for proper installation. When installing new rings, install as a complete set only.

Cleaning/Inspecting Piston Rings

1. Take an old piston ring and snap it into two pieces; then grind the end of the old ring to a 45° angle and to a sharp edge.
2. Using the sharpened ring as a tool, clean carbon from the ring grooves. Be sure to position the ring with its tapered side up.

CAUTION

Improper cleaning of the ring grooves by the use of the wrong type of ring groove cleaner will result in severe damage to the piston.

Measuring Piston-Ring End Gap (Installed)

1. Place each piston ring in the wear portion of the cylinder. Use the piston to position each ring squarely in the cylinder.
2. Using a feeler gauge, measure each piston-ring end gap. Acceptable ring end gap must be within specifications.



Measuring Piston Pin (Outside Diameter) and Piston-Pin Bore

1. Measure the piston pin outside diameter at each end and in the center. If measurement exceeds specifications, the piston pin must be replaced.

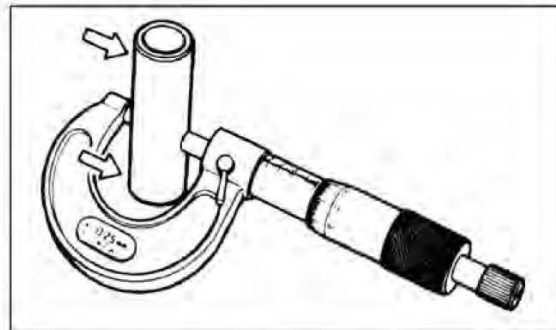

ATV-1070

2. Insert an inside dial indicator into the piston-pin bore. Take two measurements to ensure accuracy. The diameter must not exceed specifications. If the diameter exceeds specifications, the piston must be replaced.

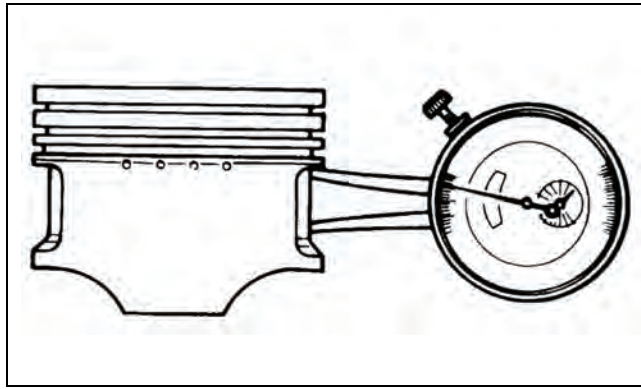

ATV-1069

Measuring Piston Skirt/ Cylinder Clearance

1. Measure the cylinder front to back in six places.

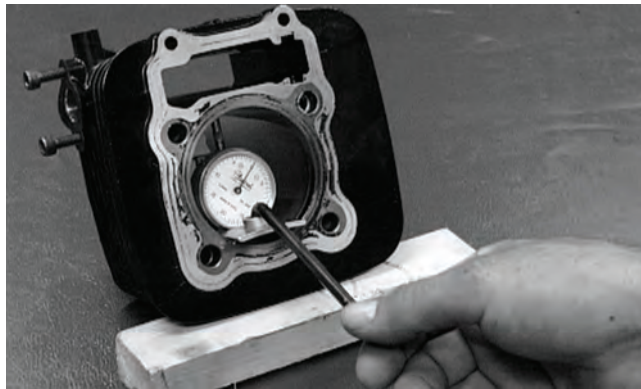

CC397D

2. Measure the corresponding piston diameter at a point 15 mm (0.6 in.) above the piston skirt at a right angle to the piston-pin bore. Subtract this measurement from the measurement in step 1. The difference (clearance) must be within specifications.

Installing Piston Rings

1. Install ring expander (4) in the bottom groove of the piston; then install the thin oil rings (3) over the expander making sure the expander ends do not overlap. Stagger the end gaps of the upper and lower thin oil rings according to the illustration.

■NOTE: Note the direction of the exhaust side of the piston (5) for correct ring end gap orientation.

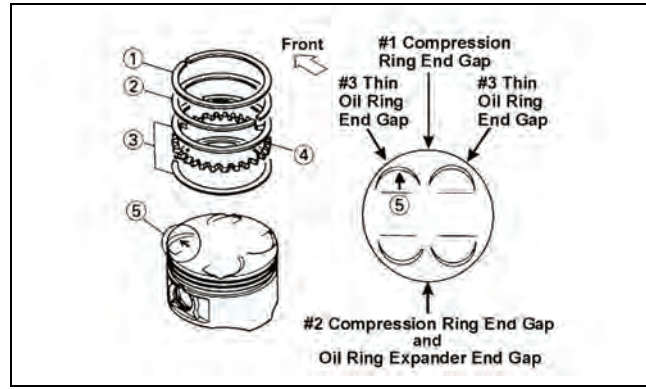

ATV-1085B

2. Install the compression rings (1 and 2) so the letter(s) on the top surface of each ring faces the dome of the piston. Rotate the rings until the ring end gaps are on directly opposite sides of the piston according to the illustration.

■NOTE: The chrome (silver) ring should be installed in the top position.

3

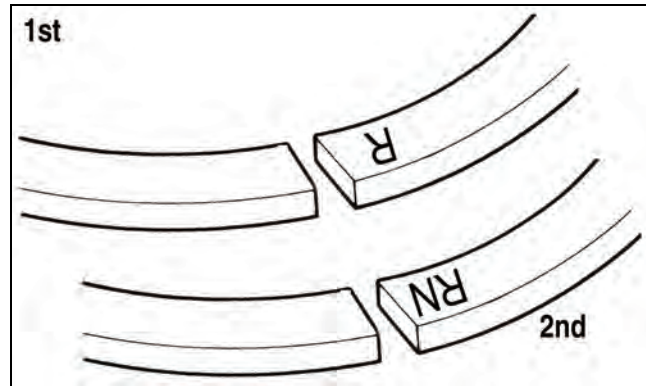

MD1343A

⚠ CAUTION

Incorrect installation of the piston rings will result in engine damage.

CYLINDER/CYLINDER HEAD ASSEMBLY

■NOTE: If the cylinder/cylinder head assembly cannot be trued, they must be replaced.

Cleaning/Inspecting Cylinder Head

⚠ CAUTION

The cylinder head studs must be removed for this procedure.

1. Using a non-metallic carbon removal tool, remove any carbon buildup from the combustion chamber being careful not to nick, scrape, or damage the combustion chamber or the sealing surface.
2. Inspect the spark plug hole for any damaged threads. Repair damaged threads using a "heli-coil" insert.

- Place the cylinder head on the surface plate covered with #400 grit wet-or-dry sandpaper. Using light pressure, move the cylinder head in a figure eight motion. Inspect the sealing surface for any indication of high spots. A high spot can be noted by a bright metallic finish. Correct any high spots before assembly by continuing to move the cylinder head in a figure eight motion until a uniform bright metallic finish is attained.

⚠ CAUTION

Water or parts-cleaning solvent must be used in conjunction with the wet-or-dry sandpaper or damage to the sealing surface may result.

- Inspect the cylinder for pitting, scoring, scuffing, warpage, and corrosion. If marks are found, repair the surface using a cylinder hone (see Honing Cylinder in this sub-section).
- Place the cylinder on the surface plate covered with #400 grit wet-or-dry sandpaper. Using light pressure, move the cylinder in a figure eight motion. Inspect the sealing surface for any indication of high spots. A high spot can be noted by a bright metallic finish. Correct any high spots before assembly by continuing to move the cylinder in a figure eight motion until a uniform bright metallic finish is attained.

⚠ CAUTION

Water or parts-cleaning solvent must be used in conjunction with the wet-or-dry sandpaper or damage to the sealing surface may result.

Measuring Cylinder Head Distortion

- Remove any carbon buildup in the combustion chamber.
- Lay a straightedge across the cylinder head; then using a feeler gauge, check the distortion factor between the head and the straightedge.
- Maximum distortion must not exceed specifications.



CC141D

Cleaning/Inspecting Cylinder

- Wash the cylinder in parts-cleaning solvent.

Inspecting Cam Chain Guide

- Inspect cam chain guide for cuts, tears, breaks, or chips.
- If the chain guide is damaged, it must be replaced.

Honing Cylinder

- Using a slide gauge and a dial indicator or a snap gauge, measure the cylinder bore diameter in three locations from top to bottom and again from top to bottom at 90° from the first measurements for a total of six measurements. The trueness (out-of-roundness) is the difference between the highest and lowest reading. Maximum trueness (out-of-roundness) must not exceed specifications.

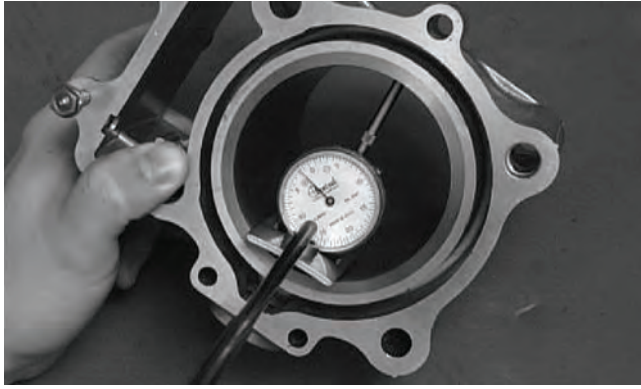

CC127D

2. Wash the cylinder in parts-cleaning solvent.
3. Inspect the cylinder for pitting, scoring, scuffing, and corrosion. If marks are found, repair the surface using a ball hone.

■NOTE: To produce the proper 60° cross-hatch pattern, use a low RPM drill (600 RPM) at the rate of 30 strokes per minute. If honing oil is not available, use a lightweight petroleum-based oil. Thoroughly clean cylinder after honing using soap and hot water. Dry with compressed air; then immediately apply oil to the cylinder bore. If the bore is severely damaged or gouged, replace the cylinder.

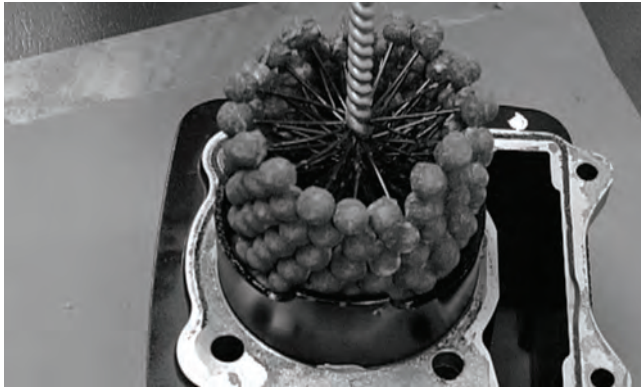

CC390D

4. If any measurement exceeds the limit, bore the cylinder and install an oversized piston or replace the cylinder.

■NOTE: Oversized piston and rings are available. The oversized piston and rings are marked for identification.

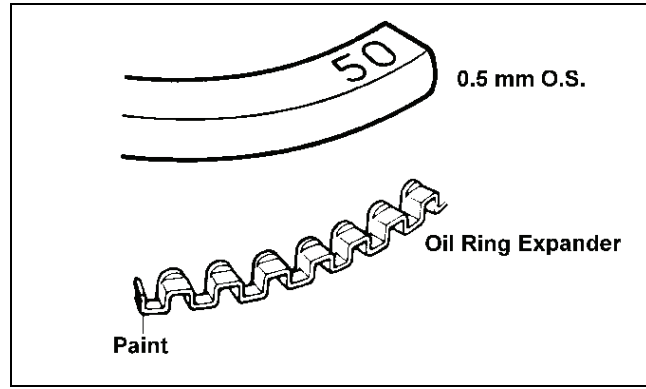

ATV-1068A

Measuring Camshaft Runout

■NOTE: If the camshaft is out of tolerance, it must be replaced.

1. Place the camshaft on a set of V blocks; then position the dial indicator contact point against the shaft and zero the indicator.

3

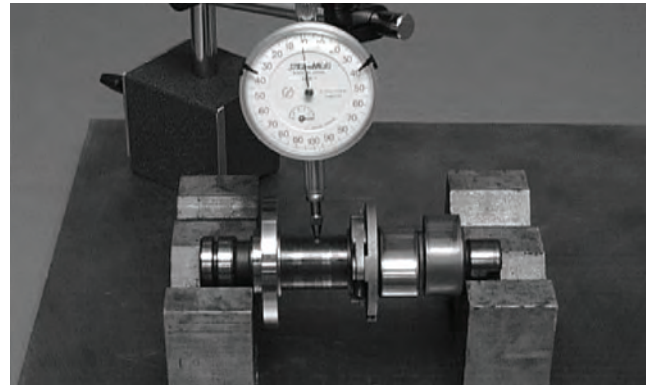

CC283D

2. Rotate the camshaft and note runout; maximum tolerance must not exceed specifications.

Measuring Camshaft Lobe Height

1. Using a calipers, measure each cam lobe height.

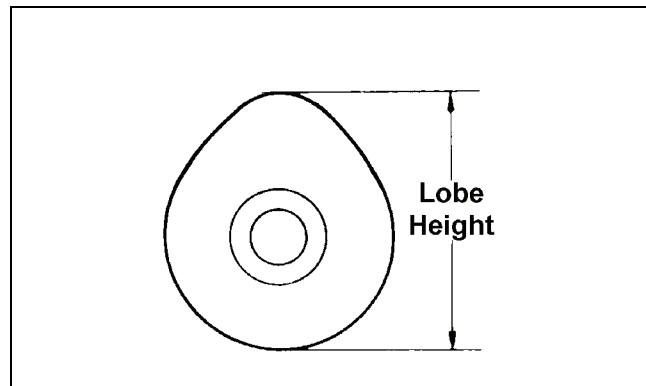

ATV1013A

2. The lobe heights must not exceed minimum specifications.

Inspecting Camshaft Bearing Journal

1. Inspect the bearing journal for scoring, seizure marks, or pitting.
2. If excessive scoring, seizure marks, or pitting is found, the cylinder head assembly must be replaced.

Measuring Camshaft to Cylinder Head Clearance

1. Remove the adjuster screws and jam nuts.

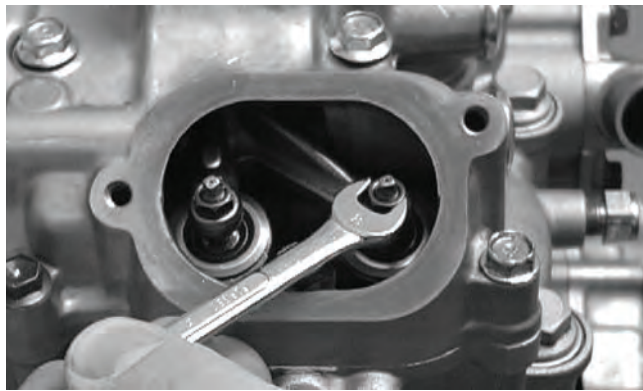

CC005D

2. Place a strip of plasti-gauge in each of the camshaft lands in the cylinder head.
3. Place the valve cover on the cylinder head and secure with the valve cover cap screws. Tighten securely.

■NOTE: Do not rotate the camshaft when measuring clearance.

4. Remove the cap screws securing the valve cover to the cylinder; then remove the valve cover and camshaft.

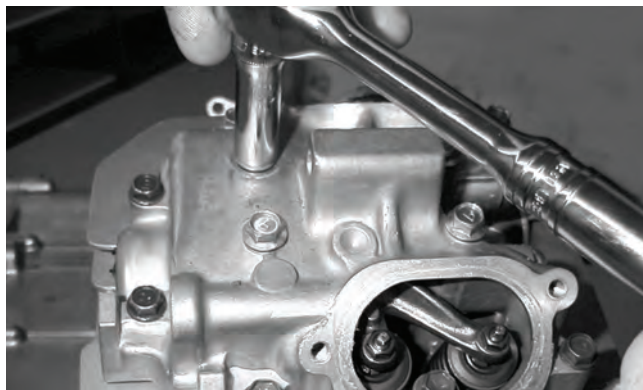

MD1261

5. Match the width of the plasti-gauge with the chart found on the plasti-gauge packaging to determine camshaft to cylinder head and valve cover clearance.

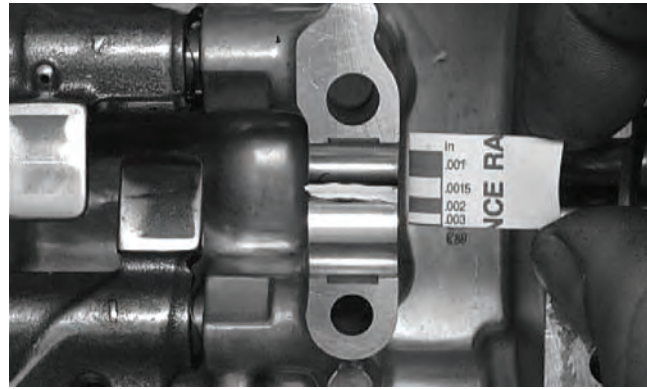

CC145D

6. If clearance is excessive, measure the journals of the camshaft.

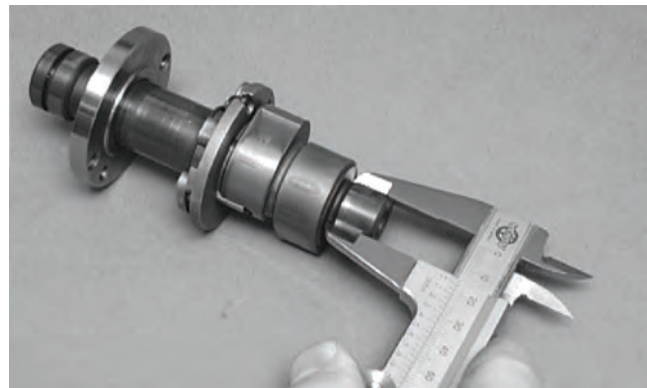

CC287D

■NOTE: If the journals are worn, replace the camshaft; then measure the clearance again. If it is still out of tolerance, replace the cylinder head.

Inspecting Camshaft Spring/Drive Pin

1. Inspect the spring and unloader pin for damage.

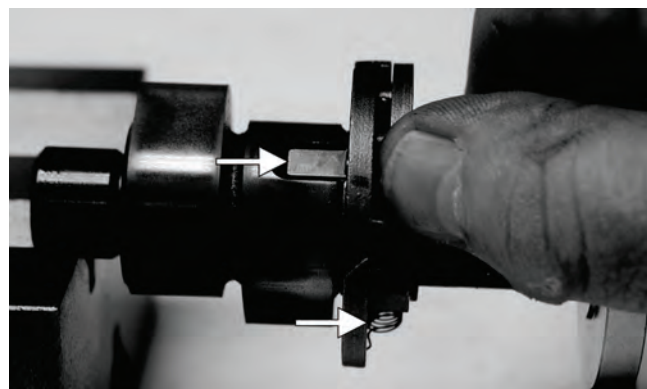

CF061A

■NOTE: With the weight extended, the unloader pin should be flat-side out; with the weight retracted, the unloader pin should be round-side out.

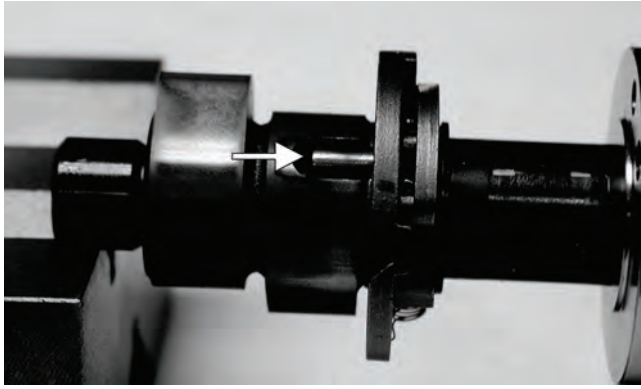

CF060A

2. If damaged, the camshaft must be replaced.

Installing Top-Side Components

- A. Piston
- B. Cylinder

■NOTE: If the piston rings were removed, install them in this sequence.

A. Install ring expander (4) in the bottom groove of the piston; then install the thin oil rings (3) over the expander making sure the expander ends do not overlap. Stagger the end gaps of the upper and lower thin oil rings according to the illustration.

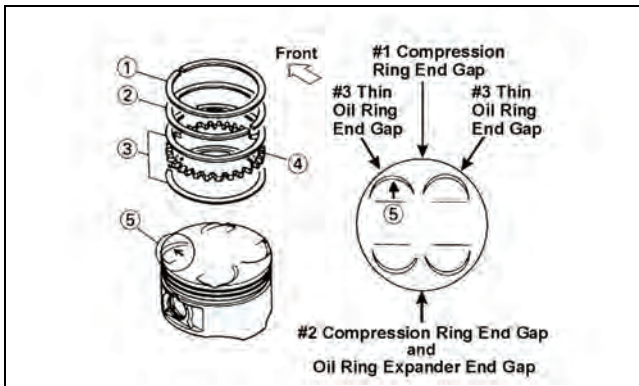

ATV-1085B

■NOTE: Note the direction of the exhaust side of the piston (5) for correct ring end gap orientation.

B. Install the compression rings (1 and 2) so the letter(s) on the top surface of each ring faces the top of the piston. Rotate the rings until the ring end gaps are on directly opposite sides of the piston according to the illustration.

■NOTE: The chrome (silver) ring should be installed in the top position.

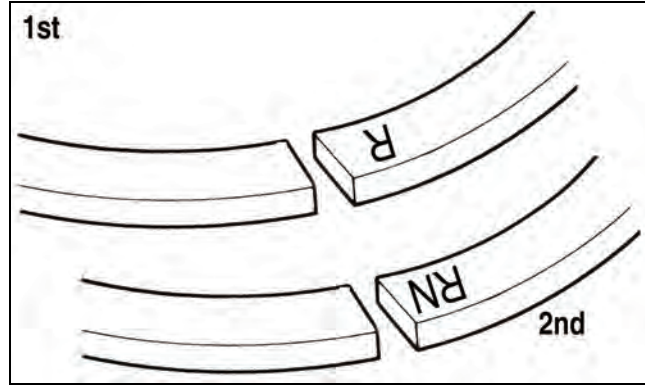

MD1343A

CAUTION

Incorrect installation of the piston rings will result in engine damage.

1. Install the piston on the connecting rod making sure there is a circlip on each side and the open end of the circlip is directed upwards or downwards.

■NOTE: The piston should be installed so the arrow points towards the exhaust.

3

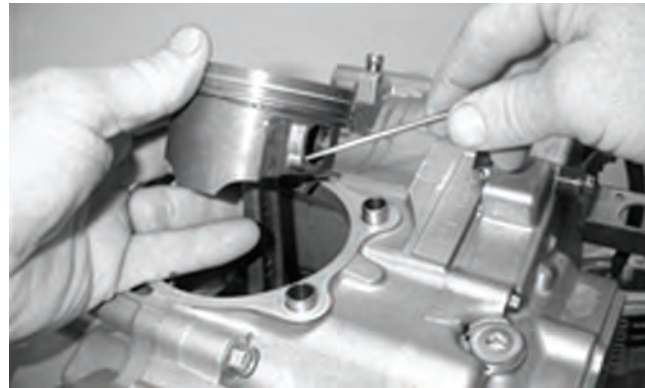

MD1213

2. Place the two alignment pins into position. Place a new cylinder gasket into position; then place a piston holder (or suitable substitute) beneath the piston skirt and square the piston in respect to the crankcase.

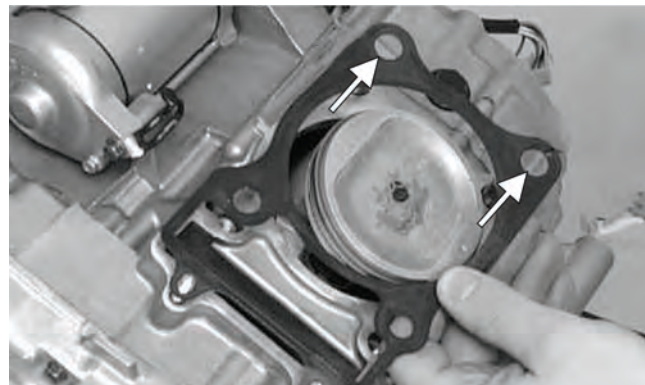

MD1344

- Lubricate the inside wall of the cylinder; then using a ring compressor or the fingers, compress the rings and slide the cylinder over the piston. Route the cam chain up through the cylinder cam chain housing; then remove the piston holder and seat the cylinder firmly on the crankcase.

CAUTION

The cylinder should slide on easily. Do not force the cylinder or damage to the piston, rings, cylinder, or crankshaft assembly may occur.



- Loosely install the two nuts securing the cylinder to the right-side crankcase half.

■NOTE: The two cylinder-to-crankcase nuts will be tightened in step 9.



**C. Cylinder Head/Camshaft
D. Valve Cover/Rocker Arms**

■NOTE: Steps 1-4 in the preceding sub-section must precede this procedure.

- While keeping tension on the cam chain, place the front cam chain guide into the cylinder.

CAUTION

Care should be taken that the bottom of the chain guide is secured in the crankcase boss.

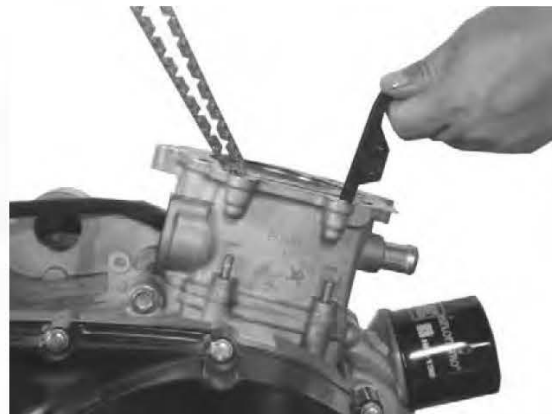

- Place a new gasket into position on the cylinder. Place the alignment pins into position; then place the head assembly into position on the cylinder making sure the cam chain is routed through the chain cavity.

CAUTION

Keep tension on the cam chain to avoid damaging the crankcase boss.



MD1347



- Install the four cylinder head cap screws with washers. Note that the two cap screws on the right side of the cylinder head nearest the cam sprocket are longer than the two cap screws on the left (spark plug) side. Tighten only until snug.



8. Install the two lower nuts securing the cylinder head to the cylinder, one in front and one in rear.

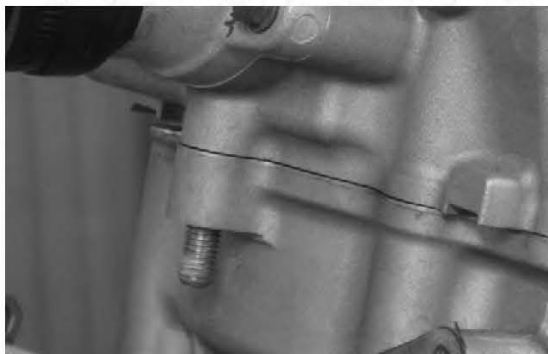

9. In a crisscross pattern, tighten the four cylinder head cap screws (from step 7) to 27.5 ft-lb. Tighten the two lower cylinder head nuts (from step 8) to 20 ft-lb and the cylinder-to-crankcase nuts (from step 4) to 8 ft-lb.
10. With the timing inspection plug removed and the cam chain held tight, rotate the crankshaft until the piston is at top-dead-center.
11. While holding the cam chain sprocket to the side, install the rear cam chain tensioner guide into the cylinder head. Install the pivot cap screw and washer.



CD383

12. With the alignment pin installed in the camshaft and the cam lobes directed down (toward the piston), place the camshaft in position and verify that the timing mark on the magneto is visible through the inspection plug and that the timing marks on the camshaft sprocket are parallel with the valve cover mating surface.

■NOTE: When the camshaft assembly is seated, make sure the alignment pin in the camshaft aligns with the smallest hole in the sprocket.

13. With the alignment pin installed in the camshaft, loosely place the cam sprocket (with the recessed side facing the camshaft lobes) onto the camshaft and place it into position with the cam chain over the sprocket.

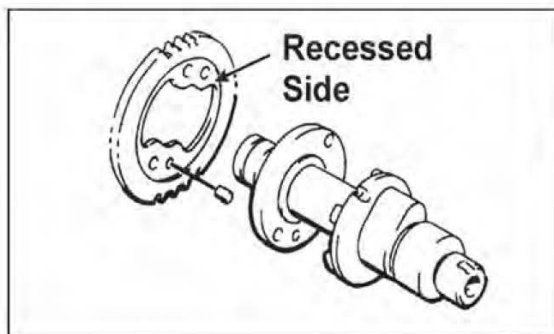

MD1359

14. Place the C-ring into position in its groove in the cylinder head.



■NOTE: At this point, oil the camshaft bearings, cam lobes, and the three seating journals on the cylinder head.

■NOTE: Note the position of the alignment marks on the end of the camshaft. They must be parallel with the valve cover mating surface. If rotating the camshaft is necessary for alignment, do not allow the chain and sprocket to rotate and be sure the cam lobes end up in the down position.

15. When the camshaft assembly is seated, ensure the following.

- A. Piston still at top-dead-center.
- B. Camshaft lobes directed down (toward the piston).
- C. Camshaft alignment marks parallel to the valve cover mating surface.
- D. Recessed side of the sprocket directed toward the cam lobes.
- E. Camshaft alignment pin and sprocket alignment hole (smallest) are aligned.

CAUTION

If any of the above factors are not as stated, go back to step 13 and carefully proceed.

16. Place the tab washer onto the sprocket making sure it covers the pin in the alignment hole.

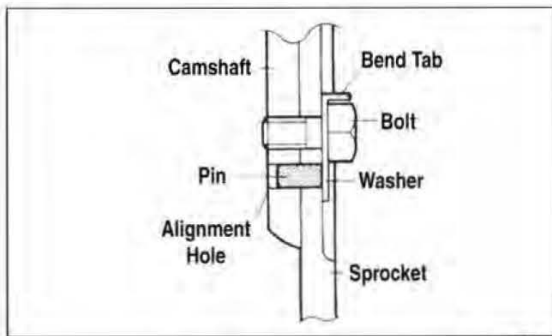

MD1363

CAUTION

Care must be taken that the tab washer is installed correctly to cover the alignment hole on the sprocket. If the alignment pin falls out, severe engine damage will result.

17. Apply red Loctite #271 to the first cap screw securing the sprocket and tab washer to the camshaft; then install the cap screw and tab washer. Tighten cap screw only until snug.



CC404D

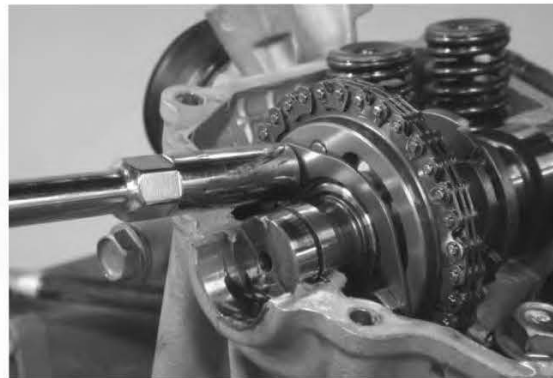

18. Rotate the crankshaft until the second cap screw securing the sprocket to the camshaft can be installed; then install the cap screw (threads coated with red Loctite #271). Tighten to 11 ft-lb; then bend the tab to secure the cap screw.

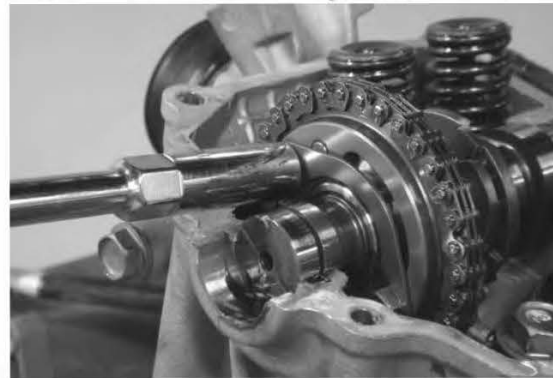

19. Rotate the crankshaft until the first cap screw (from step 17) securing the sprocket to the camshaft can be addressed; then tighten to 11 ft-lb. Bend the tab to secure the cap screw.
20. Install the cylinder head plug with the cupped end facing the camshaft and the opening directed downwards.
21. Remove the cap screw from the end of the chain tensioner.

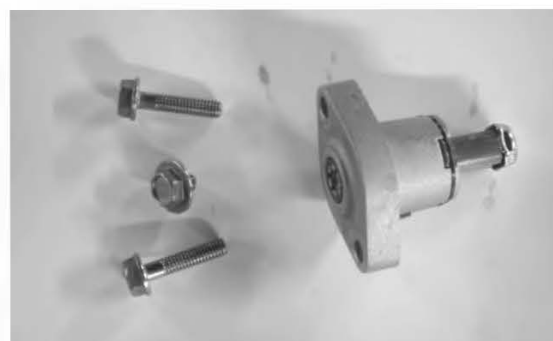

22. Depress the spring-loaded lock and push the plunger into the tensioner.



23. Place the cam chain tensioner assembly and gasket into the cylinder making sure the ratchet side is facing toward the top of the cylinder and secure with the two cap screws.



24. Install the cap screw and spring into the end of the cam chain tensioner. Tighten securely.

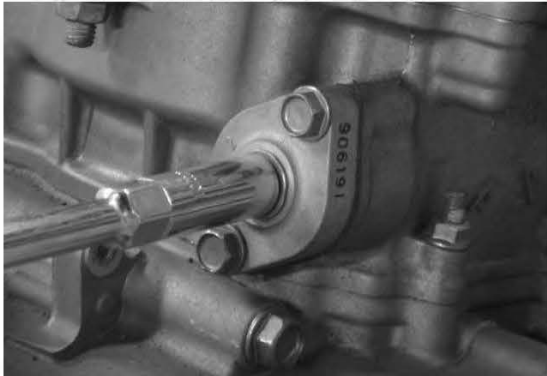

25. Loosen the adjuster screw jam nuts; then loosen the adjuster screws on the rocker arms in the valve cover.
26. Apply a thin coat of Three Bond Sealant to the mating surface of the valve cover; then place the valve cover into position. Note that the two alignment pins are properly positioned.

■NOTE: At this point, the rocker arms and adjuster screws must not have pressure on them.

27. Install the four top-side cap screws with rubber washers; then install the remaining cap screws. Tighten only until snug.



MD1261

28. In a crisscross pattern starting from the center and working outward, tighten the cap screws (from step 27) to 8 ft-lb.
29. Adjust valve/tappet clearance (see Section 2).
30. Place the two tappet covers with O-rings into position; then install and tighten the cap screws securely.

3



31. Install the spark plug and tighten to 8 ft-lb; then install the timing inspection plug.

Left-Side Components

■NOTE: For efficiency, it is preferable to remove and disassemble only those components which need to be addressed and to service only those components. The technician should use discretion and sound judgment.

AT THIS POINT

To service any one specific component, only limited disassembly of components may be necessary. Note the AT THIS POINT information in each sub-section.

■NOTE: The engine/transmission does not have to be removed from the frame for this procedure.

Removing Left-Side Components

A. Cover/Stator Assembly

1. Remove the cap screws securing the outer magneto cover and remove the cover.
2. Remove the left-side cover-to-crankcase mounting cap screws noting the location of the 8 mm cap screw with the washer near the middle of the left-side cover. Keep the different-lengthed 6 mm cap screws in order for installing purposes.

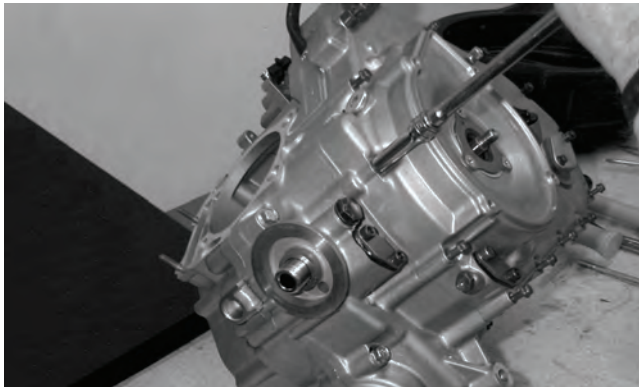

MD1186

3. Using Side Case Puller and the 6 mm adapter, remove the left-side cover w/stator assembly. Account for the two alignment pins and the position of the shifter bracket for installing purposes.

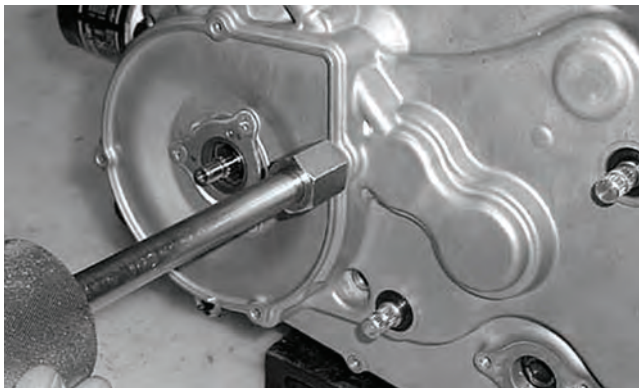

CC946

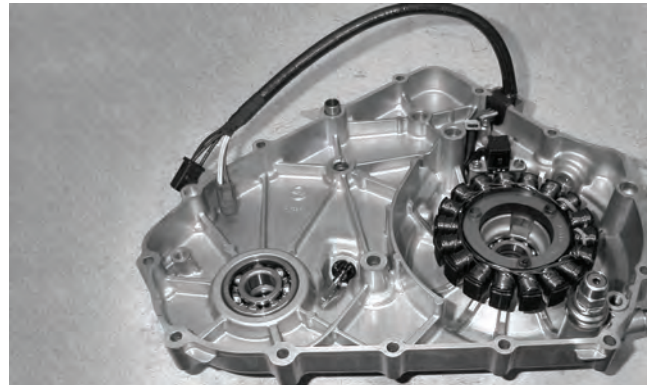

MD1188

■NOTE: Inspect the inside of the left-side cover for any shaft washers that may have come off with the cover. Make sure they are returned to their respective shafts and that the starter idler gear spacer is on the shaft or in the cover.

B. Rotor/Flywheel C. Starter Motor

■NOTE: Steps 1-3 in the preceding sub-section must precede this procedure.

4. Remove the rotor/flywheel nut.



MD1194

5. Install the crankshaft protector.

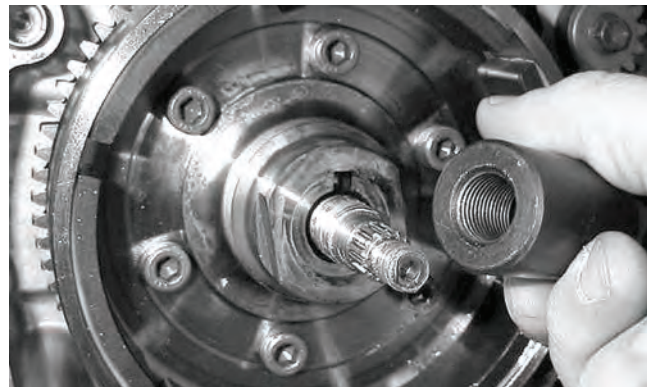

MD1365

- Using Magneto Rotor Remover, break the rotor/flywheel assembly loose from the crankshaft. Remove the remover, the crankshaft protector, the rotor/flywheel, and the starter clutch gear. Account for the key.

CAUTION

Care must be taken that the remover is fully threaded onto the rotor/flywheel or damage may occur.



MD1368



MD1369



MD1370

- Remove the starter idler gear (No. 1) and starter idler gear (No. 2).

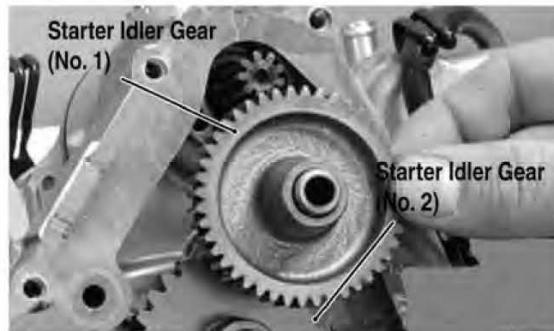

MD1305

- Remove the gear shift shaft assembly and washer from the left-side crankcase. Note the positions of the alignment marks and washer for installing purposes; then release the cam stopper spring tension.



MD1239

- Remove the shift detent cam. Note position of spacer for installing purposes.
- Remove the cam stopper assembly.
- Remove two starter motor cap screws.



- Remove starter motor by tapping lightly with a mallet.

NOTE: The starter motor is a non-serviceable component and must be replaced as an assembly.

- Using an impact screwdriver, remove the three Phillips-head screws holding the crankshaft bearing retainer. Remove the crankshaft bearing retainer.

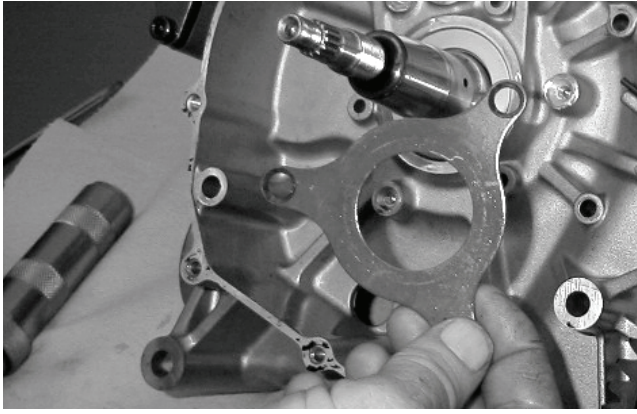

MD1122

Installing Left-Side Components

A. Starter Idler Gears

B. Rotor/Flywheel

1. Place the crankshaft bearing retainer into position. Apply red Loctite #271 to the three cap screws. Install and tighten the three cap screws securely.

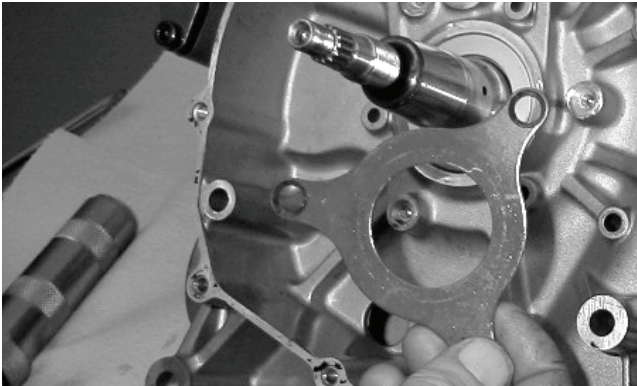

MD1122

2. Install the starter motor and tighten the two cap screws securely.
3. Install the shift detent cam making sure the spacer is properly positioned.

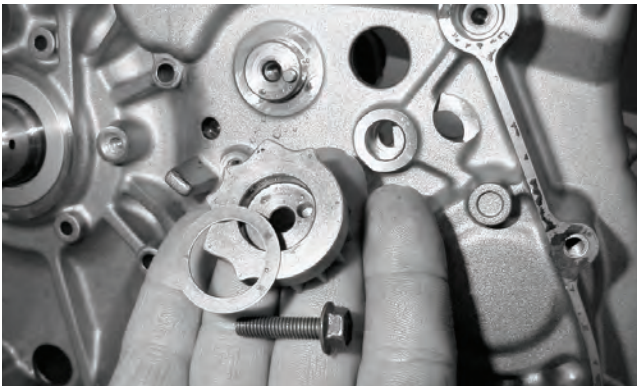

MD1086

4. Install the cam stopper assembly.
5. Install the gear shift shaft assembly and washer making sure to align the alignment marks.



MD1239

6. Install starter idler gear (No. 2) and starter idler gear (No. 1).

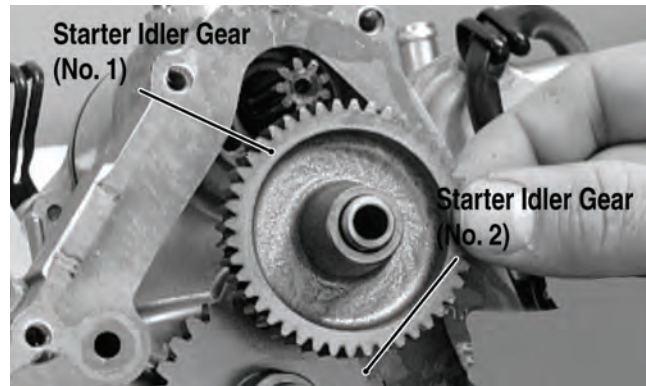

MD1305

7. Place the key into its notch; then slide the rotor/flywheel (with the ring gear in place) over the crankshaft. Tighten the nut to 107 ft-lb.

C. Cover

■NOTE: Steps 1-7 in the preceding sub-section must precede this procedure.

8. Install two alignment pins and place the left-side cover gasket into position. Install the left-side cover. Noting the different-lengthed 6 mm cap screws, the position of the shifter bracket, and the location of the long cap screw with the washer, tighten cap screws in a crisscross pattern to 8 ft-lb.
9. Place the outer magneto cover into position on the left-side cover; then install and tighten the four cap screws securely.

Right-Side Components

 **AT THIS POINT**

To service center crankcase components only, proceed to Removing Right-Side Components.

■NOTE: For efficiency, it is preferable to remove and disassemble only those components which need to be addressed and to service only those components. The technician should use discretion and sound judgment.

 **AT THIS POINT**

To service any one specific component, only limited disassembly of components may be necessary. Note the AT THIS POINT information in each sub-section.

■NOTE: The engine/transmission does not have to be removed from the frame for this procedure.

Removing Right-Side Components

A. V-Belt Cover

B. Driven Pulley

C. Clutch Cover

1. If the engine is still in the frame, remove the cap screw securing the brake pedal to the pivot shaft. Account for a flat washer.



2. Remove the cap screws securing the V-belt cover to the clutch cover; then slide the brake pedal outward and remove the V-belt cover. Account for two alignment pins and a gasket.

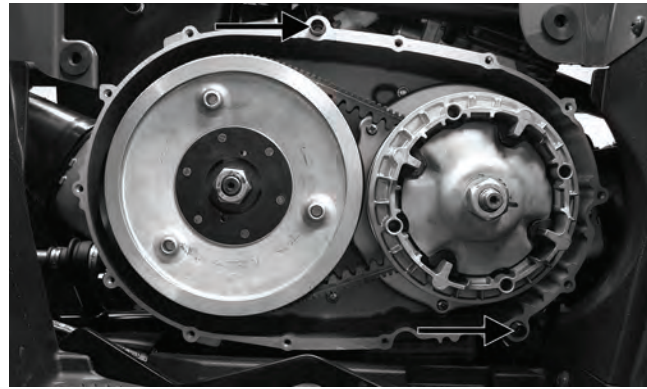

3. Mark the movable drive face and the fixed drive face for installing purposes; then remove the nut holding the movable drive face onto the crankshaft.

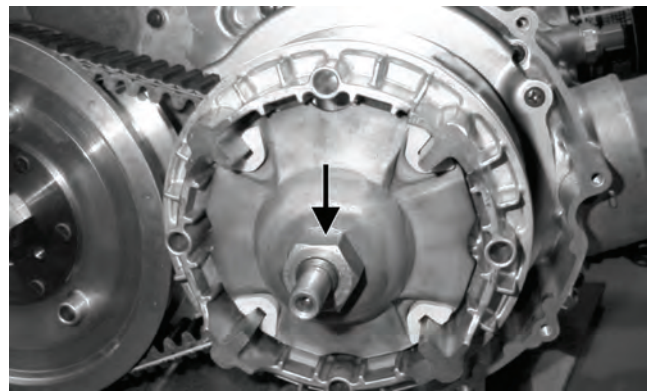

4. Remove the movable drive face and spacer. Account for the movable drive face rollers and outer drive face cover.

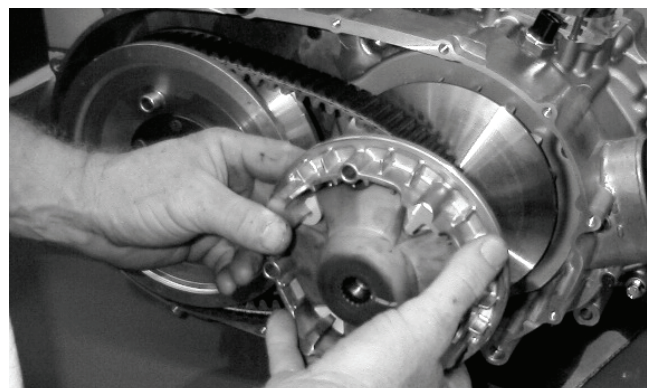

3

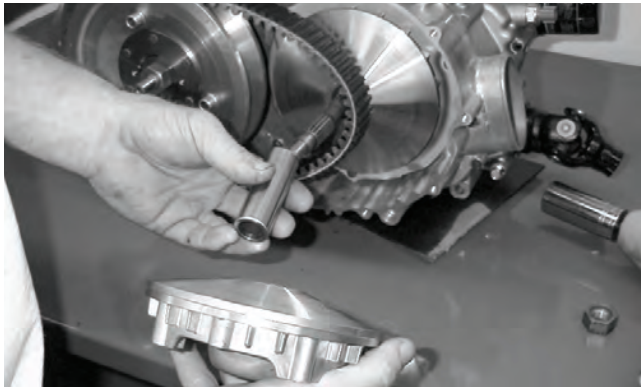

MD1034

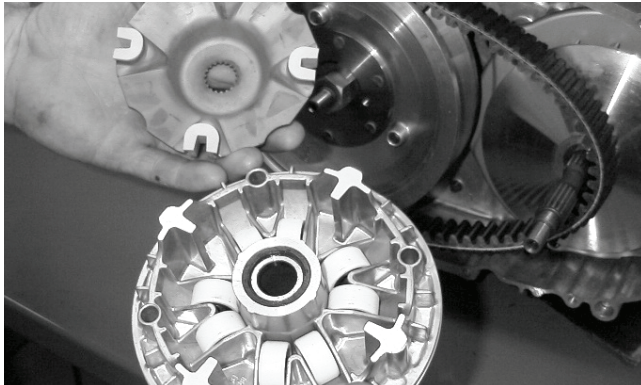

MD1036

5. Remove the V-belt.

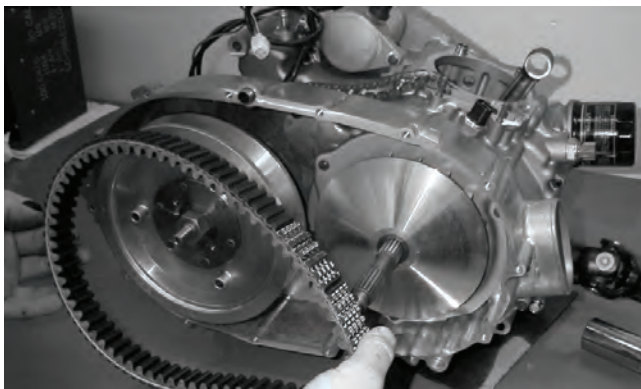

MD1118

6. Remove the fixed drive face.

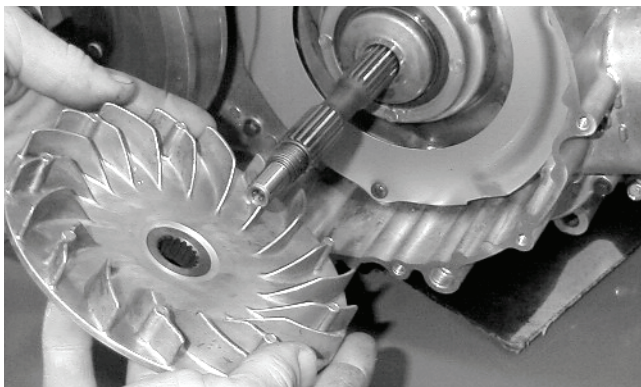

MD1094

7. Remove the nut holding the driven pulley assembly; then remove the driven pulley assembly.

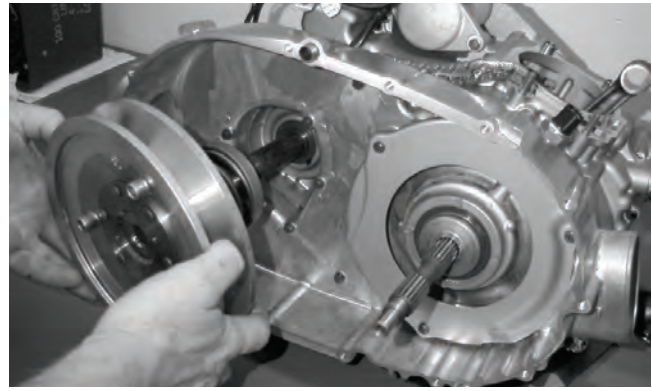

MD1068

8. Using an impact screwdriver, remove the three Phillips-head cap screws holding the air intake plate. Remove the air intake plate.

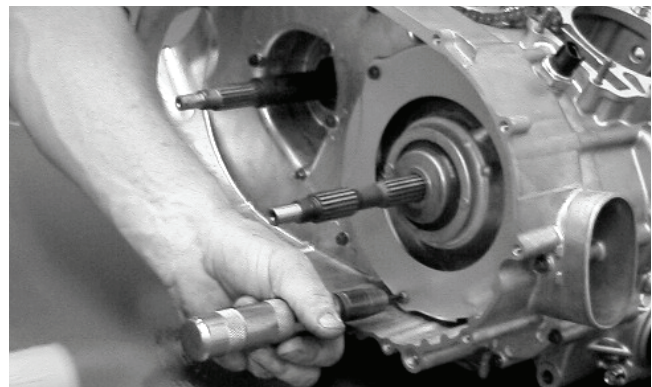

MD1092

9. Remove the cap screws holding the clutch cover onto the right-side crankcase half. Note the positions of the different-lengthed cap screws for installing purposes.

10. Using a rubber mallet, loosen the clutch cover; then pull it away from the right-side crankcase half. Account for two alignment pins and gasket.

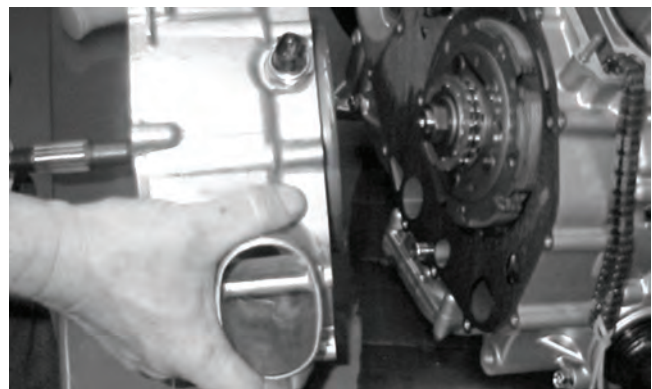

MD1115

D. Gear Shift Position Switch
E. Centrifugal Clutch Assembly
F. Oil Pump Drive Gear
G. Oil Pump Driven Gear

■NOTE: Steps 1-10 in the preceding sub-section must precede this procedure.

11. Remove the cap screw holding the gear shift position switch onto the right-side crankcase half.



KC324A

12. Remove the gear shift position switch. Account for a spacer.

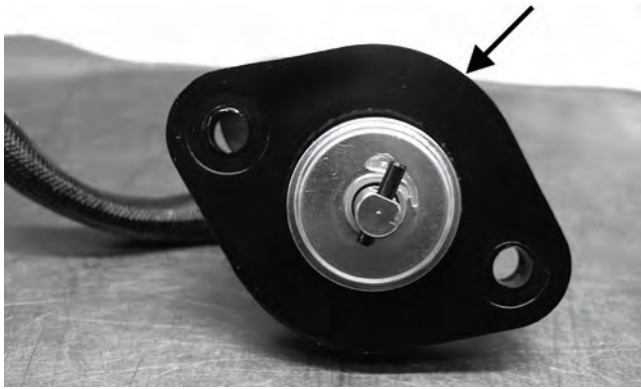

KC326A

13. Remove the one-way clutch noting the direction of the green dot or the word OUTSIDE for installing purposes.

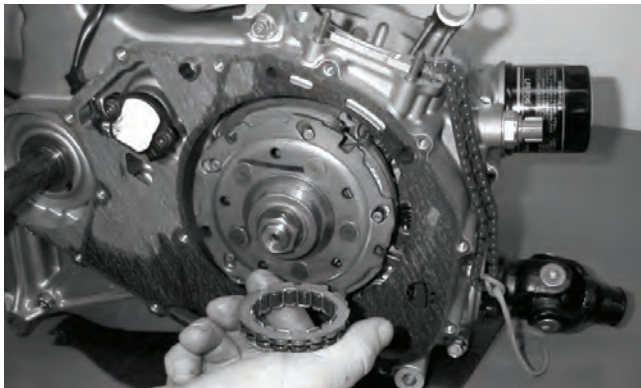

MD1286

14. Remove the left-hand threaded nut holding the centrifugal clutch assembly.

CAUTION
Care must be taken when removing the nut; it has "left-hand" threads.

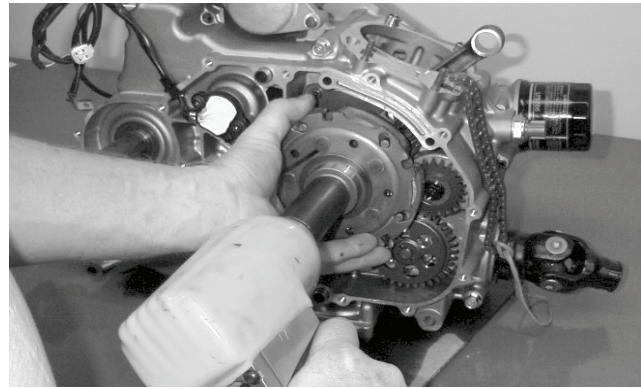

MD1014

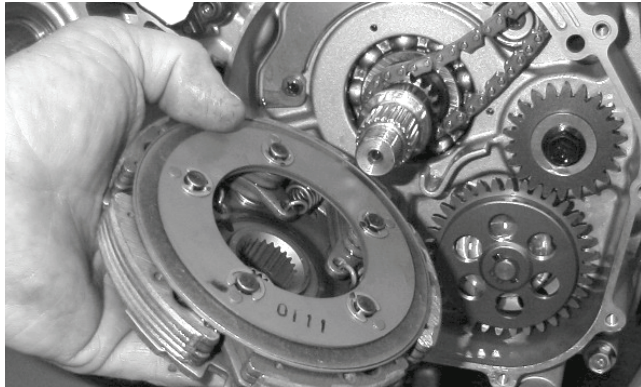

MD1016

15. Remove the cam chain.

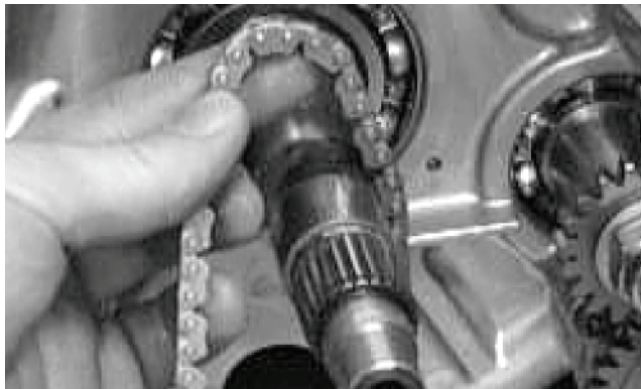

MD1335

16. Remove the oil pump drive gear cap screw.

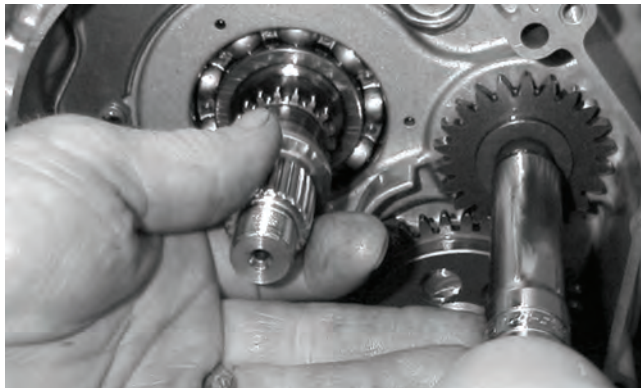

MD1018

17. Remove oil pump drive gear. Account for the pin.

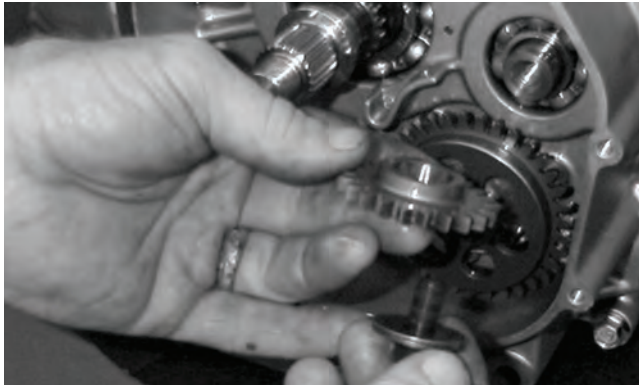

MD1017

18. Remove the snap ring holding the oil pump driven gear.

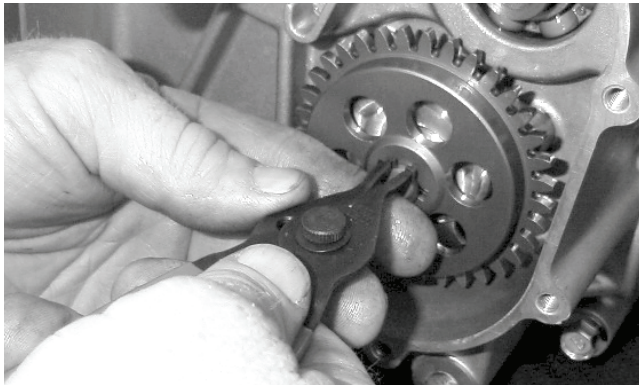

MD1019

■NOTE: Always use a new snap ring when installing the oil pump driven gear.

19. Remove oil pump driven gear. Account for the pin.

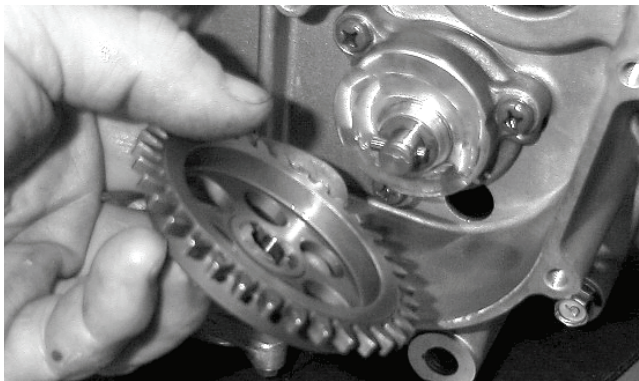

MD1020

⚠ AT THIS POINT

To service clutch components, see Servicing Right-Side Components sub-section.

H. Oil Pump/Oil Strainer

■NOTE: Steps 1-19 in the preceding sub-sections must precede this procedure.

20. Remove three Phillips-head screws holding the oil pump and remove the oil pump. Account for two alignment pins.

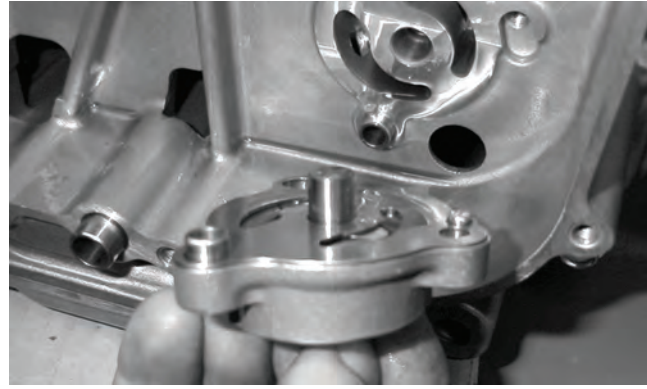

MD1060

21. Remove the four cap screws securing the oil strainer cover; then remove the Phillips-head screws securing the oil strainer. Account for the O-ring.

■NOTE: Note the directional arrow for installing purposes.

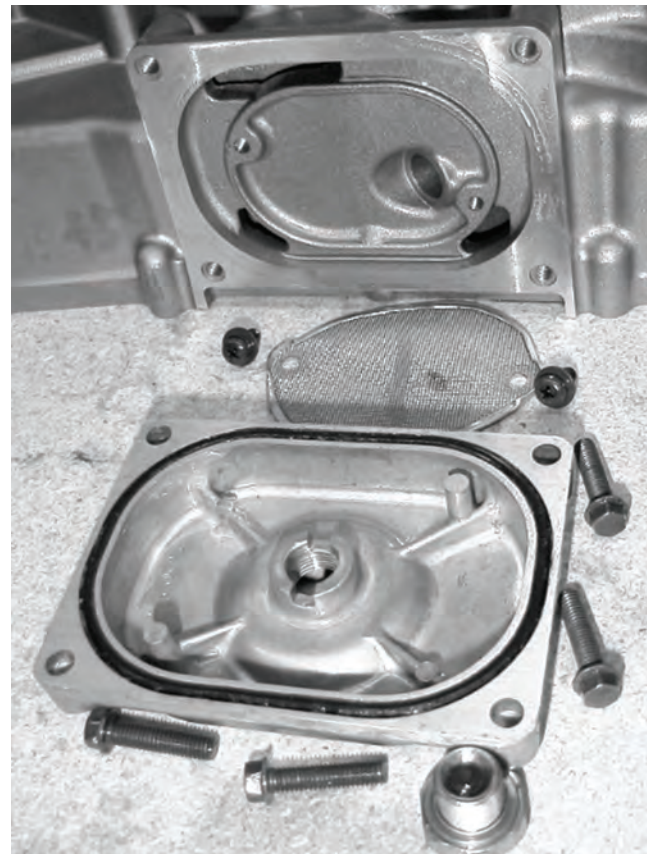

MD1207

⚠ AT THIS POINT

To service center crankcase components only, proceed to Separating Crankcase Halves.

Servicing Right-Side Components

■NOTE: Whenever a part is worn excessively, cracked, damaged in any way, or out of tolerance, replacement is necessary.

INSPECTING CENTRIFUGAL CLUTCH SHOE

1. Inspect the clutch shoe for uneven wear, chips, cracks, or discoloration.
2. Inspect the depth of the grooves in the clutch shoes. If any shoe is worn to the bottom of the groove, replace the complete set.

⚠ CAUTION

Always replace clutch shoes as a complete set or severe imbalance could occur.

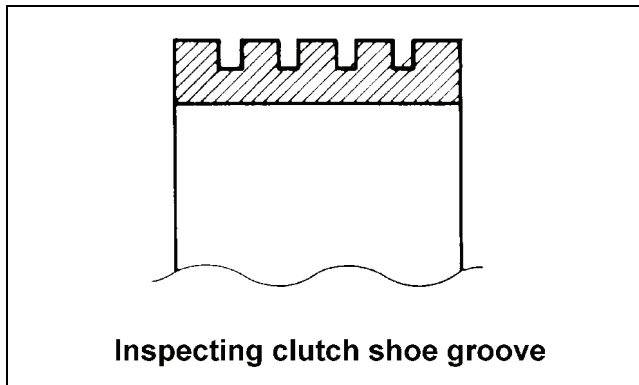

ATV1014

INSPECTING CENTRIFUGAL CLUTCH HOUSING

1. Inspect the clutch housing for burns, marks, scuffs, cracks, scratches, or uneven wear.
2. If the housing is damaged in any way, the housing must be replaced.

INSPECTING PRIMARY ONE-WAY DRIVE

1. Insert the drive into the clutch housing.
2. Rotate the inner race by hand and verify the inner race rotates only one direction.
3. If the inner race is locked in place or rotates both directions, the drive assembly must be replaced.

INSPECTING OIL PUMP

1. Inspect the pump for damage.

2. It is inadvisable to remove the screw securing the pump halves. If the oil pump is damaged, it must be replaced.

■NOTE: The oil pump is a non-serviceable component and must be replaced as a complete assembly.

DRIVEN PULLEY ASSEMBLY

■NOTE: The driven pulley assembly is a non-serviceable component and must be replaced as a complete assembly.

Installing Right-Side Components

A. Oil Strainer/Oil Pump

1. Place the oil strainer into position beneath the crankcase. Tighten the Phillips-head screws (coated with red Loctite #271) securely.

3

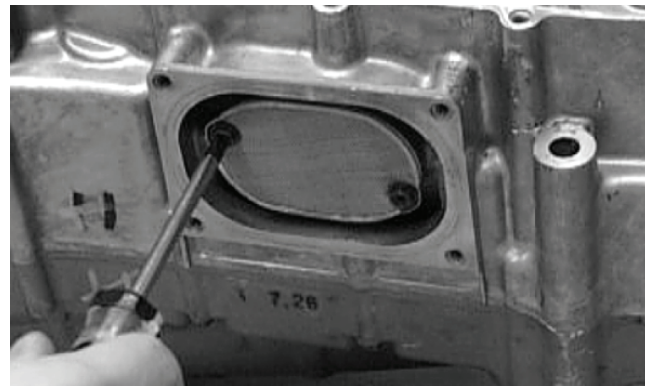

MD1337

2. Place the strainer cover into position on the crankcase making sure the O-ring is properly installed and secure with the four cap screws; then tighten the oil drain plug to 20 ft-lb.

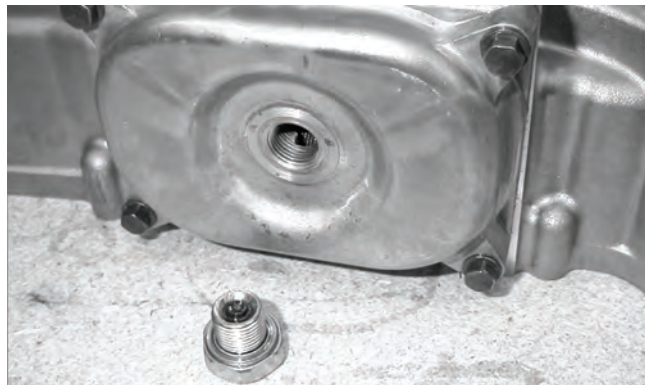

MD1208

3. Place two alignment pins and the oil pump into position on the crankcase and secure with the Phillips-head screws coated with blue Loctite #243. Tighten to 8 ft-lb.

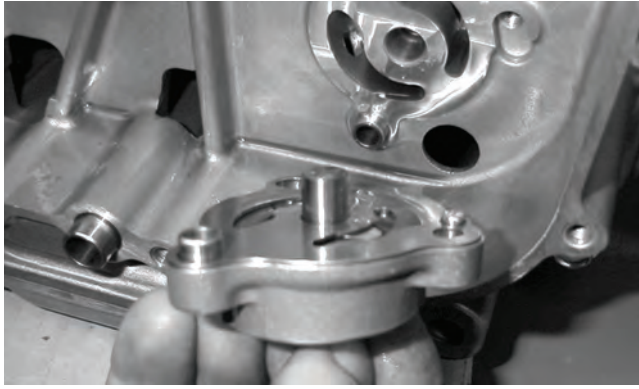

MD1060

- Place the pin into position on the oil pump shaft, install the oil pump driven gear making sure the recessed side of the gear is directed inward, and secure with a new snap ring.

■NOTE: Always use a new snap ring when installing the oil pump driven gear.

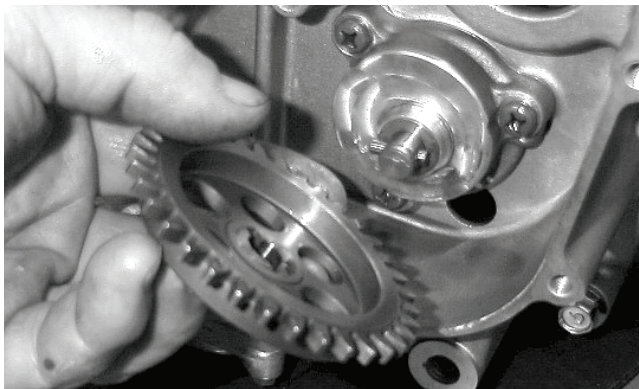

MD1020

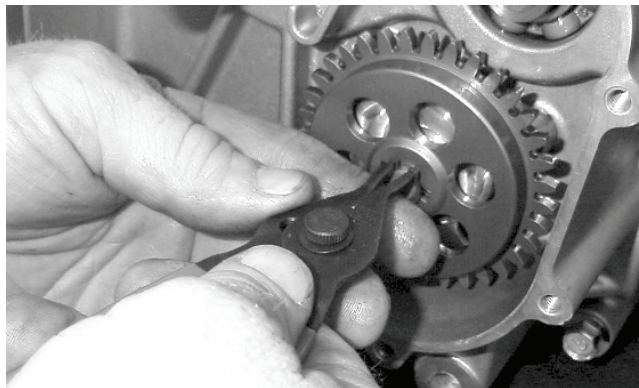

MD1019

- Install the cam chain.

■NOTE: Keep tension on the cam chain to avoid damaging the crankcase boss.

- Place the pin into position, install the oil pump drive gear, and tighten the cap screw (coated with red Loctite #271) to 63 ft-lb.

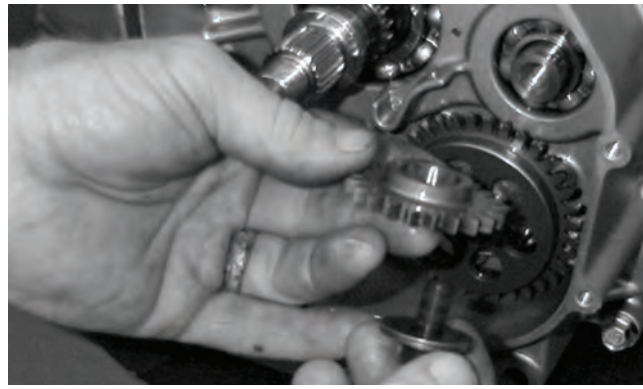

MD1017

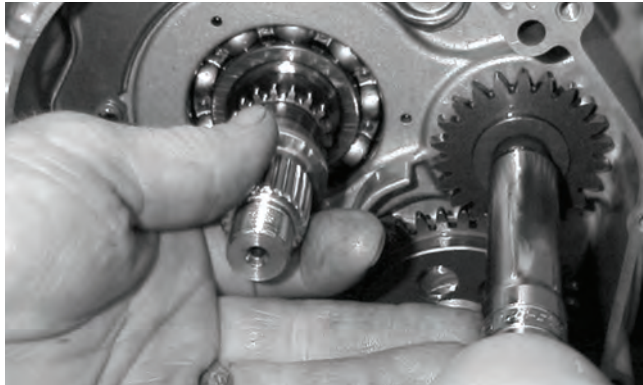

MD1018

- Install the clutch shoe assembly on the crankshaft; then install the flange nut (left-hand thread) (coated with red Loctite #271). Tighten to 147 ft-lb.

■NOTE: The flat side of the flange nut should be directed towards the clutch shoe.

⚠ CAUTION
Care must be taken when installing the flange nut; it has "left-hand" threads.

- Install the one-way clutch making sure that the green dot or the word OUTSIDE is directed away from the crankcase.

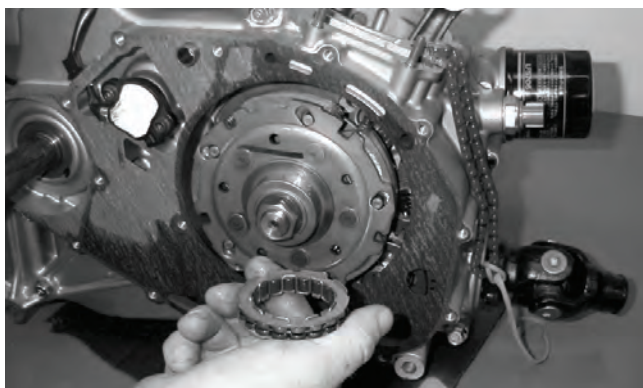

MD1286

- Install gear shift position switch spacer and switch making sure to align the drive pin with the slot in the shift shaft.

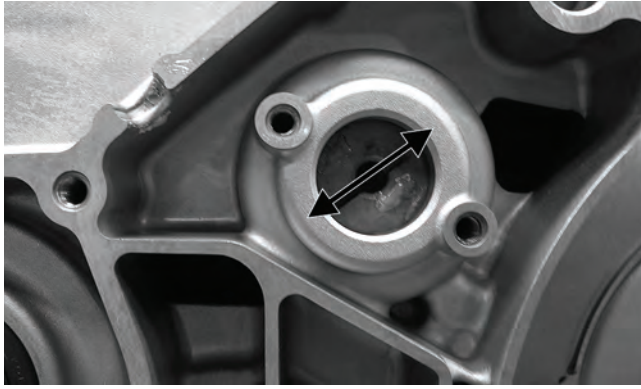

KC325A



KC326B

B. Clutch Cover
C. Fixed Drive Face
D. Movable Drive Face

■NOTE: Steps 1-9 in the preceding sub-section must precede this procedure.

10. Install two alignment pins and place the clutch cover gasket into position. Install the clutch cover.

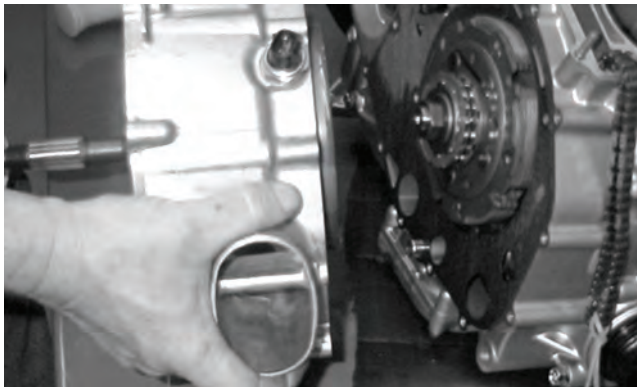

MD1115

11. Tighten the clutch cover cap screws to 8 ft-lb.

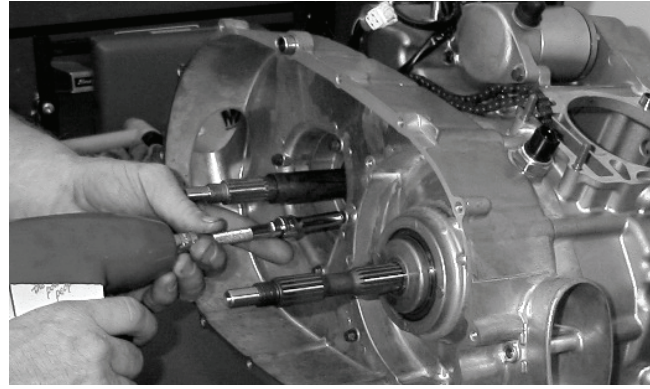

MD1117

12. Install the air intake plate. Apply red Loctite #271 to the threads of the three Phillips-head cap screws; then install and tighten securely.

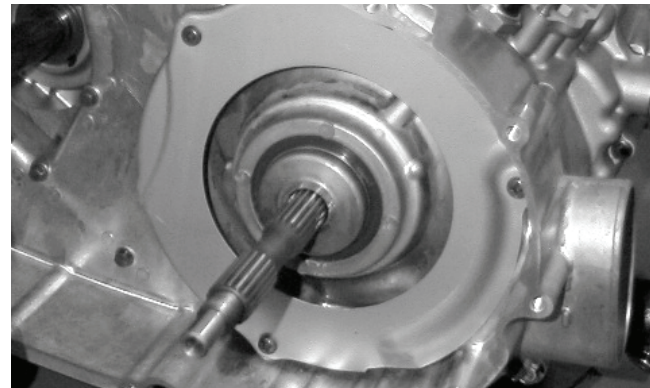

MD1342

13. Place the driven pulley assembly into position and secure with the nut (threads coated with red Loctite #271). Tighten to 147 ft-lb.

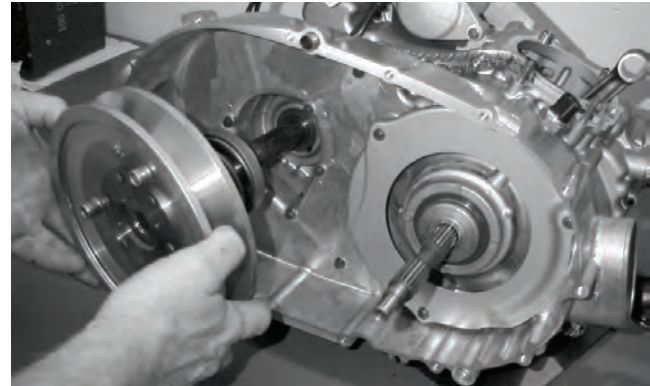

MD1068

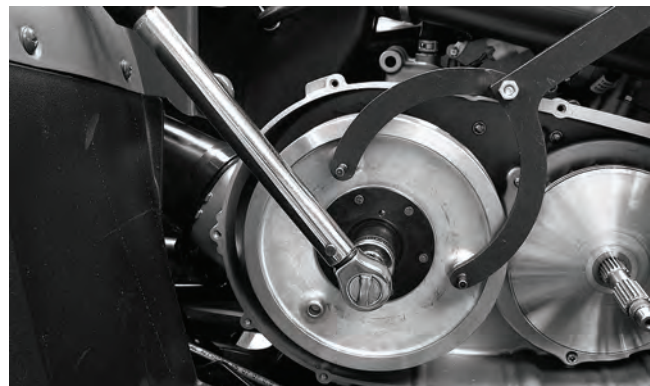

KC134

14. Slide the fixed drive face assembly onto the front shaft.
15. Spread the faces of the driven pulley by threading a V-belt cover cap screw into the fixed driven face and tightening until the faces open sufficiently to allow the V-belt to drop into the pulley approximately 3/4 in.

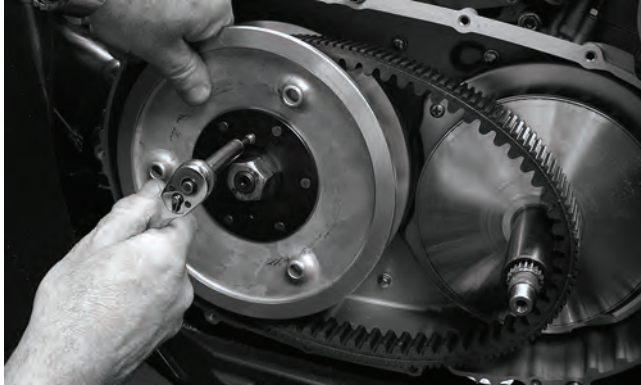

■NOTE: The arrows on the V-belt should point in direction of engine rotation.

16. Making sure the movable drive face rollers are in position, pinch the V-belt together near its center and slide the spacer and movable drive face onto the shaft.

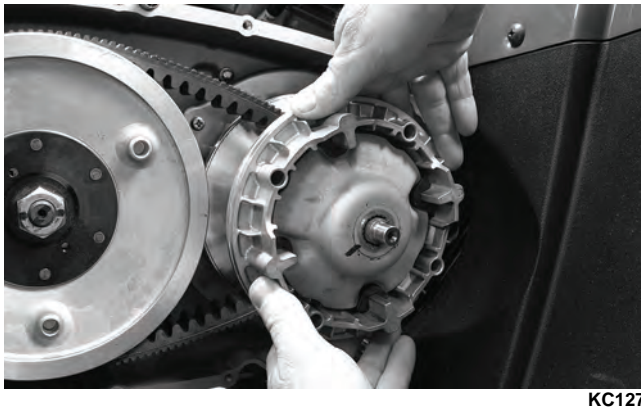

17. Coat the threads of the nut with red Loctite #271; then making sure the splines of the clutch shaft protrude through the cover plate, secure with the nut and tighten to 147 ft-lb.

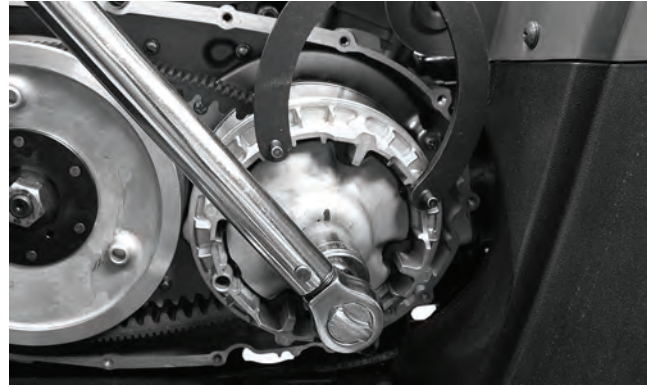

■NOTE: At this point, the cap screw can be removed from the driven pulley face.

18. Rotate the V-belt and drive/driven assemblies until the V-belt is flush with the top of the driven pulley.
19. Install two alignment pins and place a new V-belt cover gasket into position on the clutch cover. Install the V-belt cover noting the position of the long cap screws and rubber washer and two wire forms. In a crisscross pattern, tighten cap screws to 8 ft-lb.

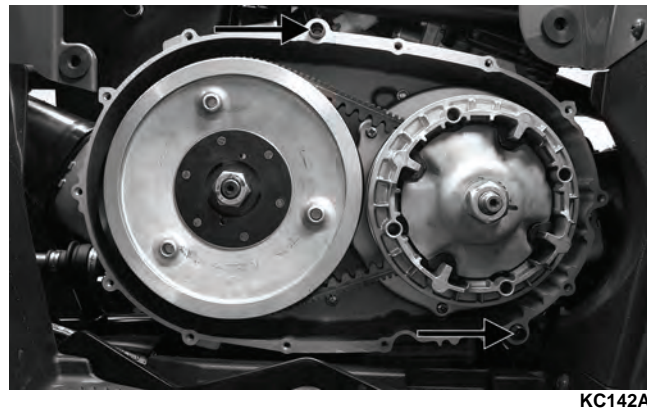

Center Crankcase Components

■NOTE: This procedure cannot be done with the engine/transmission in the frame. Complete Removing procedures for Top-Side, Left-Side, and Right-Side must precede this procedure.

■NOTE: For efficiency, it is preferable to remove and disassemble only those components which need to be addressed and to service only those components. The technician should use discretion and sound judgment.

Separating Crankcase Halves

1. Remove the left-side and right-side cap screws securing the crankcase halves noting the position of the different-sized cap screws for joining purposes.

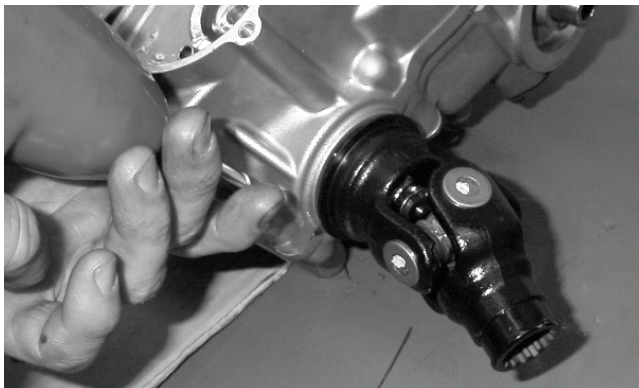
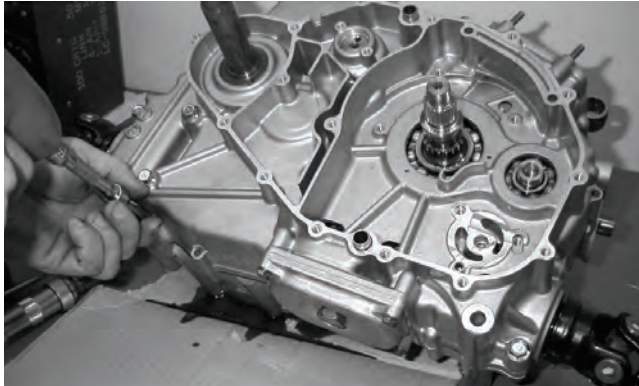

2. Using Crankcase Separator/Crankshaft Remover and tapping lightly with a rubber mallet, separate the crankcase halves. Account for two alignment pins.

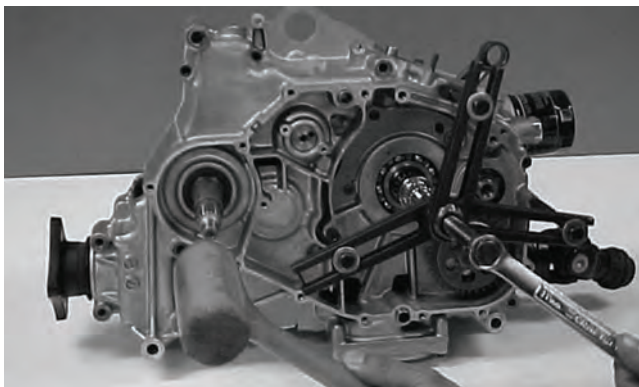

■NOTE: To keep the shaft/gear assemblies intact for identification, tap the shafts toward the left-side crankcase half when separating the halves.

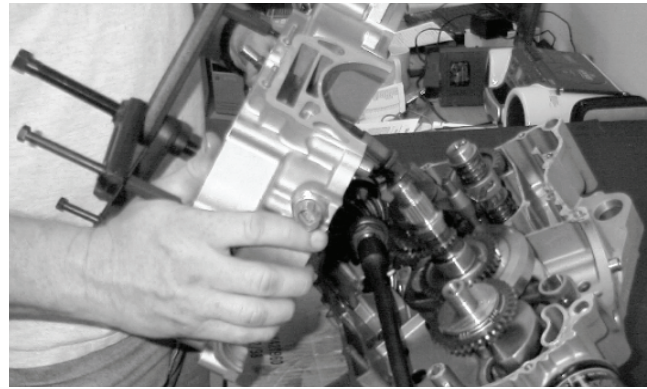

Disassembling Crankcase Half

1. Remove the secondary and primary driveshaft assemblies. Account for the bearing alignment C-ring on the bearing boss next to the pinion gear.

3

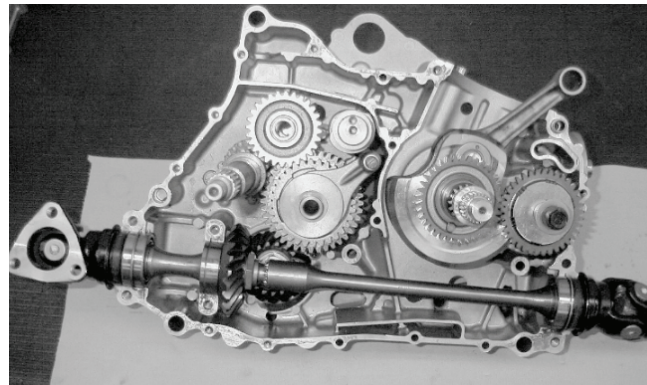

■NOTE: Note the location of the bearing alignment pin on the secondary output shaft.

2. Remove the reverse idler gear, spacer, and sleeve. Account for the washer.

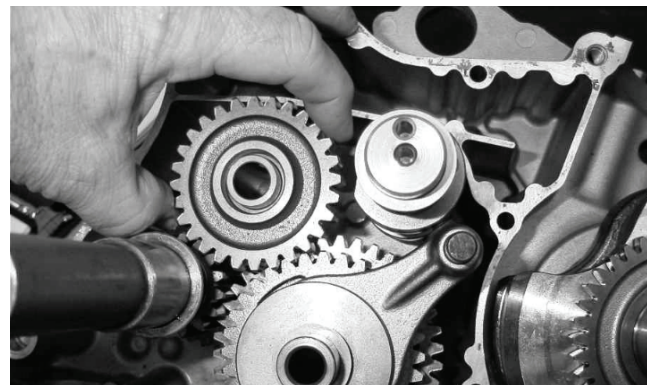

3. Remove the driveshaft.

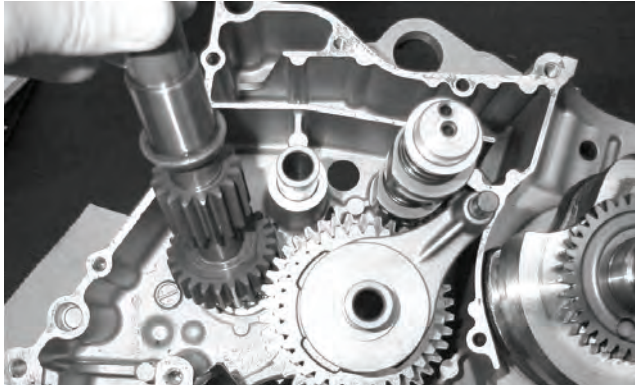

MD1326

4. Remove the shift fork shaft and the outer shift fork.

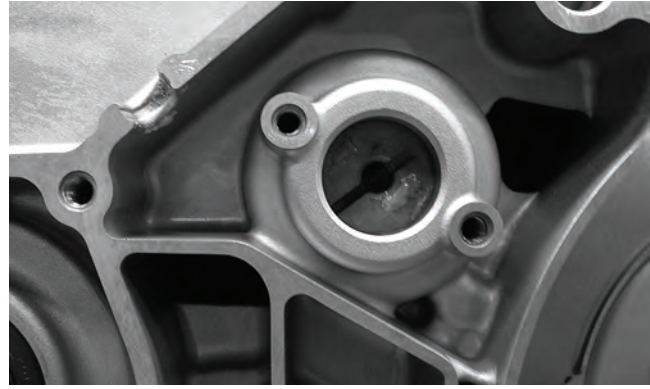

KC325

7. Remove the counterbalance gear. Account for the key.



MD1327

5. Remove snap ring and gear from the output side of the gear cluster. Remove the gear cluster and the inner shift fork together. Account for snap ring, gear, and washer.

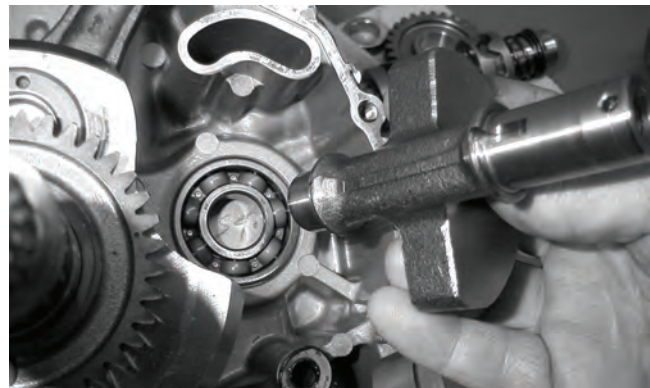

MD1024

9. Using Crankcase Separator/Crankshaft Remover, remove the crankshaft.

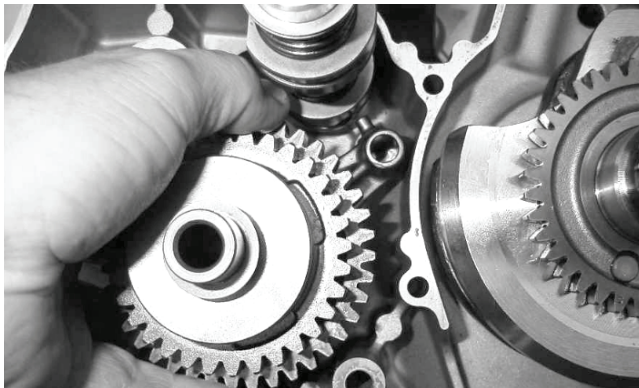

MD1328

6. Noting the position of the slot on the end, remove the shift cam assembly. Account for inner and outer washers.

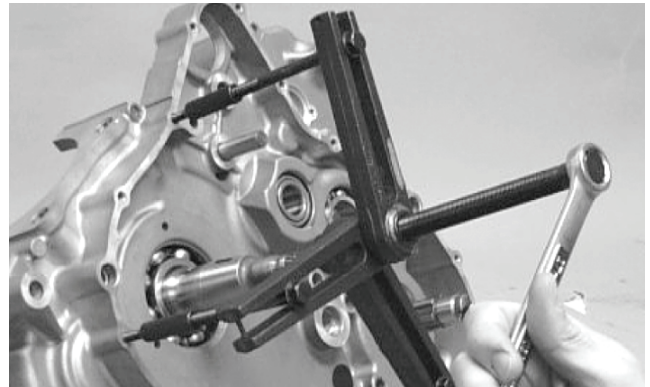

MD1330

⚠ CAUTION

Do not remove the remaining output shaft assembly unless absolutely necessary. If the shaft is removed, the shaft nut must be replaced with a new one and the shaft must be re-shimmed.

- Remove the secondary drive gear/secondary driven gear retaining nut. From inside the crankcase using a rubber mallet, drive out the output shaft assembly. Account for the output shaft, a shim, a washer, and the nut.

👉 AT THIS POINT

To service crankshaft assembly, see Servicing Center Crankcase Components sub-section.

Servicing Center Crankcase Components

■NOTE: Whenever a part is worn excessively, cracked, damaged in any way, or out of tolerance, replacement is necessary.

SECONDARY GEARS

■NOTE: When checking and correcting secondary gear backlash and tooth contact, the universal joint must be secured to the front shaft or false measurements will occur.

Checking Backlash

■NOTE: The rear shaft and bevel gear must be removed for this procedure. Also, always start with the original shims on the rear shaft.

- Place the left-side crankcase cover onto the left-side crankcase half to prevent runout of the secondary transmission output shaft.
- Install the secondary driven output shaft assembly onto the crankcase.
- Mount the indicator tip of the dial indicator on the secondary driven bevel gear (centered on the gear tooth).
- While rocking the driven bevel gear back and forth, note the maximum backlash reading on the gauge.
- Acceptable backlash range is 0.05-0.33 mm (0.002-0.013 in.).

Correcting Backlash

■NOTE: If backlash measurement is within the acceptable range, no correction is necessary.

- If backlash measurement is less than specified, remove an existing shim, measure it, and install a new thinner shim.
- If backlash measurement is more than specified, remove an existing shim, measure it, and install a thicker shim.

■NOTE: Continue to remove, measure, and install until backlash measurement is within tolerance. Note the following chart.

Backlash Measurement	Shim Correction
Under 0.05 mm (0.002 in.)	Decrease Shim Thickness
At 0.05-0.33 mm (0.002-0.013 in.)	No Correction Required
Over 0.33 mm (0.013 in.)	Increase Shim Thickness

Checking Tooth Contact

■NOTE: After correcting backlash of the secondary driven bevel gear, it is necessary to check tooth contact.

- Remove the secondary driven output shaft assembly from the left-side crankcase half.
- Clean the secondary driven bevel gear teeth of old oil and grease residue.
- Apply a thin, even coat of a machinist-layout dye to several teeth of the gear.
- Install the secondary driven output shaft assembly.
- Rotate the secondary driven bevel gear several revolutions in both directions.
- Examine the tooth contact pattern in the dye and compare the pattern to the illustrations.

3

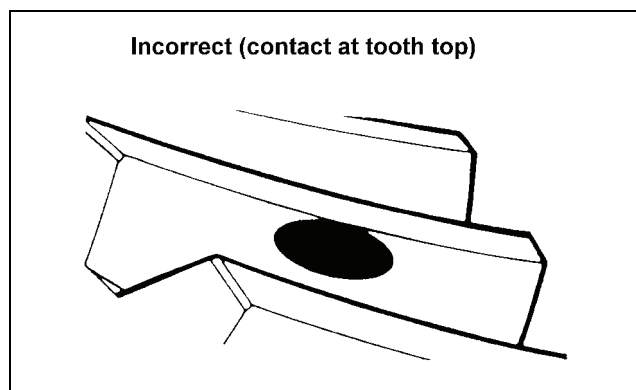

ATV-0103

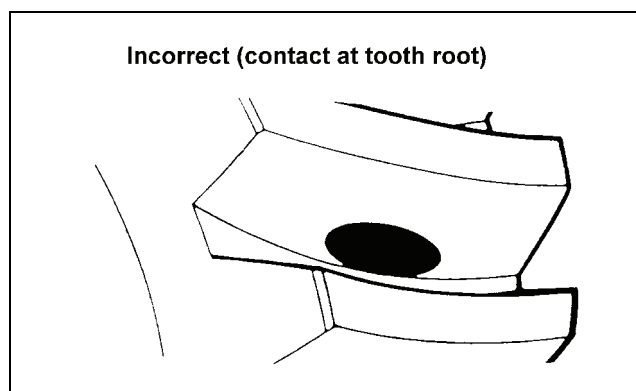

ATV-0105

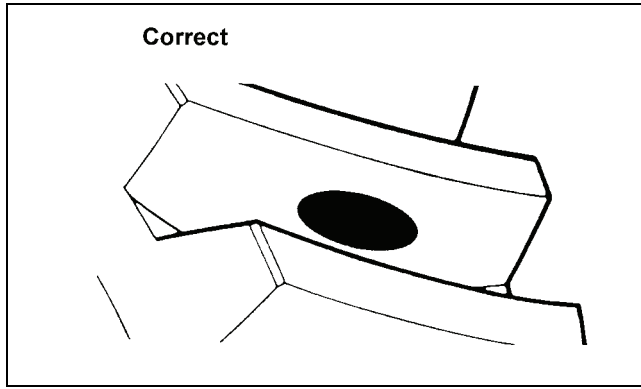

ATV-0104

Correcting Tooth Contact

■NOTE: If tooth contact pattern is comparable to the correct pattern illustration, no correction is necessary.

If tooth contact pattern is comparable to an incorrect pattern, correct tooth contact according to the following chart.

Tooth Contact	Shim Correction
Contacts at Top	Decrease Shim Thickness
Contacts at Root	Increase Shim Thickness

■NOTE: To correct tooth contact, steps 1 and 2 (with NOTE) of “Correcting Backlash” must be followed and the above “Tooth Contact/Shim Correction” chart must be consulted.

 CAUTION
<p>After correcting tooth contact, backlash must again be checked and corrected (if necessary). Continue the correcting backlash/correcting tooth contact procedures until they are both within tolerance values.</p>

CRANKSHAFT ASSEMBLY

Measuring Connecting Rod (Small End Inside Diameter)

1. Insert a snap gauge into the upper connecting rod small end bore; then remove the gauge and measure it with micrometer.

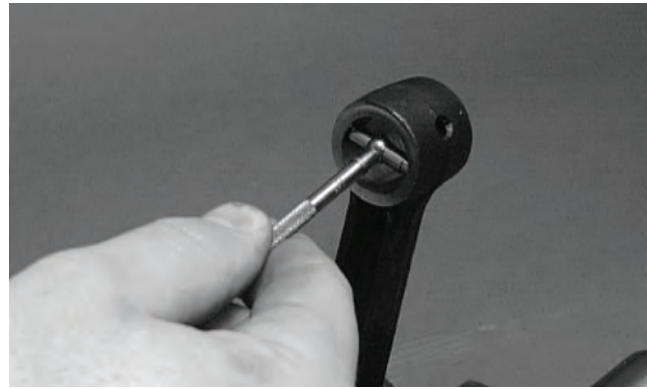

CC290D

2. Maximum diameter must not exceed specifications.

Measuring Connecting Rod (Small End Deflection)

1. Place the crankshaft on a set of V-blocks and mount a dial indicator and base on the surface plate. Position the indicator contact point against the center of the connecting rod small end journal.
2. Zero the indicator and push the small end of the connecting rod away from the dial indicator.
3. Maximum deflection must not exceed specifications.

Measuring Connecting Rod (Big End Side-to-Side)

1. Push the lower end of the connecting rod to one side of the crankshaft journal.
2. Using a feeler gauge, measure the gap between the connecting rod and crankshaft journal.



CC289D

3. Acceptable gap range must be within specifications.

Measuring Connecting Rod (Big End Width)

1. Using a calipers, measure the width of the connecting rod at the big-end bearing.
2. Acceptable width range must be within specifications.

Measuring Crankshaft (Runout)

1. Place the crankshaft on a set of V blocks.
2. Mount a dial indicator and base on the surface plate. Position the indicator contact at point 1 of the crankshaft.

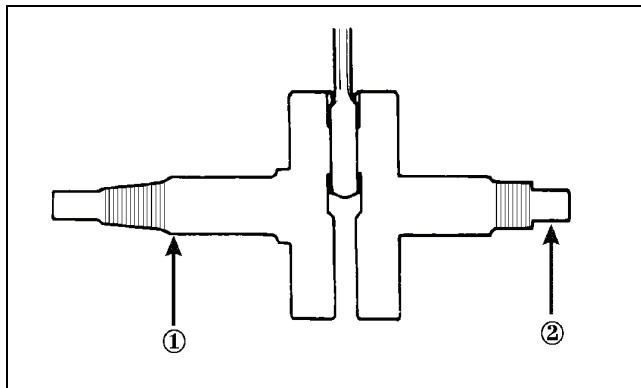

ATV-1074

3. Zero the indicator and rotate the crankshaft slowly.

CAUTION

Care should be taken to support the connecting rod when rotating the crankshaft.

4. Maximum runout must not exceed specifications.

■NOTE: Proceed to check runout on the other end of the crankshaft by positioning the indicator contact at point 2 and following steps 3-4.

Measuring Crankshaft (Web-to-Web)

1. Using a calipers, measure the distance from the outside edge of one web to the outside edge of the other web.

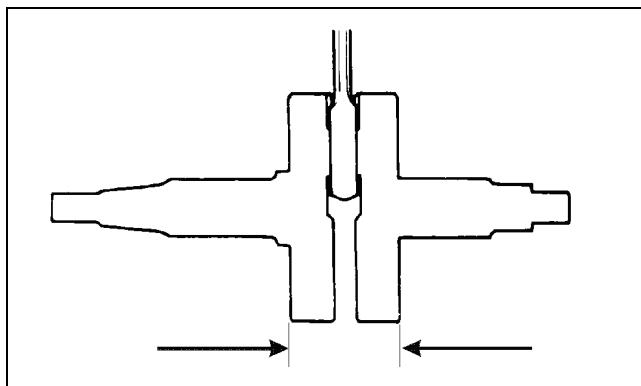

ATV-1017

2. Acceptable width range must be within specifications.

COUNTERSHAFT

CAUTION

When disassembling the countershaft, care must be taken to note the direction each major component (dog, gear) faces. If a major component is installed facing the wrong direction, transmission damage may occur and/or the transmission will malfunction. In either case, complete disassembly and assembly will be required.

Disassembling

1. Remove the reverse driven gear dog; then remove the circlip securing the reverse driven gear.
2. Remove the reverse driven gear and account for the washer, bushing, and bearing.
3. Remove the low driven gear washer; then remove the low driven gear. Account for the bushing and bearing.
4. Remove the washer; then remove the circlip securing the sliding dog. Remove the sliding dog.
5. Remove the high driven gear circlip; then remove the high driven gear. Account for the washer, bushing, and bearing.

3

Assembling

1. Place the high driven gear onto the countershaft making sure the bearing, bushing, and washer are properly positioned. Secure with the circlip.
2. Place the sliding dog onto the countershaft; then secure with the circlip. Place the washer next to the circlip.
3. Place the low driven gear onto the countershaft making sure the bearing and bushing are properly positioned; then place the washer onto the shaft.
4. Place the reverse driven gear onto the countershaft making sure the bearing, bushing, and washer are properly positioned; then secure with the circlip.
5. Place the reverse driven gear dog onto the countershaft.

■NOTE: The countershaft is now completely assembled for installation.

Assembling Crankcase Half

■NOTE: For ease of assembly, install components on the right-side crankcase half.

■NOTE: If the output shaft was removed, make sure that the proper shim is installed.

1. Install the output shaft into the crankcase making sure the two gears, shim, washer, and nut are in the correct order.

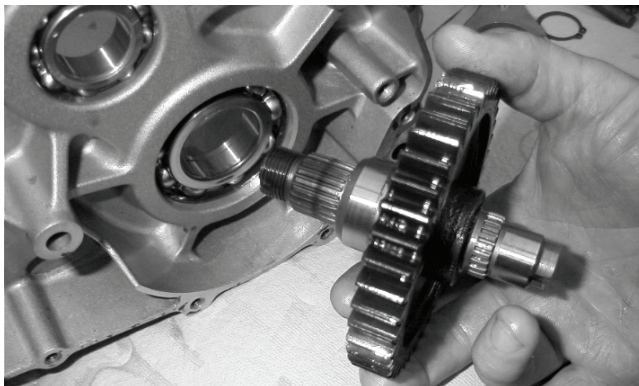
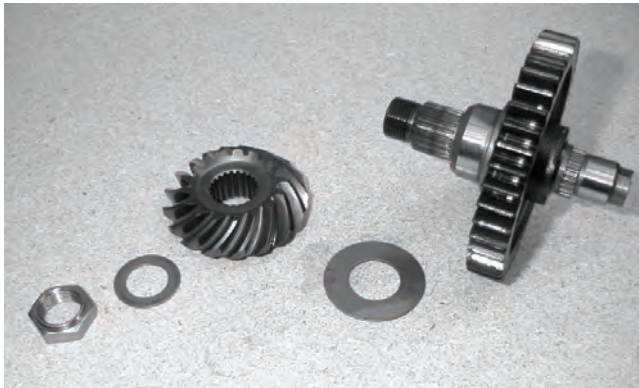

2. Apply red Loctite #271 to the threads of the output shaft. Install and tighten the nut 59 ft-lb. Using a punch, peen the nut.



3. Apply a liberal amount of oil to the crankshaft bearing. Using a propane torch, heat the bearing until the oil begins to smoke; then slide the crankshaft assembly into place.



■NOTE: If heating the bearing is not possible, the crankshaft can be installed using a crankshaft installer.

4. Rotate the crankshaft so the counterweight is toward the rear of the engine. Install the counterbalance shaft.

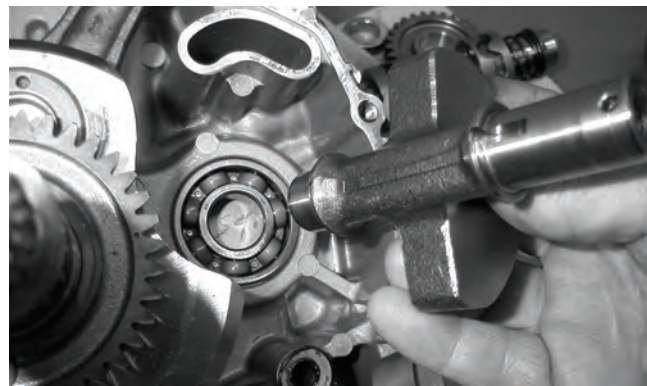

5. Keeping the counterbalance gear timing mark aligned with the one on the crankshaft gear, install the key and the counterbalance gear.

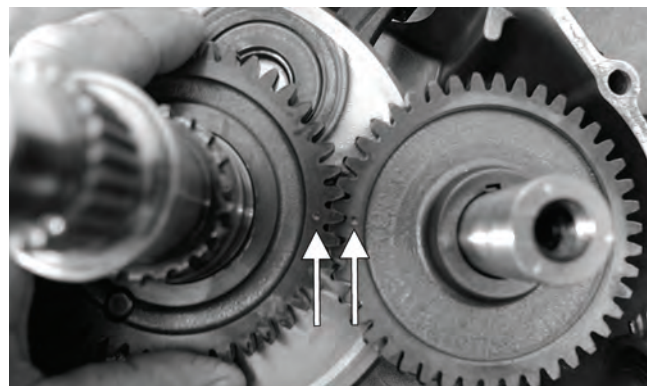

6. Keeping the slot directed as shown, install the shift cam and inner and outer washers.

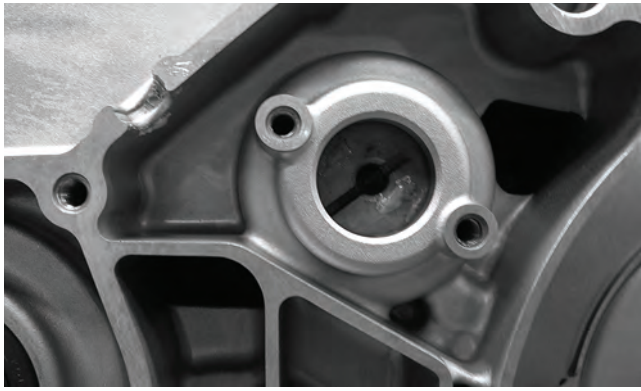

KC325

7. Align the inner shift fork with the gear cluster and with the inner washer in place, install the gear cluster and inner shift fork. While holding the gear cluster in place, install the washer, gear, and snap ring.

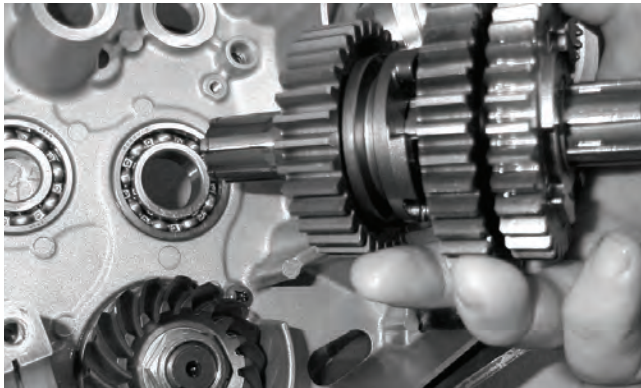

MD1032

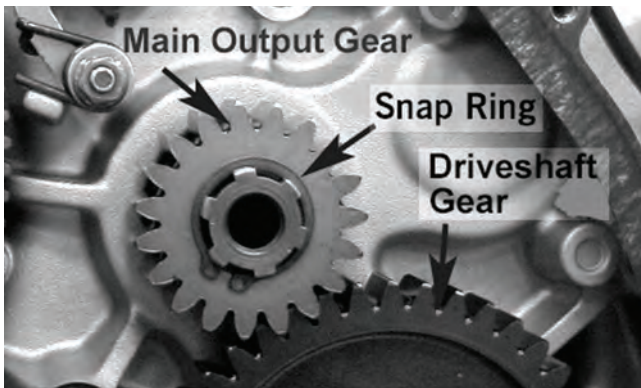

MD1198

8. Install the outer shift fork and the shift fork shaft.



MD1327

9. Install the input driveshaft.

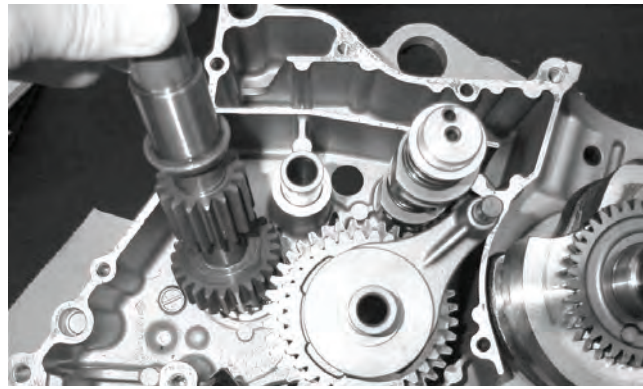

MD1326

10. Install the washer, spacer, sleeve, and reverse idler gear.

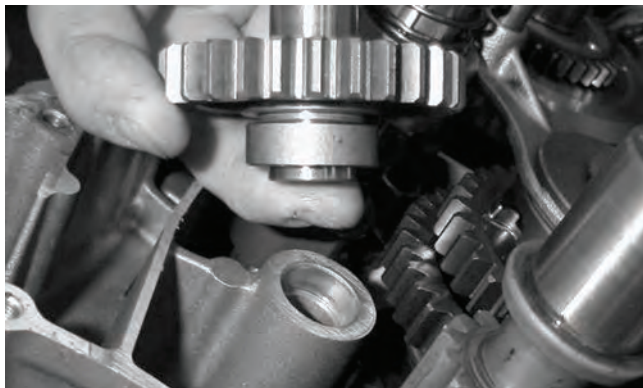

MD1357

11. Install the secondary and primary driveshaft assemblies. Account for the bearing alignment C-ring on the bearing boss next to the pinion gear.

■NOTE: Align the bearing alignment pin on the secondary output shaft.

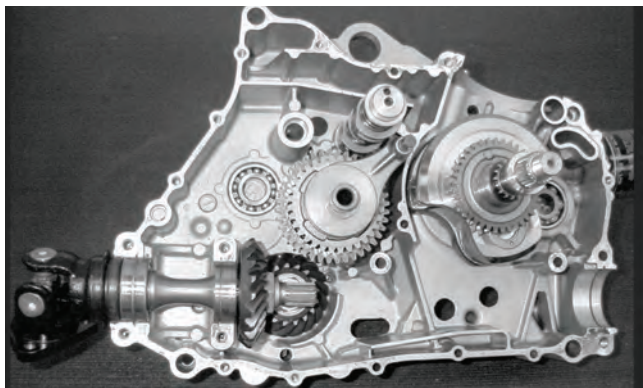

MD1316

3

Joining Crankcase Halves

1. Verify that the two alignment pins are in place and that both case halves are clean and grease free. Apply Three Bond Sealant to the mating surfaces. Place the right-side half onto the left-side half.



MD1336

2. Using a plastic mallet, lightly tap the case halves together until cap screws can be installed.
3. From the right side, install the crankcase cap screws noting the location of the different-sized cap screws; then tighten only until snug.

■NOTE: Rotate the shafts back and forth to ensure no binding or sticking occurs while tightening the cap screws.



MD1008

4. From the left side, install the remaining crankcase cap screws; then tighten only until snug.

■NOTE: Rotate the shafts back and forth to ensure no binding or sticking occurs while tightening the cap screws.

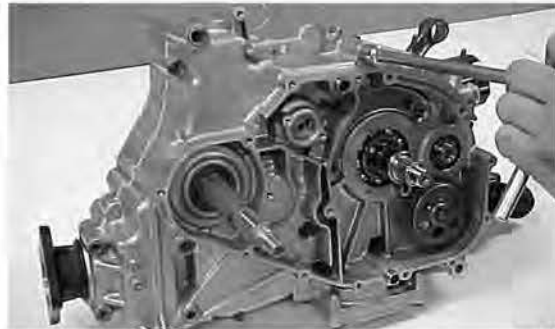

CC871

5. In a crisscross/case-to-case pattern, tighten the 8 mm cap screws until the halves are correctly joined; then tighten to 21 ft-lb.

■NOTE: Rotate the shafts back and forth to ensure no binding or sticking occurs.

6. In a crisscross/case-to-case pattern, tighten the 6 mm cap screws to 10 ft-lb.

■NOTE: Rotate the shafts back and forth to ensure no binding or sticking occurs.

AT THIS POINT

After completing center crankcase components, proceed to Installing Right-Side Components, to Installing Left-Side Components, and to Installing Top-Side Components.

Installing Engine/Transmission

1. From the right side, place the engine/transmission into the frame tilting the top-side forward to clear the frame member.
2. Install the front and rear engine mounting through-bolts and secure with the flange nuts. Tighten to 40 ft-lb.

- Align the front and rear output flanges with the drive couplers; then secure with the screws and tighten to 20 ft-lb.



KC242



KC243

- Install the front and rear V-belt cooling boots and secure with the existing hardware.



KC235



KC236

- Connect the stator coil, trigger coil, and gear shift position switch connectors; then attach the engine ground cable and starter cable and secure with cap screws and nuts. Tighten to 8 ft-lb.

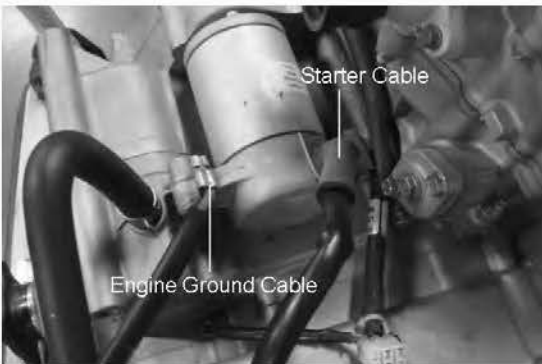
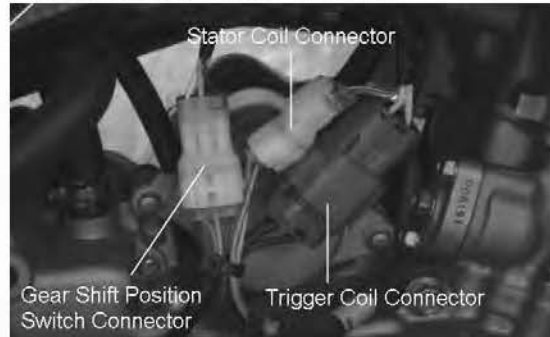

- Set the inlet air silencer into the frame; then install the exhaust pipe using a new exhaust pipe seal and grafoil seal. Tighten the cap screws evenly to 20 ft-lb and install the muffler retainer springs.



KC237

3



9. Install the shift rod onto the shift arm with bushing and flat washer and secure with an E-clip; then connect the speedometer sensor plug.



KC170

7. Place the carburetor into the intake pipe being careful to align the lug on the carburetor with the alignment tabs on the air intake pipe; then tighten the clamp securely.



KC255



KC245A

8. Install the air filter housing onto the frame; then connect the inlet air duct, air silencer duct, and intake housing to Throttle Body and tighten all hose clamps securely.



10. Connect the Water Temperature Sensor connector, then connect the TPS connector.

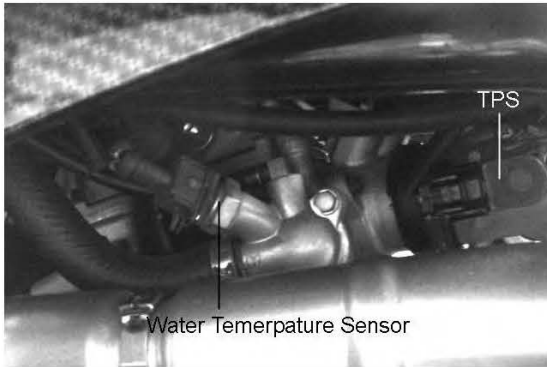

11. If the brake pedal was removed during disassembling, apply grease to the brake pedal pivot stud; then install the brake pedal and secure with a flat washer and cap screw. Tighten to 20 ft-lb.



KC232A



KC149A

3

12. Install the heat shield; then install the gas tank (see Section 4).
13. Install the front body panel, front rack, and footwells (see Section 8).
14. Pour the appropriate quantity and grade oil into the crankcase; then connect the negative battery cable and move the ATV outside to a well ventilated area.
15. Start the engine and allow the engine to warm up while checking for oil leaks; then shut the engine off and check the oil level. Add oil as required.

OIL FILTER / OIL PUMP

- * Whenever internal engine components wear excessively or break and whenever oil is contaminated, the oil pump should be replaced. The oil pump is not a serviceable component.

TESTING OIL PUMP PRESSURE

- * The engine must be warmed up to the specified temperature for this test.
1. Connect the tachometer to the engine.
 2. Connect the oil pressure test kit to the oil filter drain plug.

- * Some oil seepage may occur when installing the oil pressure gauge. Wipe up oil residue with a cloth.

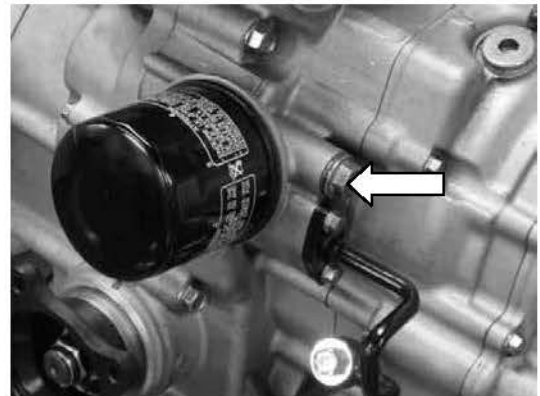

3. Start the engine and run at 3000 RPM. The oil pressure gauge must read as specified.

Standard: 1.1-1.5 kg/cm² (16-21 psi)

Oil Temperature – 60 °C (140 °F)

- * If the oil pressure is lower than specified, check for low oil level, defective oil pump.

- * If the oil pressure is higher than specified, check for too heavy engine oil weight, clogged oil passage, clogged oil filter, or improper installation of the oil filter.

SECTION 5 - ELECTRICAL SYSTEM

TABLE OF CONTENTS

Electrical System.....	5-2
Specifications	5-2
Battery	5-2
Testing Electrical Components.....	5-2
Accessory Receptacle/Connector.....	5-2
Brakelight Switch (Pressure).....	5-3
Thermostatic Switch.....	5-3
Fan Motor	5-4
Fuse Block/Power Distribution Module.....	5-4
Fuses	5-5
Ignition Coil	5-5
Speed Sensor	5-6
Ignition Switch	5-6
Handlebar Control Switches.....	5-7
Front Drive Selector Switch.....	5-7
Front Drive Selector Actuator	5-8
Gear Shift Position Switch.....	5-8
Stator Coil	5-9
Starter Relay	5-9
Starter Motor	5-10
ECU.....	5-10
Regulator/Rectifier.....	5-11
Neutral Start/Front Drive Actuator/Start-in-Gear/ 2WD Relays	5-11
Headlights	5-11
Taillights - Brakelights.....	5-11
Running Lights	5-12
Back-Up Lights	5-12
Troubleshooting	5-13

Electrical System

This section has been organized into sub-sections which show procedures for the complete servicing of the KYMCO ATV electrical system.

■ **NOTE:** Some photographs and illustrations used in this section are used for clarity purposes only and are not designed to depict actual conditions.

General Instructions

The ignition control module or ECU maybe damaged if dropped or the connector is disconnected when the key is ON, the excessive voltage may damage the ignition control module or ECU. Always turn off the ignition switch before servicing.

A faulty ignition system is often related to poor connections. Check those connections before proceeding.

Some electrical components may be damaged if terminals or connectors are connected or disconnected while the ignition switch is ON and current is present.

Specifications

Spark Plug Type	NGK CR7E
Spark Plug Gap	0.7-0.8 mm (0.028-0.032 in.)
Spark Plug Cap	4000-6000 ohms
Ignition Coil Resistance (primary)	Less than 1 ohm (terminal to terminal)
(secondary)	2900-3400 ohms (high tension - plug cap removed - to ground)
Ignition Coil Peak Voltage (primary/CDI)	250-375 DC volts (black/yellow to black)
Stator Coil Resistance (trigger charging)	90-110 ohms (green/white to blue/yellow) Less than 1 ohm (yellow to yellow)
Peak Voltage (trigger)	7.8-9.3 volts (green to blue)
AC Generator Output (no load)	60 AC volts @ 3000 RPM (black to black)
Generator Output (approx)	220W @ 5000 RPM

Battery

For battery related information, see Section 2.

Testing Electrical Components

All of the electrical tests should be made using the Fluke Model 73 Multimeter and when testing peak voltage, the Peak Voltage Reading Adapter must be used. If any other type of meter is used, readings may vary due to internal circuitry. When troubleshooting a specific component, always verify first that the fuse(s) are good, that the bulb(s) are good, that the connections are clean and tight, that the battery is fully charged, and that all appropriate switches are activated.

■ **NOTE:** For absolute accuracy, all tests should be made at room temperature of 68° F.

Accessory Receptacle/Connector

■ **NOTE:** This test procedure is for either the receptacle or the connector.

VOLTAGE

1. Turn the ignition switch to the ON position; then set the meter selector to the DC Voltage position.
2. Connect the red tester lead to the red wire; then connect the black tester lead to ground.
3. The meter must show battery voltage.

■ **NOTE:** If the meter shows no battery voltage, troubleshoot the battery, fuse, receptacle, connector, or the main wiring harness.

Brakelight Switch (Pressure)

The brakelight switch is located on the top of the auxiliary brake master cylinder and is pressure activated by the hand brake or the auxiliary brake pedal. This switch also activates the start-in-gear (SIG) relay in the power distribution module (PDM).

■NOTE: The ignition switch must be in the ON position.

VOLTAGE (Wiring Harness Side)

1. Set the meter selector to the DC Voltage position.
2. Connect the red tester to the brown/black wire; then connect the black tester lead to ground.
3. The meter must show battery voltage.

■NOTE: If the meter shows no battery voltage, troubleshoot the battery, fuse, switch, or the main wiring harness.

■NOTE: If the meter shows battery voltage, the main wiring harness is good; proceed to test the switch/component or connector.

RESISTANCE (Switch)

CAUTION

Always disconnect the battery when performing resistance tests to avoid damaging the multimeter.

1. Remove the spade connectors from the brake switch.
2. Set the meter selector to the OHMS position.
3. Connect the red tester lead to one switch terminal; then connect the black tester lead to the other switch terminal.

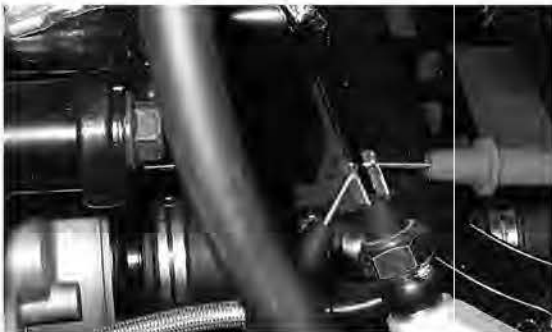

KC274

4. When the brake pedal is depressed, the meter must show less than 1 ohm.

■NOTE: If the meter shows more than 1 ohm of resistance, replace the switch.

THERMOSTATIC SWITCH

1. Connect the meter leads (selector in the OHMS position) to the switch contacts.
2. Suspend the switch and a thermometer in a container of cooking oil; then heat the oil.

■NOTE: Neither the switch nor the thermometer should be allowed to touch the bottom of the container or inaccurate readings will occur. Use wire holders to suspend switch and thermometer.

WARNING

Wear insulated gloves and safety glasses. Heated oil can cause severe burns.

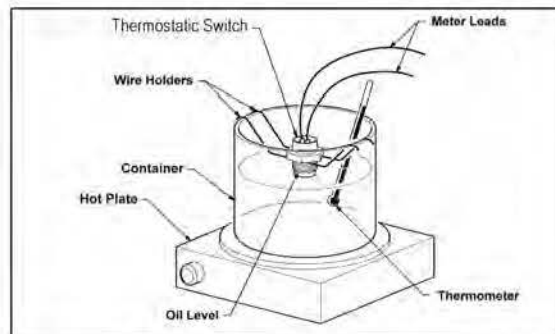

733-554C

3. When the coolant temperature is lower than 85 °C, the thermostatic switch OFF.
When coolant temperature is over 90 °C, the thermostatic switch ON.



5

Fan Motor

The connector is the black wire and the other is red, located behind the fan assembly.

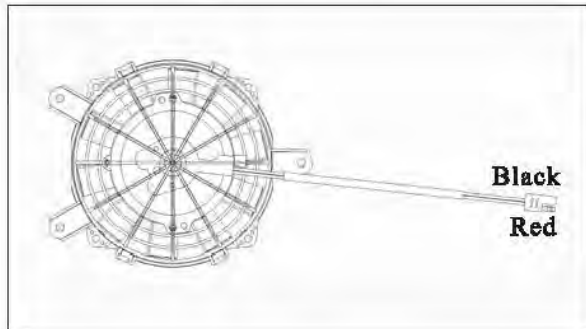

■NOTE: The ignition switch must be in the ON position.

VOLTAGE (Main Harness Connector to Fan Motor)

1. Set the meter selector to the DC Voltage position.
2. Connect the red tester lead to the orange wire; then connect the black tester lead to ground.
3. The meter must show battery voltage.

■NOTE: If the meter shows no battery voltage, troubleshoot the battery, fuse, motor, or the main wiring harness.

■NOTE: If the meter shows battery voltage, the main wiring harness is good. The connector should be checked for resistance.

RESISTANCE (Fan Motor Connector)

⚠ CAUTION

Always disconnect the battery when performing resistance tests to avoid damaging the multimeter.

1. Set the meter selector to the OHMS position.
2. Connect the red tester lead to the blue wire; then connect the black tester lead to the black wire.
3. The meter must show less than 1 ohm.

■NOTE: If the meter shows more than 1 ohm of resistance, troubleshoot or replace the switch/component, the connector, or the switch wiring harness.

■NOTE: To determine if the fan motor is good, connect the blue wire from the fan connector to the positive side of a 12 volt DC power supply; then connect the black wire from the fan connector to the negative side. The fan should operate.

⚠ CAUTION

Care should be taken to keep clear of the fan blades.

Fuse Block/Power Distribution Module

The fuses are located in a power distribution module (PDM) in front of the steering tube.

If there is any type of electrical system failure, always check the fuses first.

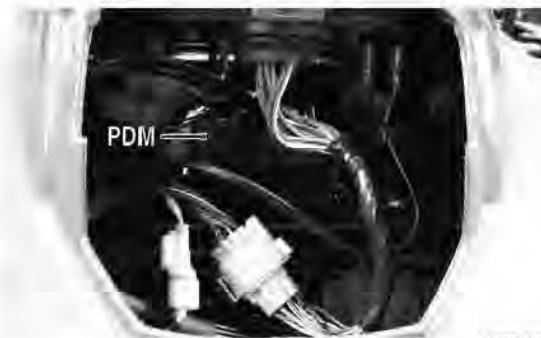

KC210A

■NOTE: The ignition switch must be in the LIGHTS position.

1. Remove all fuses from the distribution module.
2. Set the meter selector to the DC Voltage position.
3. Connect the black tester lead to ground.
4. Using the red tester lead, contact each end of the fuse holder connector terminals individually.
5. The meter must show battery voltage from one side of the connector terminal ends.

■NOTE: Battery voltage will be indicated from only one side of the fuse holder connector terminal; the other side will show no voltage.

■NOTE: When testing the HI fuse holder, the headlight dimmer switch must be in the HI position; when testing the LIGHTS fuse holder, the headlight dimmer switch can be in either position.

■NOTE: If the meter shows no battery voltage, troubleshoot the battery, switches, distribution module, or the main wiring harness.

Fuses

⚠ CAUTION

Always disconnect the battery when performing resistance tests to avoid damaging the multimeter.

1. Set the meter selector to the OHMS position.
2. Connect the red tester lead to one spade end of the fuse; then connect the black tester lead to the other spade end.
3. The meter must show less than 1 ohm resistance. If the meter reads open, replace the fuse.

■NOTE: Make sure the fuses are returned to their proper position according to amperage. Refer to the fuse block cover for fuse placement.

Ignition Coil

The ignition coil is on the frame above the engine. To access the coil, the left side panel must be removed.

RESISTANCE

⚠ CAUTION

Always disconnect the battery when performing resistance tests to avoid damaging the multimeter.

■NOTE: For these tests, the meter selector should be set to the OHMS position and the primary wire(s) should be disconnected.

Primary Winding

1. Connect the red tester lead to either terminal; then connect the black tester lead to the other terminal.
2. The meter reading must be within specification.

Secondary Winding

1. Remove the plug cap from the high tension lead; then connect the red tester lead to the high tension lead.

2. Connect the black tester lead to ground.
3. The meter reading must be within specification.

■NOTE: If the meter does not show as specified, replace ignition coil.

Spark Plug Cap

1. Connect the red tester lead to one end of the cap; then connect the black tester lead to the other end of the cap.



AR603D

2. The meter reading must be within specification.

■NOTE: If the meter does not read as specified, replace the spark plug cap.

PEAK VOLTAGE

■NOTE: All of the peak voltage tests should be made using the Fluke Model 73 Multimeter with Peak Voltage Reading Adapter. If any other type of tester is used, readings may vary due to internal circuitry.

■NOTE: The battery must be at full charge for these tests.

Speed Sensor

1. Set the meter selector to the DC Voltage position.
2. With appropriate needle adapters on the meter leads, connect the red tester lead to the voltage lead (V); then connect the black tester lead to the ground lead (G).



KC248A

3. Turn the ignition switch to the ON position.
4. The meter must show 12.0 volts.
5. Leave the black tester lead connected; then connect the red tester lead to the signal lead pin (S).
6. Slowly move the ATV forward or backward; the meter must show 0 and 6 volts alternately.

■ **NOTE:** If the sensor tests are within specifications, the speedometer must be replaced (see Section 9).

To replace a speed sensor, use the following procedure.

1. Disconnect the three-wire connector from the speed sensor; then remove the cap screw securing the sensor to the sensor housing.
2. Remove the sensor from the sensor housing accounting for an O-ring.

3. Install the new speed sensor into the housing with new O-ring lightly coated with multi-purpose grease; then secure the sensor with the cap screw (threads coated with blue Loctite #242). Tighten securely.



CD071

Ignition Switch

The ignition switch harness connects to the switch with a three-pin connector. To access the connector, remove the access panel in front of the handlebar.



VOLTAGE

■ **NOTE:** Perform this test on the main harness connector.

1. Set the meter selector to the DC Voltage position.
2. Connect the red meter lead to the red/white wire; then connect the black meter lead to ground.
3. Meter must show battery voltage.

■ **NOTE:** If the meter shows no battery voltage, troubleshoot the battery or the main wiring harness.

RESISTANCE

CAUTION

Always disconnect the battery when performing resistance tests to avoid damaging the multimeter.

■NOTE: Perform this test on the switch harness using the following procedure.

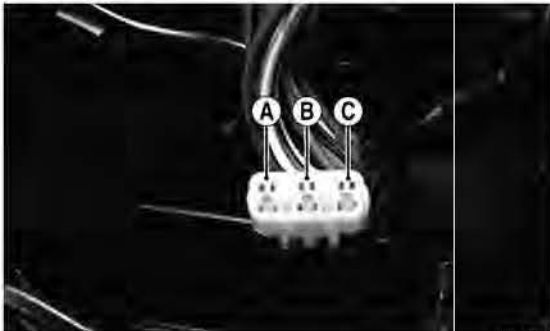

KC276A

1. Turn the ignition switch to the ON position.
2. Set the meter selector to the OHMS position.
3. Connect either tester lead to pin B; then connect the other tester lead to pin A.
4. The meter must show less than 1 ohm.
5. Turn the ignition switch to the LIGHTS position. The meter must show less than 1 ohm.
6. Leaving the tester lead on pin B, connect the other tester lead to pin C.
7. The meter must show less than 1 ohm.

■NOTE: If the meter shows more than 1 ohm of resistance, replace the switch.

Handlebar Control Switches

The connectors are located on the right side of the ATV next to the PDM. To access the connector, the electrical cover must be removed.

■NOTE: These tests should be made on the switch side of the connector.

CAUTION

Always disconnect the battery when performing resistance tests to avoid damaging the multimeter.

RESISTANCE (HI Beam)

1. Set the meter selector to the OHMS position.
2. Connect one tester lead to the brown/black wire; then connect the other tester lead to the lavender wire.
3. With the dimmer switch in the HI position, the meter must show less than 1 ohm.

■NOTE: If the meter shows more than 1 ohm of resistance, replace the switch.

RESISTANCE (LO Beam)

1. Connect one tester lead to the brown/black wire; then connect the other tester lead to the white wire.
2. With the dimmer switch in the LO position, the meter must show an open circuit.

■NOTE: If the meter reads resistance, replace the switch.

RESISTANCE (Emergency Stop)

1. Set the meter selector to the OHMS position.
2. Connect the one lead to the red/white wire; then connect the other tester lead to the yellow/black wire.
3. With the switch in the OFF position, the meter must show an open circuit.
4. With the switch in the RUN position, the meter must show less than 1 ohm.

■NOTE: If the meter shows more than 1 ohm of resistance, replace the switch.

RESISTANCE (Reverse Override)

1. Set the meter selector to the OHMS position.
2. Connect one tester lead to one lavender/red wire; then connect the other tester wire to the green/red wire. The meter must show less than 1 ohm.
3. Depress and hold the reverse override button. The meter must show an open circuit.

■NOTE: If the meter does not show as specified, replace the switch.

Front Drive Selector Switch

The connector is the snap-lock one in front of the steering post. To access the connector, the electric cover must be removed.

■NOTE: Resistance tests should be made with the connector disconnected and on the selector-side of the connector.

RESISTANCE

⚠ CAUTION

Always disconnect the battery when performing resistance tests to avoid damaging the multimeter.

1. Set the meter selector to the OHMS position.
2. Connect the one tester lead to the brown/lavender wire; then connect the other tester lead to the white/lavender wire.
3. With the selector switch in the 2WD position, the meter must show less than 1 ohm.
4. With the selector switch in the 4WD position, the meter must show an open circuit.

■NOTE: If the meter does not show as specified, replace the front drive selector switch.

VOLTAGE

■NOTE: The battery must be connected when performing voltage tests.

1. Set the meter selector to the DC Voltage position.
2. Connect the black tester lead to the negative battery terminal.
3. Connect the red tester lead to the brown/lavender wire on the harness side of the connector.
4. Turn the ignition switch to the RUN position.
5. The meter must show battery voltage.

■NOTE: If the meter shows other than specified, check the harness, connector, 30 amp fuse, and battery connections.

Front Drive Selector Actuator

■NOTE: With the engine stopped and the ignition switch in the ON position, a momentary “whirring” sound must be noticeable each time the selector switch is moved to 2WD and 4WD. Test the switch, 30 amp fuse, and wiring connections prior to testing the actuator.

■NOTE: The differential must be in the unlocked position for this procedure.

VOLTAGE

1. Select the 2WD position on the front drive selector switch; then disconnect the connector on the actuator wiring harness.
2. With the ignition switch in the OFF position, connect the black tester lead to the black wire in the supply harness; then connect the red tester lead to the brown/lavender wire in the supply harness.
3. Turn the ignition switch to the ON position. The meter must show 12 DC volts.
4. Connect the red tester lead to the white/blue wire in the supply harness. The meter must show 12 DC volts.
5. Select the 4WD position on the front drive selector switch; then connect the red tester lead to the white/blue wire in the supply harness. The meter must show 0 DC volts.

■NOTE: The 4WD icon on the LCD should illuminate.

6. Connect the red tester lead to the brown/lavender wire in the supply harness. The meter must show 12 DC volts.

■NOTE: If the voltage readings are as specified and the actuator does not function correctly, replace the actuator (see Section 6).

Gear Shift Position Switch

The gear shift position switch connector is located on the right side of the engine over the V-belt housing.

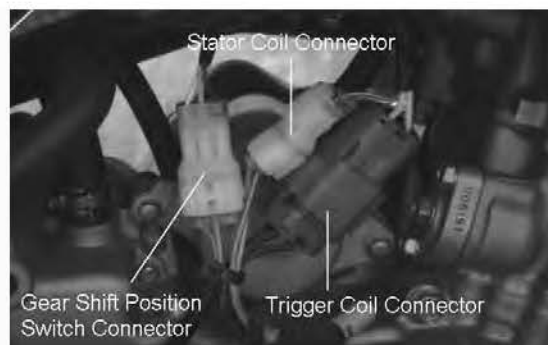

To troubleshoot the switch, use the following procedure.

1. Disconnect the gear shift position switch from the main harness at the connector; then connect the black tester lead to a suitable ground.

2. Select the OHMS position on the tester and connect the red tester lead to the lavender/red wire; then move the gear shift lever to the R (reverse) position. The meter must read less than 1 ohm.
3. Move the red tester lead and shift lever in turn to the light green/red wire and N (neutral) position, white/black wire and H (high) position, and white/red wire and L (low) position. The meter must read less than 1 ohm in all positions. If not, the gear shift linkage must be adjusted (see Section 2) or the switch must be replaced.

Stator Coil

VOLTAGE (AC Generator - Regulated Output)

1. Set the meter selector to the DC Voltage position.
2. Connect the red tester lead to the positive battery post; then connect the black tester lead to the negative battery post.
3. With the engine running at a constant 3000 RPM (with the headlights on), the meter must show 14-15.5 DC volts.

CAUTION

Do not run the engine at high RPM for more than 10 seconds.

■ **NOTE:** If voltage is lower than specified, test charging coil - no load.

VOLTAGE (Charging Coil - No Load)

The connector is the yellow three-pin one on the right side of the engine just above the starter motor.

■ **NOTE:** Test the engine-side of the connector.

1. Set the meter selector to the AC Voltage position.
2. Test between the three yellow wires for a total of three tests.
3. With the engine running at the specified RPM, all wire tests must show 60 AC volts.

CAUTION

Do not run the engine at high RPM for more than 10 seconds.

■ **NOTE:** If both charging coil tests failed, check all connections, etc., and test again. If no voltage is present, replace the stator assembly.

RESISTANCE (Charging Coil)

CAUTION

Always disconnect the battery when performing resistance tests to avoid damaging the multimeter.

1. Set the meter selector to OHMS position.
2. Test between the three yellow wires for a total of three tests.
3. The meter reading must be within specification.

RESISTANCE (Trigger Coil)

CAUTION

Always disconnect the battery when performing resistance tests to avoid damaging the multimeter.

1. Disconnect the gray four-pin connector on the right side of the engine just above the starter motor.
2. Set the meter selector to the OHMS position.
3. Connect the red tester lead to the green/white wire; then connect the black tester lead to the blue/yellow wire. The meter reading must be within specification.

PEAK VOLTAGE

■ **NOTE:** All of the peak voltage tests should be made using the Fluke Model 73 Multimeter with Peak Voltage Reading Adapter. If any other type of tester is used, readings may vary due to internal circuitry.

■ **NOTE:** The battery must be at full charge for these tests.

Trigger Coil

1. Set the meter selector to the DC Voltage position.
2. Connect the red tester lead to the green/white wire; then connect the black tester lead to the blue/yellow wire.
3. Crank the engine over using the electric starter.
4. The meter reading must be within specification.

Starter Relay

1. Remove the seat; then using the multimeter set to the DC Voltage position, check the relay as follows.
2. Connect the red tester lead to the positive battery terminal; then connect the black tester lead to the starter cable connection on the starter relay. The meter must show battery voltage.

■NOTE: Make sure that the ignition switch is in the ON position, transmission in neutral, brake lock released, and the emergency stop switch in the RUN position.

3. Depress the starter button while observing the multimeter. The multimeter should drop to 0 volts, a “click” should be heard from the relay, and the starter motor should run.

■NOTE: If a “click” is heard and any voltage is indicated by the multimeter, replace the starter relay. If no “click” is heard and the multimeter continues to indicate battery voltage, test the neutral start relay.

Starter Motor

■NOTE: The starter is a non-serviceable component. If the following test does not result as specified, the starter must be replaced.

TESTING VOLTAGE

Perform this test on the starter motor positive terminal. To access the terminal, slide the boot away.

■NOTE: The ignition switch must be in the ON position, the emergency stop switch in the RUN position, and the shift lever in the NEUTRAL position.

1. Set the meter selector to the DC Voltage position.
2. Connect the red tester lead to the starter terminal; then connect the black tester lead to ground.
3. With the starter button depressed, the meter must show approximately 12.0 DC volts and the starter motor should operate.



■NOTE: If the meter showed correct voltage but the starter did not operate or operated slowly, the starter motor is defective.

■NOTE: If the meter showed no voltage, inspect ground connections, starter motor lead, battery voltage (at the battery), starter relay, or the neutral start relay.

REMOVING

1. Disconnect the battery.

⚠ CAUTION

Always disconnect the negative battery cable from the battery first; then disconnect the positive cable.

2. Remove the nut securing the positive cable to the starter; then remove the cable from the starter.
3. Remove the two cap screws securing the starter to the crankcase; then remove the starter. Account for an O-ring.

INSTALLING

1. Apply a small amount of grease to the O-ring seal on the starter; then install the starter into the crankcase. Secure with two cap screws making sure the engine ground is secured by the rear cap screws. Tighten to 8 ft-lb.

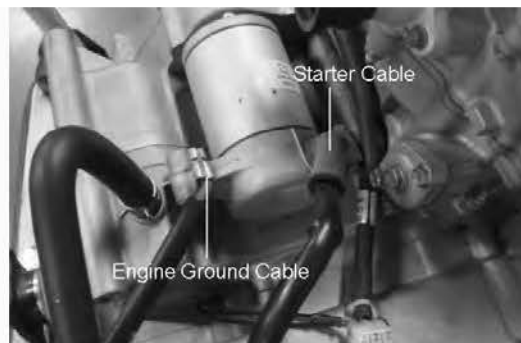

2. Secure the positive cable to the starter with the nut. Tighten to 8 ft-lb.
3. Connect the battery.

Regulator/Rectifier

The regulator/rectifier is located under the front rack and front fenders above the oil cooler.

TESTING

1. Start engine and warm up to normal operating temperatures; then connect a multimeter to the battery as follows.
2. Select the DC Voltage position; then connect the red tester lead to the positive battery post and the black tester lead to the negative battery post.
3. Start the engine and slowly increase RPM. The voltage should increase with the engine RPM to a maximum of 15.5 DC volts.

■NOTE: If voltage rises above 15.5 DC volts, the regulator is faulty or a battery connection is loose or corroded. Clean and tighten battery connections or replace the regulator/rectifier. If voltage does not rise, check Voltage (Charging Coil - No Load) in this section. If charging coil voltage is normal, replace the regulator/rectifier.

Neutral Start/ Front Drive Actuator/ Start-in-Gear/ 2WD Relays

The relays are identical plug-in type located on the power distribution module. Relay function can be checked by switching relay positions. The relays are interchangeable.

■NOTE: The module and wiring harness are not a serviceable component and must be replaced as an assembly.

Headlights



VOLTAGE

■NOTE: Perform this test on the main harness side of the connectors. Also, the ignition switch must be in the LIGHTS position.

1. Set the meter selector to the DC Voltage position.
2. Connect the black tester lead to the black wire; then connect the red tester lead to the white wire.
3. With the dimmer switch in the LO position, the meter must show battery voltage.
4. Remove the red tester lead from the white wire and connect to the lavender wire.
5. With the dimmer switch in the HI position, the meter must show battery voltage.

■NOTE: If battery voltage is not shown in any test, inspect the fuses, battery, main wiring harness, connectors, or the left handlebar switch.

Taillights - Brakelights

VOLTAGE (Taillights)

■NOTE: Perform this test on the main harness side of the connector. Also, the ignition switch should be in the LIGHTS position.

5

1. Set the meter selector to the DC Voltage position.
2. Connect the black tester lead to the black wire; then connect the red tester lead to the brown/blue wire.
3. The meter must show battery voltage.

■NOTE: If the meter does not show voltage, inspect fuses, wiring harness, connectors, and switches.

VOLTAGE (Brakelights)

■NOTE: Perform this test on the main harness side of the connector. Also, the ignition switch should be in the ON position and the brake (either foot pedal or hand lever) must be applied.

1. Set the meter selector to the DC Voltage position.
2. Connect the black tester lead to the black wire; then connect the red tester lead to the green/yellow wire.
3. The meter must show battery voltage.

■NOTE: If the meter does not show voltage, inspect bulb, fuses, wiring harness, connectors, and switches.

Running Lights

The two running lights use the same connectors as the headlights (see Headlights in this section).

VOLTAGE

1. Release the wire connector from the frame; then release and separate the connectors.

■NOTE: Perform this test on the wiring harness side of the connectors.

2. Connect the black tester lead of the meter to the black wire; then with the tester in the DC Volts position, connect the red tester lead to the brown/black wire.
3. Turn the ignition switch to the LIGHTS position. The meter must show battery voltage.

■NOTE: If the meter does not show voltage, inspect the LIGHTS fuse, battery connections, or troubleshoot the main wiring harness.

Troubleshooting

Problem: Spark absent or weak	
Condition	Remedy
<ol style="list-style-type: none"> 1. Ignition coil defective 2. Spark plug defective 3. Magneto defective 4. ECU unit defective 5. Pick-up coil defective 	<ol style="list-style-type: none"> 1. Replace ignition coil 2. Replace plug 3. Replace magneto 4. Replace ECU unit 5. Replace pick-up coil
Problem: Spark plug fouled with carbon	
Condition	Remedy
<ol style="list-style-type: none"> 1. Gasoline incorrect 2. Air cleaner element dirty 3. Spark plug incorrect (too cold) 4. Valve seals cracked - missing 5. Oil rings worn - broken 	<ol style="list-style-type: none"> 1. Change to correct gasoline 2. Clean element 3. Replace plug 4. Replace seals 5. Replace rings
Problem: Spark plug electrodes overheat or burn	
Condition	Remedy
<ol style="list-style-type: none"> 1. Spark plug incorrect (too hot) 2. Engine overheats 3. Spark plug loose 	<ol style="list-style-type: none"> 1. Replace plug 2. Service cooling system 3. Tighten plug
Problem: Magneto does not charge	
Condition	Remedy
<ol style="list-style-type: none"> 1. Lead wires/connections shorted - loose - open 2. Magneto coils shorted - grounded - open 3. Regulator/rectifier defective 	<ol style="list-style-type: none"> 1. Repair - replace - tighten lead wires 2. Replace magneto coils 3. Replace regulator/rectifier
Problem: Magneto charges, but charging rate is below the specification	
Condition	Remedy
<ol style="list-style-type: none"> 1. Lead wires shorted - open - loose (at terminals) 2. Stator coils (magneto) grounded - open 3. Regulator/rectifier defective 4. Battery voltage low 5. Cell plates (battery) defective 	<ol style="list-style-type: none"> 1. Repair - tighten lead wires 2. Replace stator coils 3. Replace regulator/rectifier 4. Recharging battery 5. Replace battery

Problem: Magneto overcharges	
Condition	Remedy
<ol style="list-style-type: none"> 1. Internal battery short circuited 2. Regulator/rectifier damaged - defective 3. Regulator/rectifier poorly grounded 	<ol style="list-style-type: none"> 1. Replace battery 2. Replace regulator/rectifier 3. Clean - tighten ground connection
Problem: Charging unstable	
Condition	Remedy
<ol style="list-style-type: none"> 1. Lead wire intermittently shorting 2. Magneto internally shorted 3. Regulator/rectifier defective 	<ol style="list-style-type: none"> 1. Replace lead wire 2. Replace magneto 3. Replace regulator/rectifier
Problem: Starter button not effective	
Condition	Remedy
<ol style="list-style-type: none"> 1. Battery charge low 2. Switch contacts defective 3. Starter motor brushes not seating 4. Starter relay defective 5. Emergency stop - ignition switch off 6. Wiring connections loose - disconnected 	<ol style="list-style-type: none"> 1. Charge - replace battery 2. Replace switch 3. Replace starter motor 4. Replace relay 5. Turn on switches 6. Connect - tighten - repair connections
Problem: Battery "sulfation" (Acidic white powdery substance or spots on surfaces of cell plates)	
Condition	Remedy
<ol style="list-style-type: none"> 1. Charging rate too low - too high 2. Battery run-down - damaged 	<ol style="list-style-type: none"> 1. Replace battery 2. Replace battery
Problem: Battery discharges too rapidly	
Condition	Remedy
<ol style="list-style-type: none"> 1. Charging system not charging 2. Cell plates overcharged - damaged 3. Battery short-circuited 	<ol style="list-style-type: none"> 1. Check magneto - regulator/rectifier - circuit connections 2. Replace battery - correct charging system 3. Replace battery
Problem: Battery polarity reversed	
Condition	Remedy
<ol style="list-style-type: none"> 1. Battery incorrectly connected 	<ol style="list-style-type: none"> 1. Reverse connections - replace battery - repair damage

SECTION 6 - DRIVE SYSTEM

TABLE OF CONTENTS

Drive System 6-2
Front Drive Actuator 6-2
Front Differential 6-3
Drive Axles 6-14
Rear Gear Case 6-18
Hub 6-19
Hydraulic Brake Caliper 6-20
Troubleshooting Drive System 6-22
Troubleshooting Brake System 6-22

Drive System

■ **NOTE:** Some photographs and illustrations used in this section are used for clarity purposes only and are not designed to depict actual conditions.

■ **NOTE:** Critical torque specifications are located in Section 1.

■ **NOTE:** Specifications regarding the gear cases (capacities, lubricant type, etc.) can be found in Section 1 of this manual.

Ring Gear Backlash	0.28-0.38 mm (0.011-0.015 in.)
Ring Gear End Play	0.1-0.2 mm (0.004-0.008 in.)

GENERAL INFORMATION

All gear cases are tagged beneath a cover bolt. This tag is marked with a production date code, sequence code, and a ratio code.

The “1” or “3.1” on the lower-right corner indicates a 3.1:1 gear set ratio (11:34 teeth).

The die-cast aluminum housings have been assembled with thread-rolling screws (trilobular). When assembling with these screws, start the screws carefully into the housing; then use the following torque values.

Size	New Housing	Reassembled Housing
M6 (Torx T-30 Recess)	8-9.5 ft-lb	6.5-9 ft-lb
M8 (Torx T-40 Recess)	25-31 ft-lb	21-25 ft-lb
M10 (Torx T-50 Recess)	37-45.5 ft-lb	31-38 ft-lb

SPECIAL TOOLS

A number of special tools must be available to the technician when performing service procedures in this section.

Description	p/n
CV Boot Clamp Tool	
Internal Hex Socket	
Pinion Gear/Shaft Removal Tool	
Slide Hammer Kit	
Gear Case Seal Installer Tool	E014

■ **NOTE:** Special tools are available from the KYMCO Spare Parts Department.

Front Drive Actuator

■ **NOTE:** The actuator is not a serviceable component. If it is defective, it must be replaced.

■ **NOTE:** The actuator will operate only when the ignition switch is in the ON position.

The front drive actuator is located on the side of the front drive input housing. With the engine stopped and the ignition switch in the ON position, a momentary “whirring” sound can be heard each time the front drive selector switch is shifted. If no sound is heard, see Section 5. If the actuator runs constantly or makes squealing or grinding sounds, the actuator must be replaced.

REMOVING

1. Disconnect the connector on the actuator harness.
2. Remove the mounting cap screw from the drive-shaft side of the actuator.

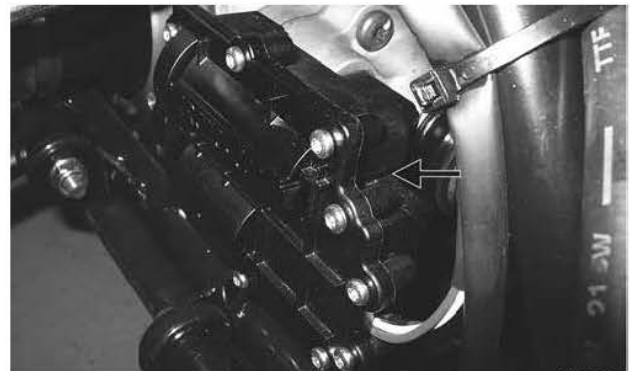

KC293A

3. Remove the mounting cap screw from below the actuator on the suspension side.



4. Loosen but do not remove the mounting cap screw at the front of the actuator; then slide the actuator to the rear enough to clear the slotted mounting tab and the selector shaft.



INSTALLING

1. Lubricate the O-ring on the actuator; then ensure that all mounting surfaces are clean and free of debris.
2. Align the actuator with the selector shaft and slide it forward onto the shaft taking care to engage the cap screw in the slot of the front mounting tab.



3. While holding the actuator firmly forward, tighten the front cap screw to hold the actuator in place; then install but do not tighten the two remaining cap screws.



4. Loosen the front cap screw; then tighten the cap screw on the driveshaft side.



■NOTE: It is important to tighten this cap screw while the others are loose to ensure proper seating of the actuator.

5. Tighten the remaining cap screws; then connect the electrical plug to the main harness.
6. Turn the ignition switch to the ON position and check the operation by shifting the selector switch several times.
7. Secure the wiring harness to the frame with a nylon cable tie.

6

Front Differential

REMOVING DIFFERENTIAL

1. Secure the ATV on a support stand to elevate the wheels.

⚠ WARNING

Make sure the ATV is solidly supported on the support stand to avoid injury.

2. Remove the drain plug and drain the gear lubricant into a drain pan; then reinstall the plug and tighten to 45 in.-lb.

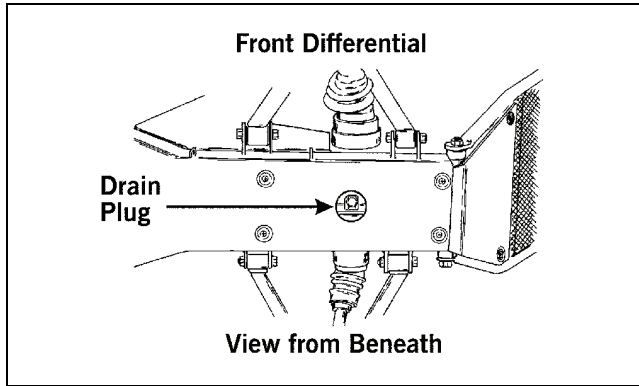

ATV0082A

3. Remove the front wheels.
4. Pump up the hand brake; then engage the brake lever lock.
5. Remove the cotter pin securing the hex nut; then remove the hex nut.
6. Release the brake lever lock.

■NOTE: It is not necessary to remove the brake hoses from the calipers for this procedure.

7. Remove the left and right brake calipers. Account for the four cap screws.

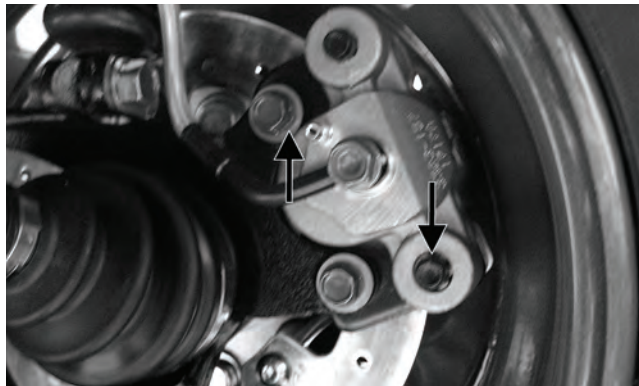

KC187A

8. Remove the upper and lower ball joint cap screws taking care not to strip the threads.

⚠ CAUTION

Apply pressure to hold the ball joint firmly in the knuckle or the threads will be stripped when the retaining cap screws are removed.

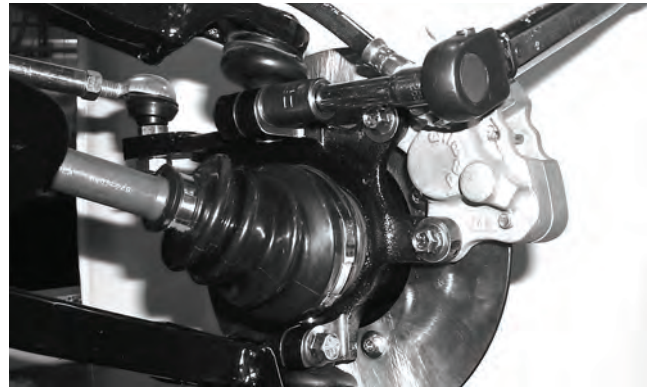

AF628D

9. Pull the steering knuckle away from the axle taking care not to damage the seals as the axle clears the knuckle.



KC314

10. Support the axle to not allow it to drop or hang.

⚠ CAUTION

The axle must be supported. If the axle is allowed to drop or hang, damage to the inner CV joint may occur.

11. Using a slide hammer, remove the front axles.

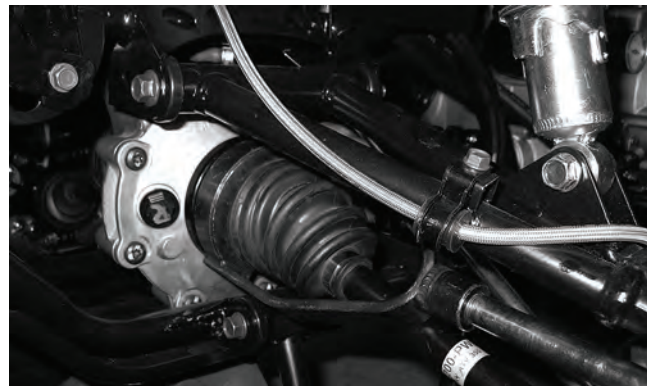

KC289

12. Remove the cap screws from the drive coupler flange; then remove the upper and lower mounting cap screws and remove the differential from the frame.

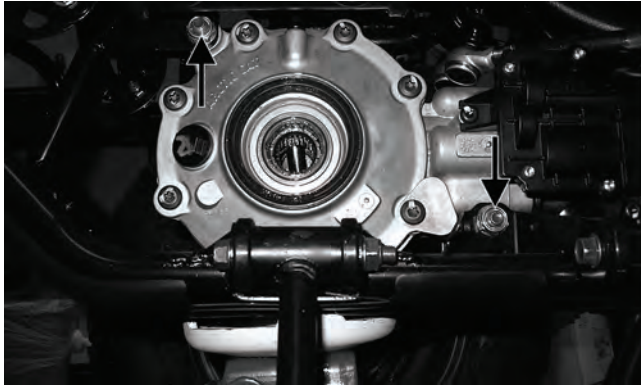

KC291A

Disassembling Input Shaft

■NOTE: This procedure can be performed on a rear gear case; however, some components may vary from model to model. The technician should use discretion and sound judgment.

1. Remove the cap screws securing the front drive actuator and remove the actuator; then remove the cap screws securing the pinion housing.



CD102

2. Using a rubber mallet, remove the housing. Account for a gasket. Remove the fork, collar, and spring. Note the location of all the components for assembling purposes.

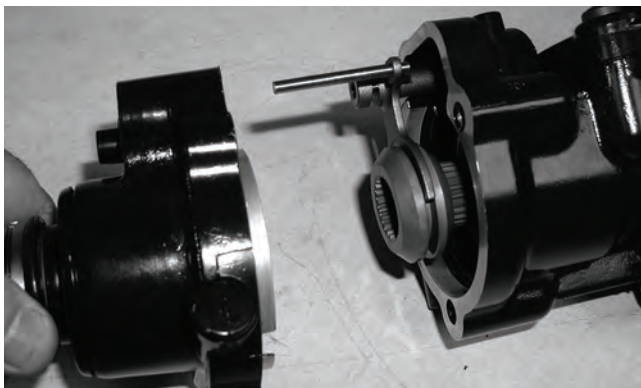

CD103

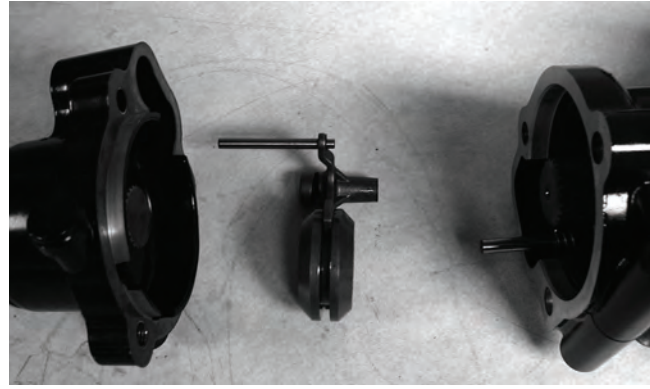

CD106

3. Using a side-cutter (or suitable substitute), remove the boot clamps; then remove the boots and splined drive from the input shaft.
4. Remove the input shaft from the pinion housing.



CD107

5. Using a seal removal tool, remove the input shaft seal. Account for a spacer.

6



AF982

6. Remove the snap ring securing the input shaft bearing; then place the pinion housing in a press and remove the bearing.



AF983

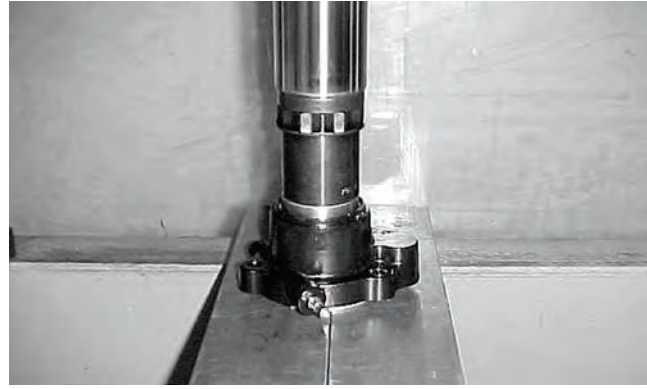

AF993

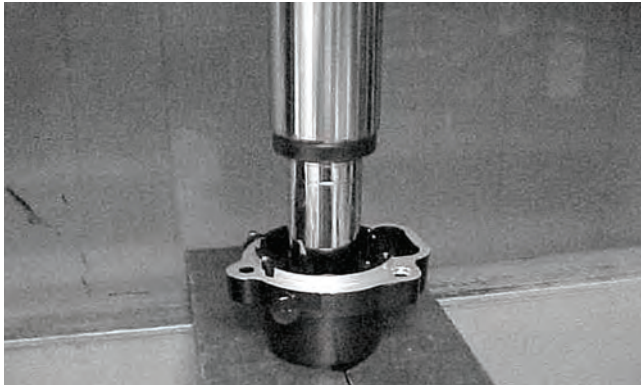

AF984



AF994



KX219

2. Install the input shaft seal making sure it is flush with the edge of the housing.
3. Lubricate the input shaft splines with High-Performance #2 Molybdenum Disulphide Grease.

■NOTE: Any time drive splines are separated, clean all splines with parts-cleaning solvent and dry with compressed air; then lubricate with recommended grease.

Assembling Input Shaft

1. Place the pinion housing in a press and install the input shaft bearing. Secure the bearing with the existing snap ring making sure the sharp edge of the snap ring faces to the outside.



KX221



KX222

4. Install the input shaft into the housing; then install the front boot and secure with an appropriate boot clamp and the rear boot with an appropriate boot clamp.



CD112

5. Using a new O-ring lubricated with grease, install the front drive actuator and secure with the cap screws.
6. Place the pinion housing with new gasket onto the gear case housing; then secure with the existing cap screws. Tighten to 23 ft-lb.

■NOTE: If a new gear case housing is being installed, tighten the cap screws to 28 ft-lb.

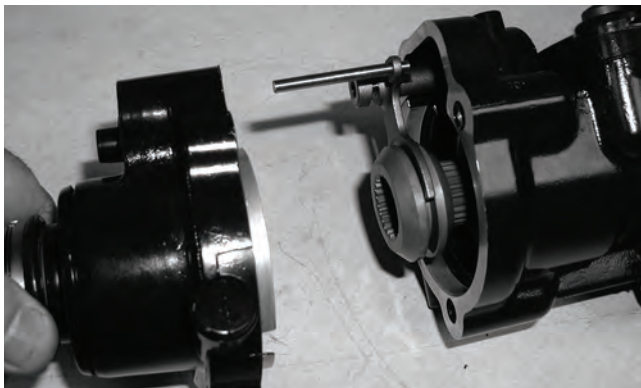

CD103

Disassembling Pinion Gear

■NOTE: This procedure can be performed on a rear gear case.

1. Remove the cap screws securing the pinion housing. Account for the coupler, fork, and spring.



KX209

2. Remove the cap screws securing the gear case cover. Account for and make note of the ID tag location for assembling purposes.



KX173

3. Using a plastic mallet, tap lightly to remove the differential cover. Account for an O-ring.

■NOTE: If the cover is difficult to remove, pry on the cover in more than one recessed location.

4. Remove the left gear case bearing flange assembly and account for a shim. Mark the shim as left-side.



KX177

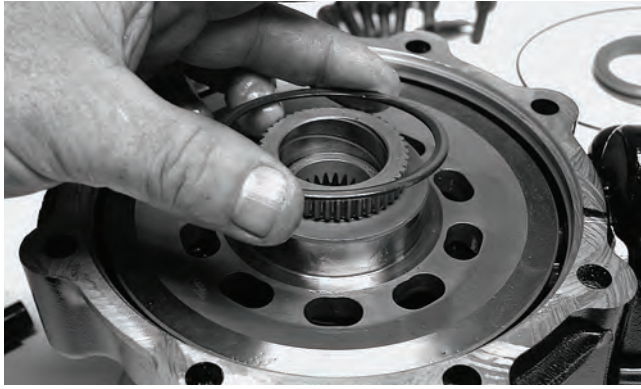

KX178

5. Place the differential with the open side down; then lift the housing off the spider assembly. Account for shim(s) and mark as right-side.

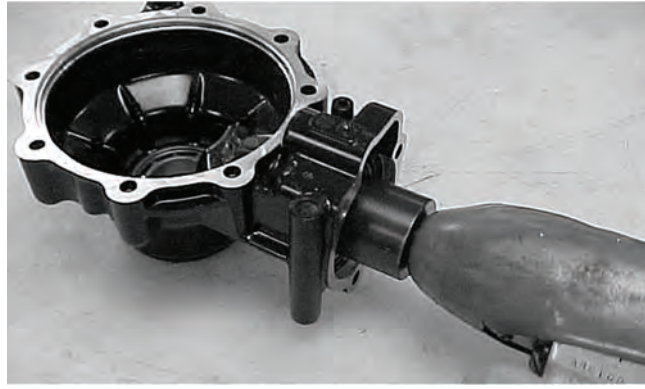

CC875



KX179



CC876

7. Using the Pinion Gear/Shaft Removal Tool and a hammer, remove the pinion gear from the gear case housing.



KX181

6. Using the 48 mm Internal Hex Socket, remove the lock collar securing the pinion gear assembly.

■NOTE: On a front differential, the lock collar has right-hand threads. On a rear gear case, the lock collar has left-hand threads.

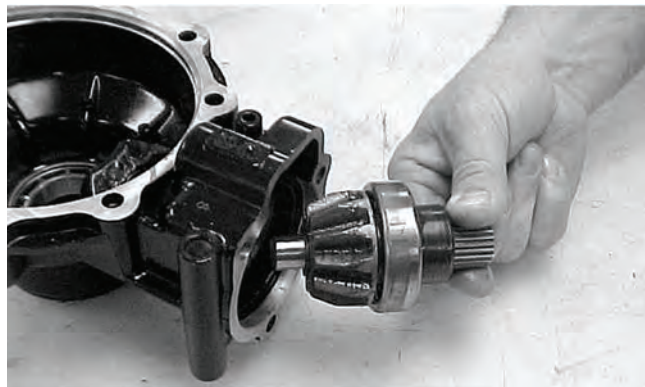

CC878

8. Secure the pinion gear in a bearing puller; then remove the pinion bearing using a press. Account for a collar and a bearing.

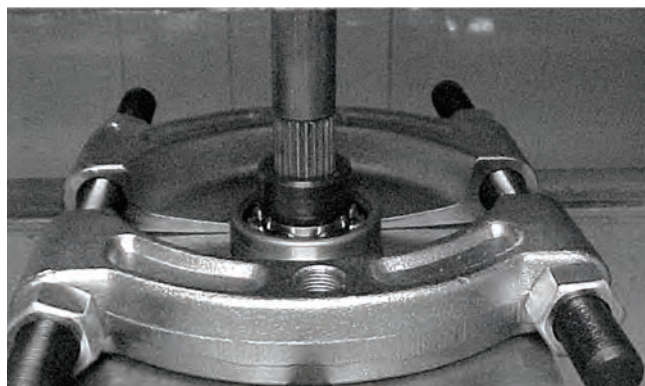

CC879

■NOTE: If gears are being replaced, use the existing shims. The numbers are scribed onto the gears: the ring gear has the number on the opposite side of the gears, and the pinion gear has the number on the end of the pinion gear shaft by the splines. If no number is present, it should be considered as being in the 0 category.

■NOTE: If the gear case housing is being replaced, proceed to the following Shimming Procedure/Shim Selection sub-section.

Shimming Procedure/Shim Selection

1. Press bearings into bores by outer ring to hard contact with seat.
2. Install the lock collar and tighten to 125 ft-lb; then on final assembling, stake the lock collar edge approximately 1.5 mm into the lower oil channel.



CC891

3. Note the following shim selections (shims are nominally 1.5 mm thick):

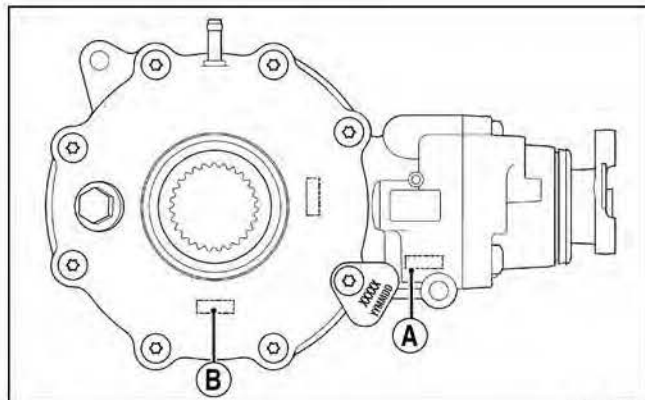

738-268C

- A. Cover Side - add value A on the gear case housing to value B on the gear case cover; then add 1.5 mm. This will give you the proper shim thickness.

B. Gear Case Side - install a 1.3-1.4 mm shim and tighten the bolts to 25-31 ft-lb. Verify backlash to be within a range of 0.28-0.38 mm (0.011-0.015 in.) and end-play to be within a range of 0.10-0.20 mm (0.004-0.008 in.). If not within specification range, reselect shim until backlash specification range can be verified.

4. Prior to final assembling, apply molybdenum disulfide grease to all oil seal lips.
5. Prior to final assembling, prelubricate journal on pinion assembly with SAE 80W-90 hypoid gear lubricant prior to pressing assembly into gear case housing.

Assembling Pinion Gear

1. Install the bearing onto the pinion shaft. Install the pinion shaft collar.



CC882



CC883

2. Place the pinion assembly in a bearing puller; then install the bearing using a press.

6

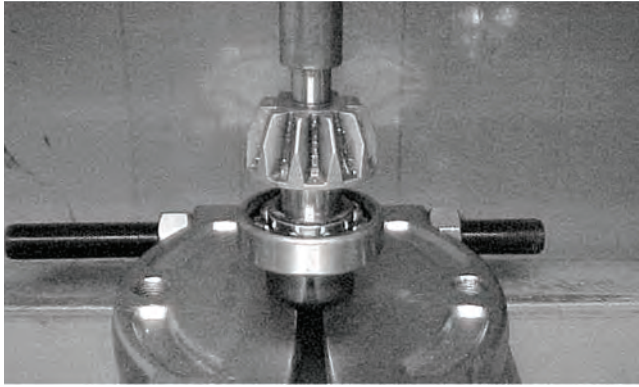

CC884

3. Install the pinion gear assembly into the housing. Using the 48 mm Internal Hex Socket, secure the pinion gear assembly with the existing lock collar. Tighten to 125 ft-lb.

■NOTE: On a front differential, the lock collar has right-hand threads. On a rear gear case, the lock collar has left-hand threads.

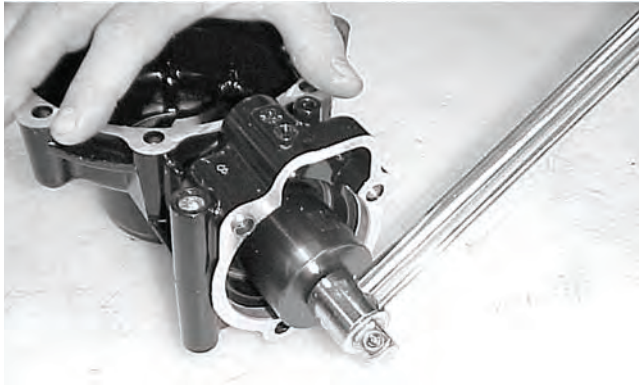

CC890

4. Place a punch on the edge of the lock collar in the oil gallery area; then using a hammer, stake the lock collar to ensure that the collar will remain securely tightened.

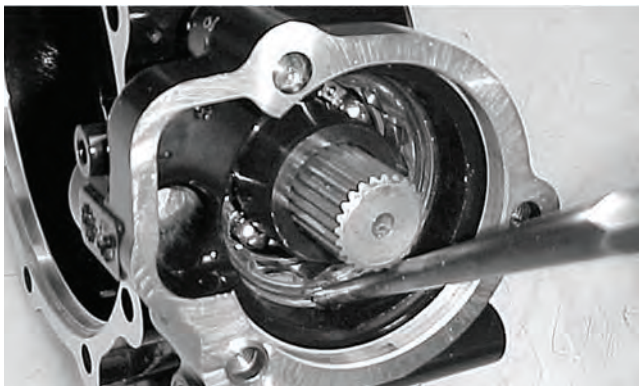

CC891

5. Install the shift fork shaft w/spring into the gear housing making sure the shaft O-ring is positioned to the inside.

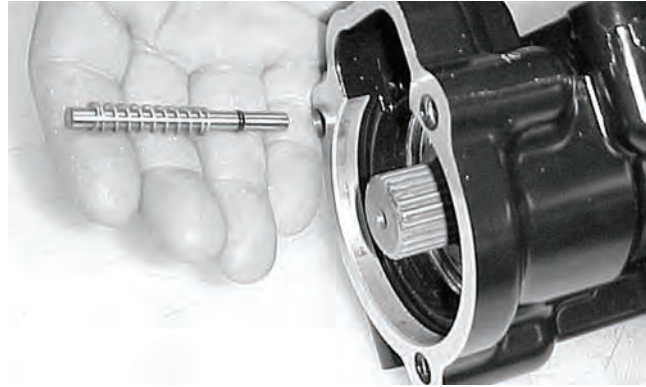

CC892

6. Install the shift fork assembly making sure the fork leg is facing upward. Apply a small amount of oil to the gasket; then install the gasket.

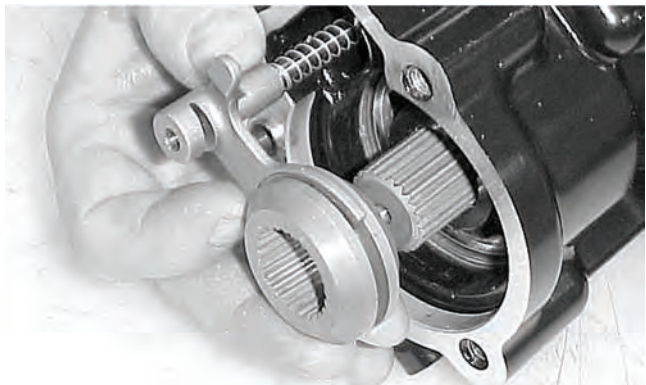

CC893

7. Place the input shaft housing assembly onto the gear housing; then secure with the existing cap screws. Tighten to 23 ft-lb.

■NOTE: If a new gear housing is being installed, tighten the cap screws to 28 ft-lb.

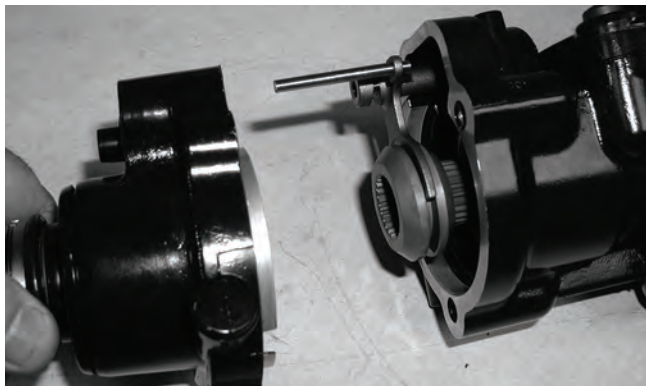

CD103



CD110

8. Install the proper shim onto the ring gear spider assembly making sure the chamfer side of the shim is facing toward the ring gear. Install the ring gear in the housing; then install the outside shim with the chamfer side of the shim toward the ring gear.

■NOTE: The spider and ring gear assembly must be replaced as a complete unit.

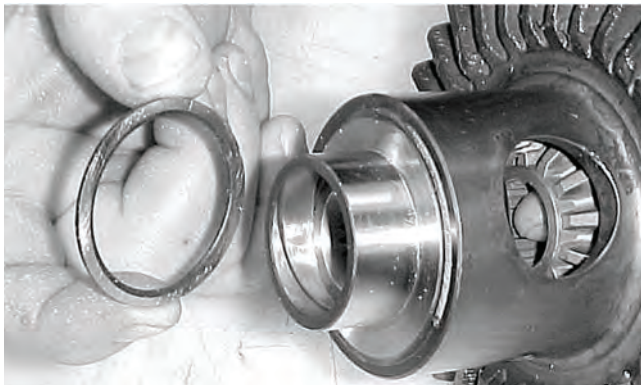

CC896

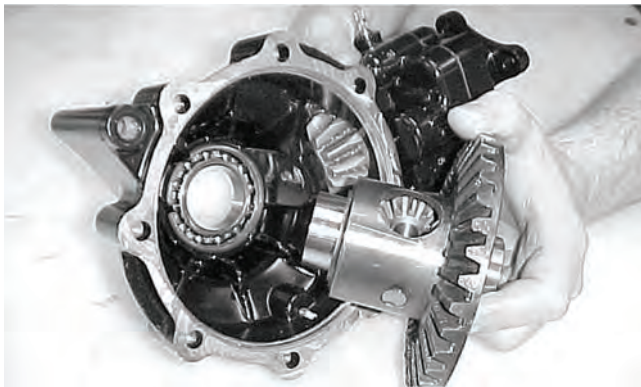

CC897

9. Install left bearing flange/bearing assembly and seat it firmly into the cover.

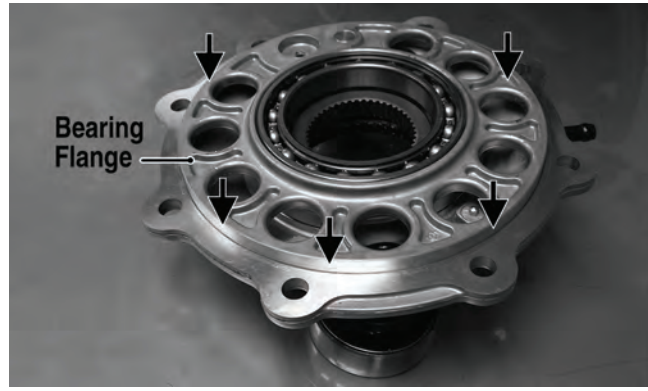

CF267A

10. Apply a liberal amount of grease to the O-ring; then install it on the assembled cover assembly making sure to seat the O-ring down around the circumference of the bearing flange.

11. Making sure the O-ring is properly positioned on the gear case cover assembly, install the cover with existing hardware. Account for the ID tag. Tighten the cap screws to 23 ft-lb.

■NOTE: Grease can be applied to the O-ring for ease of assembling.

■NOTE: If a new gear case housing is being installed, tighten the cap screws to 25-31 ft-lb.

Removing Needle Bearing

■NOTE: Removing the needle bearing is rarely necessary. Avoid removing the needle bearing unless the bearing is clearly damaged.

■NOTE: This procedure can be performed on a rear gear case.

1. Place a 1/4 in. drill bit on the inside surface of the needle bearing (against the bottom side); then drill through the pinion shaft needle bearing housing.

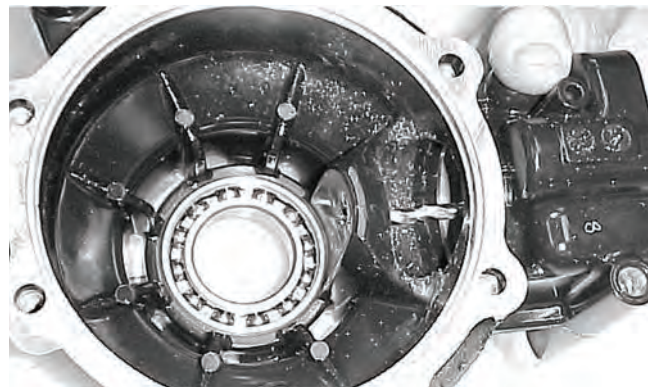

CC885

2. Using a propane torch, heat the area surrounding the needle bearing to soften the Loctite.

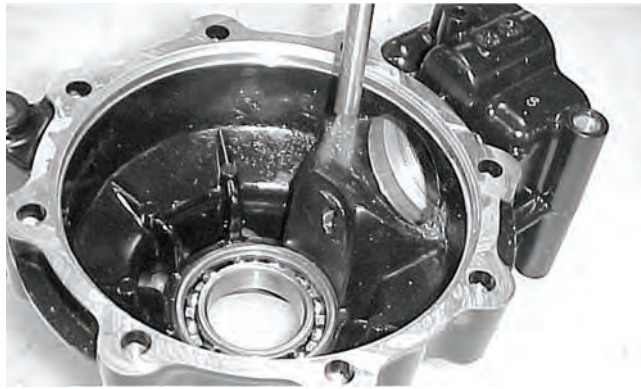

CC886

- Using a flat-nosed punch, drive the bearing out of the housing.

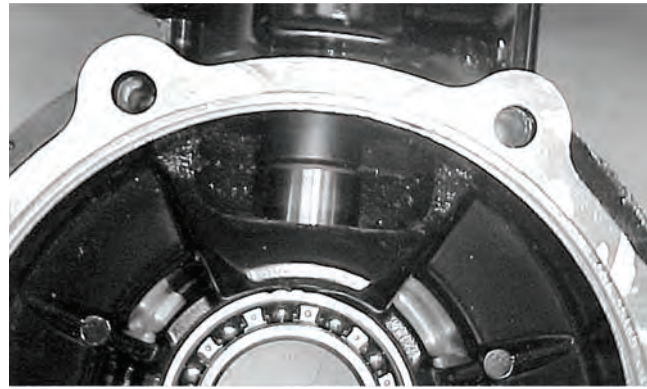

CC889

- Install the pinion shaft and secure with the existing 48 mm lock collar. Tighten to 125 ft-lb.



CC887

Installing Needle Bearing

- Apply green Loctite #609 to the outside of a new bearing; then place the new bearing into the housing.



CC888

- Using a suitable driver, install the needle bearing into the gear case housing making sure the bearing is seated.

■NOTE: Do not push the bearing too far into the housing.

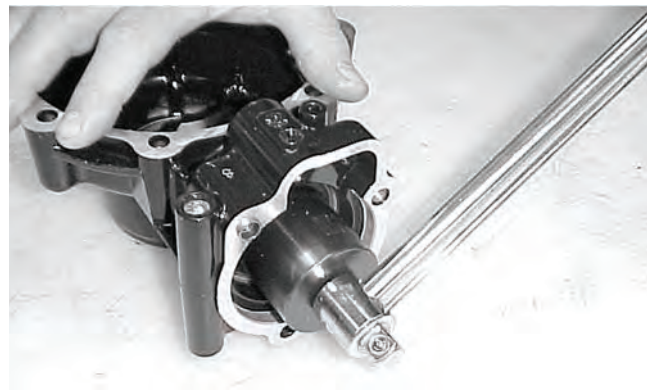

CC890

- Place a punch on the edge of the lock collar in the oil gallery area; then using a hammer, stake the lock collar to ensure that the collar will remain securely tightened.

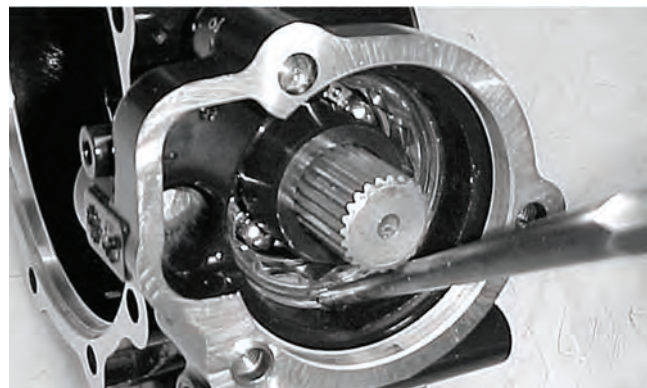

CC891

- Install the pinion housing.

Removing/Installing Axle Seal

■NOTE: This procedure can be performed on a rear gear case.

- Remove the seal using a seal removal tool.



CC899

2. Using a press, remove the bearing.



CC900

3. Using a press, install the new bearing into the housing.



CC901

■NOTE: Prior to installing the seal, apply High Performance #2 Molybdenum Disulphide Grease to the seal outside diameter.

4. Using an appropriate seal installation tool, evenly press the seal into the cover bore until seated.

CAUTION

Make sure the tool is free of nicks or sharp edges or the seal will be damaged.



CF278

5. Repeat steps 1-4 for the opposite side.

INSTALLING DIFFERENTIAL

1. Align the input flange with the front output flange; then place the differential into position on the frame and install the cap screws and nuts. Tighten to 38 ft-lb.

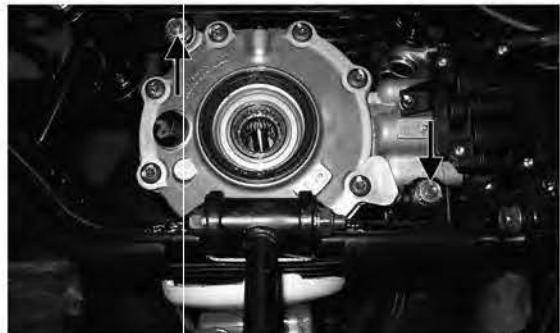

KC291A

2. Install the cap screws securing the flange couplers together and tighten to 20 ft-lb.



AG925

3. Install the front axles (see Drive Axles in this section).

6

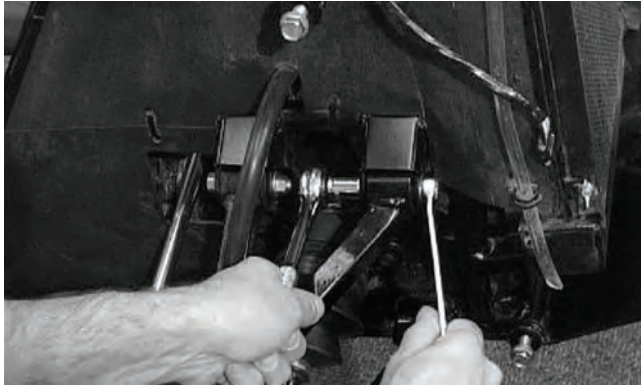

AF610D

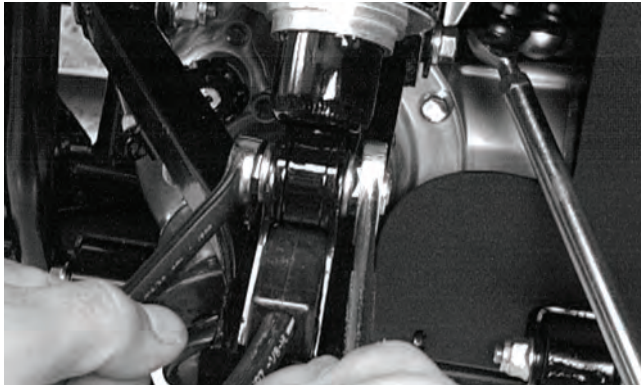

AF897D

4. Install the brake calipers and secure with the patch-lock cap screws tightened to 20 ft-lb.

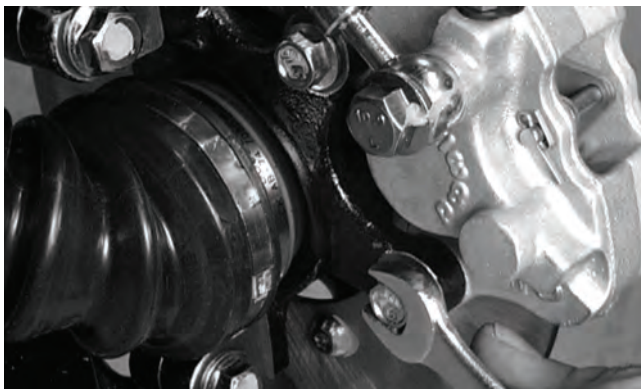

AF894D

5. Install the wheels and tighten to 40 ft-lb.
6. Pour 275 ml (9.3 fl oz) of SAE 80W-90 hypoid gear lubricant into the differential and install the filler plug. Tighten to 16 ft-lb.
7. Remove the ATV from the support stand.

Drive Axles

REMOVING REAR DRIVE AXLES

1. Secure the ATV on a support stand to elevate the wheels.

⚠ WARNING

Make sure the ATV is solidly supported on the support stand to avoid injury.

2. Pump up the hand brake; then engage the brake lever lock.
3. Remove the rear wheels.
4. Remove the cotter pin securing the hex nut; then remove the hex nut. Release the brake lever lock.
5. Remove the brake caliper (right side only).

NOTE: Do not allow the brake caliper to hang from the hose.

⚠ CAUTION

The caliper should be supported. If the calipers are allowed to hang from the hose, damage may occur.

6. Slide the hub off the shaft and set aside.
7. Remove the cap screw and lock nut securing the knuckle to the upper A-arm. Discard the lock nut.



KC284

NOTE: Never reuse a lock nut. Once a lock nut has been removed, it must be replaced with a new lock nut.

8. While holding the drive axle stationary, pull the top of the knuckle out and down until it is free of the drive axle.



KC285

9. Place a drain pan under the ATV to contain any oil leakage; then using a slide hammer, remove the drive axle.

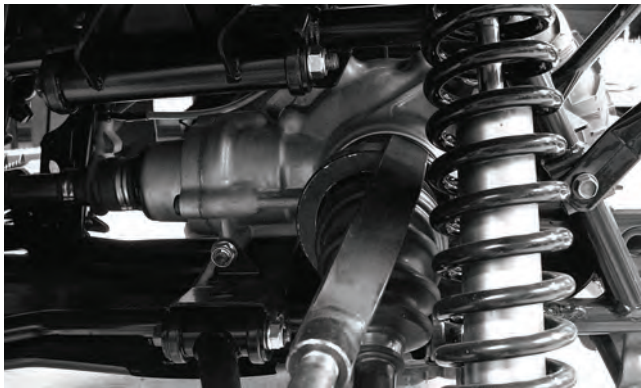

KC286

REMOVING FRONT DRIVE AXLE

■NOTE: For removing a front drive axle, see Front Differential in this section.

CLEANING AND INSPECTING

■NOTE: Always clean and inspect the drive axle components to determine if any service or replacement is necessary.

1. Using a clean towel, wipe away any oil or grease from the axle components.



CD019

2. Inspect boots for any tears, cracks, or deterioration.

■NOTE: If a boot is damaged in any way, it must be replaced with a boot kit.

3. Inspect the gear case seals for nicks or damage.

DISASSEMBLING AXLES

1. Using a side-cutters (or suitable substitute), remove the large clamp from the boot.

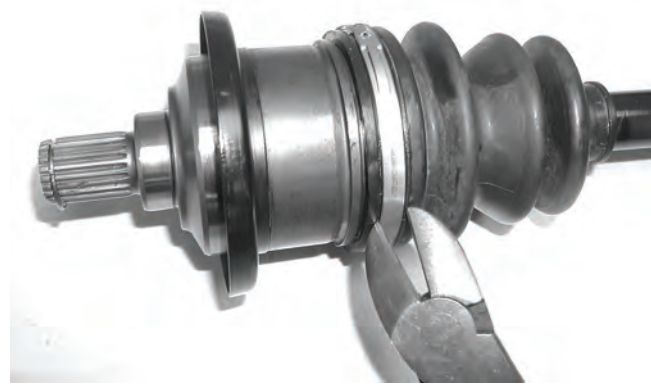

CD020

2. Wipe away excess grease to access the retaining ring. Using an awl, remove the circlip.



CD021

3. Using a snap ring pliers, remove the snap ring securing the bearing ring to the shaft. Note the direction of the bearing for assembling purposes.

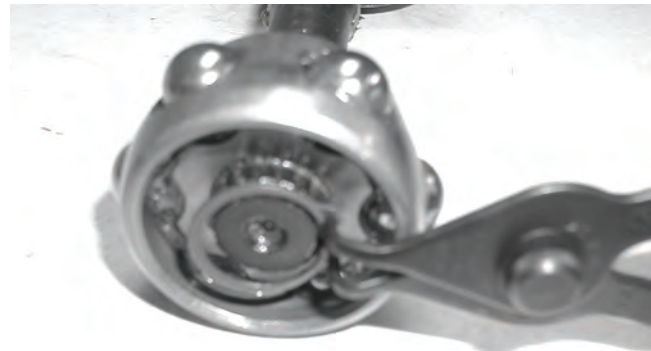

CD023

4. Note the difference inside each bearing ring end for assembling purposes; then remove the bearing ring.

■NOTE: The recess of the bearing must face toward the housing.



CD022

5. Inspect the splines of the shaft, the bearing ring, and the housing for damage.

■NOTE: If any damage is apparent to the splines, the bearing ring, and/or the housing, the drive axle must be replaced as an assembly.

6. Using a side-cutters (or suitable substitute), remove the small clamp from the shaft.



CD752

■NOTE: At this point if the outside boot is damaged, continue with step 7.

7. Using a side-cutters (or suitable substitute), remove both outside boot clamps from the shaft. Note the position of the different-sized clamps for assembling purposes.



CD751

8. Apply 40 grams (1/3 of contents) of grease from the Grease Pack into the knuckles and the new outside boot.

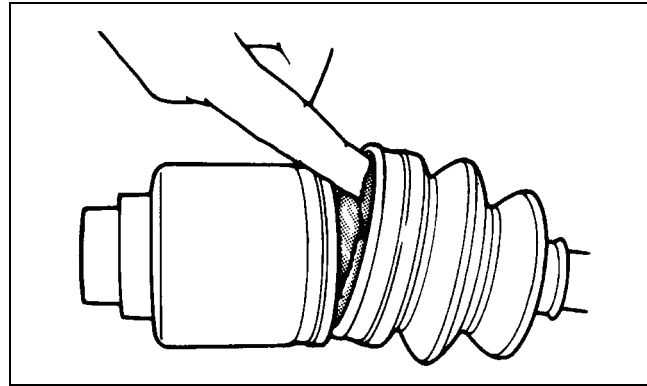

ATV-1052

■NOTE: Grease Pack contains 120 grams of grease. The inside joint (double-offset) requires approximately 70-90 grams of grease and the outside (bell-type) requires approximately 35-55 grams. When replacing boots, use 2/3 of the pack for inside boots and 1/3 of the pack for outside boots.

CAUTION

Do no over-fill the joint as boot damage may occur resulting in joint failure.

9. Slide the new outside boot onto the shaft with the new clamps positioned as shown. Note the different-sized clamps from removal.

■NOTE: The boot is positioned correctly when the small end of the boot seats down into the recessed groove.



CD754

10. Using the CV Boot Clamp Tool, secure both outside boot clamps.

CAUTION

It is important that the clamps are positioned correctly or they may loosen when in motion.



CD024

ASSEMBLING AXLES

1. Install the inner boot with the small clamp making sure the ends of the clamp are positioned correctly.

■NOTE: The boot is positioned correctly when the small end of the boot seats down into the recessed groove.



CD754

2. Using the boot clamp pliers, secure the small clamp of the inner boot.

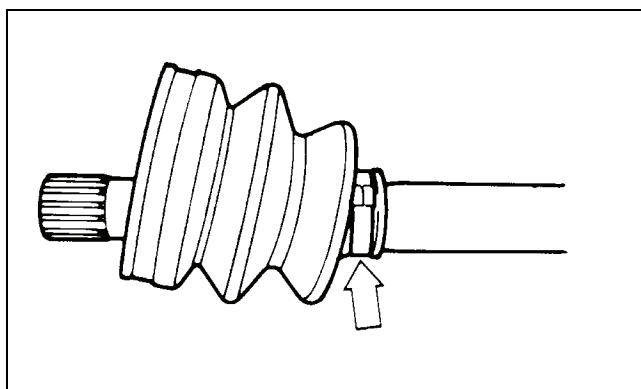

ATV-1048

3. Apply 80 grams (2/3 of contents) of grease from the pack into the bearing housing.
4. Install the bearing onto the shaft making sure the recess of the bearing is facing the housing.



CD022

⚠ CAUTION

The bearing ring must go onto the shaft with the side without splines facing toward the small clamp of the inner boot or severe damage will result.

5. Secure the bearing ring with the snap ring making sure the sharp side of the snap ring faces away from the boot.



CD023

6. Making sure the marks made during disassembling align, slide the housing over the bearing ring; then completely seat the bearing ring into the housing and install the circlip.

■NOTE: Pull the bearing ring out of the housing until it contacts the circlip; then slide the ring in half way. This will purge air from the housing and ensure the bearing is packed properly.



CD021

7. Slide the boot over the housing; then using the boot clamp pliers, secure the boot with the clamp.

6



CD024

8. Inspect the axle components for correct positioning of the four clamps. Also, inspect the boots for being correctly positioned on the shaft.

INSTALLING REAR DRIVE AXLE

1. Slide the drive axle into place in the gear case.

■NOTE: To assure proper seating of the axle, give it a light pull; the axle should remain “clipped” in place.

2. Swing the knuckle up and onto the drive axle; then place the knuckle into place in the upper A-arm. Secure the knuckle to the A-arm with a cap screw and a new lock nut. Tighten to 35 ft-lb.
3. Place the hub into position on the axle followed by a hex nut. Tighten the hex nut finger-tight at this time.
4. If the brake caliper was removed, position it on the knuckle and secure with existing cap screws. Tighten the brake caliper cap screws to 20 ft-lb.
5. Pump up the hand brake lever; then engage the brake lever lock.
6. Tighten the hub hex nut (from step 3) to 200 ft-lb; then install and spread a new cotter pin making sure each side of the pin is flush to the hub nut.
7. Install the wheel. Tighten to 40 ft-lb.
8. Remove the ATV from the support stand and release the brake lever lock.

INSTALLING FRONT DRIVE AXLE

1. Position the drive axle in the gear case and steering knuckle; then insert the upper A-arm ball joint into the steering knuckle. Secure with a cap screw tightened to 35 ft-lb.
2. Slide the hub w/brake disc into position in the steering knuckle followed by a washer and hex nut. Tighten finger-tight at this time.
3. Install the brake caliper on the steering knuckle. Tighten to 20 ft-lb; then pump up the hand brake lever and engage the brake lever lock.

4. Tighten the hub hex nut (from step 2) to 200 ft-lb; then install and spread a new cotter pin making sure each side of the pin is flush to the hub nut.



KC305

5. Install the wheel and tighten to 40 ft-lb.
6. Remove the ATV from the support stand and release the brake lever lock.
7. Check the front differential oil level and add oil as necessary.

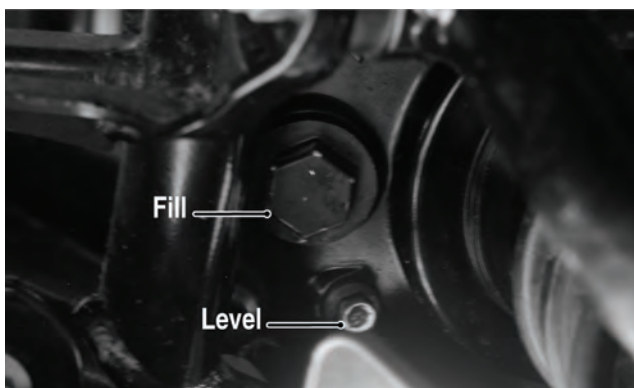

CF113A

Rear Gear Case

REMOVING

1. Remove both of the rear drive axles (see Drive Axles in this section).
2. Remove the four cap screws securing the engine output shaft to the rear gear case input flange.

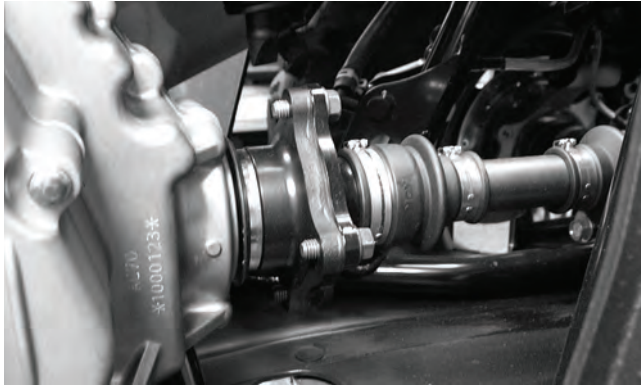

KC169

3. Remove the two cap screws and lock nuts securing the rear gear case to the frame; then remove the gear case through the left side.

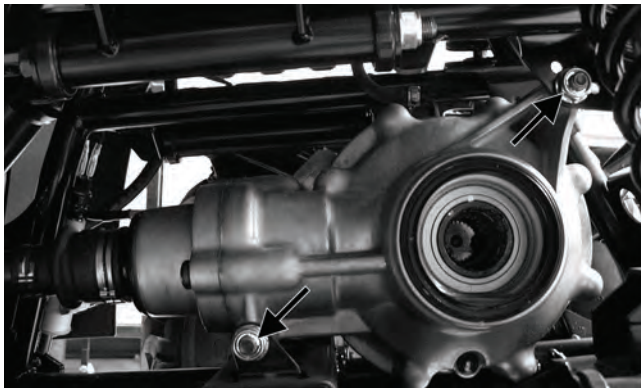

KC288A

AT THIS POINT

For servicing the input shaft, pinion gear, needle bearing, and axle seal, see Front Differential in this section.

INSTALLING

1. Slide the gear case into position through the left side of the frame; then secure it to the frame with cap screws and lock nuts. Tighten to 45 ft-lb.
2. Secure the engine output shaft to the rear gear case input flange with four cap screws (coated with red Loctite #271) and lock nuts. Tighten to 20 ft-lb.
3. Install the rear drive axles (see Drive Axles in this section).

Hub

REMOVING

1. Secure the ATV on a support stand to elevate the wheel; then remove the wheel.

WARNING

Make sure the ATV is solidly supported on the support stand to avoid injury.

2. Remove the cotter pin from the nut.

■NOTE: During assembly, new cotter pins should be installed.

3. Remove the flange nut securing the hub.
4. Remove the brake caliper.



KC283

5. Remove the hub assembly.
6. Remove the four cap screws securing the brake disc.

CLEANING AND INSPECTING

■NOTE: Whenever a part is worn excessively, cracked, or damaged in any way, replacement is necessary.

1. Clean all hub components.
2. Inspect all threads for stripping or damage.
3. Inspect the brake disc for cracks or warping.
4. Inspect the hub for pits, cracks, loose studs, or spline wear.

INSTALLING

1. Secure the brake disc to the hub with the four cap screws coated with blue Loctite #243. Tighten to 15 ft-lb.
2. Apply grease to the splines in the hub.

3. Install the hub assembly onto the shaft.
4. Secure the hub assembly with the nut. Tighten only until snug.
5. Secure the brake caliper to the knuckle with the two cap screws. Tighten the caliper to 20 ft-lb.



KC283

6. Tighten the hub nut (from step 4) to 200 ft-lb; then install and spread a new cotter pin making sure each side of the pin is flush to the hub nut.



KC305

7. Install the wheel and tighten to 40 ft-lb.
8. Remove the ATV from the support stand.

Hydraulic Brake Caliper

■NOTE: The brake calliper is a non-serviceable component; it must be replaced as an assembly.

REMOVING/DISASSEMBLING

1. Secure the ATV on a support stand to elevate the wheel; then remove the wheel.

⚠ WARNING

Make sure the ATV is solidly supported on the support stand to avoid injury.

2. Drain the brake fluid from the caliper, hose, and master cylinder.

⚠ CAUTION

Brake fluid is highly corrosive. Do not spill brake fluid on any surface of the ATV and do not reuse brake fluid.

3. Remove the brake hose from the caliper; then remove the caliper and plug the brake fluid port.
4. Compress the caliper holder against the caliper and remove the outer brake pad; then remove the inner brake pad.



PR237



PR238

5. Remove the caliper holder from the caliper and account for the brake caliper O-ring. Do not remove the piston from the caliper.

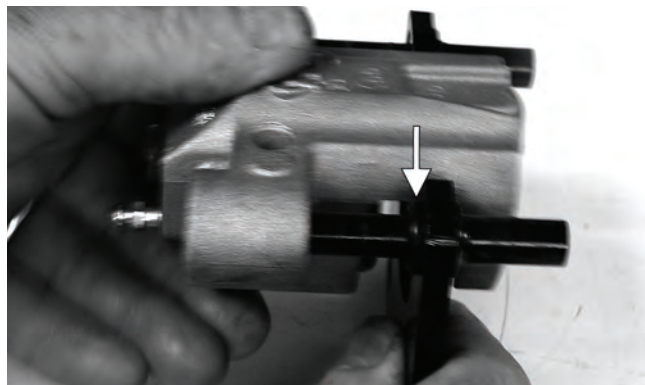

PR239B

6. Plug the fluid port with a suitable plug to prevent contamination during cleaning.

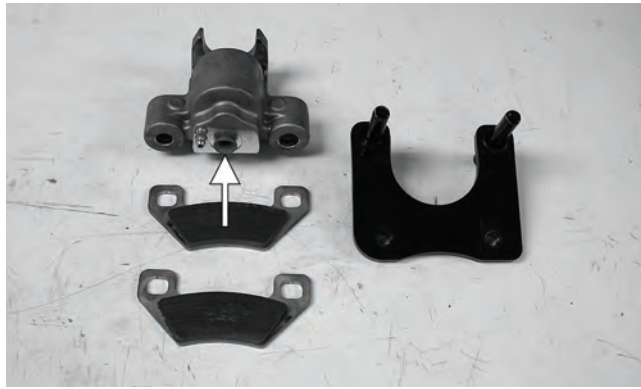

PR240A

CLEANING AND INSPECTING

1. Clean all caliper components (except the brake pads) with parts-cleaning solvent.
2. Inspect the brake pads for damage and excessive wear.

■NOTE: For measuring brake pads, see Section 2.

ASSEMBLING/INSTALLING

1. Install the caliper onto the caliper holder making sure the caliper is correctly oriented on the holder.

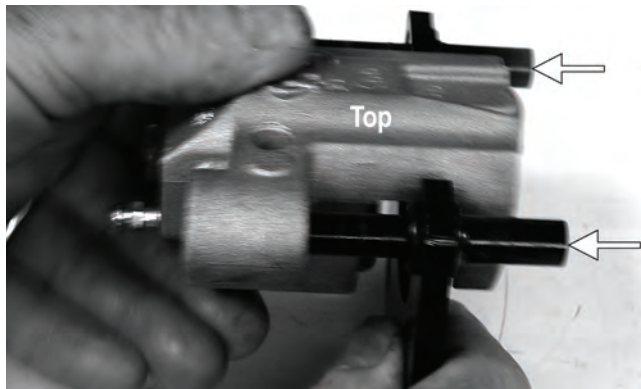

PR239C

2. Compress the caliper holder toward the caliper and install the inner brake pad; then install the outer pad.

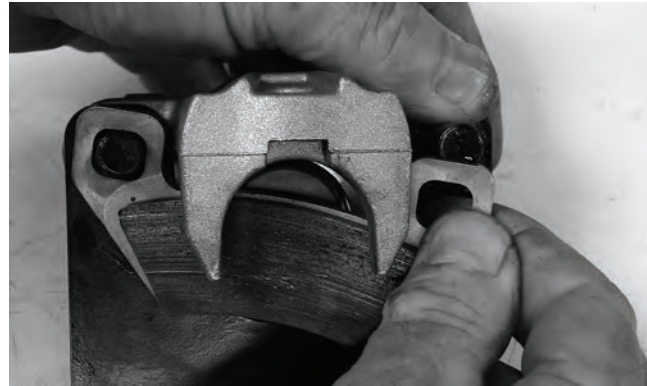

PR238

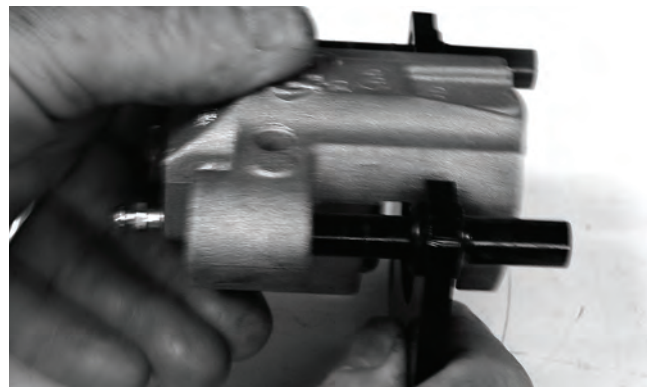

PR239

3. Place the brake caliper assembly into position and secure with the cap screws. Tighten the caliper to 20 ft-lb.
4. Place a new crush washer on each side of the brake hose fitting and install it on the caliper. Tighten to 20 ft-lb.
5. Fill the reservoir; then bleed the brake system (see Section 2).
6. Install the wheel. Tighten to 40 ft-lb.
7. Remove the ATV from the support stand and verify brake operation.

6

Troubleshooting Drive System

Problem: Power not transmitted from engine to wheels	
Condition	Remedy
1. Rear axle shafts serration worn - broken	1. Replace shaft
Problem: Power not transmitted from engine to either front wheel	
Condition	Remedy
1. Secondary drive - driven gear teeth broken	1. Replace gear(s)
2. Propeller shaft serration worn - broken	2. Replace shaft
3. Coupling damaged	3. Replace coupling
4. Coupling joint serration worn - damaged	4. Replace joint
5. Front drive - driven bevel gears broken - damaged	5. Replace gear(s)
6. Front differential gears/pinions broken - damaged	6. Replace gears - pinions
7. Sliding dogs/shaft fork worn - damaged	7. Replace gear(s)
8. Front drive axle worn - damaged	8. Replace axle
9. Front drive axle serration worn - damaged	9. Replace axle

Troubleshooting Brake System

Problem: Braking poor	
Condition	Remedy
1. Pad worn	1. Replace pads
2. Pedal free-play excessive	2. Replace pads
3. Brake fluid leaking	3. Repair - replace hydraulic system component(s)
4. Hydraulic system spongy	4. Bleed hydraulic system - correct or repair leaks
5. Master cylinder/brake cylinder seal worn	5. Replace master cylinder
Problem: Brake lever travel excessive	
Condition	Remedy
1. Hydraulic system entrapped air	1. Bleed hydraulic system
2. Brake fluid low	2. Add fluid to proper level
3. Brake fluid incorrect	3. Drain system - replace with correct fluid
4. Piston seal - cup worn	4. Replace master cylinder
Problem: Brake fluid leaking	
Condition	Remedy
1. Connection joints loose	1. Tighten joint
2. Hose cracked	2. Replace hose
3. Piston seal worn	3. Replace brake caliper

SECTION 7 - SUSPENSION

TABLE OF CONTENTS

Suspension	7-2
Shock Absorbers	7-2
Front A-Arms	7-2
Rear A-Arms	7-3
Wheels and Tires	7-4
Troubleshooting	7-6

Suspension

■NOTE: Critical torque specifications are located in Section 1.

Shock Absorbers

REMOVING

1. Secure the ATV on a support stand to elevate the wheels and to release load on the suspension.

⚠ WARNING

Make sure the ATV is solidly supported on the support stand to avoid injury.

2. Remove the two cap screws and nuts securing each front shock absorber to the frame and the upper A-arm. Account for bushings and sleeves from each.

⚠ CAUTION

Additional support stands are necessary to support the rear axle when the shock absorbers are removed or damage may occur.

3. Remove the two cap screws and nut securing each rear shock absorber to the frame and lower A-arm. Account for bushings and sleeves from each.

■NOTE: The shock absorbers are not serviceable components. If leaking, dented, or there are missing or broken parts, the shock absorber assembly must be replaced.

INSTALLING

1. Place bushings and sleeves (where appropriate) into shock eyelet; then install shock with cap screws and nuts. Tighten all nuts to 35 ft-lb.

⚠ CAUTION

Do not tighten the nuts beyond the 35 ft-lb specification or the shock eyelet or mount WILL be damaged.

2. Remove the ATV from the support stand.

Front A-Arms

REMOVING

1. Secure the ATV on a support stand to elevate the front wheels; then remove the wheels.

⚠ WARNING

Make sure the ATV is solidly supported on the support stand to avoid injury.

2. Remove the cotter pin from the nut. Discard the cotter pin.
3. Remove the nut securing the hub.
4. Remove the brake caliper. Account for two cap screws.

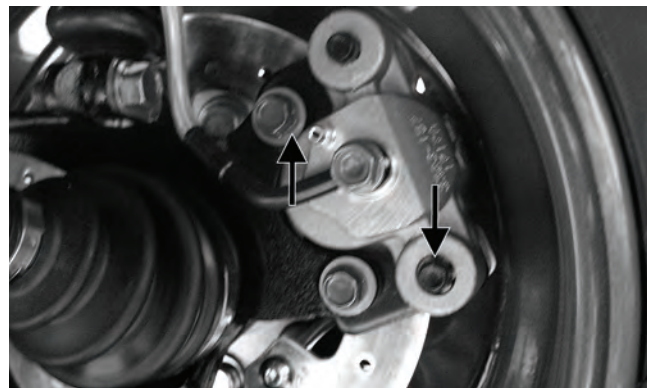

KC187A

5. Remove the hub assembly.
6. Remove the cap screws securing the ball joints to the knuckle.

⚠ CAUTION

Support the knuckle when removing the cap screws or damage to the threads will occur.



KC313A

7. Tap the ball joints out of the knuckle; then free the knuckle from the axle and swing out of the way.

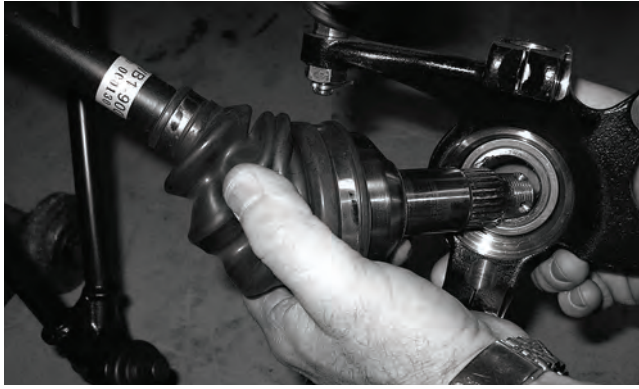

KC297

8. Remove the lower shock absorber eyelet from the upper A-arm.
9. Remove the cap screws securing the A-arms to the frame.
10. Remove the circlip from the ball joint; then remove the ball joint from the A-arm.

CLEANING AND INSPECTING

■ **NOTE:** Whenever a part is worn excessively, cracked, or damaged in any way, replacement is necessary.

1. Clean all A-arm components using a pressure washer.
2. Clean the ball joint mounting hole of all residual Loctite, grease, oil, or dirt for installing purposes.
3. Inspect the A-arm for bends, cracks, and worn bushings.
4. Inspect the ball joint mounting holes for cracks or damage.
5. Inspect the frame mounts for signs of damage, wear, or weldment damage.

INSTALLING

1. Apply green Loctite #609 to the entire outside diameter of the ball joint; then install the ball joint into the A-arm and secure with the circlip.
2. Install the A-arm assemblies into the frame mounts and secure with the cap screws. Only finger-tighten at this time.
3. Secure the lower eyelet of the shock absorber to the upper A-arm. Tighten nut to 35 ft-lb.
4. Secure the A-arm assemblies to the frame mounts (from step 2). Tighten the cap screws to 35 ft-lb.

CAUTION

Do not tighten the nut beyond the 35 ft-lb specification or the shock eyelet or mount WILL be damaged.

5. Install the knuckle assembly onto the ball joints and secure with cap screws. Tighten to 35 ft-lb.
6. Apply grease to the hub and drive axle splines; then install the hub assembly onto the drive axle.
7. Secure the hub assembly with the nut. Tighten only until snug.
8. Secure the brake caliper to the knuckle with the two patch-lock cap screws. Tighten to 20 ft-lb.
9. Secure the hub nut (from step 7) to the shaft/axle. Tighten to 200 ft-lb.
10. Install a new cotter pin and spread the pin to secure the nut.
11. Install the wheel and tighten to 40 ft-lb.
12. Remove the ATV from the support stand.

Rear A-Arms

REMOVING

1. Secure the ATV on a support stand to elevate the wheels.

WARNING

Make sure the ATV is solidly supported on the support stand to avoid injury.

2. Pump up the hand brake; then engage the brake lever lock.
3. Remove the wheel.
4. Remove the cotter pin securing the hex nut; then remove the hex nut. Release the brake lever lock.
5. Remove the caliper (right side only).

■ **NOTE:** Do not allow the brake caliper to hang from the hose.

6. Remove the cap screws and lock nut securing the shock absorber to the frame and lower A-arm; then remove the shock absorber.



KC0100

7. Slide the hub out of the knuckle and set aside.
8. Remove the cap screws and lock nuts securing the knuckle to the A-arms. Discard the lock nuts.

■NOTE: Never reuse a lock nut. Once a lock nut has been removed, it must be replaced with a new lock nut.

9. Remove the cap screws and lock nuts securing the A-arms to the frame; then remove the A-arms.

■NOTE: If removing the upper right A-arm, it will be necessary to disconnect the brake hose from the A-arm.

CLEANING AND INSPECTING

■NOTE: Whenever a part is worn excessively, cracked, or damaged in any way, replacement is necessary.

1. Clean all A-arm components using a pressure washer.
2. Inspect the A-arm for bends, cracks, and worn bushings.
3. Inspect the frame mounts for signs of damage, wear, or weldment damage.

INSTALLING

1. Install the A-arm assemblies into the frame mounts and secure with the cap screws and new lock nuts. Only finger-tighten at this time.
2. Slide the knuckle onto the drive axle and into position on the A-arms; then secure the knuckle to the A-arms with cap screws and new lock nuts. Tighten to 35 ft-lb.
3. Tighten the hardware securing the A-arms to the frame mounts (from step 1) to 35 ft-lb.
4. Apply grease on the drive axle splines; then install the hub assembly onto the drive axle.
5. Secure the hub assembly with the nut. Tighten only until snug.

6. Secure the brake caliper to the knuckle with the two cap screws (right side only). Tighten the caliper to 20 ft-lb.
7. Compress the hand brake lever and engage the brake lever lock; then secure the hub nut (from step 5) to the drive axle. Tighten to 200 ft-lb.
8. Install a new cotter pin and spread the pin to secure the nut.
9. Secure the shock absorber to the frame with a cap screw and new lock nut. Tighten to 35 ft-lb.
10. Secure the shock absorber to the lower A-arm with a cap screw and new lock nut. Tighten to 20 ft-lb.
11. Secure the boot guard to the lower A-arm with the two cap screws. Tighten securely.
12. Install the wheel and tighten to 40 ft-lb.
13. Remove the ATV from the support stand.

Wheels and Tires

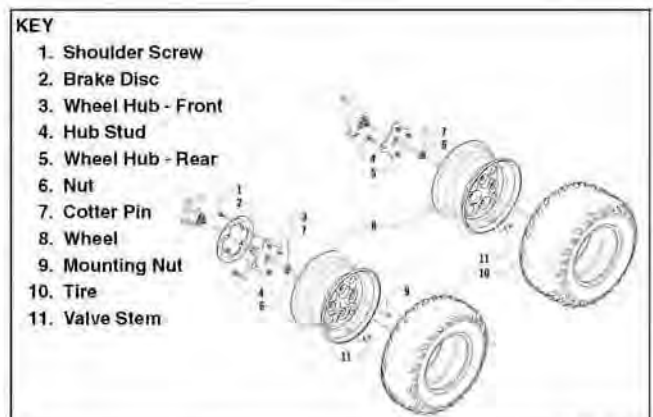

0742-948

TIRE SIZE

⚠ WARNING

Use only KYMCO approved tires when replacing tires. Failure to do so could result in unstable ATV operation.

The ATV is equipped with low-pressure tubeless tires of the size and type listed in Section 1. Do not under any circumstances substitute tires of a different type or size.

⚠ WARNING

Do not mix tire tread patterns. Use the same pattern type on front and rear. Failure to heed warning could cause poor handling qualities of the ATV and could cause excessive drive train damage not covered by warranty.

TIRE INFLATION PRESSURE

Front and rear tire inflation pressure should be **0.4 kg/cm² (5.7 psi)**.

REMOVING

1. Secure the ATV on a support stand to elevate the wheels.

WARNING

Make sure the ATV is solidly supported on the support stand to avoid injury.

2. Remove the wheels.

■NOTE: Keep left-side and right-side wheels separated for installing them on their proper sides.

CLEANING AND INSPECTING

■NOTE: Whenever a part is worn excessively, cracked, or damaged in any way, replacement is necessary.

1. Clean the wheels and hubs using a pressure washer.
2. Inspect each wheel for cracks, dents, or bends.
3. Inspect each tire for cuts, wear, missing lugs, and leaks.

INSTALLING

Install each wheel on its hub. Tighten to 40 ft-lb.

■NOTE: Make sure each wheel is installed on its proper hub as noted in removing (the "rotation arrow" (if applicable) must indicate forward direction of rotation).



AF612D

CHECKING/INFLATING

1. Using an air pressure gauge, measure the air pressure in each tire. Adjust the air pressure as necessary to meet the recommended inflation pressure.
2. Inspect the tires for damage, wear, or punctures.

WARNING

Do not operate the ATV if tire damage exists.

■NOTE: If repair is needed, follow the instructions found on the tire repair kit or remove the wheel and have it repaired professionally.

■NOTE: Be sure all tires are the specified size and have identical tread pattern.

3. Check the front wheel toe-in and toe-out and adjust as necessary (see Section 8).
4. Test drive the ATV on a dry, level surface and note any pulling to the left or right during acceleration, deceleration, and braking.

■NOTE: If pulling is noted, measure the circumference of the front and rear tires on the pulling side. Compare the measurements with the tires on the opposite side. If pulling is noted during braking only, check and adjust the brakes as necessary and recheck operation (see Section 2).

5. Increase the air pressure in the tires with the smallest circumference measurement until all tires are equal in circumference.
6. Repeat steps 4-5 as necessary to ensure proper handling.

Troubleshooting

Problem: Suspension too soft	
Condition	Remedy
<ol style="list-style-type: none"> 1. Spring(s) weak 2. Shock absorber damaged 3. Shock absorber preload too low 	<ol style="list-style-type: none"> 1. Replace spring(s) 2. Replace shock absorber 3. Adjust shock absorber preload
Problem: Suspension too stiff	
Condition	Remedy
<ol style="list-style-type: none"> 1. A-arm-related bushings worn 2. Shock absorber preload too high 	<ol style="list-style-type: none"> 1. Replace bushing 2. Adjust shock absorber preload
Problem: Suspension noisy	
Condition	Remedy
<ol style="list-style-type: none"> 1. Cap screws (suspension system) loose 2. A-arm-related bushings worn 	<ol style="list-style-type: none"> 1. Tighten cap screws 2. Replace bushings
Problem: Rear wheel oscillation	
Condition	Remedy
<ol style="list-style-type: none"> 1. Rear wheel hub bearings worn - loose 2. Tires defective - incorrect 3. Wheel rim distorted 4. Wheel hub cap screws loose 5. Auxiliary brake adjusted incorrectly 6. Rear suspension arm-related bushing worn 7. Rear shock absorber damaged 8. Rear suspension arm nut loose 	<ol style="list-style-type: none"> 1. Replace bearings 2. Replace tires 3. Replace rim 4. Tighten cap screws 5. Adjust brake 6. Replace bushing 7. Replace shock absorber 8. Tighten nut

SECTION 8 - STEERING/FRAME

TABLE OF CONTENTS

Steering/Frame.....	8-2
Steering Post/Tie Rods	8-2
Handlebar Grip.....	8-3
Steering Knuckles	8-4
Measuring/Adjusting Toe-In.....	8-5
Front Rack.....	8-6
Front Bumper Assembly	8-6
Front Body Panel/Fender.....	8-7
Exhaust System	8-8
Rear Body Panel/Rack	8-9
Troubleshooting	8-11

Steering/Frame

■NOTE: Critical torque specifications are located in Section 1.

Steering Post/Tie Rods

REMOVING

1. Remove the front body panel/fender (see Front Body Panel/Fender in this section).
2. Remove the steering post cover; then remove the cap screws securing the handlebar caps and move the handlebar out of the way. Account for the two handlebar caps.

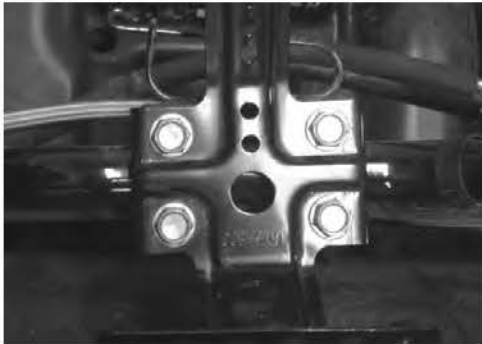

3. Remove the cap screws securing the upper steering post to the frame. Account for the housing cap, outer housing, and inner housing.

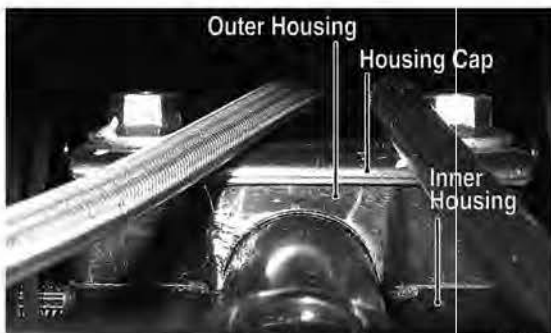

KC307A

4. Remove the cotter pins from the inner tie rod ends; then remove the nuts and disconnect the inner tie rod ends.



KC184A

■NOTE: If tie rods are to be completely removed, remove the outer tie rod ends from the knuckles at this time.

5. Remove the cap screw securing the lower steering post to the bearing. Account for a flat washer.



KC184B

6. Remove the steering post from the ATV.

CLEANING AND INSPECTING

■NOTE: Whenever a part is worn excessively, cracked, or damaged in any way, replacement is necessary.

1. Wash the tie rod ends in parts-cleaning solvent. Dry with compressed air. Inspect the pivot area for wear. Apply a low-temperature grease to the ends.

⚠ WARNING

Always wear safety glasses when using compressed air.

2. Inspect the tie rods for damaged threads or wear.
3. Inspect the tie rods for cracks or unusual bends.
4. Inspect all welded areas for cracks or deterioration.
5. Inspect the steering post and steering-post brackets for cracks, bends, or wear.
6. Inspect the bearing halves, bearing caps, and bearing housings for cracks or wear.

7. Inspect the handlebar tube for cracks, wear, or unusual bends.
8. Inspect the handlebar grips for damage or wear.

INSTALLING

1. Install the steering post into the frame and secure the lower end in the bearing with a flat washer and cap screw. Tighten to 40 ft-lb.



KC184B

2. Apply grease to the inner and outer housings of the upper steering post support; then with the housing cap in place, secure with the cap screws. Tighten to 20 ft-lb.

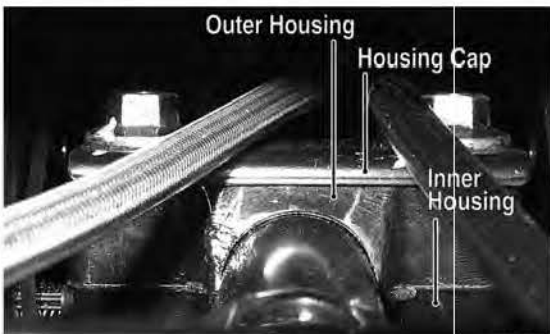

KC307A

3. Using red Loctite #271 on the threads, install the tie rod ends into the lower steering post arm and tighten to 30 ft-lb; then install new cotter pins.



KC184A

4. Place the handlebar and caps in place on the steering post and with the handlebar correctly positioned, tighten the cap screws to 20 ft-lb.

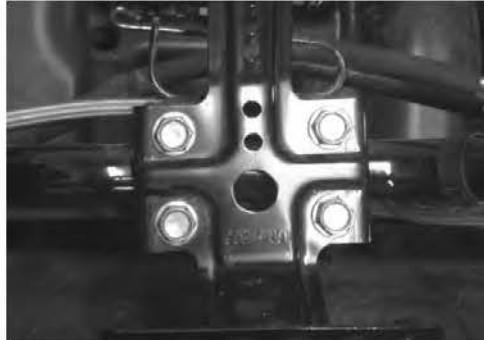

5. Install the steering post cover; then install the front body panel/fender (see Front Body Panel/Fender in this section).

Handlebar Grip

REMOVING

1. Loosen but do not remove the cap screws in the end of the handlebar; then tap lightly on the head to dislodge the handlebar plug.



KC310

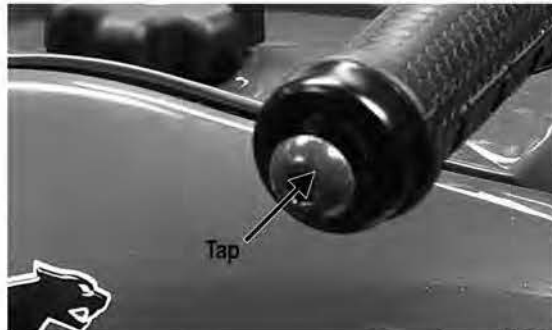

KC309A

2. Grasp the end and remove the cap screw, plug, and end cap.



KC308

3. Using a sharp utility knife, split the handlebar grip from end to end and peel off the rubber.
4. Using an adhesive solvent, clean all glue residue from the handlebar.

INSTALLING

1. Apply a liberal amount of Handlebar Grip Adhesive to the inside of the new grip.
2. Slide the grip onto the handlebar until it is fully seated with the smooth part of the grip facing up.
3. Wipe off any excess glue; then secure the grip with the plug, end cap, and cap screw.

Steering Knuckles

REMOVING AND DISASSEMBLING

1. Secure the ATV on a support stand to elevate the wheel; then remove the wheel.

WARNING

Make sure the ATV is solidly supported on the support stand to avoid injury.

2. Remove the wheel cap from the hub; then remove the cotter pin from the nut.
3. Remove the nut securing the hub.
4. Remove the brake caliper.
5. Remove the hub assembly.
6. Remove the cotter pin from the tie rod end and remove the tie rod end from the knuckle.
7. Remove the two cap screws securing the ball joints in the knuckle.
8. Tap the ball joint end out of the knuckle; then remove the knuckle.
9. Remove the snap ring from the knuckle; then remove the bearing.



PR287A



PR288

CAUTION

Use extreme care when removing the bearing. If the bearing is allowed to fall, it will be damaged and will have to be replaced.

CLEANING AND INSPECTING

■ **NOTE:** Whenever a part is worn excessively, cracked, or damaged in any way, replacement is necessary.

1. Clean all knuckle components.
2. Inspect the bearing for pits, gouges, rusting, or premature wear.
3. Inspect the knuckle for cracks, breaks, or porosity.
4. Inspect threads for stripping or damage.

ASSEMBLING AND INSTALLING

1. Install the bearing; then install the snap ring making sure it seats into the knuckle.



PR287A

2. Install the knuckle to the upper and lower ball joints and secure with the two cap screws. Tighten to 35 ft-lb.



KC313A

3. Install the tie rod end and secure with the nut. Tighten to 30 ft-lb; then install a new cotter pin and spread the pin.

■NOTE: During assembling, new cotter pins should be installed.

4. Apply a small amount of grease to the hub splines.
5. Install the hub assembly onto the splines of the shaft.
6. Secure the hub assembly with the nut. Tighten only until snug.



KC305

7. Secure the brake caliper to the knuckle with the patch-lock cap screws. Tighten to 20 ft-lb.



KC283

8. Pump the hand brake lever; then engage the brake lever lock.
9. Secure the hub nut (from step 6) to the shaft. Tighten to 200 ft-lb.
10. Install a new cotter pin and spread the pin to secure the nut.
11. Install the wheel; then using a crisscross pattern, tighten to 40 ft-lb.
12. Remove the ATV from the support stand.

Measuring/ Adjusting Toe-In

1. Thoroughly wash the ATV to remove excess weight (mud, etc.).
2. Refer to the specifications and ensure the tires are properly inflated to the recommended pressure.

■NOTE: Ensure the inflation pressure is correct in the tires or inaccurate measurements can occur.

3. Place the ATV in a level position taking care not to push down or lift up on the front end; then turn the handlebar to the straight ahead position.

■NOTE: When measuring and adjusting, there should be a normal operating load on the ATV (without an operator but with Arctic Cat approved accessories).

4. Measure the distance from the outside edge of each handlebar grip to equal reference points on each side.
5. Adjust the handlebar direction until the two measurements are equal; then secure the handlebar.

■NOTE: Care must be taken not to allow the handlebar to turn while securing it.

■NOTE: The front wheels do not have to be removed to adjust the tie rod. Also, care should be taken not to disturb the handlebar position.

- Using a permanent marker of some type, mark the center of each front tire (at a height parallel to the belly panel).



AF789D

- Measure the distance between the marks (at a height parallel to the belly panel) at the front side; then record the measurement.
- Push the ATV forward until the marks are parallel to the belly panel on the back side; then measure the distance between the marks.
- The difference in the measurements must show 1/8-1/4 in. toe-in (the front measurement 1/8-1/4 in. less than the rear measurement).
- If the difference in the measurements is not within specifications, adjust both tie rods equally until within specifications.

■NOTE: Prior to locking the jam nuts, make sure the ball joints are at the center of their normal range of motion and at the correct angle.

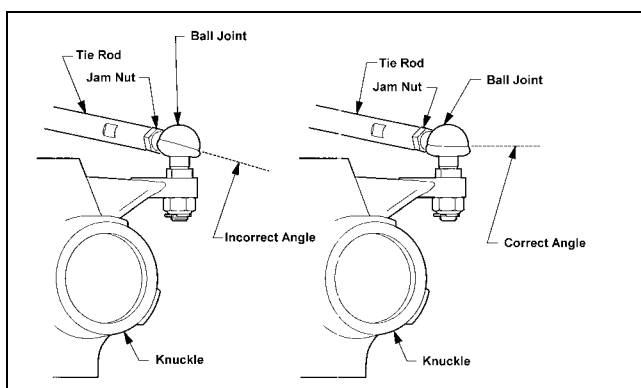

733-559A

Front Rack

REMOVING

- Remove the cap screws and lock nuts securing the rack to the frame and front fender panel.
- Remove the front rack from the ATV.

CLEANING AND INSPECTING

■NOTE: Whenever a part is worn excessively, cracked, or damaged in any way, replacement is necessary.

- Clean all rack components using a pressure washer.
- Inspect all welds for cracking or bending.
- Inspect threaded areas of all mounting bosses for stripping.
- Inspect for missing decals and/or reflectors.

INSTALLING

- Place the rack into position on the frame and front fender panel. Install the cap screws and lock nuts and finger-tighten only.
- Install the two cap screws and lock nuts securing the rack to the fenders. Tighten all hardware securely.

Front Bumper Assembly

REMOVING

- Remove the two front cap screws securing the front rack to the bumper support tubes; then remove two cap screws and nuts securing the bumper support tubes to the frame.
- Remove the through-bolt and lock nut securing the bumper to the frame; then remove the bumper.

CLEANING AND INSPECTING

■NOTE: Whenever a part is worn excessively, cracked, or damaged in any way, replacement is necessary.

- Clean all bumper components with parts-cleaning solvent.
- Inspect all welds for cracking or bending.

INSTALLING

- Place the front bumper assembly into position and install the through-bolt. Start the lock nut and finger-tighten only.
- Install the existing fasteners in the upper support tubes to frame and the front rack cap screws. Tighten the lock nut (from step 1) to 35 ft-lb; then tighten the cap screws securely.

Front Body Panel/Fender

REMOVING

1. Remove the seat and both side panels.
2. Remove the front rack; then disconnect the headlight/running light connectors located on the frame.



4. Remove the shift knob; then remove the shift mechanism splash shield.



5. Remove the screws securing the front body to the front body supports; then remove the left-side and right-side footwell fasteners.



8

3. Remove the cap screws (A); then remove the re-installable rivets (B) and remove the tank cover.

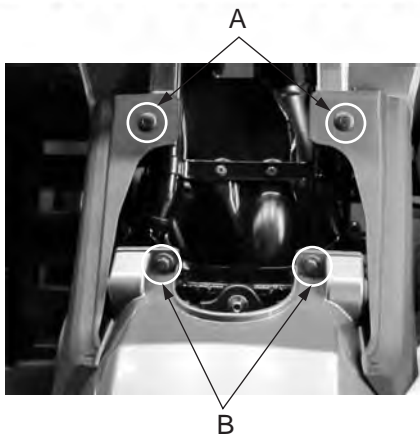

6. Remove the electric panel; then disconnect the LCD gauge connector, ignition switch, and accessory outlet.



LCD Gauge Connector

7. Remove the front body panel/fender panel.

CLEANING AND INSPECTING

■NOTE: Whenever a part is worn excessively, cracked, or damaged in any way, replacement is necessary.

1. Clean all fender components with warm soap and water.
2. Inspect fenders for cracks and/or loose rivets.
3. Inspect for any missing decals.

INSTALLING

1. Making sure the shift spring is in place and the shift lever is properly positioned, place the front body panel/fender panel onto the ATV. With the front rack in place, loosely install the front rack hardware.
2. Connect the electrical connectors under the electric panel; then connect the light connectors and attach onto the frame.



LCD Gauge Connector



3. Install the screws securing the front body to the front body supports; then install the left-side and right-side footwell fasteners. Do not tighten at this time.
4. Place the gas tank cover into position and secure with the existing hardware; then install the two cap screws securing the rear of the panel to the frame. Tighten all cap screws and fasteners securely at this time.
5. Install the electric panel, side panels, and seat.

Exhaust System

REMOVING MUFFLER

1. Remove the two exhaust springs at the muffler/exhaust pipe juncture.



KC170

2. Slide the muffler rearward to clear the mounting lugs and remove the muffler. Account for a grafoil seal.

INSPECTING MUFFLER

■NOTE: Whenever a part is worn excessively, cracked, or damaged in any way, replacement is necessary.

1. Inspect muffler externally for cracks, holes, and dents.

2. Inspect the muffler internally by shaking the muffler back and forth and listening for rattles or loose debris inside the muffler.

■NOTE: For additional details on cleaning the muffler/spark arrester, see Section 2.

INSTALLING MUFFLER

1. Using a new grafoil seal, place the muffler into position engaging the mounting lugs into the grommets; then slide the muffler forward.
2. Install the two exhaust springs.



3. Remove the auxiliary brake reservoir from the body but do not disconnect the hose; then route and secure the hose and reservoir out of the way making sure not to spill brake fluid.

Rear Body Panel/Rack

REMOVING

1. Remove the rear rack; then remove a cap screw securing the rear body panel/fender to the side frame and the cap screws securing the rear fenders to the footwells.



4. Using a small screwdriver, remove the light connectors from the frame; then disconnect both connectors and remove the rear body panel/fender.



8

2. Disconnect the battery (negative cable first) and remove from the battery compartment; then disconnect the starter relay wires and route the wiring out of the compartment.

CLEANING AND INSPECTING

■NOTE: Whenever a part is worn excessively, cracked, or damaged in any way, replacement is necessary.

1. Clean all rear body panel components with warm soap and water.
2. Inspect side panels and rear body panel for cracks and loose rivets.
3. Inspect threaded areas of all mounting bosses for stripping.
4. Inspect for missing decals.

INSTALLING

1. Place the rear body panel/fender in place on the ATV; then secure with the cap screws on the side frame and the rear rack assembly. Tighten all fasteners securely.



2. Connect the light connectors and secure to the frame; then install the battery, starter relay, and auxiliary brake. Connect all wiring making sure to connect the positive cables first.



3. Secure the rear fenders to the footwells and tighten the nuts securely.
4. Install the side panels and seat.

Troubleshooting

Problem: Handling too heavy or stiff	
Condition	Remedy
<ol style="list-style-type: none"> 1. Front wheel alignment incorrect 2. Lubrication inadequate 3. Tire inflation pressure low 4. Tie rod ends seizing 5. Linkage connections seizing 	<ol style="list-style-type: none"> 1. Adjust alignment 2. Lubricate appropriate components 3. Adjust pressure 4. Replace tie rod ends 5. Repair - replace connections
Problem: Steering oscillation	
Condition	Remedy
<ol style="list-style-type: none"> 1. Tires inflated unequally 2. Wheel(s) wobbly 3. Wheel hub cap screw(s) loose - missing 4. Wheel hub bearing worn - damaged 5. Tie rod ends worn - loose 6. Tires defective - incorrect 7. A-arm bushings damaged 8. Bolts - nuts (frame) loose 	<ol style="list-style-type: none"> 1. Adjust pressure 2. Replace wheel(s) 3. Tighten - replace cap screws 4. Replace bearing 5. Replace - tighten tie rod ends 6. Replace tires 7. Replace bushings 8. Tighten bolts - nuts
Problem: Steering pulling to one side	
Condition	Remedy
<ol style="list-style-type: none"> 1. Tires inflated unequally 2. Front wheel alignment incorrect 3. Wheel hub bearings worn - broken 4. Frame distorted 5. Shock absorber defective 	<ol style="list-style-type: none"> 1. Adjust pressure 2. Adjust alignment 3. Replace bearings 4. Repair - replace frame 5. Replace shock absorber
Problem: Tire wear rapid or uneven	
Condition	Remedy
<ol style="list-style-type: none"> 1. Wheel hub bearings worn - loose 2. Front wheel alignment incorrect 3. Tire inflation pressure incorrect 	<ol style="list-style-type: none"> 1. Replace bearings 2. Adjust alignment 3. Adjust pressure
Problem: Steering noise	
Condition	Remedy
<ol style="list-style-type: none"> 1. Cap screws - nuts loose 2. Wheel hub bearings broken - damaged 3. Lubrication inadequate 	<ol style="list-style-type: none"> 1. Tighten cap screws - nuts 2. Replace bearings 3. Lubricate appropriate components

SECTION 9 - CONTROLS/INDICATORS

TABLE OF CONTENTS

Hand Brake Lever/Master Cylinder Assembly 9-2
Throttle Control 9-2
LCD Gauge 9-3

Hand Brake Lever/ Master Cylinder Assembly

■NOTE: The master cylinder is a non-serviceable component; it must be replaced as an assembly.

REMOVING

1. Slide a piece of flexible tubing over one of the wheel bleeder valves and direct the other end into a container. Remove the reservoir cover; then open the bleeder valve. Allow the brake fluid to drain completely.

■NOTE: Compressing the brake lever several times will quicken the draining process.



AF637D

2. Place an absorbent towel around the connection to absorb brake fluid. Remove the banjo-fitting bolt from the master cylinder. Account for two crush washers and a banjo-fitting bolt.

⚠ CAUTION

Brake fluid is highly corrosive. Do not spill brake fluid on any surface of the ATV.

3. Remove the clamp screws securing the brake housing to the handlebar, then remove the assembly from the handlebar.

INSPECTING

■NOTE: Whenever a part is worn excessively, cracked, or damaged in any way, replacement is necessary.

1. Inspect the pin securing the brake lever for wear.
2. Inspect the brake lever for elongation of the pivot hole.
3. Inspect the reservoir for cracks and leakage.

4. Inspect the banjo-fitting and bolt for cracks and deterioration and the condition of the fittings (threaded and compression).

INSTALLING

1. Position the brake housing on the handlebar. Secure with clamp screws; then tighten securely.
2. Using two new crush washers, connect the banjo-fitting to the master cylinder; then secure with the banjo-fitting bolt. Tighten to 20 ft-lb.
3. Bleed the brake system (see Section 2).

Throttle Control

REMOVING

1. Remove the two machine screws securing the throttle control to the handlebar.
2. Slide the grommet out of the lower half of the throttle control; then remove the cable from the actuator arm.

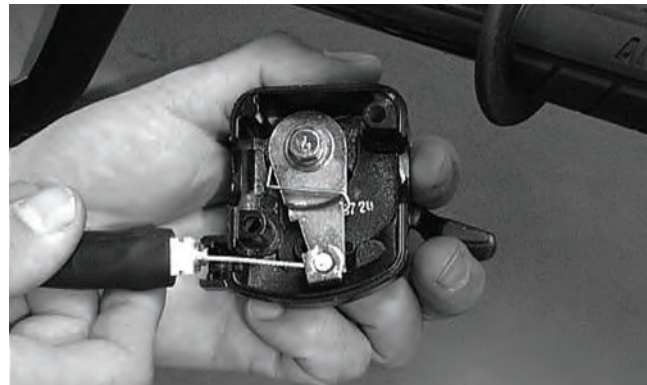

AF676D

3. Remove the cap screw, lock washer, and washer securing the actuator arm to the throttle control lever.

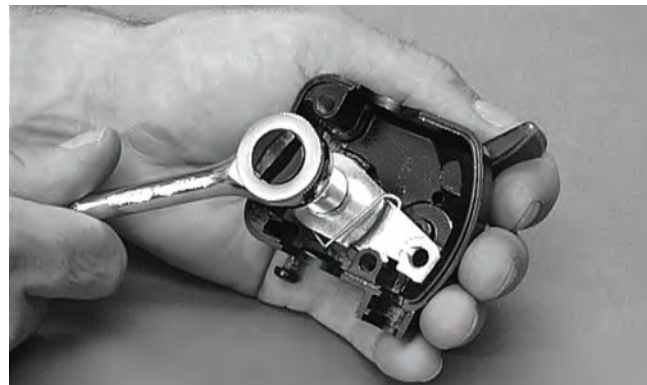

AF677D

4. Remove the actuator arm and account for a bushing. Note the position of the return spring for installing purposes.



AF678D

INSTALLING

1. Place the return spring into the throttle control; then place the bushing and actuator arm into position. Secure with the cap screw, lock washer, and washer.



AF679D

2. Using a pair of needle-nose pliers, place the spring into position on the actuator arm.



AF680D

3. Place the two halves of the throttle control onto the handlebars and secure with the two machine screws.

ADJUSTING

To adjust throttle cable free-play, see Section 2.

LCD Gauge

REPLACING

To replace the LCD gauge, use the following procedure.

1. Remove the electric panel and disconnect the LCD gauge connector; then remove three mounting screws (two in front and one in back of gauge) and remove the gauge.

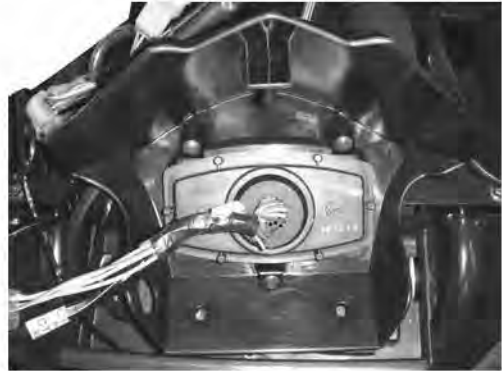

2. Install the new gauge and secure with the mounting screws; then connect the gauge to the main harness and install the electric panel.



9

NOTES

SECTION 10 - COOLING SYSTEM

10

TABLE OF CONTENTS

Radiator.....	10-2
Hoses/Thermostat.....	10-3
Coolant Mixture.....	10-4
Fan/Water Pump.....	10-5

* The coolant level should be checked periodically.

RADIATOR

1. Drain the coolant at the engine.
2. Remove the front bumper and front fender panel (see Section 8).
3. Remove the upper and lower coolant hoses.
4. Remove the cap screws and nuts securing the radiator to the frame.
5. Disconnect the fan wiring from the main wiring harness; then remove the radiator/fan assembly and account for the grommets and collars.
6. Remove the fan/fan shroud assembly from the radiator.



CLEANING AND INSPECTING

* Whenever a part is worn excessively, cracked, or damaged in any way, replacement is necessary.

1. Flush the radiator with water to remove any contaminants.
2. Inspect the radiator for leaks and damage.
3. Inspect all hoses for cracks and deterioration.
4. Inspect all fasteners and grommets for damage or wear.

INSTALLING

1. Position the fan/fan shroud assembly on the radiator; then secure with existing hardware.
2. Place on the radiator with grommets and collars into position on the frame; then install the cap screws and nuts. Tighten securely.
3. Install the upper and lower coolant hoses; then secure with hose clamps.

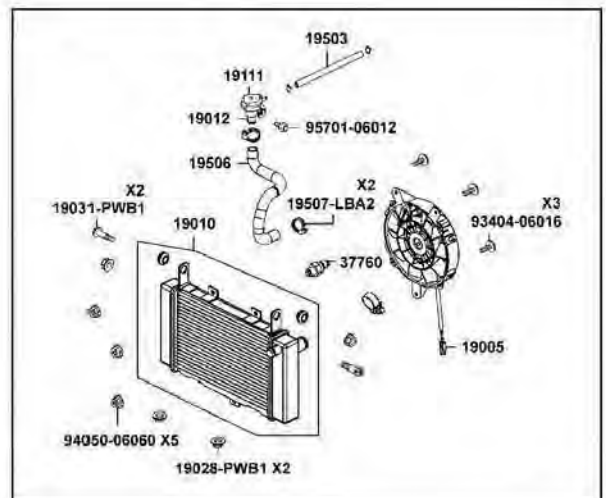

4. Install the front bumper and front fender panel.
5. Fill the cooling system with the recommended amount of antifreeze. Check for leakage.
6. Connect the fan wiring to the main wiring harness.

Standard:

Radiator & hoses **3000cc**
Coolant Reservoir **300cc**

HOSES/THERMOSTAT

REMOVING

1. Drain approximately one quart of coolant from the cooling system.
2. Remove the two cap screws securing the thermostat housing to the cylinder head. Account for an O-ring and a thermostat.

INSPECTING

* Whenever a part is worn excessively, cracked, or damaged in any way, replacement is necessary.

1. Inspect the thermostat for corrosion, wear, or spring damage.
2. Using the following procedure, inspect the thermostat for proper operation.
 - A. Suspend the thermostat in a container filled with water.
 - B. Heat the water and monitor the temperature with a thermometer.
 - C. The thermostat should start to open at 80 – 84 °C (176 – 183 °F), fully open at 95 °C (203 °F).
 - D. If the thermostat does not open, it must be replaced.
3. Inspect all coolant hoses, connections, and clamps for deterioration, cracks and wear.

* All coolant hoses and clamps should be replaced every four years or 4000 miles.

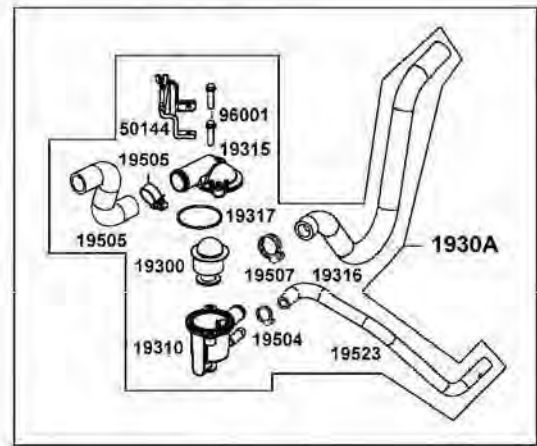

INSTALLING

1. Place the thermostat and O-ring into the thermostat housing; then secure the thermostat housing to the cylinder head with the two cap screws.
2. Install the crossover coolant hose onto the water pump and engine water inlet. Secure with the two hose clamps.
3. Slide the upper hose onto the thermostat housing and radiator. Secure with the two hose clamps.
4. Install the lower coolant hose onto the water pump housing and radiator. Secure with the two hose clamps.
5. Fill the cooling system with the recommended amount of antifreeze. Check for leakage.

COOLANT GRAVITY CHART

Temp. °C Coolant concentration	0	5	10	15	20	25	30	35	40	45	50
5%	1.009	1.009	1.008	1.008	1.007	1.006	1.005	1.003	1.001	0.999	0.997
10%	1.018	1.107	1.017	1.016	1.015	1.014	0.013	1.011	1.009	1.007	1.005
15%	1.028	1.027	1.026	1.025	1.024	1.022	1.020	1.018	1.016	1.014	1.012
20%	1.036	1.035	1.034	1.033	1.031	1.029	1.027	1.025	1.023	1.021	1.019
25%	1.045	1.044	1.043	1.042	1.040	1.038	1.036	1.034	1.031	1.028	1.025
30%	1.053	1.051	1.051	1.049	1.047	1.045	1.043	1.041	1.038	1.035	1.032
35%	1.063	1.062	1.060	1.058	1.056	1.054	1.052	1.049	1.046	1.043	1.040
40%	1.072	1.070	1.068	1.066	1.064	1.062	1.059	1.056	1.053	1.050	1.047
45%	1.080	1.078	1.076	1.074	1.072	1.069	1.056	1.063	1.062	1.057	1.054
50%	1.086	1.084	1.082	1.080	1.077	1.074	1.071	1.068	1.065	1.062	1.059
55%	1.095	1.093	1.091	1.088	1.085	1.082	1.079	1.076	1.073	1.070	1.067
60%	1.100	1.098	1.095	1.092	1.089	1.086	1.083	1.080	1.077	1.074	1.071

COOLANT MIXTURE (WITH ANTI-RUST AND ANTI-FREEZING EFFECTS)

Freezing Point	Mixing Rate	Coolant Concentrate	Distilled water
-9°C	20 %	300 cc	1200 cc
-15°C	30 %	450 cc	1050 cc
-25°C	40 %	600 cc	900 cc
-37°C	50 %	750 cc	750 cc
-44.5°C	55 %	825 cc	675 cc

* Use coolant of specified mixing rate 40% for mass-production.

FAN

REMOVING

1. Remove the radiator. (see Radiator in this section)
2. Remove the fan assembly from the radiator.

INSTALLING

1. Position the fan assembly on the radiator; then secure with existing hardware.

* The fan wiring must be in the upper-right position.

2. Install the radiator.

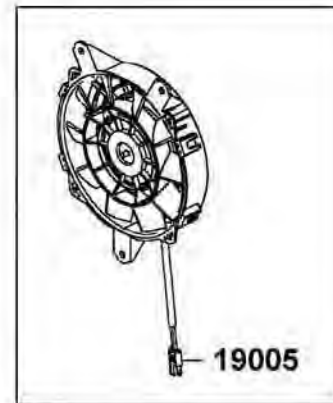

WATER PUMP

1. Drain the coolant.
2. Remove the four cap screws securing the water pump case. Account for the O-ring.
3. Remove the impeller cap screw, washer, and gasket.
4. Remove the mechanical seal using this procedure.
 - A. Tap the tip of a small sheet metal screw into the inner-metal edge of the seal.
 - B. Grip the screw with a pair of vise-grip pliers and pull the seal out. Account for the pump drive seal.

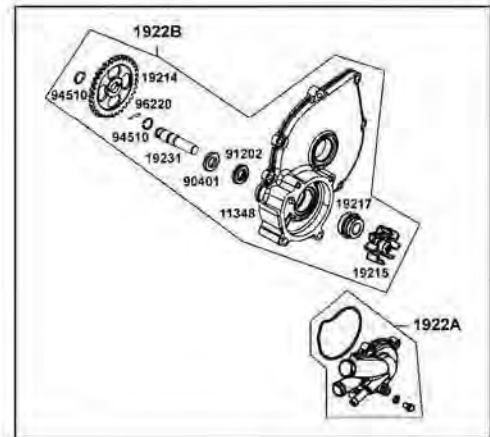

CLEANING AND INSPECTING

* Whenever a part is worn excessively, cracked, or damaged in any way, replacement is necessary.

1. Clean all pump components in solvent.
2. Inspect the mechanical seal and pump drive seal for damage.

* If the mechanical seal and/or pump drive seal are damaged, they must be replaced as a set.

3. Inspect the impeller for corrosion or damage.

ASSEMBLING/INSTALLING

* Treat seals and O-ring with clean anti-freeze for initial lubrication.

1. Press the mechanical seal with pump drive seal into the impeller by hand.
2. Install the mechanical seal assembly onto the water pump shaft and secure with the cap screw, washer, and gasket. Tighten the cap screw securely.
3. Place the washer pump case into position and secure with the four screws.
4. Fill the cooling system with the recommended amount of antifreeze.

* While the cooling system is being filled, air pockets may develop; therefore, run the engine for five minutes after the initial fill, shut the engine off, and then fill the cooling system.

5. Check the entire cooling system for leakage.

FUEL INJECTION SYSTEM

FUEL PUMP/FUEL LEVEL SENSOR -----	11- 2
WATER TEMPERATURE SENSOR -----	11- 5
THROTTLE BODY/T-MAP SENSOR/ISC/TPS -----	11- 6
DIAGNOSTIC TOOL CONNECTOR -----	11- 9
TPS/ISC RESET -----	11-10
ECU -----	11-11
CELP -----	11-13
CELP FAILURE CODES LIST -----	11-15
TILT SWITCH -----	11-17
TROUBLESHOOTING -----	11-18
DIAGNOSTIC REPORT -----	11-19
Fi DIAGOSTIC TOOL OPERATION INSTRUCTIONS -----	11-20

FUEL PUMP/FUEL LEVEL SENSOR

The electric fuel pump and fuel level sensor are not serviceable components. If either component fails, it must be replaced as a set.

TESTING

* Whenever any maintenance or inspection is made on the fuel system during which there may be fuel leakage, there should be no welding, smoking, open flames, etc., in the area.

Prior to removing the electric fuel pump, the following check should be performed to determine that removal is necessary.

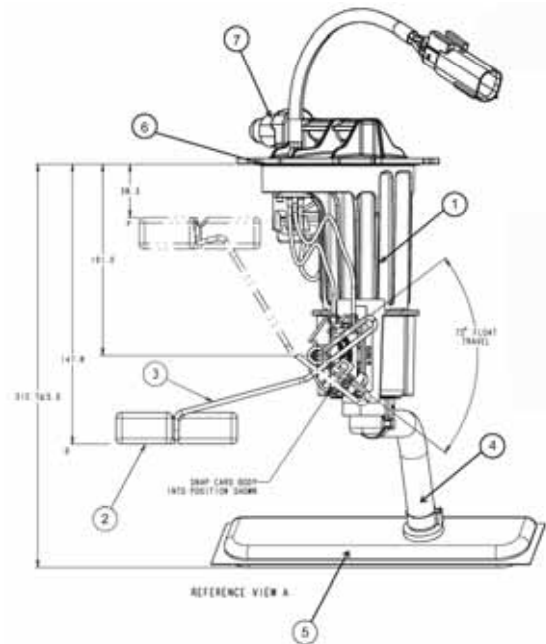

1. Turn the ignition switch ON and listen for a momentary “whirring” sound of the pump building pressure. If the sound is heard (10 seconds), no electrical checks are necessary. Turn the ignition switch OFF.
2. Disconnect the gasoline hose from the throttle body; then install a suitable pressure gauge.

* Gasoline may be under pressure. Place an absorbant towel under the connector to absorb any gasoline spray when disconnecting.

3. Turn the ignition switch to the ON position. The fuel pressure should build until the pump shuts off. Pressure should read **3.0 kg-cm² (43 psi)**.
4. If the pump is not running, disconnect the fuel pump/tank sensor connector.

7	17531-LGC7-E000	CONNECTOR ,FUEL PUMP-90 DEGREE	1				○
6	17556-PTA1-8000	FUEL PUMP SEAL	1				○
5	1670A-PTA1-8000	FUEL FILTER	1				○
4	17564-PTA1-8000	TUBE ,FILTER	1				○
3	37804-PTA1-8000	FLOAT ARM	1				○
2	37803-PTA1-8000	FLOAT	1				○
1	17550-PTA1-8001	PUMP ASSY ,FUEL	1				○
NO	DWG. NO	NAME	QTY	MATERIAL	REMARKS		DWG

5. Connect a multimeter to the power supply leads with the orange/red tester lead to the red wire and the black tester lead to the black wire; then turn the ignition switch to the ON position. The meter should read battery voltage. If battery voltage is indicated and the fuel pump does not run, replace the pump assembly. If no battery voltage is indicated, check the ECU and the vehicle tilt sensor.

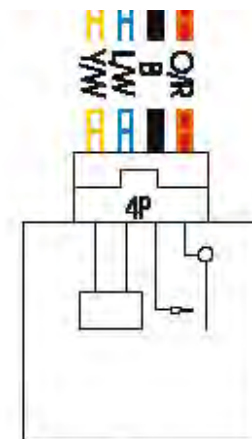

Fuel pump

REMOVING

1. Remove the rear rack and fenders; then disconnect the power supply/fuel pump connector.
2. Remove the spring clamp; then remove the fuel hose.
3. Remove the screws securing the fuel pump to the gas tank; then make a reference mark on the fuel pump and tank.
4. Lift out the fuel pump assembly carefully tilting it forward to clear the voltage regulator; then guide the pump and float lever through the opening in the gas tank.

* Take care not to damage the float or float arm or replacement of the entire assembly will be necessary.



5. Using duct tape or other suitable means, cover the fuel pump opening.

INSPECTING

1. Inspect the fuel screen and blow clean with a lower pressure compressed air.
2. Move the float lever and check for free movement. The float assembly should return to the lower position without force. If not, replace the fuel pump assembly.

3. Test the fuel level sensor by connecting a multimeter (A) to the fuel level sensor leads (B), then select OHMS. The multimeter should show >100 ohms at full fuel position (C) and <2 ohms at empty fuel position (D).



INSTALLING

1. Mark the new fuel pump with a reference mark in the same location as the removed pump; then place the new gasket on the pump.
2. Remove the material covering the fuel pump opening; then carefully guide the fuel pump into position taking care not to damage the float or float lever.
3. Rotate the fuel pump until the match marks align, then install the mounting screws and tighten securely using a fixed pattern.



It is important to install the fuel pump with the correct orientation to ensure adequate float lever clearance.

4. Connect the wires, fuel hose, and spring clamp; then turn the ignition switch to the ON position. Note that the fuel pump runs momentarily and the fuel gauge indicate the proper fuel level.
5. With the transmission in neutral and brake level lock engaged, start the engine and checks for normal operation. Check for any fuel leaks.
6. Install any wire ties that were removed; then install the rear fenders, rack, and seat making sure the seat locks securely.

WTS SENSOR (Water Temperature Sensor)

REMOVAL / INSTALLATION

Drain the coolant from the cooling system.
Disconnect the WTS sensor connector from the sensor.

Remove the WTS sensor and O-ring.

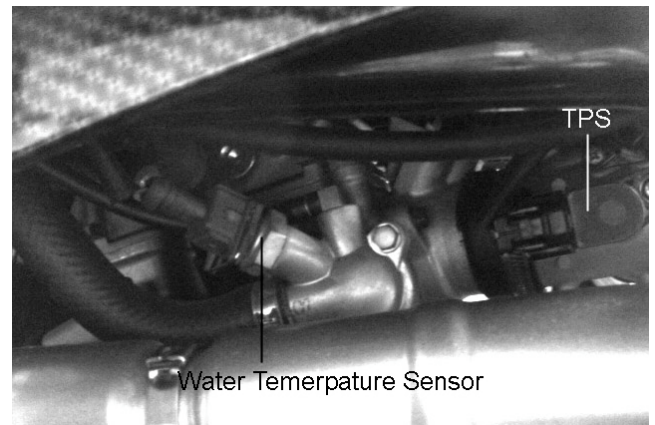

Install a new O-ring and WTS sensor.

* Always replace an O-ring with a new one.

Tighten the WTS sensor to the specified torque.

Torque: 1.2 kgf-m (12 N-m, 8.6 lbf-ft)

Connect the WTS sensor connector.
Fill the cooling system with the recommended coolant.

INSPECTION

Measure the resistance at the WTS sensor terminals.

STANDARD

°C	60	90	120
Ω	703.8±40.9	260.7±15.1	111.1±7.8

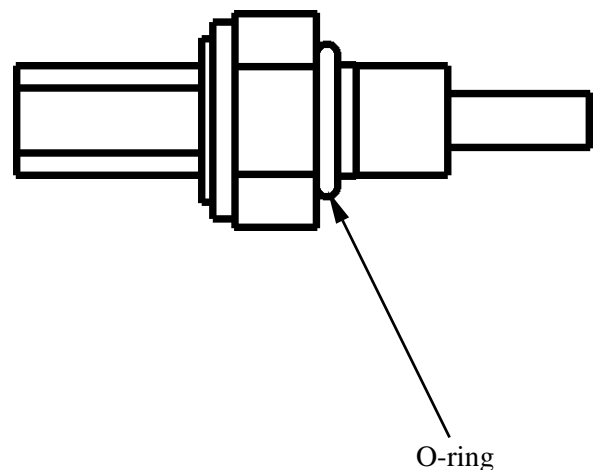

THROTTLE BODY /T-MAP SENSOR/ISC/TPS

- Turn off the ignition switch while replacement.
- Check and confirm if the voltage is over 12V by a voltmeter after replacement.
- Check and confirm if the other connectors are installed correctly after replacement.
- Do not damage the throttle body, it may cause the throttle and idle valve isn't synchronization.
- The throttle body is preset in KYMCO factory, do not disassemble it by a wrong way.
- Do not loosen or tighten the painted bolts and screws for the throttle body. Loosen or tighten them can cause the throttle and idle valve to synchronization failure.
- **TPS and ISC have to be reset after the throttle body T-MAP, TPS, ISC or ECU has been reinstalled.**

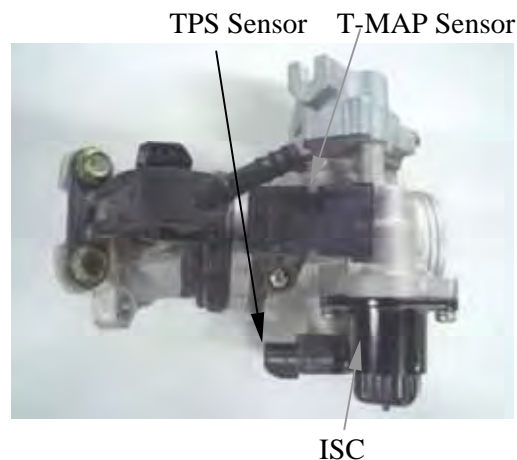

T-MAP SENSOR INSPECTION

Support the scooter on a level surface.
Put the side stand up and engine stop switch is at "RUN".

Turn the ignition switch to "ON" position.

Measure if the ECU voltage outputs to the T-MAP sensor between the following terminals of the MAP connector.

Terminal	Normal
V/R (+) -V/G (-)	5 V

TPS INSPECTION

Support the ATV on a level surface.
 Turn the ignition switch to “ON”.
 Measure if the ECU voltage outputs to TPS between the following terminals of the TPS connector.

Terminal	Normal
V/R (+) -V/G(-)	5 V



Throttle position sensor (TPS) resistance
3500~6500 (at 20°C/68°F)

REMOVAL

Disconnect the throttle cable ends from throttle seat.



Cable Ends

Disconnect the TPS, ISC and T- MAP sensor connectors.
 Loosen the air cleaner connecting hose band screw.
 Loosen the intake manifold band screw.
 Remove the throttle body, T-MAP sensor, TPS sensor and ISC sensor as a set.

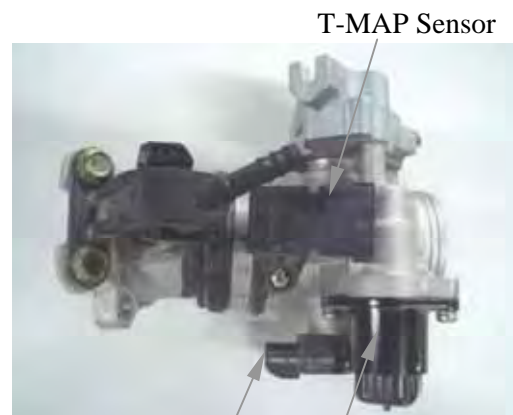

T-MAP Sensor
 TPS Sensor ISC

DISASSEMBLY

Remove the screws and then remove the ISC.
Remove the screw.
Remove the T-MAP sensor.
Remove the screw and then remove the TPS.

ASSEMBLY

*

The throttle position sensor (TPS) and idle air bypass valve (ISC) have to reset when the throttle body T-MAP sensor, TPS, ISC or ECU has been reinstalled.

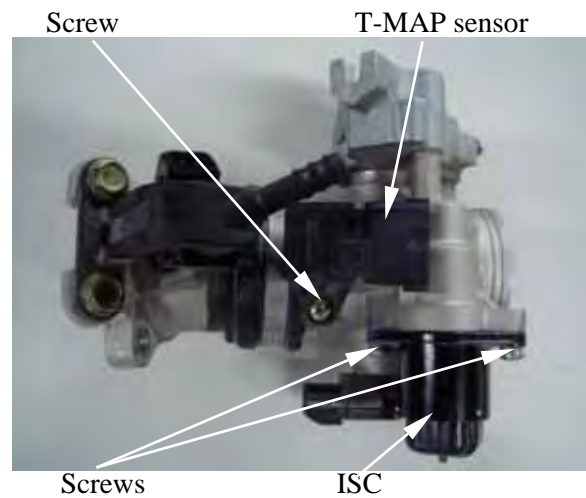

Apply oil onto a new O-ring.
When install the TPS onto the throttle body, being careful not to damage the O-ring.
Install and tighten the screw securely.



Apply oil onto a new O-ring.

When install the T-MAP sensor onto the throttle body, being careful not to damage the O-ring.

* Always replace an O-ring with a new one.

Install the set plate and tighten the screw securely.

Apply oil onto a new O-ring.
When install the ISC and T-MAP sensor onto the throttle body, being careful not to damage the O-ring.

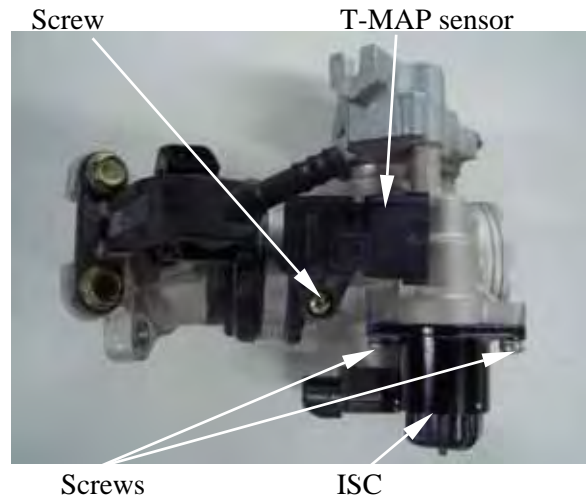

DIAGNOSTIC TOOL CONNECTOR

INSPECTION

- Remove front cover
- Make sure of moving the shift lever into the "N" or "P" position.
- Remove diagnostic tool connector protect sheath.
- Turn the ignition switch to "ON"
- Measure the voltage between the following terminals of the diagnostic tool connector.

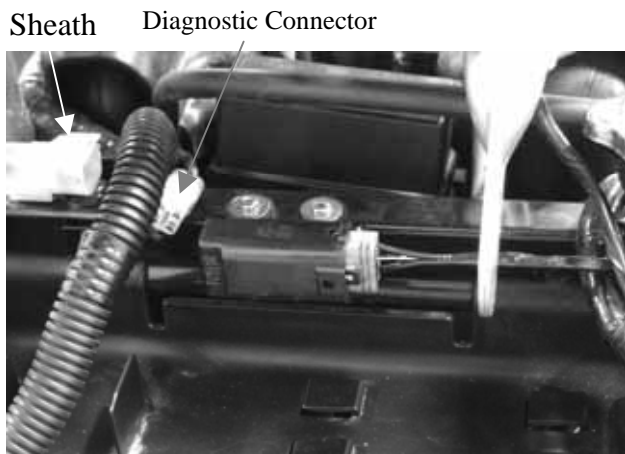

Terminal	Normal
BR/L (+) G/B (-)	Battery voltage
B/L (+) W/L (-)	Battery voltage - 1 V

TPS/ISC RESET

- If close or open the throttle grip randomly, the ECU may record the incorrect TPS when the ECU or the throttle body has been reinstalled. It can cause hard to start engine or idling speed is not smooth when engine installation.
- ISC has a motor inside, which controls ISC valve to obtain smooth idling speed. The ECU may record the incorrect ISC position during the engine speed isn't working when the ECU or the throttle body has been reinstalled. It can cause engine stop, hard to start engine or rough idling speed.

The throttle position sensor (TPS) and idle air bypass valve (ISC) have to be reset when the throttle body, T-MAP, TPS, ISC or ECU has been reinstalled.

TPS/ISC RESET PROCEDURE

Start the engine till engine temperature to 85°C over on idle condition.

ECU will learn engine new condition automatically.

ELECTRIC CONTROL UNIT (ECU)

- *

<ul style="list-style-type: none">• Do not disconnect or connect the ECU connector during the ignition switch "ON"; it may cause the ECU damaged.• The throttle position sensor (TPS) and idle air bypass valve (ISC) have to be reset when throttle body, MAP, TPS,

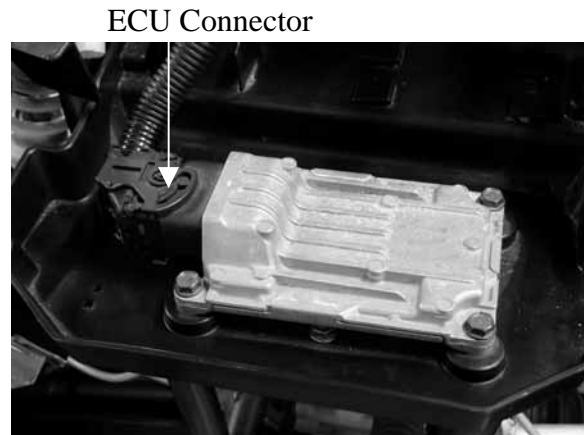

Disconnect the ECU connector and remove the ECU from the frame.

Installation is in the reverse order of the removal.

REMOVAL

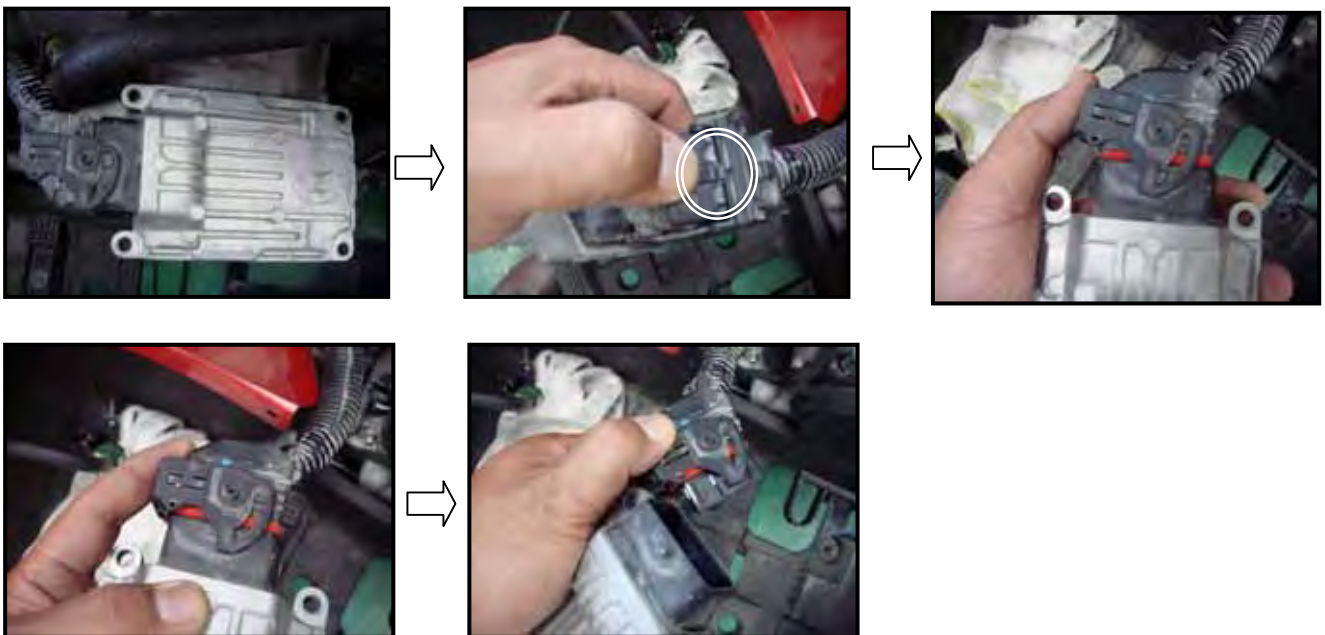

INSTALLATION

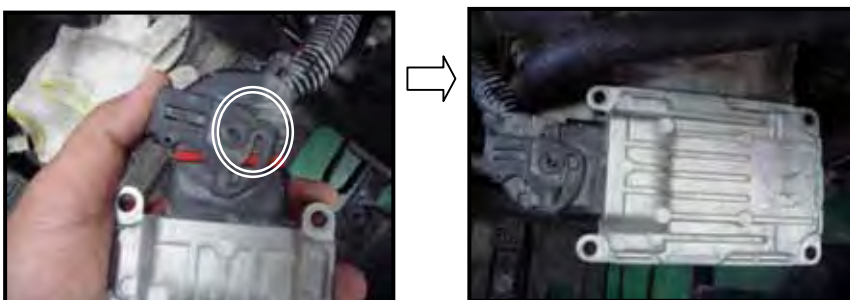

INSPECTION

Outlook checking

Checking for ECU pin(1-48) if has damage.

Checking for ECU part number is as **3920A-LKK7-E00**

Voltage inspection

Connect the meter (+) probe to the B4(R/W)wire and the meter (-) probe to the M3(G/B) wire to measure the voltage.

MAP Edition No.



Page 2 as picture

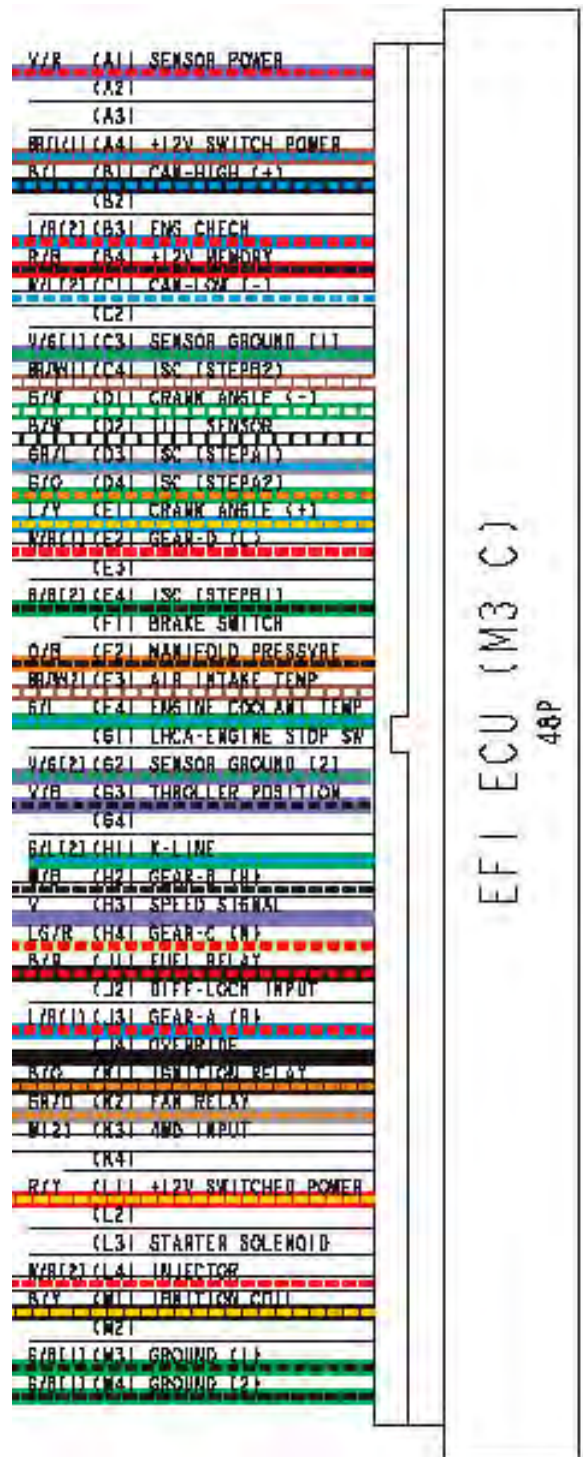

CHECK ENGINE LAMP (CELP)

- When turning on the switch, the lamp will be lighted for 2 seconds then off. Let user to know the lamp is available and connect to ECU.
- But after then or during riding, if the CELP start to blink or keep lighting, it means something wrong with this vehicle, you better do the further check to find out the failure code to know which part get trouble
- There are 3 kinds of priority grade let user to know what kind of trouble was happened.
- Priority grade 1: CELP blinks continuously. This is the most emergent situation like engine over heat. User had better to slow down the riding and go to dealer for checking.
- Priority grade 2: CELP lights all the time. It means components gets trouble or circuit something wrong. Do the further check to find out the failure code to know which part get trouble.
- Priority grade 3: CELP just blinks once suddenly and then disappear. It sometimes just warning like the RPM was too high in a short term.

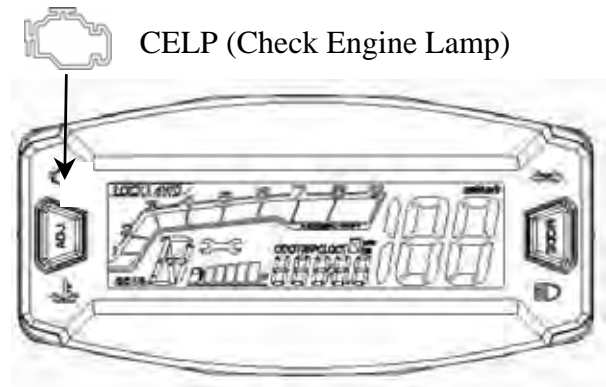

PRIORITY	LAMP ACTION
1	ON 0.3 sec OFF 0.3 sec
2	ON OFF
3	ON OFF

How To Show Failure Code

- You can read the failure code by as below :
- Turn switch on. The CELP will be lighted for 2 seconds then off. The CELP start to blink to show the failure codes
- (The number of blinks from 1 to 22).
- If vehicle got more than one failure code, the CELP will be shown from lower number failure code and then show the other higher number one after four seconds. All the failure codes would be shown repeatedly.

How To Reset Failure Code

- After repairing the trouble, you should clear the failure code or it will still exist in the ECU memory. When you maintain this vehicle next time, it will show again and you get confuse.
- Turn switch on. The CELP will be lighted for two seconds then off.
- The CELP begins to blink to show the failure codes.
- The self-diagnosis memory data will be erased when all the failure codes has showed for 4 cycles.

Example (failure codes 1 and 2):

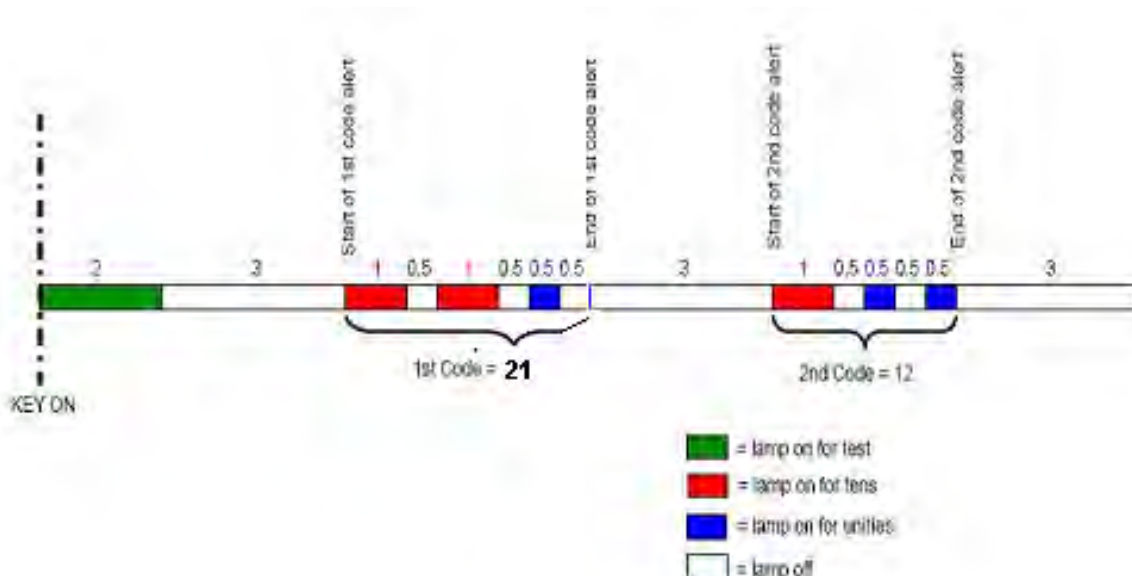

CELP FAILURE CODES LIST

Blink	Failure Codes	Fault description	Priority	Solution
1	P0217	Engine temperature overheat	1	Slow down the vehicle and go to workshop for checking immediately. Confirm if the engine temperature sensor or electric circuit is abnormality.
2	P0335	Crankshaft position sensor or circuit malfunction	2	Check the connector of crankshaft position sensor if is loosen. Check if the Rotor is align to Crankshaft position sensor during the crankshaft running.
3	P1120	Throttle position sensor setting value problem	2	Make sure if the connector of Throttle position sensor is connected correctly. Check if the Throttle position sensor is adjusted.
4	P1121	Throttle position sensor output range problem	2	Make sure if the connector of Throttle position sensor is connected correctly. Check if the Throttle position sensor is adjusted.
5	P1122	Throttle position sensor movement speed problem	2	1.Make sure if the connector of Throttle position sensor is connected correctly. 2.Check if the Throttle position sensor is adjusted.
6	P0560	Battery voltage malfunction	1	1. Check if the battery voltage is lower or higher. 2.Check if the charge system is malfunction.
7	P0110	Intake air temperature circuit malfunction	2	Inlet air temperature sensor or electric circuit malfunction
8	P0410	Idle air valve circuit malfunction	2	Check if the connector of Idle air valve is loosen. Check if the resistance of valve is normal.
9	P0505	Idle speed volume control range problem	3	Check if the ISC steps range over 65steps.
10	P0251	Injector or electric circuit problem	2	Check if the connector of Injector is loosen. Check if the ECU is signal to Injector. Check if the power source and resistance of Injector are malfunction.

Blink	Failure Codes	Fault description	Priority	Solution
11	P0350	Ignition coil or electric circuit malfunction	2	Check if the connector of ignition coil is loosen. Check if the ECU is signaled to Ignition coil. Check if the power source and resistance is malfunction
12	P0230	Fuel pump relay or electric circuit malfunction	2	Check if the connector of relay is loosen. Check if the ECU is signaled to relay. Check the fuel pump relay resistance
13	P0219	Engine speed is over than top speed	2	Check if the belt of CVT is broken.
14	P1560	Sensor don't receive power source from ECU	2	Check if ECU output DC5V to sensor. Check if the power source of all sensor is DC5V. Replace a new ECU if the CELP still blinks even the output power source of ECU is normal.
15	P0700	Engine starting speed exceed CVT speed limited	2	Don't use it at present.
16	P0115	Engine temperature sensor or electric circuit malfunction	2	Check if the connector of sensor is loosen. Check if ECU pin is broken. 3.Check if the resistance of sensor is malfunction.
17	P1561	Temperature gauge electric circuit malfunction	2	Not available
18	P0650	CELP electric circuit malfunction	3	Check if the lamp of CELP is broken. Check if the wires of CELP are broken.
21	P0105	Atmospheric Pressure Sensor/Circuit Malfunction	2	Check if the connector of sensor is loosen. Check if ECU pin is broken. Check if voltage of sensor is fit in specification.
22	P0110	Roll sensor or electric circuit malfunction	2	Check if the sensor installation direction is correct. Check if voltage of sensor is fit in specification. Check if ECU pin is broken.

TILT SWITCH(ROLL SENSOR) INSPECTION

Support the ATV level surface.

Turn the ignition switch to “OFF”

Remove the screws, washers and tilt switch.

* Do not disconnect the tilt switch connector during inspection.

Place the tilt switch vertical as shown, and turn the ignition switch to “ON”.

Measure the voltage between the following terminals of the tilt switch connector with the connector connected.

Terminal	Normal
V/R (+) -G(-)	5 V (ECU voltage)
B/W (+) - G(-)	0.4 1.4 V

Incline the tilt switch 65 ± 10 degrees to the left or right with the ignition switch turned to “ON”.

Measure the voltage between the following terminals of the tilt switch connector with the connector connected.

Terminal	Normal
V/R (+) - G (-)	5 V (ECU voltage)
B/W (+) - G(-)	3.7 4.4 V

If repeat this test, first turn the ignition switch to “OFF”, then turn the ignition switch to “ON”.

REMOVAL/INSTALLATION

Disconnect the connector and remove two screws.

Remove the Tilt switch.

Installation is in the reverse order of removal.

* Install the tilt switch with its “UP” mark facing up.

Tighten the mounting screws securely.

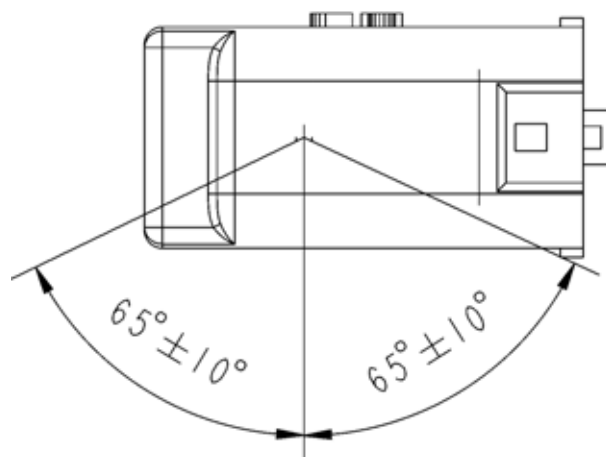
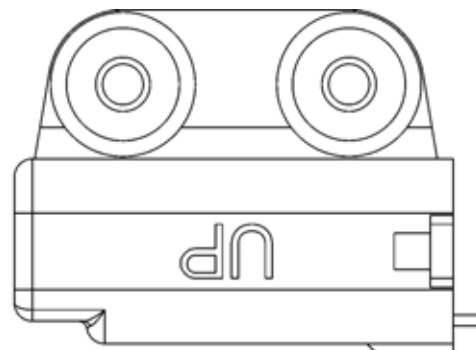

Roll Sensor

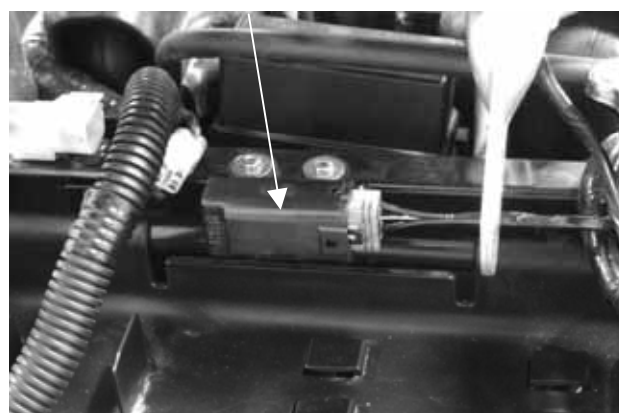

10. LIQUID COOLING SYSTEM

TROUBLESHOOTING

Engine won't start

- Battery voltage too low
- Fuel level too low
- Pinched or clogged fuel hose
- Faulty fuel pump operating system

- Clogged fuel injector
- Faulty spark plug or wrong type
- Clogged Airflow Bypass Valve
- Wet spark plug

Backfiring or misfiring during acceleration

- Ignition system malfunction

Poor performance (drive ability) and poor fuel economy

- Pinched or clogged fuel hose
- Faulty fuel injector

Engine stall, hard to start, rough idling

- Intake air leak
- Fuel contaminated/deteriorated
- Pinched or clogged fuel hose
- Idle speed miss adjusted
- Wet spark plug

11. EFI SYSTEM

Diagnostic Report



KYMCO Diagnostic Report

LKK7

 SF :
 Production
 Date :

 Customer :
 Service
 Date :

 Eng. No:
 Mileage :

Reason of repair: <input type="checkbox"/> maintenance <input type="checkbox"/> breakdown				
Item		Date	Reference	Memo
ECU Version	ECU No		---	
	Hardware Ver		---	
	Software Ver		QK120010	
	Identification Marking		A4LKK7QKAA	
(Cool Engine) Engine Stop	Idle adapted voltage (V)		0.67±0.05 V	
	TPS Opening(%)		0° / > 90°	Throttle closed / opened fully
	TPS Voltage (V)		0.67V±0.05 / >3.6V	Throttle closed / opened fully
	Engine Temp.(°C)		environ.temp ± 2 °C	
	Air Temp.(°C)		environ.temp ± 2 °C	
	Atom. Pressure(Kpa)		101.3 ± 3 kPa	
	Battery Voltage(V)		>12 V	
(Hot Engine) BeforeRepair	Engine speed (RPM)		1400 ± 100 rpm	
	Intake Pressure(Kpa)		30~40 Kpa	
	Engine Temp.(°C)		> 80°C	
	Air Temp.(°C)		45~65°C	
	Fuel Inject Interval(ms)		2.8 ~ 3.8 ms	
	Ignition Timing (°)		9° ~ 12° BTDC	
	ABV Opening (°)		< 65	
	IDLE CO(%))		1.0 ~ 5.0 %	Engine working temperature: 80 ~ 95°C
(Hot Engine) AfterRepair	Engine speed (RPM)		1400 ± 100 rpm	
	Intake Pressure(Kpa)		30~40 Kpa	
	Engine Temp.(°C)		> 80°C	
	Air Temp.(°C)		45~65°C	
	Fuel Inject Interval(ms)		2.8 ~ 3.8 ms	
	Ignition Timing (°)		9° ~ 12° BTDC	
	ABV Opening (°)		< 65	
	IDLE CO(%))		1.0 ~ 5.0 %	Engine working temperature: 80 ~ 95°C
Repair description			Repair Process	

Report ID=

Report Version : Oct/5/2010



**ATV FI DIAGNOSTIC TOOL
OPERATION INSTRUCTIONS
3620A-LEB2-E00(ENGLISH VERSION)**

Version:V1.0.7

1. FI DIAGNOSTIC TOOL

- This tool is developed by KYMCO and for KYMCO vehicle only.
- Please refer to the specification when serving this vehicle.
- This tool is without battery inside. The power is provided from vehicle.
- This software can be updated with computer for new model through the USB cable. The power required of tool is connected with 12V battery.
- For connection, please connect this tool with the connector of ECU. It's available when turning on the ignition switch.

- The function includes ECU version, model name, data analysis .
 - ECU version: includes model name, ECU number, identifications number and software version.
 - Failure codes: DTC reading, DTC clearing and troubleshooting.
 - Data analysis: For ECU's software inspection.
 - Adjust : The adjust function setting is not allowed

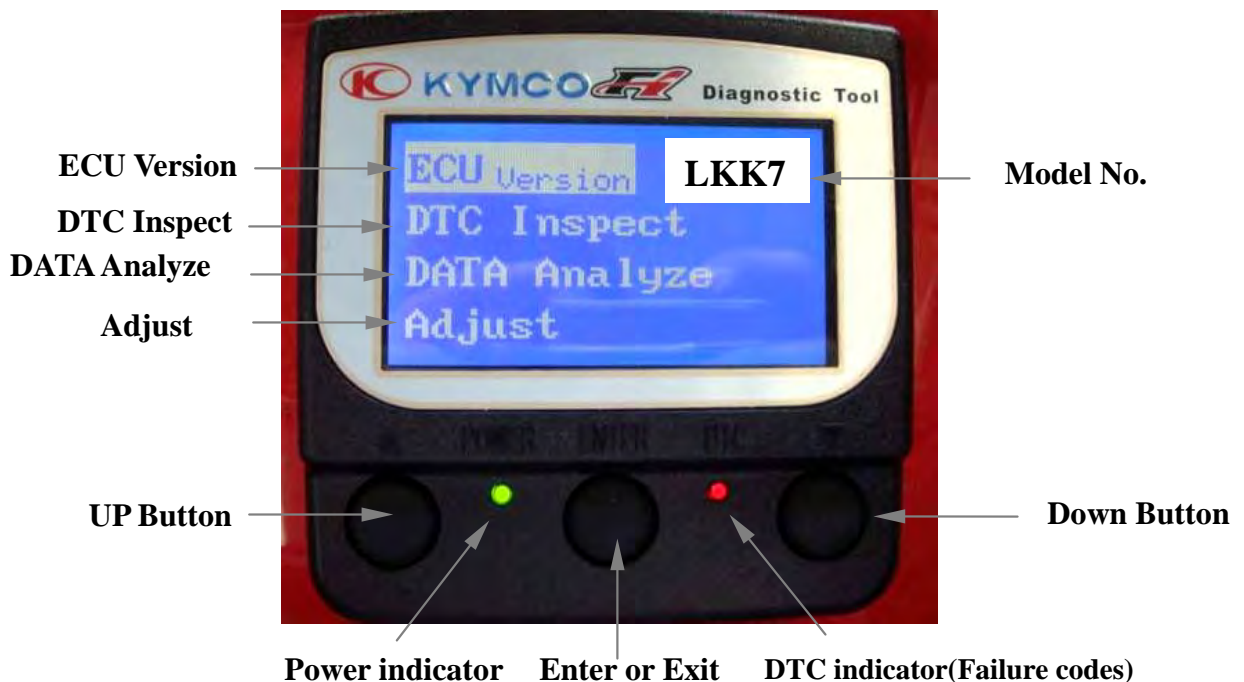

2. DTC INSPECTION PROCEDURE

To Show four functions on the screen when switching on power.



LKK7 is for MXU450i

A). ECU version: Including of model name, ECU number, identifications number and software version. Press the "Enter" button

Press the " Enter " button



LKK7 is for MXU450i

B). Press the " Down " button and then turn to the first page.



C). Press the " Enter " button to check the DTC failure code



D). Press the " Enter " button



E). Press the " Enter " button



F). Display what's DTC number on this DTC-List.

Press the " Enter " button and then turn to the previous page



G). Press the " UP " button



H). Press the " Enter " button and then turn to the previous page .



I). Press the " UP " button



J). Press the " Enter " button and then turn to the first page.



3. DTC CLEAR PROCEDURE

A). Check the DTC



B). Press the " Enter " button



C). Choose " Load DTC "
Press the " Down " button



D). Press the " Enter " button and the indicator is lighting.



E). Clearing DTC completed if the indicator is off.



4. DATA ANALYSIS PROCEDURE

A). Press the " Down " twice



B). Choose " Data Analyze"

Press the " Enter " button to enter page 01



C). Down-page 01

The measure figures including of Engine speed, Battery voltage and Engine speed.

Press the " Down " button to enter page 02.



D). Down-page 02

The measure figures including of TPS position, TPI idle adapted and ISC step .

Press the “ Down” button to enter page 03.



E). Down-page 03

The measure figures including of engine temperature, air temperature and intake pressure. Press the “ Down” button to enter page 04.



F). Down-page 04

The measure figures including of atmosphere temperature, fuel injector interval and ignition advance. Press the “ Down” button to enter page 05.



G). Down-page 05

The measure figures including of gear position and gear ratio.

Press the “ Down” button to enter page 06.



H). Down-page 06

The measure figures including of rollover voltage (**The function setting is not allowed**).

Press the “ Down” button to enter page 07.



I). Down-page 07

The measure figures including of ECU counter.



J). Press the " UP " to the previous page.