

**By KWANG YANG Motor Co., Ltd.
1st Edition, Nov 2008
All rights reserved. Any reproduction or
unauthorized use without the written permission of
KWANG YANG Motor Co., Ltd.
is expressly prohibited.
T100-SR25BA-A1**

PREFACE

This Service Manual describes the technical features and servicing procedures for the **Movie S 125i**.

Section 1 contains the precautions for all operations stated in this manual. Read them carefully before any operation is started.

Section 2 is the removal/installation procedures for the frame covers, which are subject to higher removal/installation frequency during maintenance and servicing operations.

Section 3 describes the inspection/adjustment procedures, safety rules and service information for each part, starting from periodic maintenance.

Sections 5 through 11 give instructions for disassembly, assembly and adjustment of engine parts. Section 12 through 13 is the removal/ installation of chassis. Section 15 through 17 states the testing and measuring methods of electrical equipment.

Most sections start with an assembly or system illustration and troubleshooting for the section. The subsequent pages give detailed procedures for the section.

The information and contents included in this manual may be different from the motorcycle in case specifications are changed.

KWANG YANG MOTOR CO., LTD.
QUALITY TECHNOLOGY DEPT.
EDUCATION SECTION

TABLE OF CONTENTS

ENGINE	GENERAL INFORMATION	1
	EXHAUST MUFFLER/FRAME COVERS	2
	INSPECTION/ADJUSTMENT	3
	LUBRICATION SYSTEM	4
	FUEL INJECTION SYSTEM	5
	ENGINE REMOVAL/INSTALLATION	6
	CYLINDER HEAD/VALVES	7
	CYLINDER/PISTON	8
	DRIVE AND DRIVEN PULLEYS/KICK STARTER	9
	FINAL REDUCTION	10
	CRANKCASE/CRANKSHAFT	11
CHASSIS	STEERING HANDLEBAR/FRONT WHEEL/FRONT BRAKE/FRONT SHOCK ABSORBER/FRONT FORK	12
	REAR BRAKE/REAR FORK/REAR WHEEL/REAR SHOCK ABSORBER	13
ELECTRICAL EQUIPMENT	BATTERY/CHARGING SYSTEM	14
	IGNITION SYSTEM	15
	STARTING SYSTEM	16
	SWITCHES/HORN/FUEL UNIT/ THERMOSTATIC SWITCH/TEMPERATURE GAUGE/INSTRUMENTS/ LIGHTS	17
EVAPORATIVE EMISSION CONTROL SYSTEM		18

ENGINE SERIAL NUMBER-----	1 - 0	TOOLS-----	1-11
SPECIFICATION -----	1 - 1	LUBRICATION POINTS-----	1-12
SERVICE PRECAUTIONS-----	1 - 2	CABLE & HARNESS ROUTING -	1-14
TORQUE VALUES-----	1-10	WIRE DIAGRAM -----	1-19
		TROUBLESHOOTING -----	1-20

ENGINE/FRAME SERIAL NUMBER



1. GENERAL INFORMATION

Movie S 125i

SPECIFICATIONS

Name		Movie S 125i		
Model No.		SR25BA		
Overall length		1920 mm		
Overall width		700 mm		
Overall height		1135 mm		
Wheel base		1284 mm		
Engine type		O.H.C.		
Displacement		124.8cc		
Fuel Used		92# nonleaded gasoline		
Net weight (kg)	Front wheel	41		
	Rear wheel	67		
	Total	108		
Gross weight(kg)	Front wheel	45		
	Rear wheel	73		
	Total	118		
Tires	Front wheel	110/70-12		
	Rear wheel	130/70-12		
Ground clearance		110 mm		
Performance	Braking distance (m)	7.9m(40km/hr)		
	Min. turning radius	1860 mm		
Engine	Starting system		Starting motor & kick starter	
	Type		OHC air cooled 4-cycle	
	Cylinder arrangement		Single cylinder 2V	
	Combustion chamber type		Semi-sphere	
	Valve arrangement		O.H.C.	
	Bore x stroke (mm)		$\varphi 54 \times 54.5$	
	Compression ratio		11	
	Compression pressure (kg/cm ² -rpm)		15-570 rpm	
	Max. output (ps/rpm)		11.8/8500	
	Max. torque (kg m/rpm)		1.04/6500	
	Port timing	Intake (1mm)	Open	8° BTDC
			Close	29° BTDC
		Exhaust (1mm)	Open	32° BTDC
			Close	4° BTDC
	Valve clearance (cold)	Intake	0.12	
		Exhaust	0.12	
	Idle speed (rpm)		1800 rpm	
	Lubrication System	Lubrication type		Forced pressure & wet sump
		Oil pump type		Inner/outer rotor type
		Oil filter type		Full-flow filtration
		Oil capacity		0.9 liter
		Exchanging capacity		0.8 liter
	Cooling Type		Forced air cooling	

Fuel System	Air cleaner type & No		Paper element, wet		
	Fuel capacity		7.3 liters		
Electrical Equip.	Throttle Body	Throttle type		Butterfly type	
		Ignition System	Type		ECU
			Spark plug		NGK CR7HSA
Spark plug gap		0.6~0.7mm			
Power Drive System	Battery	Capacity		12V8AH	
	Clutch	Type		Dry multi-disc clutch	
Transmission Gear		Type		Non-stage transmission	
		Operation		Automatic centrifugal type	
Reduction Gear	Type		Two-stage reduction		
	Reduction ratio	1st	0.86~2.64		
		2nd	7.8		
Moving Device	Front Axle	Caster angle		26.5°	
		Trail length		80 mm	
	Tire pressure (kg/cm ²)	Front	1.75		
		Rear	2.25		
	Turning angle	Left	45°		
Right		45°			
Brake system type		Front	Disk brake		
		Rear	Drum brake		
Damping Device	Suspension type	Front	Telescope		
		Rear	Single Swing		
Frame type		Under bone			

SERVICE PRECAUTIONS

- Make sure to install new gaskets, O-rings, circlips, cotter pins, etc. when reassembling.

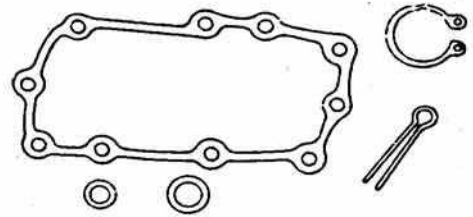

- When tightening bolts or nuts, begin with larger-diameter to smaller ones at several times, and tighten to the specified torque diagonally.

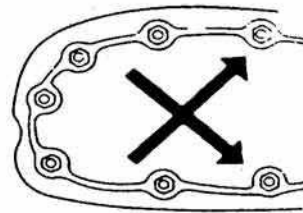

- Use genuine parts and lubricants.

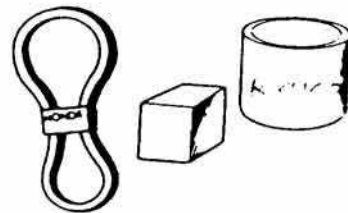

- When servicing the motorcycle, be sure to use special tools for removal and installation.

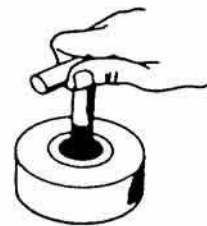

- After disassembly, clean removed parts. Lubricate sliding surfaces with engine oil before reassembly.

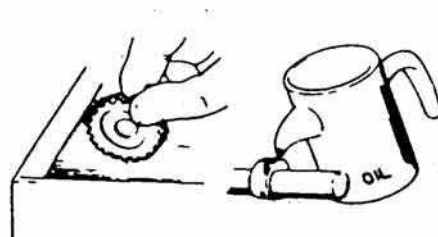

- Apply or add designated greases and lubricants to the specified lubrication points.

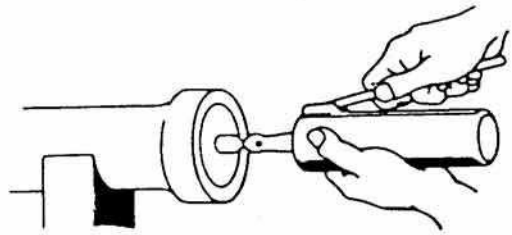

- After reassembly, check all parts for proper tightening and operation.

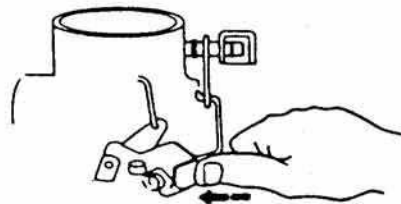

- When two persons work together, pay attention to the mutual working safety.



- Disconnect the battery negative (-) terminal before operation.
- When using a spanner or other tools, make sure not to damage the motorcycle surface.

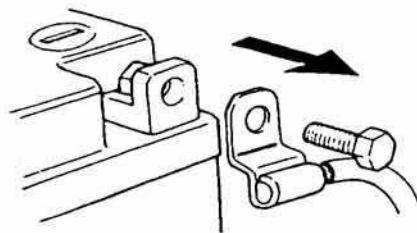

- After operation, check all connecting points, fasteners, and lines for proper connection and installation.
- When connecting the battery, the positive (+) terminal must be connected first.
- After connection, apply grease to the battery terminals.
- Terminal caps shall be installed securely.

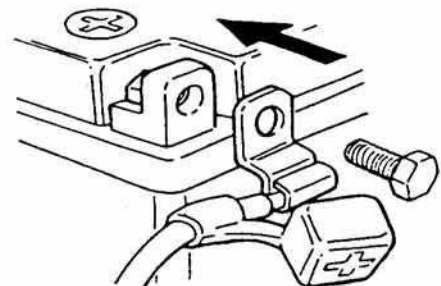

- If the fuse is burned out, find the cause and repair it. Replace it with a new one according to the specified capacity.

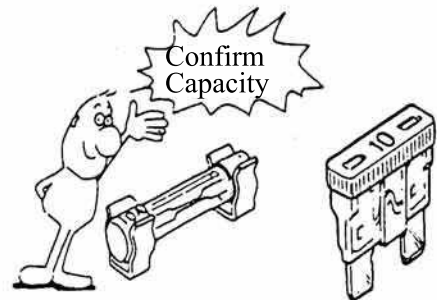

- After operation, terminal caps shall be installed securely.

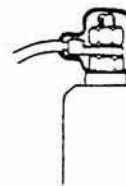

- When taking out the connector, the lock on the connector shall be released before operation.

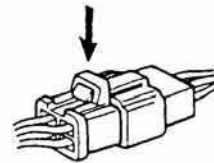

- Hold the connector body when connecting or disconnecting it.
- Do not pull the connector wire.



- Check if any connector terminal is bending, protruding or loose.

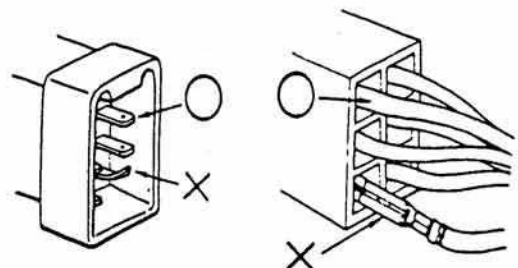

- The connector shall be inserted completely.
- If the double connector has a lock, lock it at the correct position.
- Check if there is any loose wire.

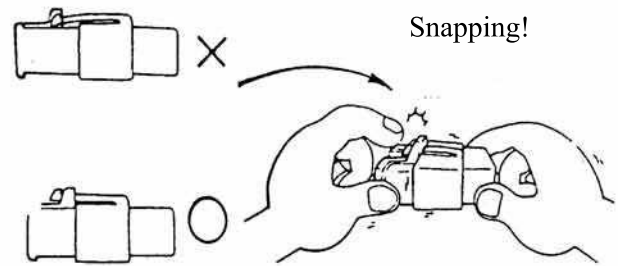

- Before connecting a terminal, check for damaged terminal cover or loose negative terminal.

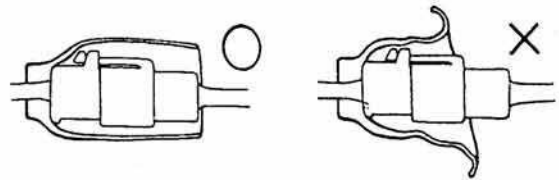

- Check the double connector cover for proper coverage and installation.

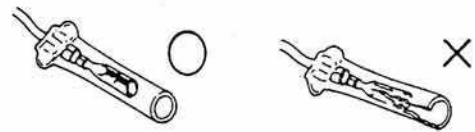

- Insert the terminal completely.
- Check the terminal cover for proper coverage.
- Do not make the terminal cover opening face up.

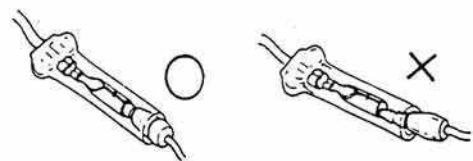

- Secure wire harnesses to the frame with their respective wire bands at the designated locations. Tighten the bands so that only the insulated surfaces contact the wire harnesses.

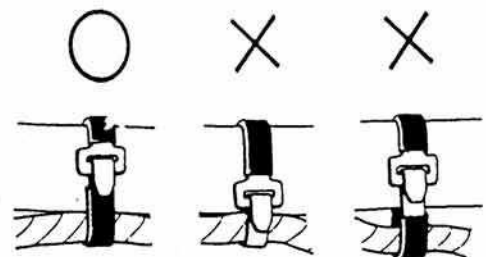

- After clamping, check each wire to make sure it is secure.

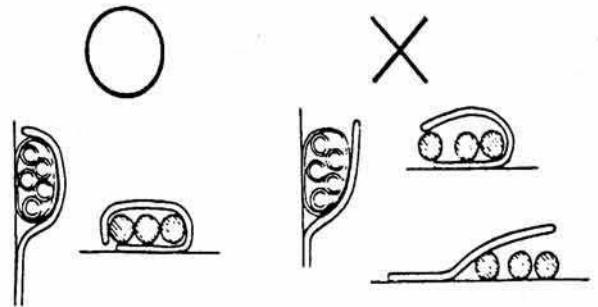

- Do not squeeze wires against the weld or its clamp.

- After clamping, check each harness to make sure that it is not interfering with any moving or sliding parts.



- When fixing the wire harnesses, do not make it contact the parts, which will generate high heat.

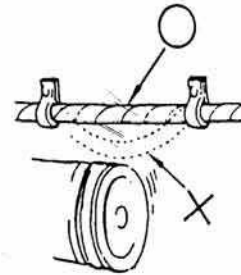

- Route wire harnesses to avoid sharp edges or corners. Avoid the projected ends of bolts and screws.
- Route wire harnesses passing through the side of bolts and screws. Avoid the projected ends of bolts and screws.

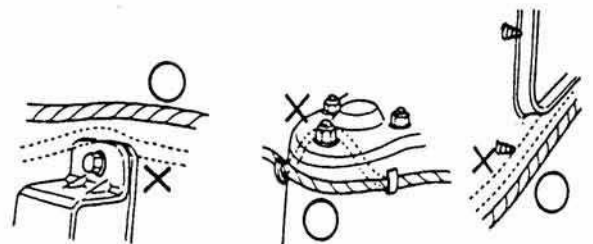
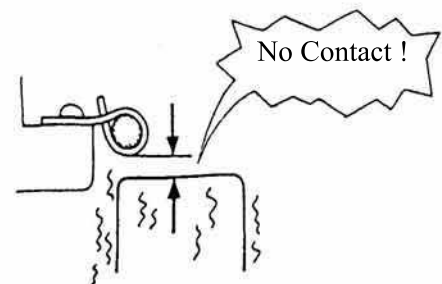

- Route harnesses so they are neither pulled tight nor have excessive slack.

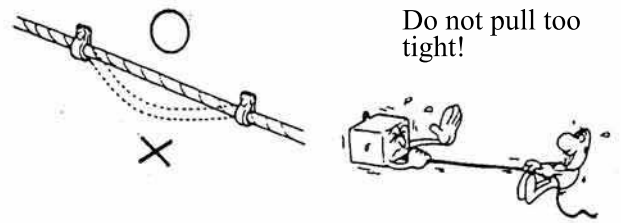

- Protect wires and harnesses with electrical tape or tube if they contact a sharp edge or corner.

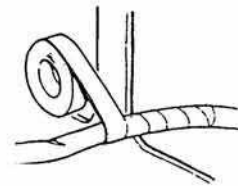

- When rubber protecting cover is used to protect the wire harnesses, it shall be installed securely.

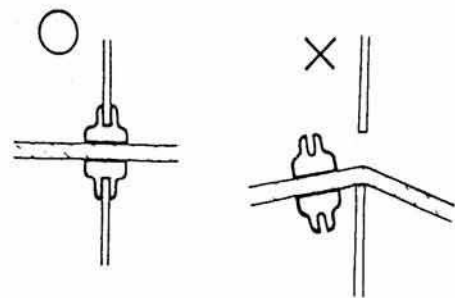

- Do not break the sheath of wire.
- If a wire or harness is with a broken sheath, repair by wrapping it with protective tape or replace it.

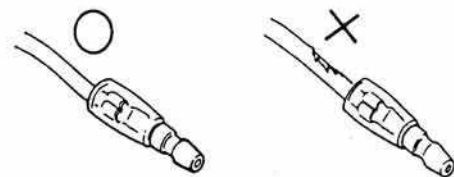

- When installing other parts, do not press or squeeze the wires.

Do not press or squeeze the wire.

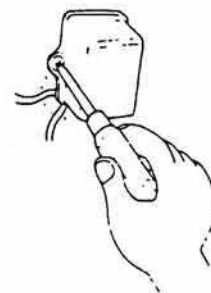

- After routing, check that the wire harnesses are not twisted or kinked.

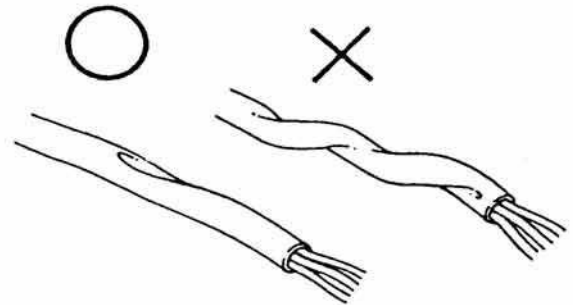

- Wire harnesses routed along with handlebar should not be pulled tight, have excessive slack or interfere with adjacent or surrounding parts in all steering positions.

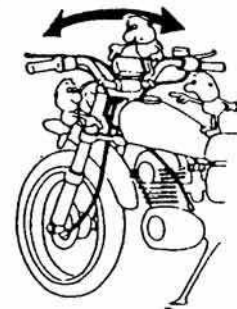

- When a testing device is used, make sure to understand the operating methods thoroughly and operate according to the operating instructions.

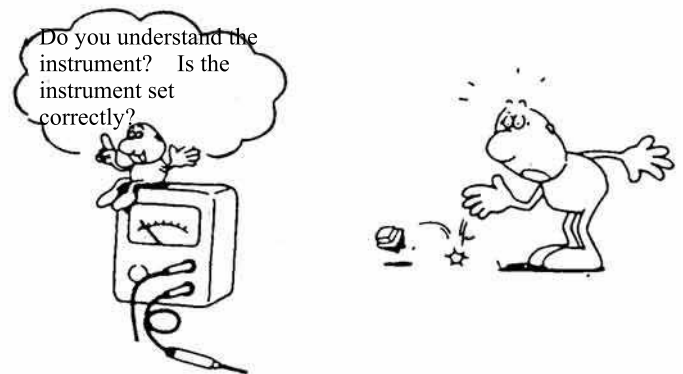

- Be careful not to drop any parts.

- When rust is found on a terminal, remove the rust with a sand papers or equivalent before connecting.

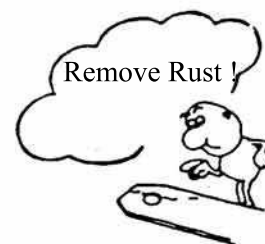

- Do not bend or twist control cables. Damaged control cables will not operate smoothly and may stick or bind.

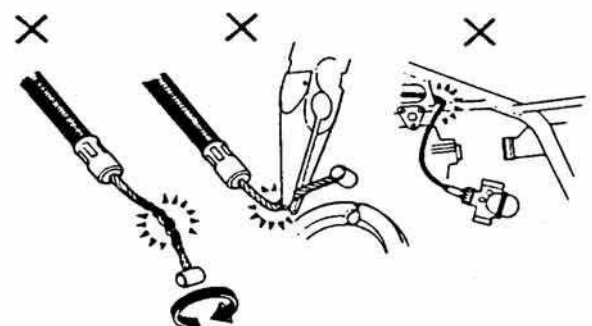

■ Symbols:

The following symbols represent the servicing methods and cautions included in this service manual.



Engine Oil

: Apply engine oil to the specified points. (Use designated engine oil for lubrication.)



Grease

: Apply grease for lubrication.



Gear Oil

: Transmission Gear Oil (90#)



: Use special tool.



: Caution



: Warning

TORQUE VALUES

STANDARD TORQUE VALUES

Item	Torque (kg-m)	Item	Torque (kg-m)
5mm bolt, nut	0.45~0.6	5mm screw	0.35~0.5
6mm bolt, nut		6mm screw, SH bolt	0.7~1.1
8mm bolt, nut	0.8~1.2	6mm flange bolt, nut	1.0~1.4
10mm bolt, nut	1.8~2.5	8mm flange bolt, nut	2.0~3.0
12mm bolt, nut	3.0~4.0	10mm flange bolt, nut	3.5~4.5
	5.0~6.0		

Torque specifications listed below are for important fasteners.

ENGINE

Item	Q'ty	Thread dia.(mm)	Torque (kg-m)	Remarks
Cylinder head bolt A	2	8	0.9	Double end bolt
Cylinder head bolt B	4	8	0.9	
Oil filter screen cap	1	30	1.5	
Exhaust muffler joint lock nut	2	6	0.9	Double end bolt
Cylinder head nut	4	8	2.0	Apply oil to threads
Valve adjusting lock nut	2	5	0.9	
Cam chain tensioner slipper bolt	1	6	1.0	
Oil bolt	1	8	1.3	
Clutch outer nut	1	12	5.5	
Clutch drive plate nut	1	12	5.5	
Drive face seal cover bolt	3	4	0.3	
Starter clutch cap bolt	3	6	1.2	
Drive face nut	1	12	5.5	
Spark plug	1	10	1.2	
Starter clutch lock nut	1	22	9.5	Left hand threads
Cam chain tensioner screw	1	6	0.4	
Engine temperature sensor screw	1	8.8	0.75	
Temperature manifold & pressure sensor screw	1	4	0.25	1/8-27 NPSF

1. GENERAL INFORMATION

Movie S 125i

FRAME

Item	Q'ty	Thread dia.(mm)	Torque (kg-m)	Remarks
Steering stem lock nut	1	10	4.5	U-nut
Front axle nut	1	12	6.0	U-nut
Rear axle nut	1	14	11.0	U-nut
Rear shock absorber upper mount bolt	1	10	4.0	
Rear shock absorber lower mount bolt	1	8	2.5	
Speedometer cable set screw	1	5	0.45	
Front shock absorber tube bolt	1	5	0.45	
Front shock absorber upper mount bolt	2	8	0.1	
Front shock absorber lower mount bolt	2	8	1.8	
Front shock absorber hex bolt	4	8	3.0	
Rear shock absorber lower joint lock nut	1	8	3.5	Apply locking glue

SPECIAL TOOLS

Tool Name	Tool No.	Remarks	Ref. Page
FLYWHEEL PULLER	E002		
TAPPET ADJUSTER	E036		
OIL SEAL & BEARING INSTALL	E014		
FLYWHEEL HOLDER	E021		
BEARING PULLER	E037		
LONG SOCKET WRENCH	F007		
CLUTCH SPRING COMPRESSOR	E034		
CRANKSHAF BEARING PULLER	E030		
LONG SOCKET WRENCH	F001		
RACE CONE INSTALL	F005		

LUBRICATION POINTS

ENGINE

Lubrication Points	Lubricant
Valve guide/valve stem movable part Camshaft protruding surface Valve rocker arm friction surface Camshaft drive chain Cylinder lock bolt and nut Piston surroundings and piston ring grooves Piston pin surroundings Cylinder inside wall Connecting rod/piston pin hole Connecting rod big end Crankshaft Crankshaft one-way clutch movable part Oil pump drive chain Starter reduction gear engaging part Countershaft gear engaging part Final gear engaging part Bearing movable part O-ring face Oil seal lip	•Genuine KYMCO Engine Oil (SAE15W-40) •API SE, SF or SG Engine Oil
Starter idle gear Friction spring movable part/shaft movable part Shaft movable grooved part Starter spindle movable part	High-temperature resistant grease
Starter one-way clutch threads	Thread locking glue
A.C. generator connector Transmission case breather tube	Adhesive

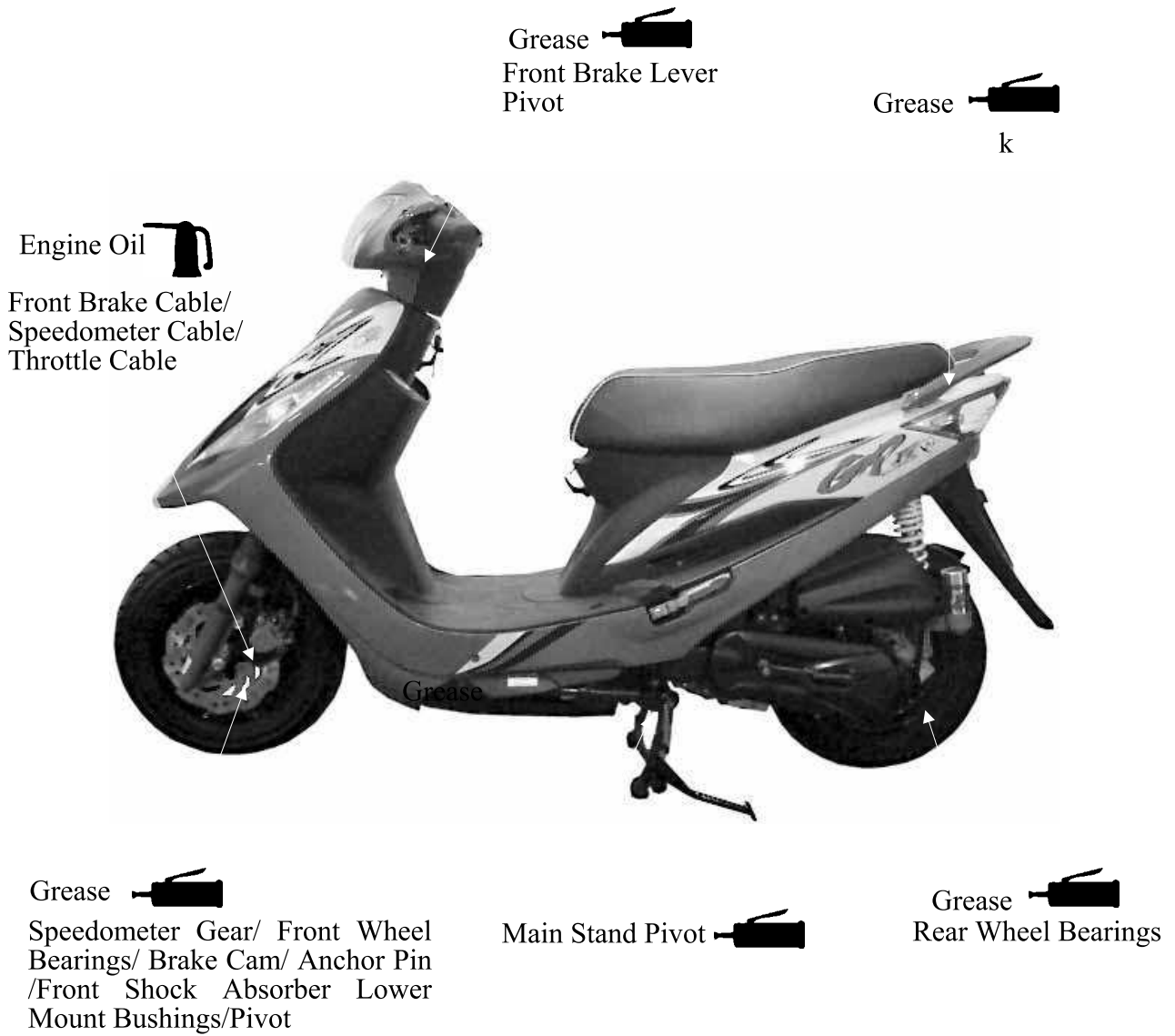

CABLE & HARNESS ROUTING

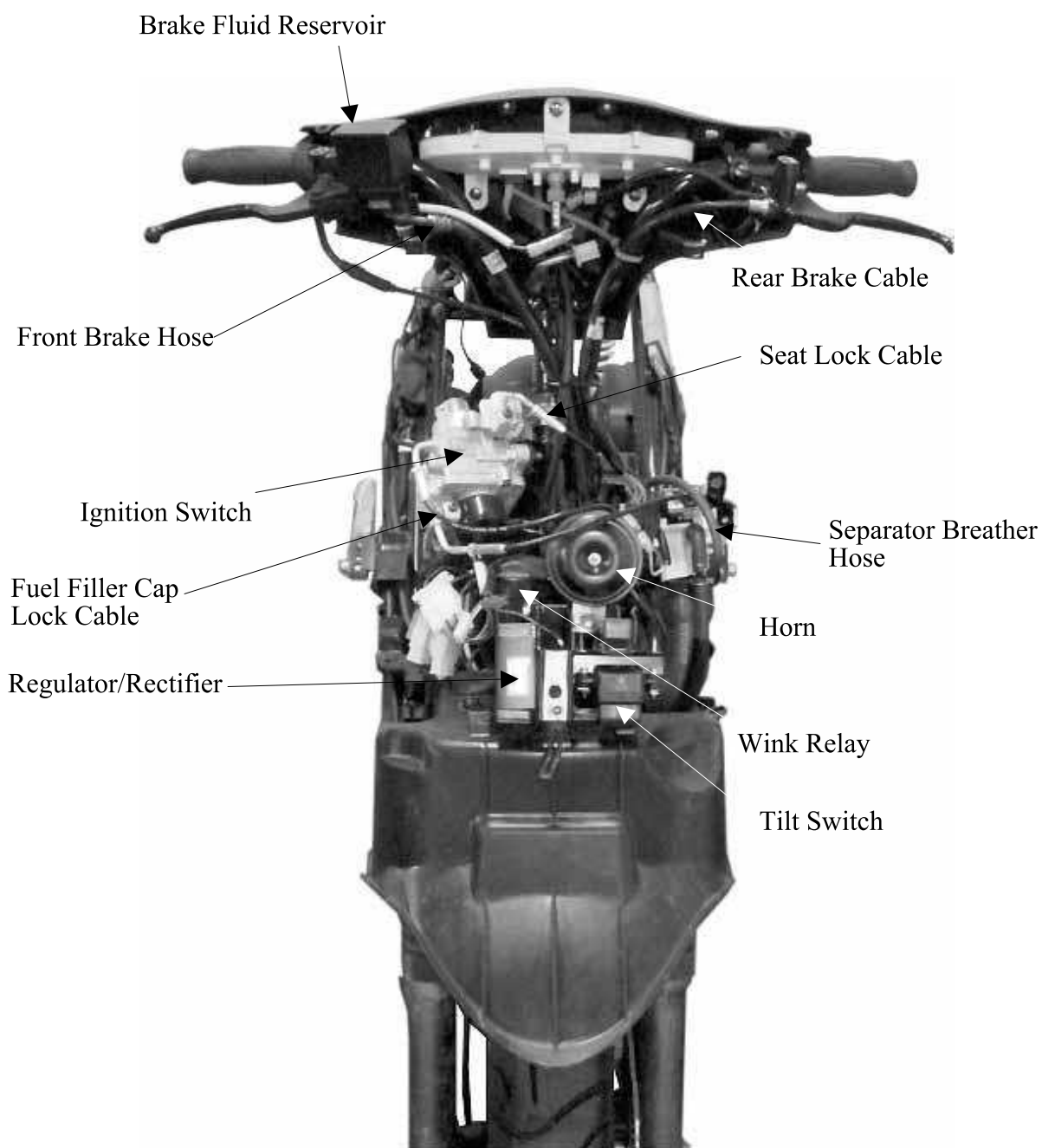

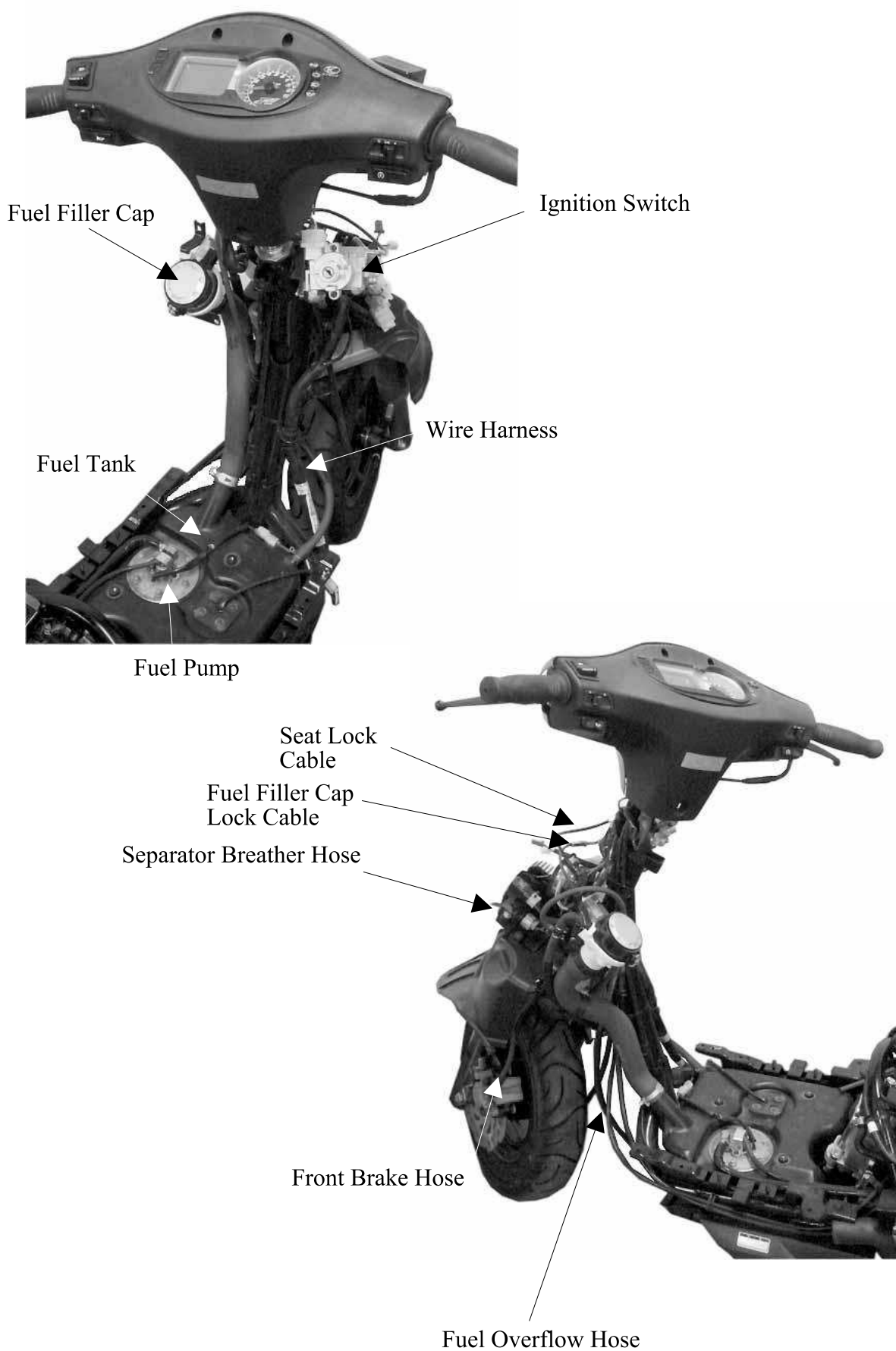

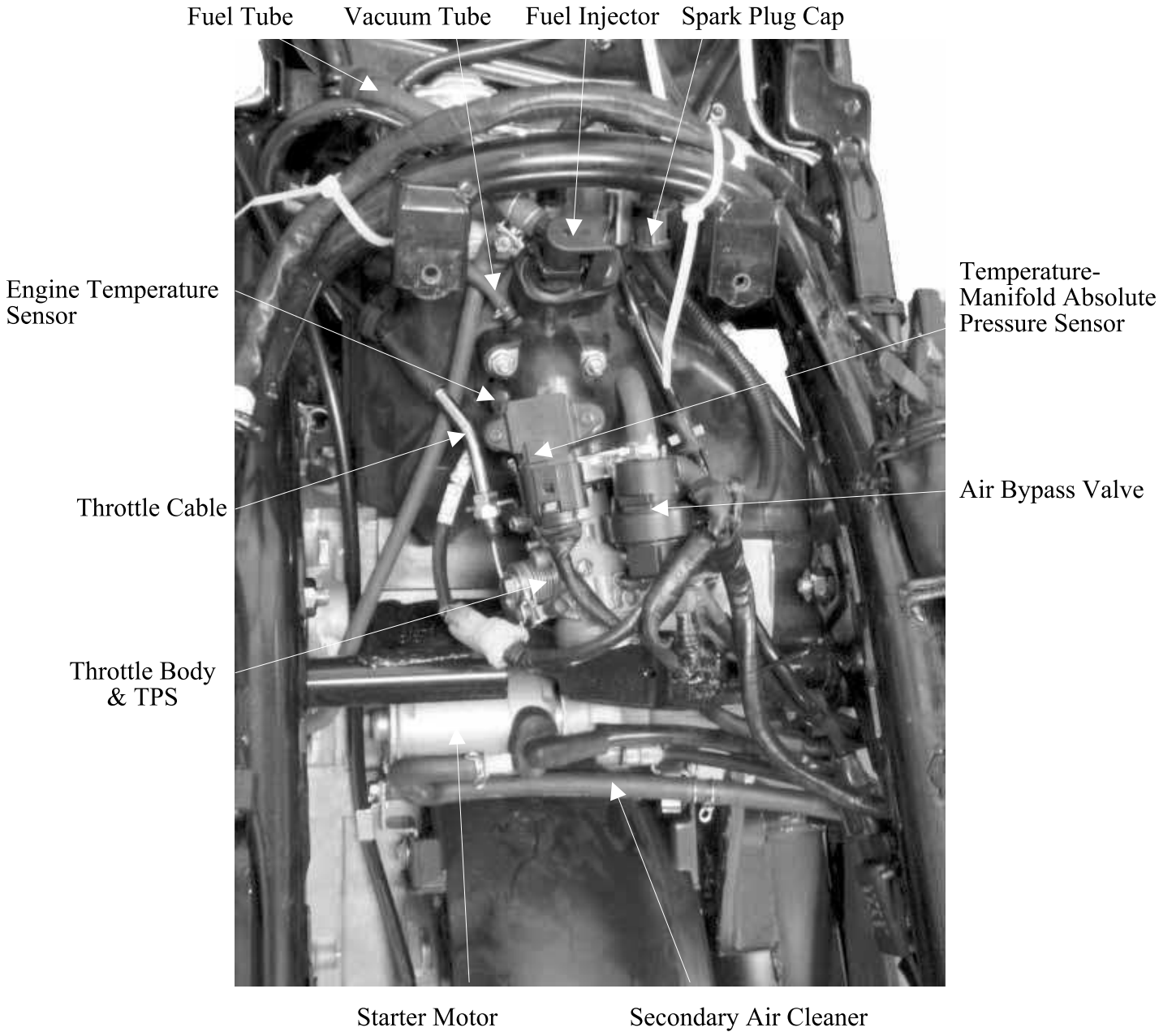

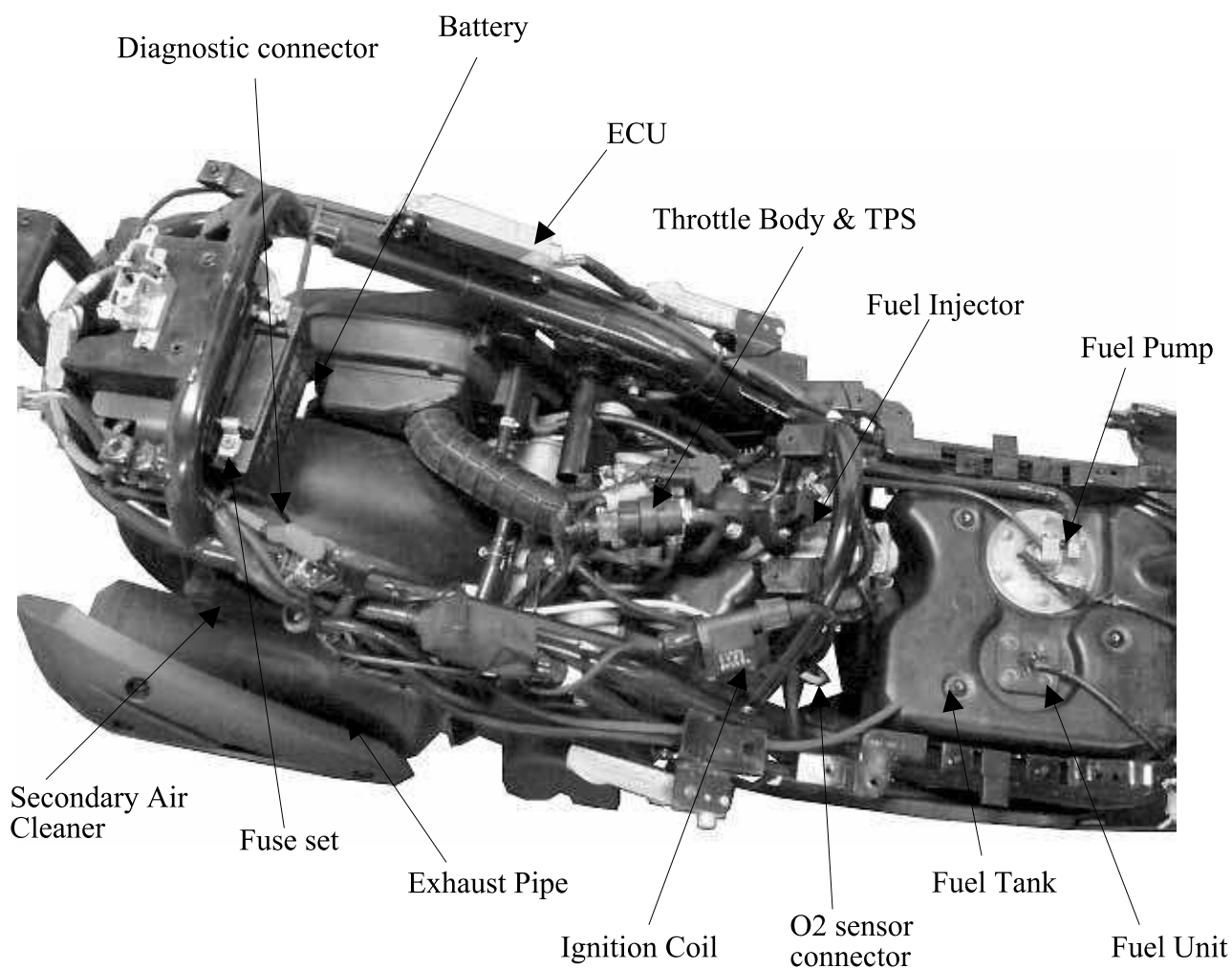

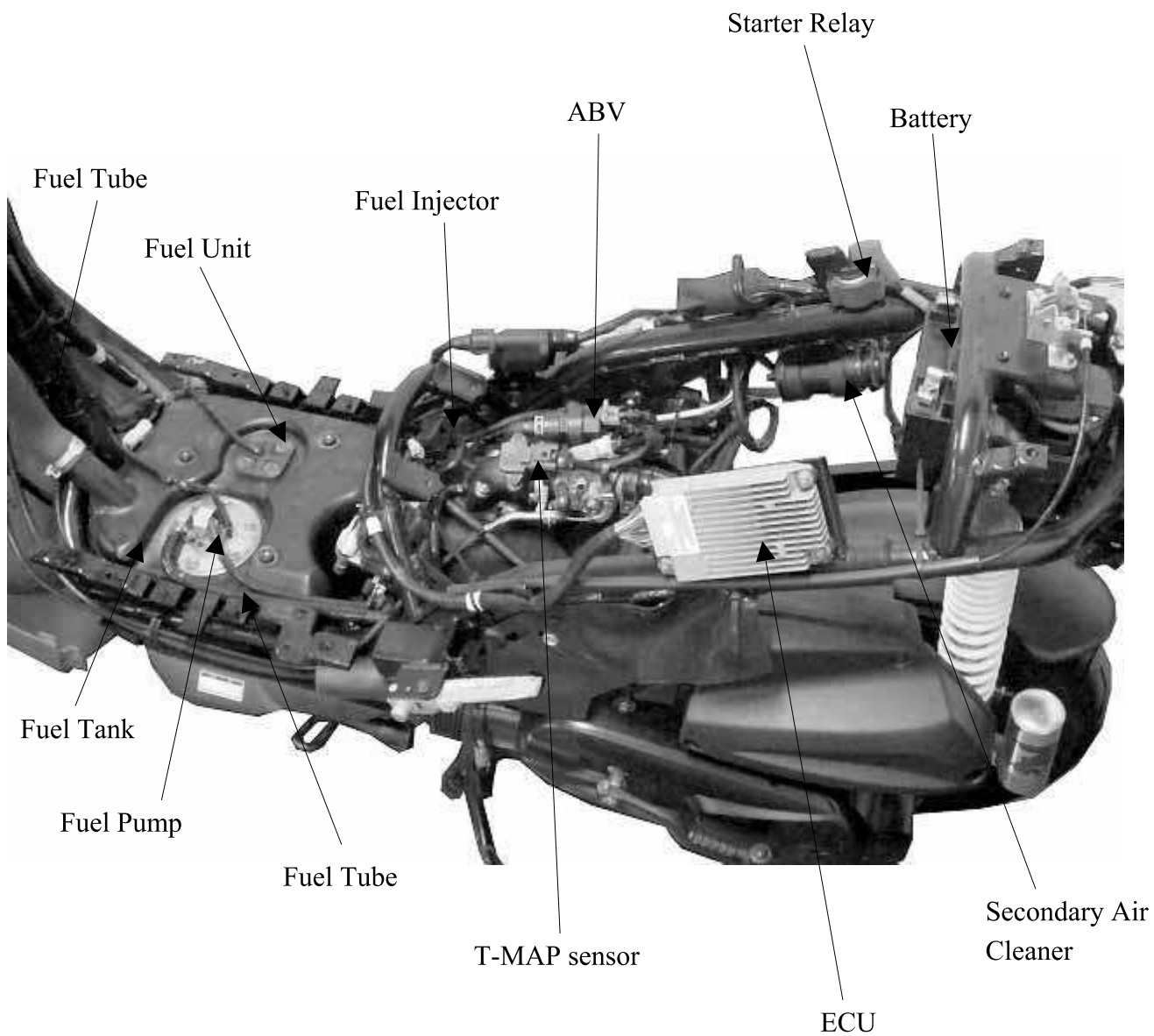

WIRING DIAGRAM

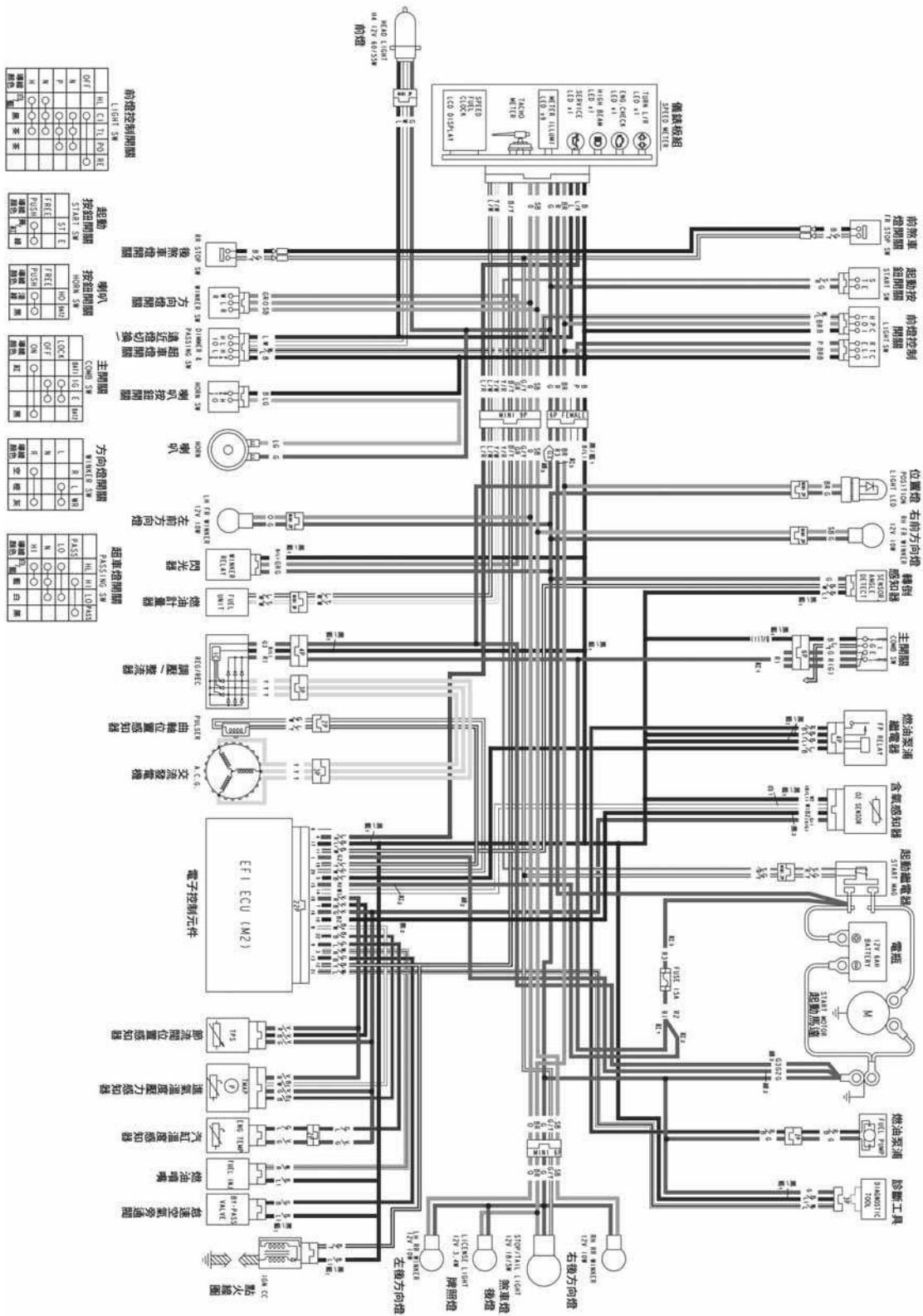

TROUBLESHOOTING

ENGINE WILL NOT START OR IS HARD TO START

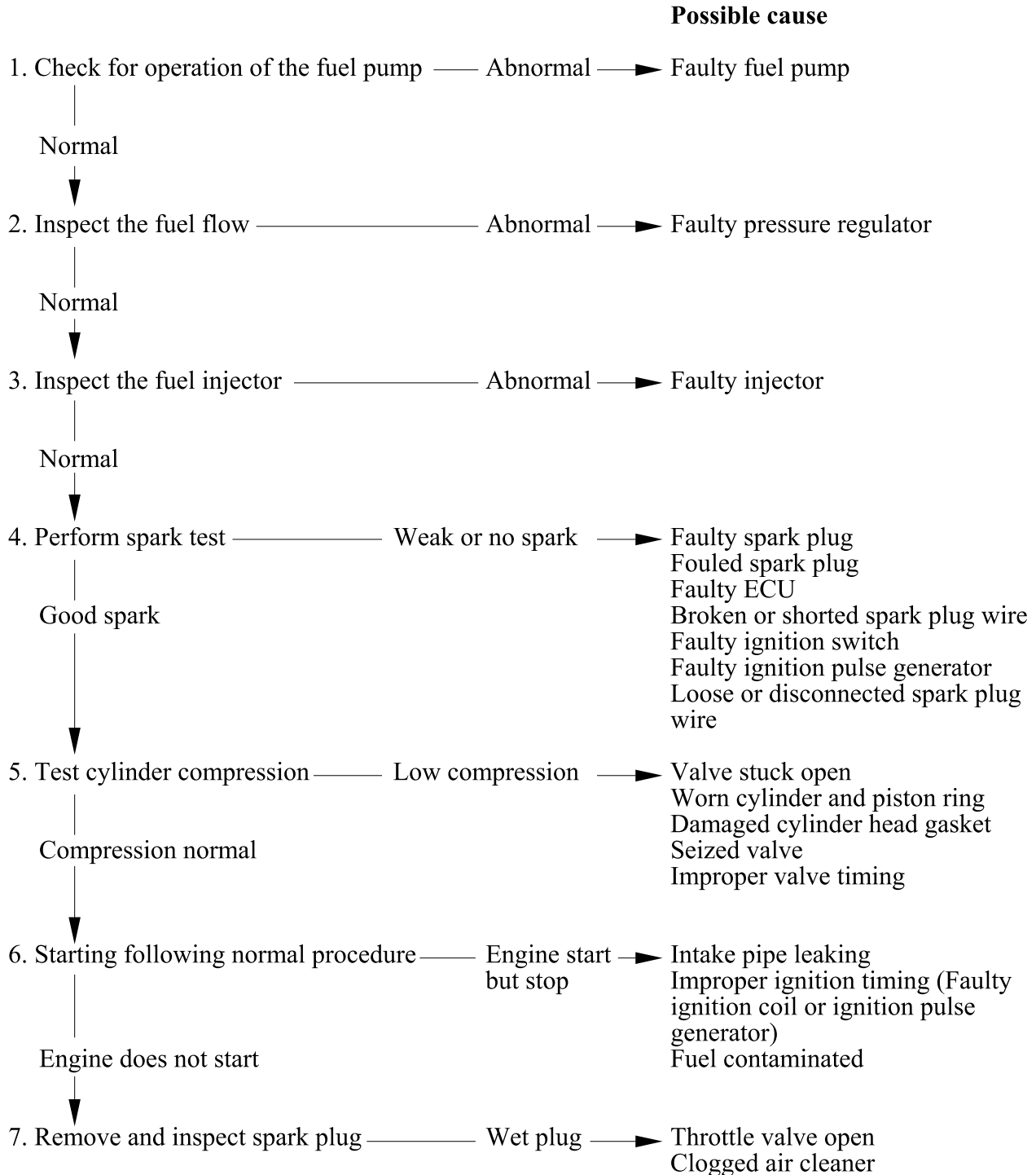

ENGINE LACKS POWER

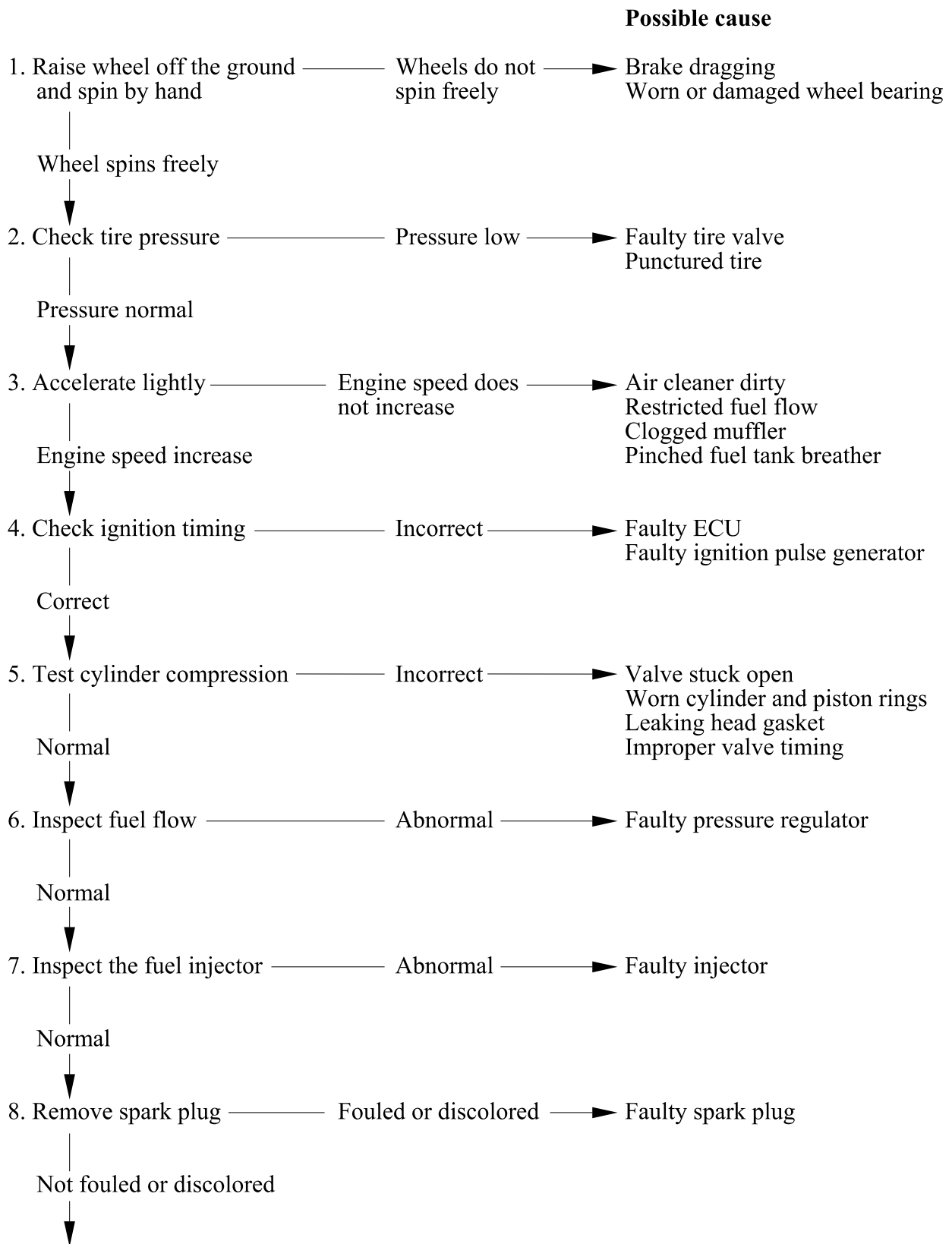

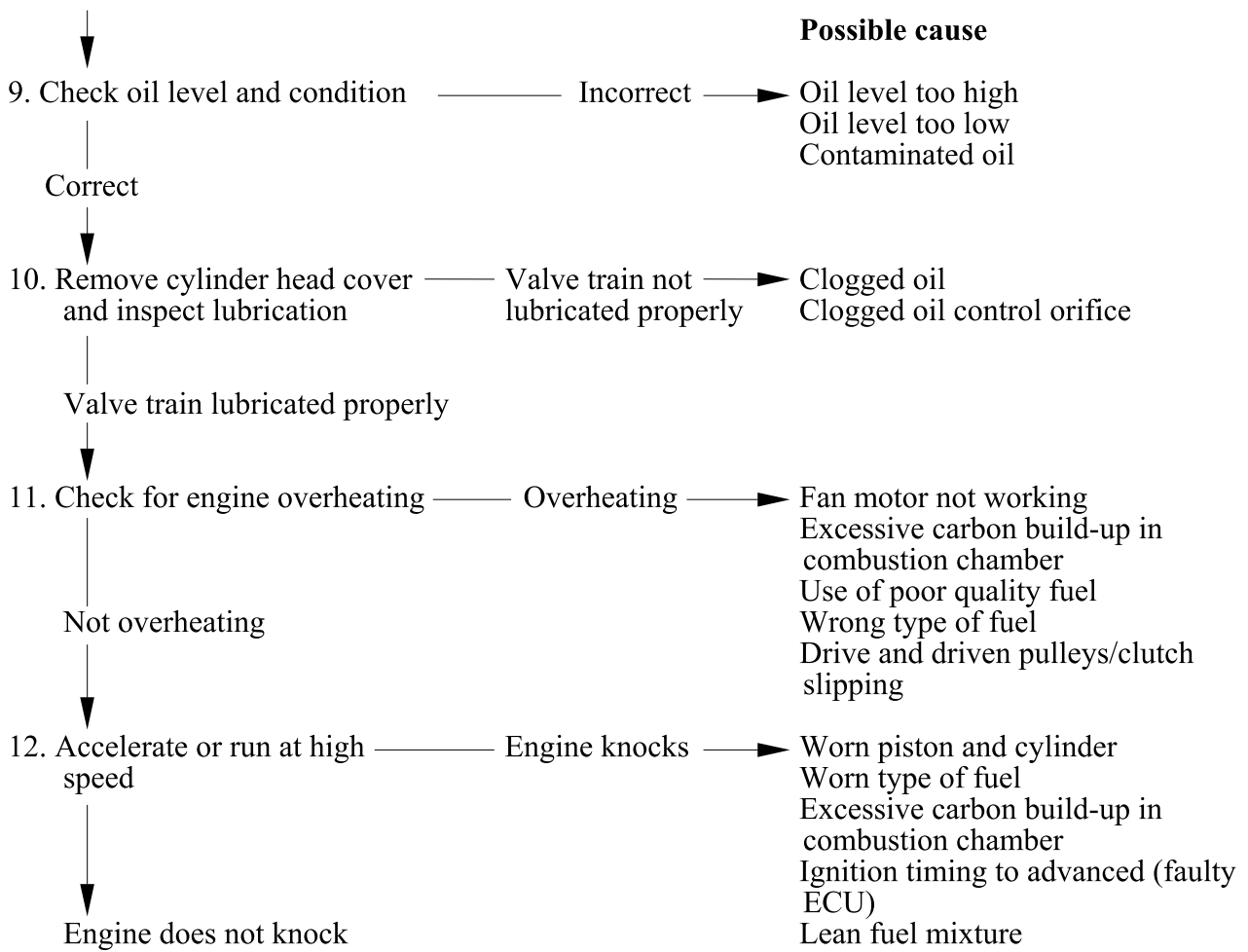

POOR PERFORMANCE AT LOW AND IDLE SPEED

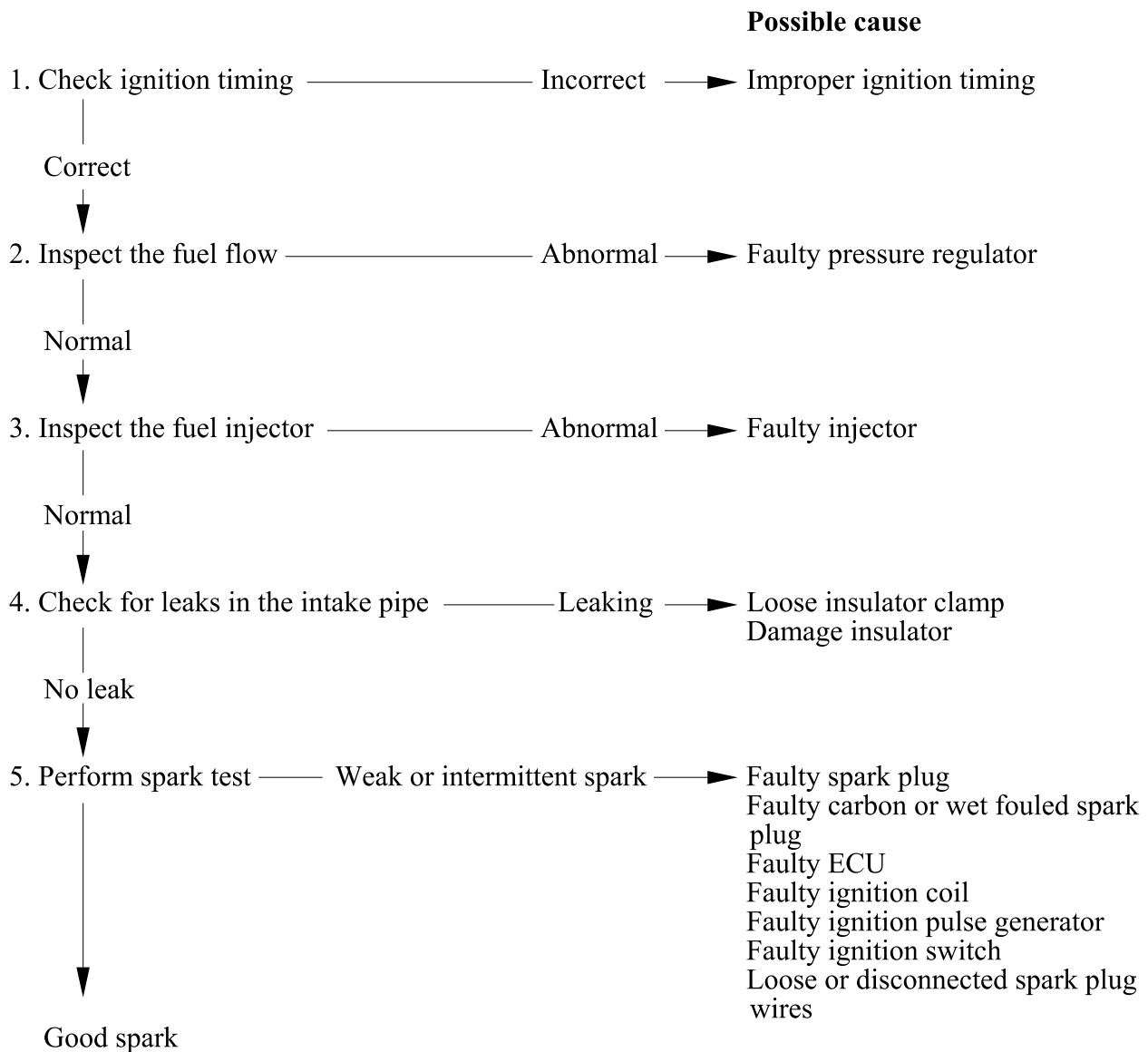

POOR PERFORMANCE AT HIGH SPEED

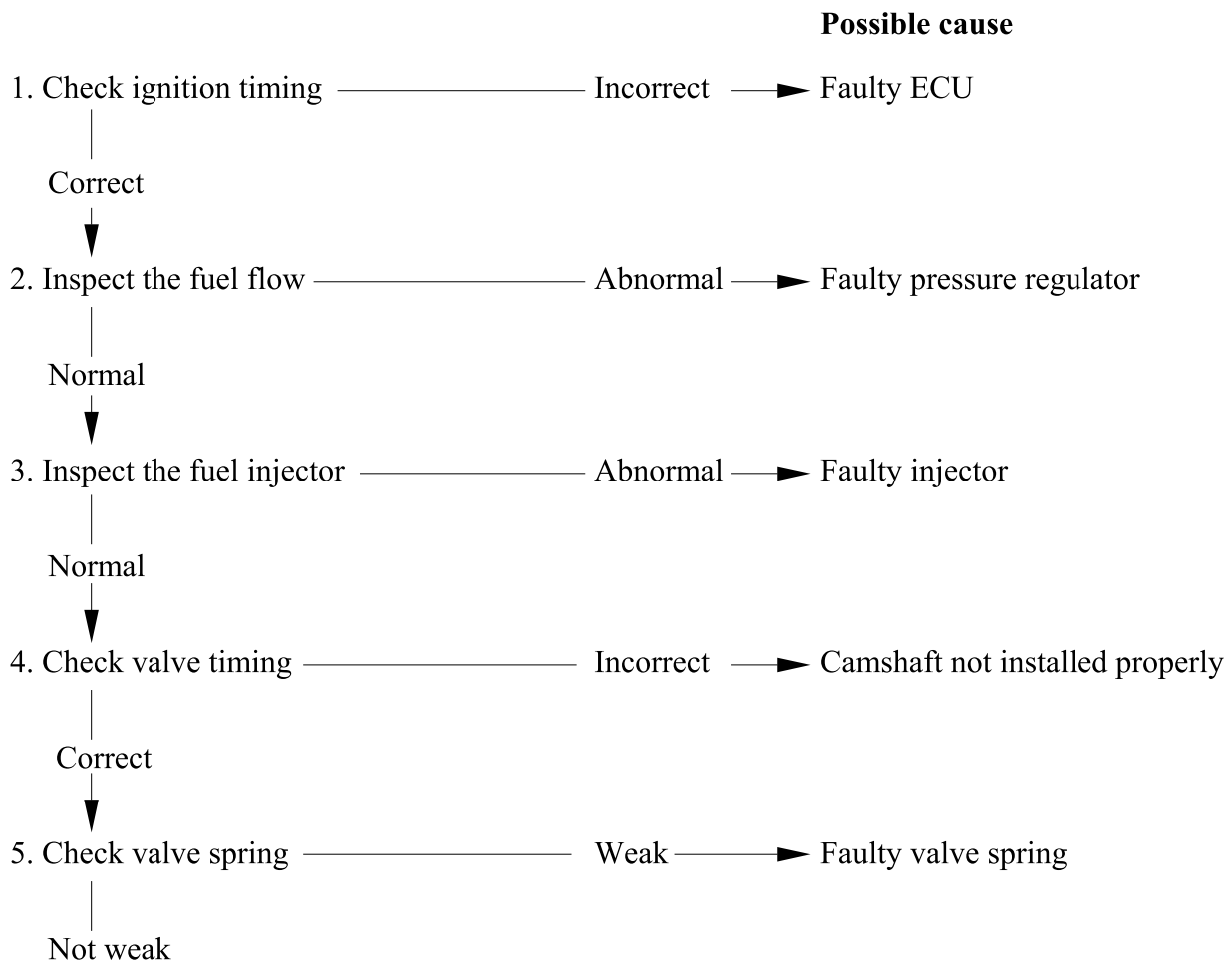

POOR HANDLING

	Possible cause
1. If steering is heavy	Steering stem adjusting nut too tight Damaged steering head bearings
2. If either wheel is wobbling	Excessive wheel bearing play Bent rim Improper installed wheel hub Swing arm pivot bearing excessively worn Bent frame
3. If the motorcycle pulled to one side	Faulty shock absorber Front and rear wheel not aligned Bent fork Bent swing arm Bent axle

2. EXHAUST MUFFLER/FRAME COVER

SERVICE INFORMATION	2-0
TROUBLESHOOTING	2-0
FRAME COVER	2-1
EXHAUST MUFFLER	2-4

SERVICE INFORMATION

GENERAL

 **WARNING**

- When removing frame covers, use care not to pull them by force because the cover joint claws may be damaged.
- Make sure to route cables and harnesses according to the Cable & Harness Routing.

TORQUE VALUES

Exhaust muffler lock bolt	3.5 kg-m
Exhaust muffler joint lock nut	1.2 kg-m

TROUBLESHOOTING

Noisy exhaust muffler

Damaged exhaust muffler
Exhaust muffler joint air leaks

Lack of power

Caved exhaust muffler
Clogged exhaust muffler
Exhaust muffler air leaks

2. EXHAUST MUFFLER/FRAME COVER

FRAME COVER

RIGHT/LEFT SIDE SKIRT REMOVAL

Remove two screws attaching to the left/right rear skirt.
Remove the rear skirt.

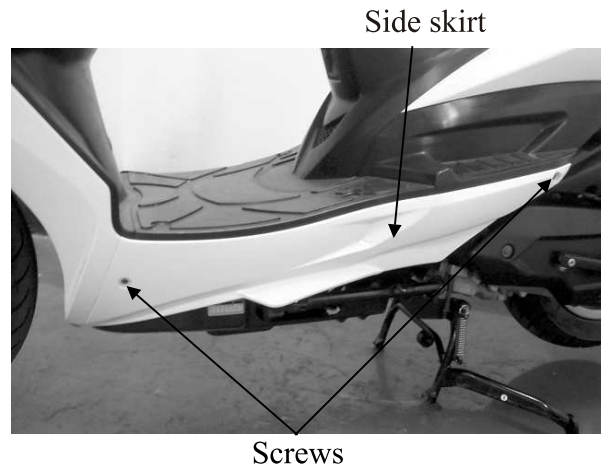

REAR CAREER REMOVAL

Remove four screws attaching to the rear career.
Remove the rear career.

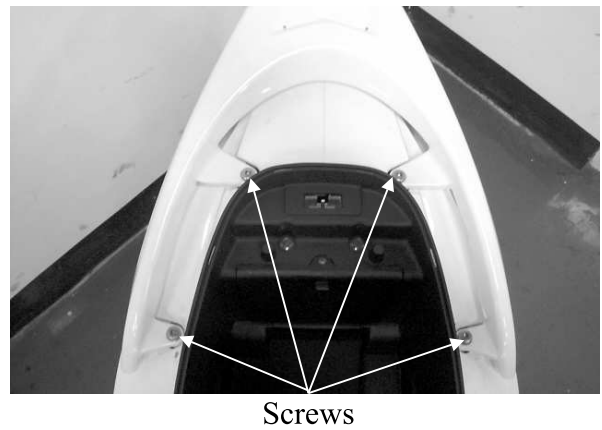

LUGGAGE BOX REMOVAL

Remove four bolts attaching to the luggage box.
Remove the screw on the center luggage.

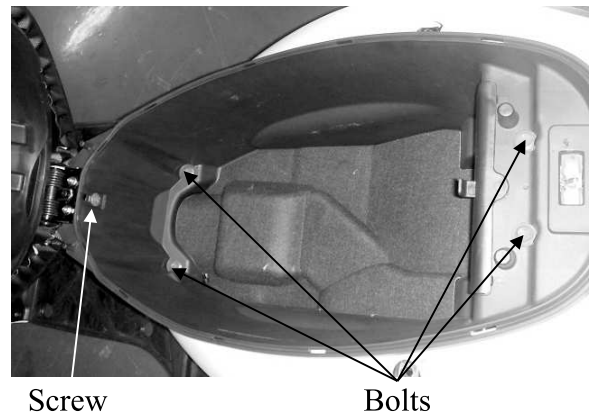

BODY CENTER COVER REMOVAL

Be careful not to damage the clips while removing the body center cover.



2. EXHAUST MUFFLER/FRAME COVER

REAR FENDER & TAILLIGHT LEN REMOVAL

Remove the nut and two bolts attaching to the rear fender.
Disconnect the tail light connector.
Be careful not to damage the clips attaching between the front point of body covers and the floorboard.

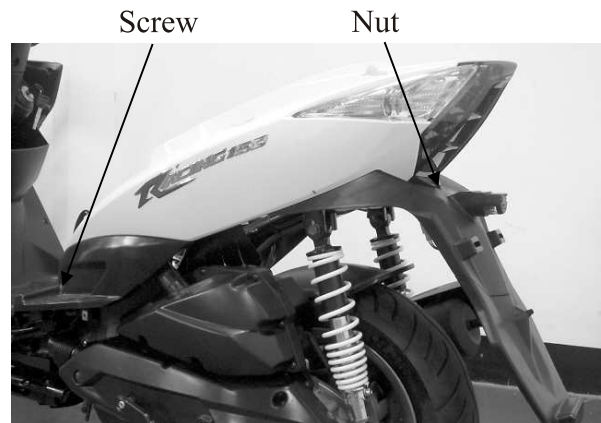

FRONT CENTER COVER REMOVAL

Remove two screws attaching to the front cover.
Remove the front center cover.
Be careful not to damage the claw while removing the front center cover.

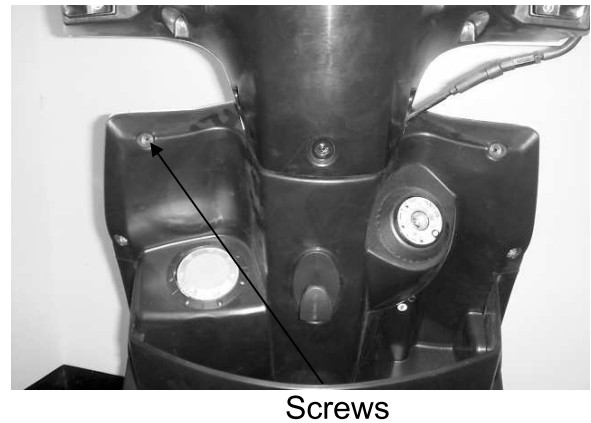

FRONT BOTTOM COVER REMOVAL

Remove four plastic screws attaching to the front bottom cover.
Remove the front bottom cover.

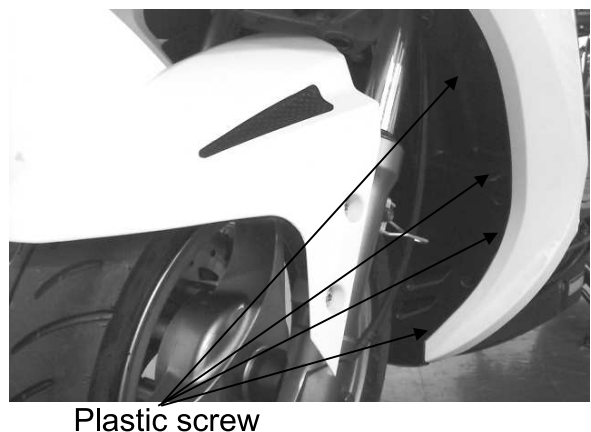

FRONT COVER REMOVAL

Remove four screws onto the leg shield attached to the front cover.
Remove the two nuts attaching to the front cover.
Disconnect the head light connector.
Remove the front cover.
Installation is in the reverse order of removal.

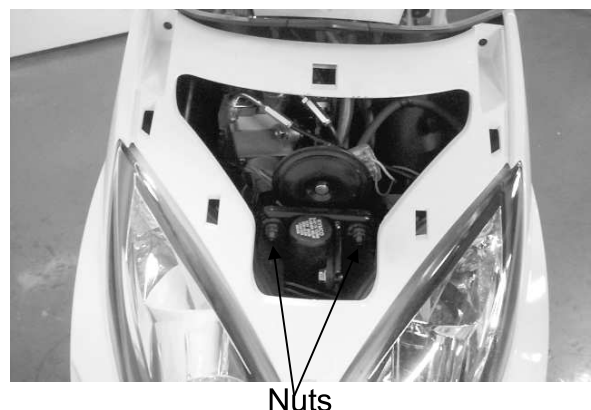

2. EXHAUST MUFFLER/FRAME COVER

Movie S 125i

FRONT/REAR HANDLEBAR COVER REMOVAL

REAR HANDLEBAR COVER REMOVAL

Remove the back mirrors.
Remove five screws attaching to the rear handlebar cover.

* If the rear handlebar cover removed, be careful not to damage the claw.



Screws

Remove the speedometer cable.
Disconnect the wires of the speedometer.
Remove the rear handlebar cover.



Speedometer cable

FRONT HANDLEBAR COVER REMOVAL

Remove two screws attaching to the back of front handlebar cover.
Remove the bolt attaching to the front of front handlebar cover.
Installation is in the reverse order of removal.



Screws

FLOORBOARD REMOVAL

Remove four bolts onto the floorboard.
Remove the floorboard.
Installation is in the reverse order of removal.

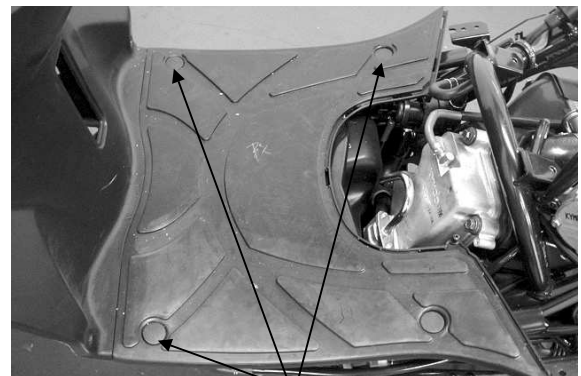

Bolts

2. EXHAUST MUFFLER/FRAME COVER

INNER LEG SHIELD REMOVAL

Remove the floorboard.
 Remove the screw attaching to ignition switch collar.
 Remove three screws onto the fuel filler seat.
 Remove the two plastic bolts attaching to the front cover.

Screw, Collar Switch Plastic bolt

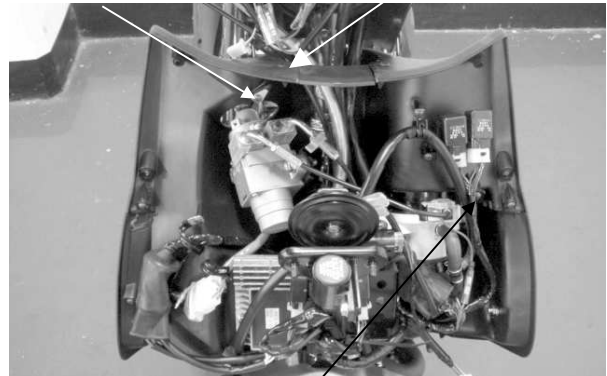

Bolts, fuel filler seat

UNDER COVER REMOVAL

Remove the side skirts.
 Remove four bolts attached the under cover.
 Remove the under cover.
 Installation is in the reverse order of removal.

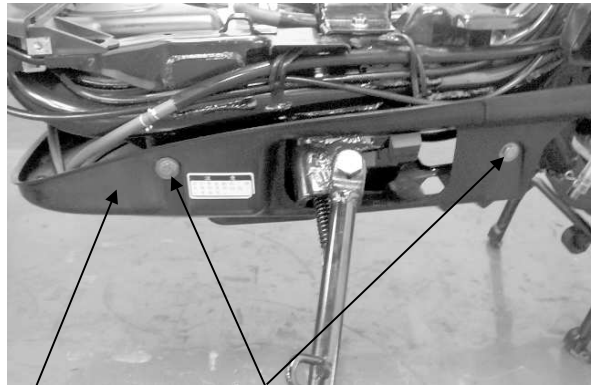

Under cover Bolts

EXHAUST MUFFLER

REMOVAL

Remove the wire of O2 sensor.
 Remove two exhaust muffler joint bolts.
 Remove three exhaust muffler lock bolts.
 Remove the packing attached the exhaust muffler.
 When installation, first install the packing collar to the engine and then muffler.

Torque:

Exhaust muffler joint lock nut: 1.2 kg-m
 Exhaust muffler lock bolt: 3.5 kg-m
 O2 sensor bolt: 2.5 kg-m

*

The packing should be used a new one.
 Be careful not to damage the wire of O2 sensor.



Bolts

FRONT FENDER

REMOVAL

Remove two bolts attaching to the front fender.
 Remove the front fender.



Bolts

3. INSPECTION/ADJUSTMENT

SERVICE INFORMATION	3-0	BRAKE SYSTEM	3-7
MAINTENANCE SCHEDULE	3-2	HEADLIGHT AIM.....	3-8
THROTTLE OPERATION	3-3	CLUTCH SHOE WEAR	3-8
AIR CLEANER.....	3-4	SUSPENSION	3-8
SPARK PLUG.....	3-4	NUTS/BOLTS/FASTENERS	3-9
VALVE CLEARANCE	3-5	WHEEL/TIRES	3-9
CYLINDER COMPRESSION.....	3-5	STEERING HANDLEBAR	3-9
FINAL REDUCTION GEAR OIL.....	3-6		
DRIVE BELT	3-6		

SERVICE INFORMATION

GENERAL



WARNING

- Before running the engine, make sure that the working area is well-ventilated. Never run the engine in a closed area. The exhaust contains poisonous carbon monoxide gas which may cause death to people.
- Gasoline is extremely flammable and is explosive under some conditions. The working area must be well-ventilated and do not smoke or allow flames or sparks near the working area or fuel storage area.

SPECIFICATIONS

ENGINE

Throttle grip free play	:	2 ~ 6 mm
Spark plug gap	:	0.6 ~ 0.7 mm
Spark plug	:	NGK - CR8E
Valve clearance :	IN: 0.12 mm	EX: 0.12 mm
Idle speed	:	1800±100rpm

Engine oil capacity

At disassembly	:	0.9 liter
At change	:	0.8 liter

Gear oil capacity

At disassembly	:	140 cc
At change	:	120 cc

3. INSPECTION/ADJUSTMENT

Cylinder compression : 15 kg/cm² - 570rpm
Ignition timing : BTDC 4° - 32° / 1800 rpm

CHASSIS

Rear brake free play : 10~20mm

TIRE PRESSURE

	1 Rider	1 Rider (with passenger)
Front	1.75 kg/cm ²	1.75 kg/cm ²
Rear	2.00 kg/cm ²	2.25 kg/cm ²

TIRE SIZE:

Front : 110 / 70 - 12
Rear : 130 / 70 - 12

TORQUE VALUES

Front axle nut 4~ 5 kg-m
Rear axle nut 8~10 kg-m

SPECIAL TOOL:

Valve Wrench E012

3. INSPECTION/ADJUSTMENT

Movie S 125i

MAINTENANCE SCHEDULE

Perform the periodic maintenance at each scheduled maintenance period.

I: Inspect, and Clean, Adjust, Lubricate or Replace if necessary.

A: Adjust C: Clean R: Replace T : Tighten M: Maintain D: Diagnostic

Item	Frequency	Which ever come first	Regular Service Mileage (km)										
			300	1000	3000	4000	5000	6000	7000	8000	9000	10000	11000
Engine Oil			R (New)	R	R		R		R		R		R
Engine Oil Filter Screen			C		C				C				C
Fuel Line							I				I		
Gear Oil	Note 3		R (New)		R				R				R
Valve Clearance			A		A				A				A
Air Cleaner	Note 2			I	R		I		R		I		R
Spark Plug							R					R	
Brake System				I	I		I		I		I		I
Drive belt (CVT)									I				
Suspension							I				I		
Nuts / Bolts / Fasteners			I				I				I		
Tire				I	I		I		I		I		I
Steering Hand Bearing			I				I				I		
Throttle Body							M		D			C	D
Injector							D		D			D	D
Idle Air Bypass Valve							D		D			D	D
Engine Temperature Sensor							D		D			D	D
Battery							D		D			D	D
Ignition coil							D		D			D	D
Tilt switch							D		D			D	D
Intake pressure sensor							D		D			D	D

- In the interest of safety, we recommend these items should be serviced only by an authorized KYMCO motorcycle dealer.

Note: 1. For higher odometer readings, repeat at the frequency interval established here.
 2. Service more frequently when riding in dusty or rainy areas.
 3. Clean CVT at every 2000 km.

3. INSPECTION/ADJUSTMENT

THROTTLE OPERATION

Check the throttle grip for smooth movement.
Measure the throttle grip free play.

Free Play: 2 ~ 6mm

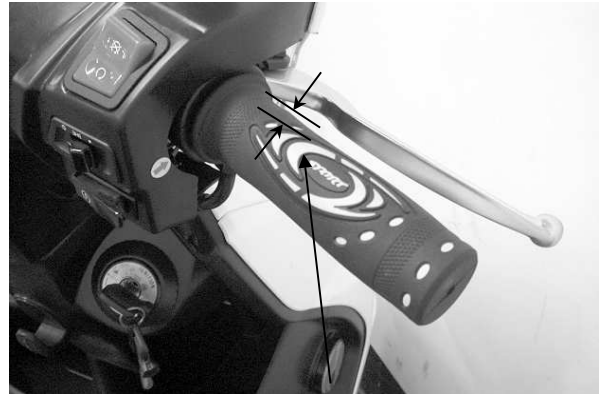

2-6mm

Major adjustment of the throttle grip free play is made with the adjusting nut at the throttle body side. Adjust by loosening the lock nut and turning the adjusting nut.

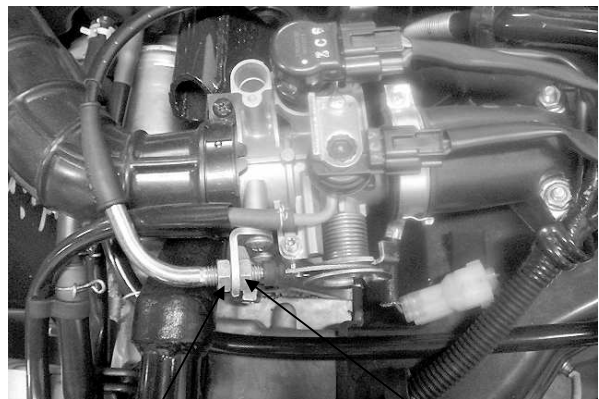

Adjusting Nut

Lock Nut

Minor adjustment is made with the adjusting nut at the throttle grip side.

Slide the rubber cover out and adjust by loosening the lock nut and turning the adjusting nut.



Adjusting Nut

Lock Nut

3. INSPECTION/ADJUSTMENT

AIR CLEANER

AIR FILTER REPLACEMENT

Remove the body cover.
 Remove seven screws attaching to the air cleaner cover.
 Remove six screws attaching to the filter.
 Check the filter and replace it if it is excessively dirty or damaged.

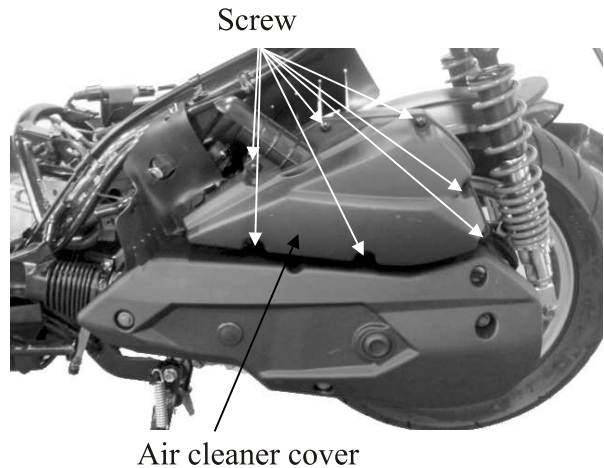

Air filter



MAINTAIN INTERVAL

More frequent replacement is required when riding in unusually dusty or rainy areas.

* Be sure to install the air filter and cover securely.

SPARK PLUG

Remove the spark plug cap and spark plug.
 Check the spark plug for wear and fouling deposits.
 Clean any fouling deposits with a spark plug cleaner or a wire brush.

Specified Spark Plug: NGK- CR8E



Spark plug

Measure the spark plug gap.

Spark Plug Gap: 0.6~0.7 mm

* When installing, first screw in the spark plug by hand and then tighten it with a spark plug wrench.

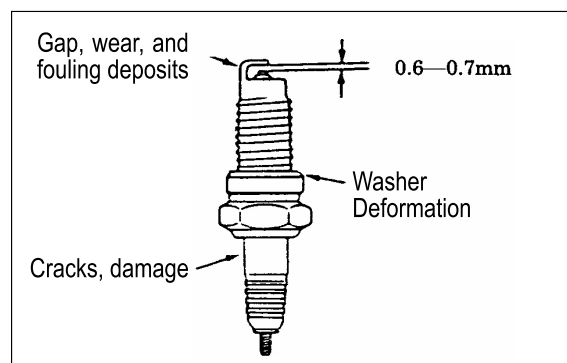

3. INSPECTION/ADJUSTMENT

VALVE CLEARANCE

* Inspect and adjust valve clearance while the engine is cold (below 35°C).

Remove the center cover and the secondary air inlet tube bolt.
Remove the cylinder head cover.

Turn the A.C. generator flywheel to the top dead center (TDC) on the compression stroke so that the "T" mark on the flywheel aligns with the index mark on the left crankcase cover.

Inspect and adjust valve clearance.

Valve Clearance: IN: 0.12 mm EX: 0.12 mm

Loosen the lock nut and adjust by turning the adjusting nut.

Special

Valve Wrench

* Check the valve clearance again after the lock nut is tightened.

CYLINDER COMPRESSION

Warm up the engine before compression test.
Remove the center cover and luggage box.
Remove the spark plug.
Insert a compression gauge.
Open the throttle fully and push the starter button to test the compression.

Compression: 15 kg/cm² – 570 rpm

If the compression is low, check for the following:

- Leaky valves
- Valve clearance too small
- Leaking cylinder head gasket
- Worn piston rings
- Worn piston/cylinder

If the compression is high, it indicates that carbon deposits have accumulated on the combustion chamber and the piston head.

Cylinder Head Cover

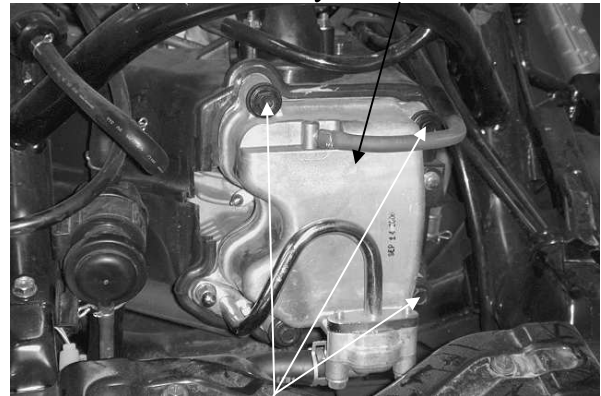

Bolts

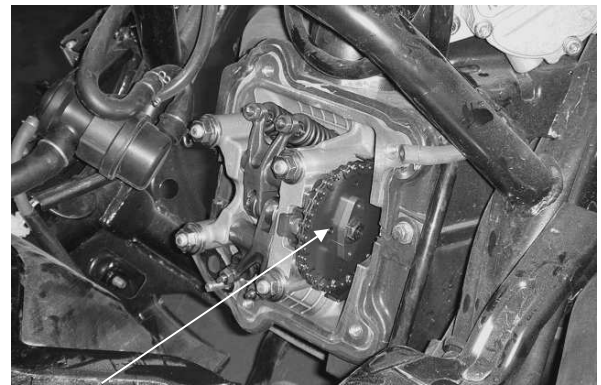

Round Hole(TDC mark)

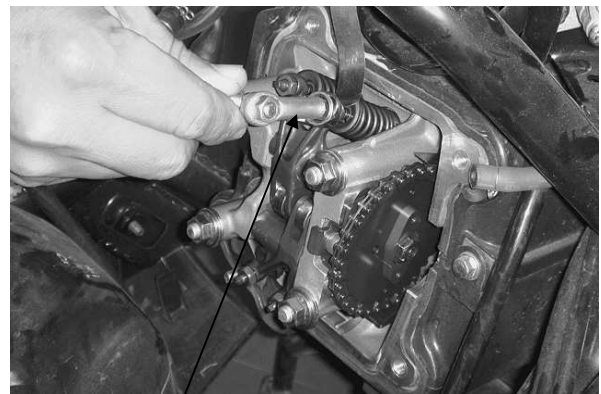

Valve Wrench

Feeler Gauge



3. INSPECTION/ADJUSTMENT

FINAL REDUCTION GEAR OIL

* Place the motorcycle on its main stand on level ground.

Stop the engine and remove the oil check bolt.
The oil level shall be at the oil check bolt hole.
If the oil level is low, add the recommended oil SAE90# to the proper level.
Install the oil check bolt.

* Make sure that the sealing washer is in good condition.

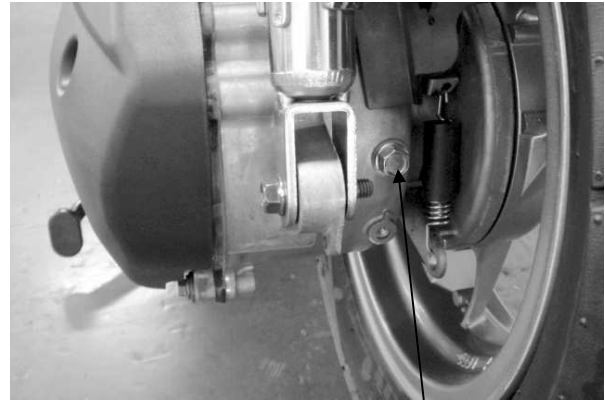

Oil check bolt

GEAR OIL CHANGE

Remove the oil check bolt.
Remove the oil drain bolt and drain the oil thoroughly.
Install the oil drain bolt.

Torque: 1.0 kg-m

Fill the final reduction with the recommended oil SAE90#.

Gear Oil Capacity:

At disassembly : 140 cc

At change : 120 cc

Reinstall the oil check bolt and check for oil leaks.

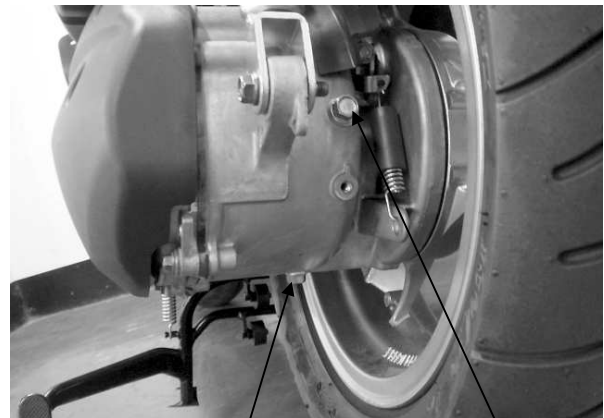

Oil drain bolt

Sealing washer

DRIVE BELT

Remove the left crankcase cover.
Inspect the drive belt for cracks or excessive wear.
Replace the drive belt with a new one if necessary and in accordance with the Maintenance Schedule.

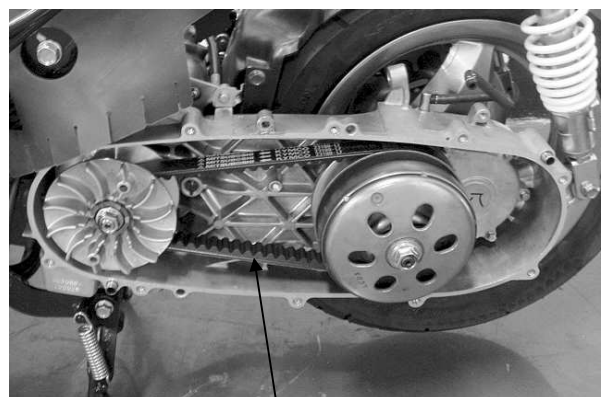

Drive belt

3. INSPECTION/ADJUSTMENT

BRAKE SYSTEM

BRAKE LEVER

Measure the rear brake lever free plays.
Free Play: Front: 10~20 mm



BRAKE DISK/BRAKE PAD

Check the brake disk surface for scratches, unevenness or abnormal wear.
Check if the brake disk runout is within the specified service limit.
Check if the brake pad wear exceeds the wear indicator line.



Brake disk

* Keep grease or oil off the brake disk to avoid brake failure.

BRAKE FLUID

Turn the steering handlebar upright and check if the front brake fluid level is at the upper limit. If the brake fluid is insufficient, fill to the upper limit.

Specified Brake Fluid: DOT-4

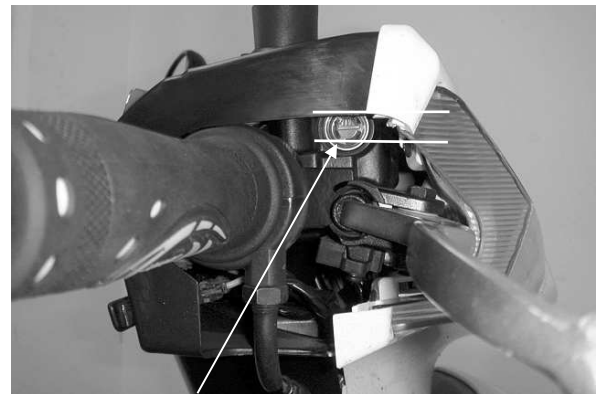

Brake fluid reservoir

* The brake fluid level will decrease if the brake pads are worn.

BRAKE DRUM/SHOE

《 Brake Shoe Wear 》

Replace the brake shoes if the arrow on the brake arm aligns with △ mark on the brake panel when the brake is fully applied.

《 Brake Drum Wear/Damage 》

Check the brake drum appearance for damage. Check if the brake lining wear is within the specified service limit. Check the brake operation for abnormal noise and brake drum inside for wear or damage.



Mark

3. INSPECTION/ADJUSTMENT

If the rear brake lever free play is beyond the specified service limit. Should adjust the adjust nut.



Adjust nut

HEADLIGHT AIM

Turn the ignition switch to ON.
Turn on the headlight switch.
Adjust the headlight aim by turning the headlight aim adjusting bolt.



Headlight Aim Adjusting Bolt

CLUTCH SHOE WEAR

Start engine and check the clutch operation by increasing the engine speed gradually.
If the motorcycle tends to creep or the engine stop, check the clutch shoes for wear and replace if necessary.

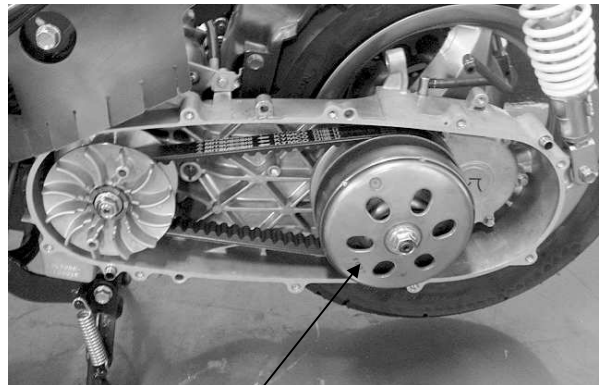

Clutch shoes

SUSPENSION

FRONT

Check the action of the front shock absorbers by compressing them several times.
Check the entire shock absorber assembly for oil leaks, looseness or damage.



3. INSPECTION/ADJUSTMENT

REAR

Check the action of the rear shock absorbers by compressing them several times.

Check the entire shock absorber assembly for oil leaks, looseness or damage.

Jack the rear wheel off the ground and move the rear wheel sideways with force to see if the engine hanger bushings are worn.



NUTS/BOLTS/FASTENERS

Check all important chassis nuts and bolts for looseness.

Tighten them to their specified torque values if any looseness is found.



WHEELS/TIRES

Check the tires for cuts, imbedded nails or other damages.

Check the tire pressure.

* Tire pressure should be checked when tires are cold.

Tire Pressure

	1 Rider	1 Rider (with passenger)
Front	1.75 kg/cm ²	1.75 kg/cm ²
Rear	2.00 kg/cm ²	2.25 kg/cm ²



STEERING HANDLEBAR

Raise the front wheel off the ground and check that the steering handlebar rotates freely.

If the handlebar moves unevenly, binds, or has vertical movement, adjust the steering head bearing.



Front axle nut

4. LUBRICATION SYSTEM

SERVICE INFORMATION	4-1
TROUBLESHOOTING	4-1
ENGINE OIL/OIL FILTER	4-2
OIL PUMP	4-3

LUBRICATION SYSTEM

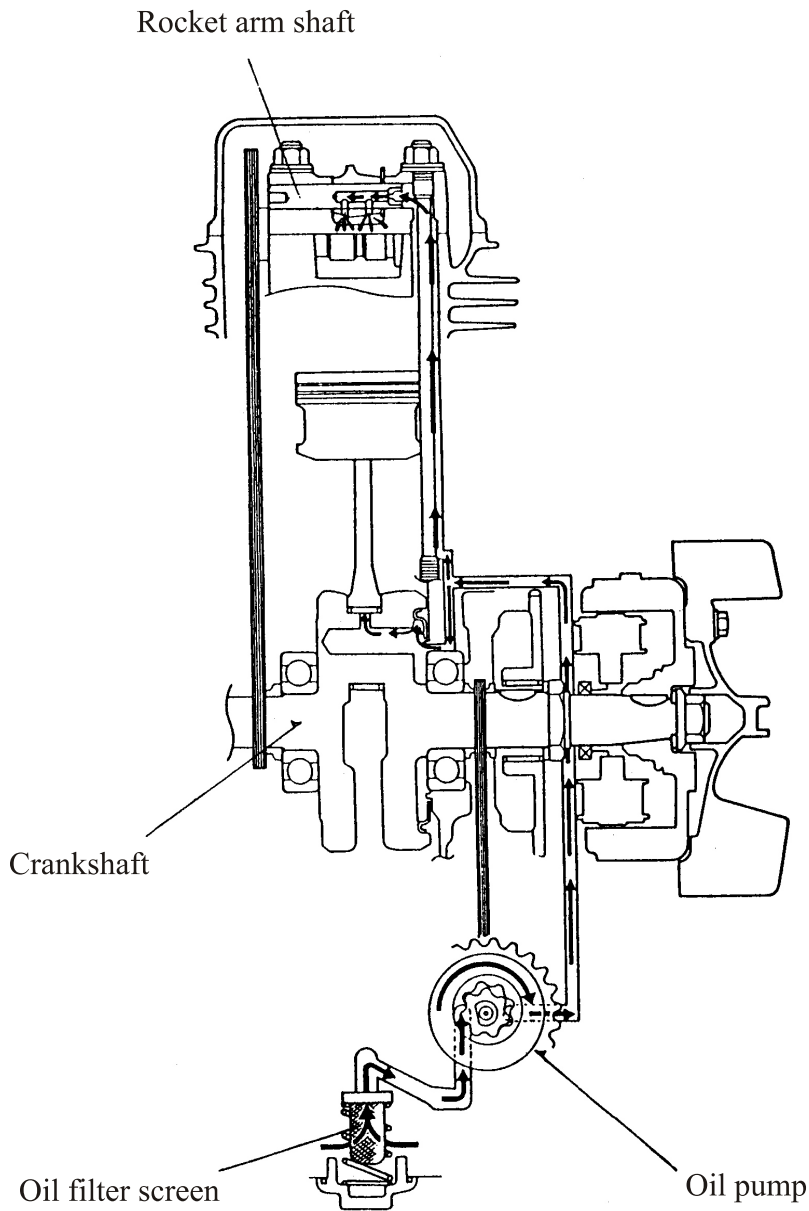

4. LUBRICATION SYSTEM

SERVICE INFORMATION

GENERAL INSTRUCTIONS

The maintenance of lubrication system can be performed with the engine installed in the frame.

Use care when removing and installing the oil pump not to allow dust and foreign matters to enter the engine and oil line.

Do not attempt to disassemble the oil pump. The oil pump must be replaced as a set when it reaches its service limit.

After the oil pump is installed, check each part for oil leaks.

SPECIFICATIONS

	Item	Standard(mm)	Service limit(mm)
Oil pump	Inner rotor-to-outer rotor clearance	—	0.12
	Outer rotor-to-pump body clearance	—	0.12
	Rotor end-to-pump body clearance	0.05~0.10	0.2

TROUBLESHOOTING

Oil level too low

1. Natural oil consumption
2. Oil leaks
3. Worn or poorly installed piston rings
4. Worn valve guide or seal

Poor lubrication pressure

1. Oil level too low
2. Clogged oil filter or oil passages
3. No use the specified oil

4. LUBRICATION SYSTEM

ENGINE OIL/OIL FILTER

OIL LEVEL

* Place the motorcycle upright on level ground for engine oil level check.
Run the engine for 2~3 minutes and check the oil level after the engine is stopped for 2~3 minutes.

Remove the oil dipstick and check the oil level with the oil dipstick.
If the level is near the lower level, fill to the upper level with the specified engine oil.

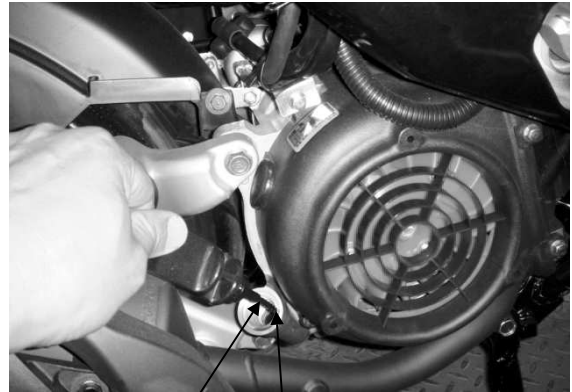

Upper lever Lower lever

Remove the oil dipstick and check the oil level with the oil dipstick.
If the level is near the lower level, fill to the upper level with the specified engine oil.

OIL CHANGE

* The engine oil will drain more easily while the engine is warm.

The engine oil will drain more easily while the engine is warm.

Remove the oil filter screen cap located on the bottom of the engine to drain the engine oil thoroughly.



Oil filter screen cap

After the oil has been completely drained, check the filter screen O-ring for damage and replace if necessary.

Install the oil filter screen, spring and filter screen cap.

Torque: 1.5 kg-m

Fill with the specified SAE15W40#, API: SG/CD engine oil to the proper level.



Oil ring

Oil Capacity:

At disassembly: 0.9 liter

At change : 0.8 liter

Check for oil leaks and then start the engine and let it idle for few minutes.
Recheck the oil level.

4. LUBRICATION SYSTEM

OIL PUMP

REMOVAL

Remove the A.C. generator flywheel.
Remove two bolts located on the A.C. Generator and the other two bolts located on the CPS.
Remove the A.C. Generator and CPS.
Remove nine right crankcase cover bolts and the right crankcase cover.

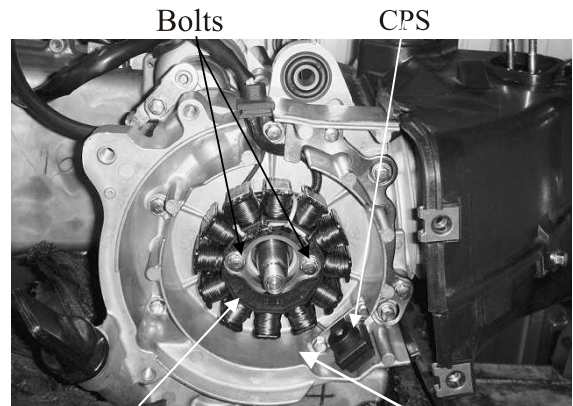

A.C. Generator Right Crankcase Cover

Remove the gasket and dowel pins.
Remove the starter idle gear and starter clutch.



Gasket Dowel Pins

Oil separator cover

Remove the two bolts and oil separator cover.

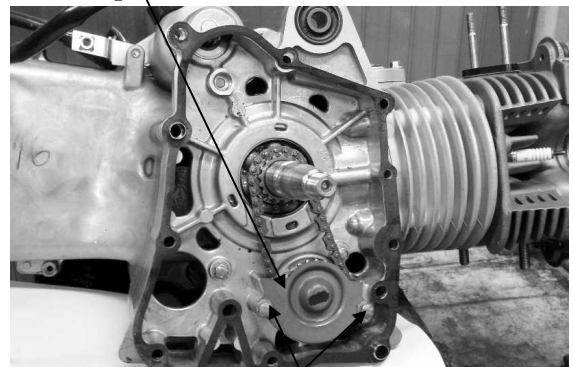

Bolts

Remove the oil pump driven gear nut to remove the oil pump driven gear and drive chain.

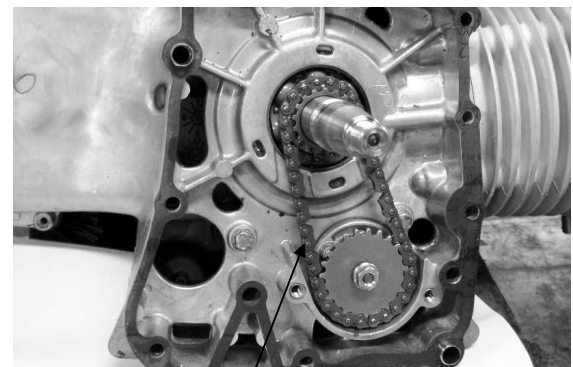

Oil pump drive chain

4. LUBRICATION SYSTEM

Remove two oil pump mounting bolts and the oil pump.

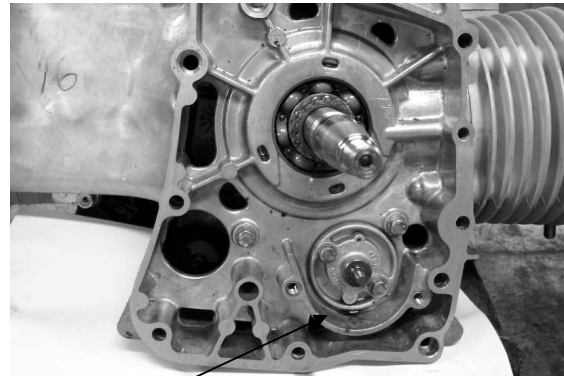

Oil pump

DISASSEMBLY

Remove the screw and disassemble the oil pump.

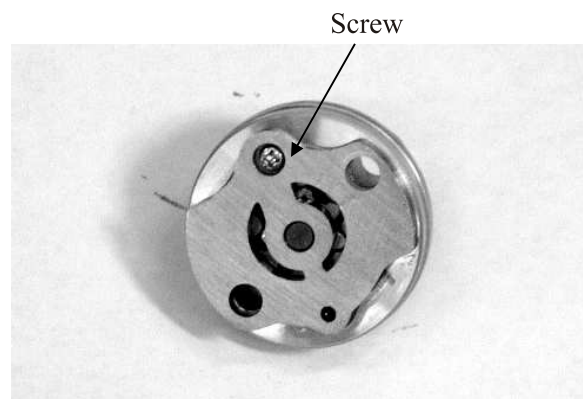

Screw

INSPECTION

Measure the pump body-to-outer rotor clearance.

Service Limit: 0.12 mm

Outer rotor

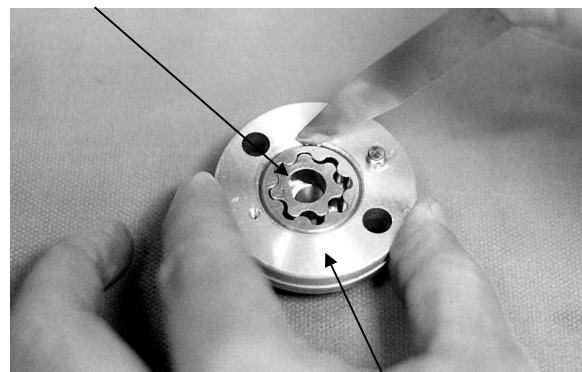

Pump body

Measure the inner rotor-to-outer rotor clearance.

Service Limit: 0.12 mm

Outer rotor

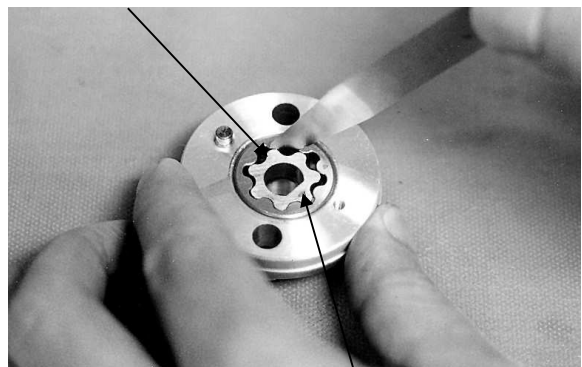

Inner rotor

4. LUBRICATION SYSTEM

Measure the rotor end-to-pump body clearance.

Service Limit: 0.2 mm

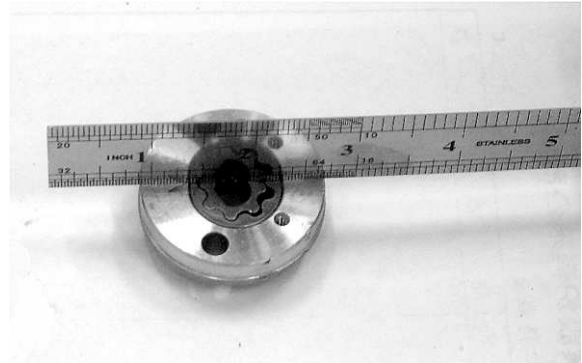

ASSEMBLY

Install the outer rotor, inner rotor and pump shaft into the pump body.

* Insert the pump shaft by aligning the flat on the shaft with the flat in the inner rotor.

Install the dowel pin.
Install the pump cover by aligning the hole in the cover with the dowel pin.

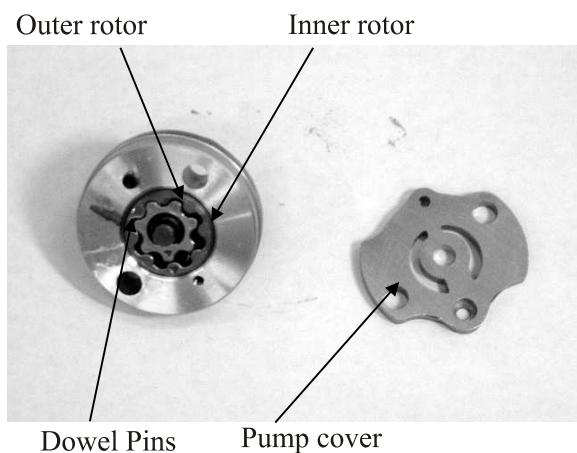

Tighten the screw to secure the pump cover.
Make sure that the pump shaft rotates freely without binding.

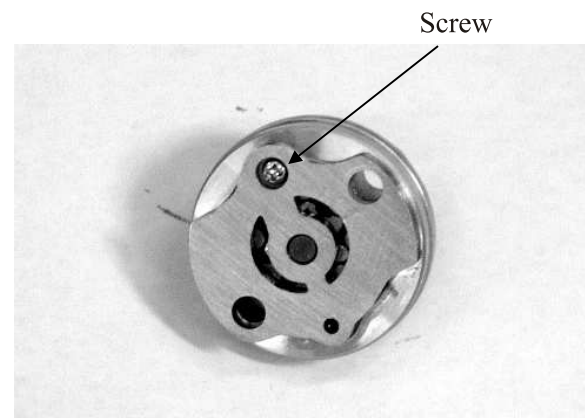

INSTALLATION

Install the oil pump into the crankcase.

* Install the oil pump with the arrow on the pump body facing up and fill the oil pump with engine oil before installation.

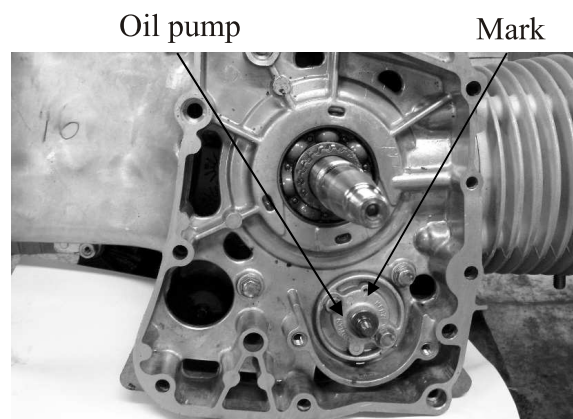

4. LUBRICATION SYSTEM

After the oil pump is installed, tighten the two mounting bolts.

Oil pump

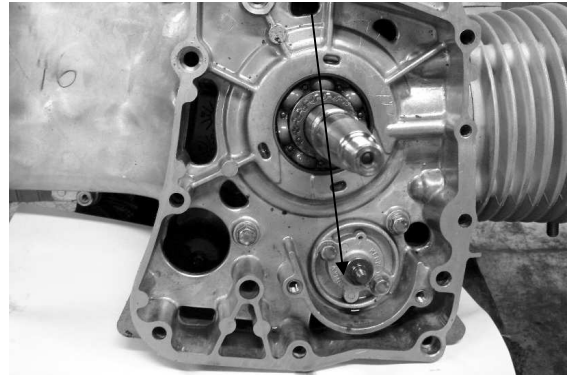

Install the pump driven gear and drive chain by aligning the pump driven gear with the cutout in the pump shaft.

Install and tighten the pump driven gear nut.

Torque: 1.0 kg-m



Drive chain

Install the oil separator cover and tighten the bolts.



Dowel Pins

Install the starter idle gear and starter clutch. Install the gasket and dowel pins.

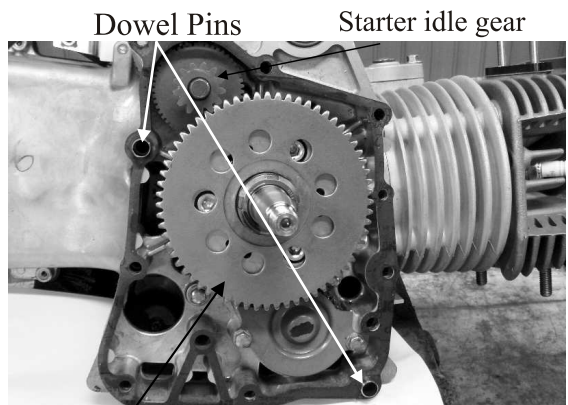

Starter clutch

4. LUBRICATION SYSTEM

Install the right crankcase cover and tighten the nine bolts.

Torque: 0.9 kg-m

* Diagonally tighten the bolts in 2~3 times.

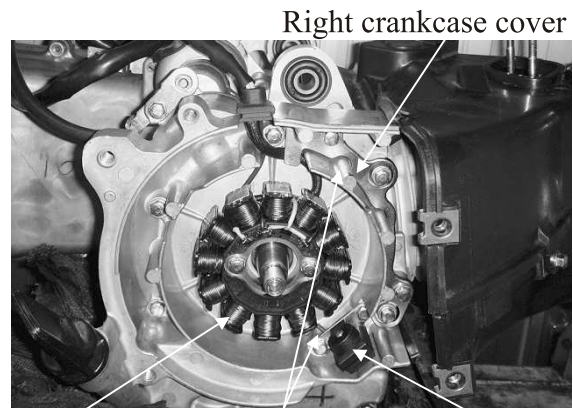

A.C. Generator

Bolts

CPS

5. Fi INJECTION SYSTEM

Fi INJECTION SYSTEM

SYSTEM DIAGRAM	5-1
FI PARTS DRAWING.....	5-2
SERVICE INFORMATION	5-3
TROUBLESHOOTING.....	5-4
CHECK ENGINE LAMP (CELP)	5-5
HOW TO SHOW THE FAILURE CODE	5-6
DTC CODES LIST.....	5-7
SYNERJECT M3A ECU MODULE	5-11
ECU MODULE.....	5-13
TO INITIAL TPS AND ABV	5-15
FUEL PUMP & T-MAP SENSOR	5-17
TPS & ENGINE TEMPERATURE SENSOR	5-18
FUEL INJECTOR.....	5-19
O2 SENSOR.....	5-21
ROLL SENSOR.....	5-22
TPI AND ABV INITIALIZATION	5-23
DIAGNOSTIC RECORD REPORT	5-24
FI DIAGNOSTIC TOOL OPERATION INSTRUCTIONS.....	5-25

5. Fi INJECTION SYSTEM

SYSTEM DIAGRAM

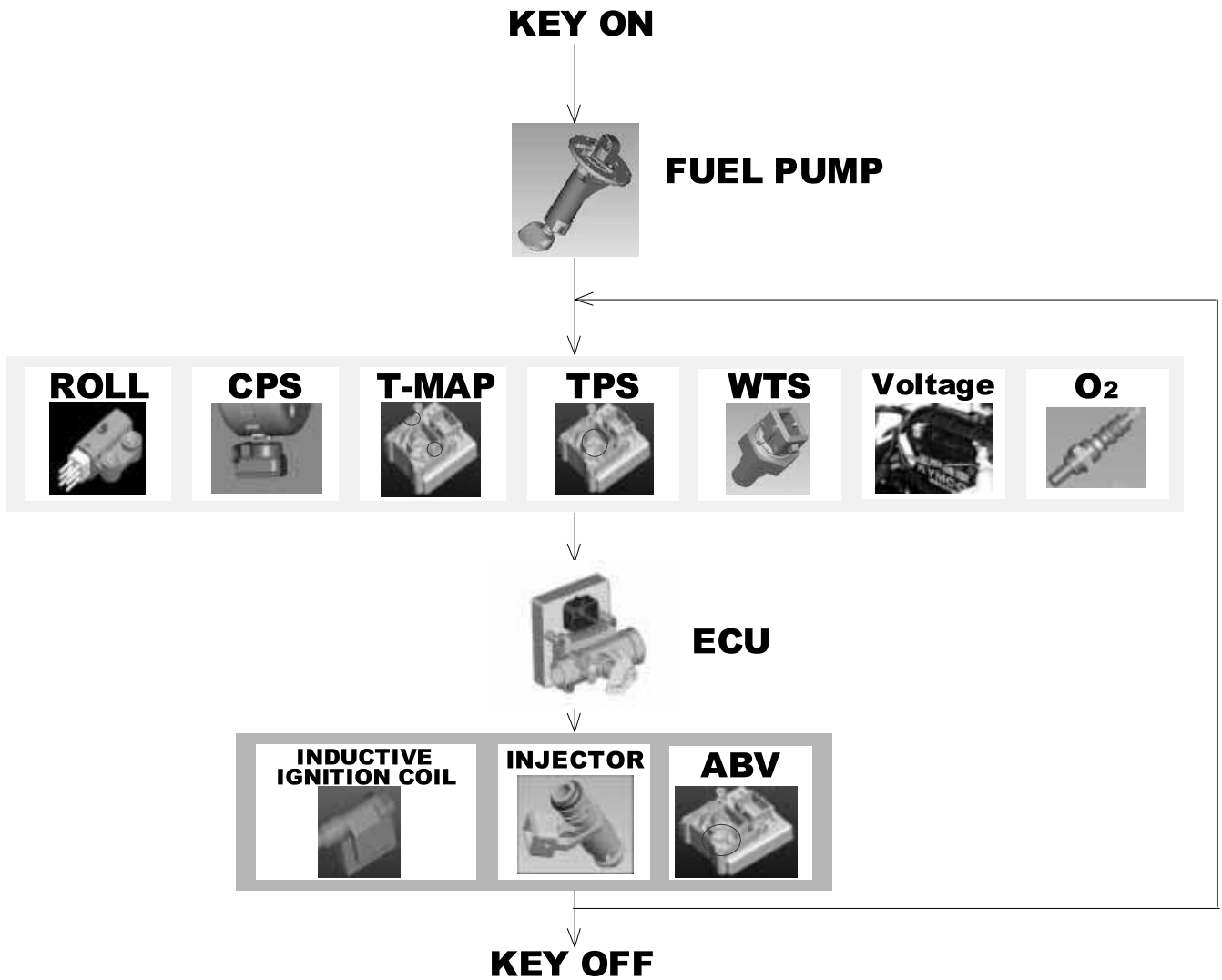

5. Fi INJECTION SYSTEM

Fi PARTS DRAWING

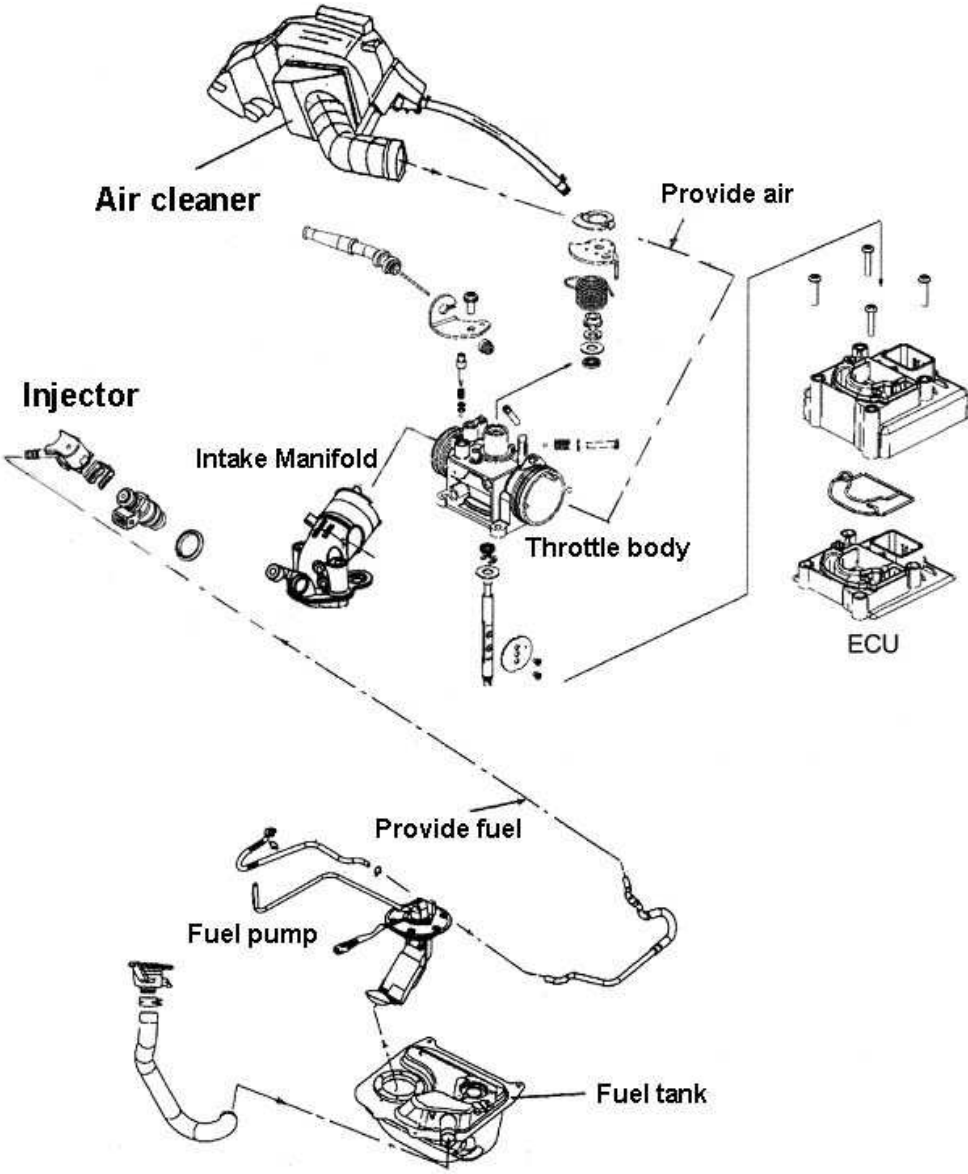

5. Fi INJECTION SYSTEM

SERVICE INFORMATION

GENERAL INSTRUCTIONS

Gasoline is very dangerous. When working with gasoline, keep sparks and flames away from the working area.
Gasoline is extremely flammable and is explosive under certain conditions. Be sure to work in a well-ventilated area.

- Disconnect the cables of the battery when the engine is running, which could lead to ECU damage.
- Connect the harness positive (+) cable to the battery negative (-) terminal or connect the harness negative (-) to the battery positive (+) terminal, which could lead to ECU damage.
- Always keep fuel over 750 cc in fuel tank.

SPECIFICATIONS

Item		Standard	
Charging voltage of battery		> 12V	
Voltage from the ECU to sensor		5±0.1V	
Fuel injector resistance (20°C/68°F)		10.6Ω ~ 15.9Ω	
Engine temperature sensor resistance		11.15KΩ ±7.45% (25°C)	
Throttle position sensor voltage		Idle (0°)=0.23±0.05V Throttle fully (90°) >3.27V	
Fuel pump resistance (20°C/68°F)		F: about 7Ω ±3Ω E: about 95Ω ±5Ω	
O2 sensor	O2 sensor heater resistance	6.7Ω~9.5Ω (two white wires)	
	Voltage	Air/Fuel<14.7 (Rich)	> 0.80V
		Air/Fuel>14.7 (Lean)	< 0.18V

Item	Standard
Crank position sensor (Pulser) resistance (20°C/68°F)	96Ω~144Ω
Inductive ignition coil resistance (20°C/68°F)	0.55~0.75Ω (for primary coil)
Roll sensor voltage	Normal: 0.4~1.44V Over 65° fall down: 3.7~4.4V
Idle speed	1800±100 rpm

5. FI INJECTION SYSTEM

TROUBLESHOOTING

Engine won't start

- Battery voltage too low
- Fuel level too low
- Pinched or clogged fuel hose
- Faulty fuel pump operating system
- Clogged fuel filter (fuel pump)
- Clogged fuel injector
- Faulty spark plug or wrong type
- Cut by ECU due to angle detect sensor or incorrect function

Backfiring or misfiring during acceleration

- Ignition system malfunction

Poor performance (drive ability) and poor fuel economy

- Pinched or clogged fuel hose
- Faulty fuel injector

Engine stall, hard to start, rough idling

- Intake air leak
- Fuel contaminated/deteriorated
- Pinched or clogged fuel hose
- Idle speed misadjusted

5. Fi INJECTION SYSTEM

CHECK ENGINE LAMP (CEL)

- When turning on the switch, the lamp will be lighted for two seconds then off. Let user to know the lamp is available and connect to ECU.
- If the CEL starts to blink or keep lighting, could see the DTC on the time area of speedometer. It means something wrong with this vehicle, you had better to do the further check to find out the failure code to know which part get trouble
- There are three kinds of priority grade, let user to know what kind of trouble was happened.
- Priority grade 1: CELP blinks continuously. This is the most emergent situation like engine over heat. User should slowdown the riding and go to dealer for checking immediately.
- Priority grade 2: CELP lights all the time. It means components gets trouble or circuit something wrong. Do the further check to find out the failure code to know which part get trouble.
- Priority grade 3: CELP just blinks once suddenly and then disappear. It sometimes just warning like the RPM was too high in a short term.

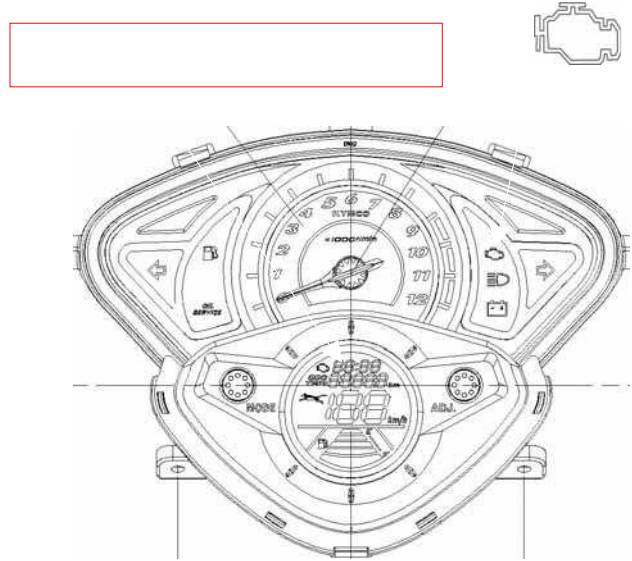

PRIORITY	LAMP ACTION
1	ON OFF
2	ON OFF
3	ON OFF

5. Fi INJECTION SYSTEM

How To Show Failure Code

- You can read the failure code by as below :
- Turn switch on. The CELP will be lighted for 2 seconds then off. The CELP start to blink to show the failure codes
- (The number of blinks from 1 to 25).
- If vehicle got more than one failure code, the CELP will be shown from lower number failure code and then show the other higher number one after four seconds. All the failure codes would be shown repeatedly.

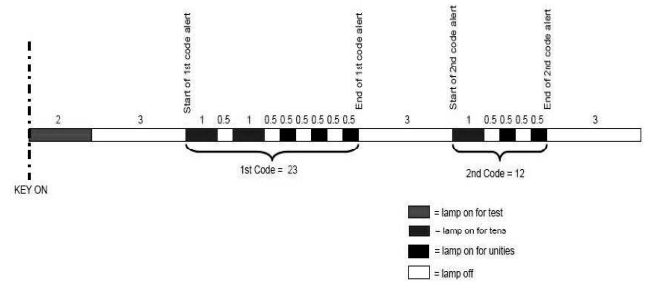

How To Reset Failure Code

- After repairing the trouble, you should clear the failure code or it will still exist in the ECU memory. When you maintain for this vehicle next time, it will show again and you get confuse.
- Turn switch on. The CELP will be lighted for two seconds then off.
- The CELP begins to blink to show the failure codes.
- The self-diagnosis memory data will be erased when all the failure codes has showed for four cycles.

5. Fi INJECTION SYSTEM

DTC Code List

Blink	Failure Codes	Fault description	Priority	Fault management
1	P0217	Engine temperature overheat	1	1.Slow down the vehicle and go to workshop for checking immediately. 2.Confirm if the engine temperature sensor or electric circuit is abnormality.
2	P0335	Crankshaft position sensor or circuit malfunction	2	1.Check if the connector of crankshaft position sensor is loosen. 2.Check if the Rotor is align with Crankshaft position sensor during the crankshaft running.
3	P1120	Throttle position sensor setting value problem	2	1.Make sure if the connector of Throttle position sensor is connected correctly. 2.Check if the Throttle position sensor is adjusted.
4	P1121	Throttle position sensor output range problem	2	1.Make sure if the connector of Throttle position sensor is connected correctly. 2.Check if the Throttle position sensor is adjusted.

5. Fi INJECTION SYSTEM

DTC Code List

Blink	Failure Codes	Fault description	Priority	Fault management
5	P1122	Throttle position sensor movement speed problem	2	<ol style="list-style-type: none"> 1.Make sure if the connector of Throttle position sensor is connected correctly. 2.Check if theThrottle position sensor is adjusted.
6	P0560	Battery voltage malfunction	1	<ol style="list-style-type: none"> 1. Check if the battery voltage is lower or higher. 2.Check if the charge system is malfunction.
7	P0110	Inlet air temperature sensor or electric circuit malfunction	2	<ol style="list-style-type: none"> 1. Check if the connector of Inlet air temperature sensor loosen. 2.Check if the resistance of sensor is normal .
8	P0410	Idle air valve or electric circuit malfunction	2	<ol style="list-style-type: none"> 1. Check if the connector of Idle air valve loosen. 2.Check if the resistance of valve is normal.
9	P0505	Idle speed volume control range	2	<ol style="list-style-type: none"> 1.Check if the opening angle is over 180 for Idle air valve. 2.Check if the opening angle is malfunction.
10	P0251	Injector or electric circuit	2	<ol style="list-style-type: none"> 1.Check if the connector of Injector is loosen. 2.Check if the ECU send signal to Injector. 3.Check if the power source and resistance of Injector are malfunction.

5. Fi INJECTION SYSTEM

DTC Code List

Blink	Failure Codes	Fault description	Priority	Fault management
11	P0350	Ignition coil or electric circuit malfunction	2	<ol style="list-style-type: none"> 1. Check if the connector of ignition coil is loosen. 2. Check if the ECU send signal to Ignition coil. 3. Check if the power source and resistance is malfunction.
12	P0230	Fuel pump relay or electric circuit malfunction	2	<ol style="list-style-type: none"> 1. Check if the connector of relay is loosen. 2. Check if the ECU send signal to relay. 3. Check the fuel pump relay resistance
13	P0219	Engine speed is over than top speed	2	Check if the belt of CVT is broken.
14	P1560	Sensor don't receive power source from ECU	2	<ol style="list-style-type: none"> 1. Check if ECU output DC5V to sensor. 2. Check if the power source of all sensor is DC5V. 3. Replace a new ECU if the CELP still blinks even the output power source of ECU is normal.
15	P0700	Engine starting speed exceed CVT speed limited	2	<ol style="list-style-type: none"> 1. Check if the throttle wire locked. 2. Check if the position of throttle screw is correct. 3. Check if the belt of CVT is broken.
16	P0115	Engine temperature sensor or electric circuit malfunction	2	<ol style="list-style-type: none"> 1. Check if the connector of sensor is loosen. 2. Check if ECU pin is broken. 3. Check if the resistance of sensor is malfunction.
17	P1561	Temperature gauge electric circuit malfunction	2	Don't use it at present.

5. Fi INJECTION SYSTEM

DTC Code List

Blink	Failure Codes	Fault description	Priority	Fault management
18	P0650	CELP electric circuit malfunction	3	<ol style="list-style-type: none"> 1. Check if the lamp of CELP is broken. 2. Check if wires of CELP is broken.
21	P0105	Atmospheric Pressure Sensor or electric Circuit Malfunction	2	<ol style="list-style-type: none"> 1. Check if the connector of sensor is loosen. 2. Check if ECU pin is broken. 3. Check if voltage of sensor is fit in specification.
22	P1110	Roll sensor or electric circuit malfunction	2	<ol style="list-style-type: none"> 1. Check if the sensor installation direction is correct. 2. Check if voltage of sensor is fit in specification. 3. Check if ECU pin is broken.
23	P0136	O2 sensor malfunction	1	<ol style="list-style-type: none"> 1. Check if the connector of sensor is loosen. 2. Check if ECU pin is broken.
24	P0141	O2 sensor heater malfunction	1	<ol style="list-style-type: none"> 1. Check if the connector of sensor is loosen. 2. Check if ECU pin is broken. 3. Check if the resistance of sensor is malfunction.
25	P0171	O2 sensor electric circuit malfunction	1	<ol style="list-style-type: none"> 1. Check if the connector of sensor is loosen. 2. Check if O2 sensor is blocked. 3. Don't follow a routine maintenance.

5. Fi INJECTION SYSTEM

SYNERJECT M3A ECU MODULE

1. Function and structure :

ECU module is designed to be used with DC 8~16V battery as its power resource, which combines ECU, TPS, ABV and T-MAP as a module, equips totally 32 functional pins. A microchip inside records a program to communicate and deal with all information. This module includes an interface loop to detect and handle the condition of engine, and has the driven loops for fuel injector, fuel pump and inductive ignition coil.

Intake air pressure sensor



TPS ABV

Intake air temperature sensor

2. Disassembly of ECU module :

(Except technician who has been qualified by KYMCO, disassembling this module will be forbidden)

1. Do not remove the ECU module before switching off.
2. Removing luggage box and fixed bolts of battery ⊕ ⊖ terminals (remove ⊖ terminal first, then ⊕ terminal).
3. To push the stopper and release the pulling rod of ECU module coupler. Rotate the rod while you hearing a click, remove the coupler.
4. To release screw, connecting pipe's bolt, inlet manifold and ECU module separately.
5. Releasing the fixed nut of the throttle cable and remove the cable.
6. To remove ECU module.
7. Removing four fixed screws to separate throttle body from ECU module.
8. Assembly would reverse the steps of disassembly.

ECU (ECU MODULE)



ECU module coupler

Rod

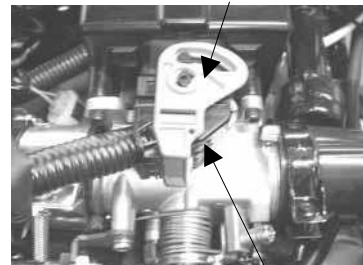

Stopper



ECU module is a precision electronic component, noticing items as following:

1. Don't put it in water.
2. Don't remove battery while the ignition switch is on or could burn the circuit of ECU.

5. Fi INJECTION SYSTEM

3. ECU Module Replacement

When switch is on and battery is connected, don't remove ECU module, connect additional wire or cut any wire.

1. Make sure to replace the ECU module after the ignition switch is turned off.
2. To identify if new ECU with certain version, check with sticker on ECU or with diagnostic tool.
3. To aim the axle of throttle at knob of TPS then assemble the ECU module and install to vehicle.
4. After assembling ECU module, to confirm if operating throttle smoothly and throttle back in position precisely when release acceleration.
5. Proceeding TPS initial and adaptation setting after replacing the ECU module would be necessary.
6. Connecting diagnostic tool to the diagnostic connector, to check if throttle position and output voltage from TPS are out of the range.

Item	Specification
TPS voltage	Idle (0°)=0.23±0.05V Throttle fully(90°) >3.27V

7. To run the engine till reaching the working temperature and check with diagnostic tool and refer to the related diagnostic report, to confirm all figures are fitted in standard. (Especially notice if there is any abnormal leaking symptom or unstable situation at idle speed)

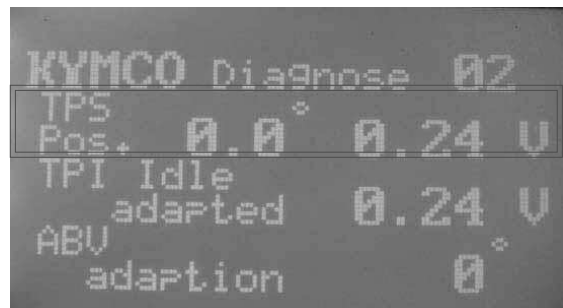

5. Fi INJECTION SYSTEM

ECU MOUDLE

Removal

- To dismantle the throttle cable
- To disconnect the coupler from ECU module
- To release the bolts of clamp of intake manifold
- To remove the vacuum pipe
- To remove the ECU module



First, push the stopper of coupler to release the rod, then pull back the rod to a lower fixed position after hearing click and then remove the coupler.

Assembly

- 1.To confirm there is no any damage for O-ring, which inside the throttle body set or replace it with a new one.
- 2.To confirm there is no any damage on rib of ECU set (yellow part in the illustration), damage on rib or o-ring would cause air leaking.
- 3.To aim the TPS's knob of ECU set to axle of throttle body then assemble the ECU module, tightening four fixed screws evenly with specific torque 0.3~0.37 kgf-m and install to vehicle.
- 4.Connecting diagnostic tool to the diagnostic connector, to check if throttle position and output voltage from TPS are out of the range.

If the voltage measured is out of the range, refer to page 5-16 as inspection or readjustment of the output voltage of throttle.

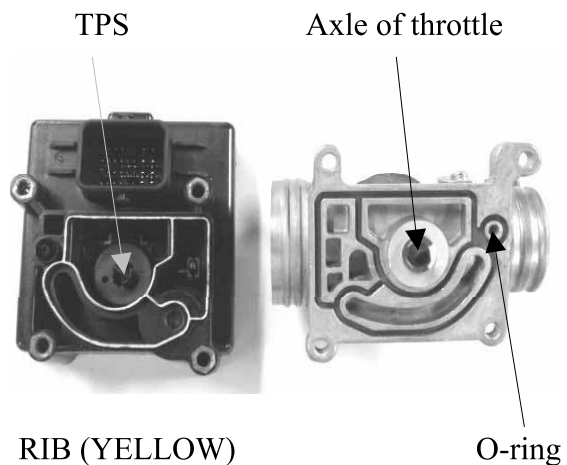
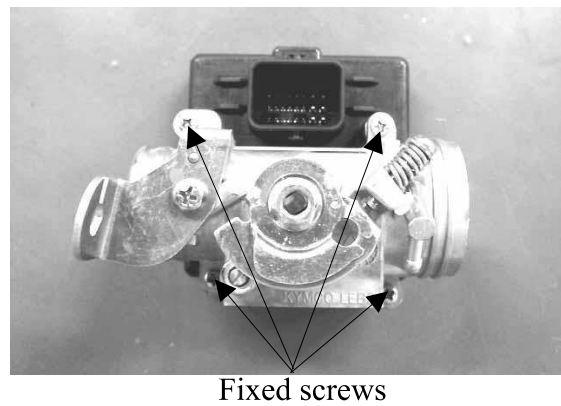
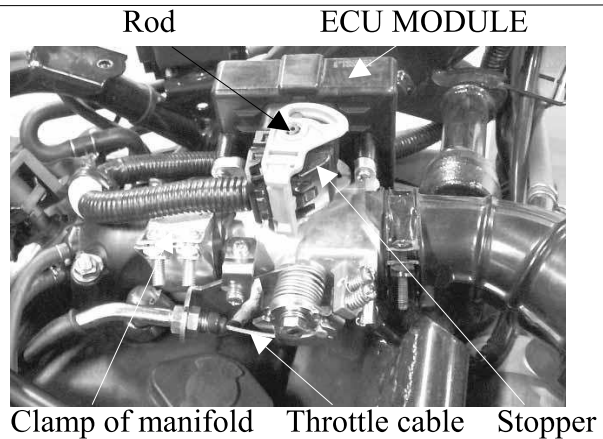

5. Fi INJECTION SYSTEM

ECU MODULE COUPLER

Installation

- 1.To confirm if the pulling rod of coupler is in a lower fixed position before installation or would fail to install the ECU module.
- 2.To install the coupler to ECU module (notice its direction).
- 3.To press the top of coupler with the finger and rotate the pulling rod by thumb at the same time, in the meantime, bumps of ECU seat should be engaged with the track of rod.
- 4.When the rod has been rotated to the top position, the stopper will fix the rod prevent from loosen, while you hearing a click, you have succeeded in installation.

Step 1



Step 2

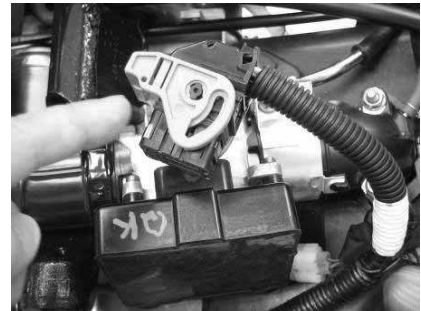

Step 3

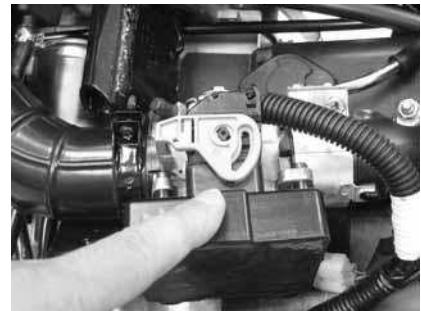

Step 4



Step 5

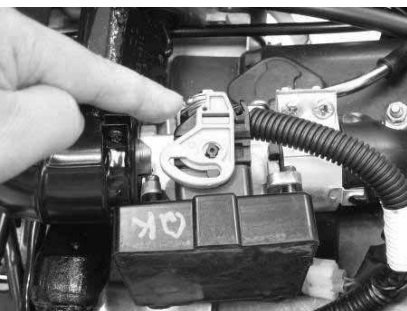

Step 6



5. Fi INJECTION SYSTEM

Removal

To push the stopper and release the pulling rod.
To ensure the rod back to the lowest fixed position, while you hearing a click, you have succeeded in removing the ECU module



ECU module and coupler are extremely expensive components just like which used in mobiles, so you need to remove and install the component carefully, prevent from increasing the maintenance cost by damaging components.

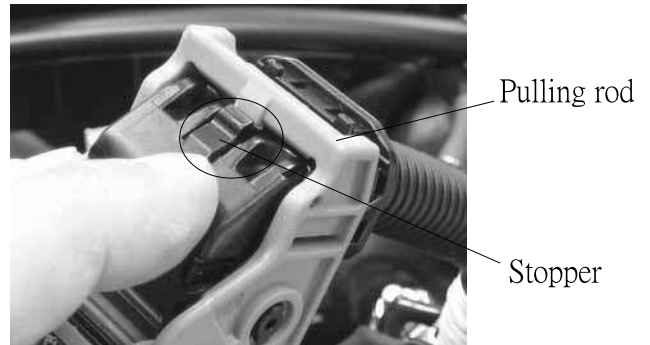

TO INITIAL TPS AND ABV

Switch off the vehicle and then switch on. (To ensure the engine is not running).

There is an initial terminal (pink wire) which is located beside the diagnostic cable. To ground the initial terminal to battery \ominus terminal or frame ground by an additional wire that will succeed in initialing TPS and ABV value which recorded in ECU.



After grounding the initial terminal, remove it back to original position, don't keep connecting this terminal.
Don't damage the sheath and initial terminal wire.

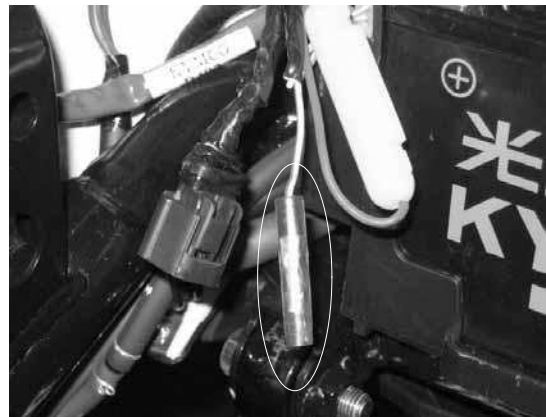

5. Fi INJECTION SYSTEM

ECU ADAPT THE NEW THOTTLE POSITION VOLTAGE

Switch on and off at least three times, then ECU will adapt the new throttle position setting, each action should be stayed for more than four seconds or ECU could fail to record the new position.

INSPECTION OR RE-ADJUSTMENT OF THE OUTPUT VOLTAGE OF THROTTLE

1. Full open the throttle and then full close it at least five times and record the voltage figure when vehicle in the idle speed, checking if voltage is out of the range $0.23 \pm 0.05V$, and the variations in those five values should be $\leq 0.03 V$.
2. Accelerating a bit , that means opening the throttle around 10° and then full close the throttle at least five times, then record the voltage when in idle speed, to check if voltage is out of the range $0.23 \pm 0.05V$, and the variations in those five values should be $\leq 0.03 V$.
3. If the results of both actions above are fitted in a standard specification, it means you have finished the setting. But if either of both results above is out of the range, you need to loosen four screws a bit and reseal evenly then repeat action 1 and action 2 to recheck voltage till they are fitted in standard then tighten screws in specific torque evenly.

5. Fi INJECTION SYSTEM

FUEL PUMP

Connect the voltmeter (+) probe to the red/black wire and the voltmeter (-) probe to the green wire to measure the voltage from the ECU input to fuel pump unit.

Standard : 8~16 V (Battery volt)

To measure the resistance of the fuel pump to see if it is short circuit or not.

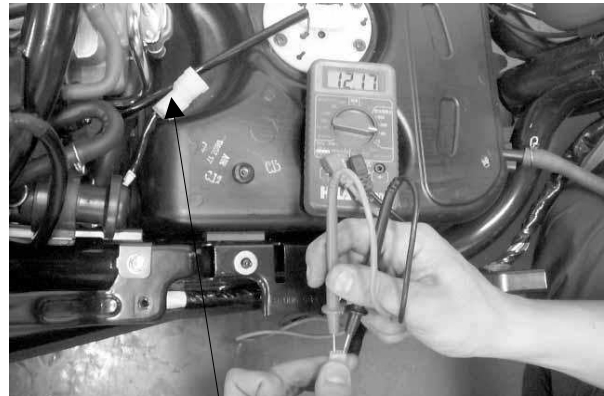

Connector

T-MAP (Manifold Air Temperature Pressure) Sensor

To connect the PDA or KYMCO Fi diagnostic tool.

Enter the Data Analyze item to check if the manifold pressure data is malfunction.

(Turn on the ignition switch but engine is not starting)

If the figure was incorrect, it means T-map sensor is problem.

Standard : 101.3 ±3 kpa

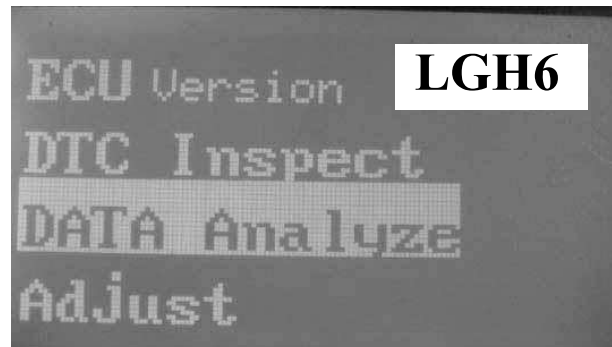

The ambient pressure drop about 12Kpa at the altitude every raised.



5. Fi INJECTION SYSTEM

TPS (Throttle Position Sensor)

Connect the PDA or KYMCO Fi diagnostic tool.
 Choose the Data Analyze
 Check if the TPS position data is malfunction.
 (Key switch ON but engine is not started)
 If data was incorrect when the idle and throttle fully opened, TPS is possible to be problem.

Standard:

Item	Specification
TPS voltage	Idle (0°)=0.23±0.05V Throttle fully(90°) >3.27V

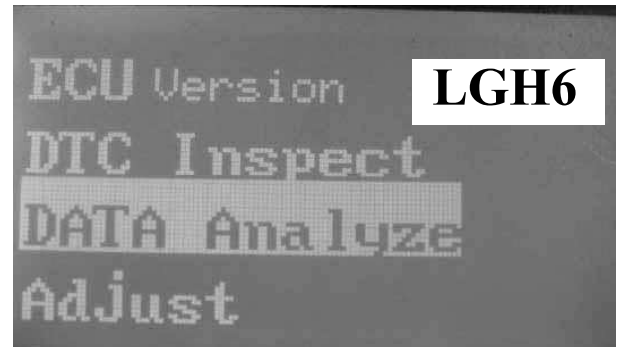
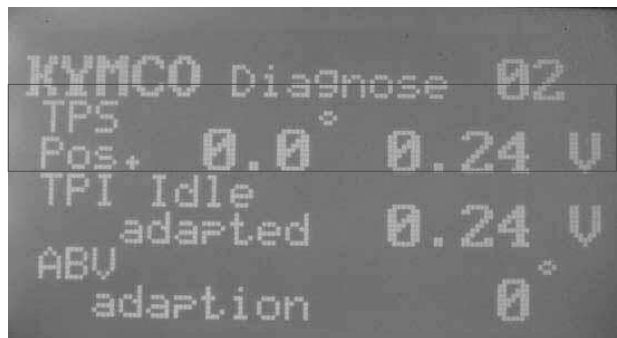
LGH6

Connector

ENGINE TEMPERATURE SENSOR

Removal

Remove the throttle body
 Dismantle the intake manifold
 Disconnect the connector of engine temperature sensor
 Remove the engine temperature sensor



Engine Temperature Sensor

Inspection

The ignition is turned off
 Disconnect the connector between engine temperature sensor and harness wires
 The ignition is turned on
 Measure the input voltage from ECU to engine temperature sensor, voltmeter probe to G L wire and voltmeter ○ probe to V G wire

Standard: 5±0.25V



Connector

5. Fi INJECTION SYSTEM

Measure the resistance for the engine temperature sensor's wires

Standard: 8.24~14.4KΩ

Torque: 60~90 kg-cm

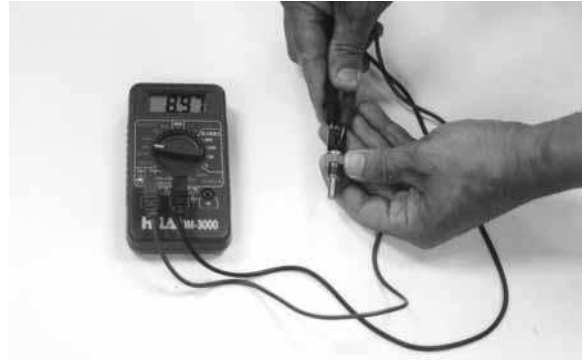

INJECTOR

Inspection

Measure the resistance of the Injector

Standard (20°C/68°F): 10.6~15.9Ω

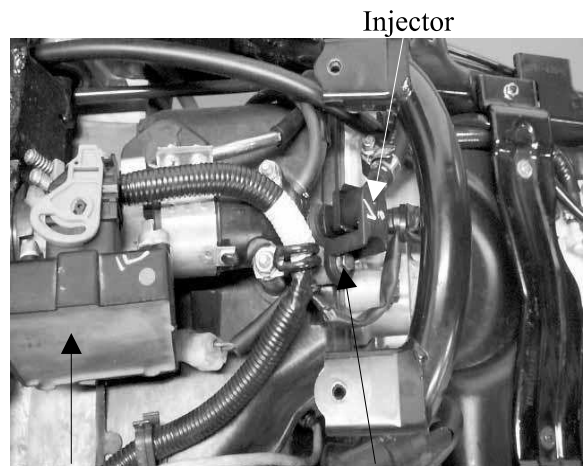

ECU

Bolt



Replace a new O-ring and lubricate with engine oil before installation.

The cleaner must be used for fuel injector special only.



5. FI INJECTION SYSTEM

FI Fuel Injector Cleaning Method

1. Condition: Fuel Injector can't spray fuel or spray with limited quantity
2. Cause: Fuel Injector blocked by carbon deposit
3. Method
 - 1) Clean Fuel Injector with Ultrasound Cleaner with House Made Device
 - 2) The level of detergent solution in the ultrasound tank shall not exceed the height of wiring receptacle of fuel injector
 - 3) Inject detergent at the inlet port of fuel injector and clean for 30 minutes, then it can be assembled to car to start
 - 4) The method of making House Made Device

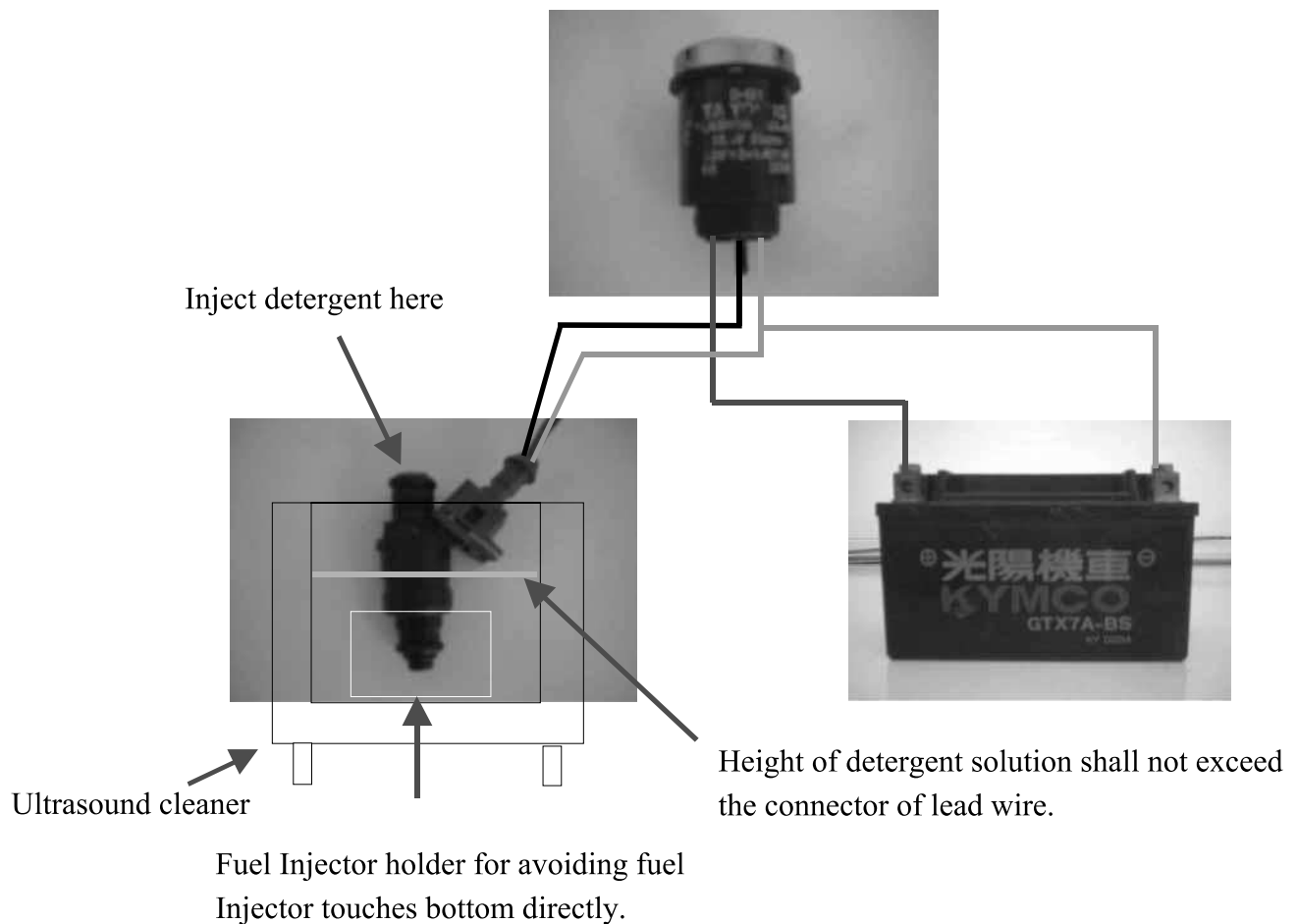

5. Fi INJECTION SYSTEM

O2 SENSOR

Measure the resistance of the O2 sensor heater.
(two white wire pins)

Standard (20°C/68°F): 6.7 ~9.5Ω

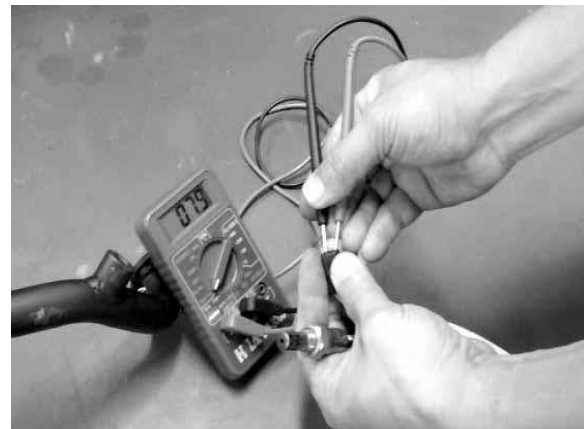
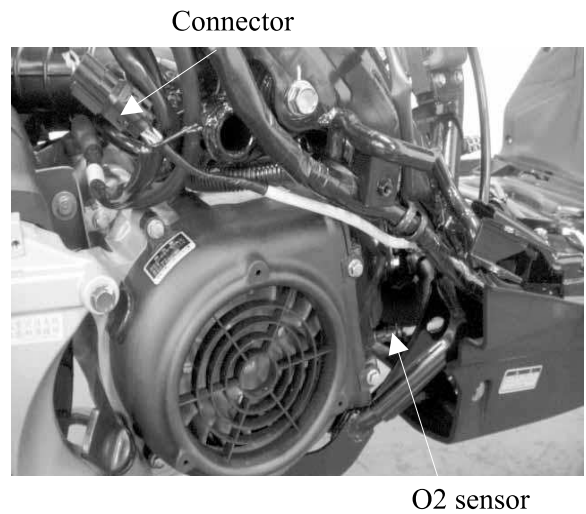

Connect the PDA or KYMCO Fi diagnostic tool.

Choose the Data Analyze

Check Page 05 (Key switch ON, then start engine till O2 heater activation is ON)

If the figure is wrong, the O2 sensor maybe a problem.

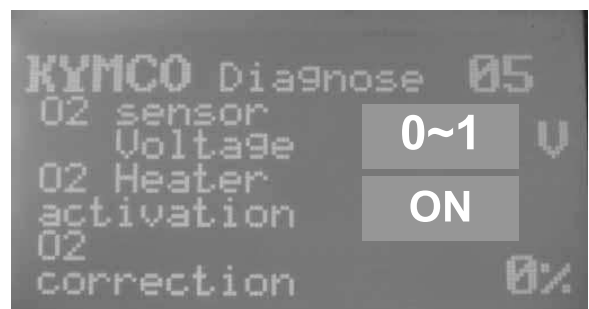

5. Fi INJECTION SYSTEM

ROLL SENSOR

The engine should be stopped running when the vehicle inclines over 65° for safety. When you place the vehicle back to normal situation, you have to key-off and key-on the switch, then it can be restarted.

Standard:

Normal: 0.4~1.4V

OVER 65° : 3.7~4.4 V

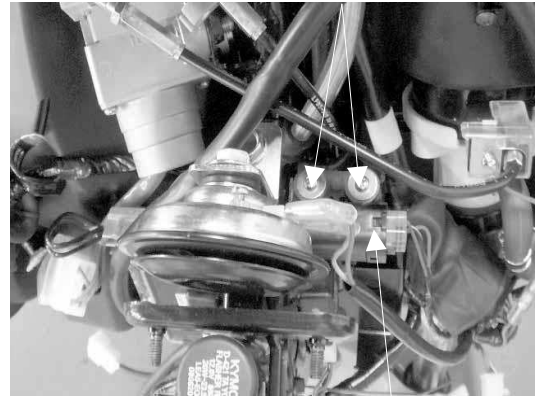

Roll sensor

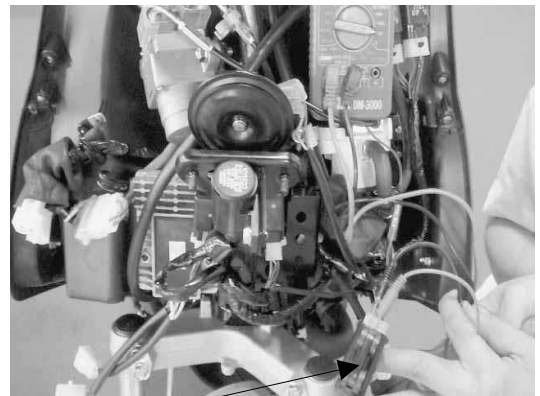

Roll sensor



5. Fi INJECTION SYSTEM



Adjust TP screw should not be allowed. The best engine working condition had already been adjusted by KYMCO, if any change, maybe cause to engine problem.

Connect the PDA or KYMCO Fi diagnostic tool.

Choose the Data Analyze

The ignition switch is turned on

Starting engine till working temperature 80°C

Check if the ignition advance data is malfunction.

If figure is over 20°C, you should adjust the air bypass adjustment screw for 1~1.5 turns (counterclockwise). Don't adjust the air bypass adjustment screw over 1.5 turns.

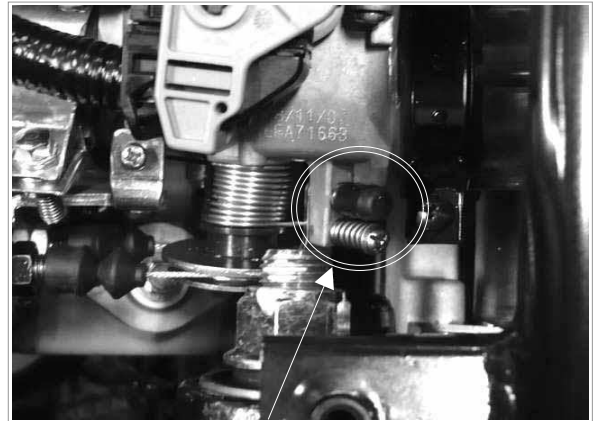

TP screw

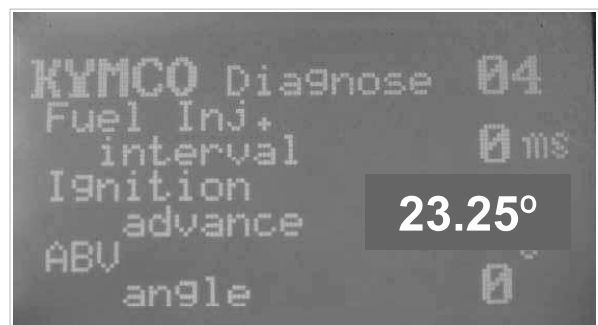

TPI and ABV Initialization

After replacing the throttle body or engine overhauled, the efficiency of air intake would be changed, have to do the TPI/ABV initialization process.

When the engine is started, turn off the ignition switch first and then turn it on again (keep the engine is off).

Use a test rod or wire clip short Reset (pink) wire to short with negative of battery or the earth of frame to reset TPI ABV.



After short, remove the test rod or wire clip. Don't let them connected all the time.

Do not break the PVC sleeve of Reset wire.



5. Fi INJECTION SYSTEM

MOVIE S 125i



Diagnostic Report

Movie S 125 Fi

Workshop
Date of
production

Customer
Date of
repair

Eng.Num
Mileage

Reason of repair: <input type="checkbox"/> maintenance <input type="checkbox"/> breakdown				
Item		Date	Reference	Memo
ECU Version	ECU No			
	Hardware Ver			
	Software Ver			
	Calibration Ver			
(Cool Engine) Engine Stop	Air Temp.		environ.temp ± 2 °C	
	Engine Temp.		environ.temp ± 2 °C	
	Atom. Pressure (Kpa)		101.3 ± 3 kPa	
	Throttle Position (TPS)		0° / 90° above	For throttle grip, closed / opened fully
	TPI voltage (V)		0.23V±0.05 / 3.27V above	For throttle grip, closed / opened fully
	TPI idle adapted voltage (V)		0.23V±0.05	
	Battery Volt (V)		>12 V	
	Transducer power supply volt (V)		5 ± 0.2 V	3.7 ~ 4.4V (vehicle is fallen down)
	Idle speed setpoint (rpm)		---	For engine running only, the figure is changed by cylinder head's temperature.
	ABV adapted value		---	
	Tilt switch volt (V)		0.4~1.44V (Main stand used only)	3.7~4.4V (Scooter is falled down only)
	ECU running time (hr)		---	
(Hot Engine) Before Repair	Engine Speed IDLE (rpm)		1800 ± 100 rpm	Engine working temperature is >80°C
	MAP Sample (kPa)		48~60 kpa	
	Injection duration (ms)		1.6~2.6 ms	The injection duration probably is over 2.8ms if engine temperature is less than 80°C
	Ign. Advance (°)		3°~20° BTDC	Adjusting the side adjusting screw to be 1-1.5 turns when the ignition advance exceed 20°
	Ign.Dwell duration (ms)		2.0 ~ 2.2 ms	
	Air Temp.(°C)		environ.temp ±2 °C	
	Engine Temp. (°C)		>110°C	
	IDLE CO(%)		1.8 ~ 2.8%	
COFPC		---		
ABVAngDurMech (°)		140°		
(Hot Engine) After Repair	EngineSpeed IDLE(rpm)		1800 ± 100 rpm	Engine working temperature is >80°C
	MAPSample (kPa)		42 ~ 51 kpa	
	Injection duration (ms)		2.5 ~ 3.5 ms	The injection duration probably is over 2.8ms if engine temperature is less than 80°C
	Ign. Advance (°)		10 ~ 14 BTDC	
	Ign.Dwell duration (ms)		2.0 ~ 2.2 ms	
	Air Temp.(°C)		environ.temp ±2 °C	
	Engine Temp. (°C)		environ.temp ±2 °C	
	IDLE CO(%)		1.8 ~ 2.8%	
COFPC		---		
ABVAngDurMech (°)		140°		
Repair description			Repair Process	

Fi Diagnostic Tool

Operation Instructions

Part No. 3620A-LEB2-E00



KEY FUNCTION

- | | |
|---------------------------------------|----------------|
| ① Model No. | ⑧ DATA Analyze |
| ② Down Button | ⑨ DTC Inspect |
| ③ DTC indicator(Failure codes) | ⑩ ECU Version |
| ④ Enter or Exit | |
| ⑤ Power indicator | |
| ⑥ UP Button | |
| ⑦ Adjust (TPI and ABV reset function) | |

5. Fi INJECTION SYSTEM

DTC INSPECTION PROCEDURE

Connect Fi diagnostic tool with the connector of harness wire located beside the Battery.



Diagnostic Tool Connector

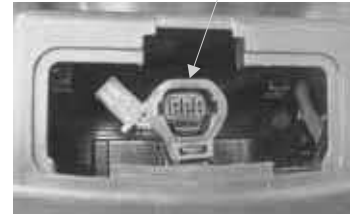

Press the "Enter" button

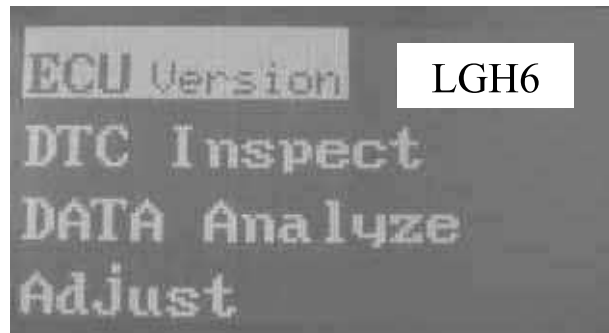

Check the software version

Press the "Enter" button and then turn to the first page.

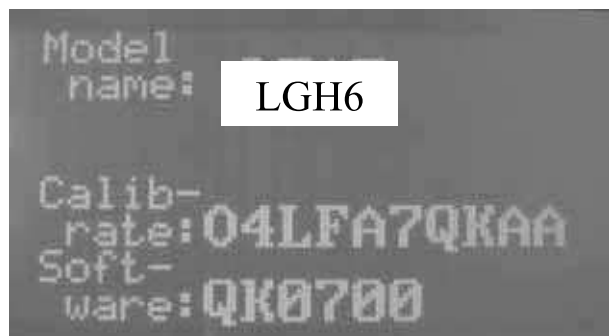

Press the "Down" button to enter the DTC Inspect.

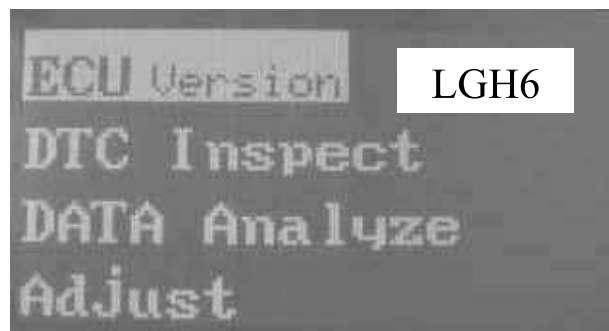

5. Fi INJECTION SYSTEM

Press the "Enter" button to check the DTC number

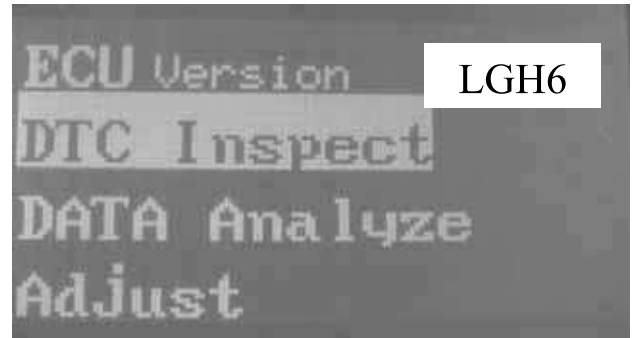

Press the "Enter" button

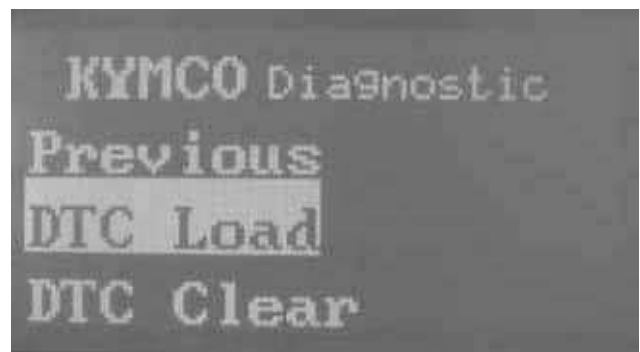

Press the "Enter" button

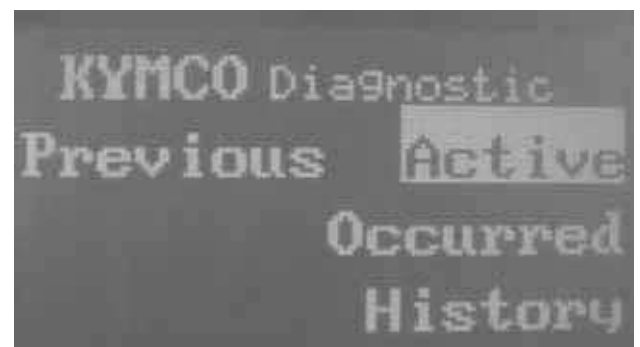

Display what's DTC number on this DTC-List.
Refer to DTC summary list.

Press the "Enter" button and then turn to the
previous page

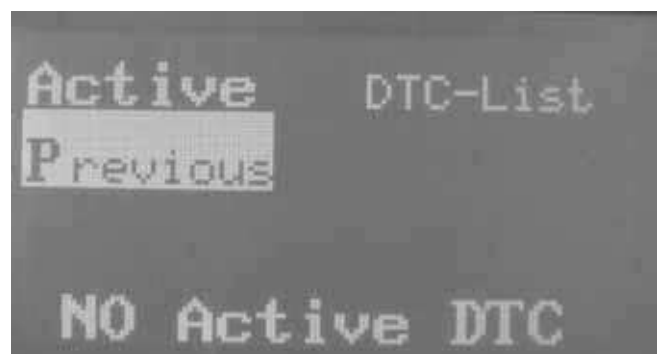

5. Fi INJECTION SYSTEM

Press the "UP" button

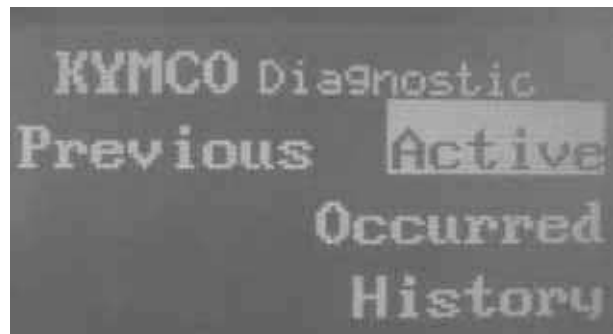

Press the "Enter" button and then turn to the previous page.

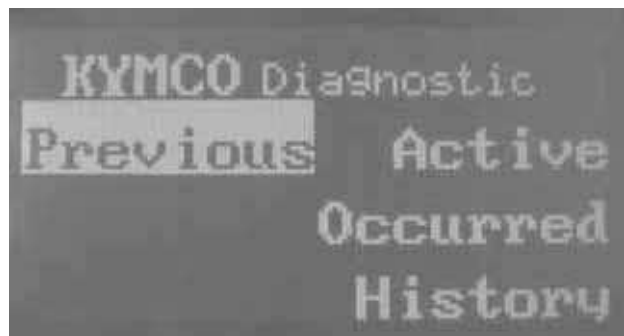

Press the "UP" button

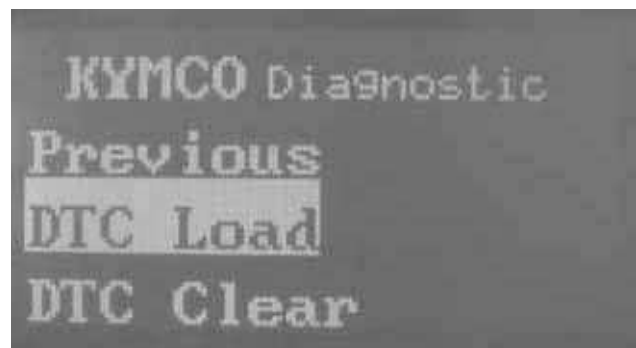

Press the "Enter" button and then turn to the first page.

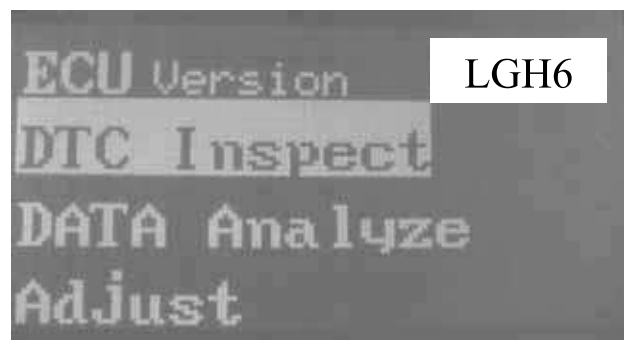

5. Fi INJECTION SYSTEM

DTC CLEAR PROCEDURE

Choose "Load DTC"

Press the "Down" button

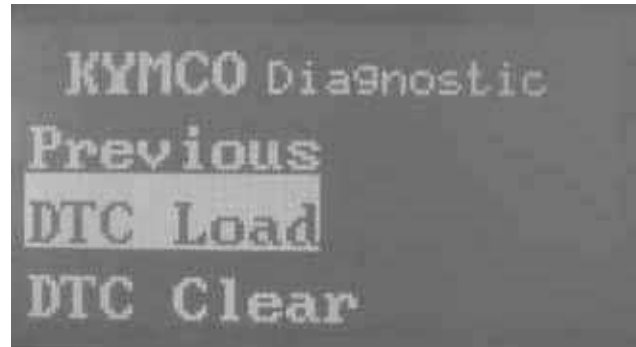

Press the "Enter" button

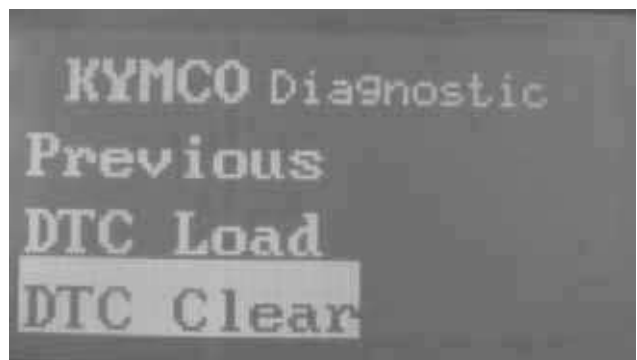

The DTC indicator is lighting at that time.



Clearing DTC completed until the DTC indicator is off.

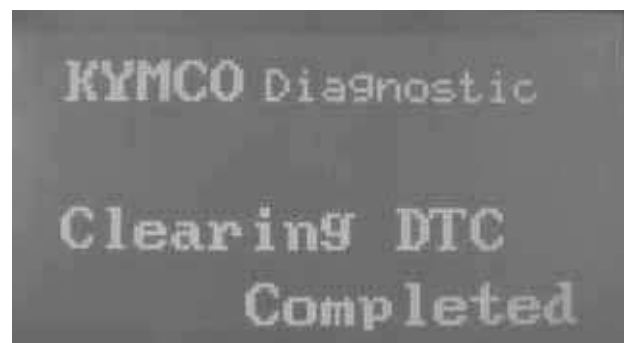

5. Fi INJECTION SYSTEM

DATA ANALYSIS

Choose "Data Analyze"

Press the "Enter" button to enter page 01.

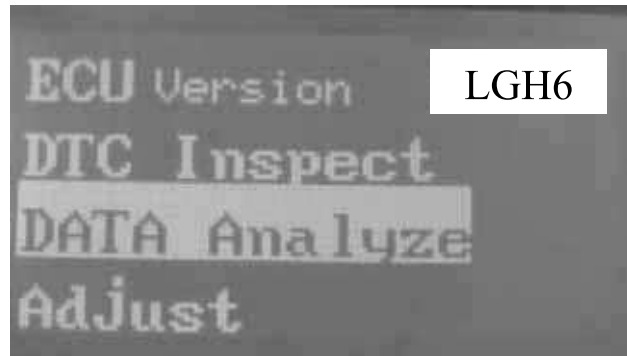

The figure includes engine speed, idle speed setpoint and battery voltage.

Refer to standard specifications .

Press the "Down" button to enter page 02.

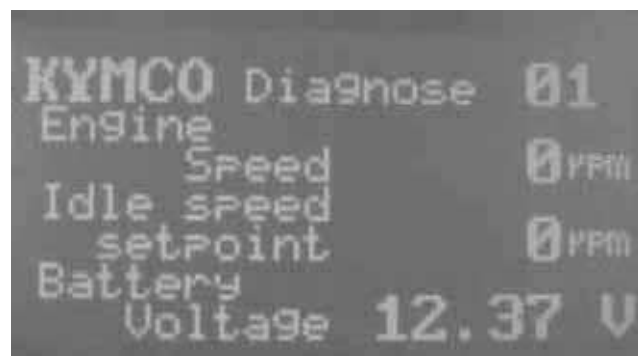

The figure includes TPS position, TPI idle adapted voltage and TPI WOT adapted (Throttle grip fully opened).

Refer to standard specifications .

Press the "Down" button to enter page 03.

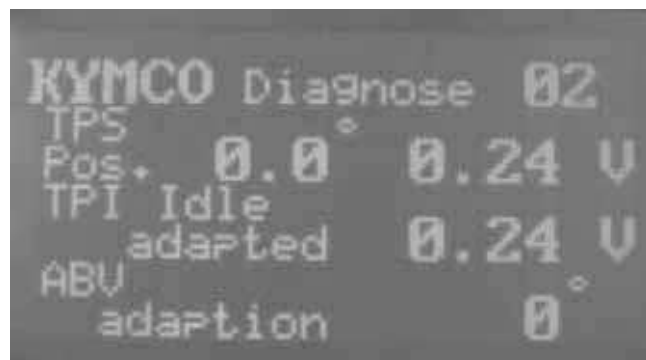

The figure includes engine working temperature, atmosphere pressure and Manifold pressure.

Refer to standard specifications on page 18-9.

Press the "Down" button to enter page 04.

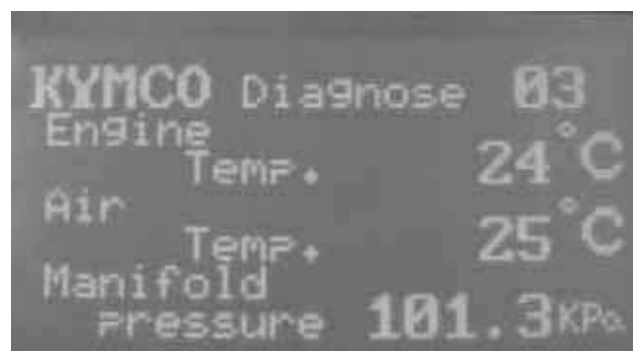

5. Fi INJECTION SYSTEM

The figure includes fuel injector interval, ignition advance angle and ABV angle.

Refer to standard specifications .

Press the " Down " button to enter page 05.

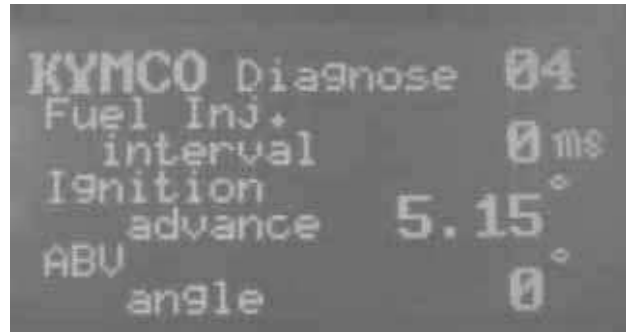

The figure includes O2 sensor voltage, O2 heater working condition and O2 correction.

Refer to standard specifications .

Press the " Down " button to enter page 06.



The figure includes rollover voltage .

Refer to standard specifications .

Press the " Down " button to enter page 07.

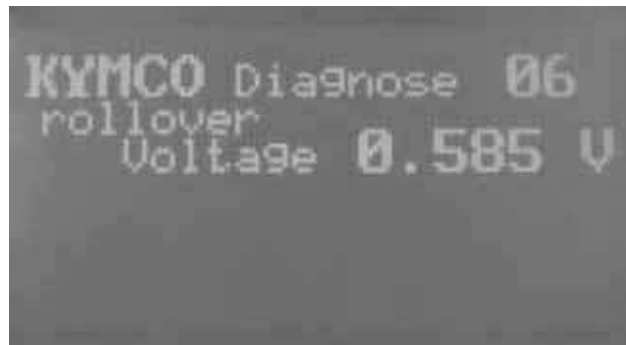

The figure includes ECU counter hours.

Press the " UP " button to the first page.

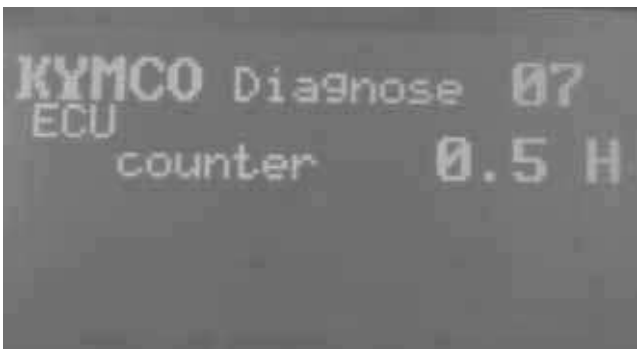

5. Fi INJECTION SYSTEM

ADJUST

Need to make TPI/ABV reset after changing new ECU and clean THROTTLE BODY and changing the engine department product, let ECU set up and set up initially

Choose "Adjust"

Press the "Enter" button to TPI/ABV Reset

Press the "Enter" button

Please key switch off and then key switch on

Completed the TPI/ABV reset operate.

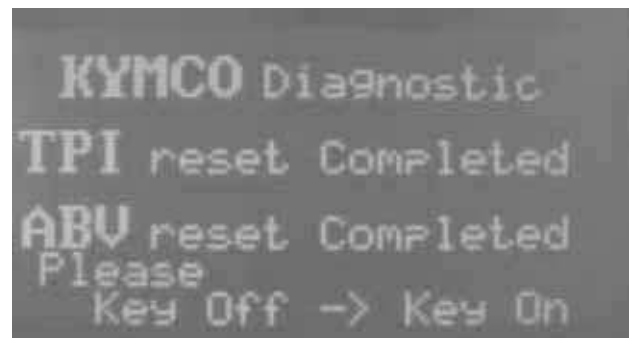
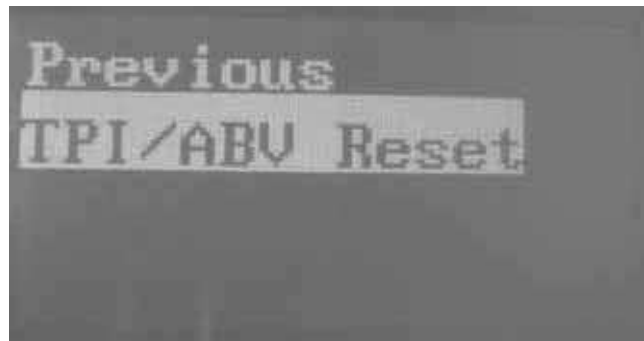
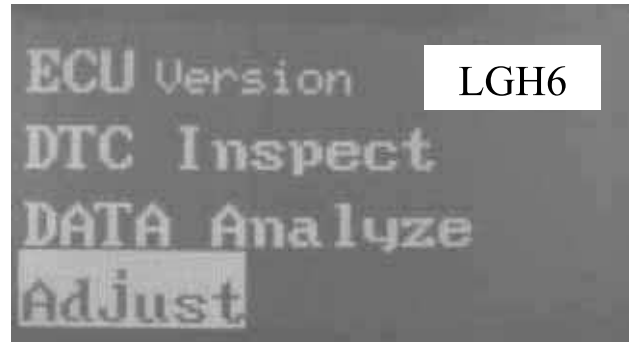

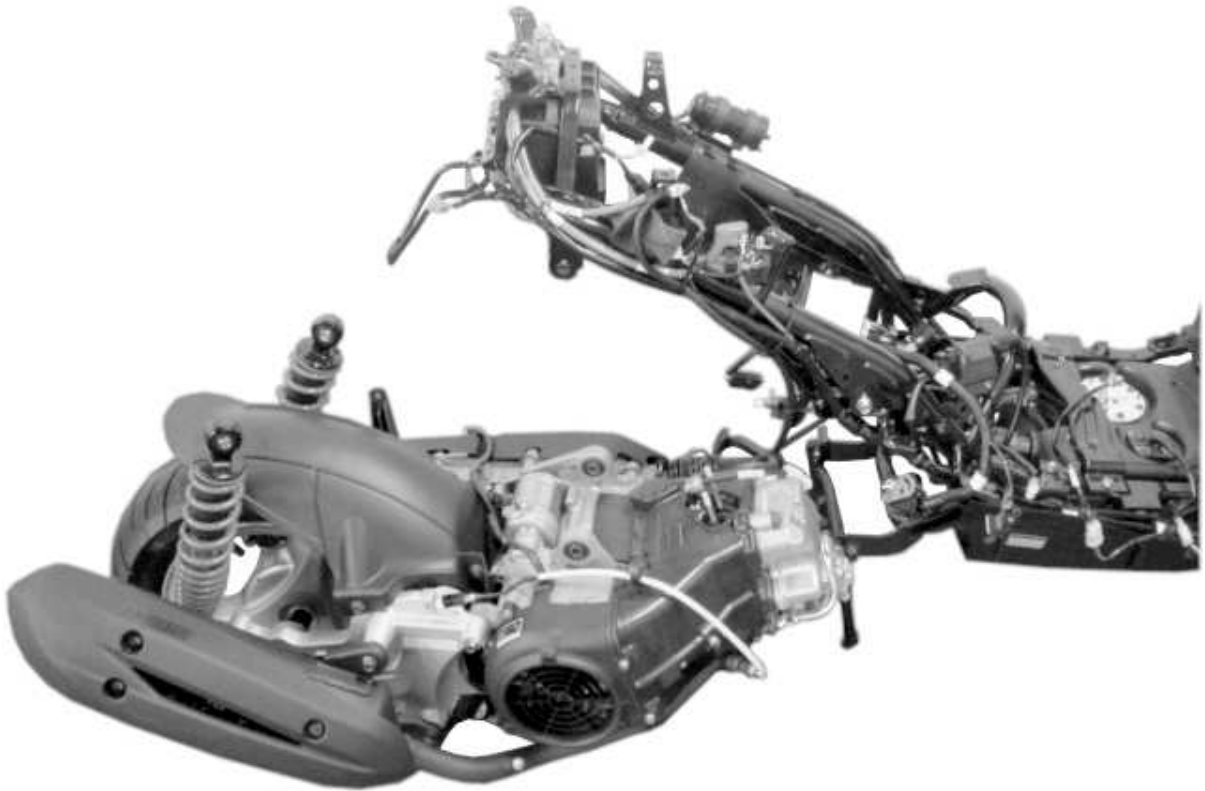

6. ENGINE REMOVAL/INSTALLATION

SERVICE INFORMATION	6 - 1
ENGINE REMOVAL	6 - 2
ENGINE INSTALLATION	6 - 4

SERVICE INFORMATION

GENERAL INSTRUCTIONS

The engine removal operation is required to support the engine. Be careful not to damage the motorcycle body, cables and wires during engine removal.

Use shop towels to protect the motorcycle body during engine removal.

Parts requiring engine removal for servicing:

- Crankcase
- Crankshaft

6. ENGINE REMOVAL/INSTALLATION

Movie S 125i

ENGINE REMOVAL

Disconnect the battery negative cable.
 Remove the frame body cover.
 Disconnect the engine negative cable.
 Disconnect the A.C. Generator wire connector.
 Disconnect the engine temperature sensor connector.
 Remove the rear brake caliper.
 Remove two nuts attaching to the intake manifold.

Battery Negative Cable Engine temperature sensor connector



A.C. Generator Wire Connector

Disconnect the starter motor cable from the starter relay.
 Remove the spark plug cap.
 Remove the ignition coil's wire.
 Remove the O2 sensor wire.
 Remove the bolt attaching to the rear suspension.

Starter Relay



Spark plug cap

Remove the injector's wire.
 Remove the throttle cable.
 Remove the vacuum tube.
 Remove the fuel tube attaching to injector.

Band Screw

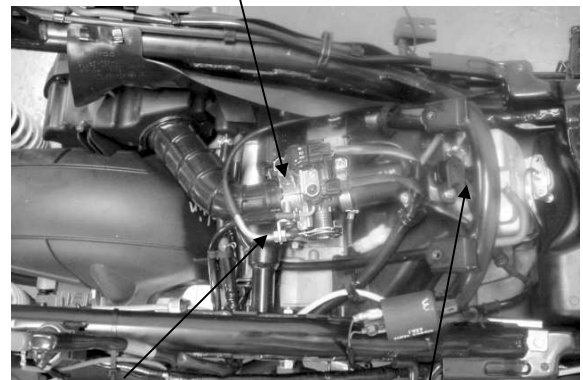

Throttle Cable

Injector Wire

Loosen the CVT's connecting tube band screw and remove the connecting tube.



Connecting Tube

6. ENGINE REMOVAL/INSTALLATION

Movie S 125i

Remove the air cleaner bolts.
Remove the rear brake adjusting nut, connecting pin and rear brake cable.

Brake Adjusting Nut

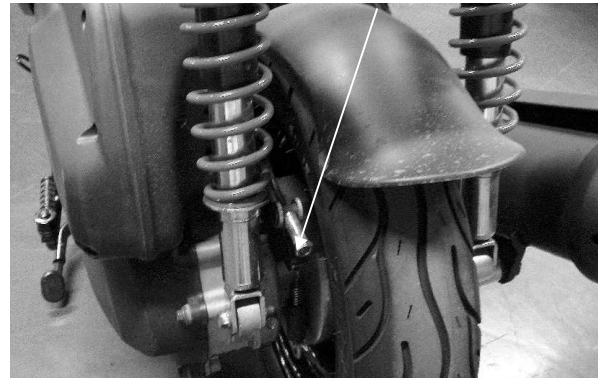

Remove the rear absorbers mounting bolt.

Rear Absorbers Mounting Bolt



Remove the engine mounting bolt and pull out the engine with the engine hanger bracket backward.

Engine hanger bracket

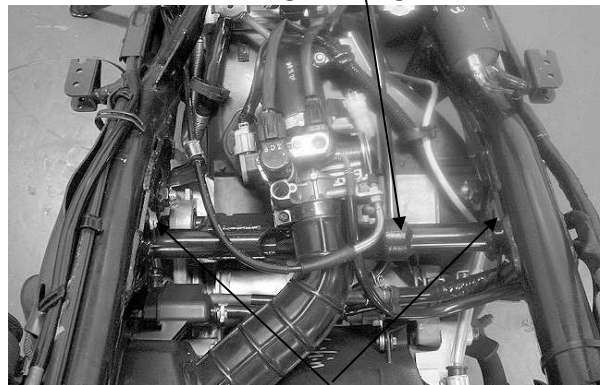

Engine Mounting Bolt

ENGINE HANGER BRACKET REMOVAL

Remove the engine hanger bracket bolt and nut.
Remove the engine hanger bracket.

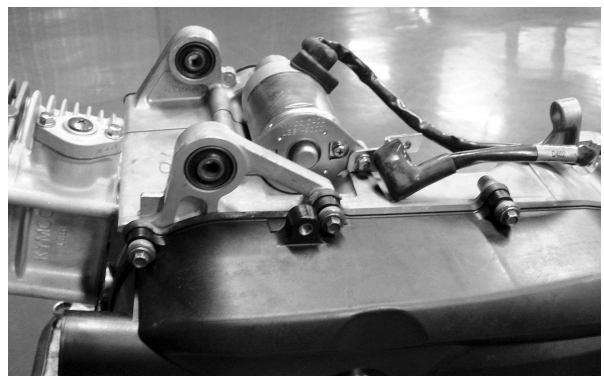

6. ENGINE REMOVAL/INSTALLATION

Movie S 125i

Inspect the engine hanger bushings and stopper rubbers for wear or damage.

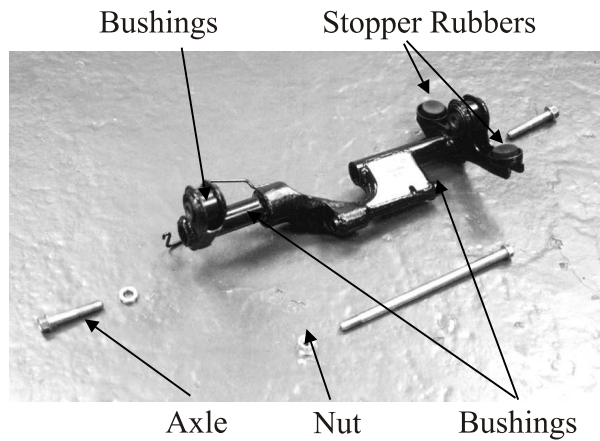

Engine Hanger Bracket

ENGINE HANGER BRACKET INSTALLATION

Install the engine hanger bracket to the engine.
Install the engine hanger bracket bolt and tighten the nut.

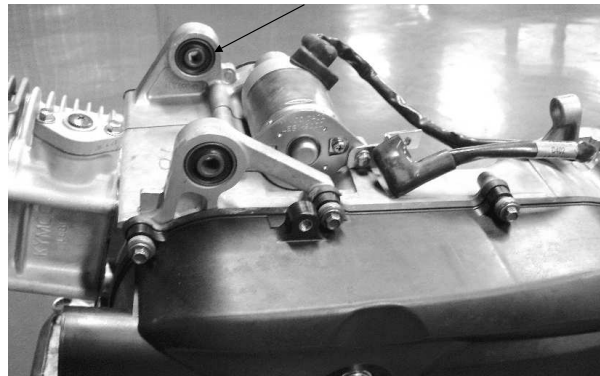

ENGINE INSTALLATION

Install the engine and tighten the engine mounting bolts.

Torque: 5.0kg-m

Tighten the rear shock absorbers mounting bolts.

Torque: 4.0kg-m

Engine Mounting Bolts



Install the removed parts in the reverse order of removal.

After installation, inspect and adjust the following:

- Throttle grip free play
- Rear brake adjustment

Rear Shock Absorbers Mounting Bolts



* Route the wires and cables properly.

7. CYLINDER HEAD/VALVES

7

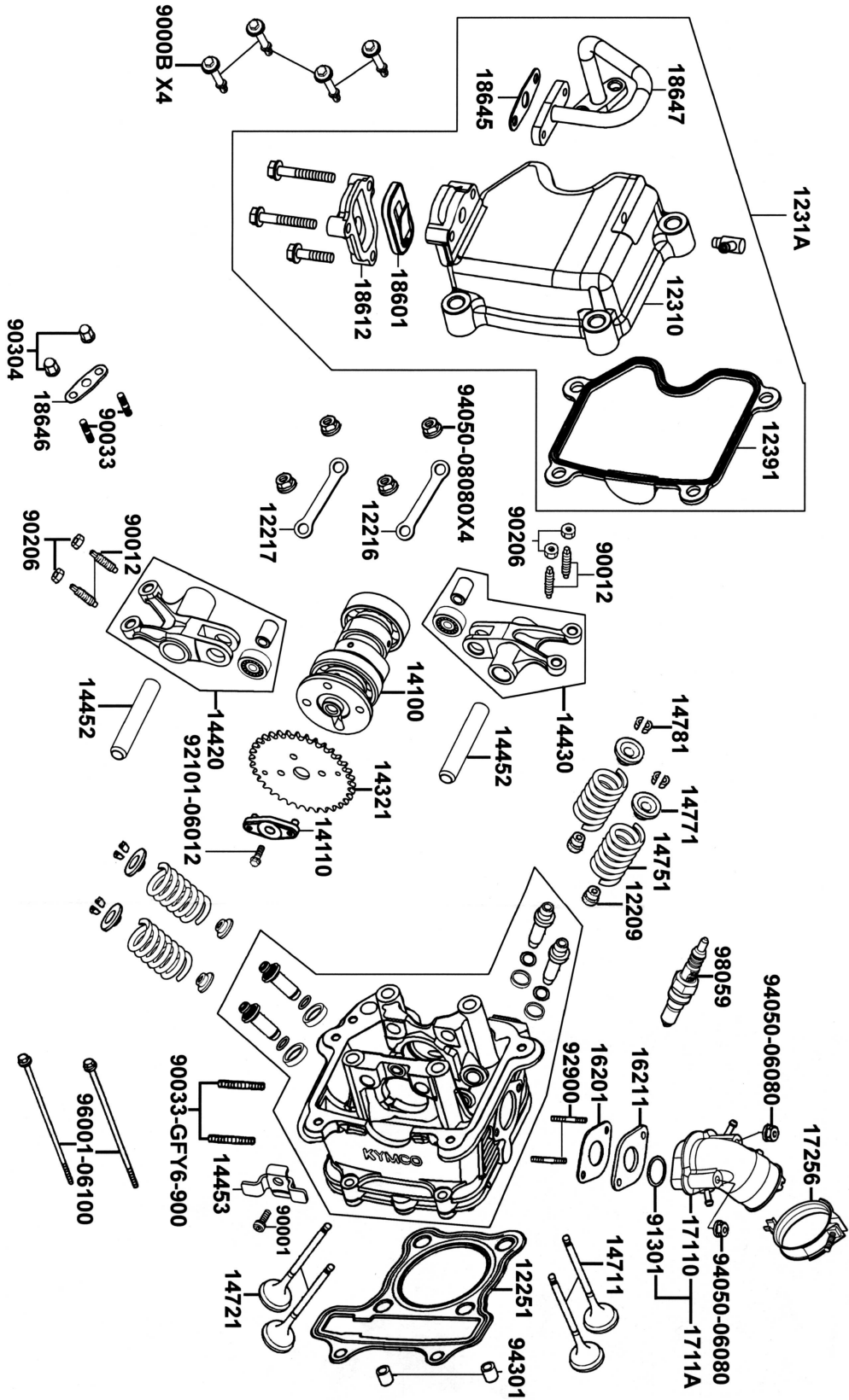

7. CYLINDER HEAD/VALVES

SERVICE INFORMATION	7 - 1	CYLINDER HEAD DISASSEMBLY	7 - 7
TROUBLESHOOTING	7 - 2	CYLINDER HEAD INSPECTION	7 - 8
CAMSHAFT REMOVAL	7 - 3	CYLINDER HEAD INSTALLATION	7 - 9
CYLINDER HEAD REMOVAL	7 - 6	CAMSHAFT INSTALLATION	7 - 10

SERVICE INFORMATION

GENERAL INSTRUCTIONS

The cylinder head can be serviced with the engine installed in the frame.

When assembling, apply molybdenum disulfide grease or engine oil to the valve guide movable parts, valve arm and camshaft sliding surface for initial lubrication.

The camshaft is lubricated by engine oil through the cylinder head engine oil passages. Clean the oil passages before assembling the cylinder head.

After disassembly, clean the removed parts and dry them with compressed air before inspection.

After removal, mark and arrange the removed parts in order. When assembling, install them in the reverse order of removal.

SPECIFICATIONS

Item		Standard (mm)
Valve clearance (cold)	IN	0.12
	EX	0.12
Cylinder head compression		15 kg/cm ² - 570 rpm
Cylinder head warp		—
Camshaft cam height	IN	25.965
	EX	25.810
Valve rocker arm I.D	IN	10.000-10.015
	EX	10.000-10.015
Valve rocker arm shaft O.D	IN	9.972-9.987
	EX	9.972-9.987
Valve seat width	IN	1.0
	EX	1.0
Valve stem O.D	IN	4.955-4.970
	EX	4.955-4.970
Valve guide I.D	IN	5.000-5.012
	EX	5.000-5.012
Valve stem-to-guide clearance	IN	0.010-0.037
	EX	0.030-0.057

7. CYLINDER HEAD/VALVES

TORQUE VALUES

Camshaft locating bolts	2.0 kg-m
Valve clearance adjusting nut	0.9 kg-m
Engine temperature sensor	0.75 kg-m

SPECIAL TOOL

Valve spring compressor E040

TROUBLESHOOTING

Poor performance at idle speed

Compression too low

Compression too low

1. Incorrect valve clearance adjustment
2. Burned or bent valves
3. Incorrect valve timing
4. Broken valve spring
5. Valve seat leak
6. Leaking cylinder head gasket
7. Warped or cracked cylinder head
8. Poorly installed spark plug

Compression too high

Excessive carbon build-up in combustion chamber

White smoke from exhaust muffler

1. Worn valve stem or valve guide
2. Damaged valve stem seal

Abnormal noise

1. Incorrect valve clearance adjustment
2. Sticking valve or broken valve spring
3. Damaged or worn camshaft
4. Worn cam chain guide
5. Worn camshaft and rocker arm

7. CYLINDER HEAD/VALVES

CAMSHAFT REMOVAL

Remove the secondary air intake rubber connector.
 Remove two bolts attaching to the secondary air intake tube.
 Remove four bolts to remove the cylinder head cover.

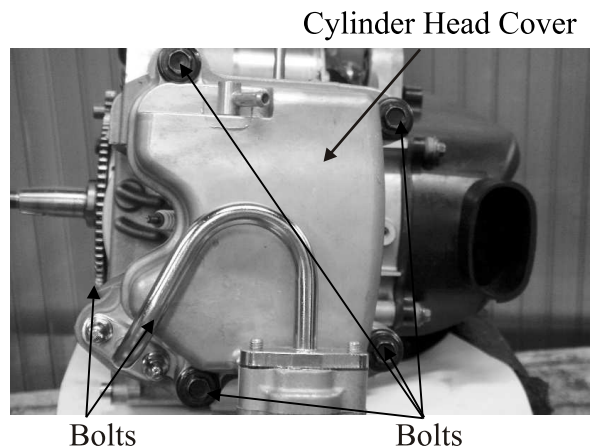

Remove the cam chain tensioner cap's screw and the O-ring.

Turn the cam chain tensioner screw clockwise to tighten it.

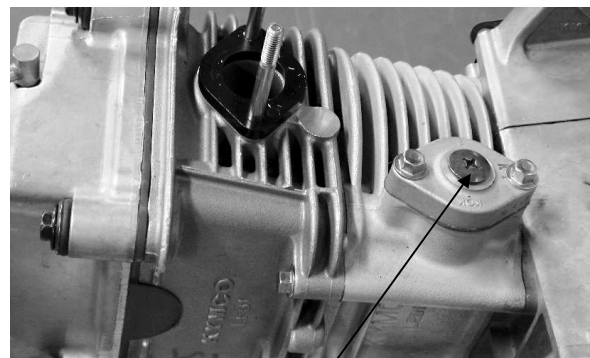

Turn the flywheel counterclockwise so that the "T" mark on the flywheel aligns with the index mark on the crankcase to bring the round hole on the camshaft gear facing up to the top dead center on the compression stroke.

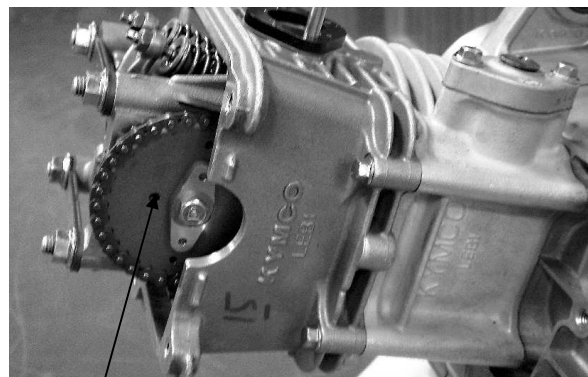

Remove two bolts attaching to the cylinder head.
 Remove four nuts attaching to camshaft holder.
 Remove two fix plate, which also has mark I and mark E.

* Diagonally loosen the cylinder head nuts in 2 or 3 times.

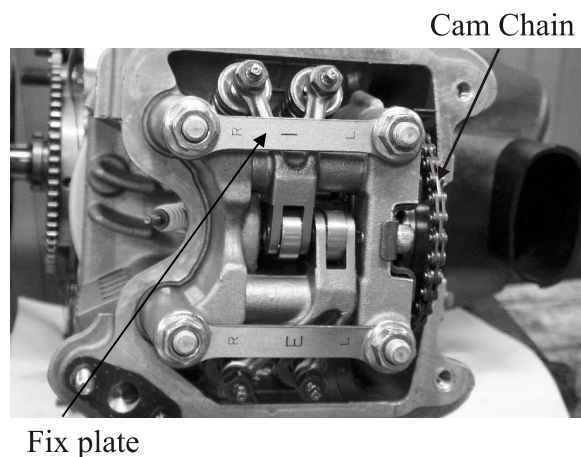

7. CYLINDER HEAD/VALVES

Remove the bolt attaching to cam chain.
Remove the cylinder head.

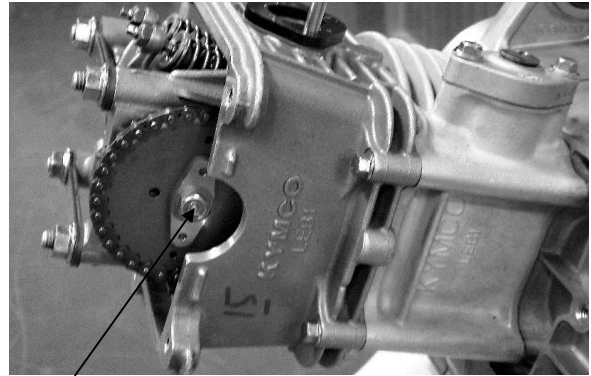

Bolt

Remove the inner six angle bolt attaching to camshaft holder.
Remove the fix plate.

Bolt with six angle inner Fix plate

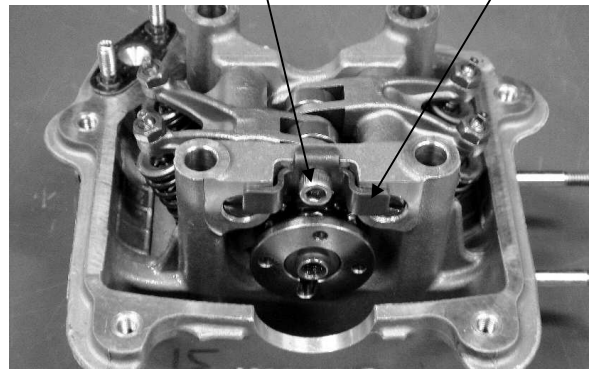

Take out the valve rocker arm shafts using a 5mm bolt.
Remove the camshaft and valve rocker arms.

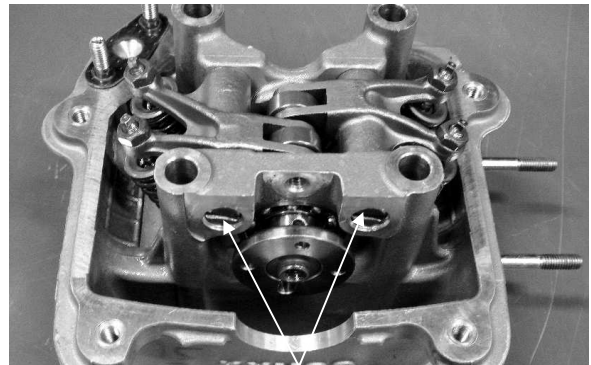

Rocker Arm Shafts

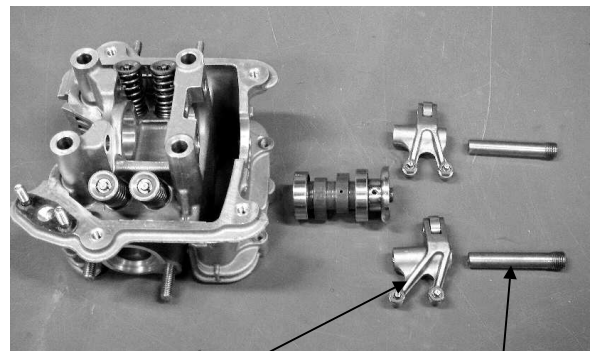

Rocker Arm Rocker Arm Shafts

7. CYLINDER HEAD/VALVES

CAMSHAFT INSPECTION

Check each cam lobe for wear or damage.
Measure the cam lobe height.

Service Limits:

IN : 25.57mm replace if below

EX: 25.41mm replace if below

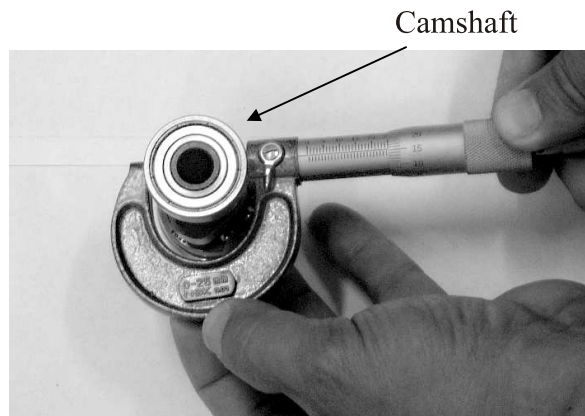

Camshaft

Check each camshaft bearing for play or damage.
Replace the camshaft assembly with a new one if the bearings are noisy or have excessive wear.

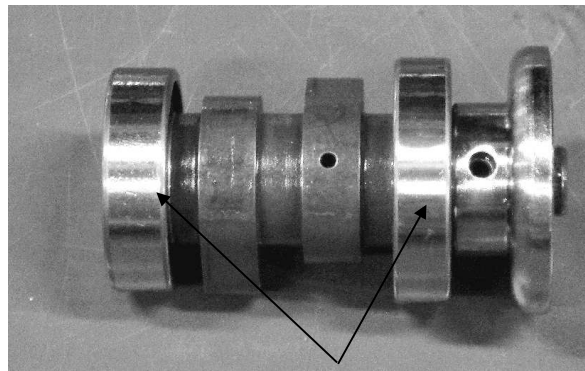

Bearing

CAMSHAFT HOLDER DISASSEMBLY

Take out the valve rocker arm shafts using a 5mm bolt.

Remove the valve rocker arms.

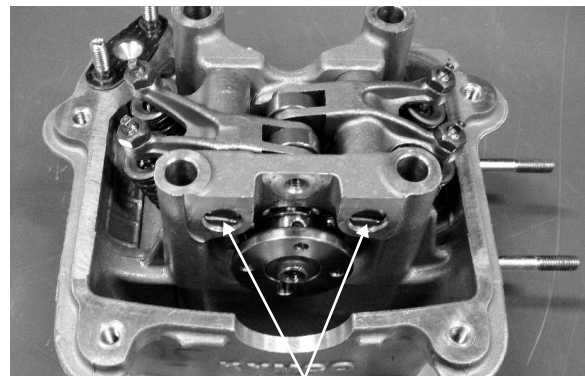

Rocker Arm Shafts

Inspect the camshaft holder, valve rocker arms and rocker arm shafts for wear or damage.

* If the valve rocker arm contact surface is worn, check each cam lobe for wear or damage.

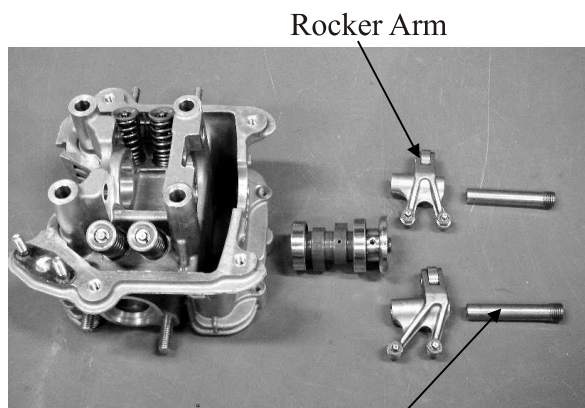

Rocker Arm

Rocker Arm Shafts

7. CYLINDER HEAD/VALVES

Measure the I.D. of each valve rocker arm.

Service Limits:

IN: 10.10mm replace if over

EX: 10.10mm replace if over

Measure each rocker arm shaft O.D.

Service Limits:

IN: 9.91mm replace if below

EX: 9.91mm replace if below

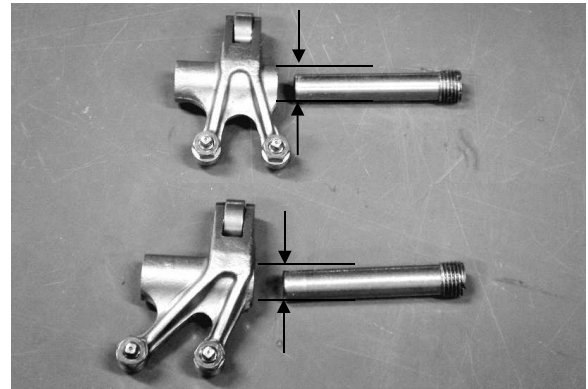

CYLINDER HEAD REMOVAL

Remove the throttle body.

Remove the intake manifold.

Remove the cylinder head cover.

Remove the camshaft.



Intake manifold

Remove the cooling fan cover.

Remove the engine cover bolts and screws.

Separate the engine cover joint claws.

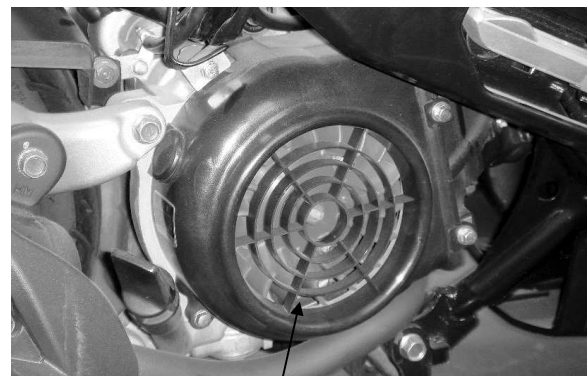

Fan cover

7. CYLINDER HEAD/VALVES

Remove the cylinder head.

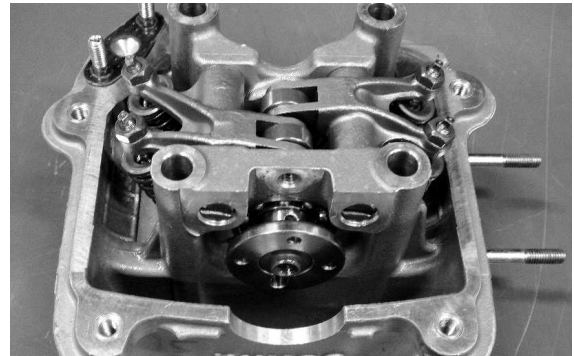

Remove the dowel pins and cylinder head gasket.
Remove the cam chain guide.

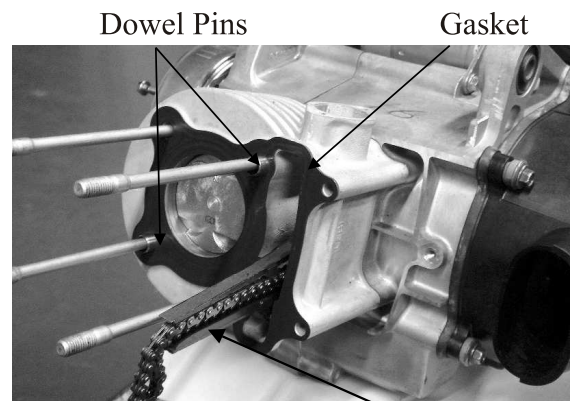

Cam Chain Guide

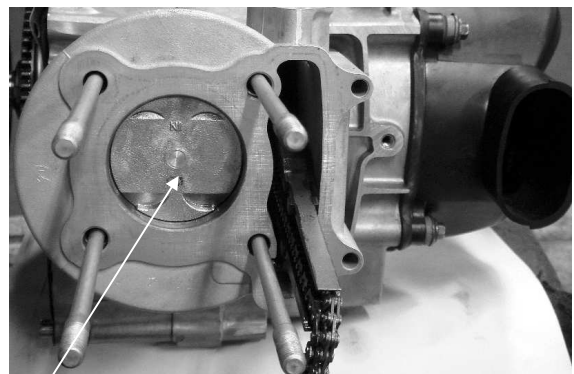

Piston

CYLINDER HEAD DISASSEMBLY

Remove the valve spring cotters, retainers, springs, spring seats and valve stem seals using a valve spring compressor.

* Be sure to compress the valve springs with a valve spring compressor.

Special

Valve spring compressor E040

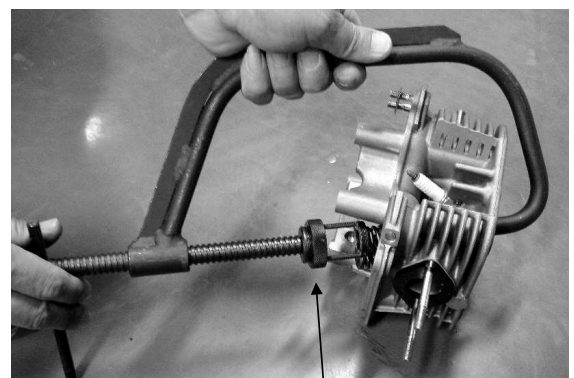

Valve spring compressor

7. CYLINDER HEAD/VALVES

Remove carbon deposits from the combustion chamber.

Clean off any gasket remnants from the cylinder head contact surface.

* Be careful not to damage the cylinder head mating surface.

Combustion Chamber

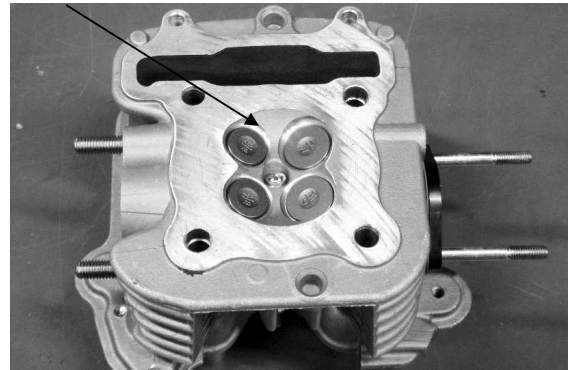

CYLINDER HEAD INSPECTION

Check the spark plug hole and valve hole areas for cracks.

Check the cylinder head for warpage with a straight edge and feeler gauge.

Service Limit: 0.05mm repair or replace if over

Valve

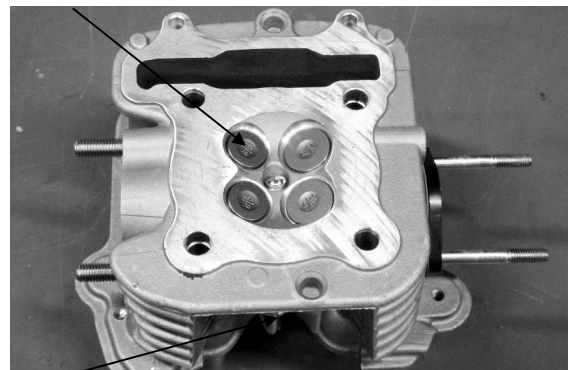

Spark plug

VALVE SPRING

FREE LENGTH

Measure the free length of the inner and outer valve springs.

Service Limits: 34.1mm replace if below

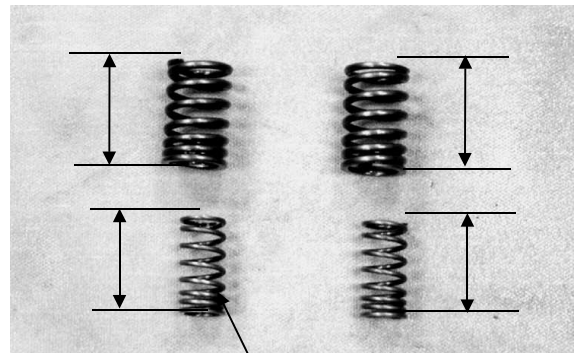

Valve Spring

VALVE /VALVE GUIDE

Inspect each valve for bending, burning, or abnormal stem wear.

Check valve movement in the guide.

Measure each valve stem O.D.

Service Limits: 4.9 mm replace if below

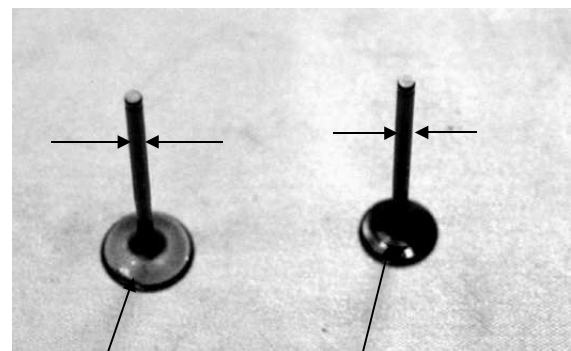

Intake valve

Exhaust valve

7. CYLINDER HEAD/VALVES

CYLINDER HEAD ASSEMBLY

Install the valve spring seats and valve stem seals. Lubricate each valve stem with engine oil and insert the valves into the valve guides. Be sure to install new valve stem seals.

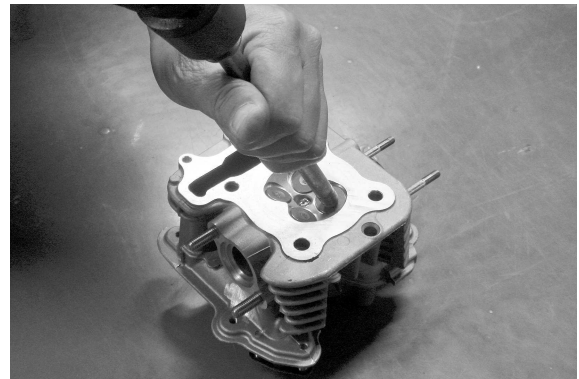

Install the valve spring.

Special

Valve spring compressor E040

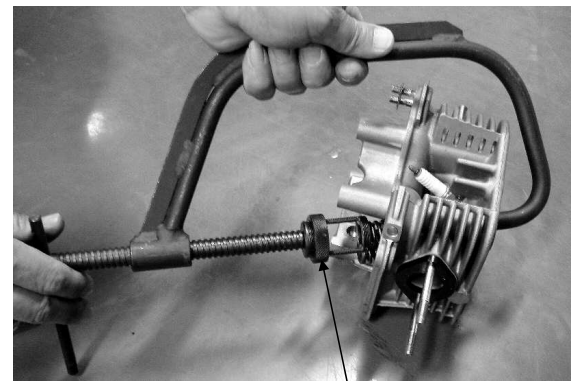

Valve spring compressor

Tap the valve stems gently with a plastic hammer for 2~3 times to firmly seat the cotters.

* Be careful not to damage the valves.

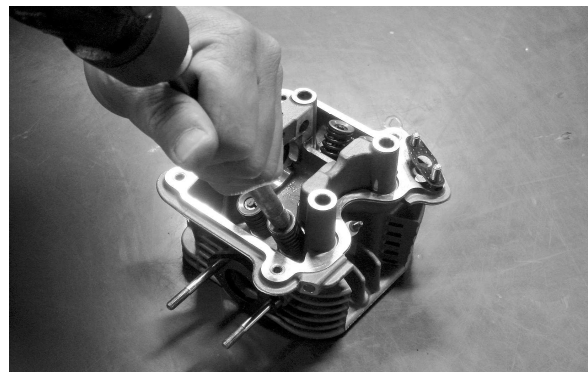

CYLINDER HEAD INSTALLATION

Install the dowel pins and a new cylinder head gasket. Install the cam chain guide.

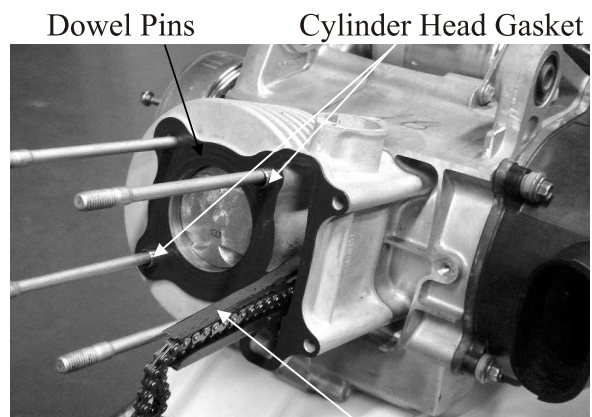

Cam Chain Guide

7. CYLINDER HEAD/VALVES

Install the cylinder head.

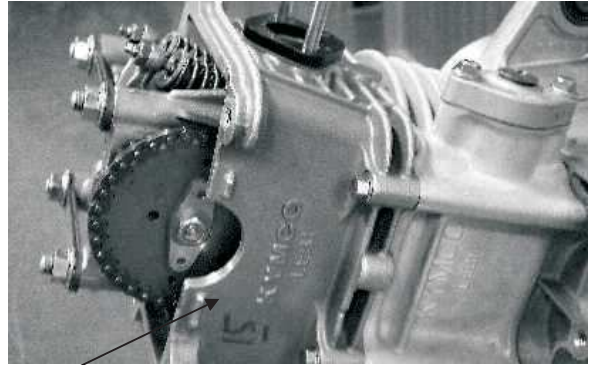

Cylinder Head

CAMSHAFT INSTALLATION

CAMSHAFT HOLDER

Install the exhaust valve rocker arm to the "EX" mark side of the camshaft holder.
Install the intake valve rocker arm and the rocker arm shafts.

Torque: Rocker Arm Shafts 5.5 N-m
(0.55 kgf-m , 3.96 lb-ft)

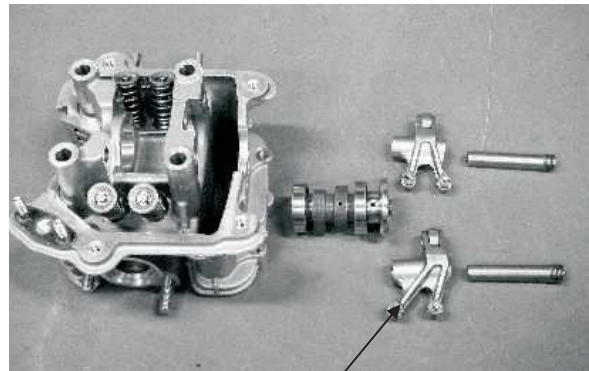

Rocker arm

Apply engine oil to a new O-ring and install it.
Tighten the cam chain tension cap screw.

* Be sure to install the O-ring into the groove properly.

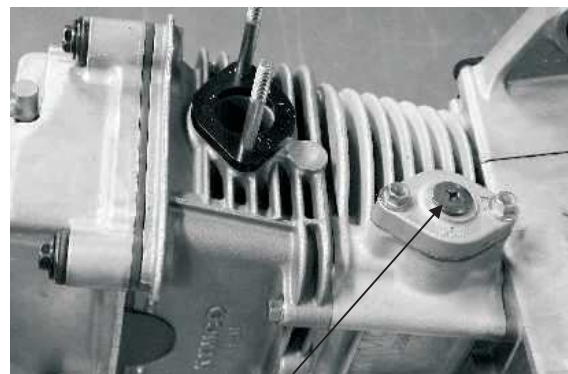

O ring

8. CYLINDER/PISTON

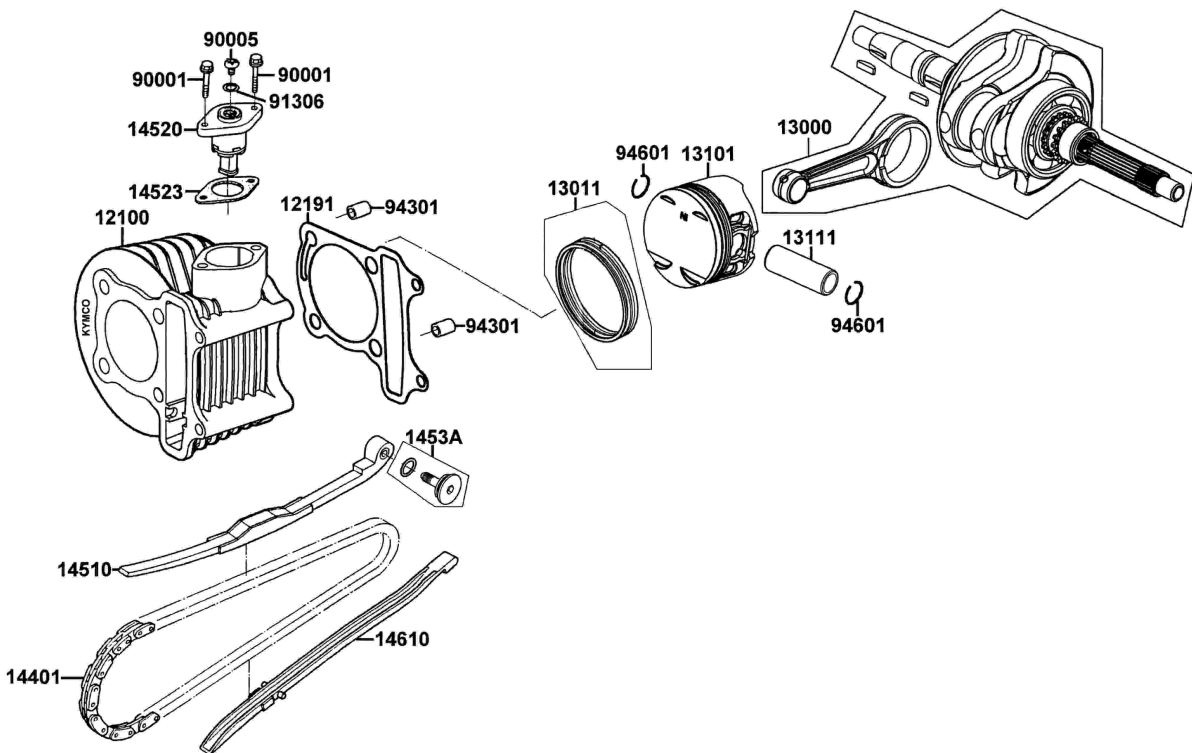

8

8. CYLINDER/PISTON

SERVICE INFORMATION.....	8-1	PISTON REMOVAL	8-2
TROUBLESHOOTING.....	8-1	PISTON INSTALLATION	8-6
CYLINDER REMOVAL.....	8-2	CYLINDER INSTALLATION.....	8-6

SERVICE INFORMATION

GENERAL INSTRUCTIONS

- The cylinder and piston can be serviced with the engine installed in the frame.
- After disassembly, clean the removed parts and dry them with compressed air before inspection.

SPECIFICATIONS

Item		Standard (mm)	
Cylinder	I.D.	54	
	Warpage	–	
	Cylindricity	–	
	True roundness	–	
Piston, piston ring	Ring-to-groov clearance	Top	0.015 -0.055
		Second	0.015 -0.055
	Ring end gap	Top	0.10 - 0.25
		Second	0.10 - 0.25
		Oil side rail	0.2 - 0.7
	Piston O.D.		53.37- 53.39
	Piston O.D. measuring		9mm from bottom of skirt
	Piston-to-cylinder clearance		0.101 -0.040
Piston pin hole I.D.		15.002 - 15.008	
Piston pin O.D.		14.994 - 15.000	
Piston-to-piston pin clearance		0.002 - 0.014	
Connecting rod small end I.D. Bore		15.016 - 15.034	

TROUBLESHOOTING

When hard starting or poor performance at low speed occurs, check the crankcase breather for white smoke. If white smoke is found, it means that the piston rings are worn, stuck or broken.

Compression too low or uneven compression

- Worn, stuck or broken piston rings
- Worn or damaged cylinder and piston

Compression too high

- Excessive carbon build-up in combustion chamber or on piston head.

Excessive smoke from exhaust muffler

- Worn or damaged piston rings
- Worn or damaged cylinder and piston

Abnormal noisy piston

- Worn cylinder, piston and piston rings
- Worn piston pin hole and piston pin

8. CYLINDER/PISTON

CYLINDER REMOVAL

- Remove the cylinder head.
- Remove the cam chain guide.
- Remove the cylinder.

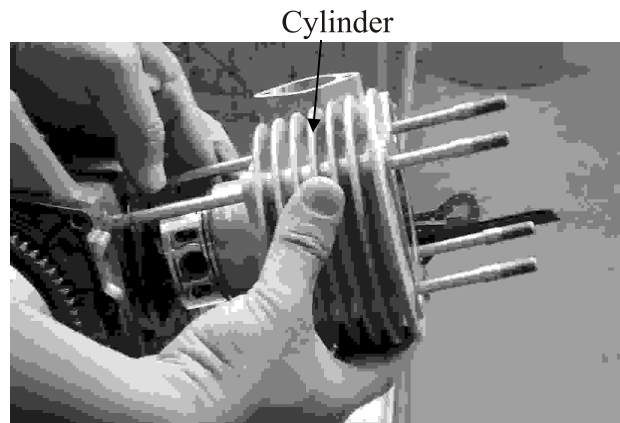

- Remove the cylinder gasket and dowel pins.
- Clean any gasket material from the cylinder surface.

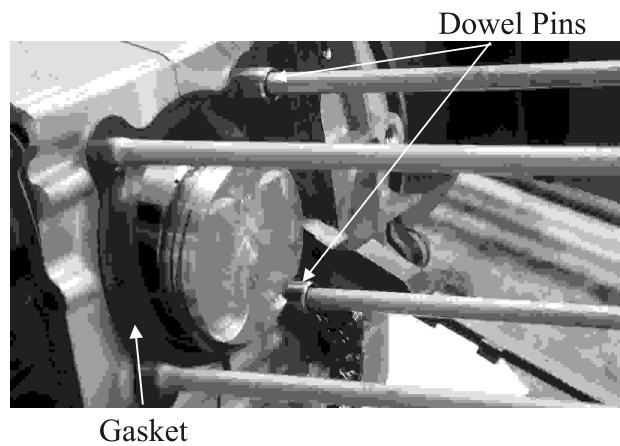

PISTON REMOVAL

- Remove the piston pin clip.

* Place a clean shop towel in the crankcase to keep the piston pin clip from falling into the crankcase.

- Press the piston pin out of the piston and remove the piston.

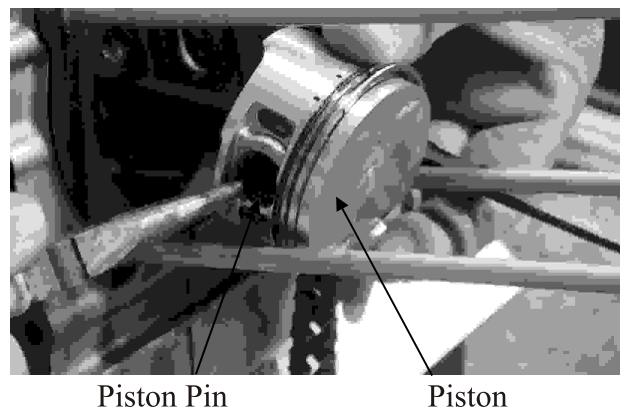

8. CYLINDER/PISTON

Inspect the piston, piston pin and piston rings.
Remove the piston rings.

* Take care not to damage or break the piston rings during removal.

Clean carbon deposits from the piston ring grooves.



Install the piston rings onto the piston and measure the piston ring-to-groove clearance.

Service Limit : Top : 0.09 mm replace if over
2nd : 0.09 mm replace if over



Remove the piston rings and insert each piston ring into the cylinder bottom.

* Use the piston head to push each piston ring into the cylinder.

Measure the piston ring end gap.

Service Limit : 0.5 mm replace if over



Measure the piston pin hole I.D.

Service Limit : 15.04 mm replace if below



8. CYLINDER/PISTON

Measure the piston pin O.D.

Service Limit :14.96 mm replace if below

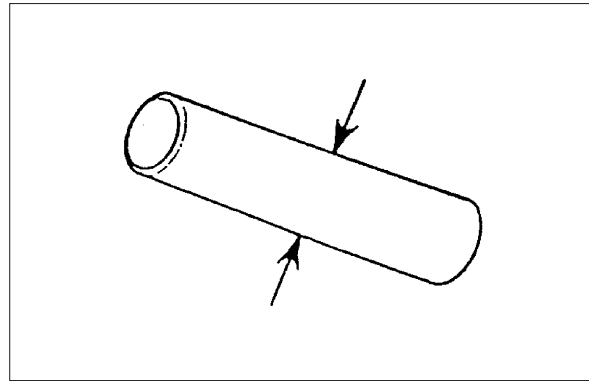

* Take measurement at 9mm from the bottom and 90 degree to the piston pin hole.

Service limit : 52.3 mm replace if below

Measure the piston-to-piston pin clearance

Service limit : 0.02 mm replace if over



CYLINDER INSPECTIION

Inspect the cylinder bore for wear or damage. Measure the cylinder I.D. at three levels of top, middle and bottom at 90 to the piston pin (in both X and Y directions).

Service limit : 52.5 mm repair or replace if over

Measure the cylinder-to-piston clearance.

Service limit : 0.1mm repair or replace if over



The true roundness is the difference between the values measured in X and Y directions. The cylindricity (difference between the values measured at the three levels) is subject to the maximum value calculated.

Service limit :

True Roundness : 0.05 mm repair or replace if over

Cylindricity : 0.05 mm repair or replace if over

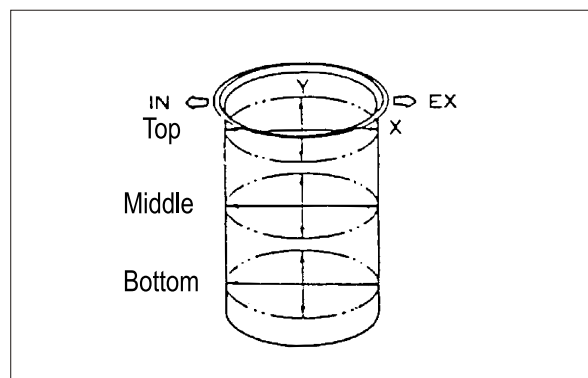

8. CYLINDER/PISTON

Inspect the top of the cylinder for warpage.

Service limit : 0.05 mm repair or replace if over

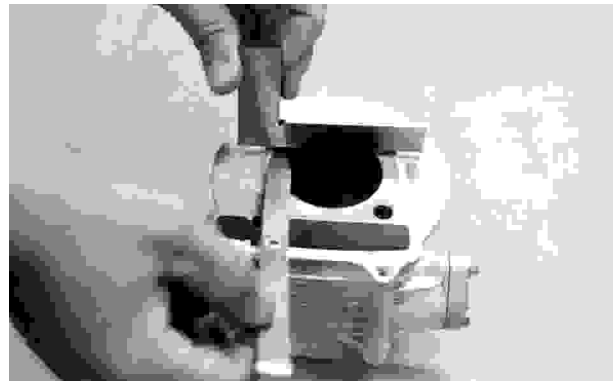

Measure the connecting rod small end I.D.

Service limit : 15.06 mm replace if over

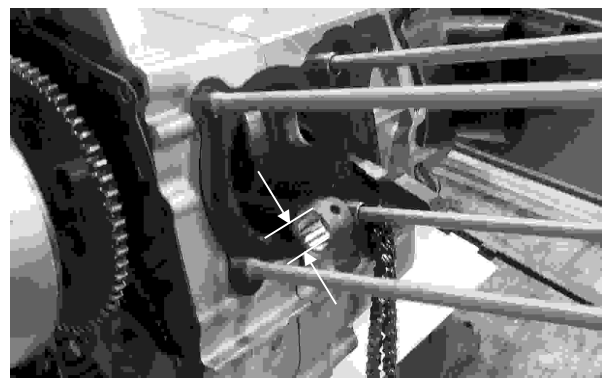

PISTON RING INSTALLATION

Install piston ring onto the piston.

Apply engine oil to each piston rings.

* Be careful not to damage or break the piston and piston rings.
 All rings should be installed with the markings facing up.
 After installing the rings, they should rotate freely without sticking.

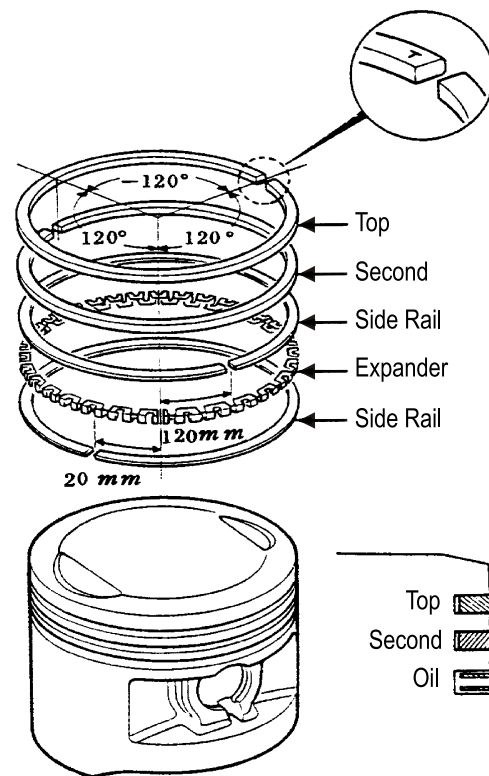

8. CYLINDER/PISTON

PISTON INSTALLATION

Remove any gasket material from the crankcase surface.

- * Be careful not to drop foreign matters into the crankcase.

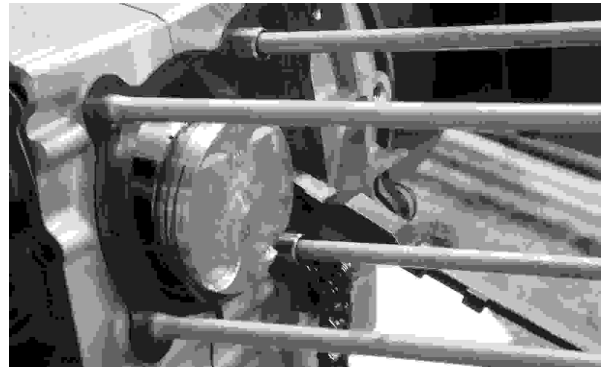

Install the piston, piston pin and a new piston pin clip.

- * Position the piston "IN" mark on the intake valve side. Place a clean shop towel in the crankcase to keep the piston pin clip from falling into the crankcase.

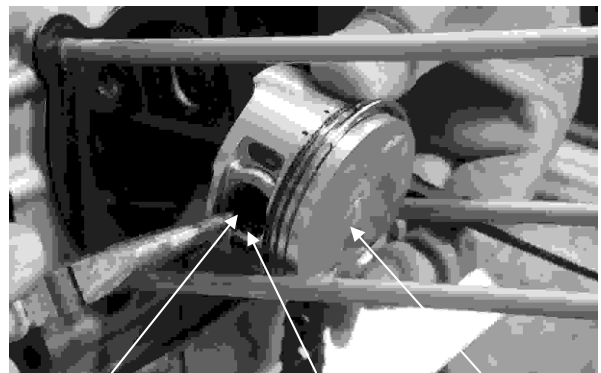

Piston pin clip Piston pin Piston

CYLINDER INSTALLATION

Install the dowel pins and a new cylinder gasket on the crankcase.

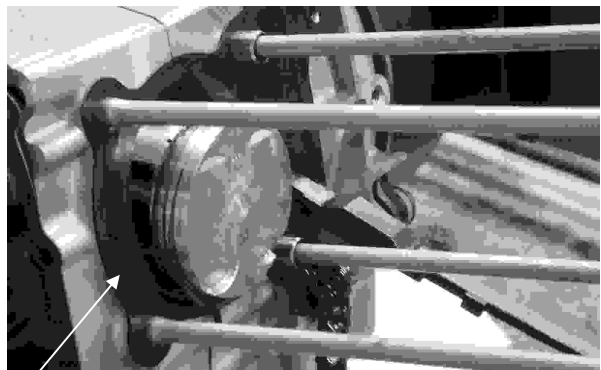

Gasket

Coat the cylinder bore, piston and piston rings with clean engine oil. Carefully lower the cylinder over the piston by compressing the piston rings.

- * Be careful not to damage or break the piston rings. Stagger the ring end gaps at 120 to the piston pin.

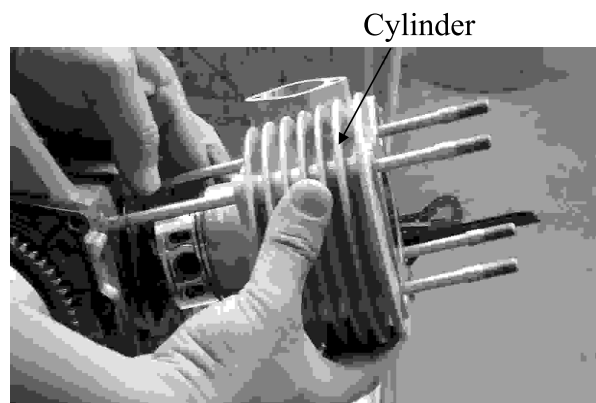

Cylinder

8. CYLINDER/PISTON

Tighten the cylinder base bolts.

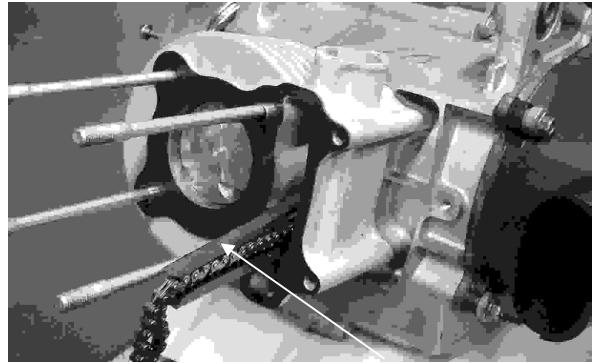

Cam chain guide

Install the cam chain guide.

* Insert the tab on the cam chain guide into the cylinder groove.

Install the cylinder head.

Loosely install the cylinder base bolts.

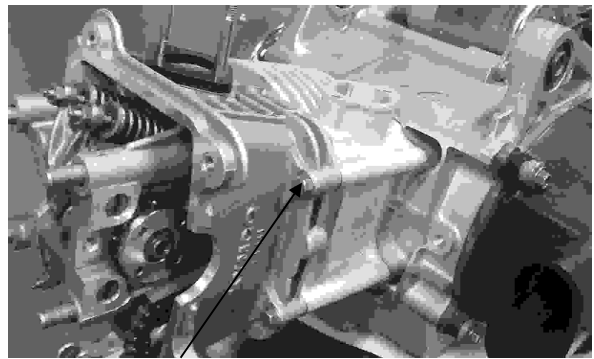

Cylinder base bolts

9. DRIVE AND DRIVEN PULLEYS/ KICK STARTER

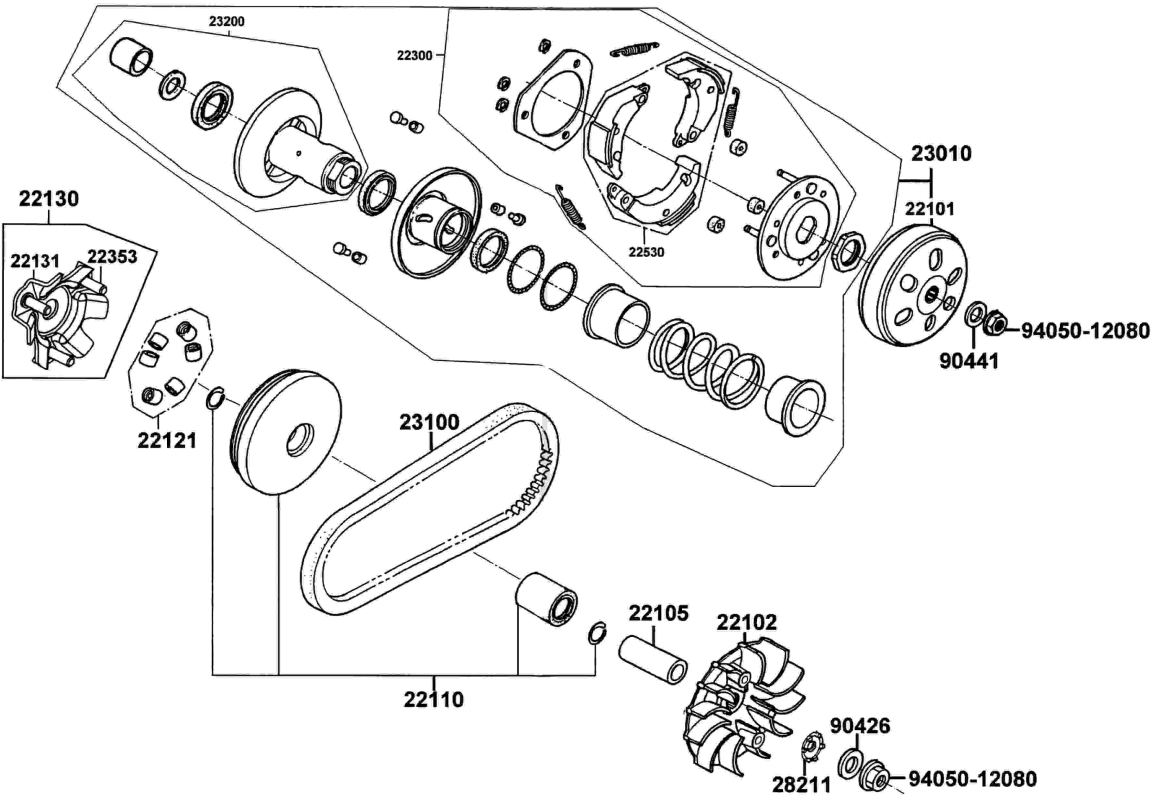

9

SERVICE INFORMATION.....	9-1	DRIVE PULLEY.....	9- 3
TROUBLESHOOTING.....	9-1	CLUTCH/DRIVEN PULLEY.....	9- 8
LEFT CRANKCASE COVER.....	9-2		

SERVICE INFORMATION

GENERAL INSTRUCTIONS

- The drive pulley, clutch and driven pulley can be serviced with the engine installed.
- Avoid getting grease and oil on the drive belt and pulley faces. Remove any oil or grease from them to minimize the slipping of drive belt and drive pulley.

SPECIFICATIONS

Item	Standard (mm)
Movable drive face bushing I.D.	24.011-24.052
Drive face collar O.D.	23.960-23.974
Drive belt width	20.0-21.0
Clutch outer I.D.	125.0-125.2
Driven face O.D.	33.965-33.485
Movable driven face I.D.	34.000-34.025
Weight roller O.D.	17.920-18.080

TORQUE VALUES

Drive face nut	5.5 kg-m
Clutch outer nut	5.5 kg-m
Clutch drive plate nut	5.5 kg-m

SPECIAL TOOLS

Universal holder	E017	Clutch spring compressor	E027
Outer driver, 32x35mm	E015	Bearing driver	E037

TROUBLESHOOTING

Engine starts but motorcycle won't move

- Worn drive belt
- Broken ramp plate
- Worn or damaged clutch lining
- Broken driven face spring

Lack of power

- Worn drive belt
- Weak driven face spring
- Worn weight roller
- Fouled drive face

Motorcycle scrape during riding

- Broken clutch weight spring

LEFT CRANKCASE COVER REMOVAL

Remove three bolts attaching to the protector cover.
Remove the protector cover.

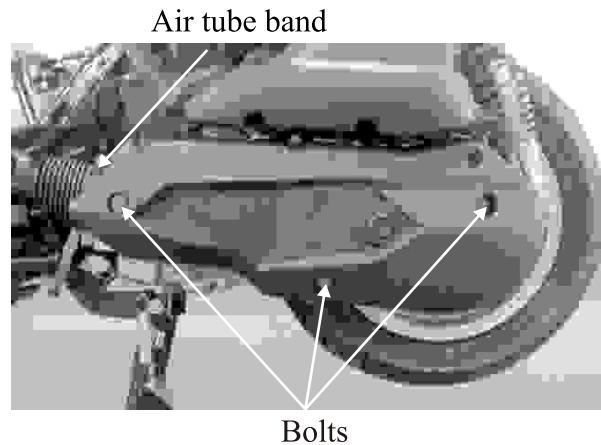

Remove bolts attaching to left crankcase cover.
Remove the gasket and dowel pins.

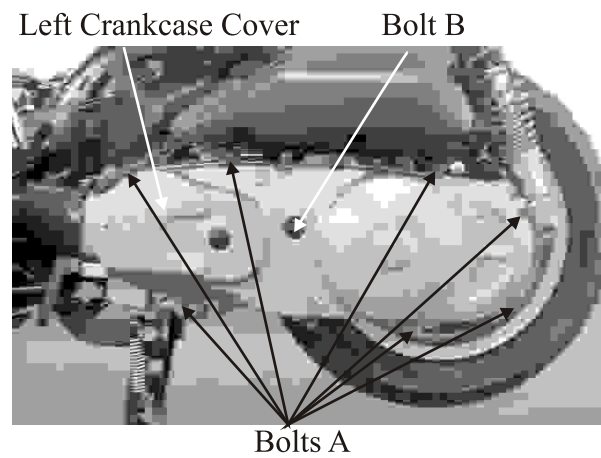

INSTALLATION

Install the dowel pins.
Install the gasket.

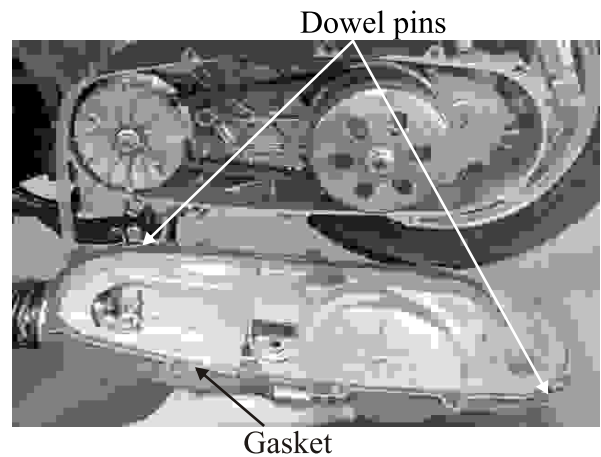

Install the left crankcase cover and tighten the left crankcase cover bolts diagonally. Connect the drive belt air tube and tighten the tube band screw.

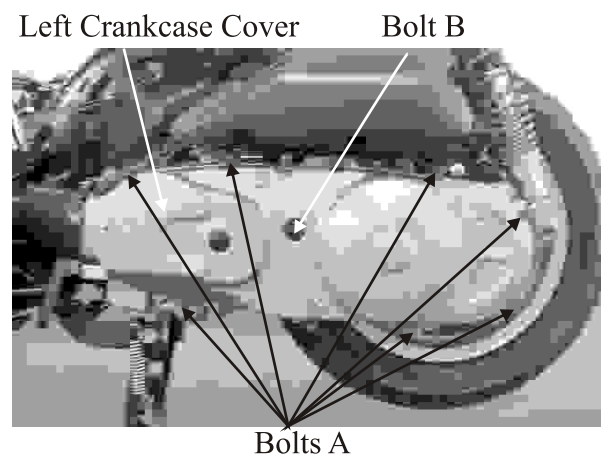

9. DRIVE AND DRIVEN PULLEYS/ KICK STARTER

Tighten the drive belt air tube band screw.
Install the protector cover and kick starter.
Tighten the bolts attaching the protector cover.

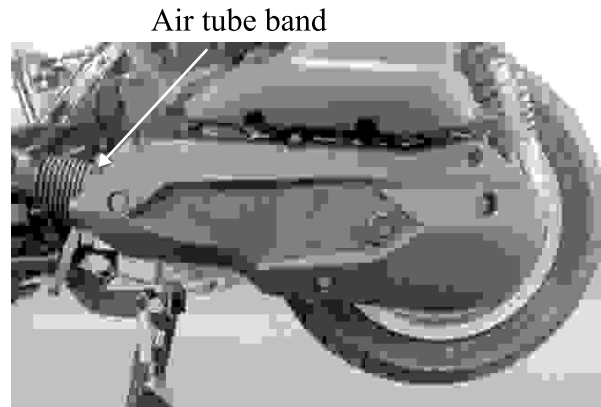

DRIVE PULLEY REMOVAL

Remove the left crankcase cover.
Hold the drive pulley by using a universal holder
and remove the drive face nut, starting ratchet and
washer.
Remove the drive pulley face.



Universal holder E017

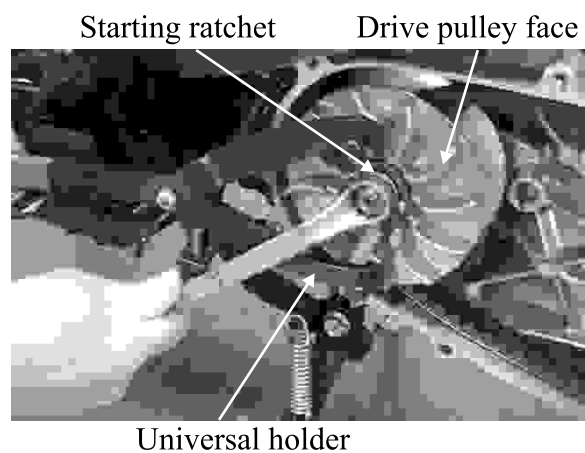

Hold the clutch outer with an universal holder
and remove the clutch outer nut.
Remove the drive belt from the clutch/driven
pulley.

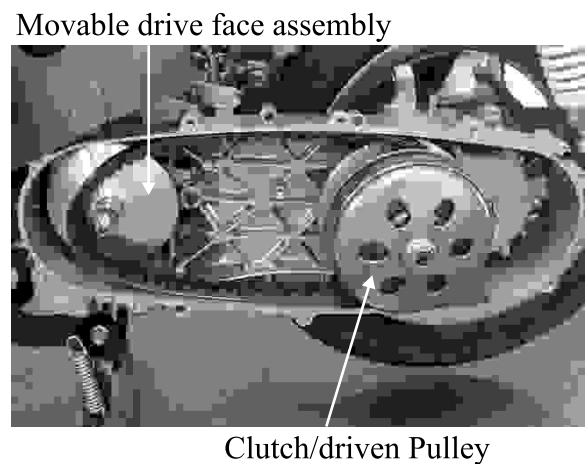

INSPECTION

Check the drive belt for cracks, separation or
abnormal or excessive wear.

Measure the drive belt width.
Service Limit : 19 mm or lower

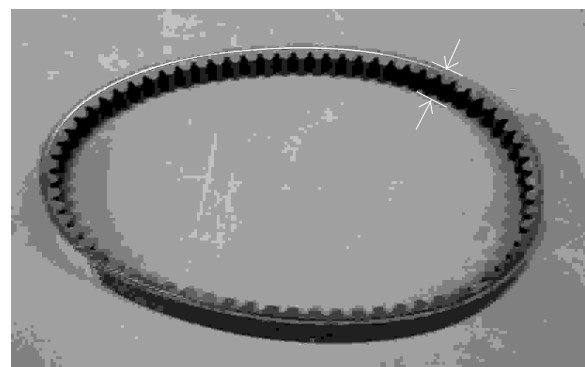

9. DRIVE AND DRIVEN PULLEYS/ KICK STARTER

Remove the movable drive face assembly and drive pulley collar from the crankshaft.

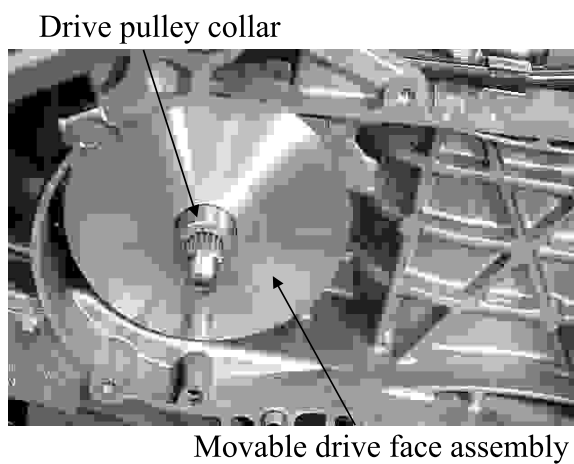

Remove the ramp plate.

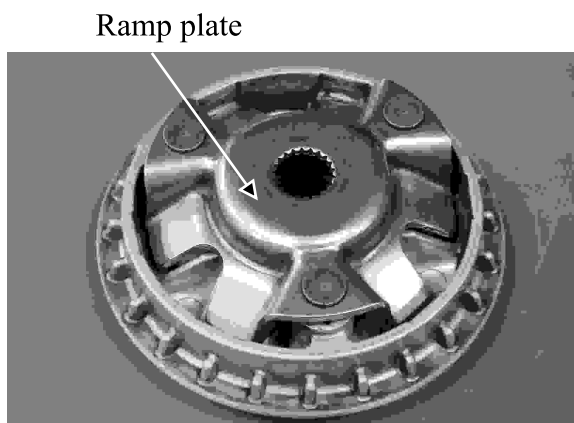

Remove the weight roller.

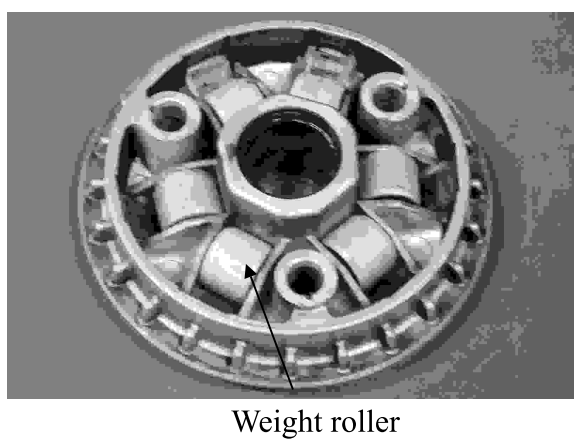

9. DRIVE AND DRIVEN PULLEYS/ KICK STARTER

INSPECTION

Check each weight roller for wear or damage.
Measure each weight roller O.D.

Service limit : 17.4 mm replace if below

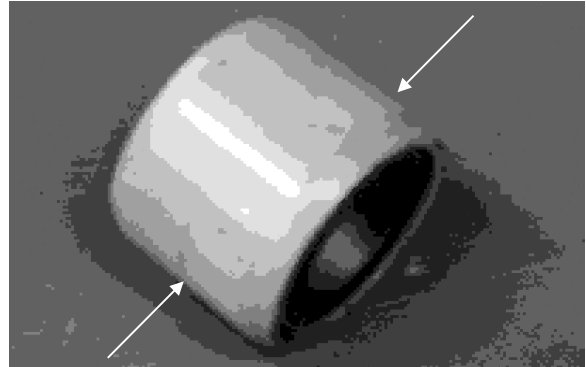

Measure the i.d. Of the movable drive face assembly

Service limit : 24.06 mm replace if below

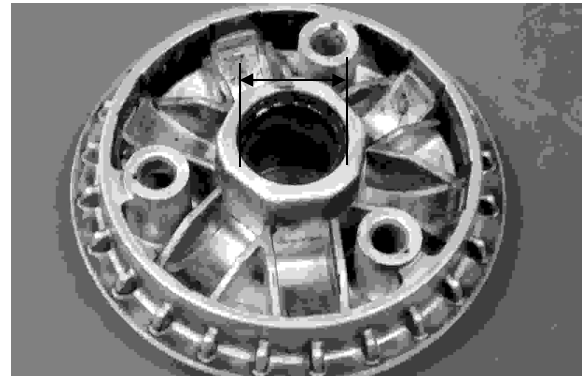

Check the drive pulley collar for wear or damage.
Measure the O.D. of the drive pulley collar sliding surface.

Service limit : 23.94 mm replace if below

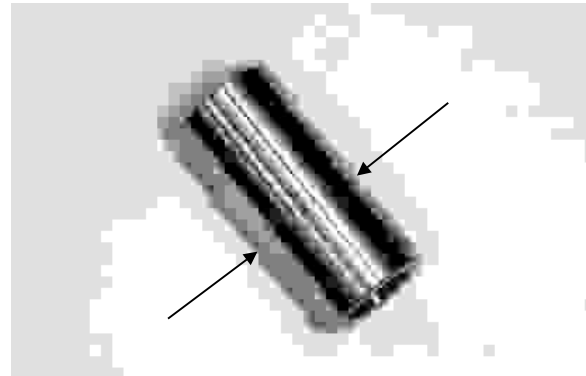

ASSEMBLY

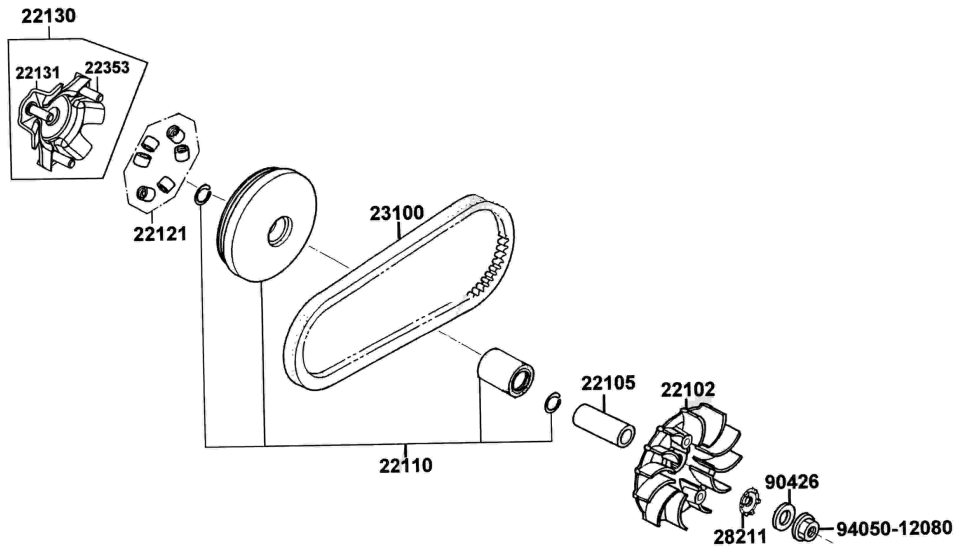

Install the weight rollers into the movable drive face.



Weight roller

Ramp plate

Install the ramp plate.

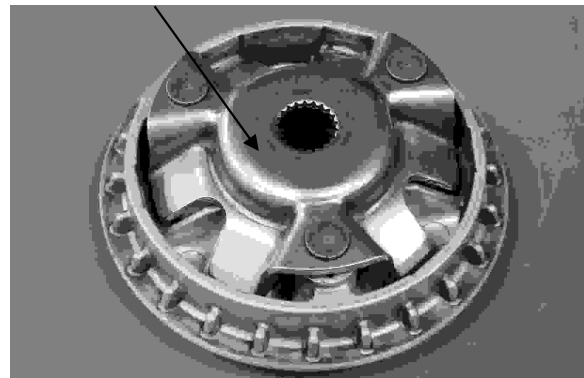

9. DRIVE AND DRIVEN PULLEYS/ KICK STARTER

Insert the drive pulley collar into the movable drive face.

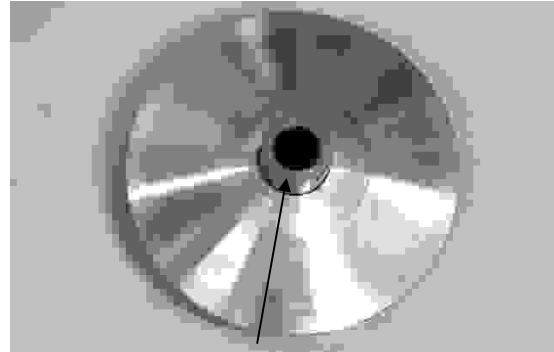

Drive Pulley Collar

INSTALLATION

Install the movable drive face onto the crankshaft.

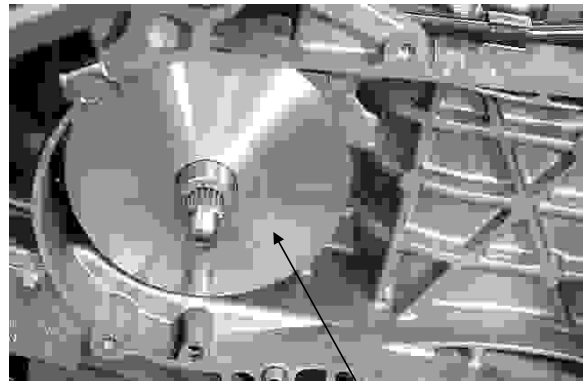

Movable drive face assembly

Install the drive belt onto the clutch/driven pulley assembly and drive pulley collar.

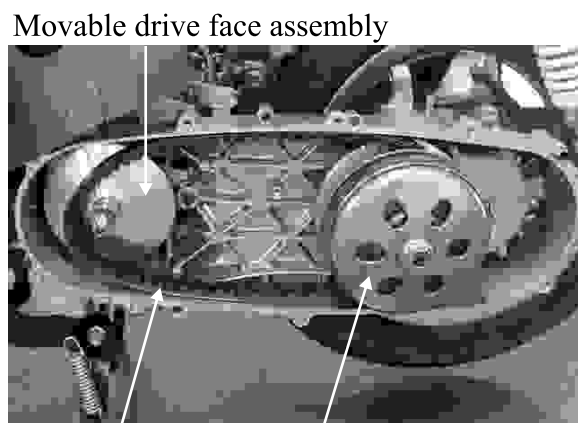

Drive belt

Clutch/driven Pulley

9. DRIVE AND DRIVEN PULLEYS/ KICK STARTER

Install the drive pulley, starting ratchet and nut.

* Make sure to align to the crankshaft's gear when the starting ratchet installed.

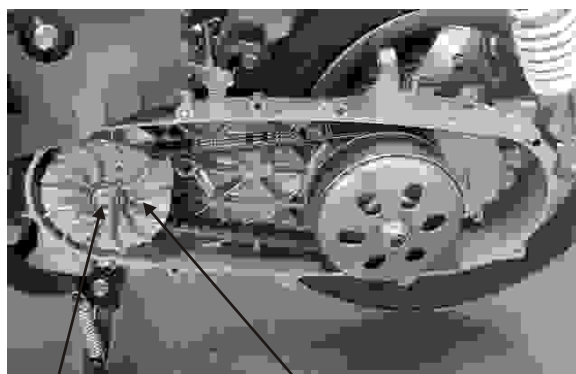

Nut Starting ratchet

Hold the movable drive pulley's nut with the universal holder.

Special

Universal holder E017

* Be careful not make the lubricant applied on the drive belt and drive pulley.

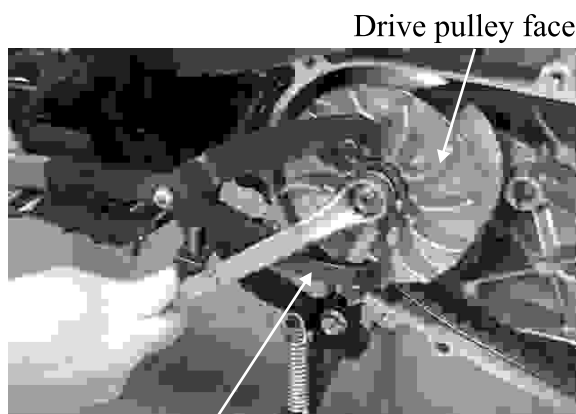

Drive pulley face
Universal holder

CLUTCH/DRIVEN PULLEY

Remove the left crankcase cover.
Remove the movable drive pulley and take off the drive belt.
Hold the clutch outer with the universal holder and remove the clutch outer nut.

Special

Universal holder E017

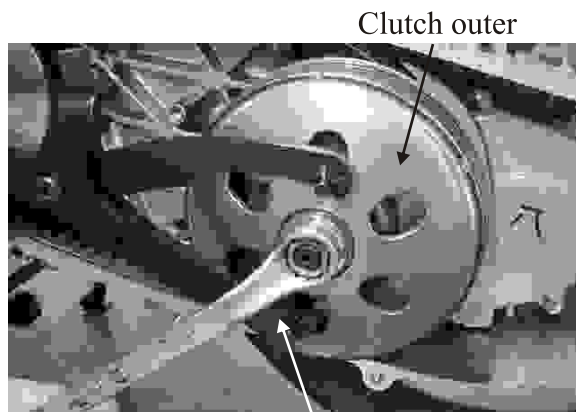

Clutch outer
Universal holder

INSPECTION

Inspect the clutch outer for wear or damage.
Measure the clutch outer I.D.
Service Limit: 125.5 mm replace if over

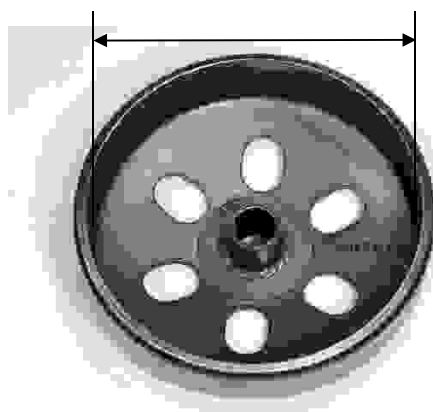

9. DRIVE AND DRIVEN PULLEYS/ KICK STARTER

Check the clutch lining for wear or damage.
Measure the clutch lining thickness.
Service Limit: 1.5 mm replace if below

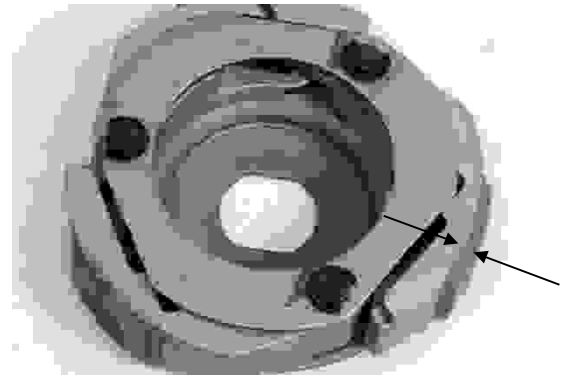

DISASSEMBLY

Clutch / Driven pulley

Clutch / Driven pulley

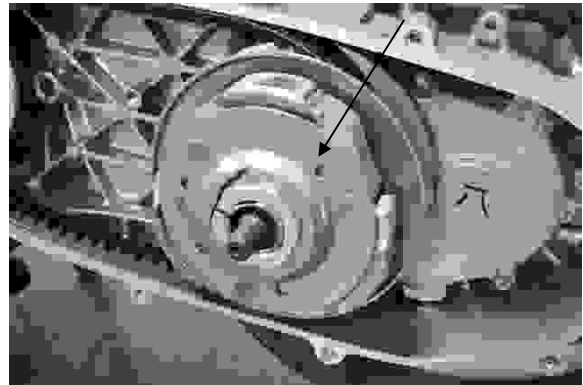

* Be sure to use a clutch spring compressor to avoid spring damage.

Special

Clutch spring compressor E027

Set the clutch spring compressor onto a vise and remove the clutch drive plate nut.

Outer driver, 32x35mm

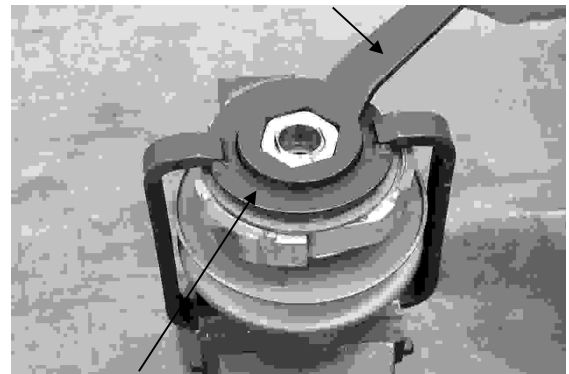

Clutch spring compressor E027

Loosen the clutch spring compressor and disassemble the clutch/driven pulley assembly.
Remove the seal collar.



9. DRIVE AND DRIVEN PULLEYS/ KICK STARTER

Pull out the guide roller pins and guide rollers. Remove the movable driven face from the driven face.

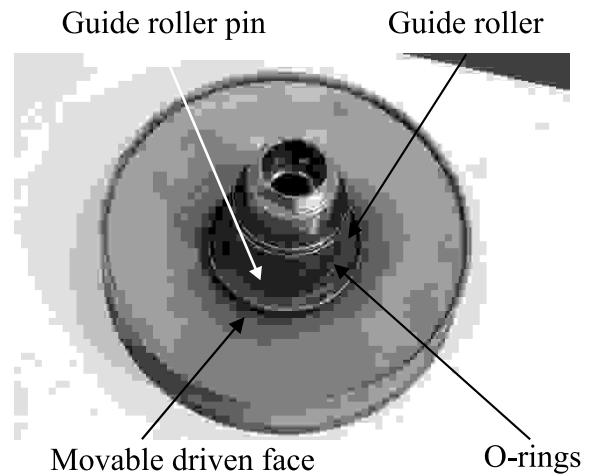

Remove the O-rings and oil seal from the movable driven face.

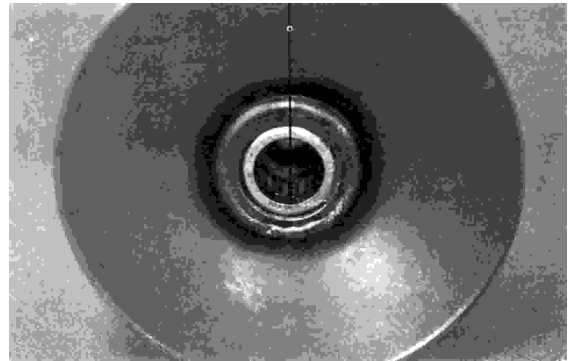

INSPECTION

Measure the driven face spring free length.
Service Limit: 103 mm replace if below

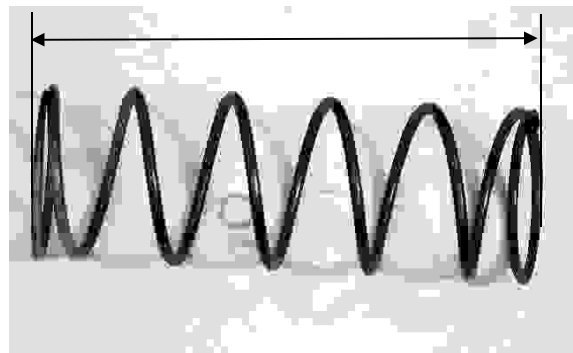

Check the driven face for wear or damage.
Measure the driven face O.D.
Service Limit: 33.94 mm replace if below



9. DRIVE AND DRIVEN PULLEYS/ KICK STARTER

Check the movable driven face for wear or damage. Measure the movable driven face I.D.

Service limit : 34.06mm replace if over

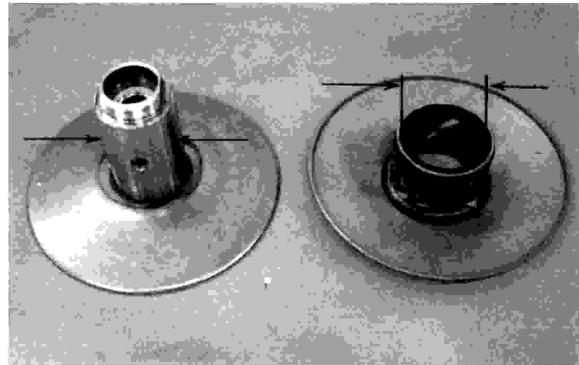

Drive the inner needle bearing out of the driven pulley face.
Discard the removed bearing and replace with a new one.

Inner bearing

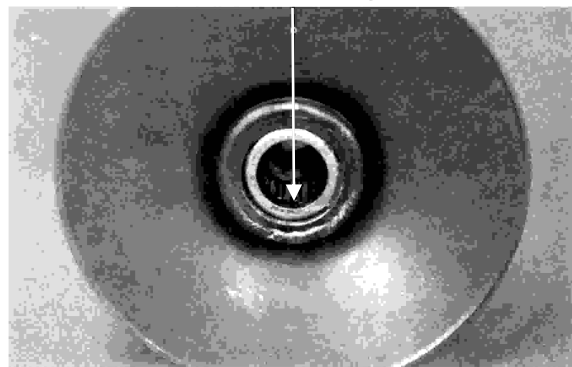

Remove the snap ring and drive the outer bearing out of the driven face.

* Discard the removed bearing and replace with a new one.

Special

Bearing driver

E037

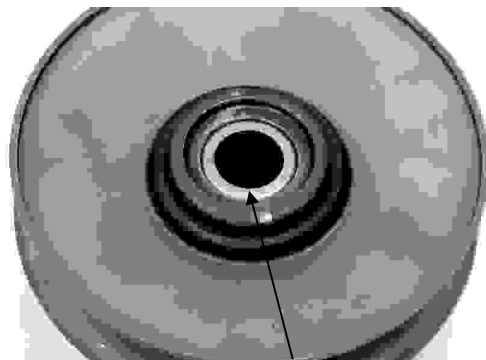

Outer bearing

Apply grease to the outer bearing. Drive a new outer bearing into the driven face with the sealed end facing up. Seat the snap ring in its groove.

* Pack all bearing cavities with 9.0~9.5g grease.
Specified grease: Heat resistance 230°C

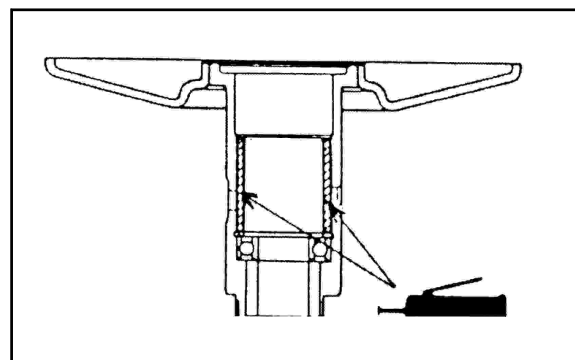

Press a new needle bearing into the driven face.

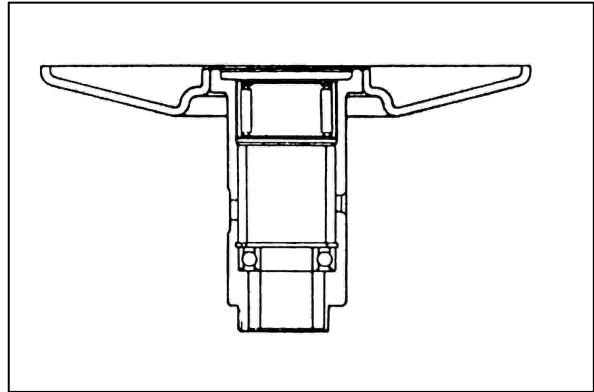

CLUTCH DISASSEMBLY

Remove the circlips and retainer plate to disassemble the clutch.

* Keep grease off the clutch linings.

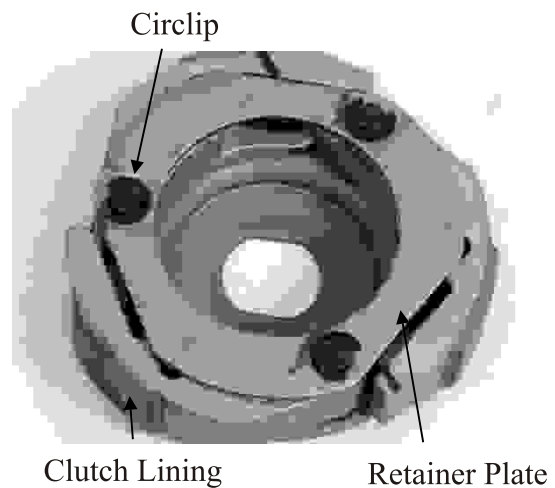

CLUTCH / DRIVEN PULLEY ASSEMBLY

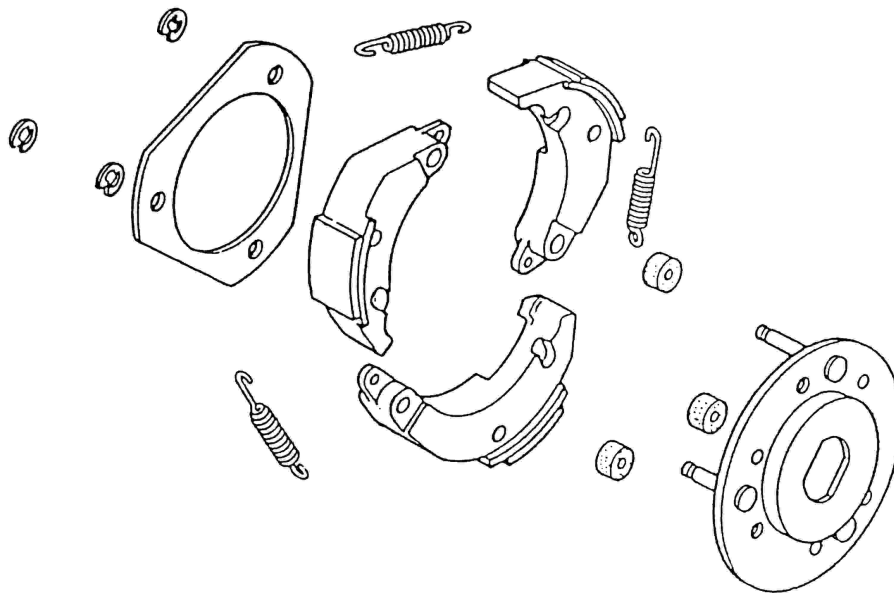

Install the damper rubbers on the drive plate pins.
Install the clutch weights/shoes and clutch
springs onto the drive plate.
Install the retainer plate and secure with the
circlips.

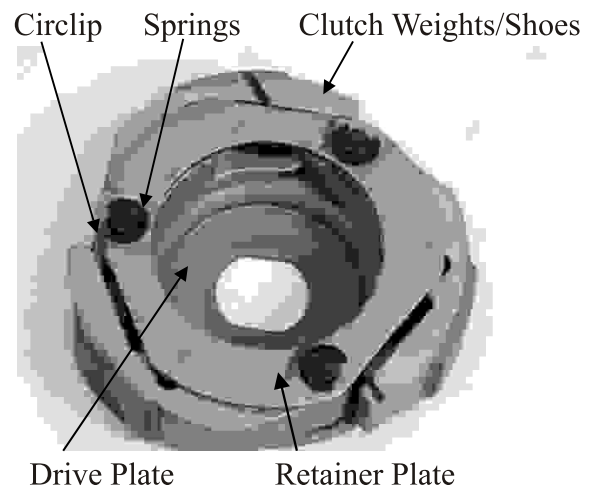

CLUTCH/DRIVEN PULLEY ASSEMBLY

Clean the driven pulley faces and remove any
grease from them.
Install the oil seal onto the moveable driven face.
Apply grease to the O-rings and install them onto
the moveable driven face.

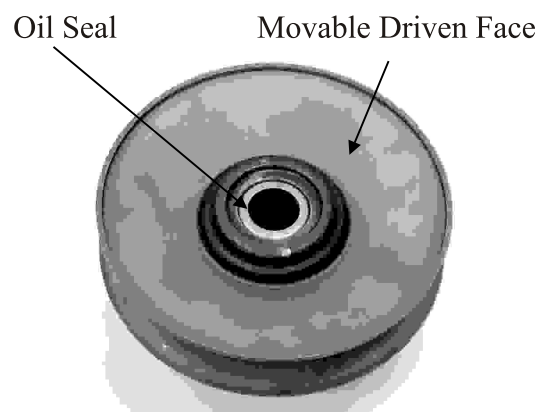

9. DRIVE AND DRIVEN PULLEYS/ KICK STARTER

Install the movable driven face onto the driven face.

Apply grease to the guide rollers and guide roller pins and then install them into the holes of the driven face.

Install the seal collar.

Remove any excessive grease.

* Be sure to clean the driven face off any grease.

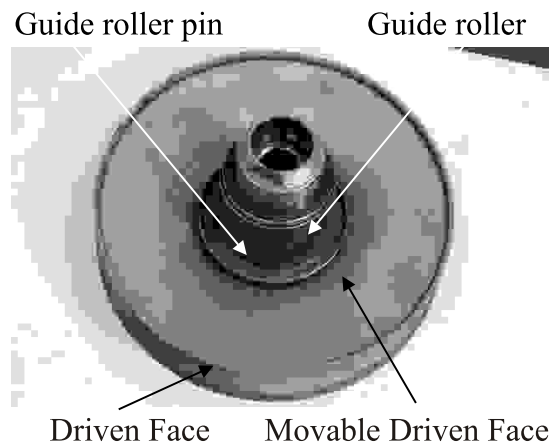

Set the driven pulley assembly, driven face spring and clutch assembly onto the clutch spring compressor.

* Align the flat surface of the driven face with the flat on the clutch drive plate.

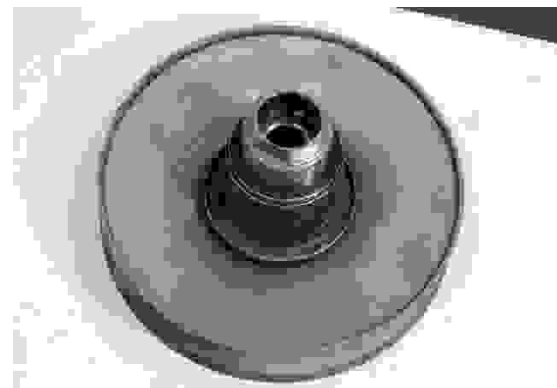

Compress the clutch spring compressor and install the drive plate nut. Set the clutch spring compressor on a vise and tighten the drive plate nut to the specified torque.

Torque: 5.5 kg-m

* Be sure to use a clutch spring compressor to avoid spring damage.

Clutch spring compressor

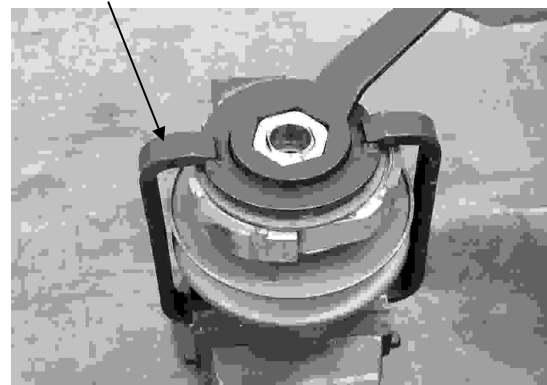

Special

Clutch spring compressor E027

INSTALLATION

Install the clutch/driven pulley onto the drive shaft.

* Be sure to clean the driven face off any grease.

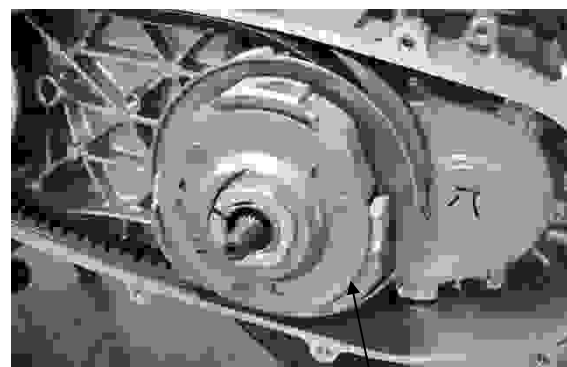

Clutch / Driven pulley

9. DRIVE AND DRIVEN PULLEYS/ KICK STARTER

Install the clutch outer.
Hold the clutch outer with the flywheel holder.
Install and tighten the clutch outer nut.

Torque: 5.5 kg-m

Special

Universal holder E017

Install the drive belt.
Install the left crankcase cover.

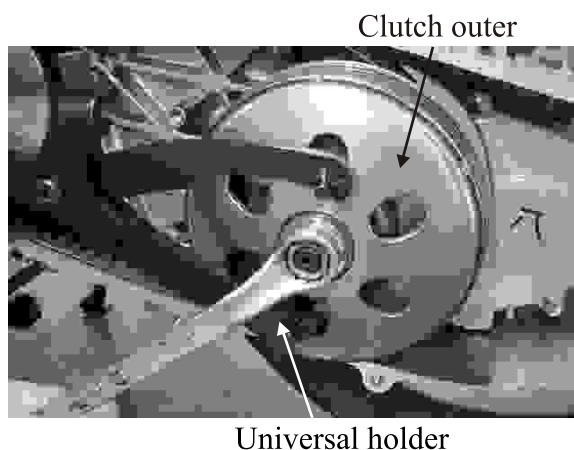

10. FINAL REDUCTION

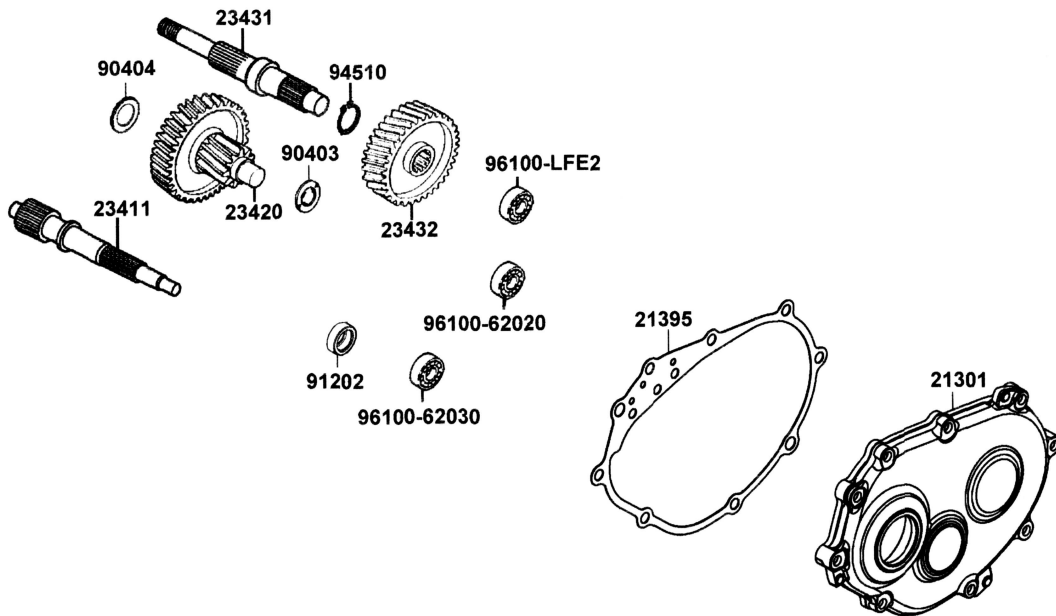

10

10. FINAL REDUCTION

SERVICE INFORMATION.....	10-1	FINAL REDUCTION INSPECTION	10-2
TROUBLESHOOTING	10-1	BEARING REPLACEMENT	10-3
FINAL REDUCTION DISASSEMBLY.....	10-2	FINAL REDUCTION ASSEMBLY.....	10-4

SERVICE INFORMATION

SPECIFICATIONS

Specified Oil	:	GEAR OIL SAE 90#
Oil Capacity	:	At disassembly : 140 cc
		At change : 120 cc

TORQUE

Transmission cover 1.2 kg-m

SPECIAL TOOLS

Bearing puller/remover set, 12mm	E020
Bearing puller/remover set, 15mm	E018
Oil seal/Bearing driver	E014
Crankshaft assembly collar	E029
Driver handle A	E014
Crankshaft assembly shaft	E016

TROUBLESHOOTING

Engine starts but motorcycle won't move

- Damaged transmission
- Seized or burnt transmission
- Faulty drive belt
- Faulty clutch

Abnormal noise

- Worn, seized or chipped gears
- Worn bearing

Oil leaks

- Oil level too high
- Worn or damaged oil seal

10. FINAL REDUCTION

FINAL REDUCTION DISASSEMBLY

- Remove the muffler.
- Remove the rear wheel.
- Remove the rear brake cable.
- Remove the left crankcase cover.
- Remove the clutch/driven pulley.
- Drain the transmission gear oil into a clean container.
- Remove the transmission case cover attaching bolts.
- Remove the transmission case cover.
- Remove the gasket and dowel pins.

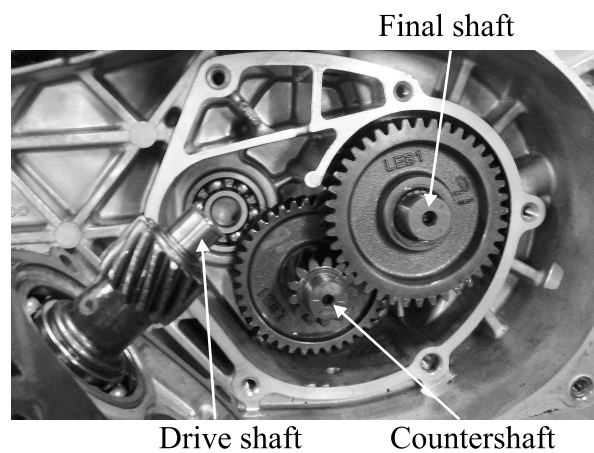
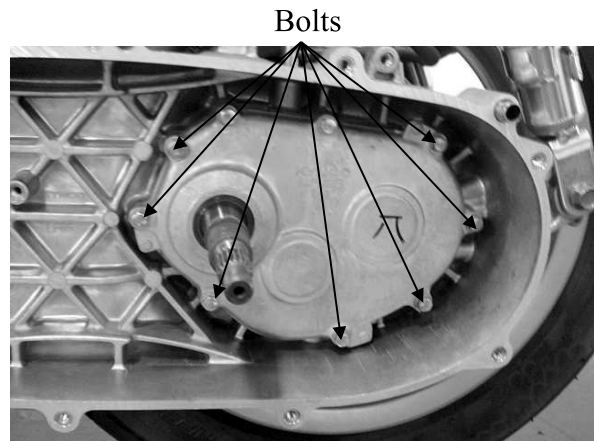

FINAL REDUCTION INSPECTION

Inspect the countershaft and gear for wear or damage.

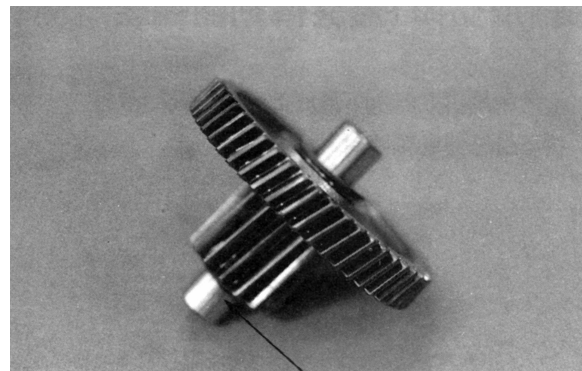

Inspect the final gear and final shaft for wear, damage or seizure.

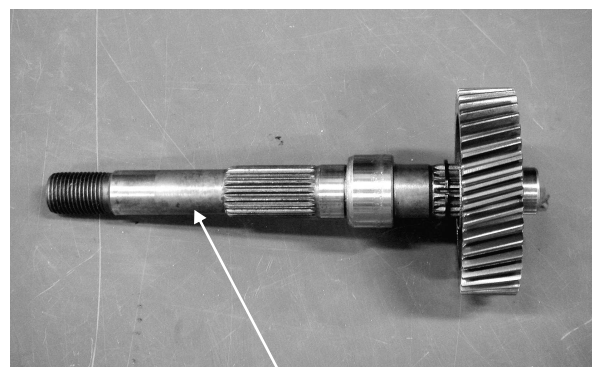

10. FINAL REDUCTION

Check the left crankcase bearings for excessive play and inspect the oil seal for wear or damage.

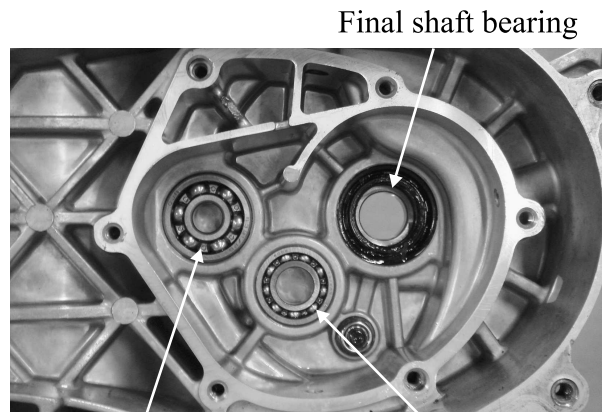

Drive shaft bearing Countershaft bearing

Inspect the drive shaft and gear for wear or damage. Check the transmission case cover bearings for excessive play and inspect the final shaft bearing oil seal for wear or damage.

* Do not remove the transmission case cover except for necessary part replacement. When replacing the drive shaft, also replace the bearing and oil seal.

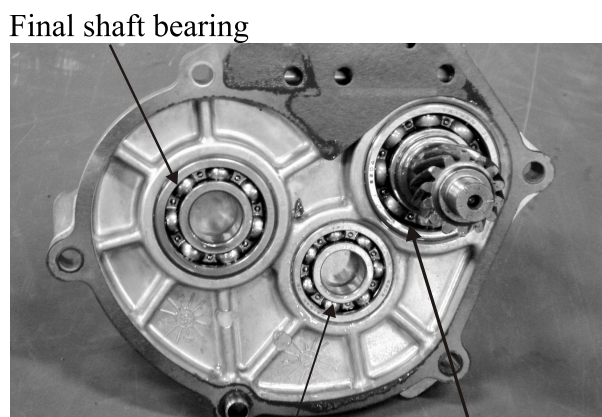

Countershaft bearing Drive shaft bearing

BEARING REPLACEMENT

(TRANSMISSION CASE COVER)

Remove the transmission case cover bearings using a bearing puller.
Remove the final shaft oil seal.

Special

Bearing puller/remover set, 15mm E018

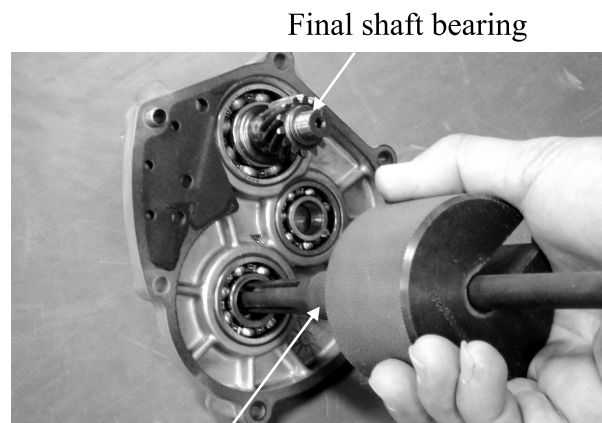

Bearing puller

Drive new bearings into the transmission case cover.

Special

Oil seal/Bearing driver E014

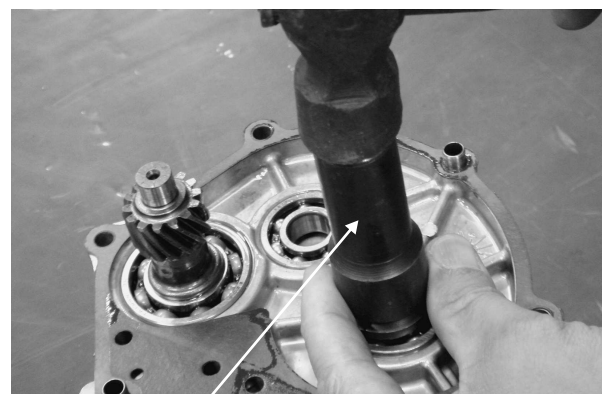

Oil seal/Bearing driver

10. FINAL REDUCTION

BEARING REPLACEMENT

(LEFT CRANKCASE)

Remove the drive shaft.
 Remove the oil seal drive shaft.
 Remove the left crankcase bearing using a bearing puller.



Bearing puller/remover set, 12mm E020

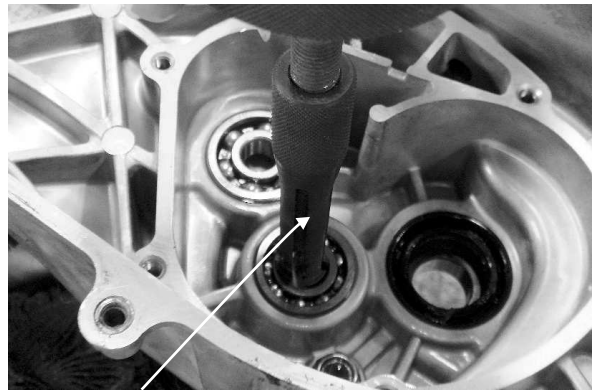

Bearing puller, 12mm

Drive new bearings into the left crankcase.
 Install a new drive shaft's oil seal.



Oil seal/Bearing driver E014

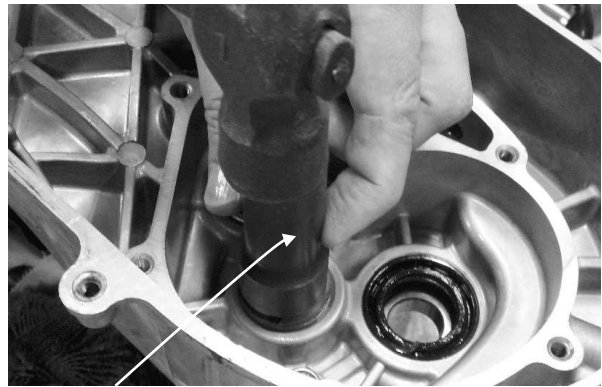

Bearing driver

FINAL REDUCTION ASSEMBLY

Install the drive shaft into the left crankcase.

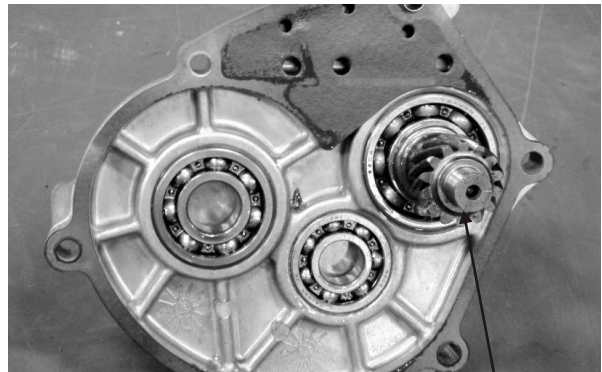

Drive shaft

Install the final gear and final shaft into the left crankcase.

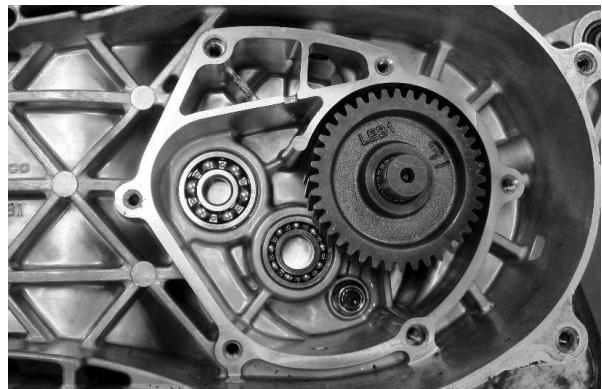

10. FINAL REDUCTION

Install the countershaft and gear into the left crankcase. Install the resin washer onto the countershaft. Install the dowel pins and a new gasket.

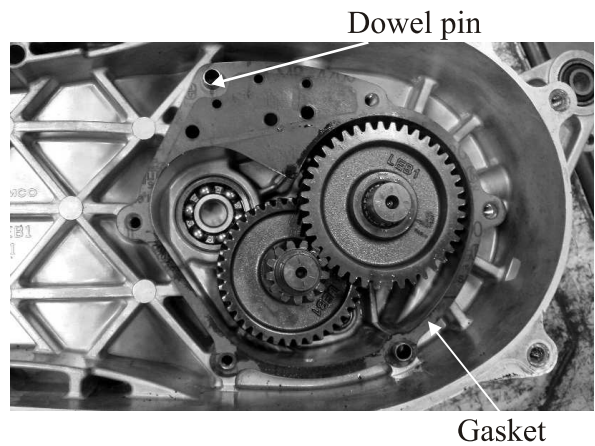

Install the transmission case cover.

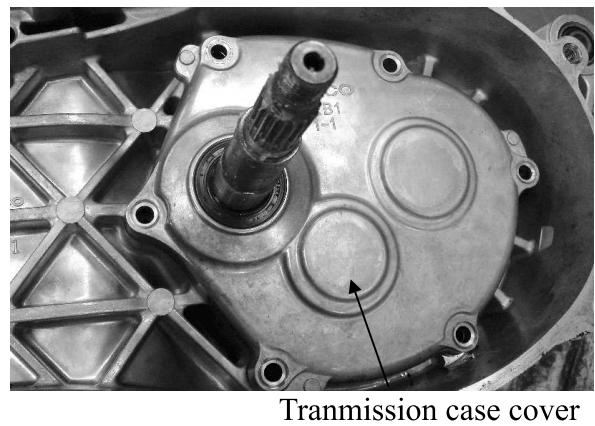

Install and tighten the transmission case cover bolts.

Install the clutch/driven pulley.

Install the rear wheel.

Install the rear brake cable.

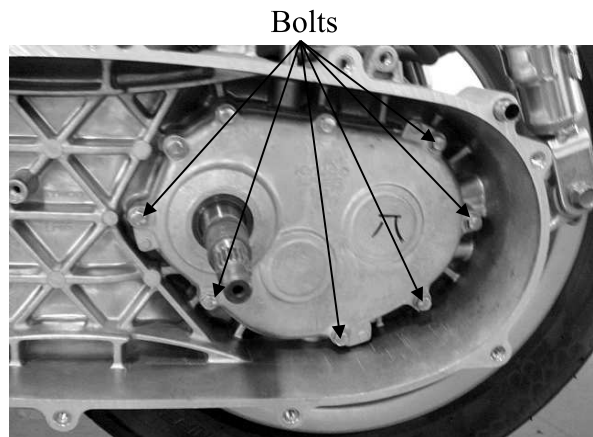

10. FINAL REDUCTION

After installation, fill the transmission case with the specified oil.

* Place the motorcycle on its main stand on level ground.
Check the oil sealing washer for wear or damage.

Specified gear oil : SAE90#

Oil Capacity :	At disassembly	140 cc
	At change	120 cc

Install and tighten the oil check bolt.

Torque : 1.0~1.5 kgf-m

Fill the transmission with the recommend fluid to the capacity listed below.

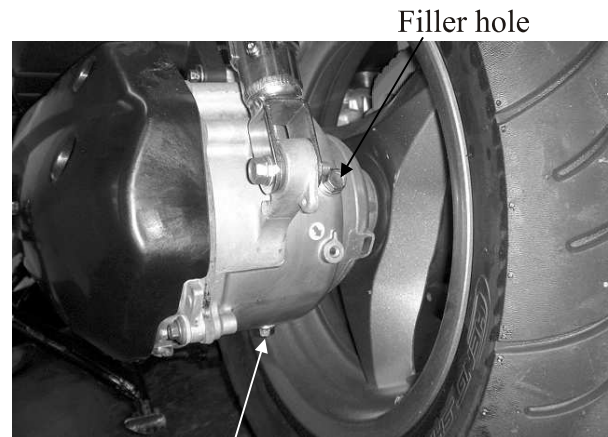

Drain bolt

11. CRANKCASE/CRANKSHAFT

Movie S 125i

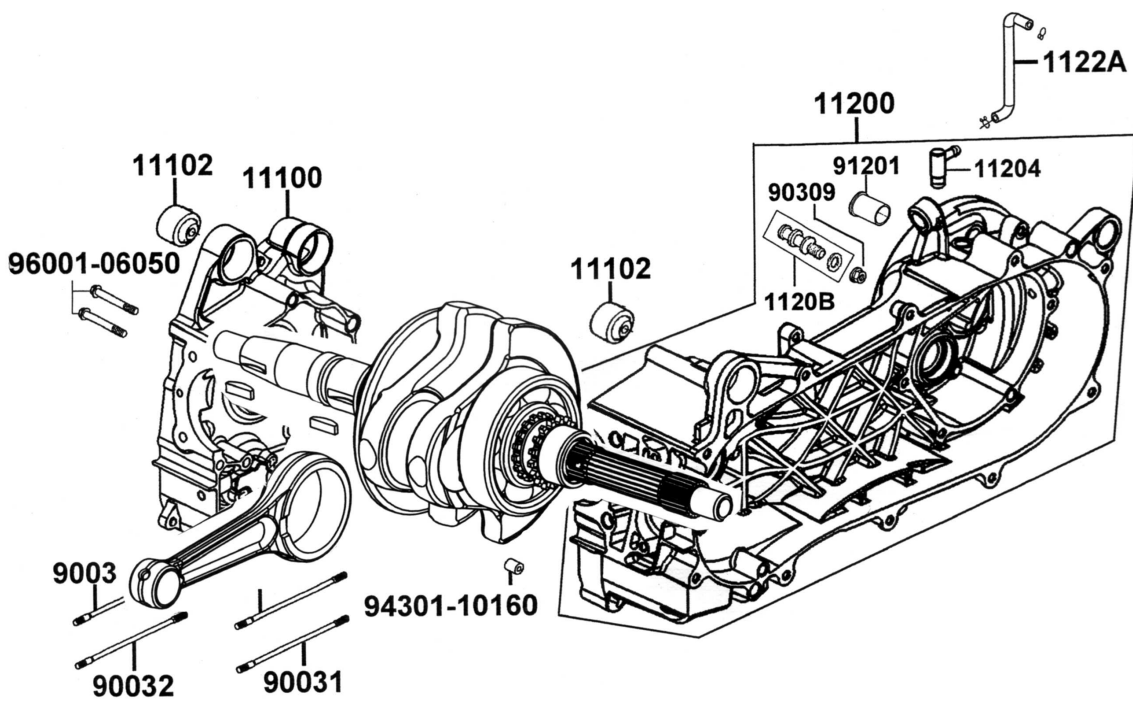

11

11. CRANKCASE/CRANKSHAFT

SERVICE INFORMATION	11-1	CRANKSHAFT INSPECTION	11-4
TROUBLESHOOTING	11-1	CRANKCASE ASSEMBLY.....	11-5
CRANKCASE SEPARATION.....	11-2		

SERVICE INFORMATION

GENERAL INSTRUCTIONS

This section covers crankcase separation to service the crankshaft. The engine must be removed for this operation.

SPECIFICATIONS

	Item	Standard(mm)	Service limit(mm)
Crankshaft	Connecting rod big end side clearance	0.10~0.35	0.55
	Connecting rod big end radial clearance	0 - 0.008	0.05
	Runout	—	0.10

TORQUE VALUES

Crankcase bolt	1.0 kg-m
Cam chain tensioner slipper bolt	1.0kg-m

SPECIAL TOOLS

Oil seal & Bearing installer E014

TROUBLESHOOTING

Excessive engine noise

- Excessive bearing play
- Excessive crankpin bearing play

11. CRANKCASE/CRANKSHAFT

CRANKCASE SEPARATION

Remove the cam chain tensioner slipper bolt and cam chain tensioner slipper.
Check if the O ring damaged.

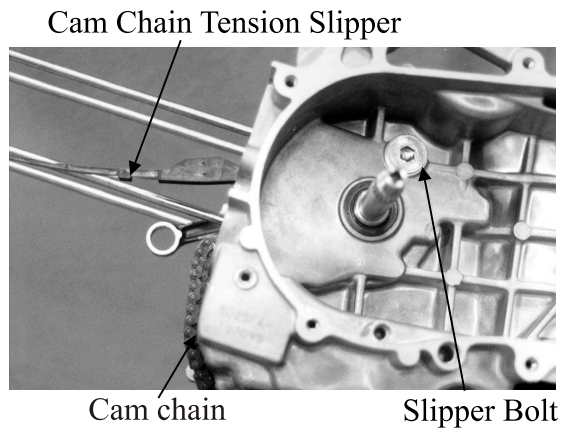

Remove two bolts attaching to the right crankcase.
Remove the right crankcase.

* Do not damage the crankcase gasket surface

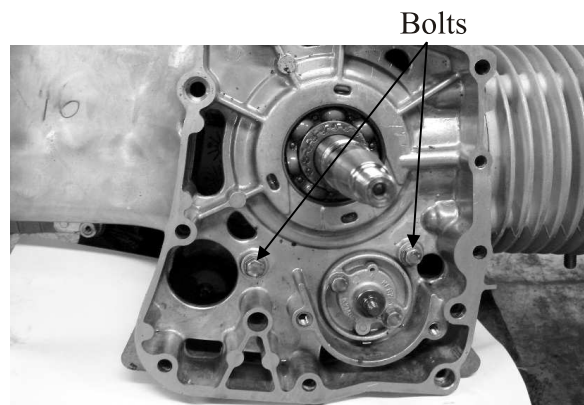

Remove the gasket and dowel pins.

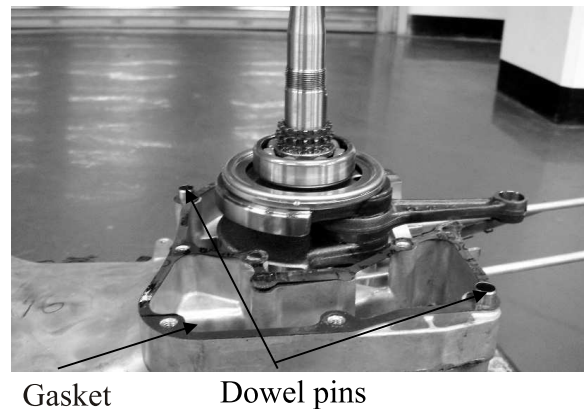

Remove the crankshaft from the left crankcase.



11. CRANKCASE/CRANKSHAFT

Clean off all gasket material from the crankcase mating surfaces.

*

Avoid damaging the crankcase mating surfaces.

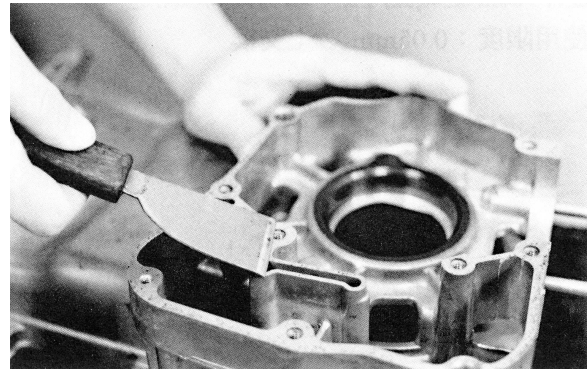

Remove the oil seal from the right crankcase.

Check the oil seal lip for wear or deterioration. The installation sequence is the reverse of removal.

Special

Oil seal & Bearing installer E014



CRANKSHAFT INSPECTION

Measure the connecting rod big end side clearance.

Service limit : 0.55 mm replace if over.

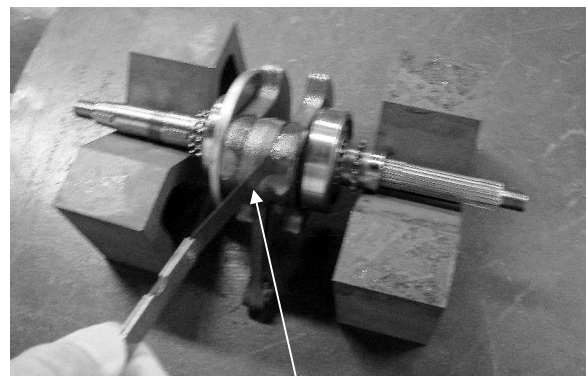

Connecting rod big end

Measure the connecting rod big end radial clearance at two points at right angles to the shaft.

Service limit: 0.05 mm replace if over.

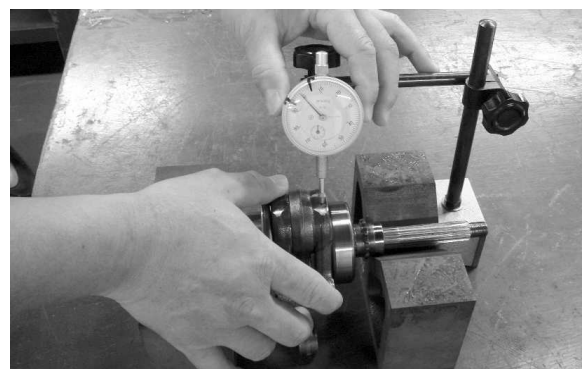

11. CRANKCASE/CRANKSHAFT

Measure the crankshaft runout.

Service limit : 0.10 mm replace if over.

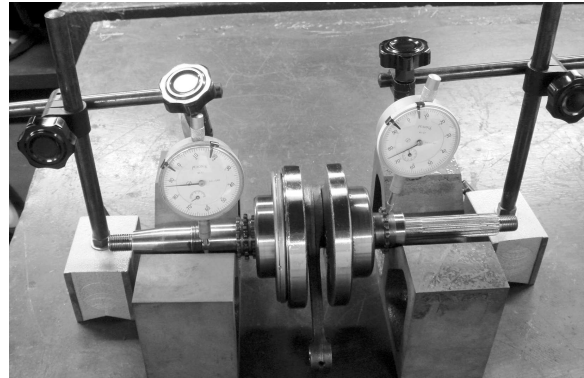

Turn the crankshaft bearings and check for excessive play.

If they do not turn smoothly, quietly or if they fit loosely in the crankshaft, replace the crankshaft as a set.

Crankshaft bearing

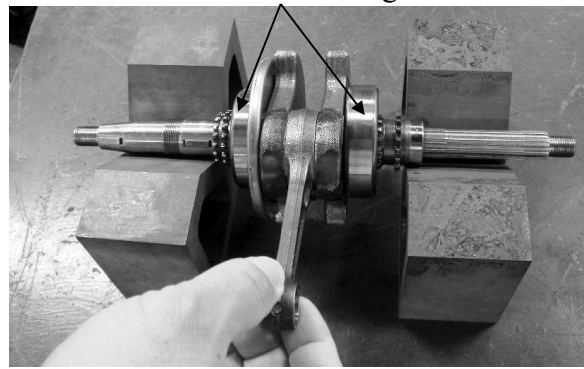

CRANKCASE ASSEMBLY

Install the cam chain into the left crankcase.



Install the dowel pins and a new gasket onto the left crankcase.

* Place the right crankcase over the crankshaft and onto the left crankcase.

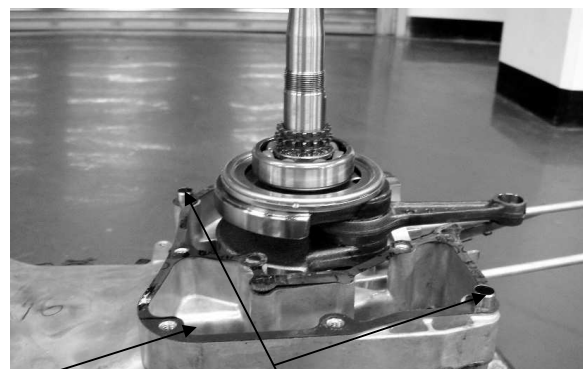

Gasket

Dowel pins

11. CRANKCASE/CRANKSHAFT

Tighten the crankcase attaching two bolts.

Torque : 0.9 kg-m

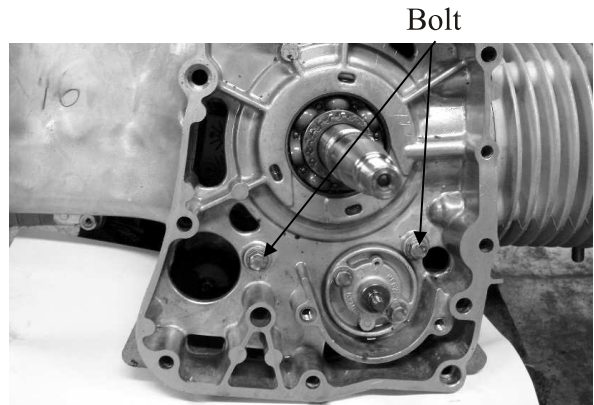

Install the cam chain.
Install the cam chain tension slipper.

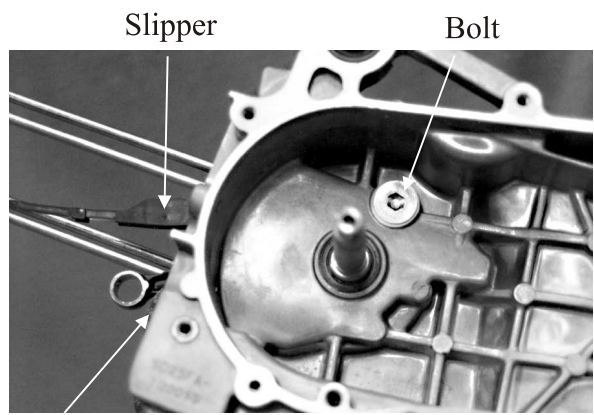

Cam chain

12. FRONT WHEEL/FRONT BRAKE/ FRONT SUSPENSION

 **KYMCO**
Movie S 125i

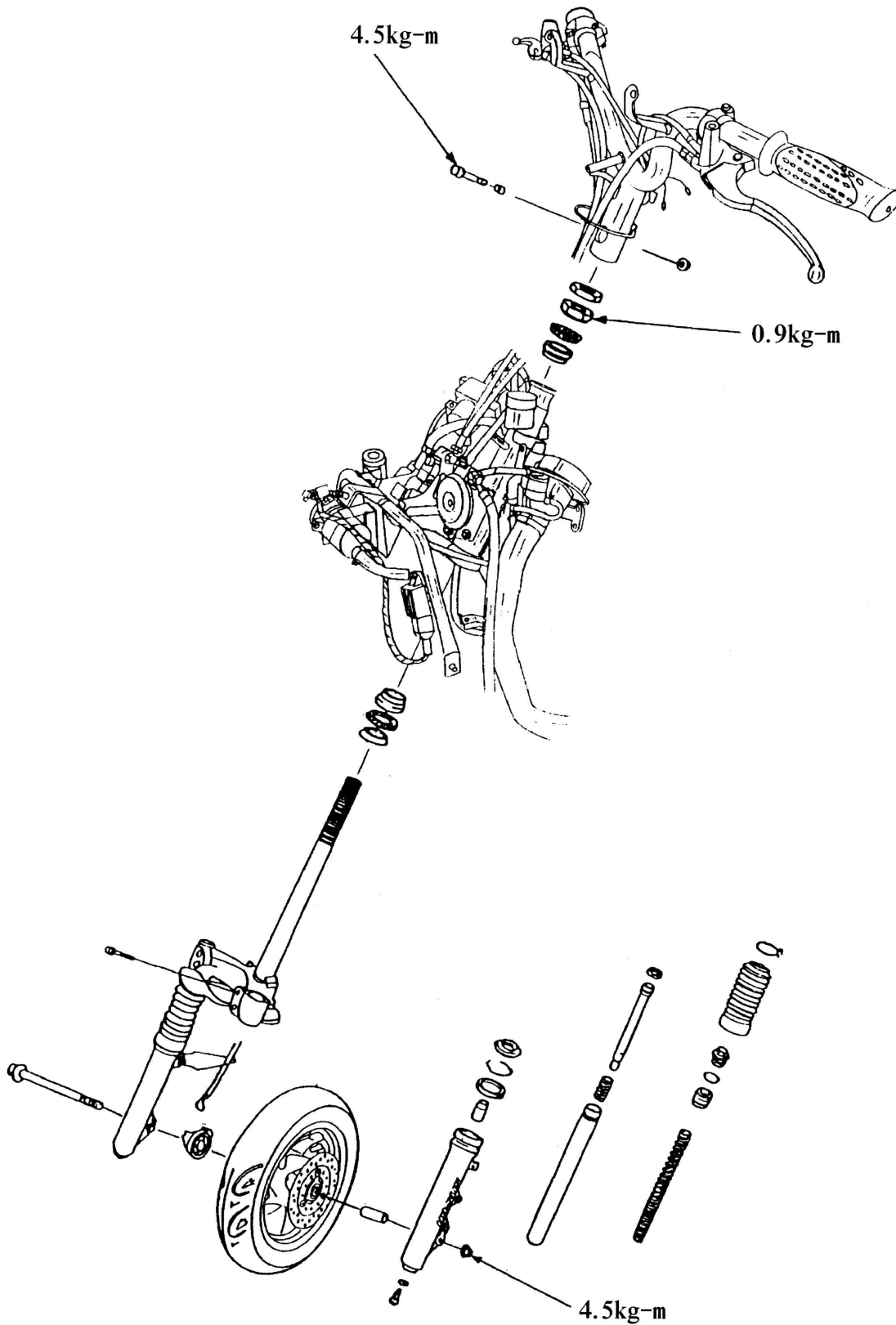

12

12. FRONT WHEEL/FRONT BRAKE/ FRONT SUSPENSION

SERVICE INFORMATION	12-1	HYDRAULIC BRAKE	12-7
TROUBLESHOOTING	12-2	FRONT SUSPENSION	12-9
FRONT WHEEL	12-3	STEERING HANDLEBAR.....	12-12
BEARING REPLACEMENT	12-4	STEERING STEM	12-13

SERVICE INFORMATION

GENERAL INSTRUCTIONS

Remove the motorcycle frame covers before removing the front wheel. Jack the motorcycle front wheel off the ground and be careful to prevent the motorcycle from falling down.

During servicing, keep oil or grease off the brake drum and brake linings.

Contaminated brake disk or brake pads reduce stopping power. Clean the contaminated brake disk with high-performance brake degreaser and replace the brake pads.

Do not use brake fluid for cleaning.

Bleed air from the brake system if the brake system is removed or the brake is soft.

Do not allow any foreign matters to enter the brake system when filling it with brake fluid.

Brake fluid will damage painted surfaces and plastic parts. When servicing the brake system, use shop towels to cover and protect rubber, plastic parts and coated surfaces. Wipe off any spilled brake fluid with a clean shop towel.

Inspect the brake system before riding.

SPECIFICATIONS

Item	Standard (mm)	Service limit (mm)
Axle shaft runout	—	0.2
Front wheel rim runout	Radial	2.0
	Axial	2.0
Front shock absorber spring free length	259	251
Front brake lining thickness	4.0	2.0
Brake disk thickness	3.5 ~ 3.8	3.0
Brake disk runout	—	0.30

TORQUE VALUES

Steering Handlebar bolt	4.0~5.0 kg-m
Steering stem lock nut	8.0~12.0 kg-m
Steering top cone race	0.5~1.3 kg-m
Front shock absorber bolt	2.0~2.5 kg-m
Front axle nut	4.5~5.0 kg-m
Front brake hose bolt	2.5~3.5 kg-m

12. FRONT WHEEL/FRONT BRAKE/ FRONT SUSPENSION

SPECIAL TOOLS

Oil Seal & Bearing Driver	E014
Bearing Puller (12 mm)	E020
Long Socket wrench	F002

TROUBLESHOOTING

Hard steering (heavy)

- Excessively tightened steering stem top cone race
- Broken steering balls
- Insufficient tire pressure

Steers to one side or does not track straight

- Uneven front shock absorbers
- Bent front fork
- Bent front axle or uneven tire

Poor brake performance

- Incorrectly adjusted brake
- Worn brake linings
- Contaminated brake lining surface
- Worn brake shoes at cam contacting area
- Worn brake drum
- Poorly connected brake arm

Front wheel wobbling

- Bent rim
- Excessive wheel bearing play
- Bent spoke plate
- Faulty tire
- Improperly tightened axle nut

Soft front shock absorber

- Weak shock springs
- Insufficient damper oil

Front shock absorber noise

- Slider bending
- Loose fork fasteners
- Lack of lubrication

12. FRONT WHEEL/FRONT BRAKE/ FRONT SUSPENSION

FRONT WHEEL

REMOVAL

Jack the motorcycle front wheel off the ground.
Remove the bolt and disconnect the speedometer cable.



Axle Shaft Speedometer cable

Remove the front axle nut and pull out the axle.
Remove the front wheel.
Remove the front brake disk.

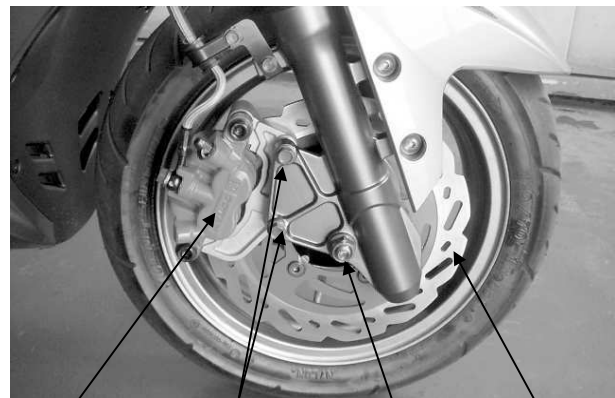

Caliper Bolts Nut Disk

INSPECTION

AXLE RUNOUT

Set the axle in V blocks and measure the runout using a dial gauge. The actual runout is 1/2 of the total indicator reading.

Service Limit: 0.2 mm replace if over

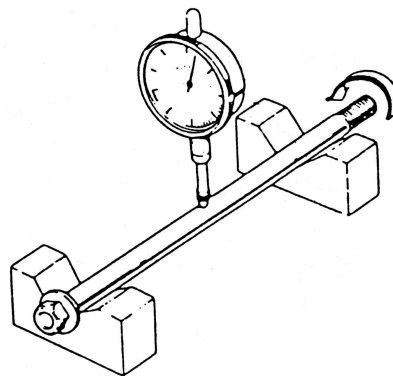

WHEEL RIM

Check the wheel rim runout.

Service Limits:

Radial: 2.0 mm replace if over

Axial: 2.0 mm replace if over

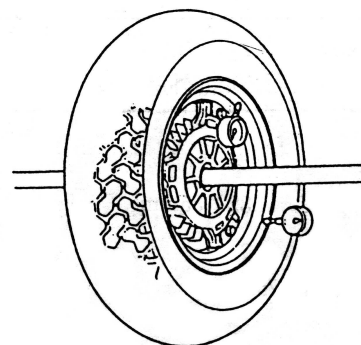

BEARING INSPECTION

Remove the side collar and dust seal.

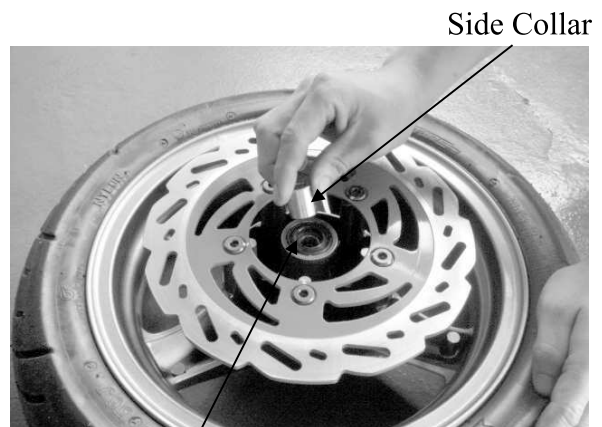

Dust Seal

Turn the inner race of each bearing with your finger to see if they turn smoothly and quietly. Replace a new bearings if not turning smoothly, quietly or loose.

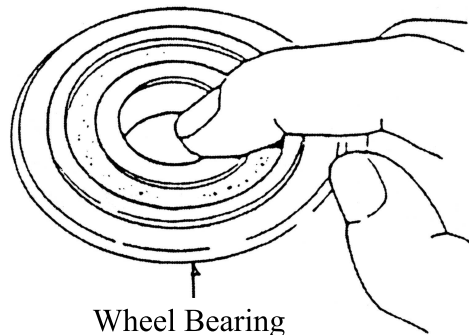

Wheel Bearing

BEARING REPLACEMENT

Remove the front wheel bearings and distance collar.

Special

Bearing Puller (12 mm) E020

Bearing Puller



Driver Handle A

Driver Handle A

Pack all bearing cavities with grease.

Drive in the left bearing.

Install the distance collar.

Drive in the right bearing.

*

Do not allow the bearings to tilt while driving them in.
Drive in the bearing squarely with the sealed end facing out.

Special

Seal & Bearing Driver



Pilot

12. FRONT WHEEL/FRONT BRAKE/ FRONT SUSPENSION

KYMCO
Movie S 125i

Apply grease to a new dust seal lip and install the dust seal.
Install the side collar.

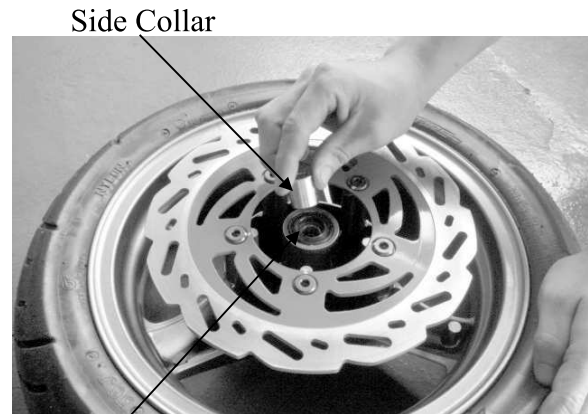

Dust Seal

Pawls

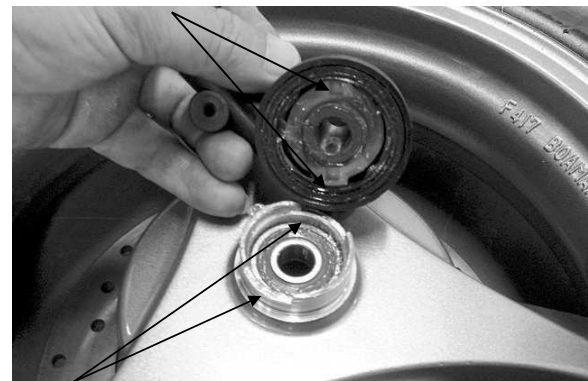

Cutouts

INSTALLATION

Apply grease to the speedometer gear.
Install the brake panel by aligning the speedometer retaining pawls with the hub cutouts.

*

If not aligned, the retaining pawl will be deformed when the axle nut is tightened.
After installing the axle, turn the wheel to make sure that the speedometer drive shaft rotates freely.

Apply a thin coat of grease to the axle shaft. Install the front wheel by aligning the brake panel groove with the front fork tab.
Insert the axle shaft.
Connect the speedometer cable and secure it with the screw.



Axle Shaft

Install and tighten the axle nut.

Torque: 6.0 kg-m

Install the front brake cable.

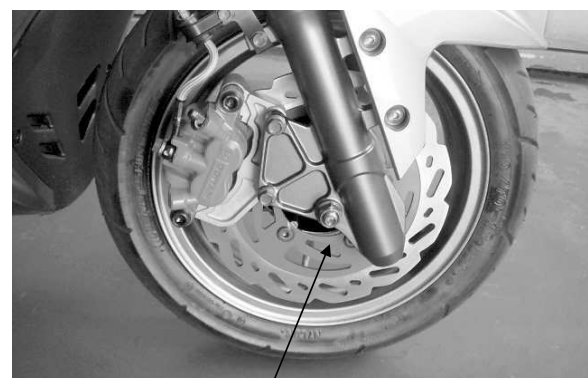

Axle Nut

12. FRONT WHEEL/FRONT BRAKE/ FRONT SUSPENSION

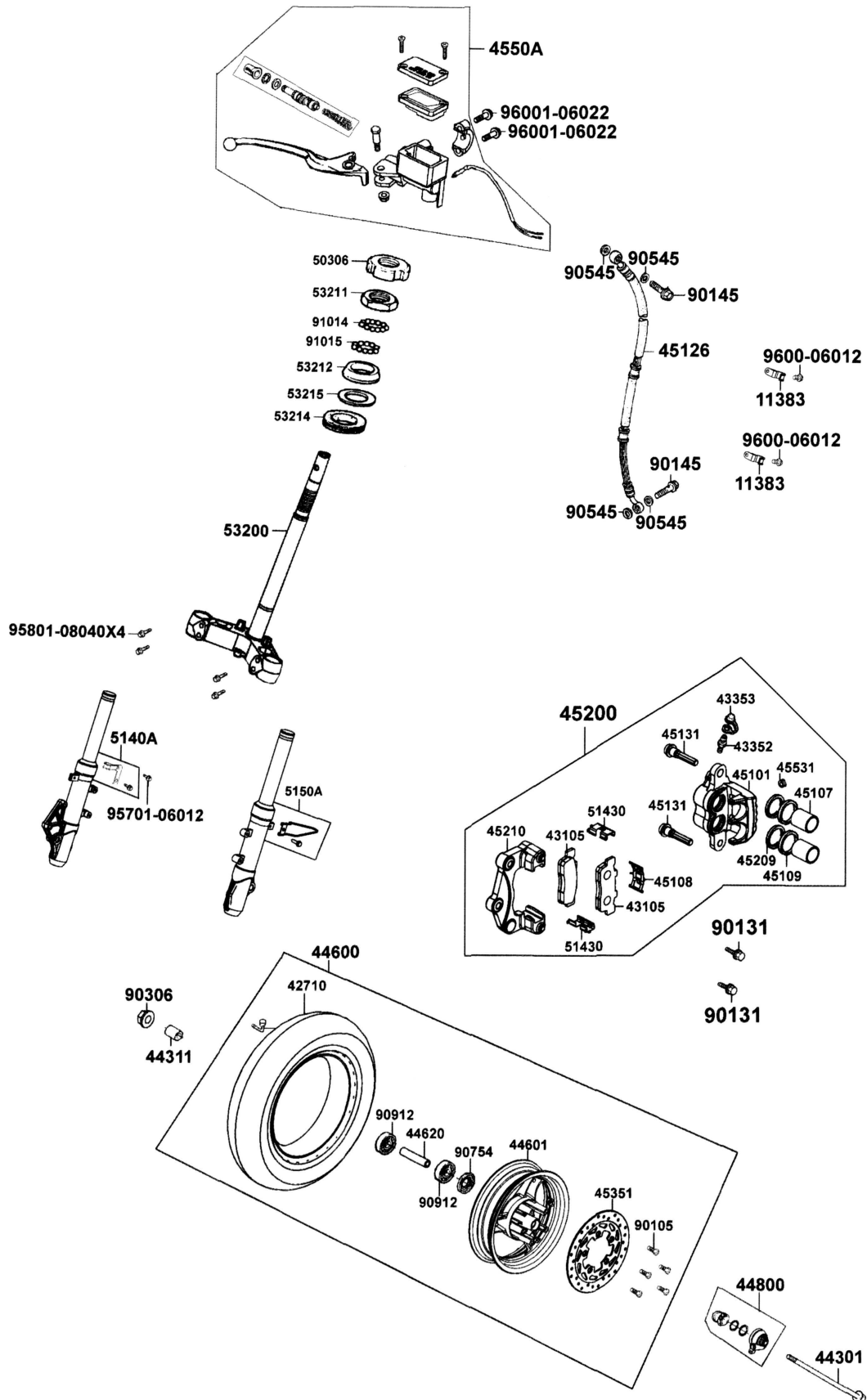

12. FRONT WHEEL/FRONT BRAKE/ FRONT SUSPENSION

HYDRAULIC BRAKE (FRONT BRAKE)

Check the brake fluid level on level ground.

*

When operating the brake lever, the brake reservoir cap must be tightened securely to avoid splash of brake fluid.
When servicing the brake system, use shop towels to cover plastic parts and coated surfaces to avoid damage caused by splash of brake fluid.

Upper Level

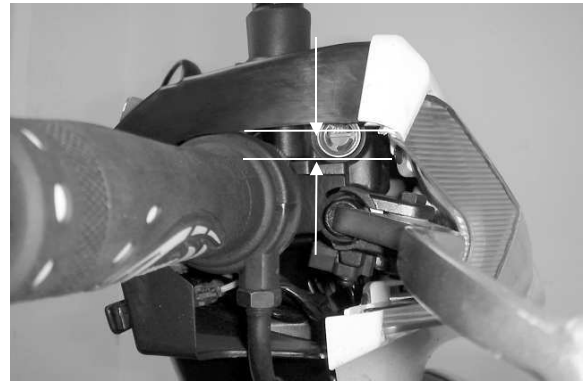

Lower Level

BRAKE FLUID BLEEDING

In order to avoid spilling brake fluid, connect a transparent hose to the bleed valve.

Fully apply the brake lever and then loosen the brake caliper bleed valve to drain the brake fluid until there is no air bubbles in the brake fluid. Then, tighten the bleed valve.

Repeat these steps until the brake system is free of air.



Caliper

BRAKE FLUID REFILLING

Add DOT-4 brake fluid to the brake reservoir.

*

When bleeding, be careful not to allow air in the brake reservoir flowing into the brake system.
Never use dirty or unspecified brake fluid or mix different brake fluids because it will damage the brake system.



Make sure to bleed air from the brake system.

BRAKE PAD/DISK REPLACEMENT

*

The brake pads must be replaced as a set to ensure the balance of the brake disk.

Remove the two bolts attaching the brake caliper.

Remove the brake caliper.

Compress the brake caliper seat, and press down the fixed-rod to take out the brake pads.

Bolts

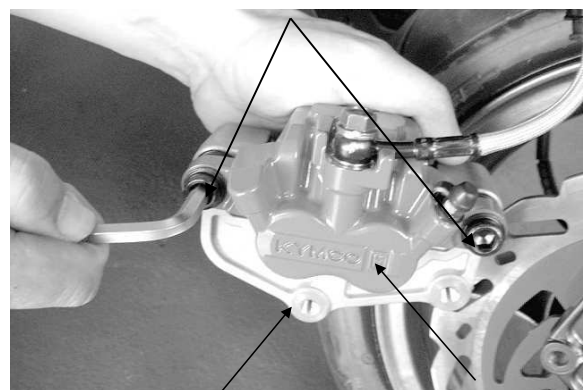

Caliper Seat

Caliper

12. FRONT WHEEL/FRONT BRAKE/ FRONT SUSPENSION

Install the brake pads in the reverse order of removal.

* Keep grease or oil off the brake pads to avoid brake failure.

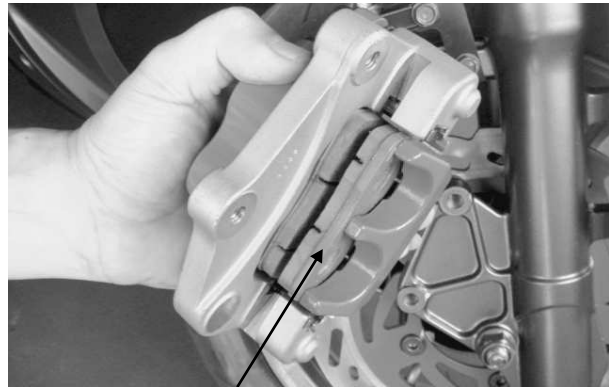

Pad comp

BRAKE DISK

Measure the brake disk thickness.

Service Limit: 3.0 mm

Measure the brake disk runout.

Service Limit: 0.3 mm



INSTALLATION

Install the brake caliper and tighten the two bolts.

Torque: 2.9~3.5 kg-m



Connect the brake fluid tube to the brake caliper and tighten the fluid tube bolt.

Torque: 2.5~3.5 kg-m

Fill the brake reservoir with recommended brake fluid and bleed air from the brake system.

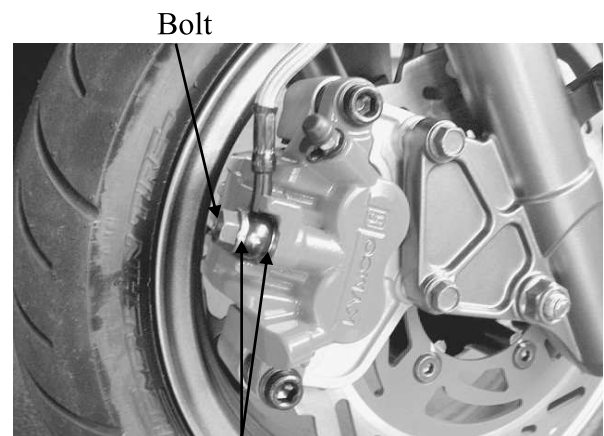

Washer

12. FRONT WHEEL/FRONT BRAKE/ FRONT SUSPENSION

KYMCO
Movie S 125i

FRONT SUSPENSION

REMOVAL

Remove the front cover.
Remove the front wheel.
Remove the front shock absorber upper mount bolts.
Loosen the lower mount bolts to remove the front shock absorbers.

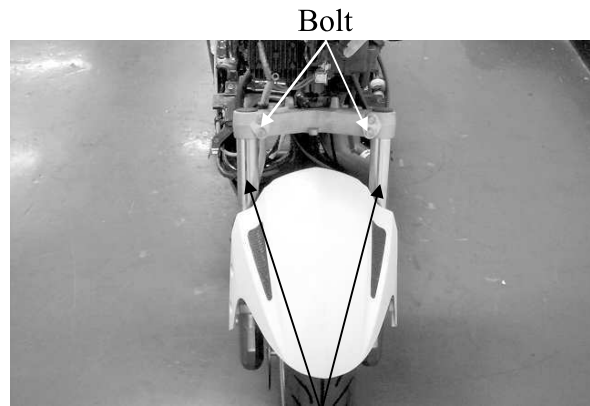

Bolt
Shock Absorber

DISASSEMBLY

Remove the dust boot.
Remove the circlip.

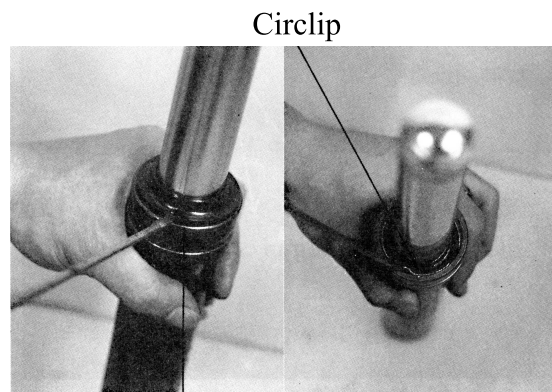

Circlip
Dust Boot

Set the front shock absorber in a vise.
Remove the damper rod, hex bolt and copper washer.
Pull out the front shock absorber tube.

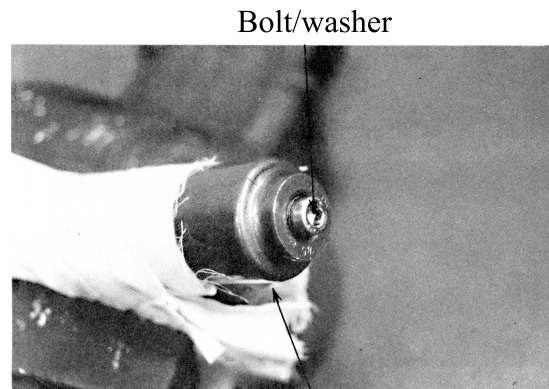

Bolt/washer
Six angle bolt

Set the front shock absorber tube in a vise.
Remove the lock bolt on the front shock absorber tube.

* When holding the shock absorber tube, place a shop towel to protect it and do not apply too much force.
Place a container under the front shock absorber to drain the engine oil from it.

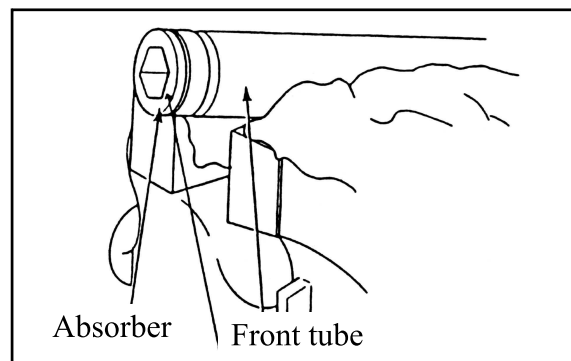

12. FRONT WHEEL/FRONT BRAKE/ FRONT SUSPENSION

 **KYMCO**
Movie S 125i

DISASSEMBLY

Take out the front shock absorber spring, damper and damper spring.

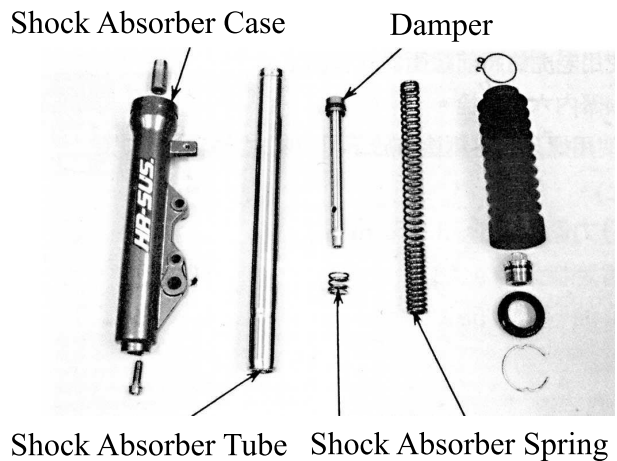

INSPECTION

Inspect the following items and replace if necessary.

Front shock absorber tube bending or damage

Weak front shock absorber spring

Damper and damper rod bending

Oil seal damage or wear

Measure the front shock absorber spring free length.

Service Limits:

Right 251 mm

Left 251 mm

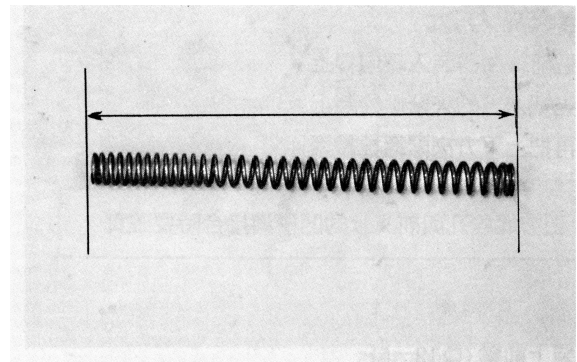

ASSEMBLY

Install the damper spring onto the damper rod and then install them into the front shock absorber tube. Install the shock absorber spring onto the front shock absorber tube and tighten the lock bolt on the top.

*

Install the front shock absorber spring with the closely wound coils facing down.

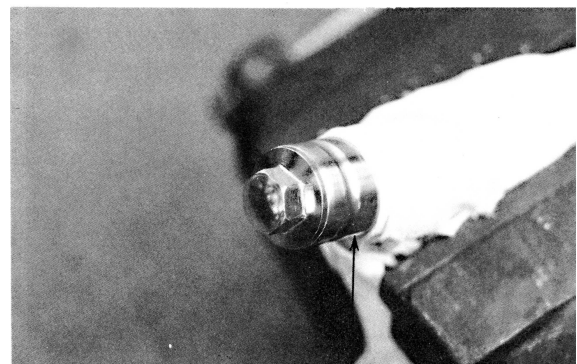

Front Absorber tube

12. FRONT WHEEL/FRONT BRAKE/ FRONT SUSPENSION

 **KYMCO**
Movie S 125i

Set the front shock absorber in a vise.
Insert the shock absorber tube into the shock absorber and tighten the hex bolt. Apply locking agent to the washer and install it together with the hex bolt.

Torque: 1.5~3.0 kg-m

Specified Oil: SS#8

Oil Capacity: 120 cc

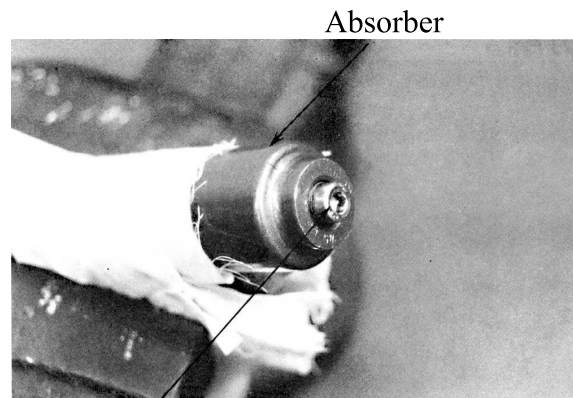

Six angle bolt

Install the circlip.
Install the dust boot.

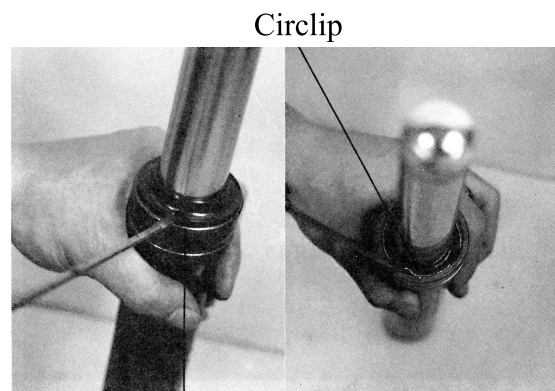

Dust Boot

INSTALLATION

Install the front shock absorbers onto the steering stem.

Install and tighten the front shock absorber upper mount bolts.

Tighten the lower mount bolts.

* Align the upper mount bolt hole with the groove on the front fork.

Torque: 2.0~2.5 kg-m

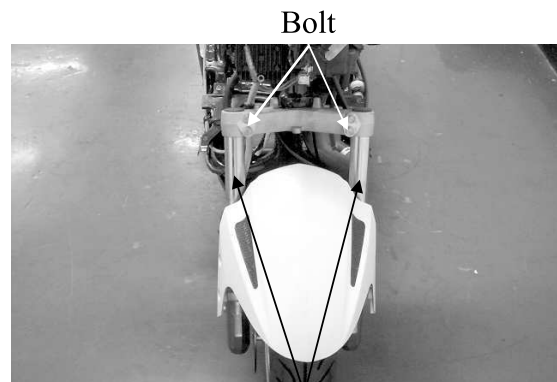

Shock Absorber

12. FRONT WHEEL/FRONT BRAKE/ FRONT SUSPENSION

STEERING HANDLEBAR

REMOVAL

Remove the handlebar covers.
Remove the rear brake lever holder bolt to remove the holder.
Remove the front brake master cylinder holder bolts to remove the brake master cylinder.

Rear brake lever Bolts Front brake lever



Remove the throttle seat screw and throttle grip.

Bolts Throttle grip

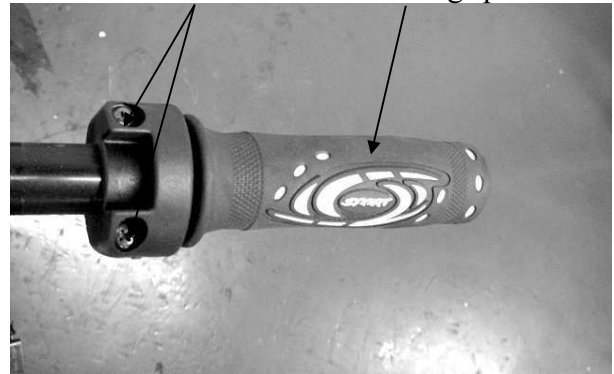

Remove the throttle seat from the handlebar and disconnect the throttle cable from the throttle pipe.
Remove the throttle pipe from the handlebar.

Throttle pipe



Remove the steering stem lock bolt, collar, nut and the handlebar.



Nut Collar Bolt

STEERING STEM

REMOVAL

Remove the steering stem lock nut.

 Special

Long Socket wrench

F002

Long Socket wrench

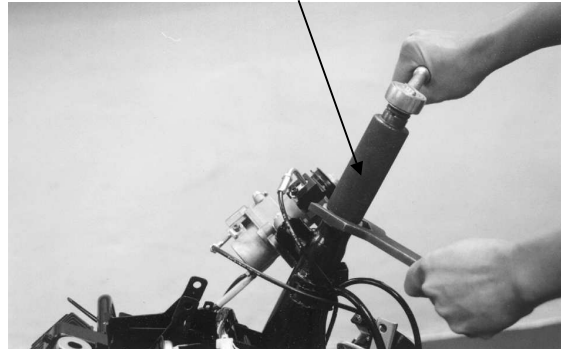

Remove the top cone race.

* Be careful not to lose the steel balls (26 on top race and 19 on bottom race).
Clean the openings of frame covers with clean shop towels.

Top Cone Race

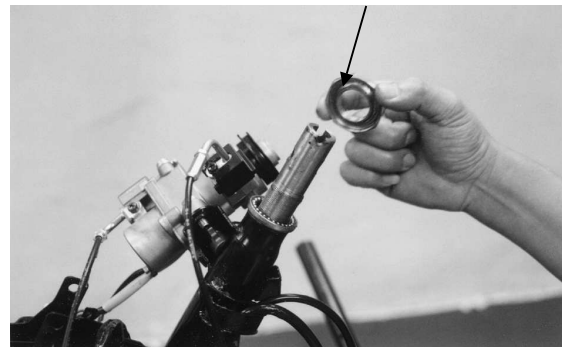

Remove the front fork.

BOTTOM CONE RACE REPLACEMENT

Remove the bottom cone race using a chisel.

* Be careful not to damage the steering stem and front fork.

Drive a new bottom cone race into place with a proper driver.

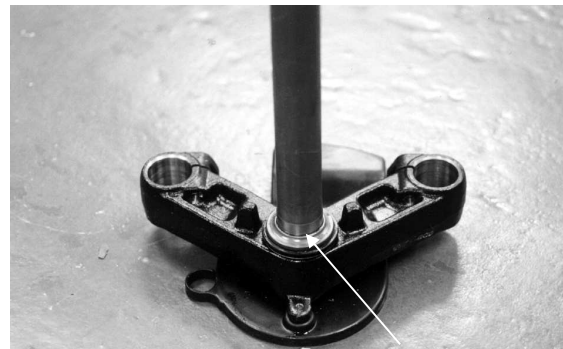

Bottom Cone Race

BALL RACE REPLACEMENT

Drive out the top and bottom ball races.

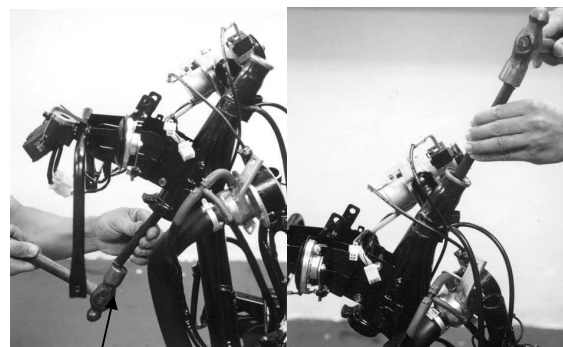

Race Cone remover

12. FRONT WHEEL/FRONT BRAKE/ FRONT SUSPENSION

 **KYMCO**
Movie S 125i

BOTTOM CONE RACE INSTALLATION

Drive new top and bottom ball races into the steering head using the outer driver.

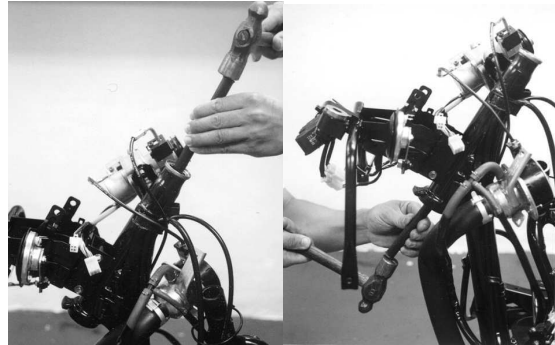

Apply grease to the top and bottom ball races and install 26 steel balls on the top ball race and 19 steel balls on the bottom ball race.

Apply grease to the ball races and install the front fork.

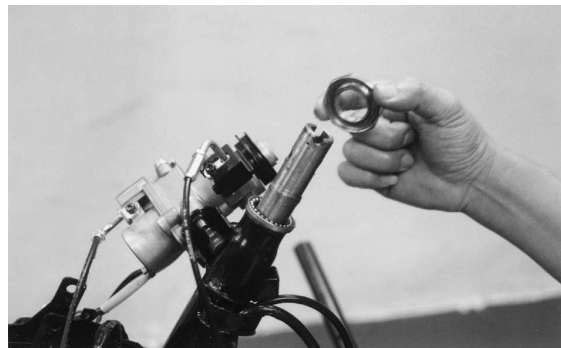

Apply grease to the top cone race and install it. Tighten the top cone race and then turn the steering stem right and left several times to make steel balls contact each other closely.

* Check that the steering stem rotates freely without vertical play.

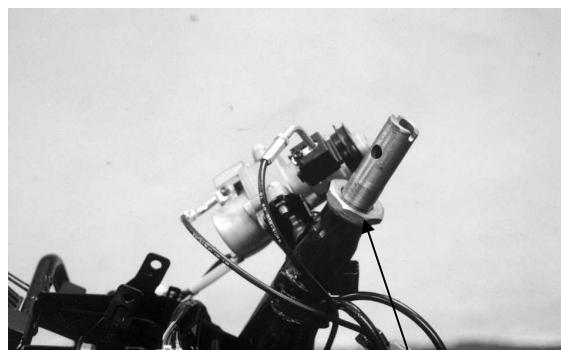

Top Cone Race

Install the steering stem lock nut and tighten it while holding the top cone race.

Torque: 8.0~12.0 kg-m

Install the front wheel.

Long Socket wrench



HANDLEBAR INSTALLATION

Install the handlebar onto the steering stem tube and then install and tighten the bolt.

Torque: 4.0 ~ 5.0 kg-m

Install the front wheel.

Install the brake levers.

Install the handlebar covers.



Nut

Collar

Bolt

13. REAR WHEEL/REAR BRAKE/ REAR SUSPENSION

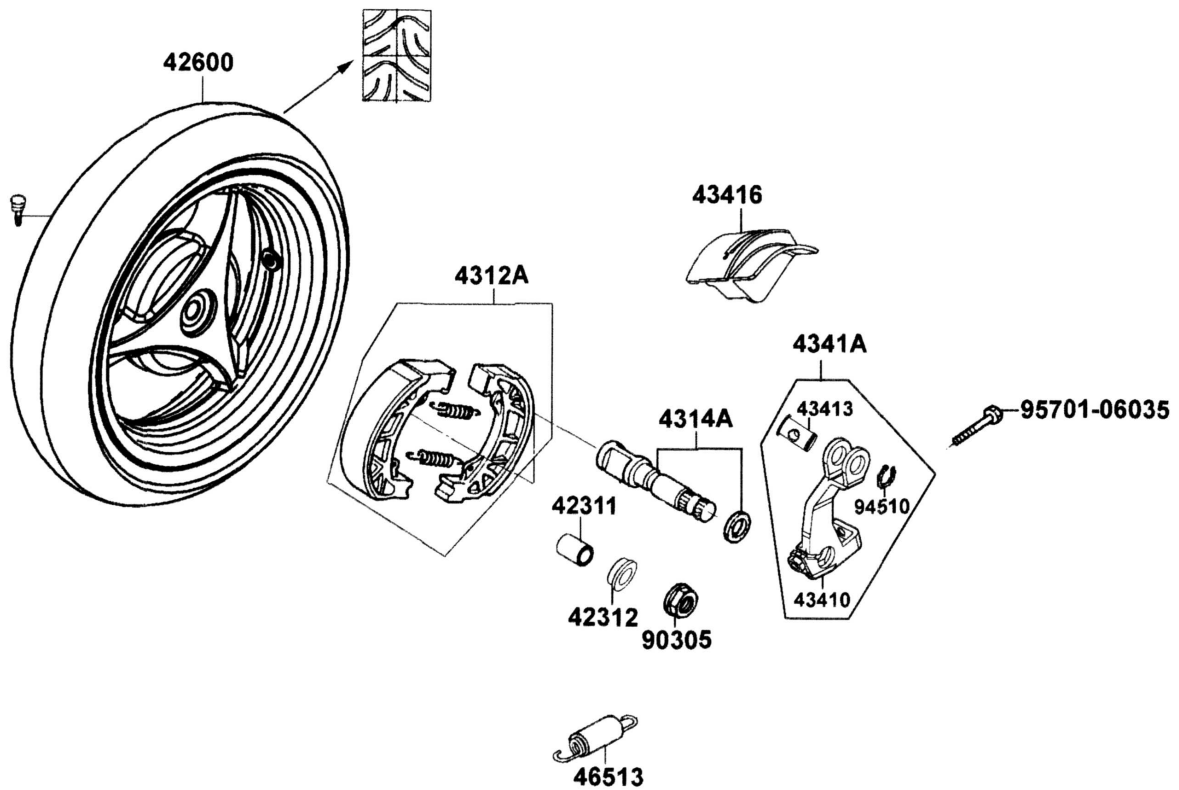

13

13. REAR WHEEL/REAR BRAKE/ REAR SUSPENSION

SERVICE INFORMATION	13-1	REAR BRAKE	13-2
TROUBLESHOOTING	13-1	REAR SHOCK ABSORBER	13-4
REAR WHEEL	13-2		

SERVICE INFORMATION

GENERAL INSTRUCTIONS

During servicing, keep oil or grease off the brake drum and brake linings.

SPECIFICATIONS

Item		Standard (mm)	Service Limit (mm)	
Rear wheel	Rim runout	Radial	—	2.0
		Axial	—	2.0
	Rear brake drum I.D		130	131
Rear brake lining thickness		4.0	2.0	

TORQUE VALUES

Rear axle nut	11 kg-m
Rear shock absorber upper mount bolt	4 kg-m
Rear shock absorber lower mount bolt	2.5 kg-m
Exhaust muffler joint lock nut	1.2 kg-m
Exhaust muffler lock bolt	3.5 kg-m

TROUBLESHOOTING

Rear wheel wobbling

- Bent rim
- Faulty tire
- Axle not tightened properly

Soft rear shock absorber

- Weak shock absorber spring
- Faulty damper

Poor brake performance

- Brake not adjusted properly
- Worn brake linings
- Worn brake shoes at cam contacting area
- Worn brake cam
- Worn brake drum

13. REAR WHEEL/REAR BRAKE/ REAR SUSPENSION

REAR WHEEL

REMOVAL

Remove the O2 sensor's wire connector.
Remove the exhaust muffler.
Remove the rear axle nut and the rear wheel.

* Be careful prevent the O2 sensor from damage while removing the muffler.



INSPECTION

Measure the rear wheel rim runout.

Service Limits :

Radial : 2.0 mm replace if over

Axial : 2.0 mm replace if over

If the rim runout exceeds the specified service limits, check the final shaft bearing for excessive play and the final shaft for bending. Inspect the rear wheel and wheel rim for runout.

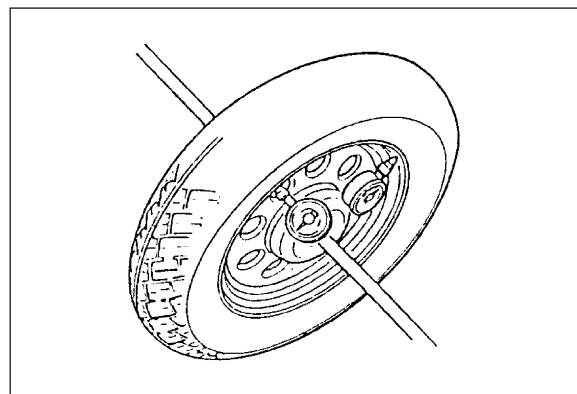

INSTALLATION

Tighten the rear axle nut.

Torque : 11.0-13.0 kg-m

Install the exhaust muffler.

Torque :

Exhaust muffler joint lock nut : 1.2 kg-m

Exhaust muffler lock bolt : 3.5 kg-m



REAR BRAKE

Remove the rear wheel.

Inspect the rear brake drum.

Measure the rear brake drum I.D.

Service Limits: 131 mm replace if over

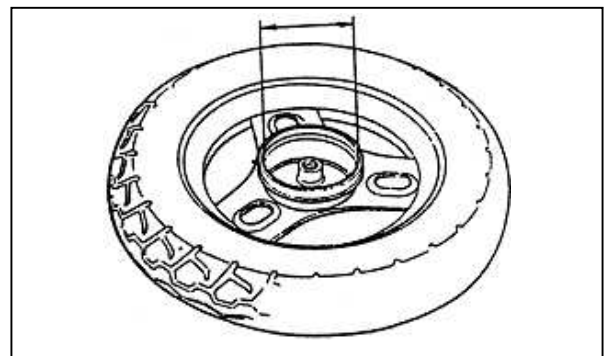

13. REAR WHEEL/REAR BRAKE/ REAR SUSPENSION

REAR BRAKE

BRAKE LINING INSPECTION

Measure the brake lining thickness.

Service Limit : 2.0 mm replace if below

* Keep oil or grease off the brake linings.

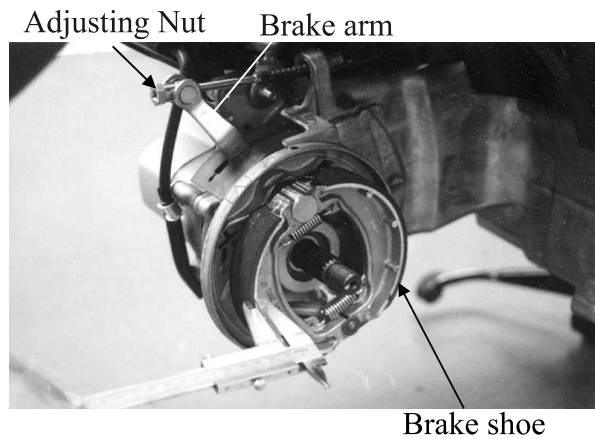

REAR BRAKE DISASSEMBLY

Remove the rear brake adjusting nut and disconnect the rear brake cable. Remove the rear brake shoes.



Remove the brake arm bolt to remove the brake arm, wear indicator plate and felt seal. Remove the brake cam.

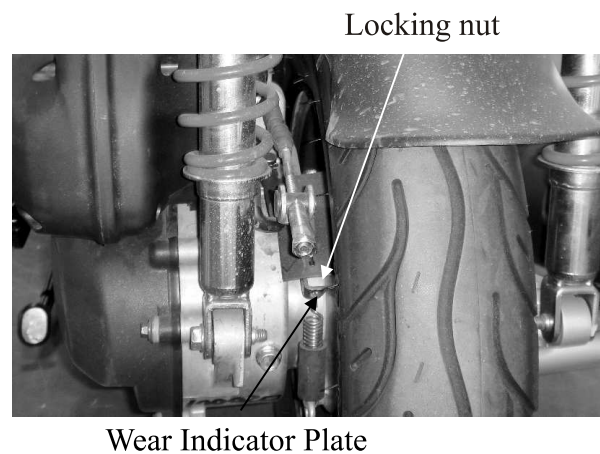

REAR BRAKE ASSEMBLY

Apply grease to the anchor pin. Apply grease to the brake cam and install it. Install the brake shoes.

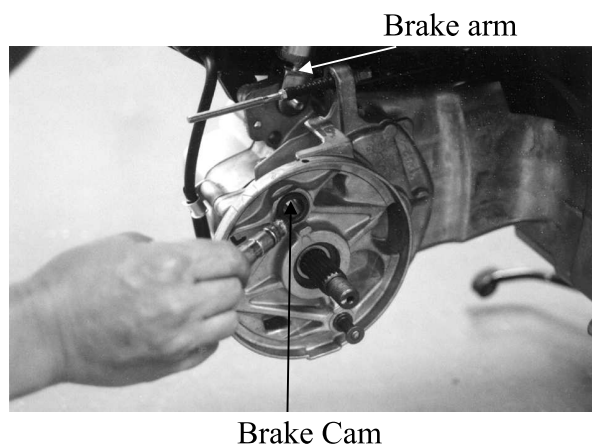

13. REAR WHEEL/REAR BRAKE/ REAR SUSPENSION

Apply a few amount of engine oil to the felt seal and install it to the brake cam.
Install the wear indicator plate and brake arm.

* Align the wide groove on the wear indicator plate with the wide tooth of the brake cam.

Install and tighten the brake arm bolt.

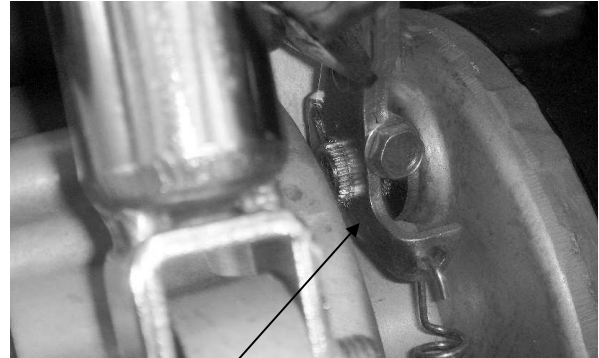

Wear Indicator Plate

* Align the scribed line on the brake arm with the punch mark on the brake cam.

Install the brake arm return spring. Install the brake arm pin. Connect the brake cable and install the adjusting nut. Install the rear wheel. Adjust the rear brake lever free play.

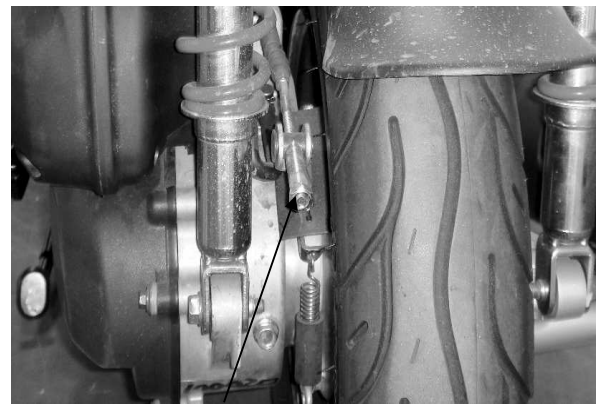

Adjusting nut

REAR SHOCK ABSORBER REMOVAL

Remove the frame body cover.
Remove the air cleaner case.

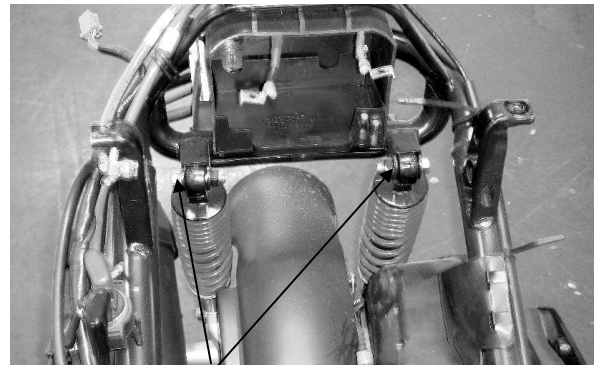

Bolt

Remove the rear shock absorber upper and lower mount bolts.
Remove the rear shock absorber.

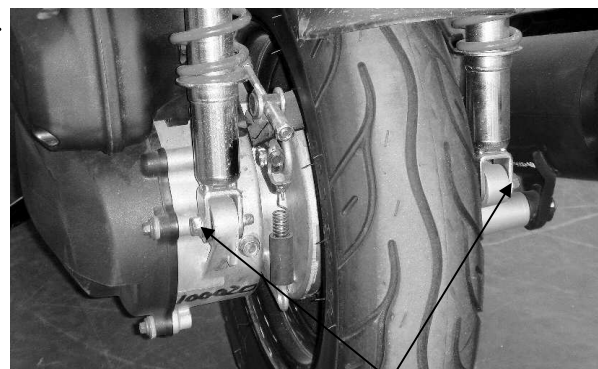

Bolt

13. REAR WHEEL/REAR BRAKE/ REAR SUSPENSION

INSTALLATION

Install the rear shock absorber.

Install the rear shock absorber upper mount bolt and then the lower mount bolt. Tighten the bolts.

Torque :

Upper Mount Bolt: 4.0 kg-m

Lower Mount Bolt: 2.5 kg-m

Install the air cleaner case.

Install the frame body cover.



Bolt

14. BATTERY/CHARGING SYSTEM/ A.C. GENERATOR

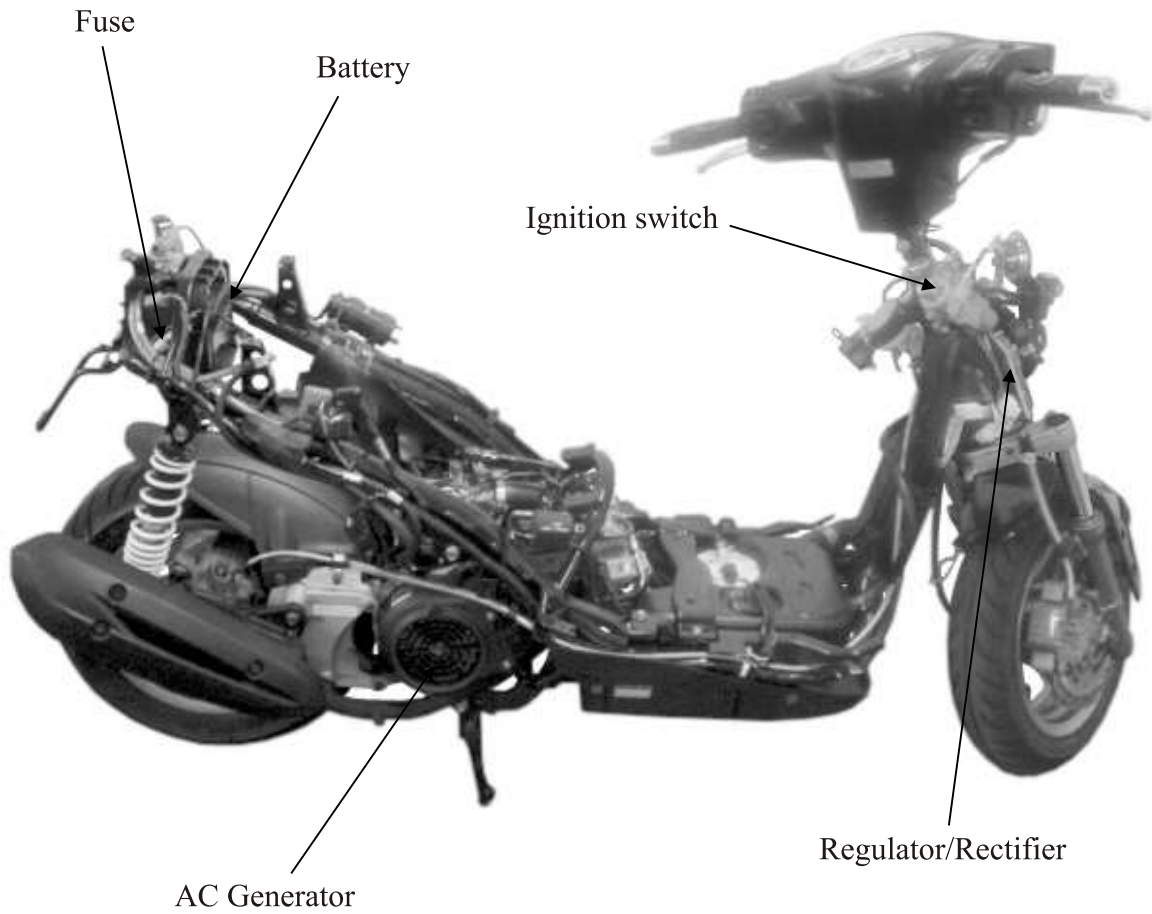

14

CHARGING SYSTEM DIAGRAM

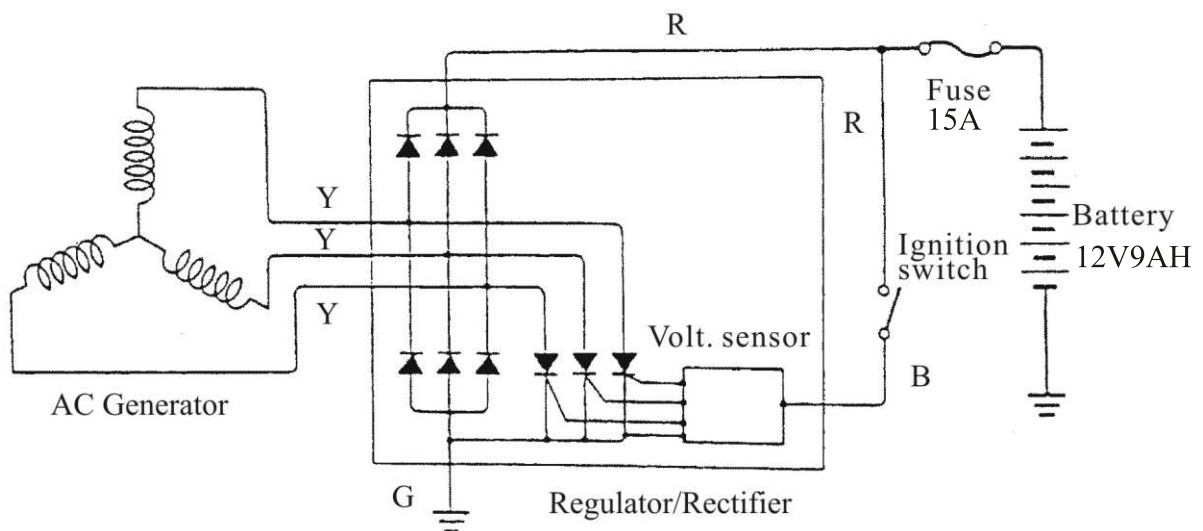

14. BATTERY/CHARGING SYSTEM/ A.C. GENERATOR

SERVICE INFORMATION.....	14-1	CHARGING SYSTEM.....	14-4
TROUBLESHOOTING.....	14-2	REGULATOR/RECTIFIER	14-5
BATTERY.....	14-3	A.C. GENERATOR	14-6

SERVICE INFORMATION

GENERAL INSTRUCTIONS

*

The battery electrolyte (sulfuric acid) is poisonous and may seriously damage the skin and eyes. Avoid contact with skin, eyes, or clothing. In case of contact, flush with water and get prompt medical attention

The battery can be charged and discharged repeatedly. If a discharged battery is not used for a long time, its service life will be shortened. Generally, the capacity of a battery will decrease after it is used for 2 or 3 years. A capacity-decreased battery will resume its voltage after it is recharged but its voltage decreases suddenly and then increases when a load is added.

When a battery is overcharged, some symptoms can be found. If there is a short circuit inside the battery, no voltage is produced on the battery terminals. If the rectifier would not operate, the voltage will become too high and shorten the battery service life.

If a battery is not used for a long time, it will discharge by itself and should be recharged every 3 months. A new battery filled with electrolyte will generate voltage within a certain time and it should be recharged when the capacity is insufficient. Recharging a new battery will prolong its service life.

Inspect the charging system according to the sequence specified in the Troubleshooting.

Do not disconnect and soon reconnect the power of any electrical equipment because the electronic parts in the regulator/rectifier will be damaged. Turn off the ignition switch before operation.

It is not necessary to check the MF battery electrolyte or fill with distilled water.

Check the load of the whole charging system.

Do not quick charge the battery. Quick charging should only be done in an emergency.

Remove the battery from the motorcycle for charging.

When replacing the battery, do not use a traditional battery.

When charging, check the voltage with a voltmeter.

14. BATTERY/CHARGING SYSTEM/ A.C. GENERATOR

SPECIFICATIONS

Item		Standard	
Battery	Capacity/Model	12V/YTX9-BS , GTX9-BS	
	Voltage (20°C)	Fully charged	13.1V
		Undercharged	12.3V
	Charging current	STD: 0.9A	
	Charging time	STD: 5 ~ 10hr	
	Limit voltage	14.5±0.5V/5000rpm	
A.C. Generator	Capacity	150 W / 5000 rpm	
	Lighting coil resistance (20°C)	Yellow ~ Yellow	1.0 ~ 1.8Ω
	Charging coil resistance (20°C)	Min. 1.0 A / 2500 rpm Min. 2.0 A / 6000 rpm	

TORQUE

CPS bolt	0.5 kg-m
Stator bolt	0.9 kg-m
Flywheel nut	5.5 kg-m
Cooling fan bolt	0.9 kg-m

SPECIAL TOOLS

Universal holder	E017
Flywheel puller	E002

TROUBLESHOOTING

No power

- Dead battery
- Disconnected battery cable
- Fuse burned out
- Faulty ignition switch

Low power

- Weak battery
- Loose battery connection
- Charging system failure
- Faulty regulator/rectifier

Intermittent power

- Loose battery cable connection
- Loose charging system connection
- Loose connection or short circuit in lighting system

Charging system failure

- Loose, broken or shorted wire or connector
- Faulty regulator/rectifier
- Faulty A.C. generator

14. BATTERY/CHARGING SYSTEM/ A.C. GENERATOR

Movie S 125i

BATTERY

REMOVAL

Remove the battery cover screws in met in-box. Open the battery cover and remove the battery by removing the bolt and band. First disconnect the battery negative (-) cable and then the positive (+) cable.

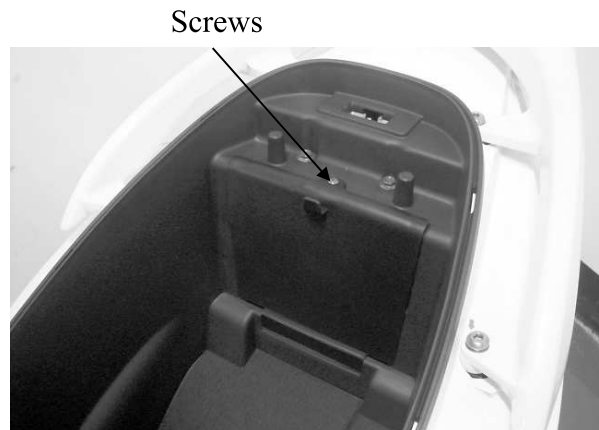

⚠ When disconnecting the battery positive (+) cable, do not touch the frame with tool; otherwise it will cause short circuit and sparks to fire the fuel.

⚠ First connect the positive (+) cable and the negative (-) cable to avoid short circuit.

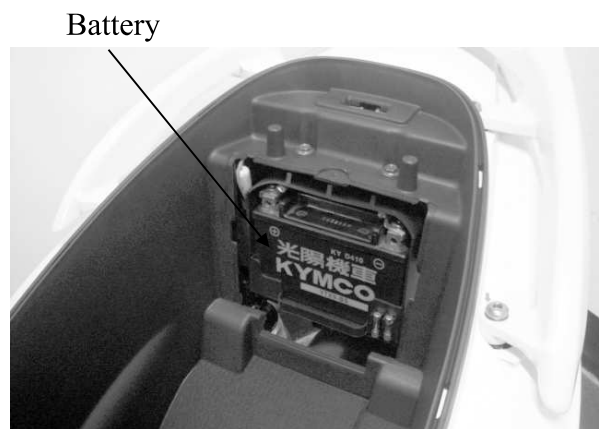

BATTERY VOLTAGE INSPECTION

Open the battery cover and disconnect the battery cables. Measure the voltage between the battery terminals.

Fully charged : 13.1V

Low charged : 12.3V max.

* Battery charging inspection must be performed with a voltmeter.

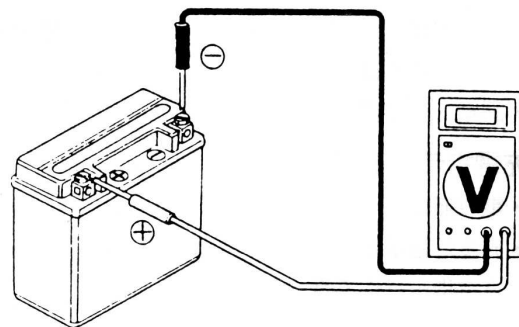

CHARGING

Connect the charger positive (+) cable with the battery positive (+) terminal. Connect the charger negative (-) cable with the battery negative (-) terminal.

⚠ Keep flames and sparks away from a charging battery. Turn power ON/OFF at the charger, not at the battery terminals to prevent sparks near the battery to avoid explosion. Charge the battery according to the current specified on the battery.

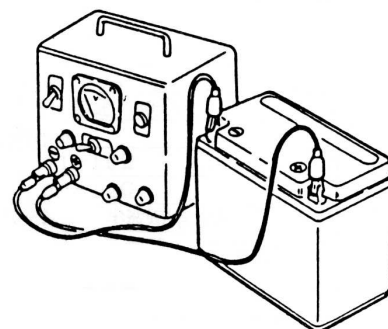

Charging current : 0.9A

Charging time : 5~10 hours

After charging : 12.8V min.

CHARGING SYSTEM

This inspection must be performed with an electric tester when the battery is fully charged.

Warm up the engine for inspection.

Connect the voltmeter with battery terminals. Attach a tachometer to the engine. Start the engine and gradually increase the engine speed to measure the limit voltage and current.

Limit Voltage : $14.5 \pm 0.5V$ / 5000 rpm



If the limit voltage is not within the specified range, check the regulator/rectifier.

CHARGING PERFORMANCE

Position \ RPM	1500	5000
Day	6.5 A min.	10.8 A min.
Night	6.5 A min.	10.8 A min.

* Perform this test with a fully charged battery.



Remove the right side skirt.

Disconnect the A.C. generator connector.

Check the continuity among the yellow wires.

There should be continuity between the yellow wires and no continuity between each yellow wire and ground.

Resistance

Yellow ~ Yellow $1.0 \sim 1.8 \Omega$



REGULATOR/RECTIFIER

INSPECTION

Remove the front covers.
Remove the regulator/rectifier 4P coupler and check for continuity between the wire harness terminals according to the following :



Forward: Pass

	(+)Probe	(-)Probe
I	Yellow	Green
II	Red	Yellow

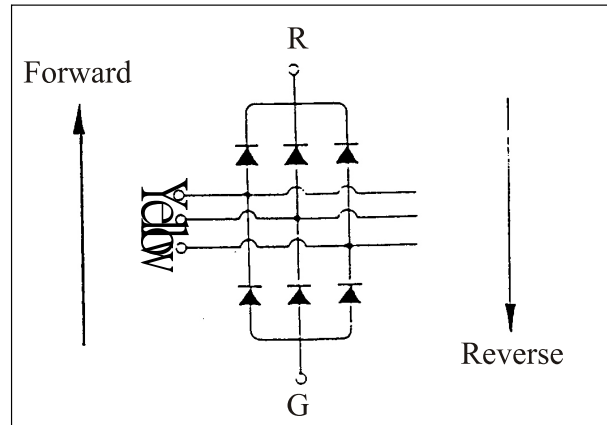

Reverse: Disconnect

	(+)Probe	(-)Probe
I	Green	Yellow
II	Yellow	Red

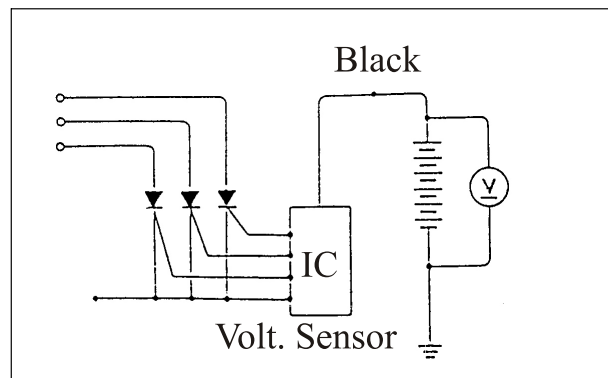

PERFORMANCE TEST

Connect the voltmeter with battery wires.
Start the engine and gradually increase the engine speed.
The battery terminal voltage should be within 14.0 -15.0V.

14. BATTERY/CHARGING SYSTEM/ A.C. GENERATOR

A.C. GENERATOR

Remove the right cover.
Remove the four bolts attaching the fan cover.
Remove the fan cover.

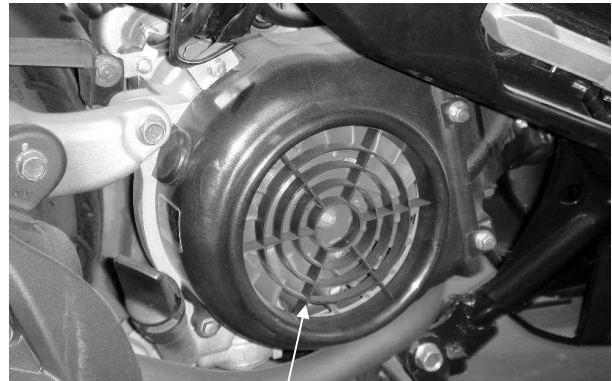

Fan cover

Remove the cooling fan by removing the four cooling fan attaching bolts.

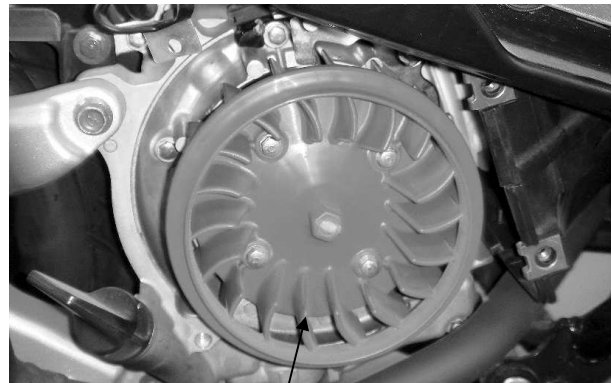

Cooling Fan

Hold the flywheel with an universal holder.
Remove the flywheel nut.



Universal holder E017

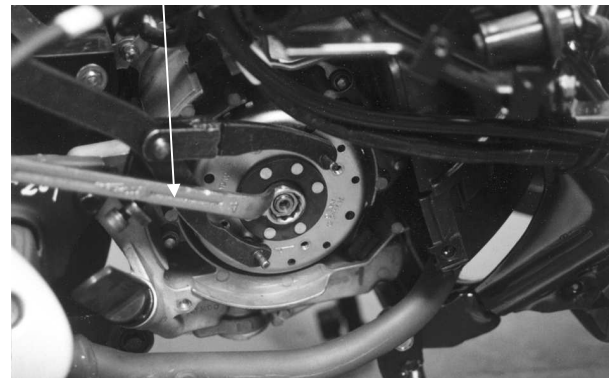

Remove the A.C. generator flywheel using the flywheel puller.
Remove the woodruff key.



Flywheel puller E002

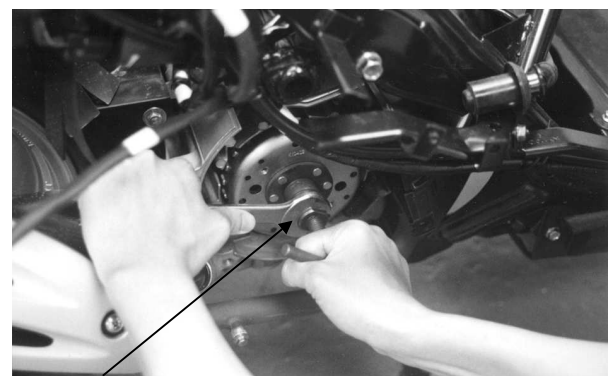

Flywheel puller

14. BATTERY/CHARGING SYSTEM/ A.C. GENERATOR

Remove the A.C. generator wire connector.

A.C. Generator Wire Connector



Remove the A.C. generator wire set plate.
Remove the CPS bolts.
Remove the A.C. generator wire rubber sleeve and CPS.

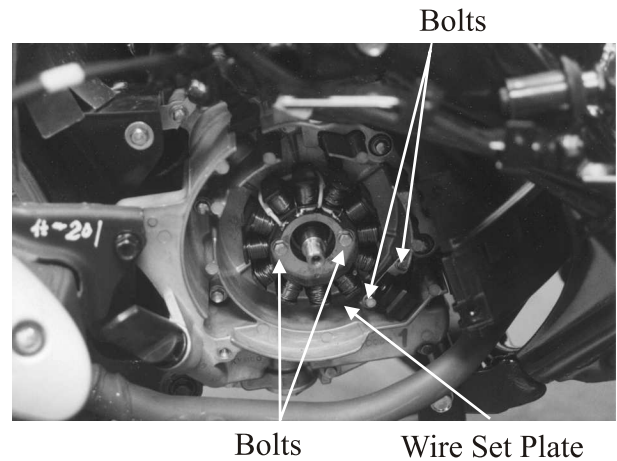

INSTALLATION

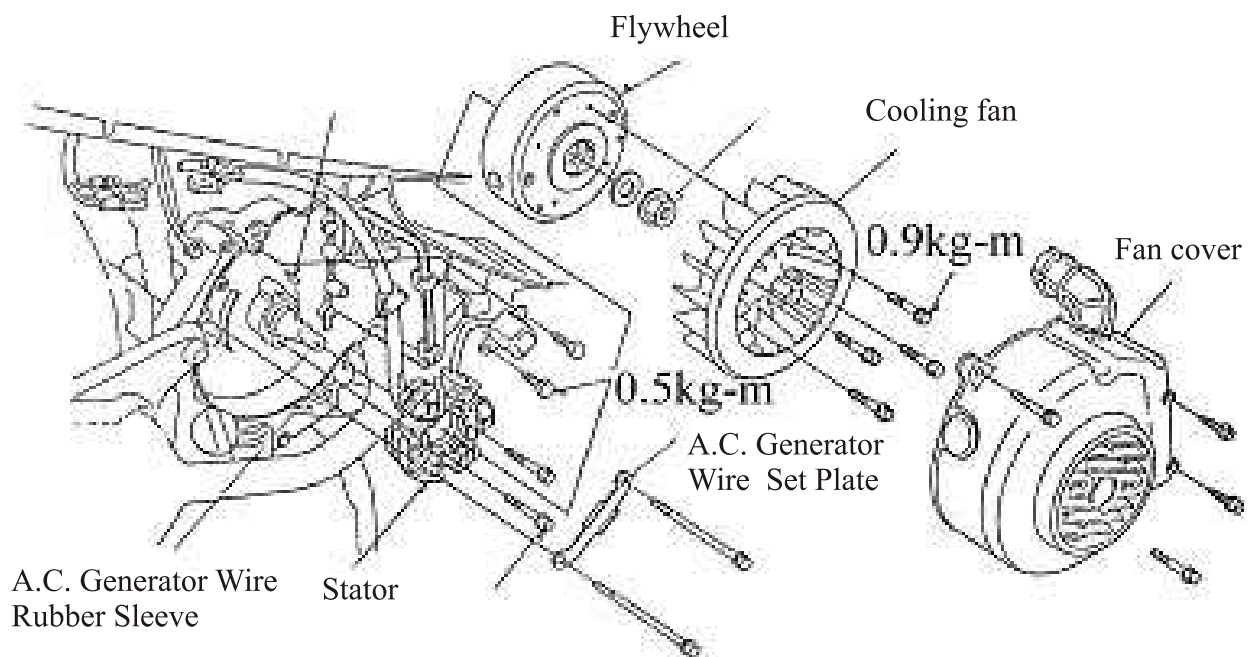

14. BATTERY/CHARGING SYSTEM/ A.C. GENERATOR

 **KYMCO**
Movie S 125i

Install the CPS on the right crankcase/
Tighten the bolts attaching the CPS.

Torques :

CPS : 0.5 kg-m

Stator : 0.9 kg-m

Connect the A.C. Generator Wire Connector.
Install the Wire Set Plate.

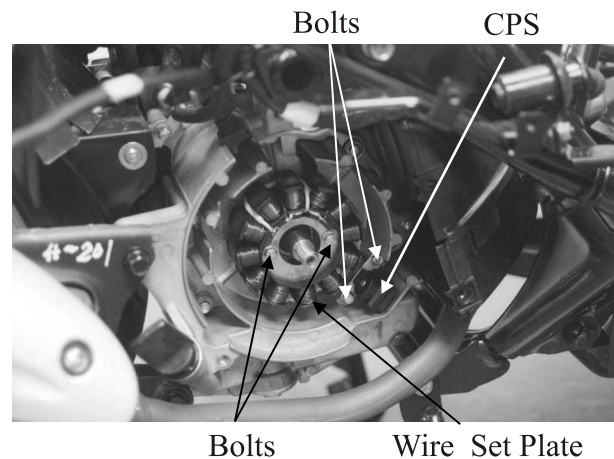

Connect the A.C. generator wire connector.



A.C. Generator Wire Connector

Clean the taper hole in the flywheel off any burrs
and dirt.
Install the woodruff key in the crankshaft keyway.



Woodruff Key

Hold the flywheel with the universal holder and
tighten the flywheel nut.

Torque : 5.5 kg-m

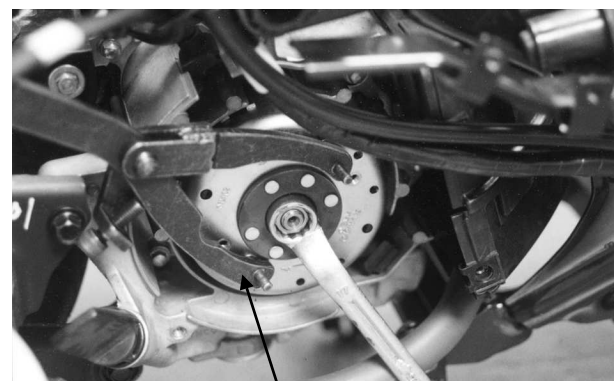

Universal holder

14. BATTERY/CHARGING SYSTEM/ A.C. GENERATOR

Special

Universal holder E017

Install the cooling fan.

Torque : 0.9 kg-m

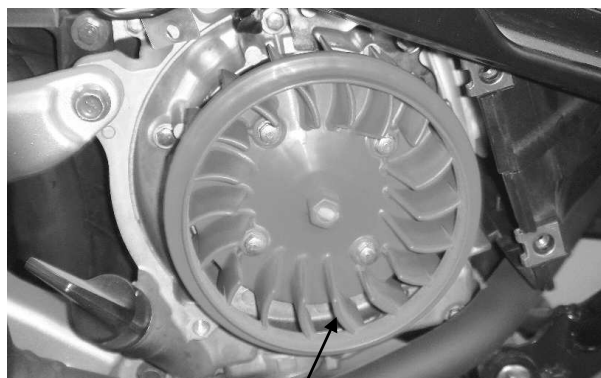

Cooling fan

Install the fan cover.
Install the right side cover.



Fan cover

15. IGNITION SYSTEM

15

IGNITION SYSTEM

IGNITION SYSTEM LAYOUT	15-1
IGNITION CIRCUIT	15-2
SERVICE INFORMATION.....	15-3
TROUBLESHOOTING.....	15-3
IGNITION COIL	15-4
AC GENERATOR	15-4
TILT SWITCH	15-5

IGNITION SYSTEM LAYOUT

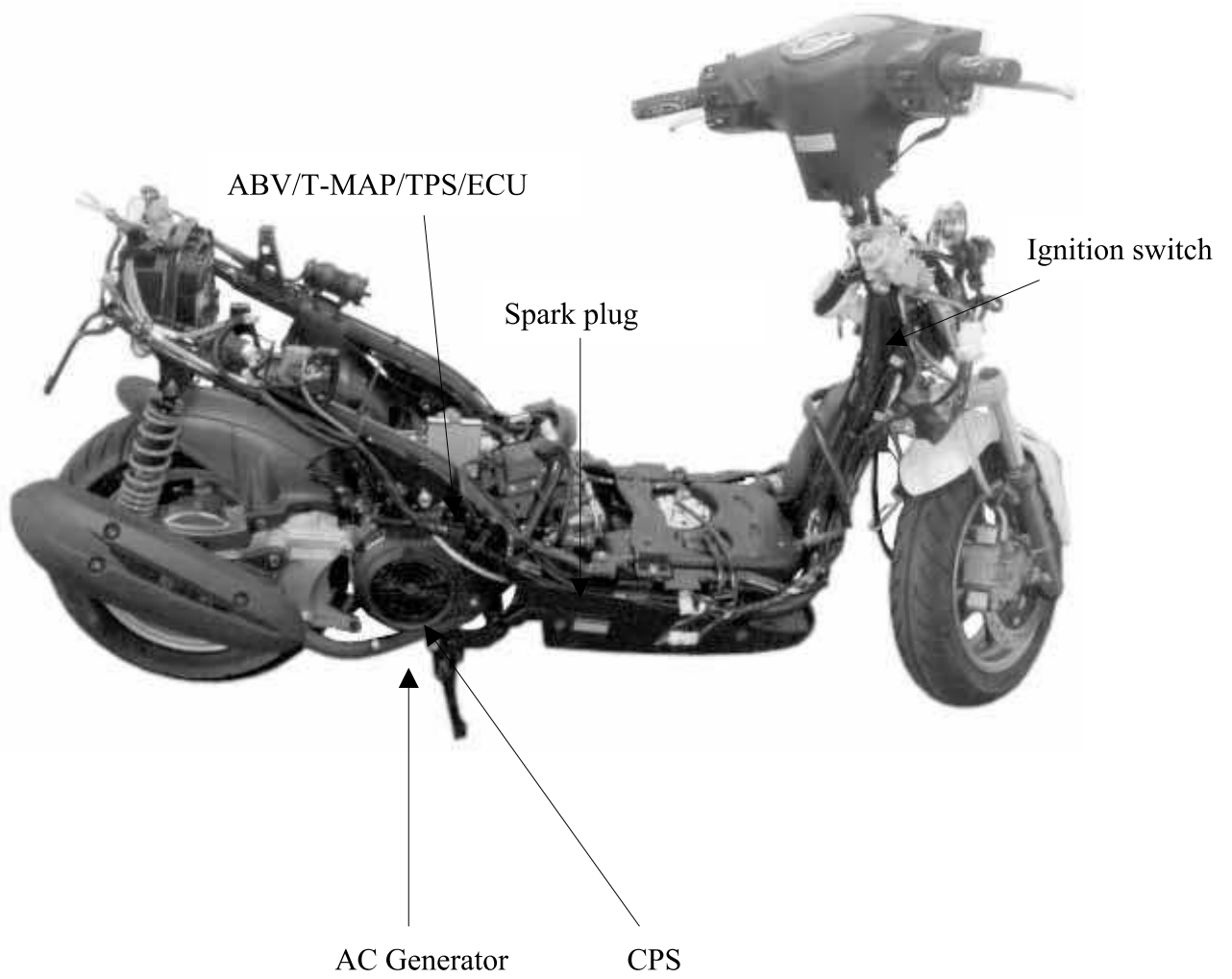

15. IGNITION SYSTEM

Movie S 125i

IGNITION CIRCUIT

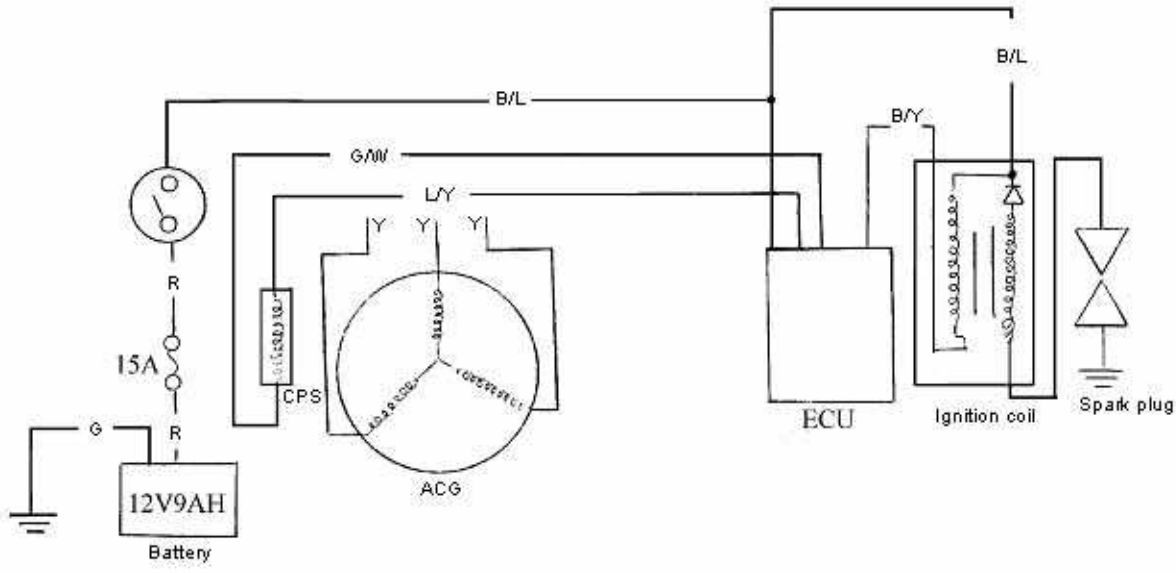

SERVICE INFORMATION

GENERAL INSTRUCTIONS

Some electrical components may be damaged if terminals or connectors are disconnected while the ignition switch is “ON”.

- When servicing the ignition system, always follow the steps in the troubleshooting.
- The ignition timing cannot be adjusted since the ignition control module is set by factory preset.
- The ignition control module or ECU may be damaged if battery’s power dropped. Also, if the connector is disconnected when current is working, the excessive voltage may damage the ignition control module or ECU. Always turn off the ignition switch before servicing.
- A faulty ignition system is often related to poor connections. Check those connections before proceeding.
- Make sure the battery is adequately charged. Using the starter motor with a weak battery can result in a slower engine starting speed as well as no spark at the spark plug.
- Use of spark plug with improper heat range is the main cause of poor engine performance.
- Check the ignition system according to the sequence specified in the Troubleshooting.

SPECIFICATIONS

Item	Standard
Spark plug	CR8E(NGK)
Spark plug gap	0.6~0.7 mm
Ignition coil resistance	0.55~0.75 Ω
CPS resistance	96~144 Ω

TROUBLESHOOTING

LOW PEAK VOLTAGE

- Cranking speed is too low (Battery is lacking of power).
- Poorly connected connectors or an open circuit in the ignition system.
- Faulty ignition-coil.
- Faulty ignition control module.

NO PEAK VOLTAGE

- Short circuit in engine stop switch or ignition switch wire.
- Faulty engine stop switch or ignition switch.
- Loose or poorly connected ignition control module connectors.
- Open circuit or poor connection in ground wire of the ignition control module.
- Faulty ignition pulse generator.
- Faulty ignition control module.

PEAK VOLTAGE IS NORMAL, BUT NO SPARK JUMPS AT THE PLUG

- Faulty spark plug or leaking ignition coil secondary current.
- Faulty ignition coil.

IGNITION COIL

REMOVAL

Remove the body covers.
 Disconnect the spark plug cap from the spark plug.
 Disconnect the ignition coil primary connector.
 Remove the bolt and the ignition coil.

Ignition Coil

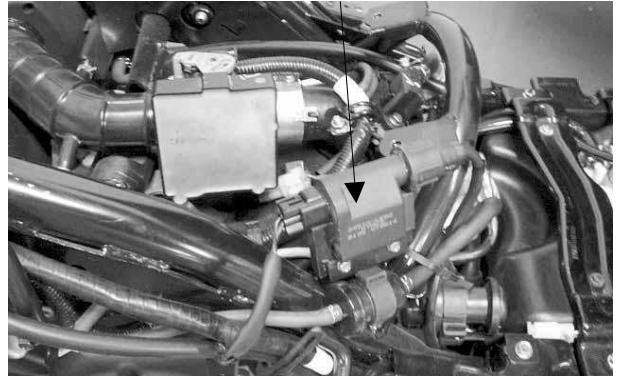

INSPECTION

Measure the resistance of ignition primary coil.

Standard: 0.55~0.75 Ω /20°C

Ignition Primary Coil

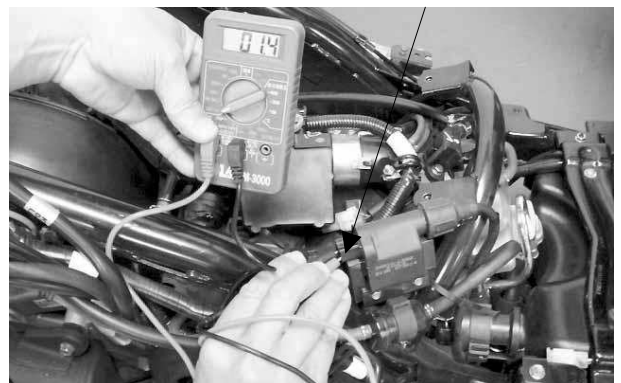

AC GENERATOR

CPS



The test is served under engine working.

Remove the body covers.
 Disconnect the ignition pulse generator connector.
 Measure the ignition pulse generator resistance between the Green/White wire and Blue/Yellow wire.

Standard: 96~144 Ω



15. IGNITION SYSTEM

TILT SWITCH

Use DC 8-16V Battery power, it is with 3 pins: one power pin, one signal output pin and one earthing pin. When vehicle tilted to more than 65 deg. The signal line will be earthed so that ECU can tell that the vehicle is tilting and further cut fuel supply and ignition. When the vehicle is reset up, it shall go through Key Off and Key On to return to normal status. It is comprised of Hall Effect with output voltage range of 0-14V.

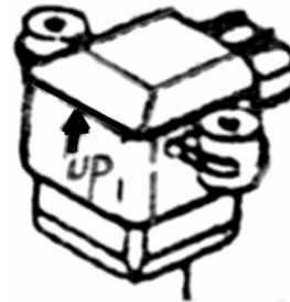

Modes of Trouble

The motor starter can keep function. But ECU is out of function so that engine can't start includes fuel pump and injector lose function, spark plug no sparking.

Even if the scooter fall down, the engine is still running.

Cause

- Broken lead wire
- Short circuit
- Install angle incorrect

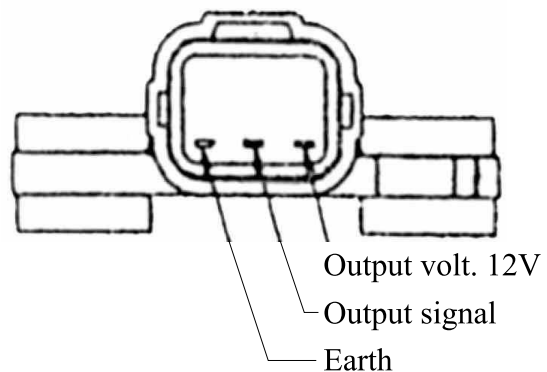

15. IGNITION SYSTEM

Use DC 8-16V Battery power, it is with 3 pins: one power pin, one signal output pin and one earthing pin. When vehicle tilted to more than 65 deg. The signal line will be earthed so that ECU can tell that the vehicle is tilting and further cut fuel supply and ignition. When the vehicle is reset up, it shall go through Key Off and Key On to return to normal status. When voltage is over 3.5V, it means the vehicle won't be fell down. When voltage is less than 1.4V, the vehicle should be fell down.

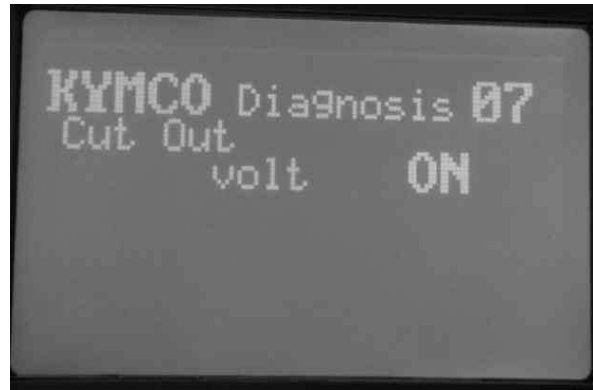

Normal range: 3.5 ~ 4.7V

TILT SWITCH REMOVAL

Remove the front cover.
Remove the bolts and Tilt switch.



Bolts

Tilt Switch

VOLTAGE MEASURE

* This purpose is that inspect the input/output voltage if normal.

Connect the multimeter (+) probe to the violet/red wire and the multimeter (-) probe to the green wire to measure the voltage.

Standard:

Input voltage: 4 ~ 6 V

Fall down is over 65°: 3.5 ~ 4.4V



* Make sure that battery is in good condition before performing this measurement.



16. STARTING SYSTEM

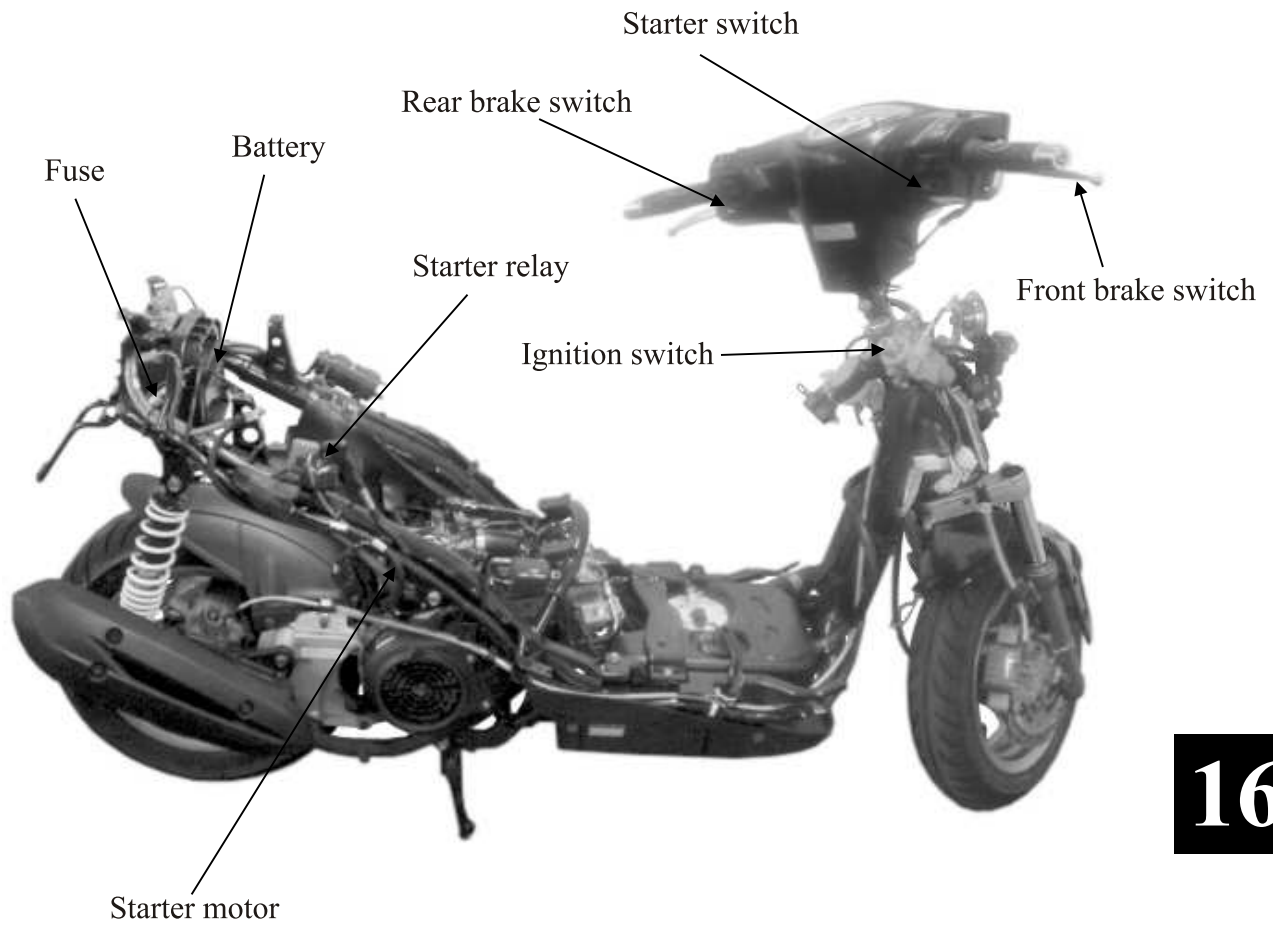

16

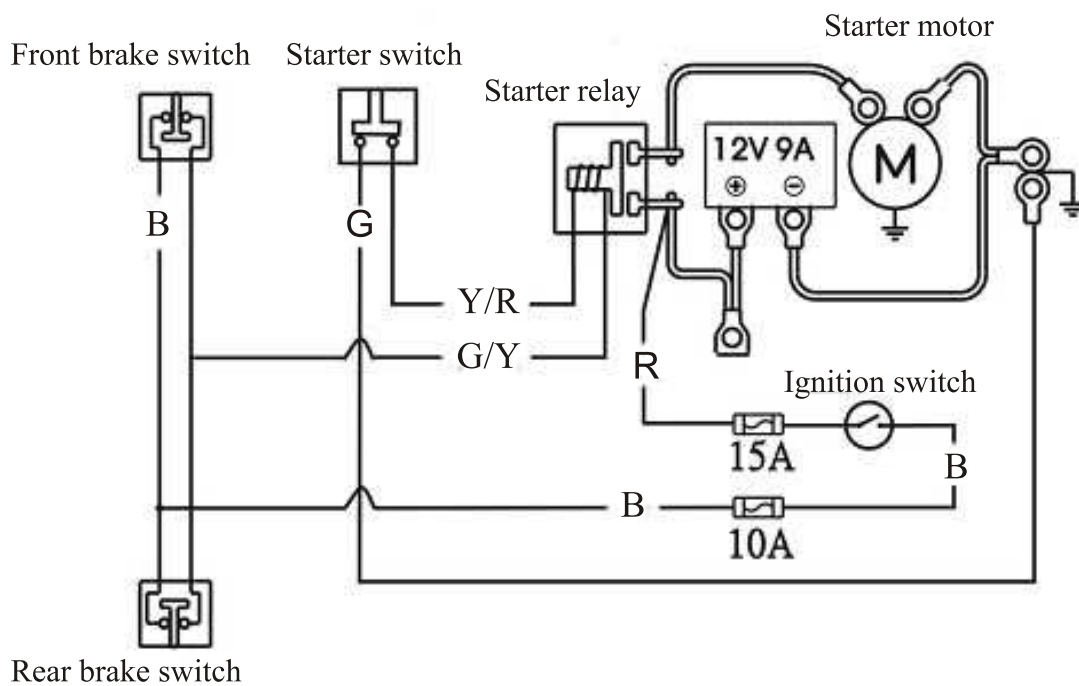

16. STARTING SYSTEM

SERVICE INFORMATION	16-1	STARTER RELAY	16-2
TROUBLESHOOTING	16-1	STARTER CLUTCH	16-3
STARTER MOTOR	16-2		

SERVICE INFORMATION

GENERAL INSTRUCTIONS

The removal of starter motor can be accomplished with the engine installed.
For the starter clutch removal, refer to chapter 4.

SPECIAL TOOL

Starter clutch lock nut wrench	E009
Universal holder	E017

TROUBLESHOOTING

Starter motor won't turn

- Fuse burned out
- Weak battery
- Faulty ignition switch
- Faulty starter clutch
- Faulty front or rear stop switch
- Faulty starter relay
- Poorly connected, broken or shorted wire
- Faulty starter motor

Lack of power

- Weak battery
- Loose wire or connection
- Foreign matter stuck in starter motor or gear

Starter motor rotates but engine does not start

- Faulty starter clutch
- Starter motor rotates reversely
- Weak battery

16. STARTING SYSTEM

STARTER MOTOR

REMOVAL

* Before removing the starter motor, turn the ignition switch OFF and remove the battery earth cable.
Turn on the ignition switch and push the starter switch to see if the starter motor operates properly.

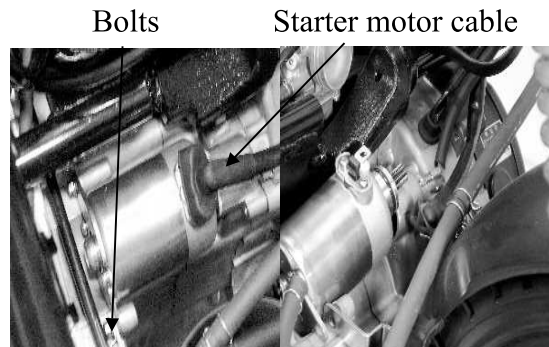

Remove the starter motor cable. Remove the two starter motor mounting bolts and the motor starter.

Remove the waterproof rubber jacket and disconnect the starter motor cable connector.

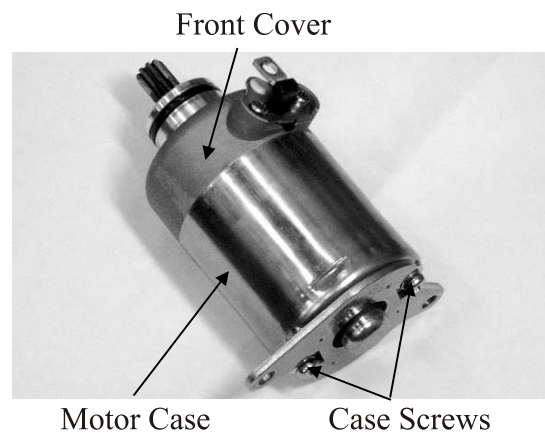

STARTER RELAY

PERFORMANCE INSPECTION

Remove the body cover.

Turn the ignition switch ON and the starter relay is normal if you hear a click when the starter button is depressed.

If no click sound:

1. Inspect the starter relay voltage
2. Inspect the starter relay earth circuit
3. Inspect the starter relay operation

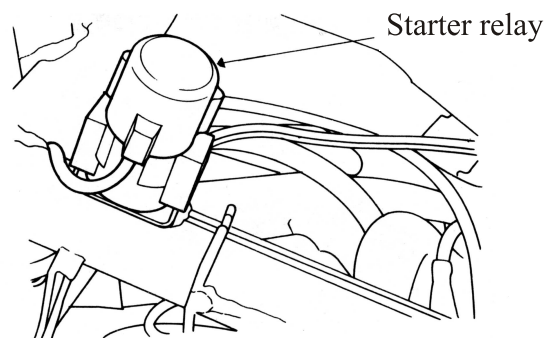

VOLT. INSPECTION

Place the motorcycle on its main stand.

Measure the voltage between the starter relay connector green/yellow wire and engine ground.

Turn the ignition switch ON and the battery voltage should be normal when the brake lever is fully applied.

If the battery has no voltage, inspect the brake lamp switch continuity and cable.

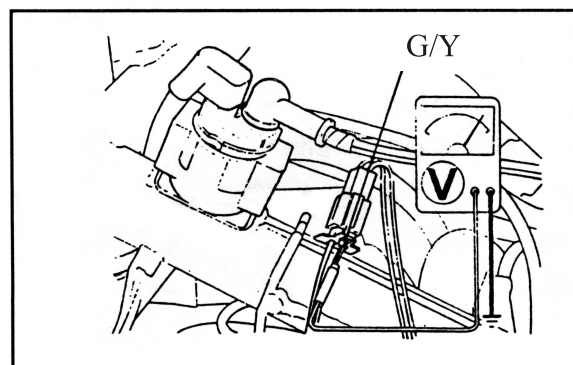

STARTER RELAY GROUND CIRCUIT INSPECTION

Disconnect the starter relay wire connector.
Check for continuity between the yellow/red wire terminal and ground.
There should be continuity when the starter button is depressed.
If there is no continuity, check the starter button for continuity and inspect the wire.

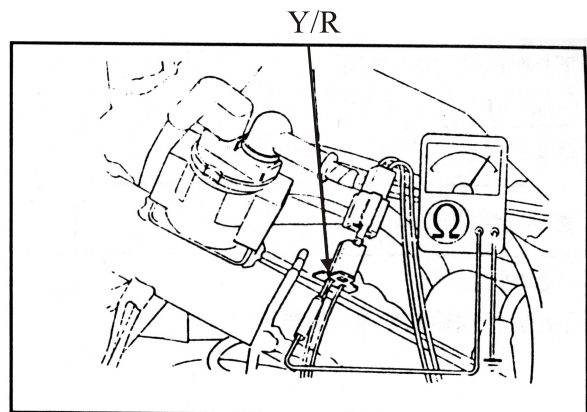

PERFORMANCE INSPECTION

Connect the electric tester to the starter relay larger terminals that connect to the battery positive cable and the starter motor cable.
Connect a fully charged battery across the starter relay yellow/red and green/yellow wire terminals.
Check for continuity between the starter relay large terminals. The relay is normal if there is continuity.

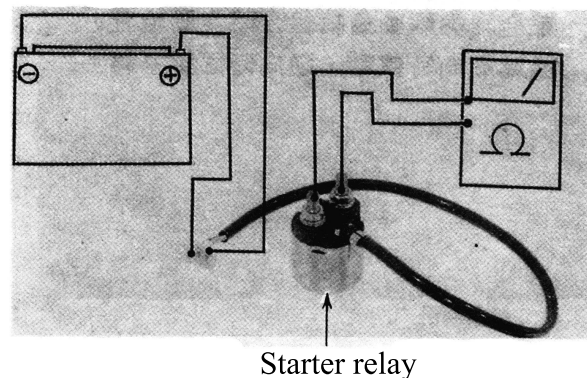

INSTALLATION

Connect the starter motor cable connector and properly install the waterproof rubber jacket.
Check the O-ring for wear or damage and replace if necessary.
Apply grease to the O-ring and install the starter motor.
Tighten the two mounting bolts.

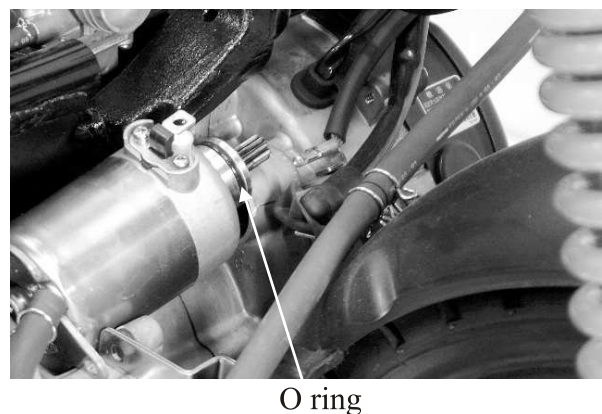

STARTER CLUTCH

REMOVAL

Remove the A.C. generator.
Remove the right crankcase cover.



16. STARTING SYSTEM

Remove the starter clutch lock nut.

Special

Starter clutch lock nut wrench E009
 Universal holder E017

* The lock nut is left threaded.

Remove the starter clutch.
 Remove the starter idle gear and shaft.

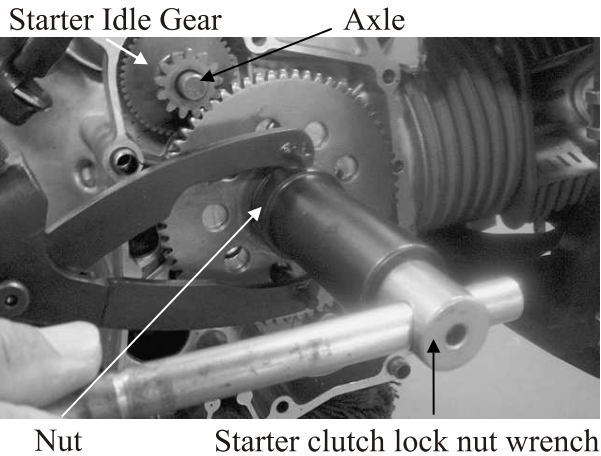

INSPECTION

Inspect the operation of the starter drive gear when it is assembled on the clutch. The starter drive gear should turn clockwise freely and should not turn counterclockwise.



STARTER CLUTCH DISASSEMBLY

Inspect the starter drive gear for wear or damage and replace if necessary.
 Measure the starter drive gear I.D.

Service Limit: 32.06 mm replace if over

Inspect the needle bearing for wear or damage and replace if necessary.

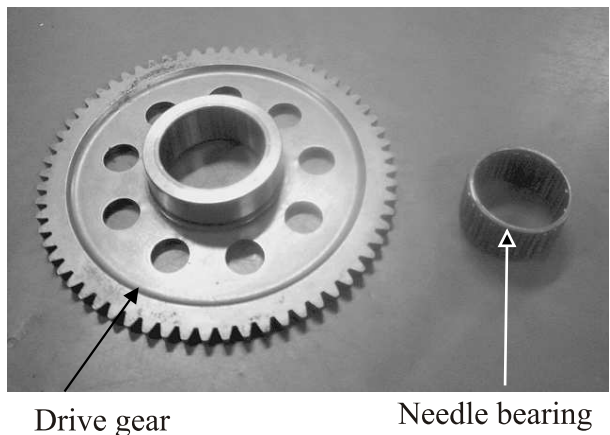

CLUTCH BODY DISASSEMBLY

Remove the rollers, plungers and springs from the clutch body.
 Inspect the clutch body for wear or damage and replace if necessary.
 Inspect each roller and plunger for wear or damage and check for weak spring. Replace a new set if necessary.

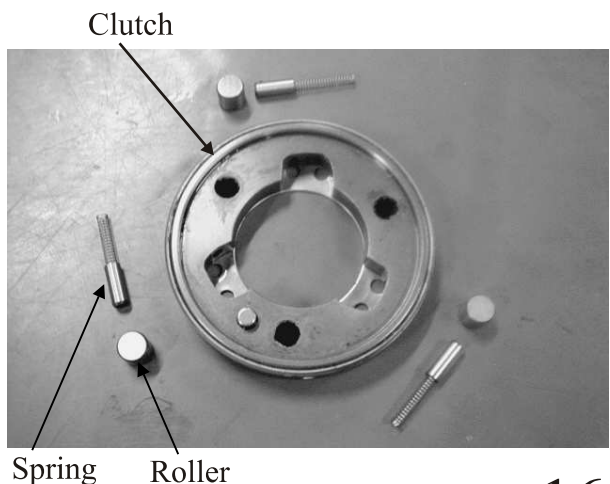

16. STARTING SYSTEM

Measure the clutch cover O.D.

Service Limit: 27.94 mm replace if over

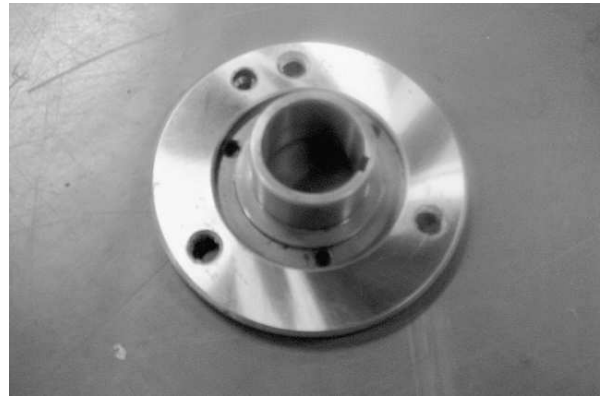

Measure the starter idle gear I.D.

Service Limit: 10.05 mm replace if over

Measure the starter idle gear shaft O.D.

Service Limit: 9.94 mm replace if below

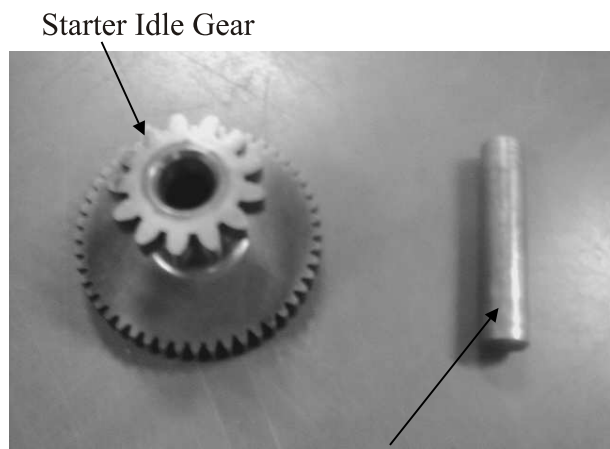

Idle Gear Shaft

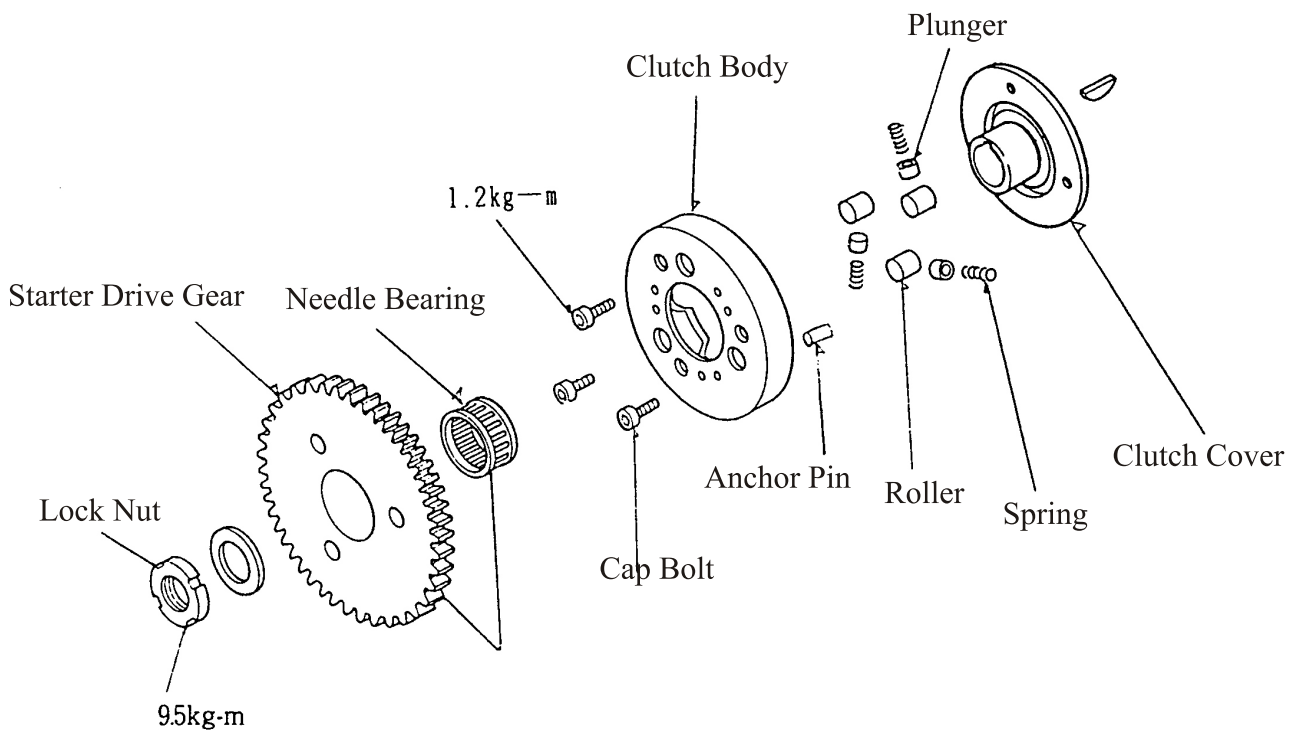

16. STARTING SYSTEM

Install the springs, plungers and rollers onto the clutch body.

Install the clutch cover by aligning the clutch cover anchor pin with the hole in the clutch body. Apply locking agent to the threads of the clutch cover bolts and tighten them.

Torque: 1.2 kg-m

Apply engine oil to the needle bearing and starter drive gear and then install them to the clutch body.

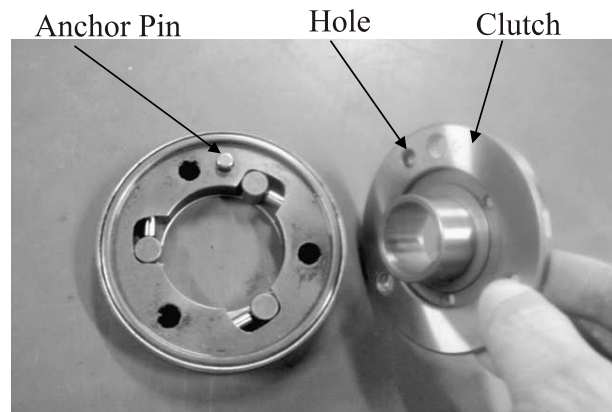

Install the starter clutch onto the crankshaft.

Apply engine oil to the starter idle gear and shaft and then install them.

Hold the starter drive gear with the universal holder and tighten the starter clutch lock nut.

Torque: 9.5 kg-m

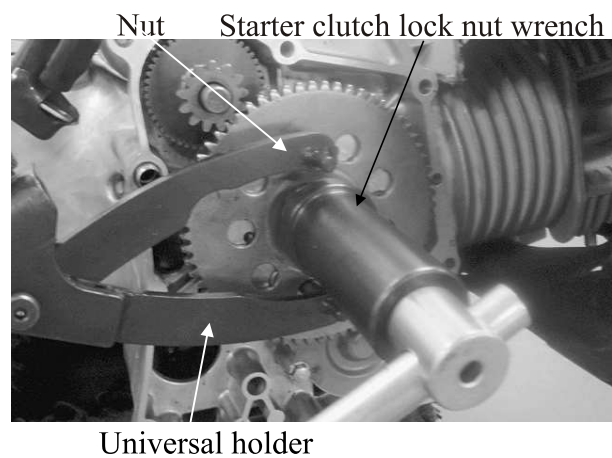

Special

Starter clutch lock nut wrench	E009
Universal holder	E017

* The lock nut is left threaded.

Install the right crankcase cover.

Install the left crankcase cover.

17. LIGHT/INSTRUMENT/SWITCH

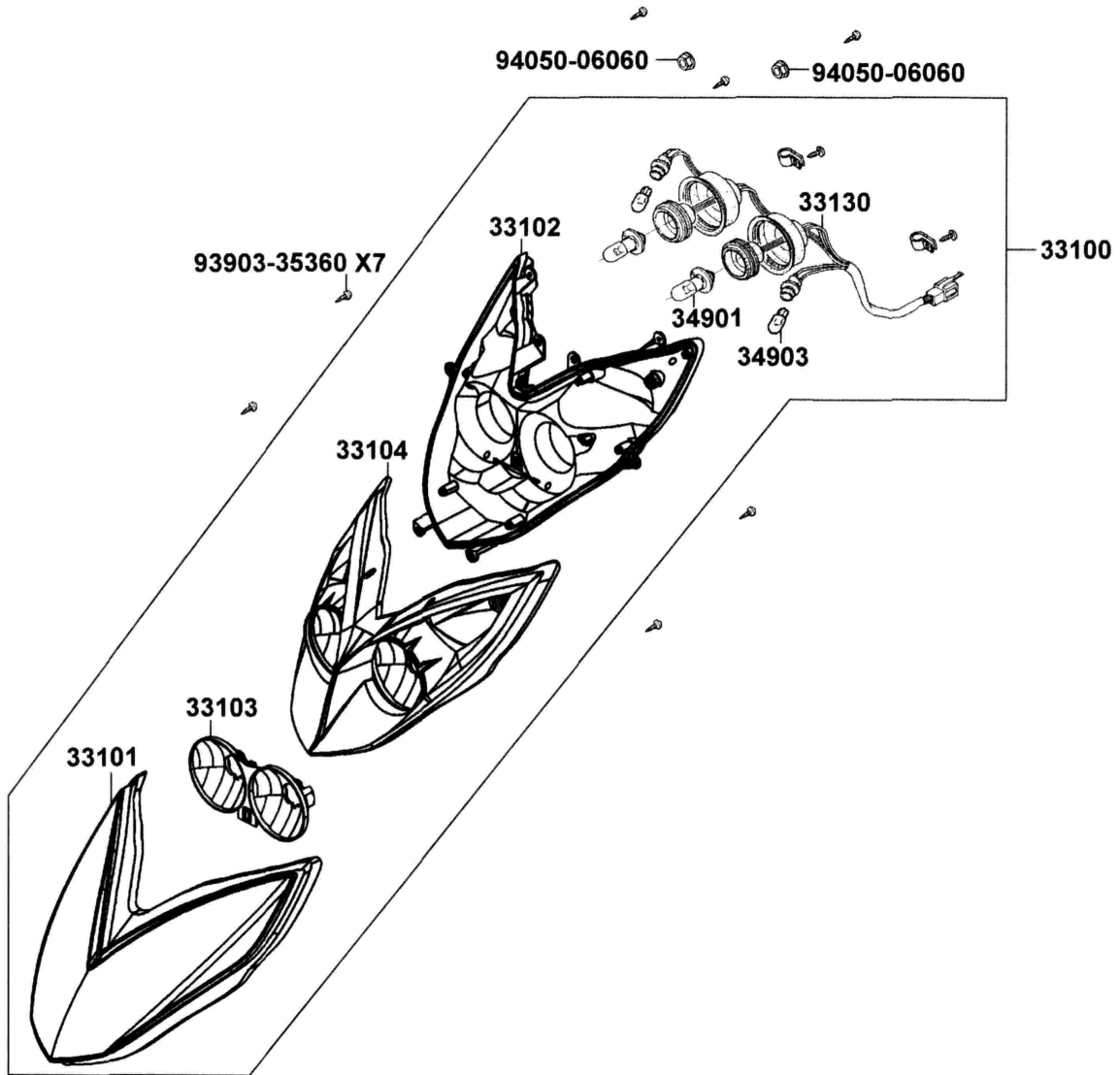

17

17. LIGHT/INSTRUMENT/SWITCH

SERVICE INFORMATION	17-0	IGNITION SWITCH	17-3
TROUBLESHOOTING	17-0	SWITCH	17-3
HEADLAMP	17-1	FUEL UNIT	17-5
TAILLAMP/BRAKE LAMP	17-1	SPEEDOMETER	17-6

SERVICE INFORMATION

GENERAL INSTRUCTIONS

An multimeter is needed to measure or test the electric equipment.

Be sure to use fuses and bulbs of the same specifications to avoid damage of electrical equipment.

After installation of each switch, a continuity check must be performed. A continuity check can usually be made without removing the part from the motorcycle.

TROUBLESHOOTING

Lights do not come on when ignition switch is "ON"

- Burned bulb
- Faulty switch
- Broken wire
- Fuse burned out
- Weak battery
- Poorly connected or shorted wire
- Faulty winker

Light dims

- Faulty ignition coil
- Wire or switch resistance too high
- Faulty regulator/rectifier

Headlight does not change when dimmer switch is turn to Hi or Lo

- Faulty or burned bulb
- Faulty dimmer switch

Fuel gauge pointer does not register correctly

- Disconnected wire or connector
- Broken wire
- Faulty float
- Faulty fuel unit
- Faulty instrument

Fuel gauge pointer fluctuates or swings

- Loose wire connection
- Faulty fuel unit
- Faulty instrument

17. LIGHT/INSTRUMEN/SWITCH

HEADLAMP

BULB REPLACEMENT

Remove the front center cover.
 Remove the front cover.
 Remove the headlamp.
 The installation sequence is the reverse of removal.

* After installation, adjust the headlight beam.

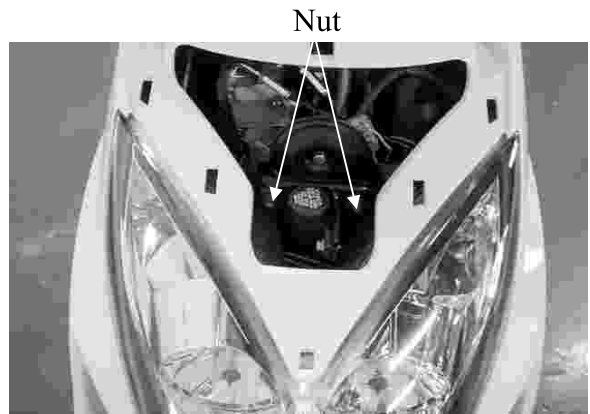

Remove the front cover.
 Remove seven bolts attaching to the headlight unit.
 Remove the headlight unit.

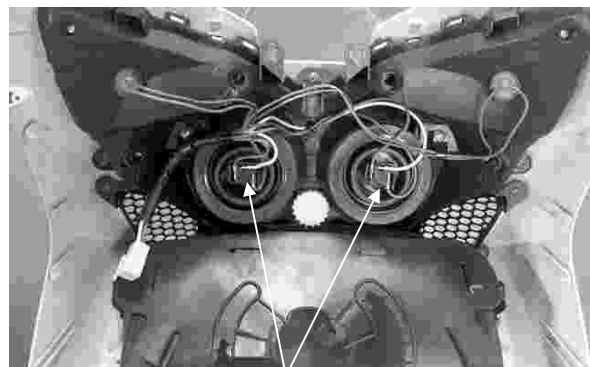

TAILLAMP/BRAKE LAMP/ REAR WINKER LAMP/ LICEANCE LAMP

Remove the body covers and taillight unit.
 Replace a new bulb.

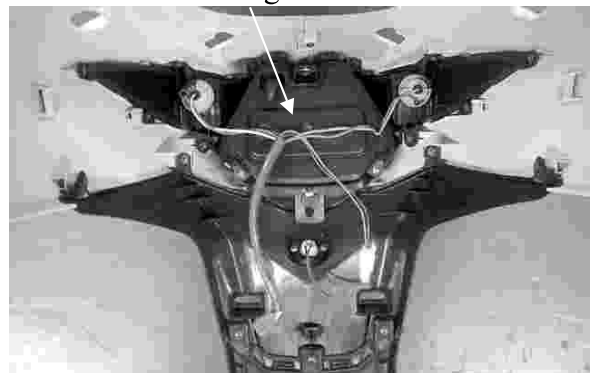

The installation sequence is the reverse of removal.



17. LIGHT/INSTRUMENT/SWITCH

IGNITION SWITCH

INSPECTION

Remove the front cover.
 Disconnect the ignition switch wire coupler.
 Check for continuity between the wire terminals.

Color	Red	Black	IG	Green
OFF			○—○	○—○
ON	○—○			
LOCK			○—○	○—○

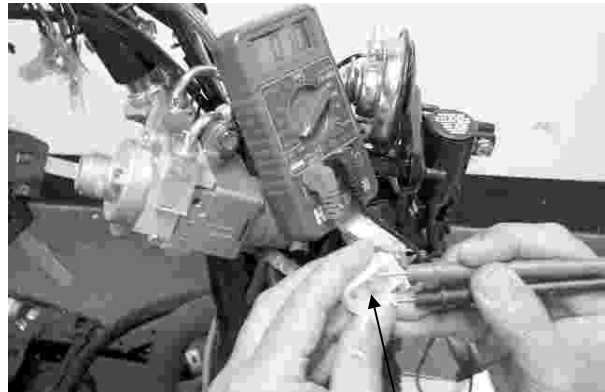

Ignition Switch Coupler

REPLACEMENT

Remove the two mounting bolts to remove the ignition switch holder.
 Remove the two screws to remove the ignition switch for replacement.

Bolts

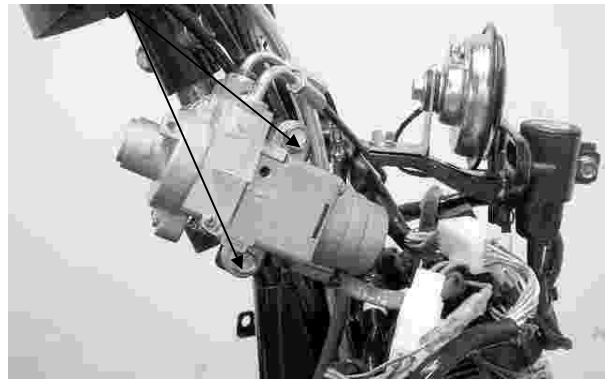

ENGINE STOP SWITCH

INSPECTION

Remove the front/rear handlebar cover.
 Remove the engine stop switch coupler.
 Check for continuity between the wire terminals.

Color	Black/ Blue(1)	Black/ Blue(2)
⊗		
⊙	○—○	○—○

Engine Stop Switch

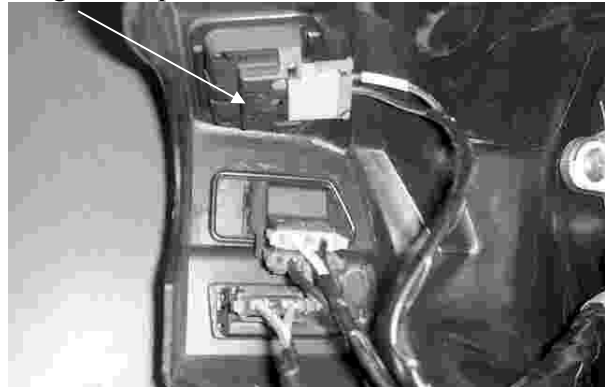

HEADLIGHT SWITCH

INSPECTION

Remove the front/rear cover.
 Disconnect the headlight switch wire coupler.
 Check for continuity between the wire terminals.

Headlight switch

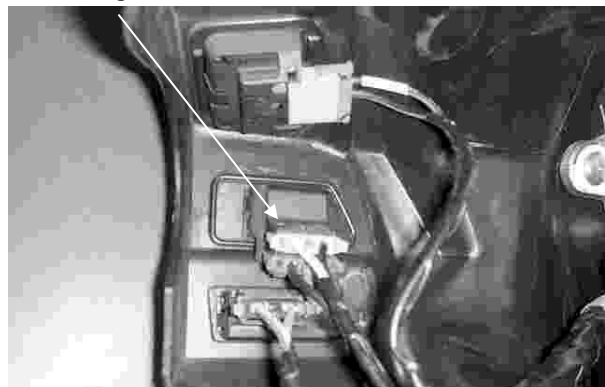

Color	White/ Blue	black	Brown	Brown
•				
≡DC≡	○—○	○—○	○—○	
☀		○—○	○—○	○—○

17. LIGHT/INSTRUMENT/SWITCH

STARTER SWITCH

Color	Yellow/red	Green
Free		
Push		

Starter Switch



Y/R G

HORN SWITCH

Color	Light green	Black
Free		
Push		

Horn Switch



LG B

TURN SIGNAL SWITCH

Color	Light blue	Orange	Gray
R			
N			
L			

Turn Signal Switch

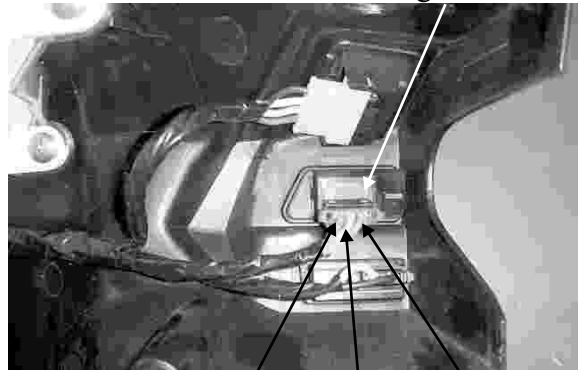

O LB GR

DIMMER/PASSING SWITCH

Color	White/Blue	Blue	White	Black
PASS				

Dimmer Switch

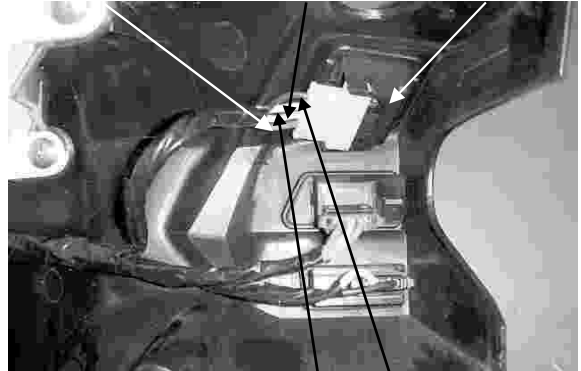

W/L L

17. LIGHT/INSTRUMENT/SWITCH

STOP SWITCH

INSPECTION

Remove the handlebar front cover.
 Disconnect the front stop switch wire coupler.
 Check for continuity between the wire terminals when the front brake lever is applied. The switch is normal if there is continuity.

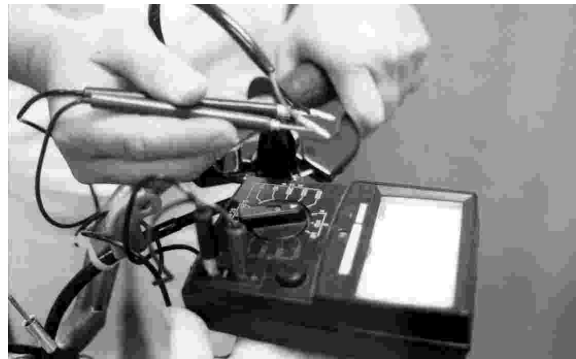

Horn

INSPECTION

Remove the front covers.
 Disconnect the horn wire coupler.
 The horn is normal if it sounds when a 12V battery is connected across the horn wire terminals.

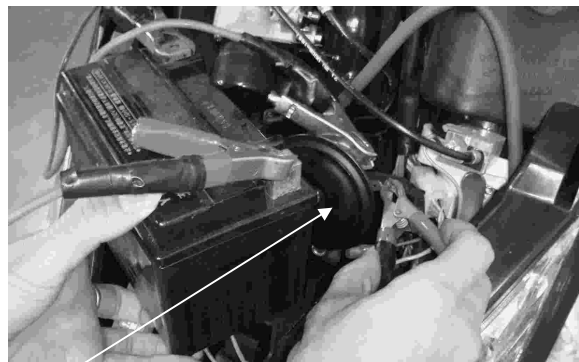

Horn

FUEL GAUGE

INSPECTION

Remove the right body cover.
 Remove the fuel float and move it up and down.
 Turn the ignition switch to the ON position.
 The LCD cell flashes from E to F when upward the float, otherwise the LCD flashed from F TO E when downward the float.



FUEL UNIT

REMOVAL

Remove the center luggage box.
 Remove the body covers.
 Remove the footboard.
 Disconnect the fuel unit wire connector.
 Remove the fuel unit plate.

* Be careful not to bend or damage the fuel unit float arm.



Fuel Unit Coupler

17. LIGHT/INSTRUMENT/SWITCH

INSPECTION

Measure the resistance between the fuel unit wire terminals with the float at upper and lower positions.

Color \ Float	Upper	Lower
Y/W~L/W	1000~1100	100~110

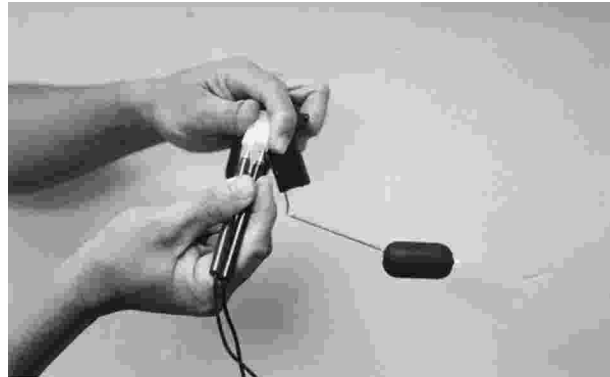

The installation sequence is the reverse of removal.

* Install the fuel unit by aligning the groove on the fuel unit with the tab on the fuel tank.

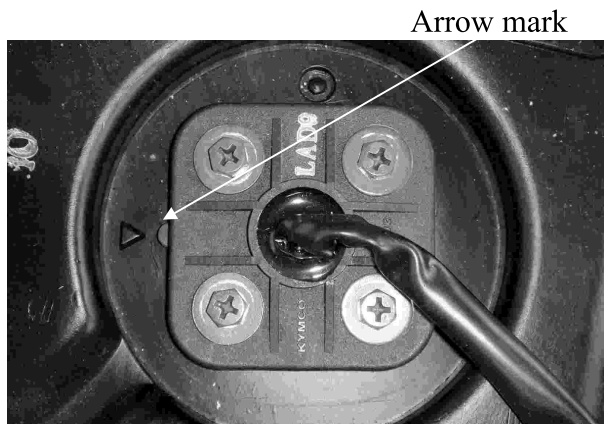

SPEEDOMETER

BULB REPLACEMENT

Remove the handlebar rear cover.
Disconnect the right and left handlebar switches wire couplers.

The installation sequence is the reverse of removal.

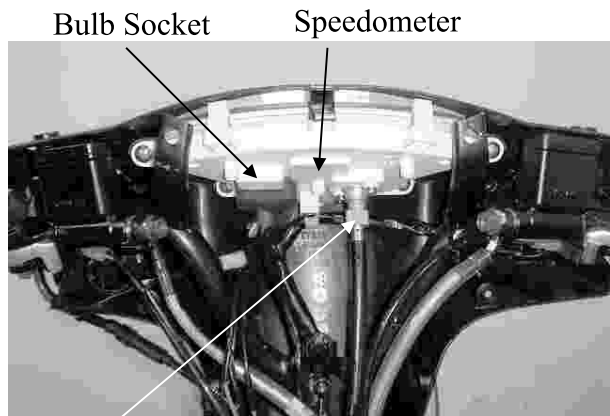

Speedometer cable

Handlebar Switch

Handlebar Switch

SPEEDOMETER REPLACEMENT

Remove the front/rear handle cover.
Remove the handlebar left/right switch socket.
Disconnect the speedometer cable.
Remove the instrument bulb sockets
Disconnect the three fuel gauge wires.
Remove the instrument wire clamp screw.



Speedometer wires

17. LIGHT/INSTRUMENT/SWITCH

Remove four screws attaching the instruments to the handlebar rear cover.
Remove the instruments.

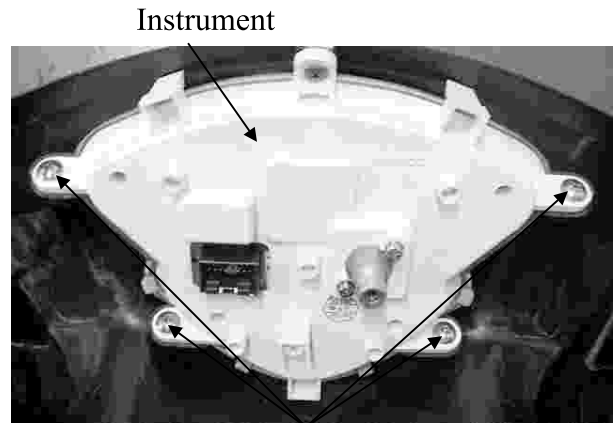

Screws

INSTALLATION

The installation sequence is the reverse of removal.

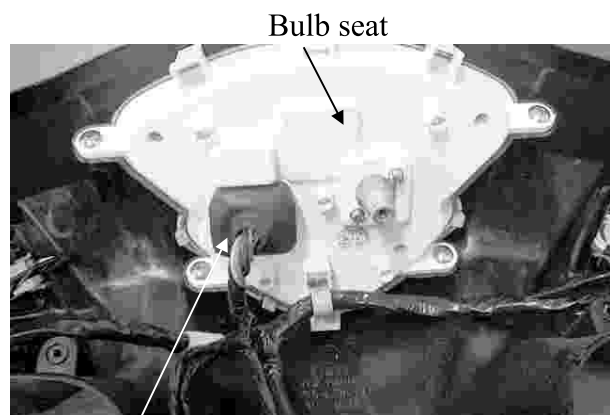

EVAPORATIVE - EMISSION CONTROL SYSTEM

SCHEMATIC DRAWING	18- 1
EVAPORATIVE CONTROL SYSTEM	18- 2
TROUBLESHOOTING.....	18- 2
SERVICE INFORMATION	18- 3
PERGE CONTROL VALVE	18- 4
P.C.V. (BLOW BY).....	18- 5
CHARCOAL CANISTER	18- 6
EMISSION CONTROL SYSTEM.....	18- 7
TROUBLESHOOTING.....	18- 8
SECONDARY AIR CLEANER / A.I.C.V.....	18- 9
REED VALVE.....	18-10

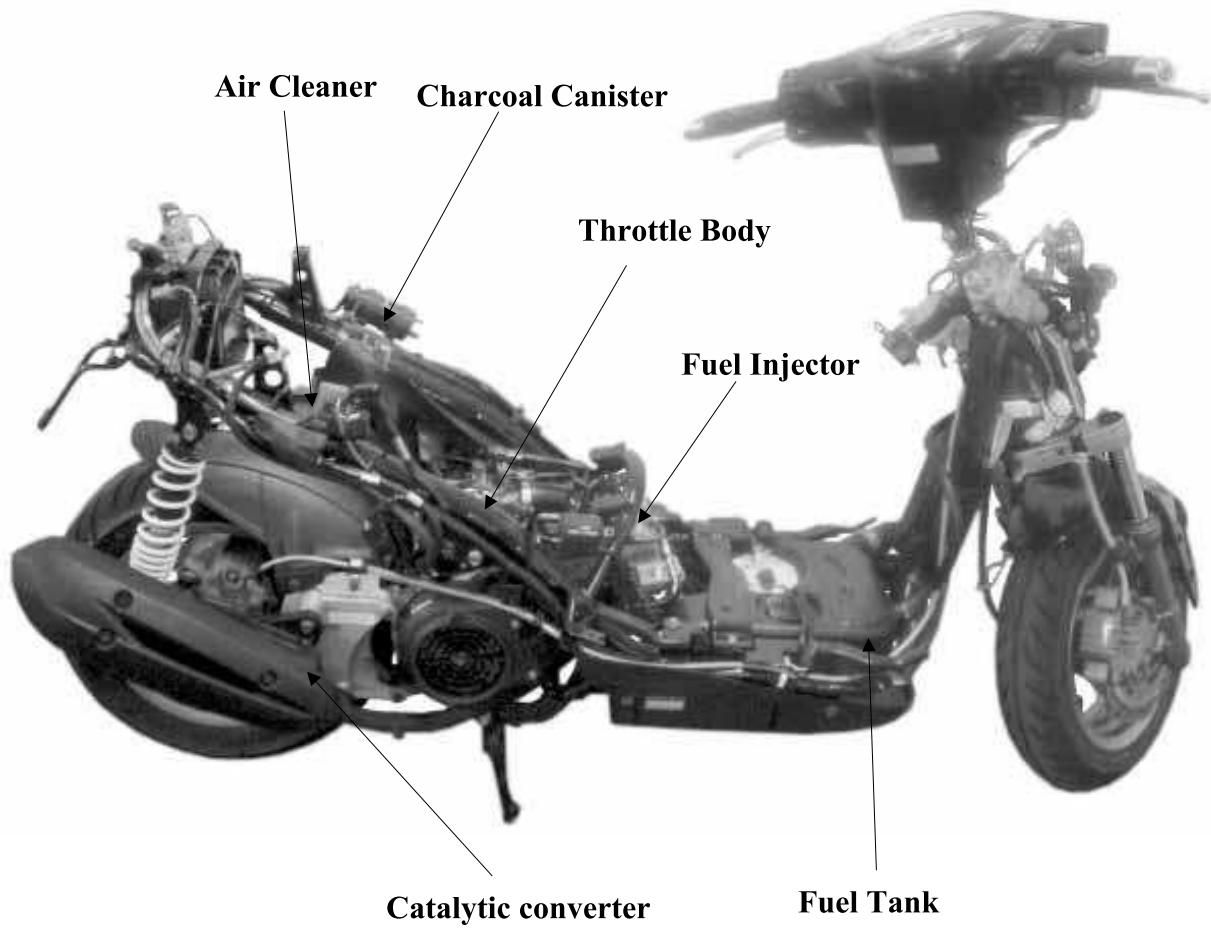
18. EVAPORATIVE / EMISSION CONTROL SYSTEM**SCHEMATIC DRAWING**

EVAPORATIVE EMISSION CONTROL SYSTEM FUNCTION
FOREWORD:

The Evaporative Emission Control System is abbreviated to E.E.C. System. This device collects the fuel vapor from the fuel tank and then the fuel vapor is drawn into the engine for re-burning to avoid air pollution caused by the fuel vapor diffused into the air.

FUNCTION

Item	Purpose	Function
Purge Control Valve	Control vaporized HC from fuel tank not to diffuse into the air.	The charcoal canister absorbs vaporized HC from the fuel tank. When the engine is running and the purge control valve is open, the fuel vapor in the charcoal canister is drawn into the engine for re-burning.
Charcoal Canister	Absorb and store the vaporized HC from the fuel tank and carburetor.	The vaporized HC is absorbed in the charcoal canister and the specified volume of HC in the emission should not exceed 2g.
P.C.V. System	Completely recover the HC from blow-by gas in the crankcase for re-burning.	Through the P.C.V. system, the blow-by gas from the crankcase is separated into fuel vapor and fuel and then drawn into the cylinder for re-burning.

TROUBLESHOOTING
Engine loses power or runs erratic at idle speed

1. Clogged P.C.V. system
2. Clogged air cleaner
3. Faulty purge control valve
4. Loose or broken E.E.C. system tubes

Engine idles or accelerates roughly

1. Faulty fuel cut-off valve
2. Faulty purge control valve
3. Clogged or faulty charcoal canister

SERVICE INFORMATION

GENERAL INSTRUCTIONS

- Do not smoke or allow flames or sparks near the working area.
- Note the locations of tubes for proper installation.
- Replace any damaged tube with a new one.
- Make sure to tighten the connector of each tube securely.

TOOLS

- Vacuum pump
- Pressure pump

SPECIFICATIONS

Purge control valve vacuum pressure	45 mm/Hg
Charcoal canister capacity	90 cc

EVAPORATIVE CONTROL SYSTEM

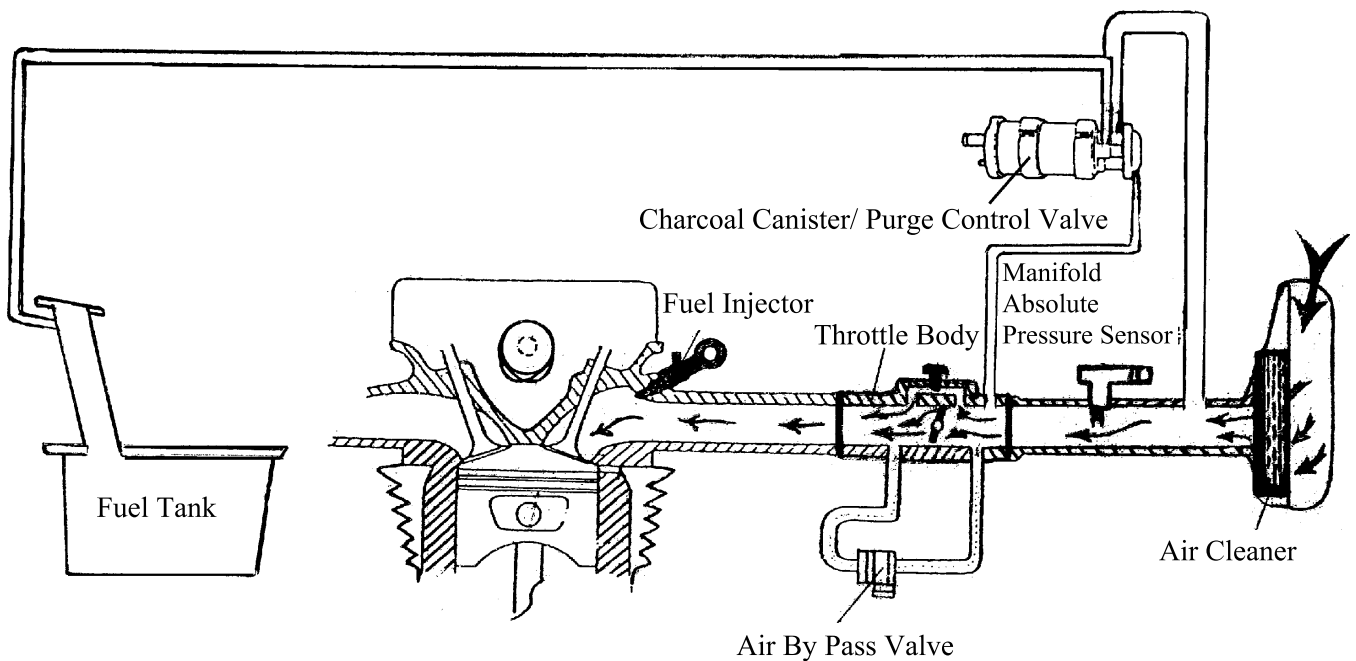

PURGE CONTROL VALVE REMOVAL

1. Remove the body cover.
2. Disconnect the purge control valve vacuum tube that goes to the throttle body and the tubes that go to the air cleaner and charcoal canister. Remove the charcoal canister/purge control valve.

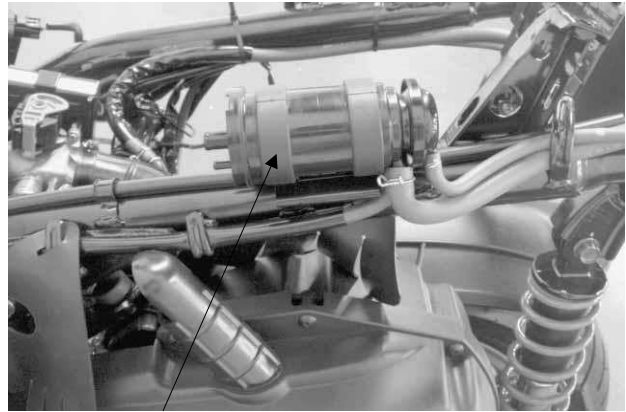

Purge Control Valve

INSPECTION

Connect a vacuum pump to the purge control valve tube that goes to the air cleaner and apply vacuum pressure of 250mm/Hg. The specified vacuum must be maintained for one minute. Replace the purge control valve with a new one if vacuum is not maintained.

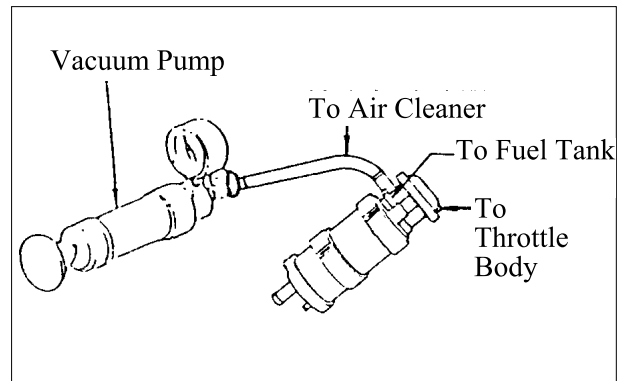

Connect a vacuum pump to the purge control valve tube that goes to the carburetor vacuum tube and apply vacuum pressure of 45mm/Hg. The specified vacuum must be maintained for one minute. Replace the purge control valve with a new one if vacuum is not maintained.

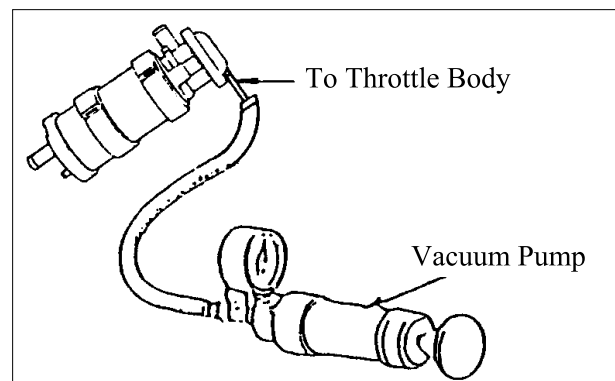

PURGE CONTROL VALVE FLOW INSPECTION

1. Connect a vacuum pump to the purge control valve vacuum tube and apply vacuum pressure of 45mm/Hg.
2. Connect a pressure pump to the tube that goes to the charcoal canister and apply pressure. The flow must be over 9.4 liters per minute and replace the purge control valve with a new one if the specified flow is not reached.

To prevent damage to the purge control valve, do not use high air pressure sources. Use a hand operated pressure pump only.

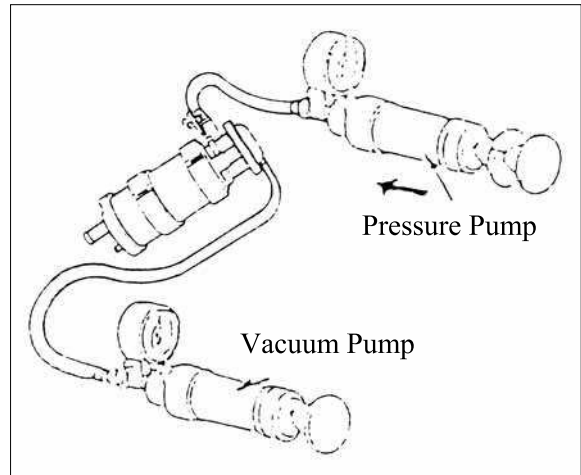

INSTALLATION

1. Install the purge control valve in the reverse order of removal.
2. Route and reconnect the purge control valve tubes properly and securely.

Be careful not to bend, twist or kink the tubes during installation.

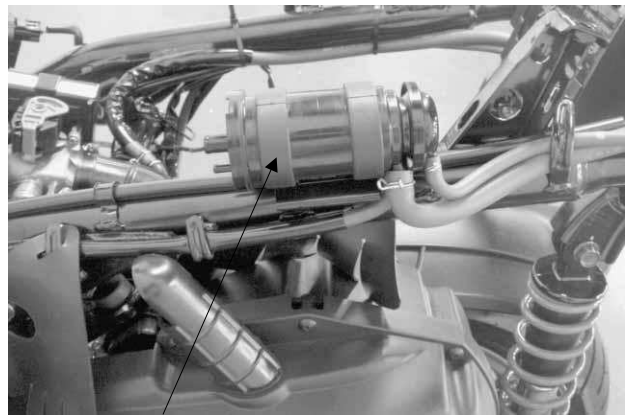

Charcoal Canister/ Purge Control Valve

P.C.V. (CRANKCASE BLOW BY)

REMOVAL

Remove the rear body cover.
 Remove the left body cover.
 Drain out the oil stayed if has any oil inside the tube.



P.C.V

Air Cleaner Cover

CHARCOAL CANISTER

REMOVAL

1. Remove the frame right side cover.
2. Disconnect the charcoal canister tubes that go to the fuel tank and purge control valve.
3. Remove the charcoal canister.

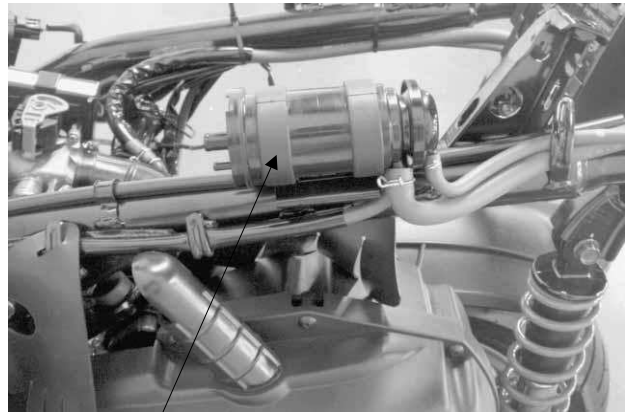

Charcoal Canister/ Purge Control Valve

INSPECTION

1. Plug the tube that goes to the fuel tank and plug the blow-by tube. Then connect a hose to the canister. Blow the hose with mouth. The charcoal canister is normal if air can be blown into it. If clogged, replace it with a new one.
2. Check the charcoal for cracks and replace if necessary.

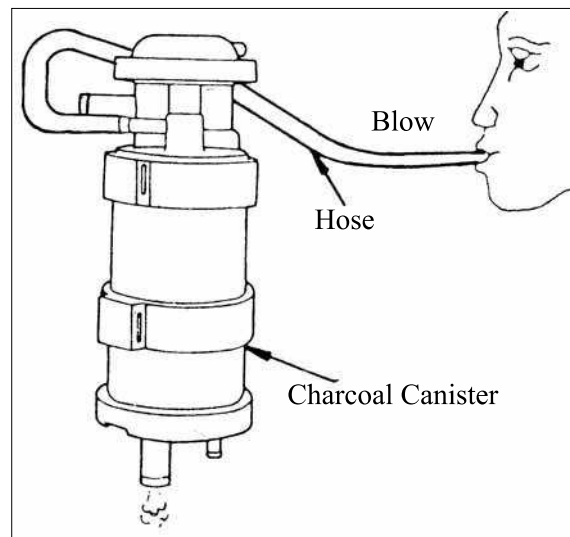

INSTALLATION

Install the charcoal canister in the reverse order of removal.

- The charcoal canister must be installed to its original position to avoid affecting its performance.
- Do not bend, twist or kink the tubes during installation.

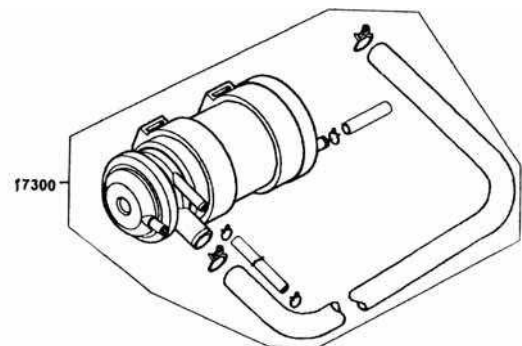

EMISSION CONTROL SYSTEM

The exhaust emission control system adopted in this model utilizes the reed valve to draw secondary air into the exhaust system for re-combustion by means of exhaust pulsation so as to minimize the exhaust emission.

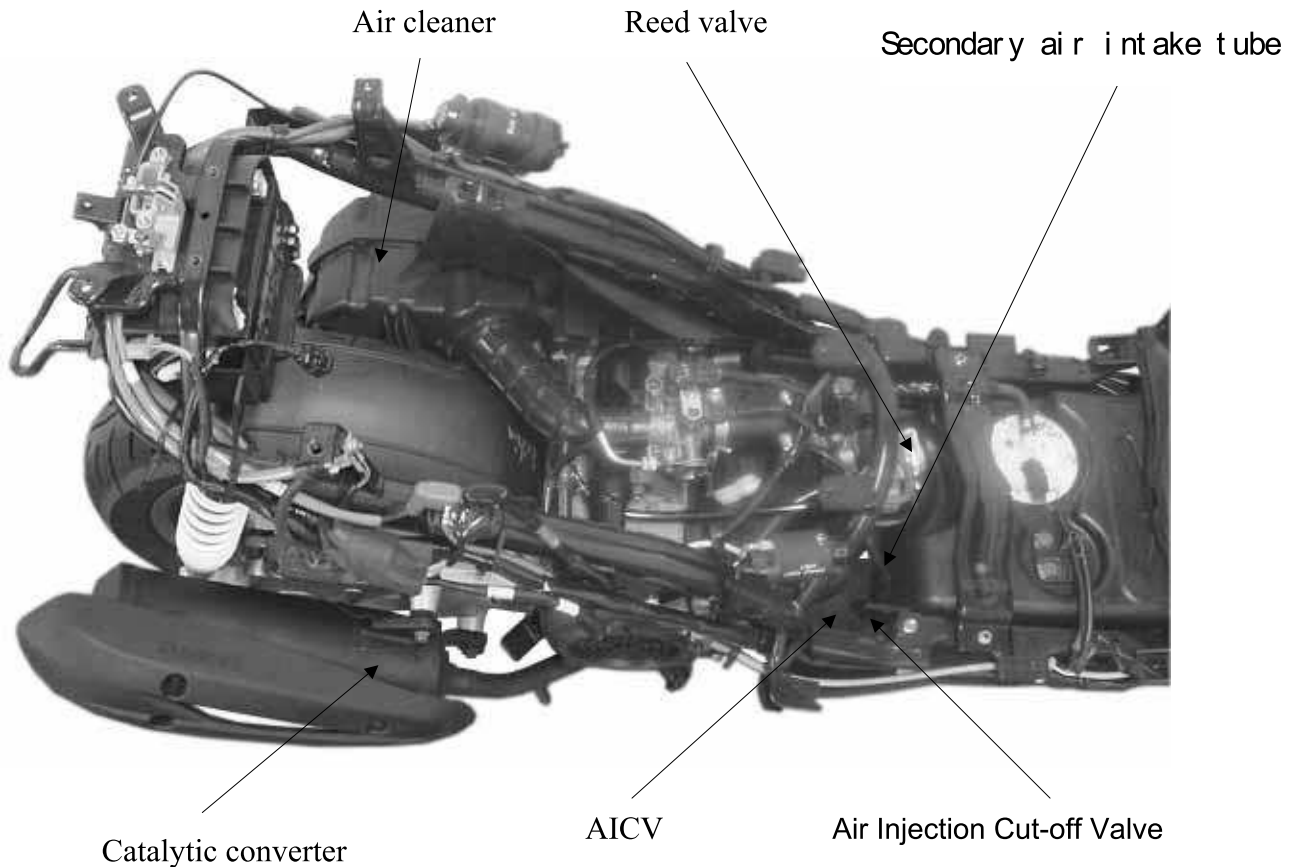

FUNCTION

Item	Purpose	Function
Secondary Air Cleaner	Filter secondary air.	It filters the fresh air drawn for re-burning to prevent dirt or dust from affecting the operation of the air injection cut-off valve.
Air Injection Cut-off Valve	Prevent exhaust muffler noise and backfiring at sudden deceleration.	The air injection cut-off valve usually opens to lead air into the exhaust muffler in which air is re-burned to reduce CO. When the throttle valve closes suddenly, the air injection cut-off valve is actuated by vacuum to close and cut off secondary air in order to prevent exhaust muffler backfiring due to air in the exhaust system.
Reed Valve	Control the secondary air inlet to reduce CO.	When the motorcycle speed is less than 50km per hour, the reed valve operates to draw secondary air into the exhaust system for re-combustion.

18. EVAPORATIVE / EMISSION CONTROL SYSTEM

TROUBLESHOOTING

High CO at idle speed

1. Damaged or clogged reed valve
2. Damaged or clogged air injection cut-off valve
3. Clogged air cleaner

Backfiring at sudden deceleration

1. Damaged reed valve (malfunction)
2. Faulty air injection cut-off valve (unable to close)
3. Carburetor incorrectly adjusted
4. Faulty air cut-off valve
5. Leaking vacuum tube

Exhaust muffler noise

1. Faulty air injection cut-off valve
2. Broken vacuum tube
3. Faulty reed valve

SERVICE INFORMATION

GENERAL INSTRUCTIONS

- During operation, be careful to avoid scalding caused by the exhaust muffler.
- Note the locations of tubes for proper installation.
- Replace any damaged tube with a new one.
- Make sure to tighten the connector of each tube securely

TOOLS

- Vacuum pump

SPECIFICATIONS

Air injection cut-off valve actuating pressure 250mm/Hg 30 liter/min.

Reed valve stopper clearance 4.6mm

18. EVAPORATIVE / EMISSION CONTROL SYSTEM

SECONDARY AIR CLEANER / AIR INJECTION CUT-OFF VALVE (A.I.C.V.)

REMOVAL

- Remove the body cover.
- Remove the side skirt.
- Remove four bolts attaching to the floorboard.

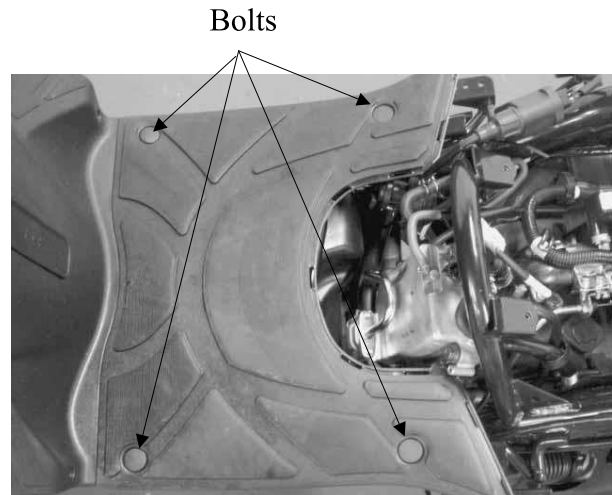

- Disconnect the secondary air cleaner/(A.I.C.V) connecting tube.
- Remove the secondary air cleaner.

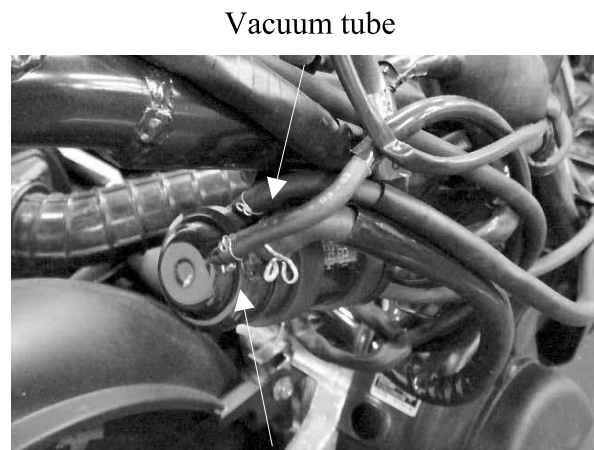

Secondary Air Cleaner

INSPECTION

Inspect the air injection cut-off valve flow using a vacuum pump. If the flow is not within the specified values, replace with a new one. The flow should be at least 30 liter/min when a vacuum of 250mm/Hg is applied. The flow should be at least 1.6 liter/min when a vacuum of 320mm/Hg is applied. Check each connecting tube for cracks or damage and replace if necessary.

- The secondary air cleaner must be assembled and installed properly to avoid dust entering the air cleaner.
- When installing, be careful not to bend or twist the tubes and check for proper installation.
- The tube length is very important to its performance, use the tube of same specification for replacement.

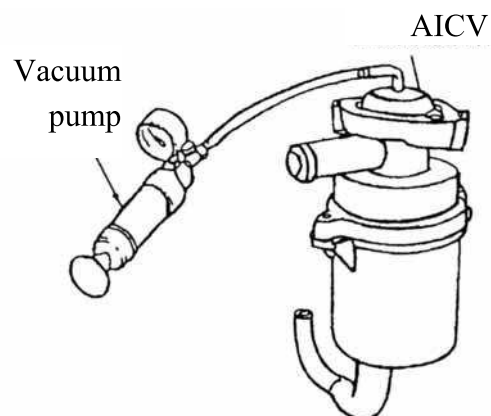

REED VALVE

REMOVAL

Remove the frame center cover.

Disconnect the secondary air inlet tube connector.

Remove the reed valve cover and two secondary air outlet tube nuts.

Secondary air inlet tube

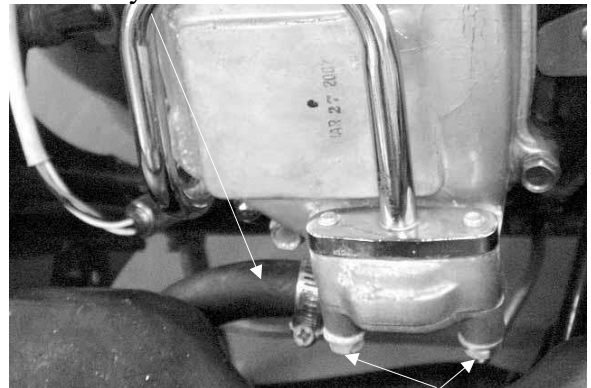

Bolts

INSPECTION

Check the reed valve for cracks, damage, big clearance or weak reeds. Replace if necessary.

Check the gasket and O-ring for damage or deterioration and replace if necessary.

Reed valve stopper clearance: 4.6 mm

Bolt

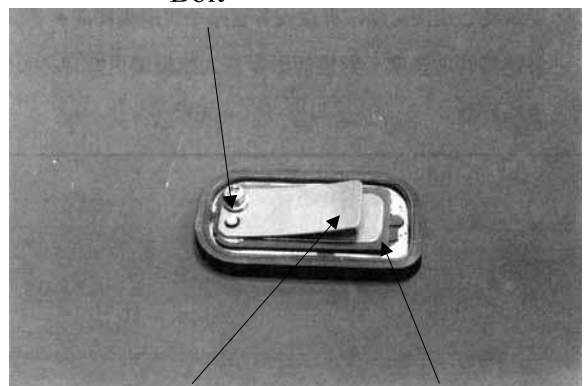

Reed Valve stopper

Reed Valve