

## PREFACE

This Service Manual describes the technical features and servicing procedures for the KYMCO Super9 50.

Section 1 contains the precautions for all operations stated in this manual. Read them carefully before any operation is started.

Section 2 is the removal/installation procedures for the frame covers which are subject to higher removal/installation frequency during maintenance and servicing operations.

Section 3 describes the inspection/adjustment procedures, safety rules and service information for each part, starting from periodic maintenance.

Sections 5 through 12 give instructions for disassembly, assembly and adjustment of engine parts. Section 13 is the removal/installation of chassis. Section 15 states the testing and measuring methods of electrical equipment.

Most sections start with an assembly or system illustration and troubleshooting for the section. The subsequent pages give detailed procedures for the section.

The information and contents included in this manual may be different from the motorcycle in case specifications are changed.

## TABLE OF CONTENTS

ENGINE	GENERAL INFORMATION	1
	EXHAUST MUFFLER/FRAME COVERS	2
	INSPECTION/ADJUSTMENT	3
	LUBRICATION SYSTEM	4
	ENGINE REMOVAL/INSTALLATION	5
	CYLINDER HEAD/CYLINDER/PISTON	6
	KICK STARTER/DRIVE PULLEY/CLUTCH/DRIVEN PULLEY	7
	FINAL REDUCTION	8
	A.C. GENERATOR	9
	CRANKCASE/CRANKSHAFT	10
	COOLING SYSTEM	11
	CARBURETOR	12
CHASSIS	STEERING HANDLEBAR/FRONT WHEEL/FRONT BRAKE/FRONT SHOCK ABSORBER/FRONT FORK	13
	REAR BRAKE/REAR FORK/REAR WHEEL/REAR SHOCK ABSORBER	14
ELECTRICAL EQUIPMENT	ELECTRICAL EQUIPMENT	15
	INSTRUMENT/SWITCHES/LIGHTS	16
E/M	EVAPORATIVE/EXHAUST EMISSION CONTROL SYSTEM	17

**KWANG YANG MOTOR CO., LTD.**  
**OVERSEAS SALES DEPARTMENT**  
**OVERSEAS SERVICE SECTION**

# 1. GENERAL INFORMATION

---

**1**

---

## GENERAL INFORMATION

---

ENGINE SERIAL NUMBER -----	1- 1
SPECIFICATIONS -----	1- 2
SERVICE PRECAUTIONS -----	1- 4
TORQUE VALUES -----	1-14
SPECIAL TOOLS -----	1-15
LUBRICATION POINTS -----	1-16
WIRING DIAGRAM-----	1-22
TROUBLESHOOTING-----	1-24

# 1. GENERAL INFORMATION

## ENGINE SERIAL NUMBER

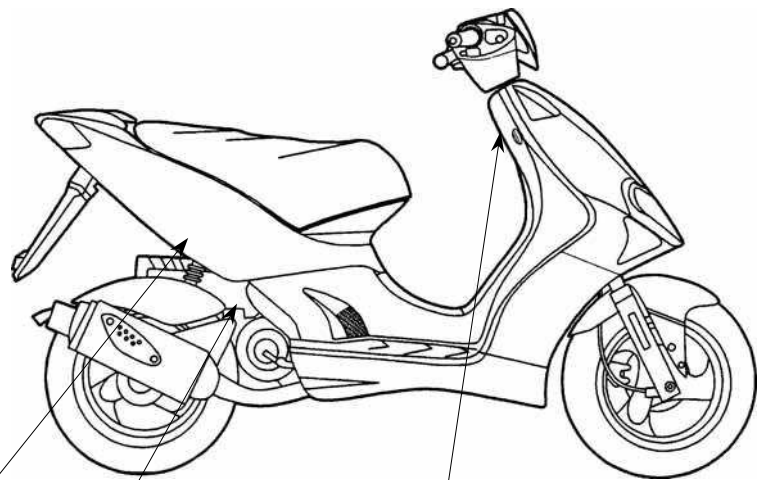

Vehicle Identification Serial Number



Location of Engine Serial Number



Location of Frame Serial Number

# 1. GENERAL INFORMATION

## SPECIFICATIONS

Name & Model No.		SH10DA		
Overall length		1850mm		
Overall width		700mm		
Overall height		1190mm		
Wheel base		1295mm		
Engine type		Water cooled 2-stroke		
Displacement		49.4cc		
Fuel Used		92# nonleaded gasoline		
Net weight (kg)	Front wheel	41		
	Rear wheel	61		
	Total	102		
Gross weight(kg)	Front wheel	95		
	Rear wheel	138		
	Total	233		
Tires	Front wheel	120/70-12		
	Rear wheel	130/70-12		
Ground clearance		160mm		
Performance	Braking distance (m)	4.4m /30km/HV		
	Min. turning radius	2150mm		
Engine	Starting system		Starting motor & kick starter	
	Type		Gasoline, 2-stroke	
	Cylinder arrangement		Single cylinder	
	Combustion chamber type		Semi-sphere	
	Bore x stroke (mm)		39 x 41.4	
	Compression ratio		7.2:1	
	Compression pressure (kg/cm <sup>2</sup> -rpm)		11.8	
	Max. output (ps/rpm)		3.6/6500	
	Max. torque (N-m/rpm)		3.92/6000	
	Port timing	Intake (1mm)	Open	Automatic controlled
		Exhaust (1mm)	Close	Automatic controlled
	Valve clearance (cold)	Intake	Open	
		Exhaust	Close	
	Idle speed (rpm)		2000±100rpm	
	Lubrication System	Lubrication type		Separate type
		Oil pump type		Plunger type
		Oil filter type		Full-flow filtration
		Oil capacity		1.7 liters
	Exchanging capacity		1.4 liters	
	Cooling Type		Water cooling	

Fuel System	Air cleaner type & No		Sponge wet	
	Gear oil capacity		0.12 liters	
	Fuel capacity		6.8 liters	
	Carburetor	Type	P B	
Piston dia.		13		
Venturi dia.		14 equivalent		
Electrical Equipment	Type		CDI	
	Ignition timing		13.5°±2°/2000rpm	
	Spark plug		NGK BR8HSA	
	Spark plug gap		0.6~0.7mm	
	Battery	Capacity		12V4AH
Power Drive System	Clutch	Type	Dry multi-disc clutch	
		Transmission Gear	Type	Non-stage transmission
	Reduction Gear		Operation	Automatic centrifugal type
		Type	Two-stage reduction	
Moving Device	Front Axle	Caster angle		
		Connecting rod		
	Tire pressure (kg/cm <sup>2</sup> )	Front	1.75	
		Rear	2.25	
Turning angle	Left	42.5°		
	Right	42.5°		
Brake system type		Front	Disk brake	
		Rear	Disk brake	
Damping Device	Suspension type	Front	Telescope	
		Rear	Unit swing	
Shock absorber type	Front	Telescope		
	Rear	Double swing		
Frame type		Under bone		

# 1. GENERAL INFORMATION

Name & Model No.		SF10DA		
Overall length		1850mm		
Overall width		700mm		
Overall height		1190mm		
Wheel base		1295mm		
Engine type		Air cooled 2-stroke		
Displacement		49.4cc		
Fuel Used		92# nonleaded gasoline		
Net weight (kg)	Front wheel	41.5		
	Rear wheel	64.5		
	Total	106		
Gross weight(kg)	Front wheel	83.5		
	Rear wheel	132.5		
	Total	216		
Tires	Front wheel	120/70-12		
	Rear wheel	130/70-12		
Ground clearance		160mm		
Performance	Braking distance (m)	4.4m /30km/HV		
	Min. turning radius	2150mm		
Engine	Starting system		Starting motor & kick starter	
	Type		Gasoline, 2-stroke	
	Cylinder arrangement		Single cylinder, flat	
	Combustion chamber type		Semi-sphere	
	Bore x stroke (mm)		39 x 41.4	
	Compression ratio		7.2:1	
	Compression pressure (kg/cm <sup>2</sup> -rpm)		11.8	
	Max. output (ps/rpm)		4.2/6500	
	Max. torque (N-m/rpm)		4.9/6000	
	Port timing	Intake (1mm)	Open	Automatic controlled
		Exhaust (1mm)	Close	Automatic controlled
	Valve clearance (cold)	Intake	Open	
		Exhaust	Close	
	Idle speed (rpm)		1900±100rpm	
	Lubrication System	Lubrication type		Separate type
		Oil pump type		Plunger type
		Oil filter type		Full-flow filtration
		Oil capacity		1.7 liters
	Exchanging capacity		1.4 liters	
	Cooling Type		Air cooling	

Fuel System	Air cleaner type & No		Sponge wet	
	Gear oil capacity		0.12 liters	
	Fuel capacity		6.8 liters	
	Carburetor	Type	P B	
Piston dia.		13		
Venturi dia.		14 equivalent		
Electrical Equipment	Type		CDI	
	Ignition timing		13.5°±2°/2000rpm	
	Spark plug		NGK BR8HSA	
	Spark plug gap		0.6~0.7mm	
	Battery	Capacity		12V4AH
Power Drive System	Clutch	Type	Dry multi-disc clutch	
		Transmission Gear	Type	Non-stage transmission
	Reduction Gear		Operation	Automatic centrifugal type
		Type	Two-stage reduction	
Moving Device	Front Axle	Caster angle		
		Connecting rod		
	Tire pressure (kg/cm <sup>2</sup> )	Front	1.75	
		Rear	2.25	
Turning angle	Left	42.5°		
	Right	42.5°		
Brake system type		Front	Disk brake	
		Rear	Expanding brake	
Damping Device	Suspension type	Front	Telescope	
		Rear	Unit swing	
Shock absorber type	Front	Telescope		
	Rear	Double swing		
Frame type		Under bone		

# 1. GENERAL INFORMATION

## SERVICE PRECAUTIONS

- Make sure to install new gaskets, O-rings, circlips, cotter pins, etc. when reassembling.

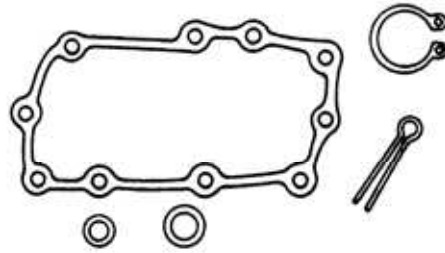

- When tightening bolts or nuts, begin with larger-diameter to smaller ones at several times, and tighten to the specified torque diagonally.

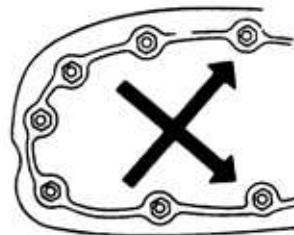

- Use genuine parts and lubricants.

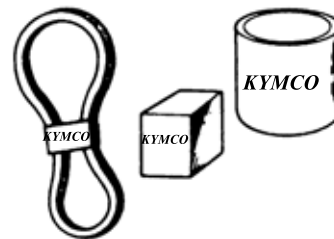

- When servicing the motorcycle, be sure to use special tools for removal and installation.



- After disassembly, clean removed parts. Lubricate sliding surfaces with engine oil before reassembly.

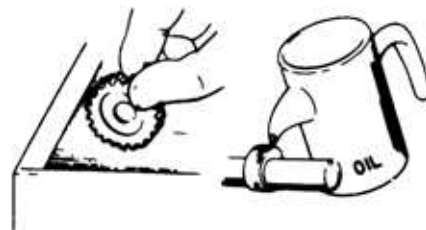

# 1. GENERAL INFORMATION

- Apply or add designated greases and lubricants to the specified lubrication points.

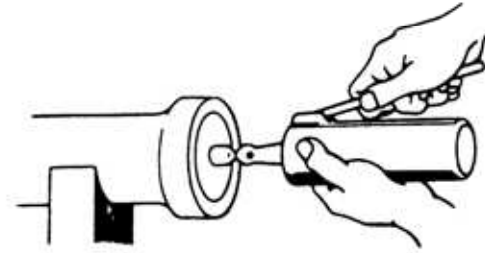

- After reassembly, check all parts for proper tightening and operation.

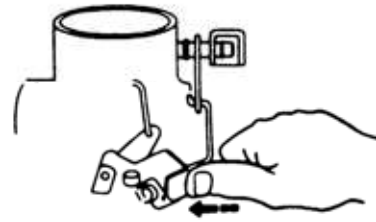

- When two persons work together, pay attention to the mutual working safety.

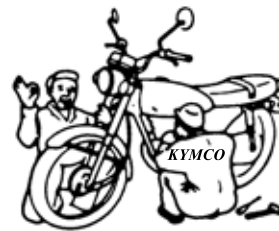

- Disconnect the battery negative (-) terminal before operation.
- When using a spanner or other tools, make sure not to damage the motorcycle surface.

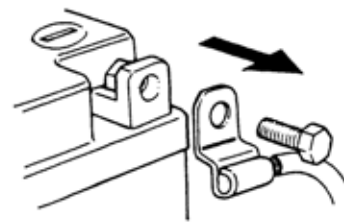

- After operation, check all connecting points, fasteners, and lines for proper connection and installation.
- When connecting the battery, the positive (+) terminal must be connected first.
- After connection, apply grease to the battery terminals.
- Terminal caps shall be installed securely.

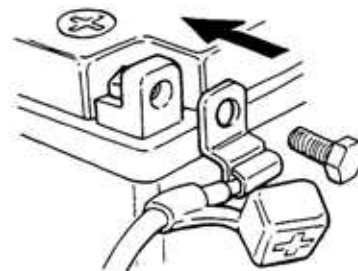

# 1. GENERAL INFORMATION

---

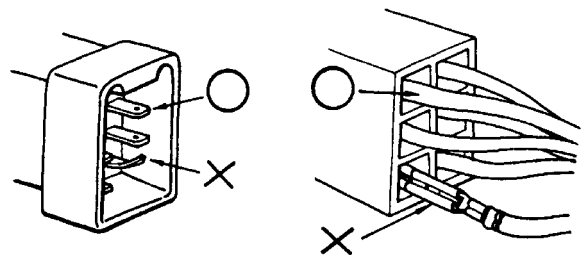
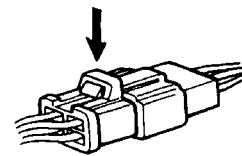
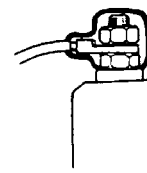
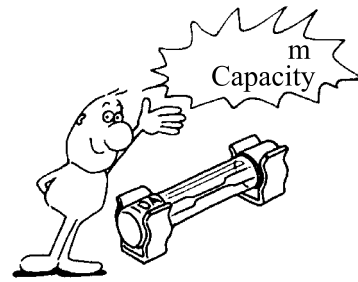



# 1. GENERAL INFORMATION

- The connector shall be inserted completely.
- If the double connector has a lock, lock it at the correct position.
- Check if there is any loose wire.

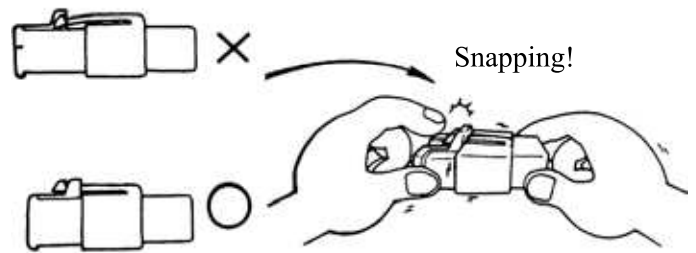

- Before connecting a terminal, check for damaged terminal cover or loose negative terminal.

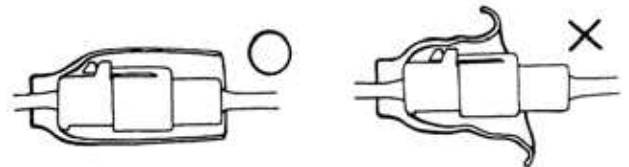

- Check the double connector cover for proper coverage and installation.

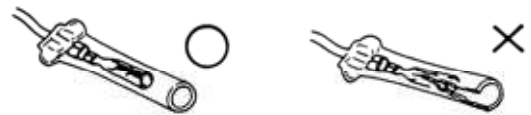

- Insert the terminal completely.
- Check the terminal cover for proper coverage.
- Do not make the terminal cover opening face up.



- Secure wire harnesses to the frame with their respective wire bands at the designated locations. Tighten the bands so that only the insulated surfaces contact the wire harnesses.

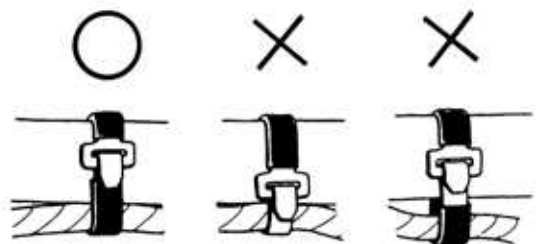

# 1. GENERAL INFORMATION

- After clamping, check each wire to make sure it is secure.

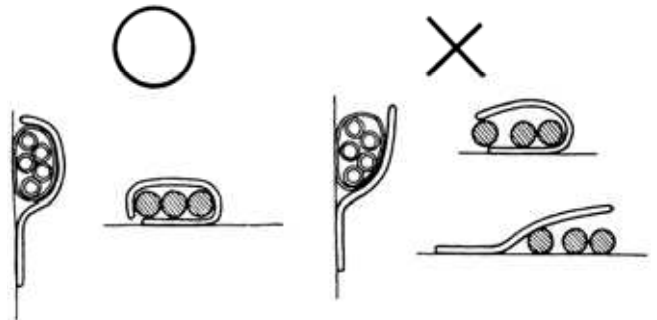

- Do not squeeze wires against the weld or its clamp.



- After clamping, check each harness to make sure that it is not interfering with any moving or sliding parts.

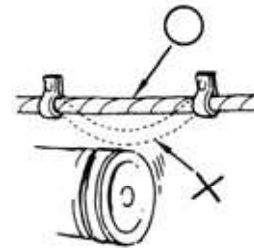

- When fixing the wire harnesses, do not make it contact the parts which will generate high heat.

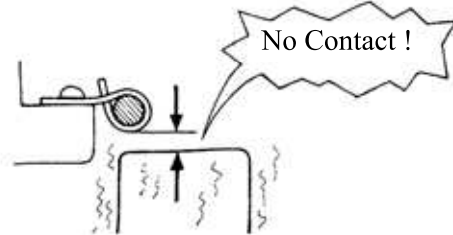

- Route wire harnesses to avoid sharp edges or corners. Avoid the projected ends of bolts and screws.
- Route wire harnesses passing through the side of bolts and screws. Avoid the projected ends of bolts and screws.

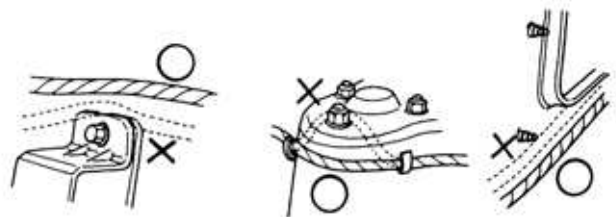

# 1. GENERAL INFORMATION

- Route harnesses so they are neither pulled tight nor have excessive slack.

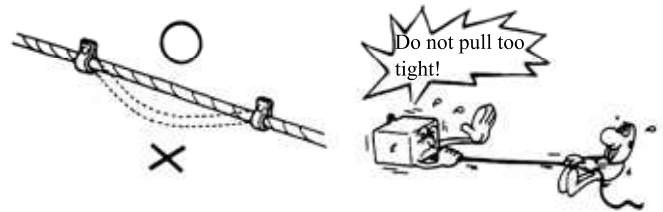

- Protect wires and harnesses with electrical tape or tube if they contact a sharp edge or corner.

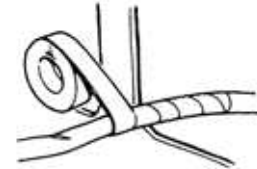

- When rubber protecting cover is used to protect the wire harnesses, it shall be installed securely.

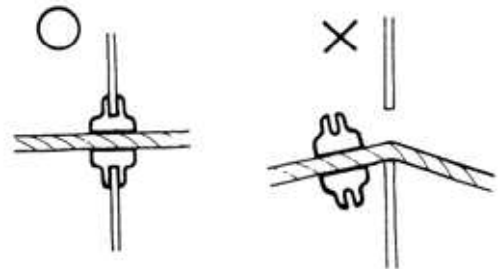

- Do not break the sheath of wire.
- If a wire or harness is with a broken sheath, repair by wrapping it with protective tape or replace it.

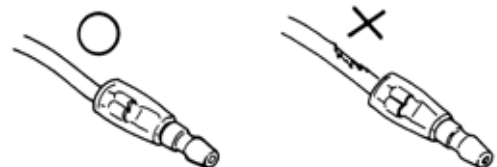

- When installing other parts, do not press or squeeze the wires.



# 1. GENERAL INFORMATION

- After routing, check that the wire harnesses are not twisted or kinked.

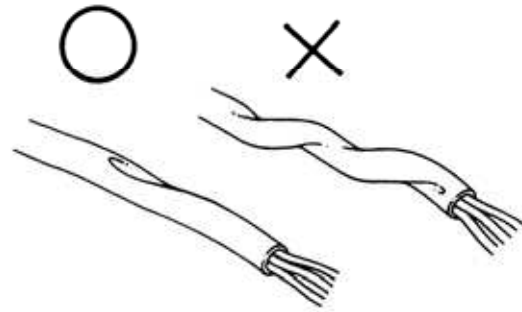

- Wire harnesses routed along with handlebar should not be pulled tight, have excessive slack or interfere with adjacent or surrounding parts in all steering positions.



- When a testing device is used, make sure to understand the operating methods thoroughly and operate according to the operating instructions.

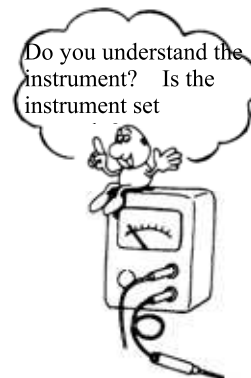

- Be careful not to drop any parts.



- When rust is found on a terminal, remove the rust with sand paper or equivalent before connecting.



# 1. GENERAL INFORMATION

---

## ■ Symbols:

The following symbols represent the servicing methods and cautions included in this service manual.



Engine Oil

: Apply engine oil to the specified points. (Use designated engine oil for lubrication.)



Grease

: Apply grease for lubrication.



Gear Oil

: Transmission Gear Oil (90#)



Special

: Use special tool.



: Caution



: Warning

# 1. GENERAL INFORMATION

## SERVICE INFORMATION

ENGINE Item	Standard (mm)		Service Limit (mm)	
	SF10DA	SH10DA	SF10DA	SH10DA
Cylinder head warpage	—	—	0.10	0.10
Piston O.D.(5mm from bottom of piston skirt)	38.955~38.970	38.955~38.970	38.90	38.90
Cylinder-to- piston clearance	0.03~0.07		0.10	0.10
Piston pin hole I.D.	12.002~12.008	12.002~12.008	12.03	12.03
Piston pin O.D.	11.994~12.0	11.994~12.0	11.98	11.98
Piston-to-piston pin clearance	0.002~0.014	←	0.03	←
Piston ring end gap (top/second)	0.10~0.25	0.10~0.25	0.40	0.40
Connecting rod small end I.D.	17.005~17.017	17.005~17.017	17.03	17.03
Cylinder bore	39.0~39.025	39.0~39.025	39.05	39.05
Drive belt width	18	18	17	17
Drive pulley collar O.D.	20.01~20.025	20.01~20.025	19.97	19.97
Movable drive face ID.	20.035~20.085	20.035~20.085	20.21	20.21
Weight roller O.D.	13.0	13.0	12.4	12.4
Clutch outer I.D.	107~107.2	107~107.2	107.5	107.5
Driven face spring free length	87.9	87.9	82.6	82.6
Driven face O.D.	33.965~33.985	←	33.94	←
Movable driven face I.D.	34.0~34.025	←	34.06	←
Connecting rod big end side clearance	—	←	0.60	←
Connecting rod big end radial clearance	—	←	0.04	←
Crankshaft runout A/B	—	—	L:0.15 R:0.10	←

CARBURETOR	SF10DA	SH10DA
Venturi dia.	14mm	14mm
Identification number	PB058 [C]	PB093 [C]
Float level	8.6mm	8.6mm
Main jet(Unlimited/limited speed)	#92/#78	#92/#78
Slow jet	#35	#35
Air screw opening	1¼ ± ½	1¼ ± ½
Idle speed	1900±100rpm	2000±100rpm
Throttle grip free play	2~6mm	2~6mm
Jet needle clip notch	1 <sup>st</sup> notch	1 <sup>st</sup> notch

# 1. GENERAL INFORMATION

## FRAME

Item		Standard (mm)		Service Limit (mm)	
		SF10DA	SH10DA	SF10DA	SH10DA
Axle shaft runout		—	—	0.2	0.2
Front wheel rim runout	Radial				
	Axial				
Front shock absorber spring free length		221.5	221.5	204.3	204.3
Rear wheel rim runout				2.0	2.0
Brake drum I.D.	Front/rear	110	110	111	111
Brake lining thickness	Front/rear	4.0/4.0	4.0/4.0	2.0/2.0	2.0/2.0
Brake disk runout	Front/rear	—	—	0.30	0.30
Rear shock absorber spring free length		214.7	214.7	197.7	197.7

## ELECTRICAL EQUIPMENT

		SF10DA	SH10DA	
Battery	Capacity	12V4AH	12V4AH	
	Voltage	13.0~13.2V	13.0~13.2V	
	Charging current	Standard	0.4A/5H	0.4A/5H
		Quick	4A/0.5H	4A/0.5H
Spark plug	(NGK)	BR8HSA	BR8HSA	
Spark plug gap		0.6~0.7mm	0.6~0.7mm	
Ignition coil resistance	Primary coil	0.153~0.187Ω	0.153~0.187Ω	
	Secondary coil (with plug cap)	6.99~10.21KΩ	6.99~10.21KΩ	
	Secondary coil (without plug cap)	3.24~3.96KΩ	3.24~3.96KΩ	
Pulser coil resistance (20°C)		80~160Ω	80~160Ω	
Ignition timing		13.5°±2°BTDC/2000rpm	13.5°±2°BTDC/2000rpm	

# 1. GENERAL INFORMATION

## TORQUE VALUES

### ENGINE

Item	Thread dia. (mm)	Torque (N-m)	Remarks
Cylinder head bolt	BF7x115	14.7~16.7	(cold)
Clutch drive plate nut	10	34.3~39.2	
Clutch outer nut	NH10	34.3~44.1	
Drive face nut	NH12	49.0~58.8	
Oil check bolt	10	9.8~14.7	
Engine mounting bolt	BF10x95	44.1~53.9	
Engine hanger bracket bolt	BF10x50	34.3~44.1	
Exhaust muffler joint lock nut	NC6mm	9.8~13.7	
Exhaust muffler lock bolt	BF8x35	29.4~35.3	
Spark plug		10.8~16.7	(cold)

### FRAME

Item	Thread dia. (mm)	Torque (N-m)	Remarks
Handlebar lock nut	10	44.1~49.0	Flange bolt/U-nut
Steering stem lock nut	25.4	78.4~117.6	
Steering top cone race	25.4	4.9~12.7	
Front axle nut	12	49.0~68.6	Flange U-nut
Rear axle nut	16	107.8~127.4	Flange U-nut
Rear brake arm bolt			Flange nut
Front shock absorber:			
upper mount bolt	8	32.3	Flange bolt/U-nut
lower mount bolt		32.3	Cross head
hex bolt		14.7~29.4	Apply locking agent
Front damper nut	8	14.7~29.4	
Front pivot arm bolt			Flange screw/U-nut
Rear shock absorber:			
upper mount bolt	10	34.3~44.1	Flange nut
lower mount bolt	8	23.5~29.4	
lower joint nut	8	14.7~24.5	

Torque specifications listed above are for important fasteners. Others should be tightened to standard torque values below.

#### STANDARD TORQUE VALUES

SH bolt: 8mm

Flange 6mm bolt

Item	Torque (N-m)	Item	Torque (N-m)
5mm bolt, nut	4.4~5.9	5mm screw	3.43~4.9
6mm bolt, nut	7.8~11.8	6mm screw, SH bolt	6.86~10.8
8mm bolt, nut	17.6~24.5	6mm flange bolt, nut	9.8~13.7
10mm bolt, nut	29.4~39.2	8mm flange bolt, nut	23.5~29.4
12mm bolt, nut	49.0~58.8	10mm flange bolt, nut	14.7~44.1



# 1. GENERAL INFORMATION

## SPECIAL TOOLS

Tool Name	Tool No.	Remarks
Universal bearing puller	E030	Crankshaft bearing removal
Lock nut socket wrench	F001	Top cone race holding
Lock nut wrench,	F001	Stem lock nut tightening
Crankcase puller	E026	Crankcase disassembly
Bearing remover set, 12mm (Spindle assy, 15mm) (Remover weight)	E020	Drive shaft bearing removal/installation
Bearing remover set, 15mm (Spindle assy, 15mm) (Remover head, 15mm) (Remover shaft, 15mm)	E018	Drive shaft bearing removal/installation
Bearing outer driver, 28x30mm	E014	Bearing installation
Clutch spring compressor	E027	Driven pulley disassembly/assembly
Crankcase assembly collar	E023	Driven shaft, crankshaft & crankcase assembly
Crankcase assembly tool	E024	Crankshaft & crankcase assembly
Ball race remover	F005	Steering stem bearing races
Rear shock absorber compressor	F004	Rear shock absorber disassembly/assembly
Universal holder	E017	Flywheel holding
Flywheel puller	E001	Flywheel removal
Pilot, 12mm	E020	Drive shaft bearing installation
Bearing outer driver, 32x35mm	E014	Drive shaft bearing installation Final shaft bearing installation
Bearing outer driver, 37x40mm	E014	Drive shaft bearing installation Final shaft bearing installation Crankshaft bearing installation
Outer driver, 24x26mm	E014	Driven pulley bearing installation

# 1. GENERAL INFORMATION

## LUBRICATION POINTS

### ENGINE

NO.	Lubrication Points	Lubricant	Remarks
1	Crankcase sliding & movable	JASO-FC or API-TC	
2	Cylinder movable parts		
3	Transmission gear (final gear)	SAE-90#	
4	Kick starter spindle bushing	Grease	
5	Drive pulley movable parts	Grease	
6	Starter pinion movable parts	Grease	

### FRAME

Apply clean engine oil or grease to cables and movable parts not specified. This will avoid abnormal noise and rise the durability of the motorcycle.

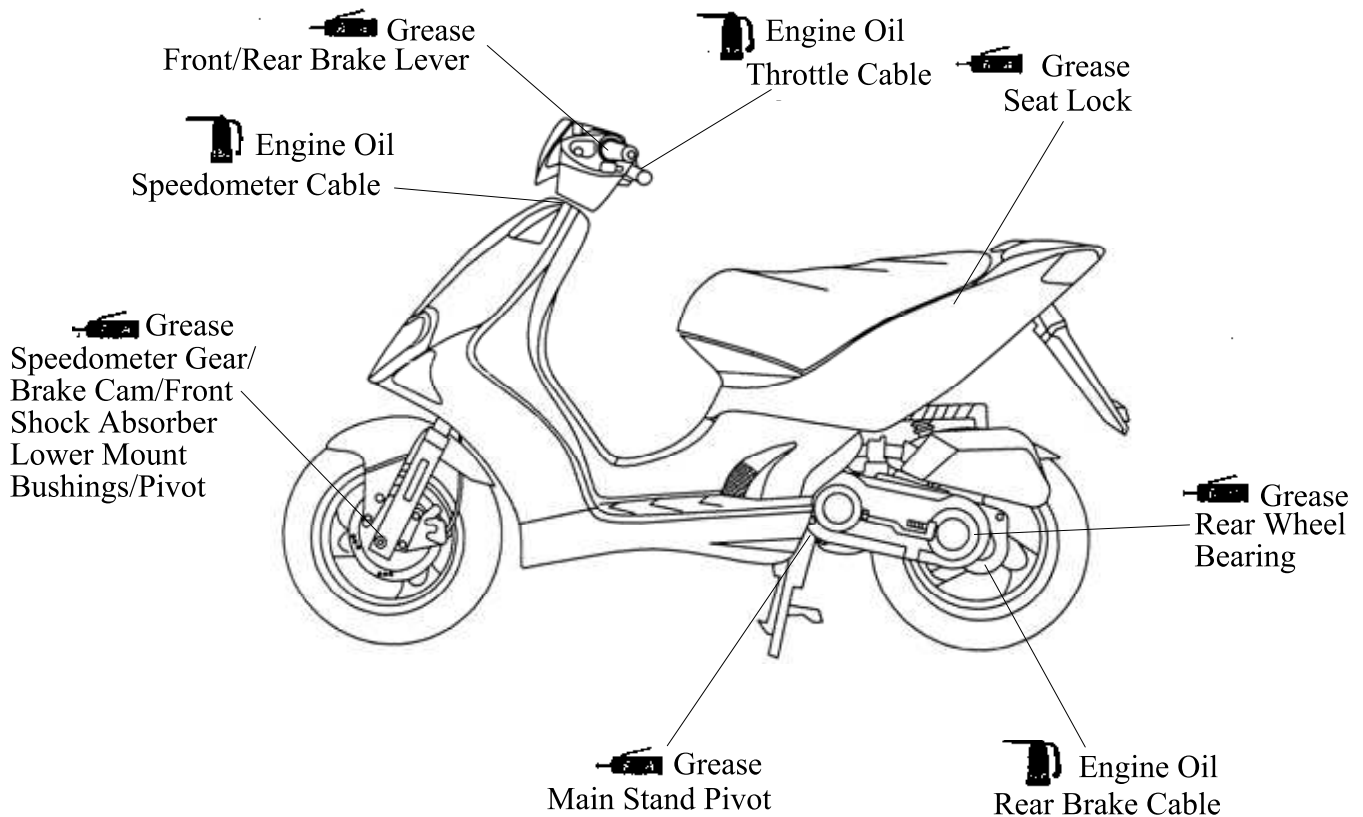

# 1. GENERAL INFORMATION

---

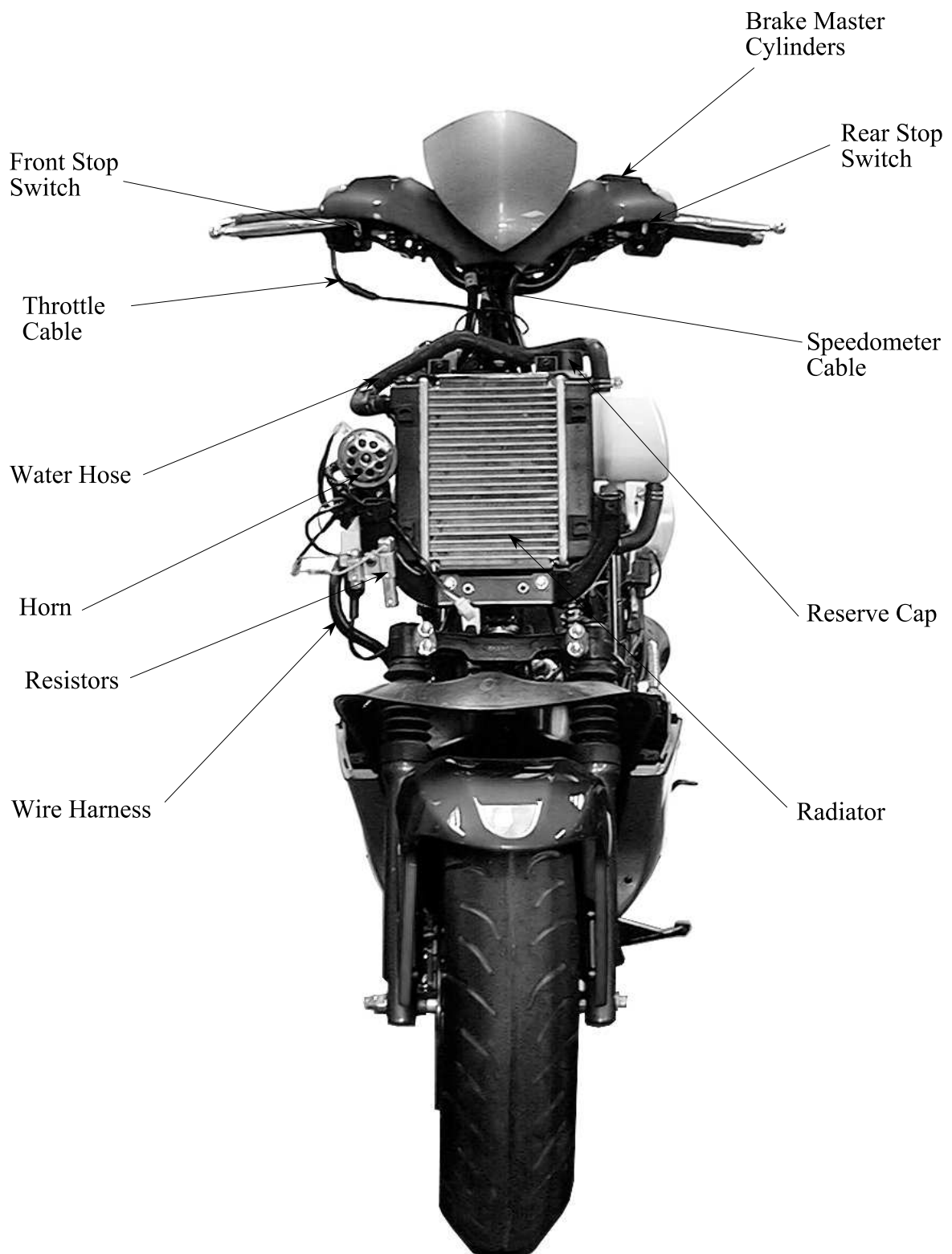

# 1. GENERAL INFORMATION

---

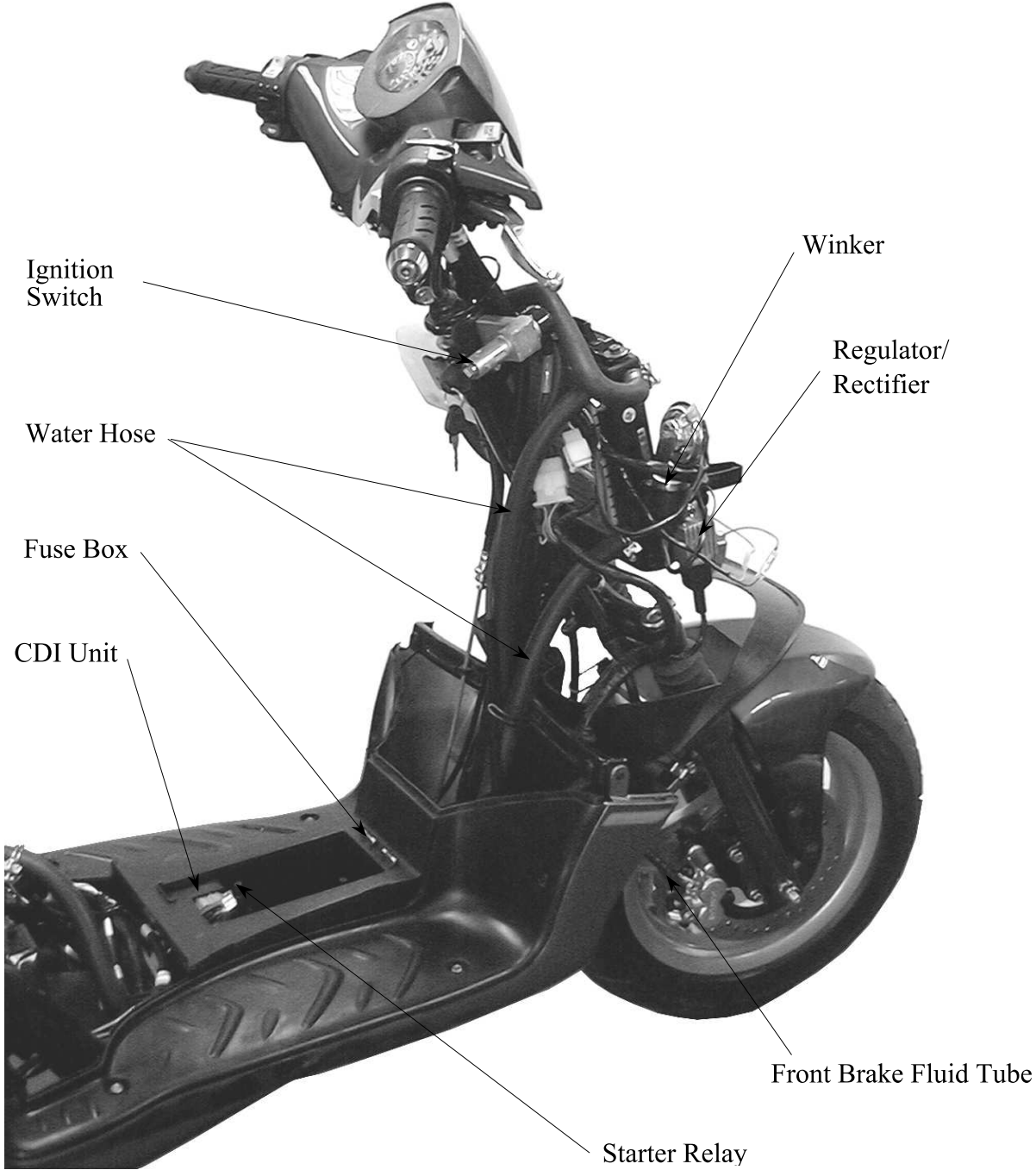

# 1. GENERAL INFORMATION

---

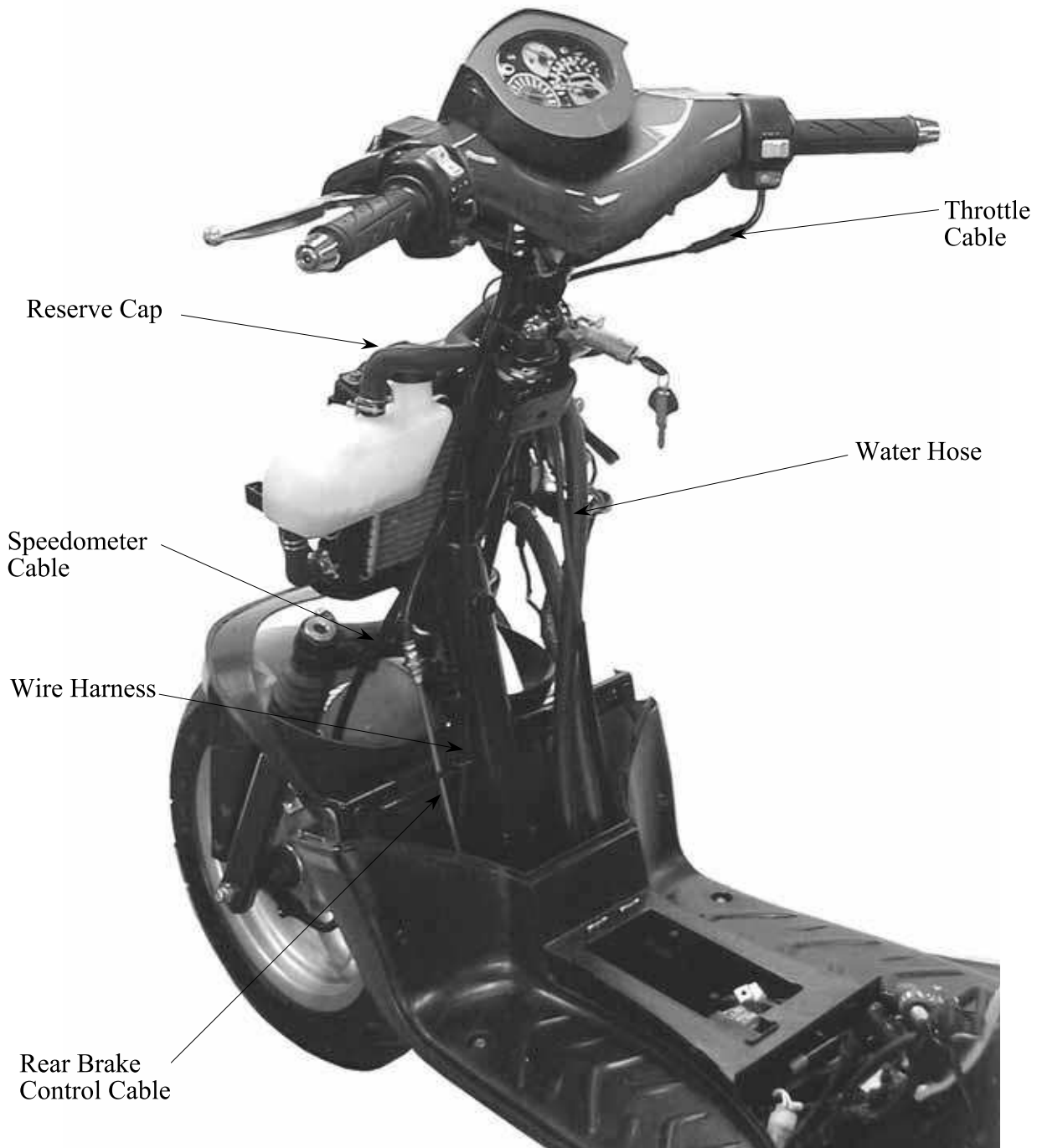

**1. GENERAL INFORMATION**

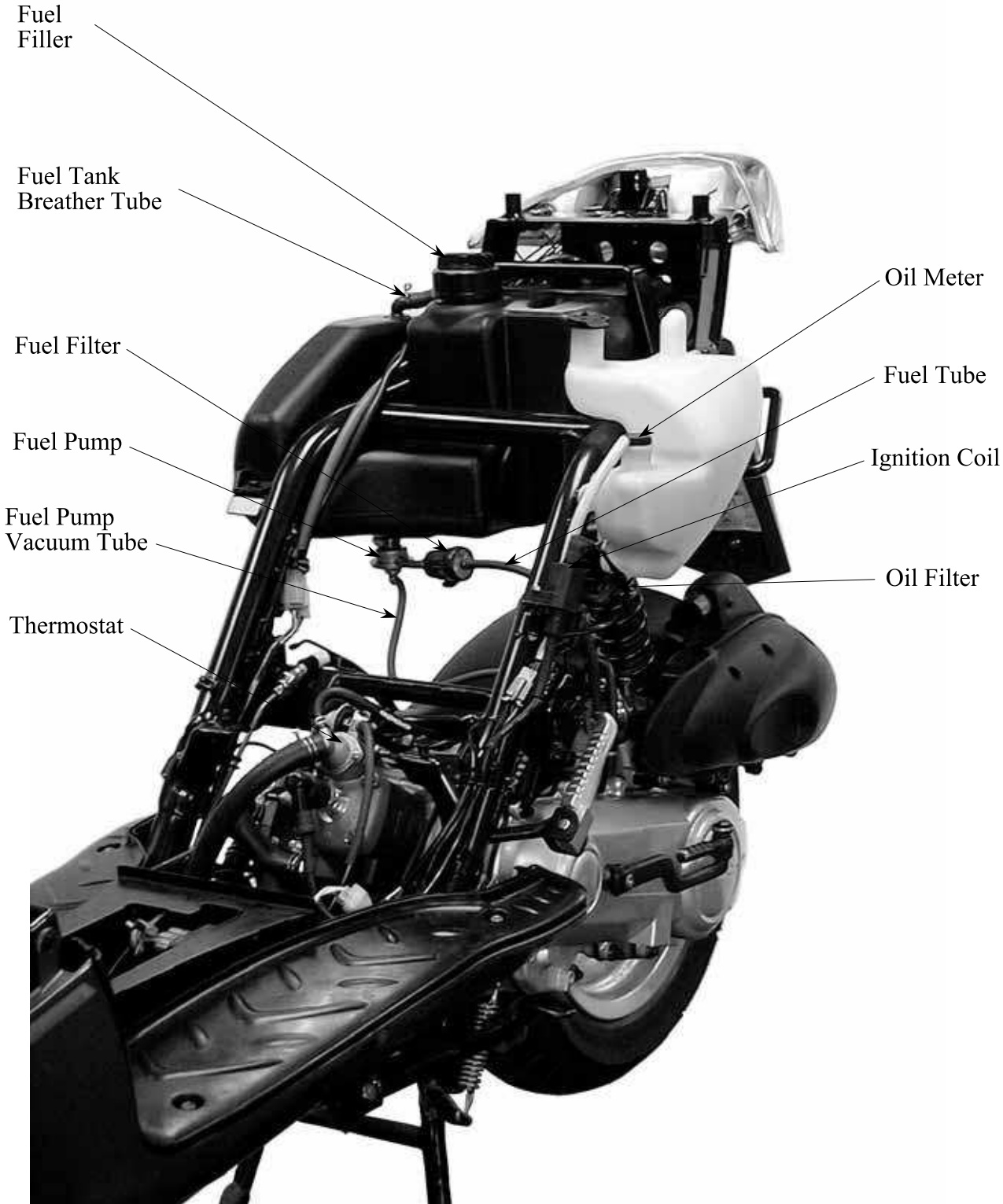

# 1. GENERAL INFORMATION

---

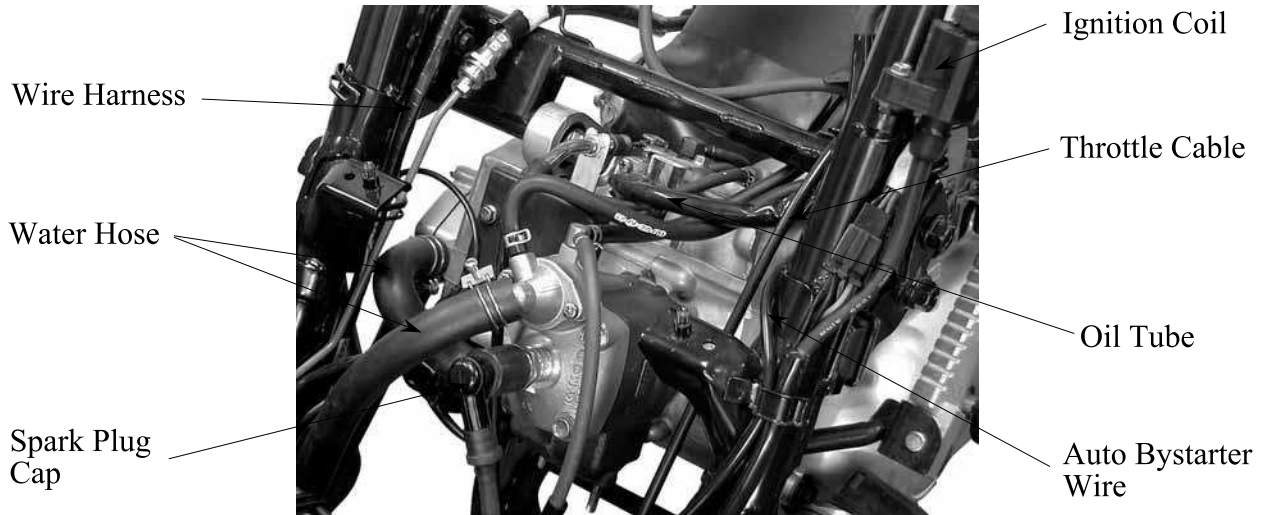

# 1. GENERAL INFORMATION

## WIRING DIAGRAM 〈SF10DA〉

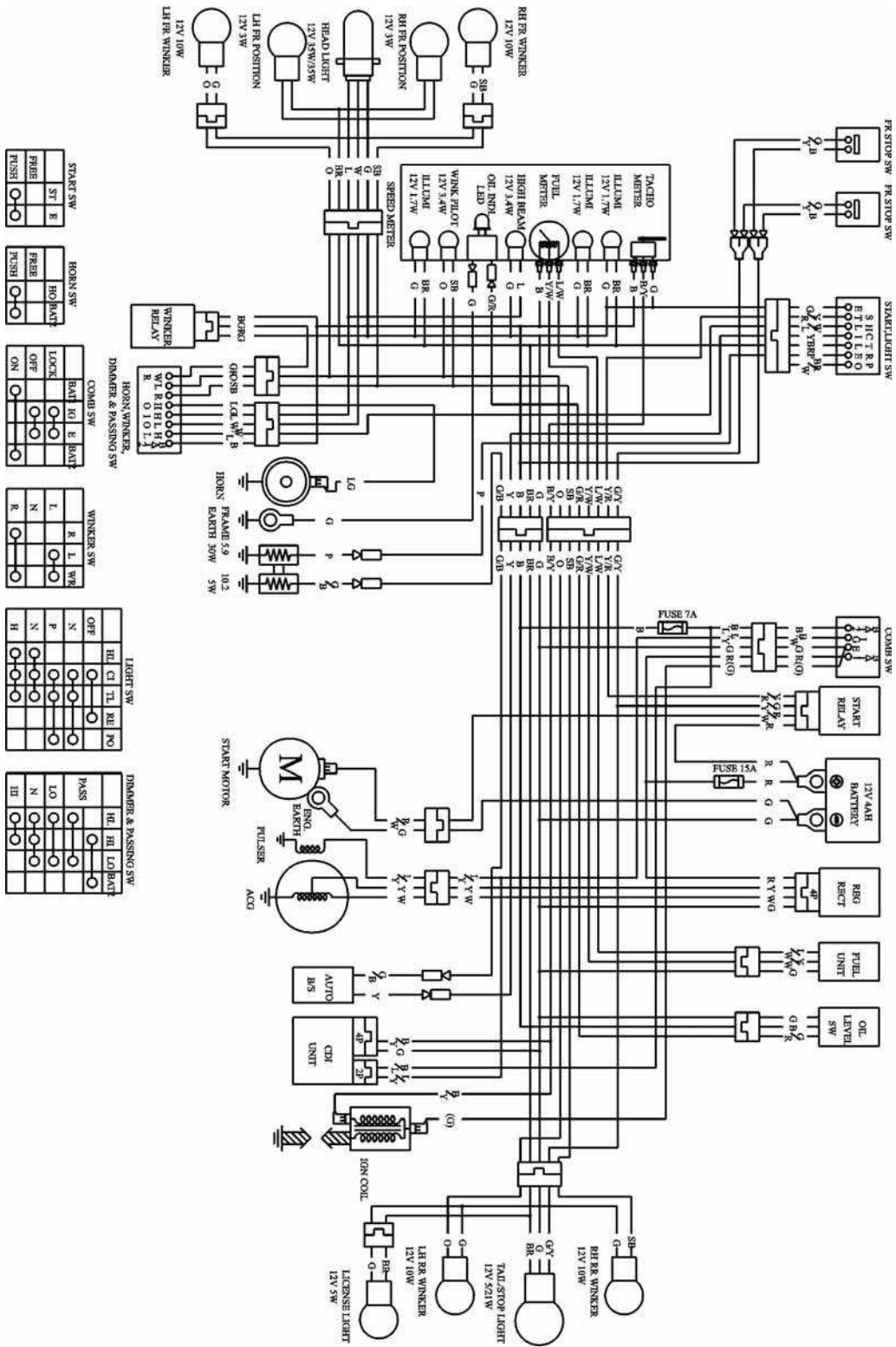



# 1. GENERAL INFORMATION

〈 SH10DA 〉

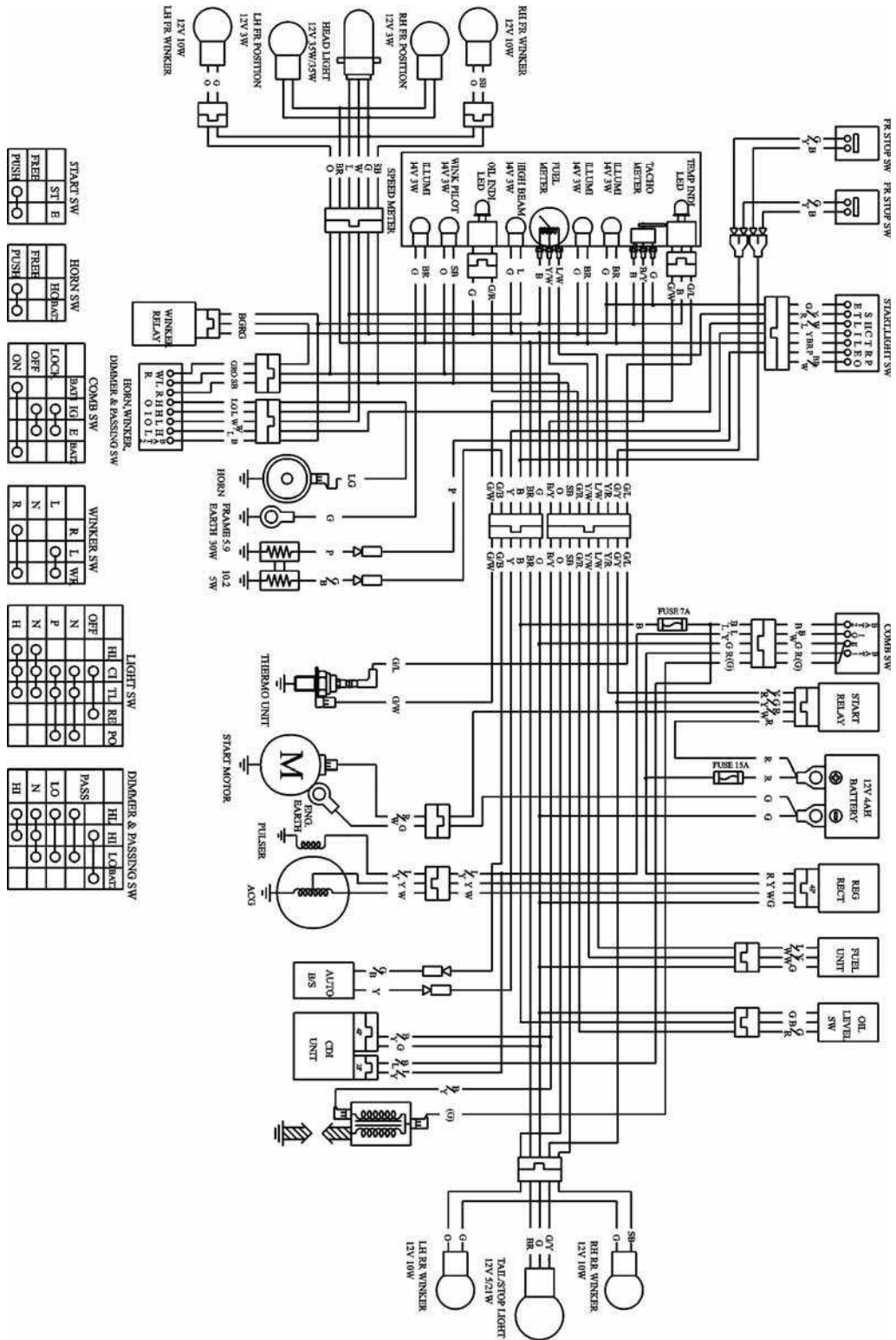

# 1. GENERAL INFORMATION

## TROUBLESHOOTING

### ENGINE WILL NOT START OR IS HARD TO START

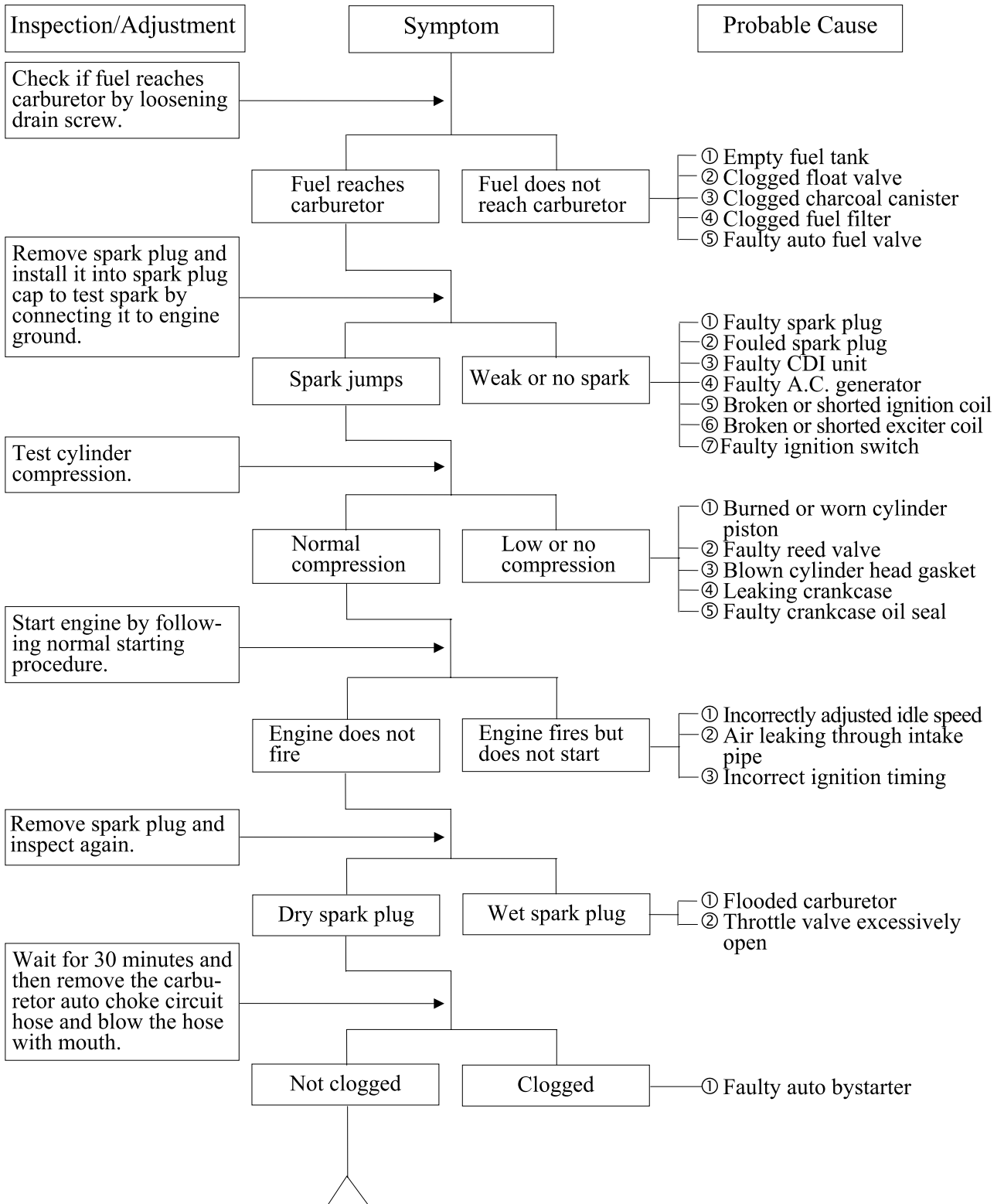

# 1. GENERAL INFORMATION

## ENGINE STOPS IMMEDIATELY AFTER IT STARTS

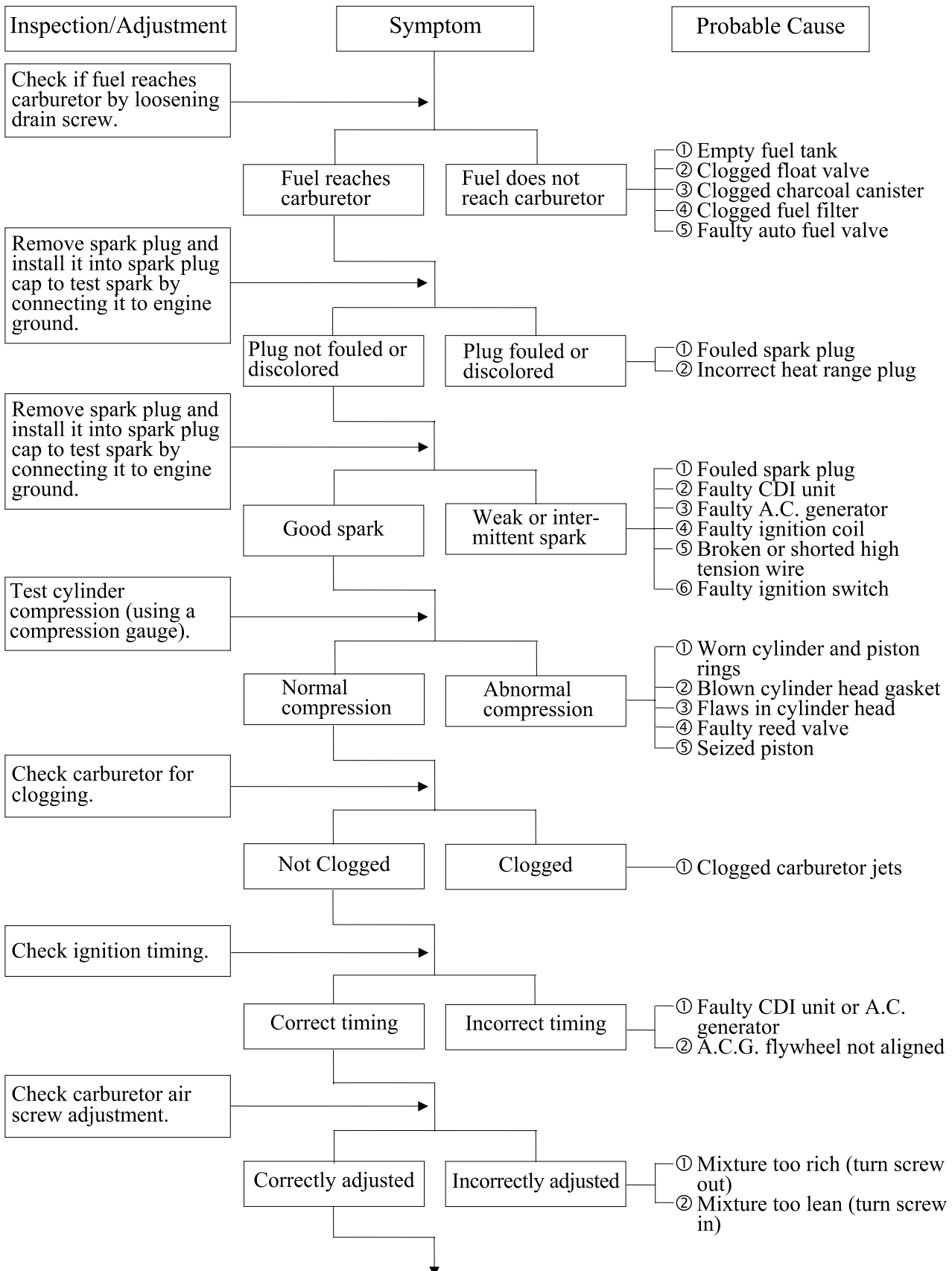

# 1. GENERAL INFORMATION

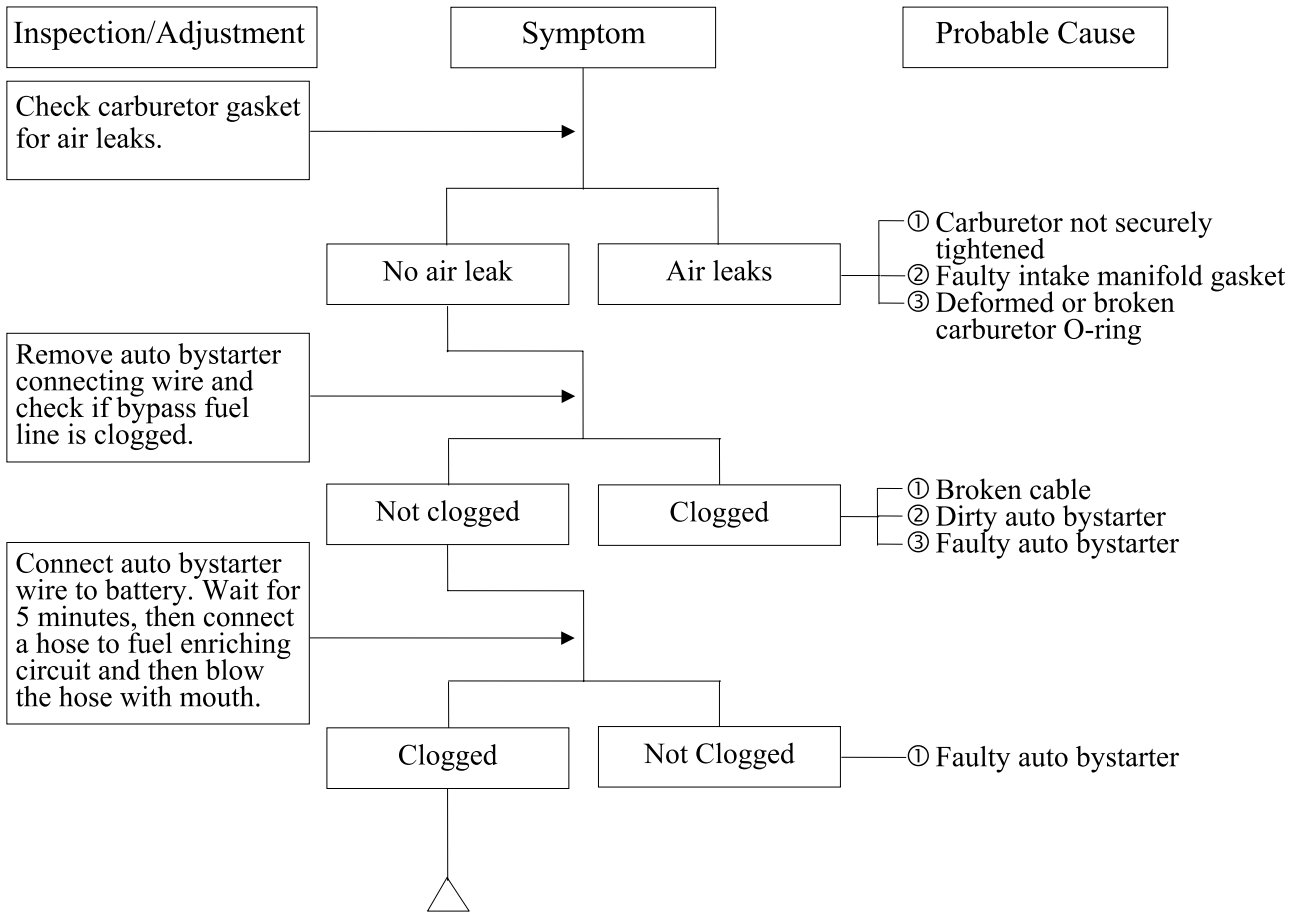

# 1. GENERAL INFORMATION

## ENGINE LACKS POWER

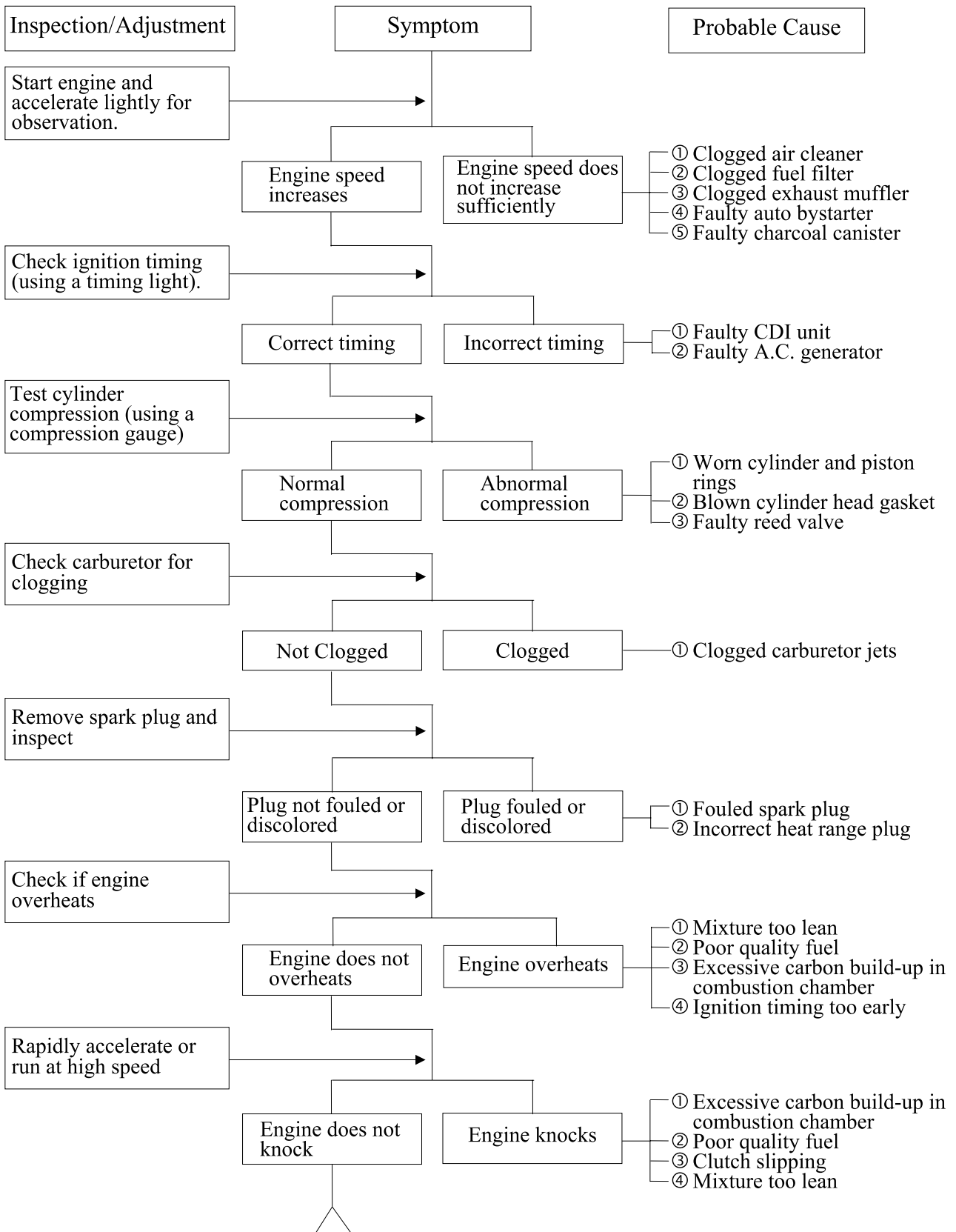

# 1. GENERAL INFORMATION

## POOR PERFORMANCE (ESPECIALLY AT IDLE AND LOW SPEEDS)

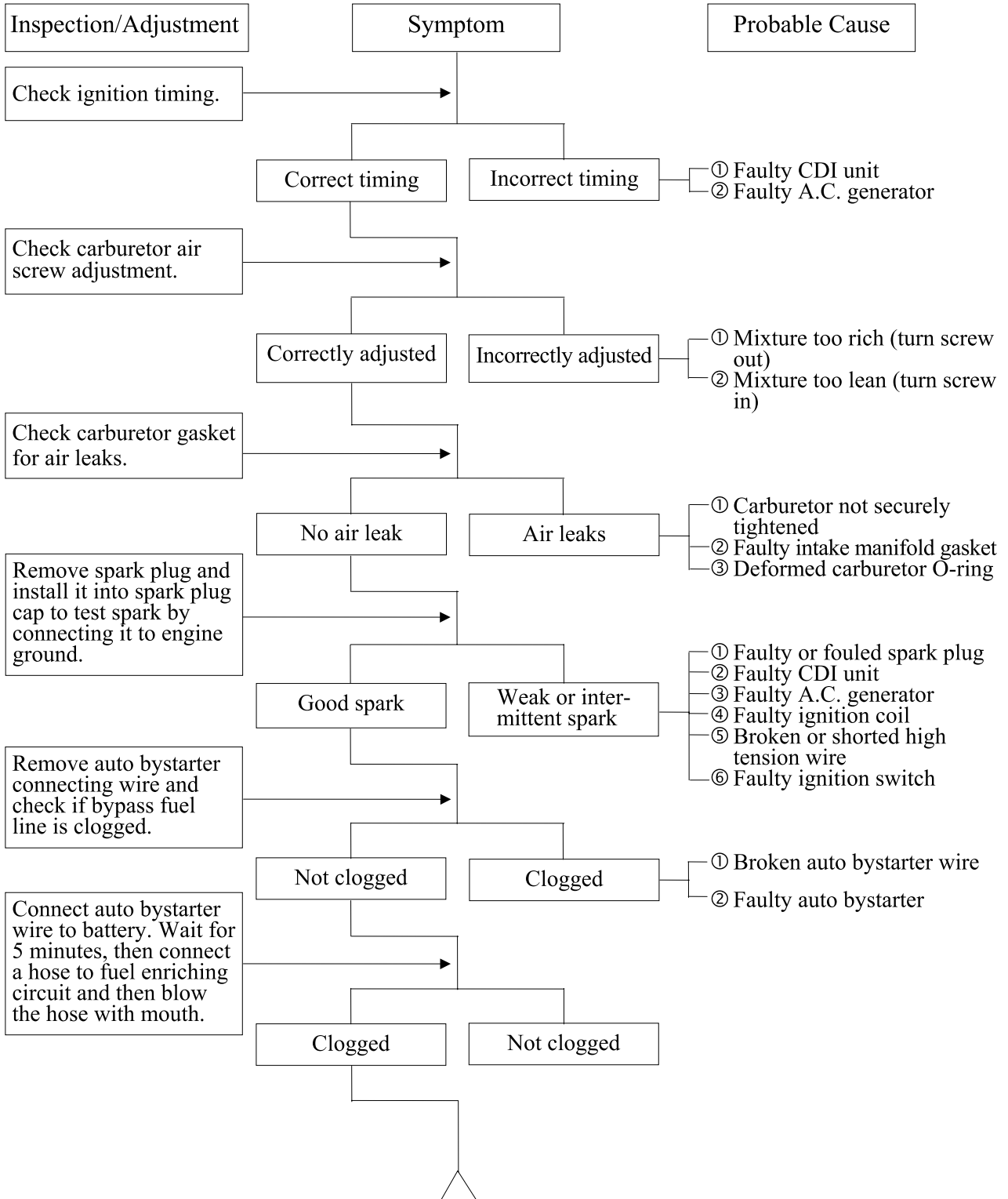

# 1. GENERAL INFORMATION

## POOR PERFORMANCE (AT HIGH SPEED)

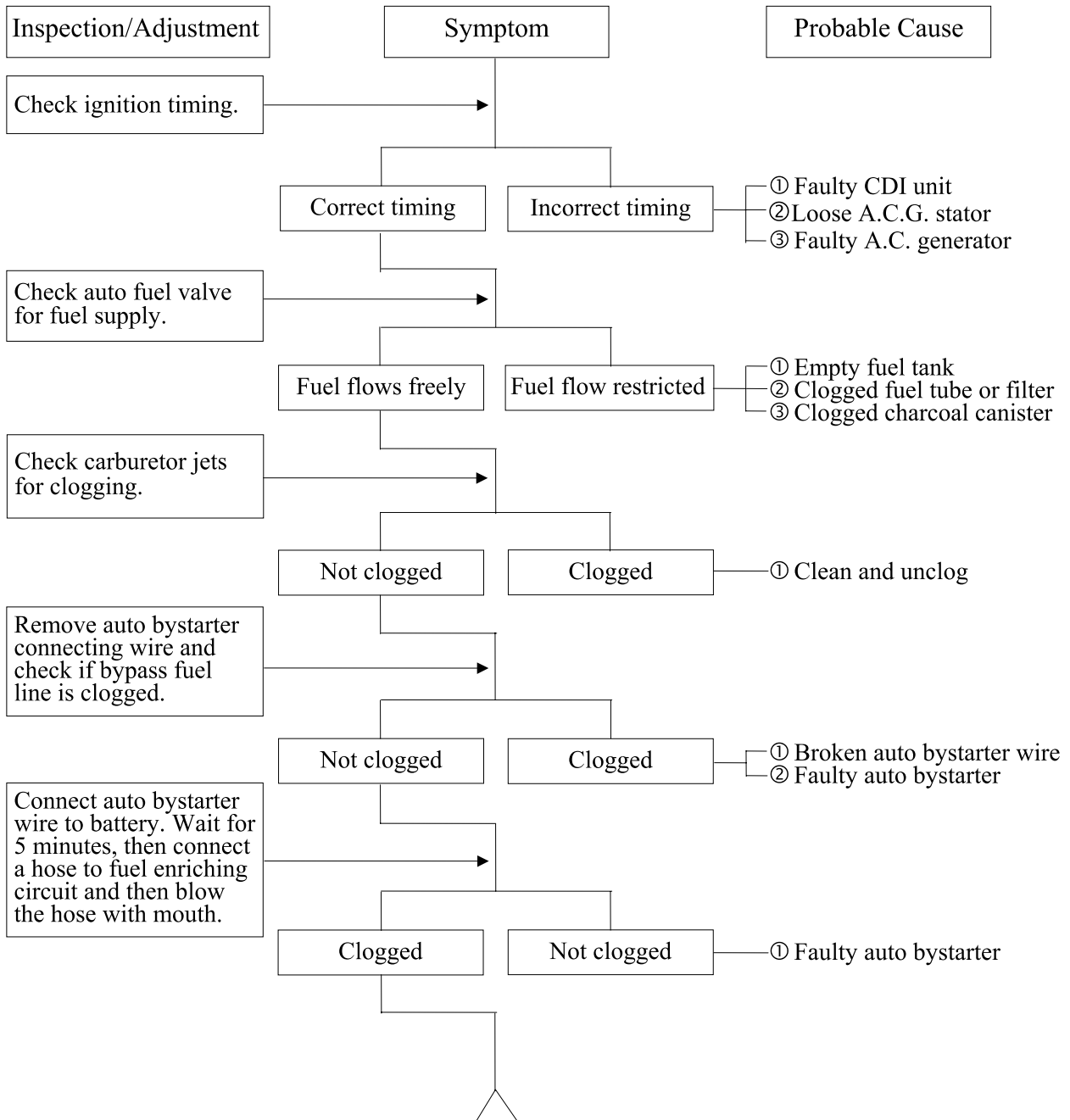

# 1. GENERAL INFORMATION

## CLUTCH, DRIVE AND DRIVEN PULLEYS

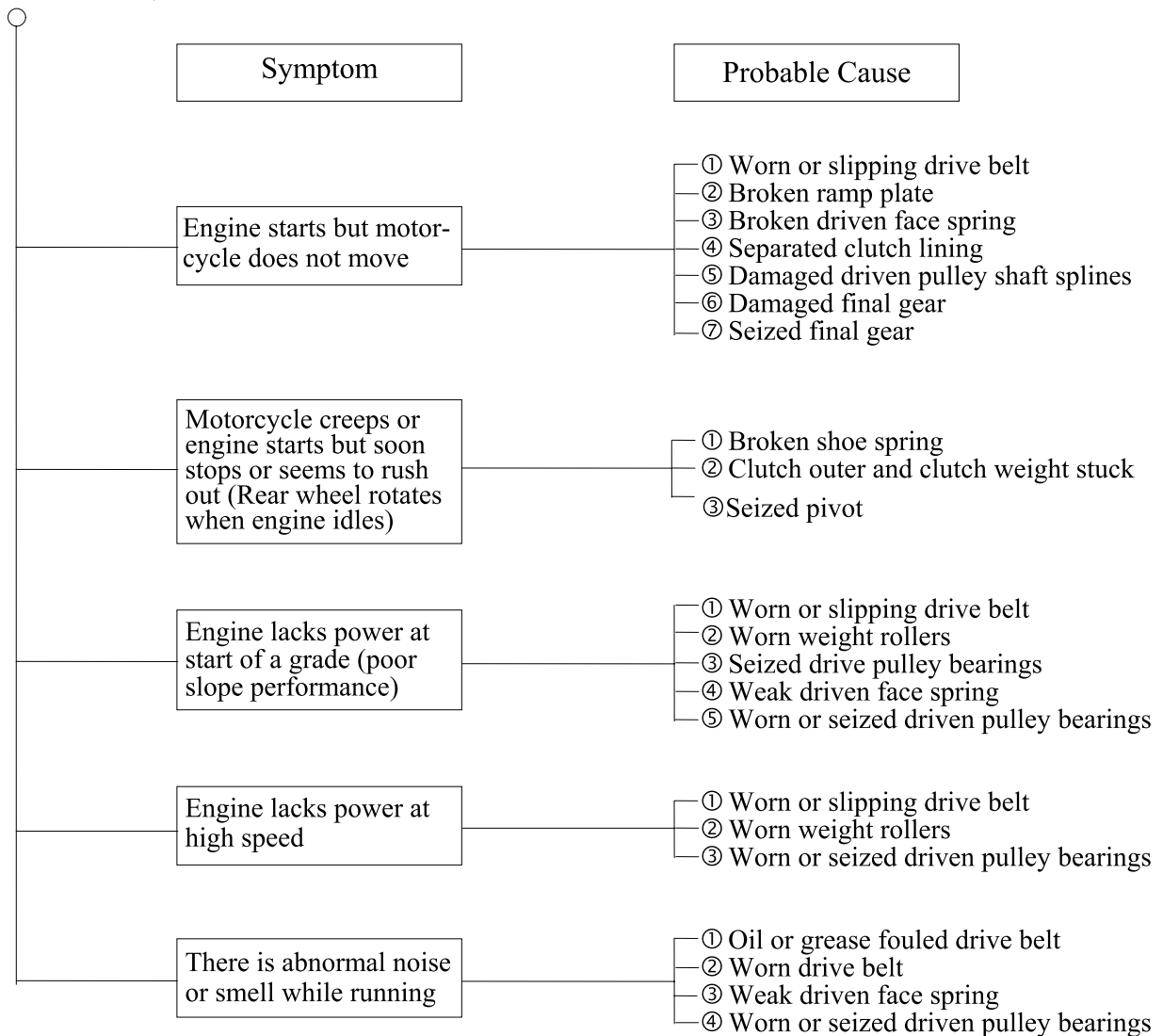

## STEERING HANDLEBAR DOES NOT TRACK STRAIGHT

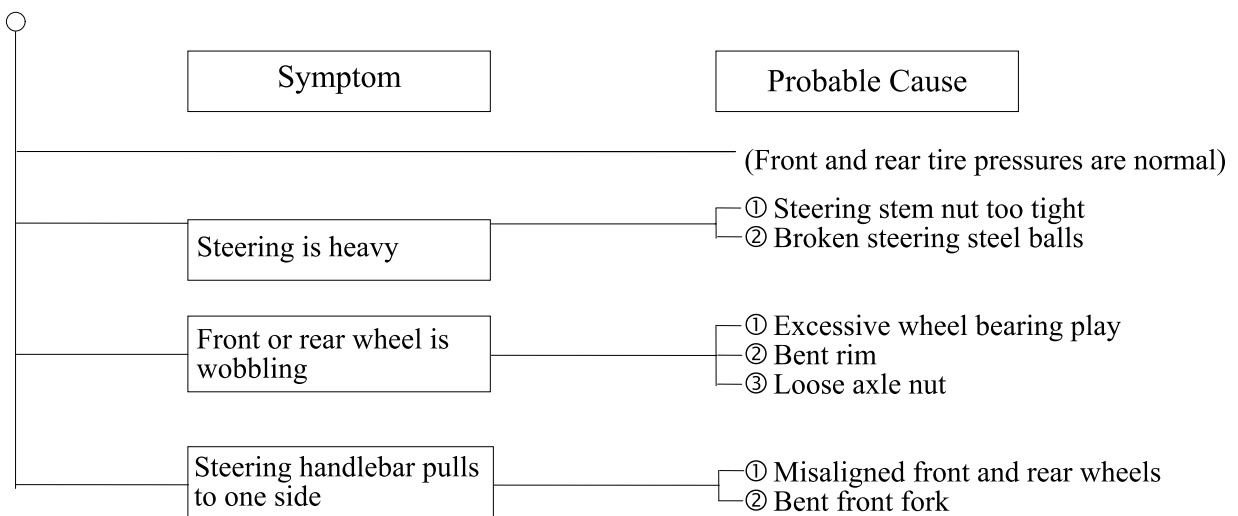



# 1. GENERAL INFORMATION

## POOR SUSPENSION PERFORMANCE

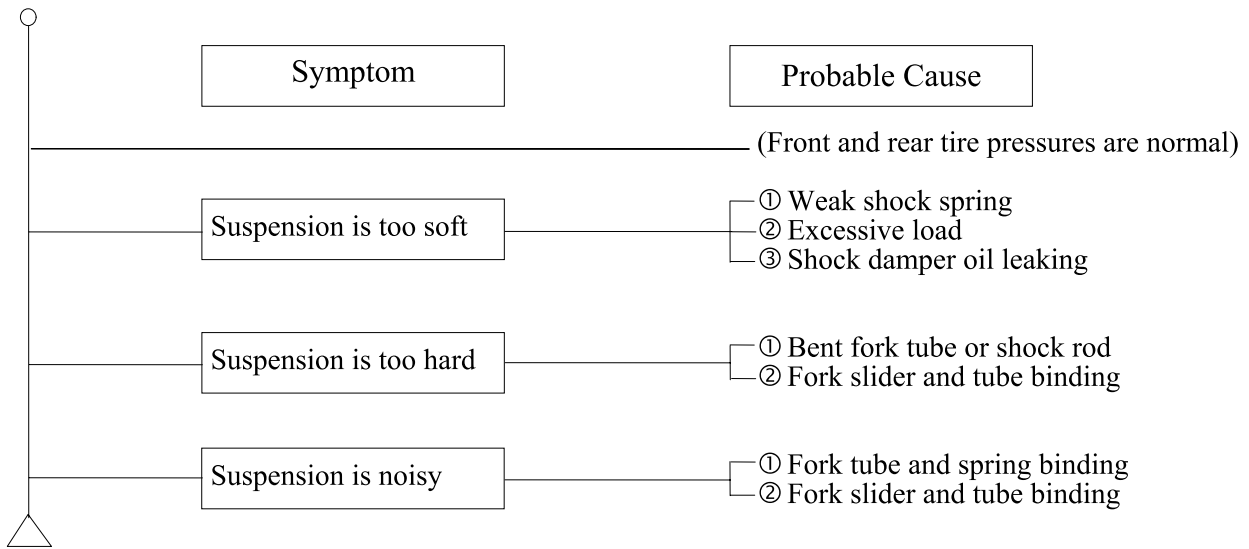

## POOR BRAKE PERFORMANCE

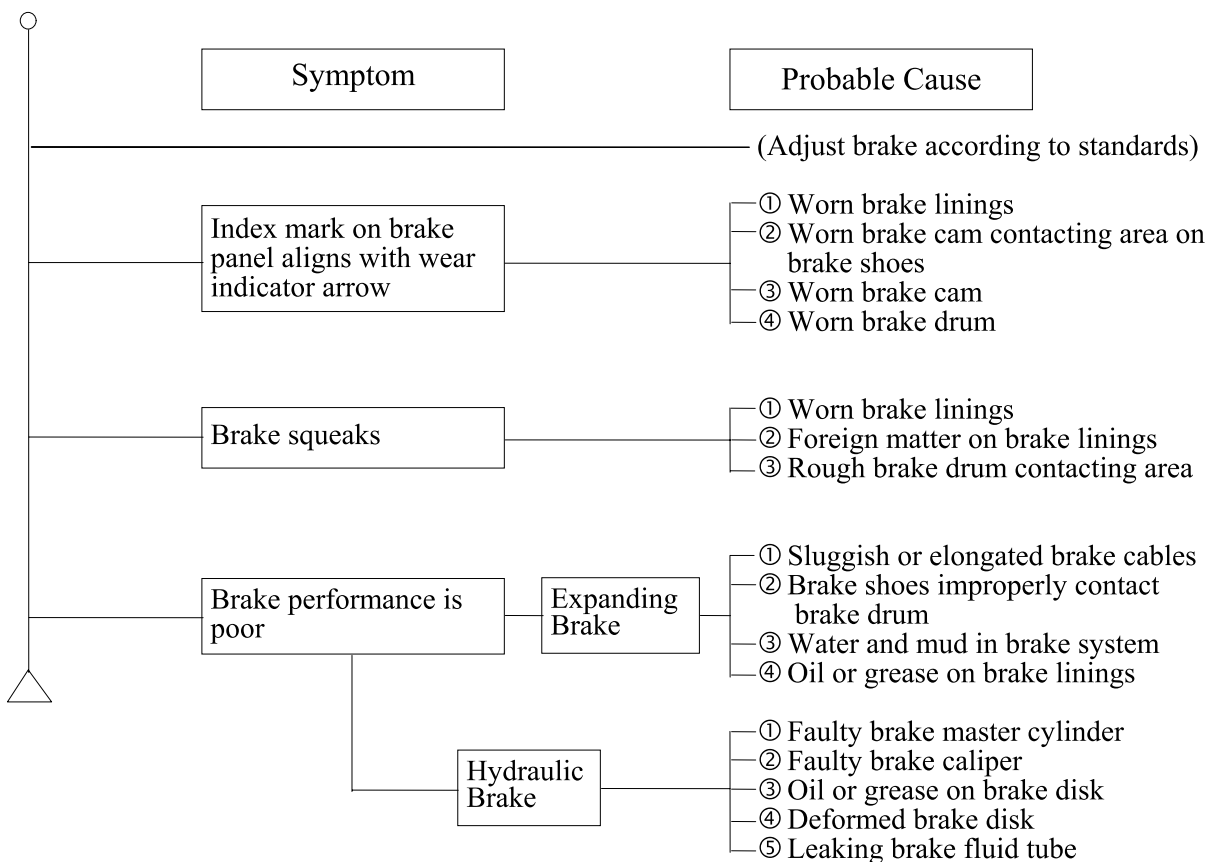

# 1. GENERAL INFORMATION

## OIL METER

1. Motor oil indicator light does not come on when there is no motor oil (Ignition switch ON)

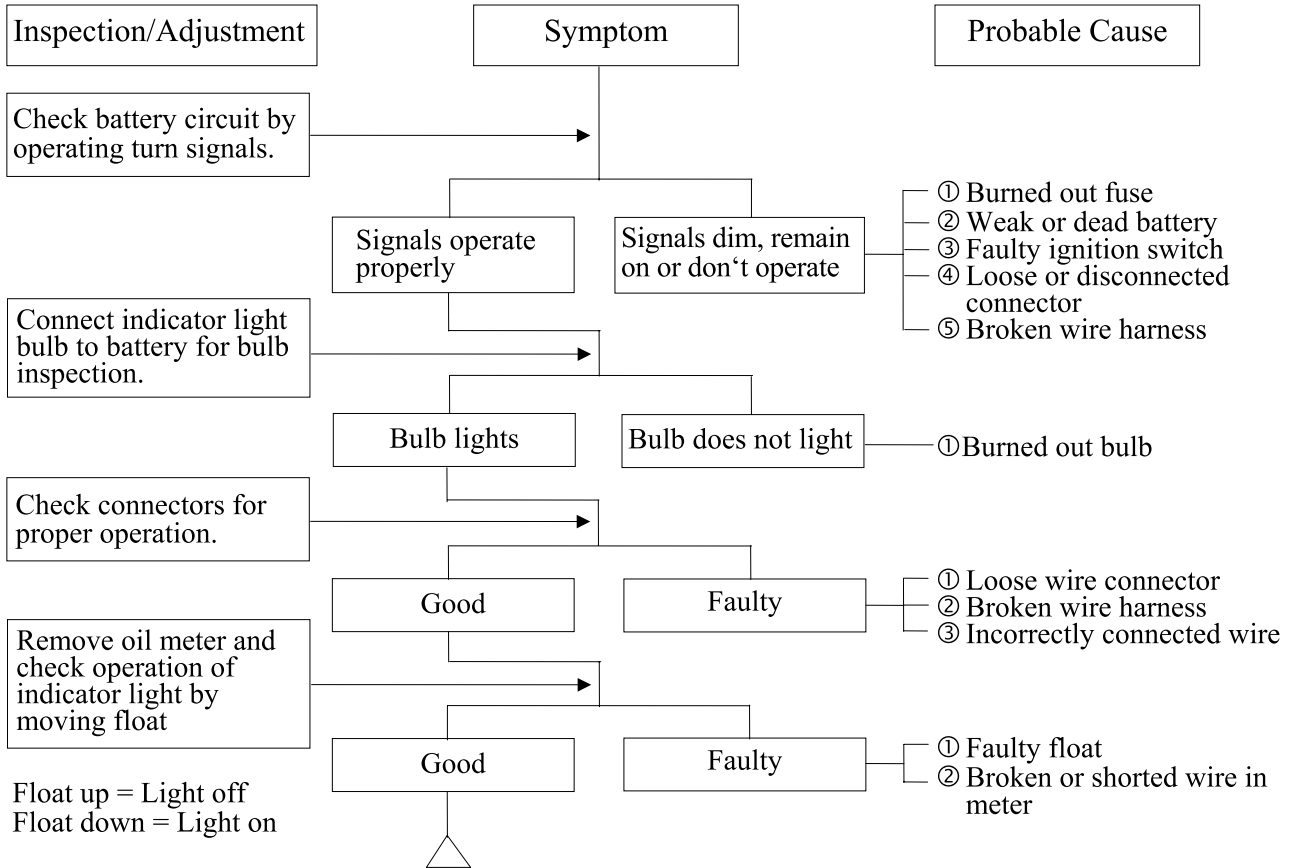

2. Motor oil is sufficient but the indicator light remains on (Ignition switch ON)

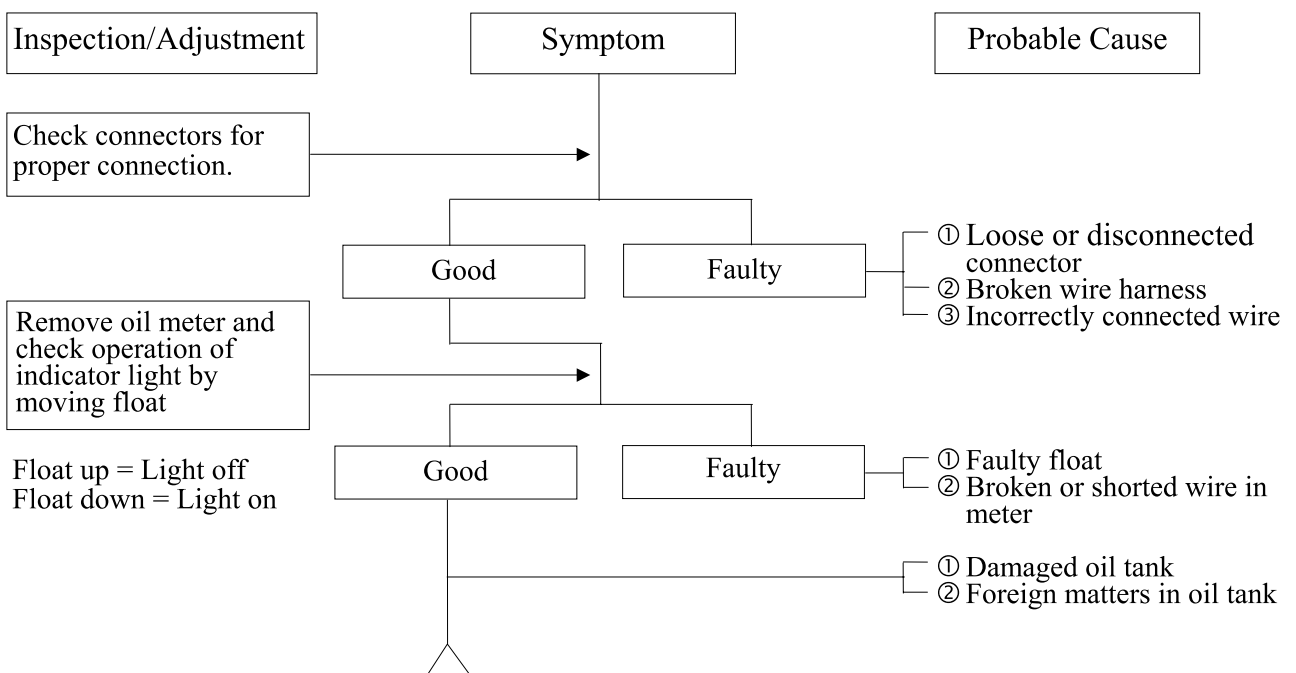

# 1. GENERAL INFORMATION

## FUEL GAUGE

### 1. Pointer does not register correctly (Ignition switch ON)

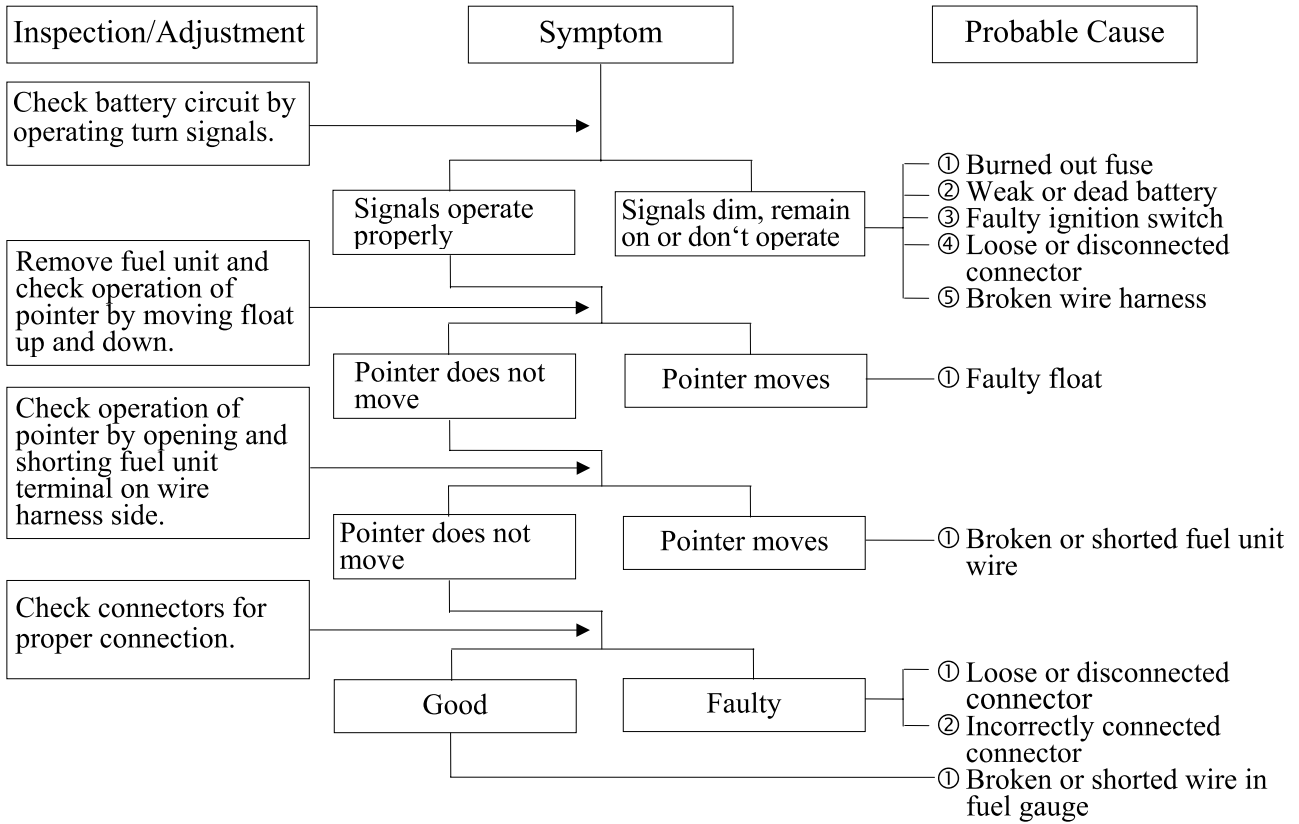

### 2. Pointer fluctuates or swings (Ignition switch ON)

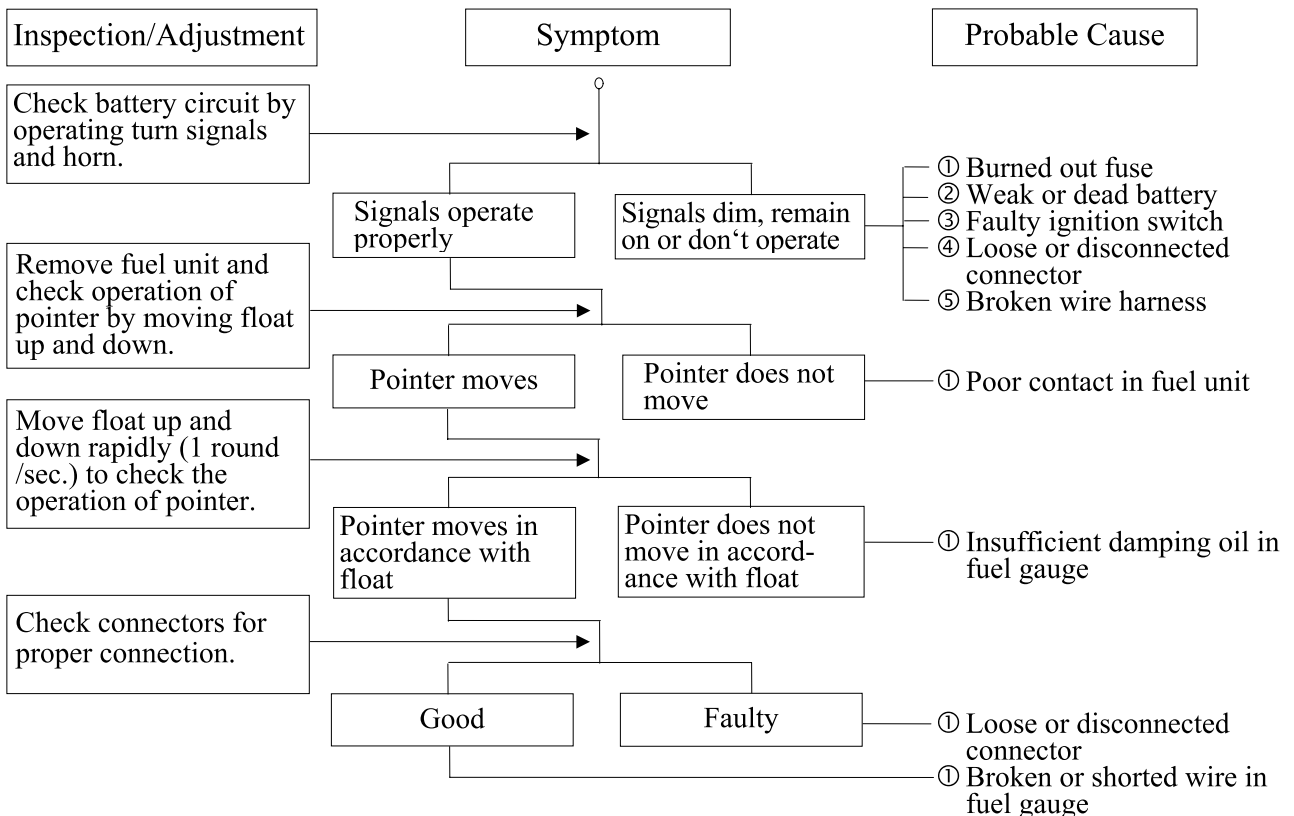

# 1. GENERAL INFORMATION

## STARTER MOTOR

### 1. Starter motor won't turn

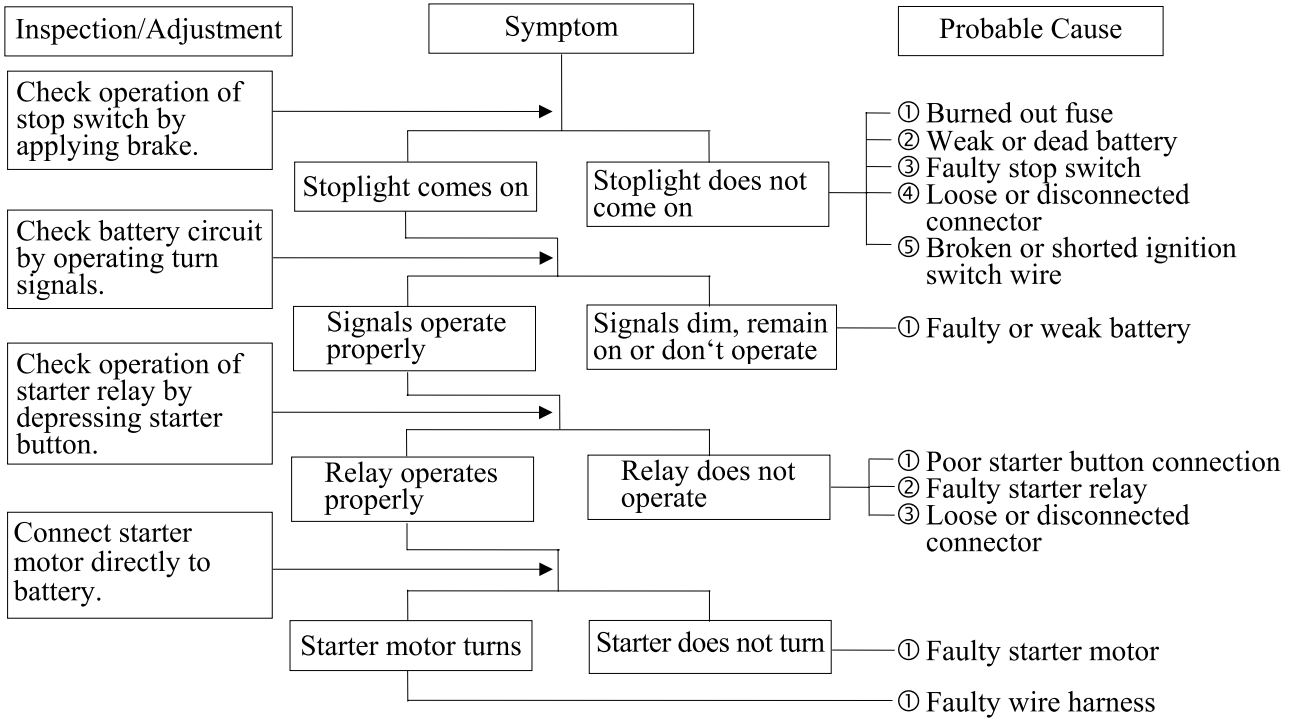

### 2. Starter motor turns slowly or idles

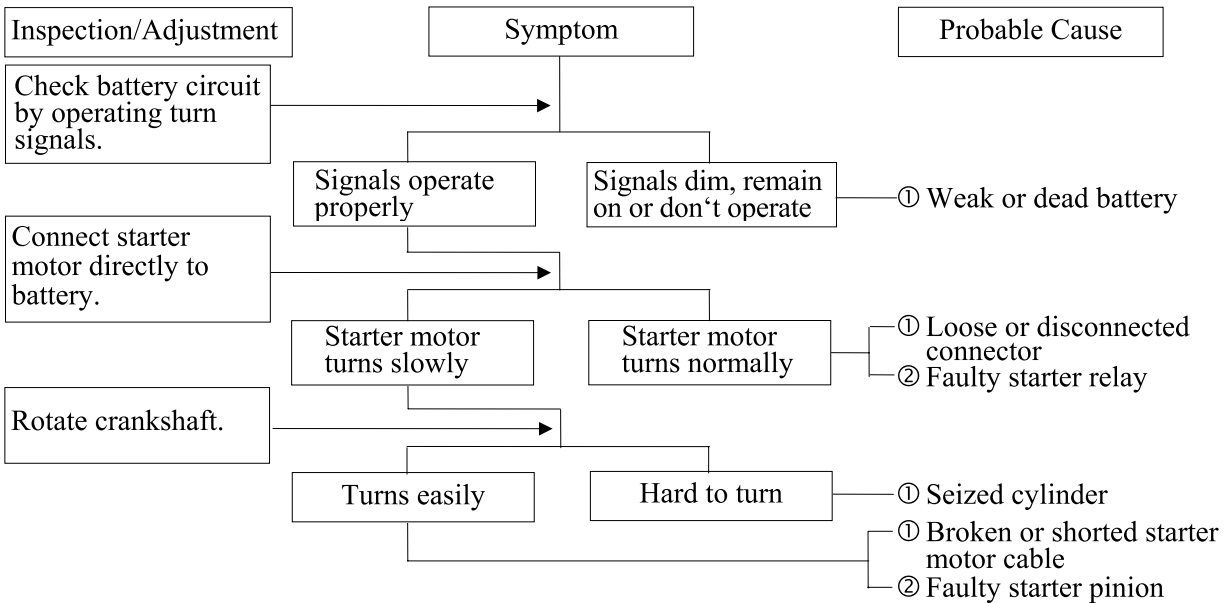

### 3. Starter motor does not stop turning

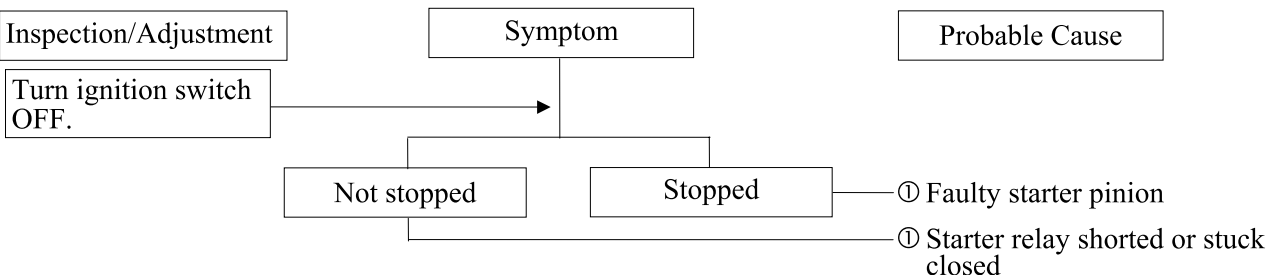

---

## **2. EXHAUST MUFFLER/FRAME COVERS**

---

**2**

---

### **EXHAUST MUFFLER/FRAME COVERS**

---

SERVICE INFORMATION-----	2- 1
TROUBLESHOOTING-----	2- 1
FRAME COVERS REMOVAL -----	2- 2
EXHAUST MUFFLER REMOVAL-----	2- 6

## 2. EXHAUST MUFFLER/FRAME COVERS

---

### SERVICE INFORMATION

#### GENERAL INSTRUCTIONS

- When removing frame covers, use care not to pull them by force because the cover joint claws may be damaged.
- Make sure to route cables and harnesses according to the Cable & Harness Routing.

#### TORQUE VALUES

Exhaust muffler lock bolt	34.3N-m
Exhaust muffler joint lock nut	11.8N-m

### TROUBLESHOOTING

#### Noisy exhaust muffler

- Damaged exhaust muffler
- Exhaust muffler joint air leaks

#### Lack of power

- Caved exhaust muffler
- Clogged exhaust muffler
- Exhaust muffler air leaks

## 2. EXHAUST MUFFLER/FRAME COVERS

### FRAME COVERS REMOVAL

#### REAR CARRIER & HAND RAIL REMOVAL

Remove the met-in box:  
First remove the two bolts and two nuts and front two screws attaching the met-in box.  
Remove the met-in box.

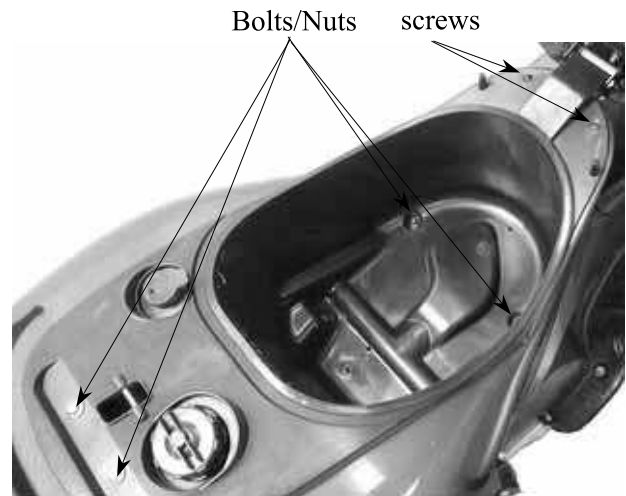

Remove the three hex bolts attaching the rear carrier.  
Remove the rear carrier and rear center cover.



Rear Center Cover

#### FRAME BODY COVER REMOVAL

Remove the four screws attaching on the bottom of the frame body cover.  
Remove the bottom cover.



Screws

## 2. EXHAUST MUFFLER/FRAME COVERS

Remove the right and left screws and bolt on the rear part of the frame body cover.  
 Disconnect the air cleaner case of the air entrance tube.  
 Remove the frame body cover.

Frame Body Cover



Air Entrance Tube

Screw

### FRONT UPPER COVER REMOVAL

Remove the two screws on the back of the front upper cover.  
 Remove the front upper cover.  
 The installation sequence is the reverse of removal.



Front Upper Cover

Screws

### FRONT LOWER COVER REMOVAL

First remove the front upper cover.  
 Remove the six screws and two bolts attaching the front lower cover.  
 Remove the six screws on the back of the front lower cover.  
 Disconnect the headlight wire connectors.  
 Remove the front lower cover.  
 The installation sequence is the reverse of removal.

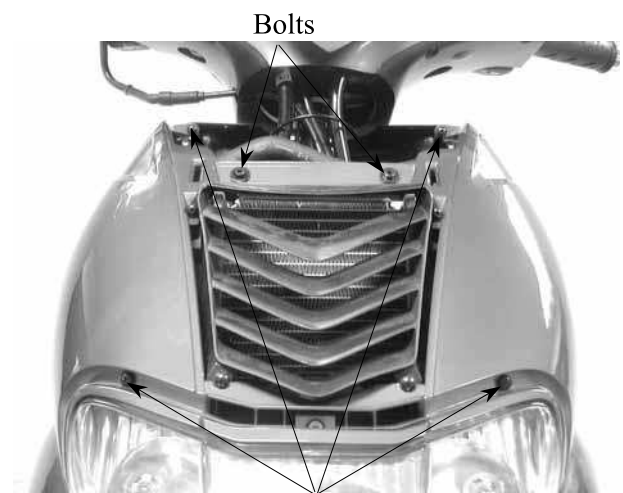

Bolts

Screws



## 2. EXHAUST MUFFLER/FRAME COVERS

### LEG SHIELD REMOVAL

Remove the front upper cover.  
Remove the front lower cover.  
Disconnect the leg shield and ignition switch cover.  
Remove the two bolts attaching the leg shield.



Remove the leg shield.  
The installation sequence is the reverse of removal.



### FRONT TOOL BOX REMOVAL

Open the front tool box and remove the bolt.  
Remove the front tool box .

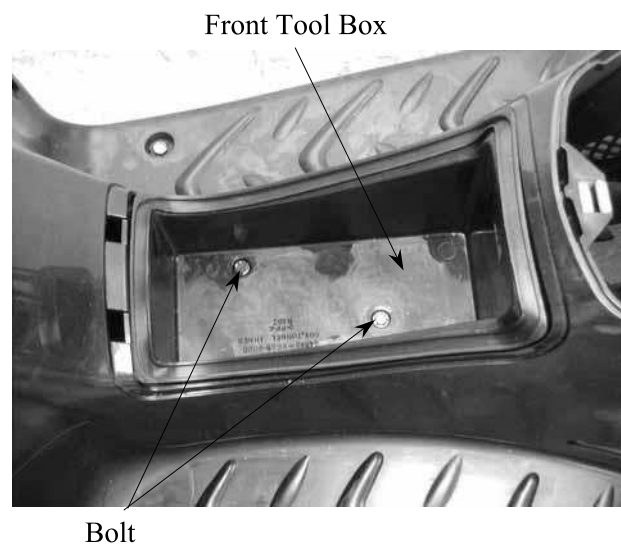

## 2. EXHAUST MUFFLER/FRAME COVERS

Remove the center cover by pulling them backward.  
Remove the center cover.



Center Cover

### **FLOOR BOARD REMOVAL**

Remove the screw and two bolts attaching the front right and left side covers. Remove the two bottom cover attaching screws.

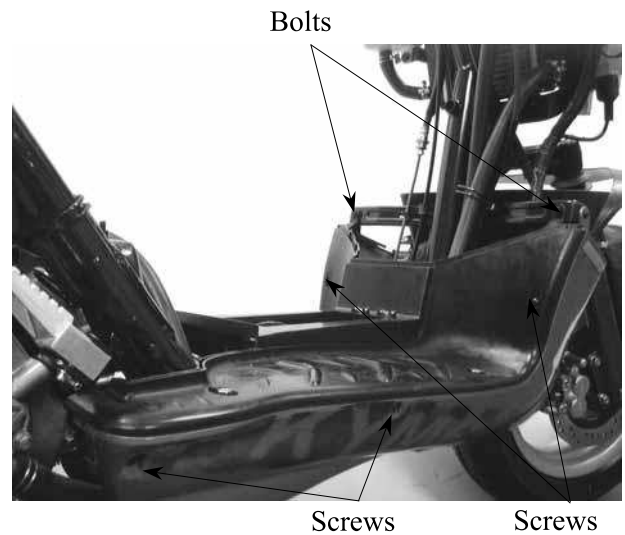

Bolts

Screws

Screws

Remove the four bolts attaching the floor board.  
Remove the floor board .  
The installation sequence is the reverse of removal.

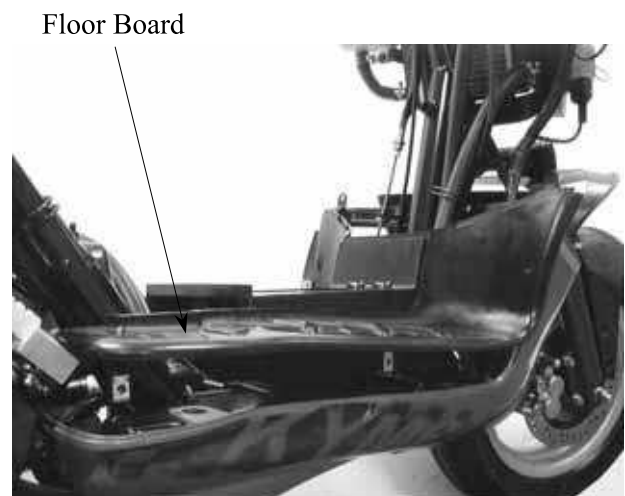

Floor Board

## 2. EXHAUST MUFFLER/FRAME COVERS

### BOTTOM COVER REMOVAL

Remove the four screws attaching the bottom cover and inner bottom cover.  
Remove the bottom cover.

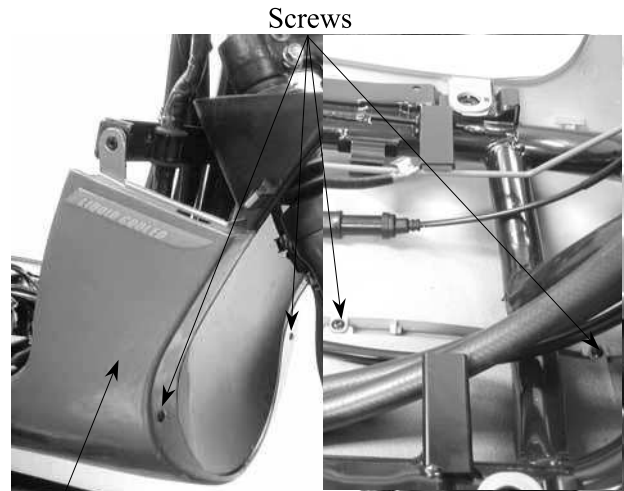

Bottom Cover

### FRONT INNER FENDER REMOVAL

Remove the front upper cover. (⇒2-3)  
Remove the front lower cover. (⇒2-3)  
Remove the leg shield and floor board.  
Remove the bottom cover.

Remove the screws which combines front fender and the front axle nut to pull out the axle.

Remove the front fender and the front wheel and the speedometer gear unit.  
Separate inner fenders.

The installation sequence is the reverse of removal.

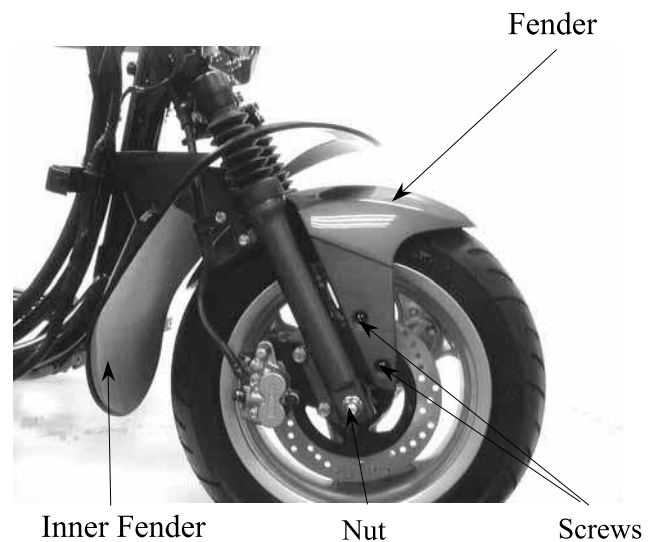

Inner Fender

Nut

Screws

### EXHAUST MUFFLER REMOVAL

Remove the two exhaust muffler joint lock nuts.  
Remove the two exhaust muffler lock bolts to remove the exhaust muffler.  
Remove the exhaust muffler joint packing collar.

The installation sequence is the reverse of removal.

#### Torque:

Exhaust muffler joint lock nut: 11.8N-m  
Exhaust muffler lock bolt: 34.3N-m



Lock Bolts

Joint Lock Nut

## 2. EXHAUST MUFFLER/FRAME COVERS

---

### HANDLEBAR COVER REMOVAL

Remove the four screws attaching the handlebar lower cover.  
Remove the handlebar lower cover.  
Remove the four screws attaching the handlebar upper cover.  
Remove the handlebar upper cover.  
The installation sequence is the reverse of removal.

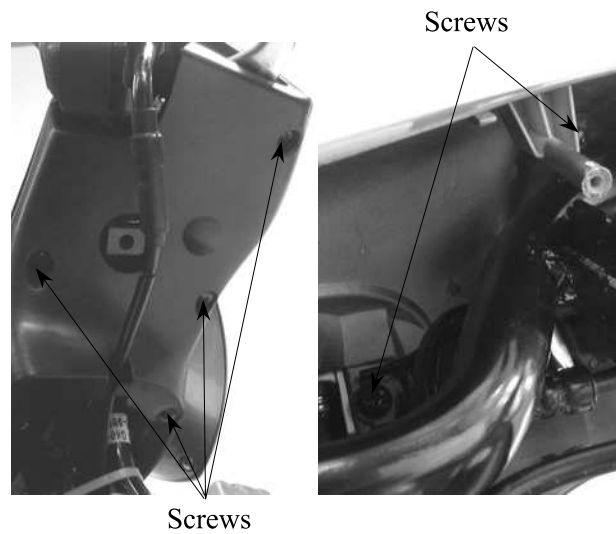

### **3. INSPECTION/ADJUSTMENT**

---



---

### **INSPECTION/ADJUSTMENT**

---

SERVICE INFORMATION-----	3- 1
INSPECTION AND MAINTENANCE SCHEDULE -----	3- 2
FUEL LINE/FUEL FILTER-----	3- 5
THROTTLE OPERATION-----	3- 5
AIR CLEANER -----	3- 6
SPARK PLUG-----	3- 7
IGNITION TIMING-----	3- 7
CYLINDER COMPRESSION -----	3- 8
FINAL REDUCTION GEAR OIL -----	3- 9
DRIVE BELT -----	3- 9
HEADLIGHT AIM -----	3-10
COOLING SYSTEM-----	3-10
BRAKE SYSTEM -----	3-11
NUTS/BOLTS/FASTENERS -----	3-13
WHEELS/TIRES -----	3-13
STEERING HANDLEBAR -----	3-13
SUSPENSION-----	3-13
LUBRICATION SYSTEM-----	3-14

### 3. INSPECTION/ADJUSTMENT

#### SERVICE INFORMATION

##### GENERAL

 <b>WARNING</b>
--

- Before running the engine, make sure that the working area is well-ventilated. Never run the engine in a closed area. The exhaust contains poisonous carbon monoxide gas which may cause death to people.
- Gasoline is extremely flammable and is explosive under some conditions. The working area must be well-ventilated and do not smoke or allow flames or sparks near the working area or fuel storage area.

##### SPECIFICATIONS

###### ENGINE

Throttle grip free play : 2~6mm  
 Spark plug : NGK: BR8HSA  
 Spark plug gap : 0.6~0.7mm  
 Idle speed : SH10DA:2000±100rpm      SF10DA:1900±100rpm

Lubrication oil capacity:	Cylinder compression : 11.8±2kg/cm <sup>2</sup>
At disassembly : 1.7 liter	Ignition timing : BTDC 13.5°±2°/2000rpm
At change : 1.4 liter	Coolant capacity : 1165cc
Gear oil capacity :	Radiator capacity : 825cc
At disassembly : 0.12 liter	Reserve tank capacity : 340cc
At change : 0.10 liter	

###### CHASSIS

Front/rear brake free play: 20~30mm

###### TIRE

	1 Rider	2 Riders
Front	1.75kg/cm <sup>2</sup>	1.75kg/cm <sup>2</sup>
Rear	2.00kg/cm <sup>2</sup>	2.25kg/cm <sup>2</sup>

###### TIRE SPECIFICATION:

Front : 120/70-12  
 Rear : 130/70-12

###### TORQUE VALUES

Front axle nut : 49.0~68.6N-m  
 Rear axle nut : 107.8~127.4N-m

### 3. INSPECTION/ADJUSTMENT

#### INSPECTION AND MAINTENANCE SCHEDULE

(Note) 1. ○ means time for inspection.

2. ☆ means regular replacement for the specified parts.

This inspection and maintenance schedule is based upon average riding conditions.

Machines subjected to serve use, or ridden in unusually dusty areas, require more frequent servicing.

Inspection & Maintenance Item			Frequency				Judgment Standards	Remarks								
			Preride	1st month	Every 6 months	Every 12 months										
Suspension	Steering handlebar	Check for looseness and vertical play				○										
		Operating performance	○			○										
		Right/left turning angle				○										
	Front fork	Damage			○	○										
		Check for front fork pivot installation			○	○		Check steering stem								
		Check front fork pivot for looseness and abnormal noise				○		Check steering stem								
Brake System	Brake Lever	Front/rear brake lever free play			○	○	Free play: 10~20mm									
		Brake lever operation	○													
		Brake performance		○	○	○										
	Lever/Cable	Looseness, abnormal noise and damage		○		○										
	Brake disk/lining(Brake drum/shoe)	Disk-to-lining clearance			○	○										
		Brake disk(shoe) and lining wear				☆										
		Brake drum wear and damage				○	Standard: Rear : 110 mm Service Limits: Rear : 111 mm									
Moving Device	Tire	Tire pressure	○		○	○	<table border="1" style="width: 100%; border-collapse: collapse;"> <thead> <tr> <th></th> <th>Front</th> <th>Rear</th> </tr> </thead> <tbody> <tr> <td>1 rider</td> <td>1.75 kg/cm<sup>2</sup></td> <td>2.25 kg/cm<sup>2</sup></td> </tr> <tr> <td>Tire Size</td> <td>120/70-12</td> <td>130/70-12</td> </tr> </tbody> </table>		Front	Rear	1 rider	1.75 kg/cm <sup>2</sup>	2.25 kg/cm <sup>2</sup>	Tire Size	120/70-12	130/70-12
	Front	Rear														
1 rider	1.75 kg/cm <sup>2</sup>	2.25 kg/cm <sup>2</sup>														
Tire Size	120/70-12	130/70-12														

### 3. INSPECTION/ADJUSTMENT

Inspection & Maintenance Item			Frequency				Judgment Standards	Remarks
			Preride	1st month	Every 6 months	Every 12 months		
Moving Device	Motor-cycle	Tire crack and damage	<input type="radio"/>		<input type="radio"/>	<input type="radio"/>		
		Tire groove and abnormal wear	<input type="radio"/>		<input type="radio"/>	<input type="radio"/>	Groove Depth: Front: 0.8mm Rear : 0.8mm	
		Imbedded objects, gravel, etc.	<input type="radio"/>		<input type="radio"/>	<input type="radio"/>		
		Axle nut looseness			<input type="radio"/>	<input type="radio"/>	Torque Values: Front axle nut 49.0~68.6N-m Rear axle nut 107.8~127.4N-m	Axle nut torque
		Check wheel rim, rim edge and spoke plate for damage		<input type="radio"/>		<input type="radio"/>	Rim runout at rim end: Front: Axial 2.0mm Radial 2.0mm Rear: Axial 2.0mm Radial 2.0mm	
		Check front wheel bearing for excessive play and abnormal noise				<input type="radio"/>		
		Check front wheel bearing for excessive play and abnormal noise				<input type="radio"/>		
Damping Device	Frame Spring	Damage					Shock spring free length	
	Suspension arm	Connecting parts looseness and arm damage				<input type="radio"/>		
	Shock absorber	Oil leakage and damage				<input type="radio"/>		
		Assembly parts looseness abnormal noise				<input type="radio"/>		
Power Drive System	Clutch	Operation		<input type="radio"/>	<input type="radio"/>	<input type="radio"/>		
	Transmission case	Oil leakage and oil level			<input type="radio"/>	<input type="radio"/>	Oil level: Oil check bolt hole at lower hole edge	Rear wheel transmission case
Electrical Equipment	Ignition device	Spark plug condition			<input type="radio"/>	<input type="radio"/>	Plug gap: 0.6~0.7mm	
	Battery	Terminal connection				<input type="radio"/>		
	Wires	Loose connection and damage				<input type="radio"/>		



### 3. INSPECTION/ADJUSTMENT

Inspection & Maintenance Item			Frequency				Judgment Standards	Remarks
			Preride	1st month	Every 6 months	Every 12 months		
Engine	Body	Performance and abnormal noise			○	○		
		Conditions at low and high speeds		○	○	○		
		Exhaust smoke			○	○		
		Air cleaner			○	○		
	Lubrication system	Oil quality and quantity			○	○	<input type="checkbox"/> Oil level indicator Indicator light comes on when oil is insufficient	
		Oil leakage			○	○		
		Oil level	○					
		Check oil filter for clogging				○		
	Fuel System	Fuel leakage						
		Carburetor, throttle valve and auto bystarter				○		
		Check fuel filter for clogging				○		
		Fuel level	○					
		Fuel tube replacement					☆Every 4 years	
	Lights & Winker	Operation						
Winking action, dirt and damage		○						
Buzzer & Steering Lock	Operation				○			
Rearview Mirror & Reflector	Rearview mirror position	○					Rearview Mirror	
Reflector & License Plate	Dirt and damage	○						
Counter	Operation				○			
Exhaust Muffler	Joint looseness and damage				○			
	Exhaust muffler performance				○			
Body & Frame	Looseness and damage				○			
Abnormal Conditions Happened Last Time	Check if the abnormal conditions occur again	○						
Others	Lubrication points			○	○			
	Remove carbon deposits on combustion chamber, breather hole and exhaust muffler				○			

### 3. INSPECTION/ADJUSTMENT

#### FUEL LINE/FUEL FILTER

Remove the center cover.

Check the fuel lines and replace any parts which show signs of deterioration, damage or leakage.

Check for dirty or clogged fuel filter and replace with a new one if it is clogged.

- \* • Do not smoke or allow flames or sparks in your working area.



Fuel Filter

Fuel Line

#### THROTTLE OPERATION

Check the throttle grip for smooth movement.  
Measure the throttle grip free play.

**Free Play:** 2~6mm



Major adjustment of the throttle grip free play is made with the adjusting nut at the carburetor side. Adjust by loosening the lock nut and turning the adjusting nut.

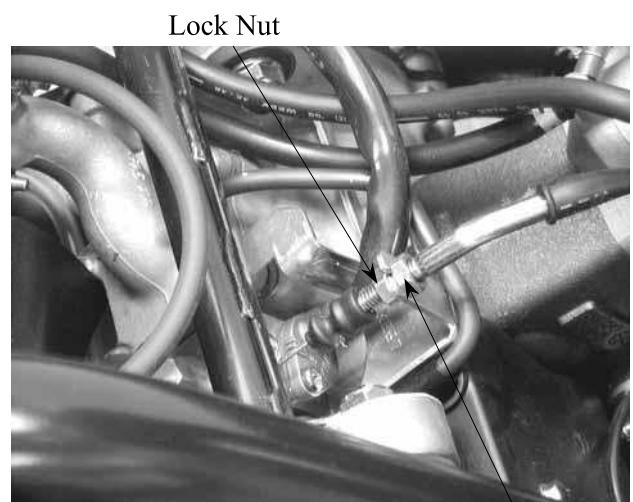

Lock Nut

Adjusting Nut

### 3. INSPECTION/ADJUSTMENT

Minor adjustment is made with the adjusting nut at the throttle grip side. Slide the rubber cover out and adjust by loosening the lock nut and turning the adjusting nut.



Adjusting Nut

Lock Nut

#### AIR CLEANER

Remove the seven air cleaner case cover screws and the cover.

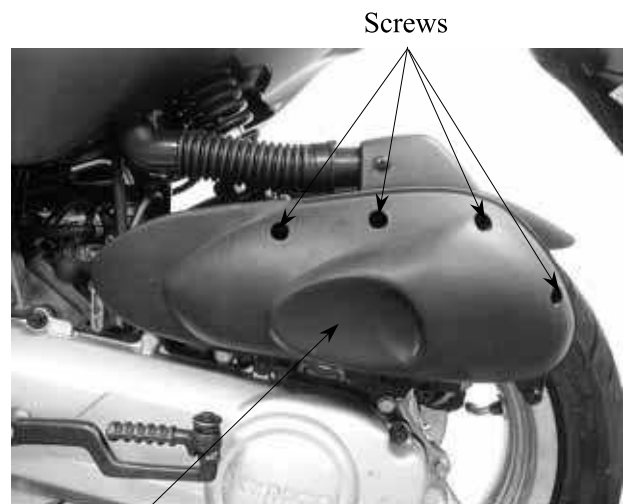

Screws

Air Cleaner Case Cover

Remove the air cleaner element. Check the element and replace it if it is excessively dirty or damaged.

#### CHANGE INTERVAL

More frequent replacement is required when riding in unusually dusty or rainy areas.

- \*
- The air cleaner element has a viscous type paper element. Do not clean it with compressed air.
  - Be sure to install the air cleaner element and cover securely.



Air Cleaner Element

### 3. INSPECTION/ADJUSTMENT

#### SPARK PLUG

Remove the frame center cover.  
 Remove the spark plug cap and spark plug.  
 Check the spark plug for wear and fouling deposits.  
 Clean any fouling deposits with a spark plug cleaner or a wire brush.



Spark Plug

**Specified Spark Plug:** NGK: BR8HSA

Measure the spark plug gap.

**Spark Plug Gap:** 0.6~0.7mm

- \*
  - When installing, first screw in the spark plug by hand and then tighten it with a spark plug wrench.

**Torque:** 7.8~9.8N-m

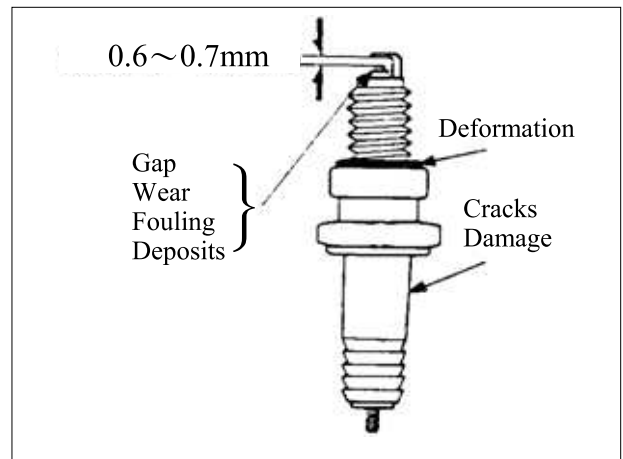

#### IGNITION TIMING

- \*
  - The CDI unit is not adjustable.
  - If the ignition timing is incorrect, check the ignition system,

Remove the two timing cap bolts and the timing cap.

Timing Cap



### 3. INSPECTION/ADJUSTMENT

Check the ignition timing with a timing light. When the engine is running at the specified idle speed, the ignition timing is correct if the “F” mark on the flywheel aligns with the index mark on the crankcase cover. Also use a timing light to check the advance. Raise the engine speed to 4,000rpm. The index mark should be between the advance marks.



Timing Light

#### CYLINDER COMPRESSION

Warm up the engine before compression test. Remove the center cover and spark plug cap. Remove the spark plug. Insert a compression gauge. Open the throttle valve fully and push the starter button to test the compression.

**Compression:**  $11.8 \pm 2 \text{kg/cm}^2$

If the compression is low, check for the following:

- Leaky valves
- Valve clearance too small
- Leaking cylinder head gasket
- Worn pistons
- Worn piston/cylinder

If the compression is high, it indicates that carbon deposits have accumulated on the combustion chamber and the piston head.



Compression Gauge

### 3. INSPECTION/ADJUSTMENT

#### FINAL REDUCTION GEAR OIL

- \* • Place the motorcycle on its main stand on level ground.

Stop the engine and remove the oil check bolt.

The oil level shall be at the oil check bolt hole.

If the oil level is low, add the recommended oil SAE90# to the proper level.

Install the oil check bolt.

- \* • Make sure that the sealing washer is in good condition.

Oil Check Bolt Hole/Oil Filler



#### OIL CHANGE

Remove the oil check bolt.

Remove the oil drain bolt and drain the oil thoroughly.

Install the oil drain bolt.

**Torque:** 9.8N-m

- \* • Make sure that the sealing washer is in good condition.

Fill the final reduction with the recommended oil SAE90#.

#### Gear Oil Capacity:

At disassembly : 120cc

At change : 100cc

Reinstall the oil check bolt and check for oil leaks.



Oil Drain Bolt/Sealing Washer

#### DRIVE BELT

Remove the left crankcase cover.

Inspect the drive belt for cracks or excessive wear.

Replace the drive belt with a new one if necessary and in accordance with the Maintenance Schedule.



Drive Belt

### 3. INSPECTION/ADJUSTMENT

#### HEADLIGHT AIM

Turn the ignition switch ON.  
Turn on the headlight switch.  
Adjust the headlight aim by turning the headlight aim adjusting bolt.



Headlight Aim Adjusting Bolt

#### COOLING SYSTEM

##### COOLANT LEVEL INSPECTION

Place the motorcycle on its main stand on level ground.

Check the coolant level of the reserve tank and the level should be between the upper and lower level lines.

If necessary, fill the reserve tank with recommended coolant to the "F" level line.

**Recommended Coolant:** SIGMA Coolant  
(Standard Concentration 30%)

- \* • The coolant level does not change no matter the engine is warm or cold. Fill to the "F" (upper) line.

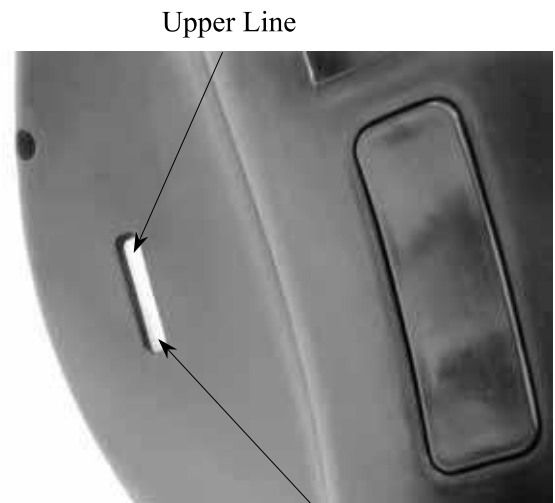

Upper Line

Lower Line

##### COOLANT REPLACEMENT

- \* • Perform this operation when the engine is cold.

Remove the front cover.

Remove the reserve cap.

Remove the drain hoses to drain the coolant and tilt the motorcycle to the right and the coolant will drain more easily.

Drain the coolant in the reserve tank.

Reinstall the drain hoses.

Fill the radiator with the specified coolant.

- \* • The coolant freezing point should be 5 °C lower than the temperature of the riding area.



Reserve Cap

Reserve Tank

### 3. INSPECTION/ADJUSTMENT

Coolant capacity : 1165cc

Radiator capacity : 825cc

Reserve tank capacity :340cc

Start the engine and check if there is no bubbles in the coolant and the coolant level is stable. Reinstall the radiator cap.

If there are bubbles in the coolant, bleed air from the system.

Fill the reserve tank with the recommended coolant up to the upper line.



#### **BRAKE SYSTEM**

##### **BRAKE LEVER**

Measure the front and rear brake lever free plays.

**Free Play:** 10~20mm

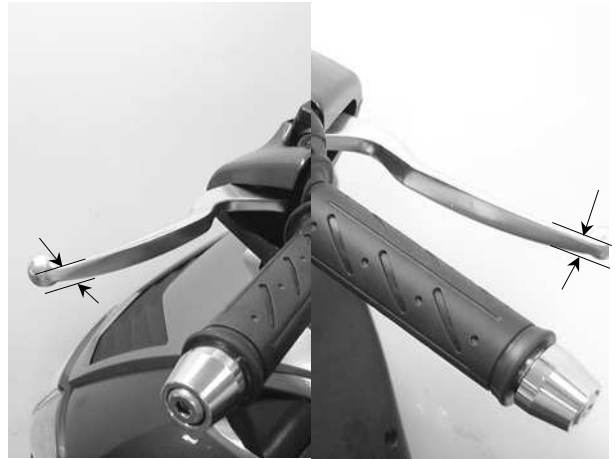

If the free plays do not fall within the limits, turn the right and left adjusting nuts for adjustment.

“△” Marks

<Rear>



Adjusting Nuts



### 3. INSPECTION/ADJUSTMENT

#### BRAKE FLUID

Turn the steering handlebar upright and check if the front/rear brake fluid level is at the upper limit. If the brake fluid is insufficient, fill to the upper limit.

**Specified Brake Fluid:** DOT-4

- \* • The brake fluid level will decrease if the brake pads are worn.

Front Brake Reservoir

Rear Brake Reservoir



#### BRAKE DISK/BRAKE PAD

Check the brake disk surface for scratches, unevenness or abnormal wear. Check if the brake disk runout is within the specified service limit. Check if the brake pad wear exceeds the wear indicator line.

- \* • Keep grease or oil off the brake disk to avoid brake failure.



Wear Indicator Line

Brake Disk

#### BRAKE DRUM/SHOE

##### 《 Brake Shoe Wear 》

Replace the brake shoes if the arrow on the brake arm aligns with reference mark“△” on the brake panel when the brake is fully applied.

##### 《 Brake Drum Wear/Damage 》

Check the brake drum appearance for damage. Check if the brake lining wear is within the specified service limit.

Check the brake operation for abnormal noise and brake drum inside for wear or damage.

Adjusting Nuts



“△” Marks

<Rear>

### 3. INSPECTION/ADJUSTMENT

#### NUTS/BOLTS/FASTENERS

Check all important chassis nuts and bolts for looseness.

Tighten them to their specified torque values if any looseness is found.

#### WHEELS/TIRES

Check the tires for cuts, imbedded nails or other damages.

Check the tire pressure.

- \* • Tire pressure should be checked when tires are cold.



Pressure Gauge

Tire Pressure

	1 Rider	2 Riders
Front	1.75kg/cm <sup>2</sup>	1.75kg/cm <sup>2</sup>
Rear	2.00kg/cm <sup>2</sup>	2.25kg/cm <sup>2</sup>

#### STEERING HANDLEBAR

Raise the front wheel off the ground and check that the steering handlebar rotates freely.

If the handlebar moves unevenly, binds, or has vertical movement, adjust the steering head bearing.



#### SUSPENSION

Check the action of the front/rear shock absorbers by compressing them several times. Check the entire shock absorber assembly for oil leaks, looseness or damage.

Jack the rear wheel off the ground and move the rear wheel sideways with force to see if the engine hanger bushings are worn. Replace the engine hanger bushings if there is any looseness.



### 3. INSPECTION/ADJUSTMENT

#### LUBRICATION SYSTEM

##### 《Oil Filter Cleaning》

Disconnect the oil tube at the oil pump side and allow oil to drain into a clean container. Remove the tube clip at the oil tank side and disconnect the oil tube. Remove the oil filter.

Clean the oil filter screen with compressed air.

Install the oil filter in the reverse order of removal and fill the oil tank with specified oil up to the proper level.

Bleed air from the oil pump and oil lines.

\*

- Connect the oil tubes securely.
- Install the tube clip at the oil tank side and also install the clip to the lower oil tube that goes to the oil pump.
- Check for oil leaks.

##### 《Oil Pump Condition》

\*

Adjust oil pump control cable after the throttle grip free play is adjusted.

Open the throttle valve fully and check that the index mark on the pump body aligns with the aligning mark on the oil pump control lever.

Reference tip alignment within 1mm of index mark on open side is acceptable.

Start and idle the engine, then slowly open the throttle to increase engine rpm and check the operation of the oil pump control lever.

If adjustment is necessary, adjust the oil pump control cable by loosening the control cable lock nut and turning the adjusting nut. After adjustment, tighten the lock nut.

\*

Reference tip alignment within 1mm of index mark on open side is acceptable. However, the aligning mark on the control lever must never be on the closed side of the index mark, otherwise engine damage will occur because of insufficient lubrication.

If the oil pump is not synchronized properly, the following will occur:

- Excessive white smoke or hard starting due to pump control lever excessively open
- Seized piston due to pump control lever insufficiently open



Oil Filter

Clip

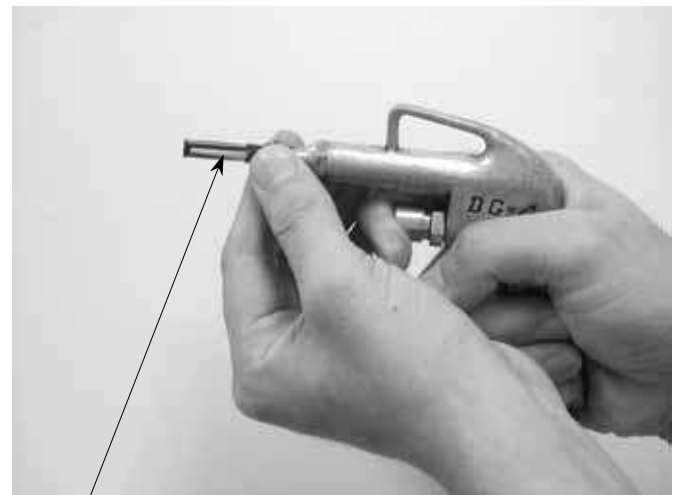

Filter Screen

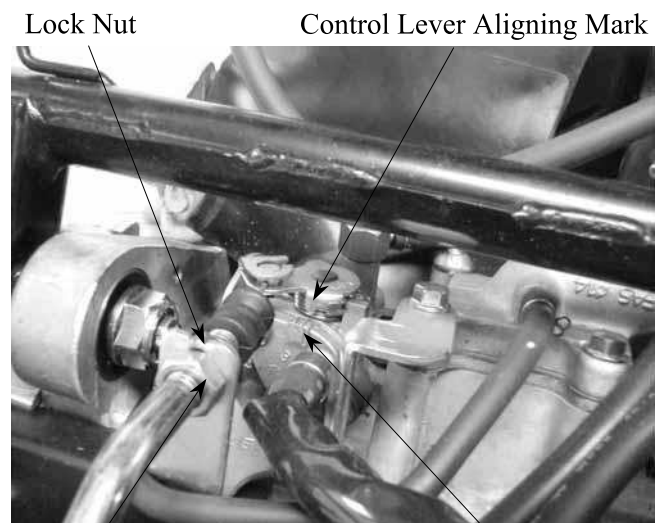

Adjusting Nut

Pump Body Index Mark



## 4. LUBRICATION SYSTEM

---

### SERVICE INFORMATION

#### GENERAL INSTRUCTIONS

- Use care when removing and installing the oil pump not to allow dust and dirt to enter the engine and oil line.
- Do not attempt to disassemble the oil pump.
- Bleed air from the oil pump if there is air between the oil pump and oil line.
- If the oil is disconnected, refill the oil line with motor oil before connecting it.

#### SPECIFICATIONS

- Recommended Motor Oil: SAE20W20# 2-stroke Motor Oil
- Oil Capacity : 1.7 liter  
Light comes on : 0.3 liter

### TROUBLESHOOTING

#### Excessive white smoke or carbon deposits on spark plug

- Oil pump not properly synchronized (excessive oil)
- Poor quality oil

#### Engine overheating

- Oil pump not properly adjusted (insufficient oiling)
- Poor quality oil

#### Seized piston

- No oil in tank or clogged oil line
- Oil pump not properly adjusted (insufficient oiling)
- Air in oil line
- Faulty oil pump

#### Oil not flowing out of tank to engine

- Clogged oil tank cap breather hole
- Clogged oil filter

## 4. LUBRICATION SYSTEM

### OIL PUMP REMOVAL

Do not allow foreign matters to enter the crankcase. Before removing the oil pump, clean the oil pump and crankcase surfaces.

Remove the met-in box. (⇒2-2)

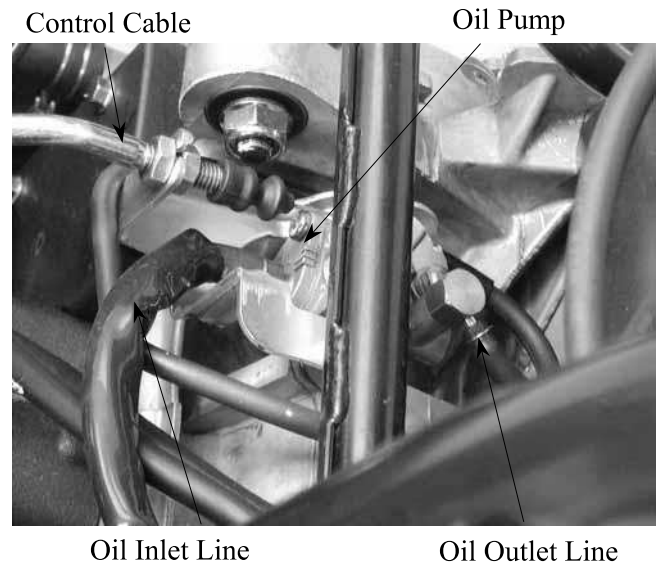

Disconnect the oil pump control cable from the pump body.  
Disconnect the oil inlet line from the oil pump.  
Then, disconnect the oil outlet line.

Before disconnecting the oil line, clip the oil line to avoid oil flowing out and then plug the oil line after it is disconnected.

Remove the oil pump control cable plate bolt and copper washer.  
Remove the oil pump from the crankcase.

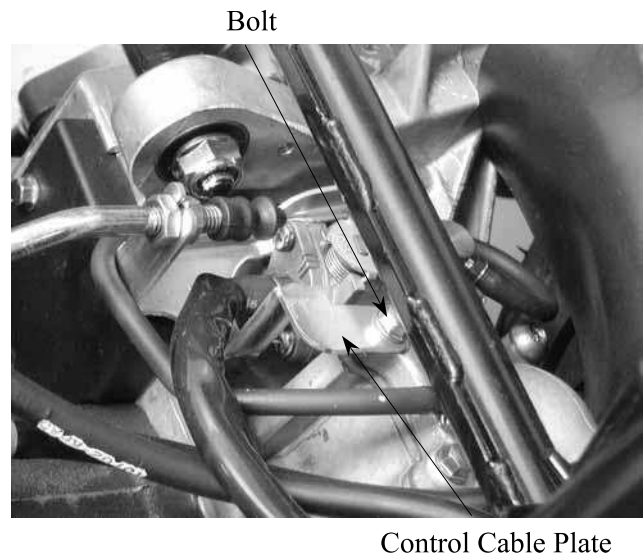

### OIL PUMP INSPECTION

Remove the oil pump and inspect the following items:

- Weakened O-ring
- Damage to crankcase mating surface
- Damage to pump body
- Control lever operation
- Oil leaks through oil seals
- Worn or damaged pump pinion

Do not disassemble the oil pump which cannot be used after disassembly.

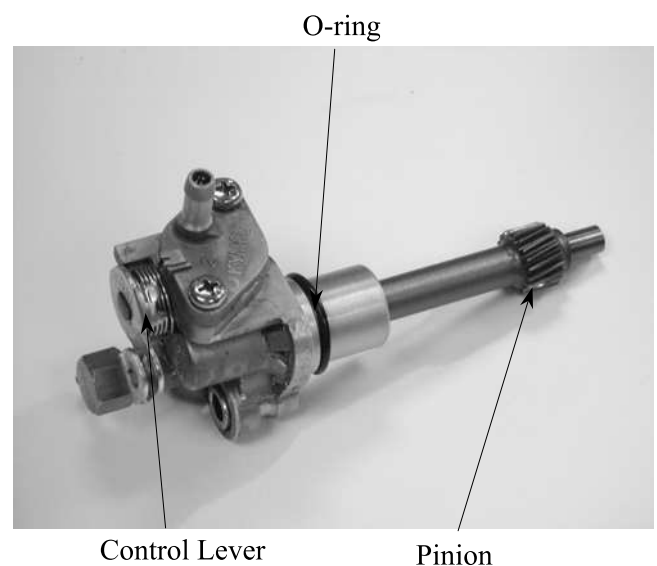

# 4. LUBRICATION SYSTEM

## OIL PUMP INSTALLATION

- Lubricate the O-ring with grease or engine oil before installation.
- Make sure that the oil pump is inserted into the crankcase.
- Apply molybdenum disulfide or grease to the pump pinion.



Grease or Engine Oil

Install the oil pump onto the crankcase.

Control Cable Plate

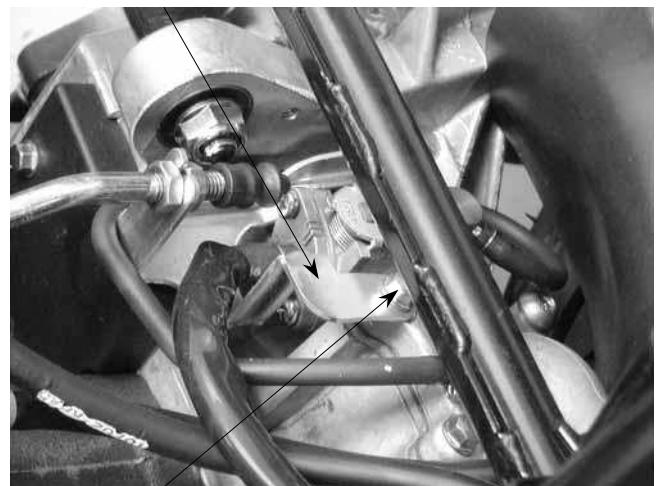

Bolt

Install the oil pump control cable plate.  
 Connect the oil inlet line and oil outlet line properly.  
 Connect the oil pump control cable.  
 Bleed air from the oil pump.

Control Cable



Oil Outlet Line

## 4. LUBRICATION SYSTEM

### OIL PUMP BLEEDING

- Air in the oil lines will block oil flow and result in severe engine damage.
- Bleed air from the oil lines and oil pump whenever the oil lines or pump have been removed or there is air in the oil lines.

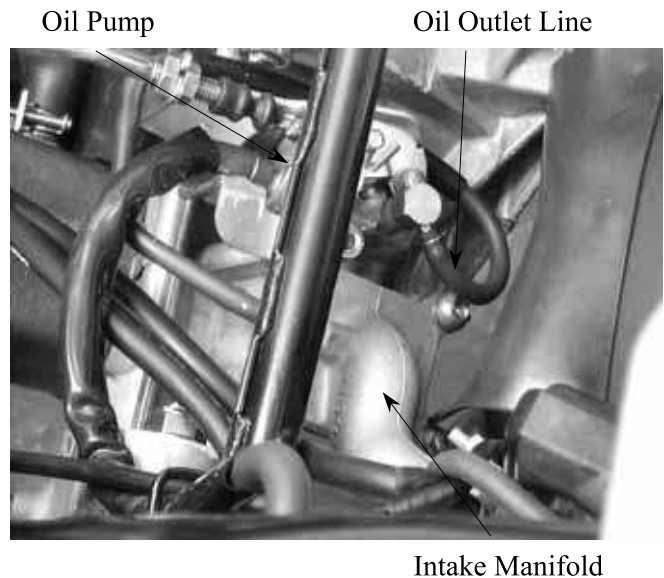

Intake Manifold

### OIL INLET LINE/OIL PUMP BLEEDING

Fill the oil tank with recommended oil. Place a shop towel around the oil pump. Disconnect the oil inlet line from the oil pump and clip it. Fill the oil pump with oil by squirting clean oil through the joint. (About 3cc) Fill the oil line with oil and connect it to the oil pump.

Bleed air from the oil inlet line first, then bleed air from the oil outlet line.

### OIL OUTLET LINE BLEEDING

1. Disconnect the oil outlet line and bend it into U shape. Force air out of the tube by filling it with oil.
2. Start the engine and allow it to idle with the oil control lever in the fully open position. Visually check the oil flow.
3. If there is no oil flowing out within 1 minute, bleed air from the oil inlet line and oil pump.

- Never run the engine in a closed area.
- Do not increase the engine speed at will.

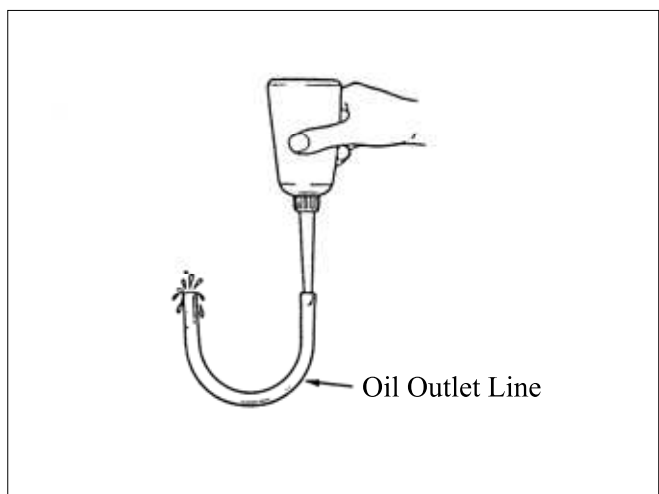



## 4. LUBRICATION SYSTEM

### OIL TANK

#### OIL TANK REMOVAL

Remove the seat and met-in box. (⇒2-2)  
 Remove the battery.  
 Remove the battery cover screw and the battery cover.  
 Remove the oil meter connector.  
 Remove the two bolts attaching the oil tank.  
 Disconnect the oil inlet line.  
 Drain the oil inside the oil tank into a clean container.  
 Remove the oil tank.  
 The installation sequence is the reverse of removal.

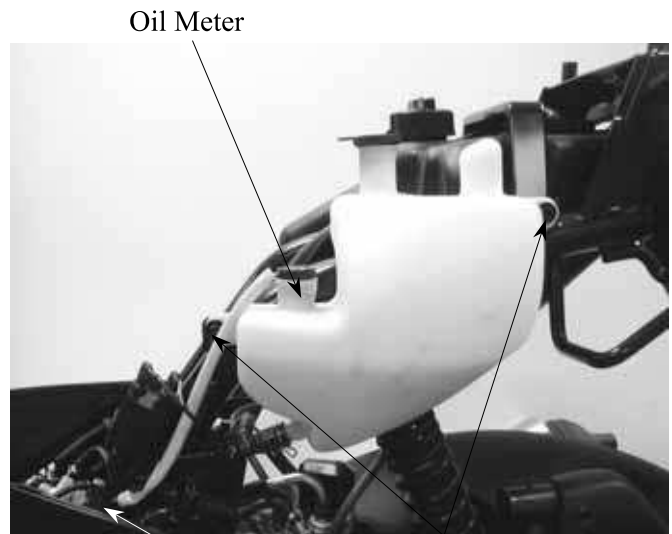

Wire Connector

Bolts

- Connect the oil line properly.
- Bleed air from the oil pump after installation.
- The oil tube clip (at the oil tank side) must be locked from inside of the oil tube joint.

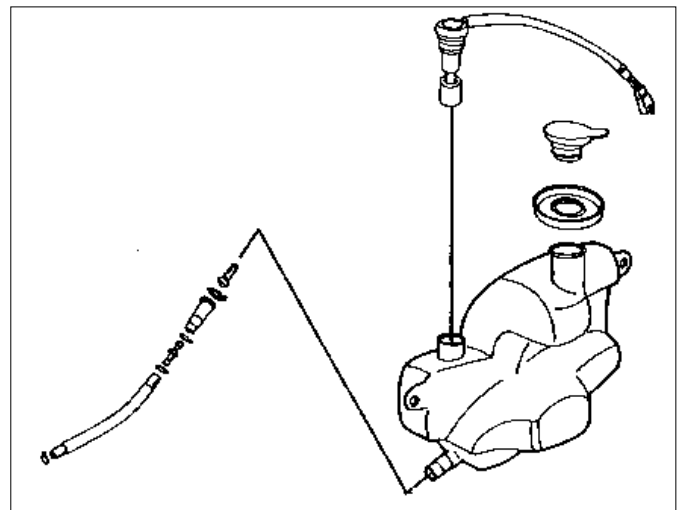

---

# 5. ENGINE REMOVAL/INSTALLATION

---

---

---

---

---

---

---



---

## ENGINE REMOVAL/INSTALLATION

---

SERVICE INFORMATION .....	5-1
ENGINE REMOVAL .....	5-2
ENGINE INSTALLATION .....	5-4

## **5. ENGINE REMOVAL/INSTALLATION**

### **SERVICE INFORMATION**

#### **GENERAL INSTRUCTIONS**

- Parts requiring engine removal for servicing:
  - Crankcase
  - Crankshaft

#### **TORQUE VALUES**

Engine mounting bolt	44.1 ~ 53.9N-m
Engine hanger bracket bolt	44.1 ~ 53.9N-m
Rear shock absorber lower mount bolt	23.5 ~ 29.4N-m
Rear shock absorber upper mount bolt	34.3 ~ 44.1N-m

# 5. ENGINE REMOVAL/INSTALLATION

## ENGINE REMOVAL

Remove the frame body cover. (⇒2-2)  
 Remove the brake fluid tube bolt of the rear brake caliper.  
 Remove the rear brake caliper bolt and the rear brake caliper.



Rear Brake Caliper Bolt Clamp

Disconnect the oil pump control cable from the pump body.  
 Disconnect the oil inlet line from the oil pump.

\* After the oil inlet line is disconnected, plug the oil line opening to prevent oil from flowing out.

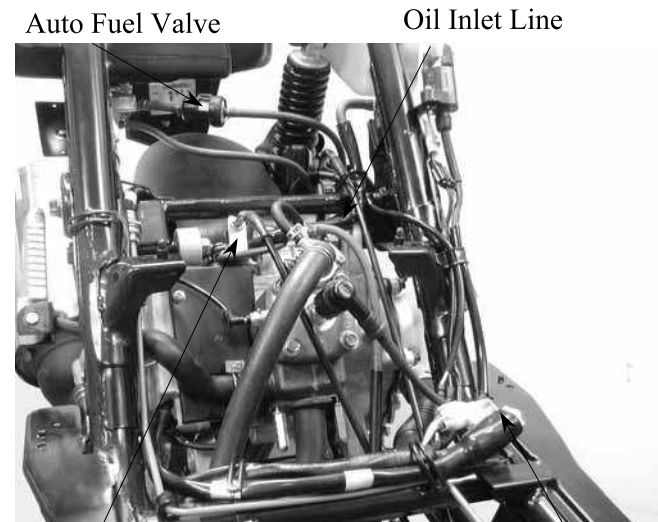

Auto Fuel Valve Oil Inlet Line  
 Oil Pump Control Cable AC Generator Wire Connector

Disconnect the auto bystarter, A.C. generator, thermosensor wire couplers and starter motor wire connectors.  
 Disconnect the fuel tube and vacuum tube that go to the carburetor from the auto fuel valve.

Remove the spark plug cap.  
 Drain the coolant. (⇒3-10)  
 Disconnect the water hose.

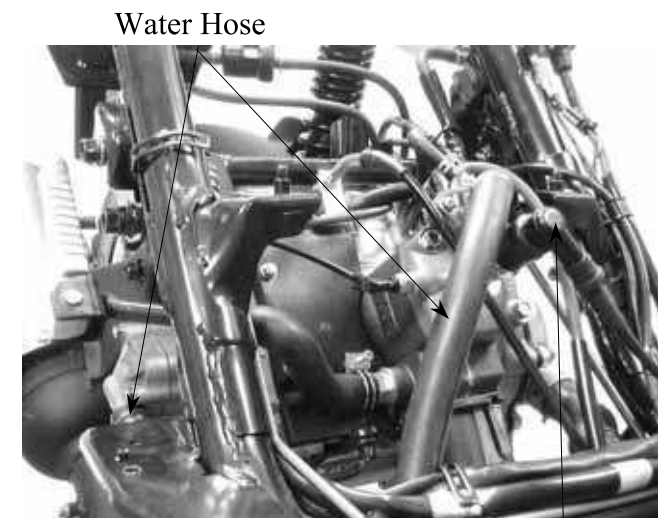

Water Hose Spark Plug Cap

## 5. ENGINE REMOVAL/INSTALLATION

Remove the two bolts attaching the air cleaner case.  
 Loosen the band between the air cleaner and carburetor to remove the air cleaner case.  
 Remove the carburetor cap.  
 Remove the rear shock absorber lower mount bolt.

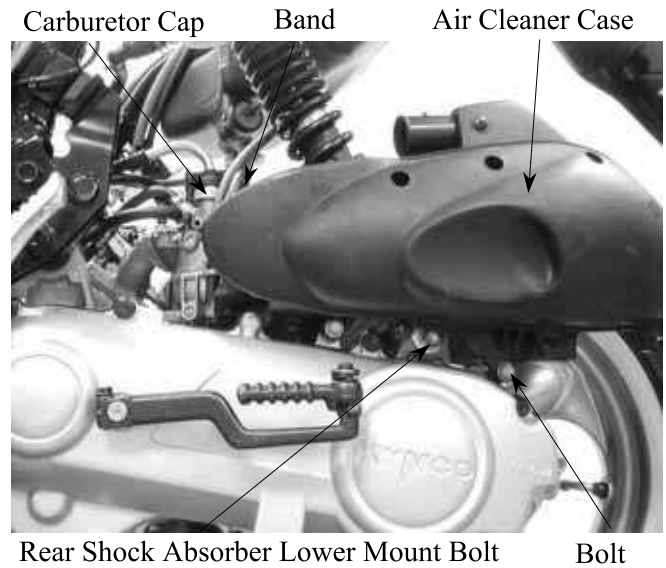

Remove the right and left engine mounting nuts.  
 Take out the right and left engine mounting bolts.  
 Lift the frame upward to separate it from the engine and be careful not to damage .



### ENGINE HANGER BRACKET REMOVAL

Remove the engine hanger bracket bolt and engine hanger bracket.  
 The installation sequence is the reserve of removal.

**Torque:**44.1 ~ 53.9N·m

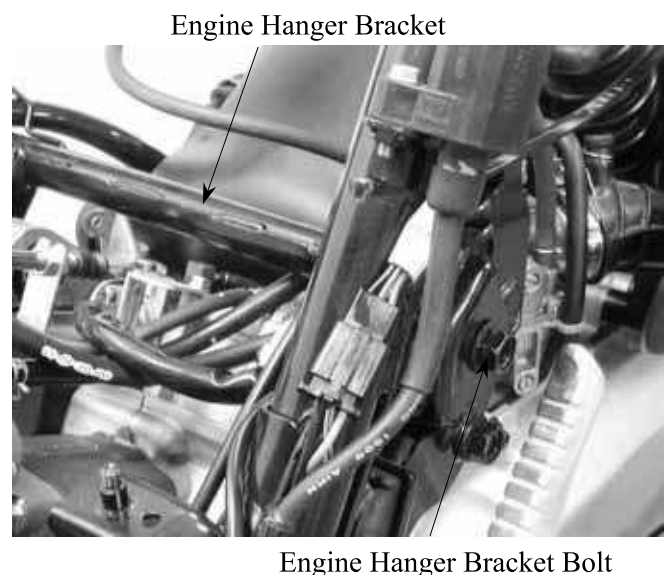

## 5. ENGINE REMOVAL/INSTALLATION

### ENGINE HANGER BRACKET INSPECTION

Inspect the stopper rubbers and bushings for damage and replace with new ones if necessary.

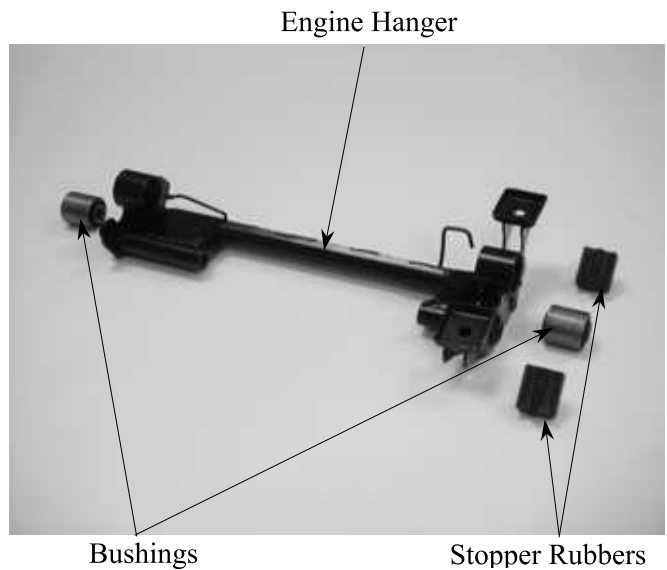

### ENGINE INSTALLATION

Install the engine in the reverse order of removal.

Cables and wires should be routed properly.

#### Torque Values:

Engine mounting bolt : 44.1 ~ 53.9N-m

Rear shock absorber lower mount bolt:  
: 23.5 ~ 29.4N-m



Perform the following inspections and adjustments after installation.

- Throttle cable
- Oil pump control cable (⇒4-2)
- Rear brake system (⇒3-11)
- Oil pump bleeding (⇒4-4)



---

**6. CYLINDER HEAD/CYLINDER/PISTON**

---

---

**CYLINDER HEAD/CYLINDER/PISTON**

---



SERVICE INFORMATION .....	6-1
TROUBLESHOOTING .....	6-1
CYLINDER HEAD .....	6-2
CYLINDER/PISTON .....	6-6

## 6. CYLINDER HEAD/CYLINDER/PISTON

### SERVICE INFORMATION

#### GENERAL INSTRUCTIONS

- The cylinder head, cylinder and piston can be serviced with the engine installed in the frame.
- Before disassembly, clean the engine to prevent dust from entering the engine.
- Remove all gasket material from the mating surfaces.
- Do not use a driver to pry between the cylinder and cylinder head, cylinder and crankcase.
- Do not damage the cylinder inside and the piston surface.
- After disassembly, clean the removed parts before inspection. When assembling, apply the specified engine oil to movable parts.

#### SPECIFICATIONS

Item	Standard (mm)		Service Limit (mm)	
	SH10DA	SF10DA	SH10DA	SF10DA
Cylinder head warpage	—		0.10	
Piston O.D.(5mm from bottom of piston)	38.970~38.955		38.90	
Cylinder-to- piston clearance	0.03~0.07		0.10	
Piston pin hole I.D.	12.002~12.008		12.03	
Piston pin O.D.	11.994~12.0		11.98	
Piston-to-piston pin clearance	0.002~0.014		0.03	
Piston ring end gap (top/second)	0.10~0.25		0.40	
Connecting rod small end I.D.	17.005~17.017		17.03	
Cylinder bore	39.0~39.025		39.05	

#### TORQUE VALUES

Cylinder head bolt	14.7~16.66N-m
Exhaust muffler joint lock nut	9.8~13.72N-m
Exhaust muffler lock bolt	29.4~35.28N-m
Spark plug	10.78~16.66N-m

#### TROUBLESHOOTING

##### Compression too low, hard starting or poor performance at low speed

- Leaking cylinder head gasket
- Loose spark plug
- Worn, stuck or broken piston and piston rings
- Worn or damaged cylinder and piston

##### Compression too high, overheating or knocking

- Excessive carbon build-up in cylinder head or on piston head

##### Abnormal noisy piston

- Worn cylinder and piston
- Worn piston pin or piston pin hole
- Worn connecting rod small end bearing

##### Abnormal noisy piston rings

- Worn, stuck or broken piston rings
- Worn or damaged cylinder



# 6. CYLINDER HEAD/CYLINDER/PISTON

## CYLINDER HEAD

### REMOVAL < SH10AD >

Remove the rear carrier.  
 Remove the frame body cover. (⇒2-2)  
 Drain the coolant.  
 Disconnect the thermosensor wire from the thermosensor.  
 Disconnect the water hose from the thermostat housing.

Spark Plug Cap



Remove the spark plug cap.  
 Remove the two joint lock nuts on the front of the exhaust muffler and then remove the two exhaust muffler lock bolts.  
 The installation sequence is the reverse of removal.

\* When installing the exhaust muffler, first tighten the two nuts on the front and then tighten the two bolts.

Exhaust muffler joint lock nut



Bolts

Remove the spark plug.  
 Remove the cylinder head bolts and the cylinder head.

\* Loosen the bolts diagonally in 2 or 3 times.

Cylinder head Bolts

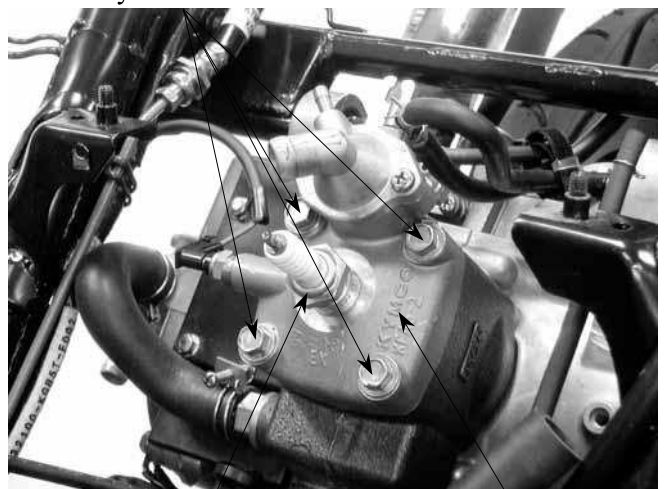

Spark Plug

Cylinder Head

# 6. CYLINDER HEAD/CYLINDER/PISTON

## CYLINDER HEAD

### REMOVAL < SF10DA >

Remove the rear carrier.  
Remove the frame body cover. (⇒2-2)

Spark Plug Cap

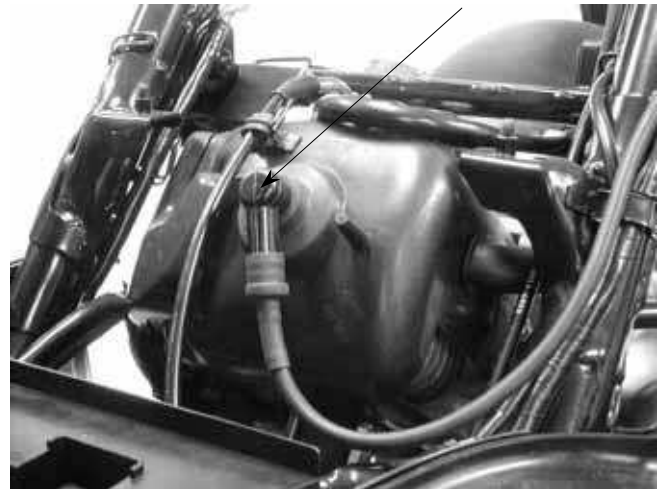

Remove the spark plug cap.  
Remove the three bolts attaching the fan cover to remove the fan cover.  
Remove the two joint lock nuts on the front of the exhaust muffler and then remove the two exhaust muffler lock bolts.  
Remove the bolt attaching the engine hood to remove the engine hood.  
The installation sequence is the reverse of removal.

Fan Cover/Engine Hood

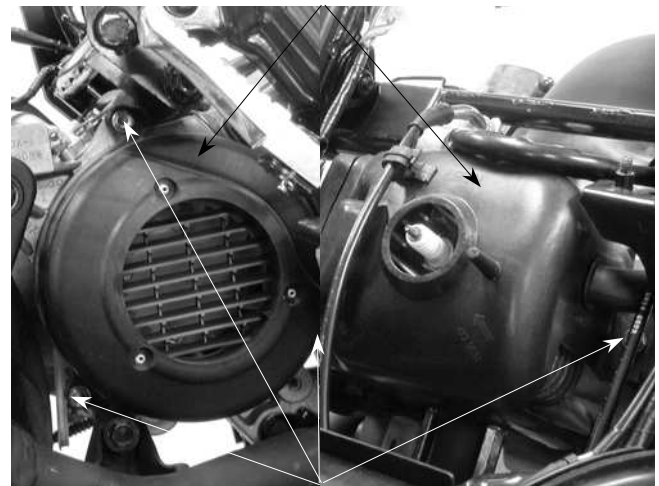

\* When installing the exhaust muffler, first tighten the two nuts on the front and then tighten the two bolts.

Bolts

Remove the spark plug.  
Remove the cylinder head bolts and the cylinder head.

\* Loosen the bolts diagonally in 2 or 3 times.

Cylinder head Bolts

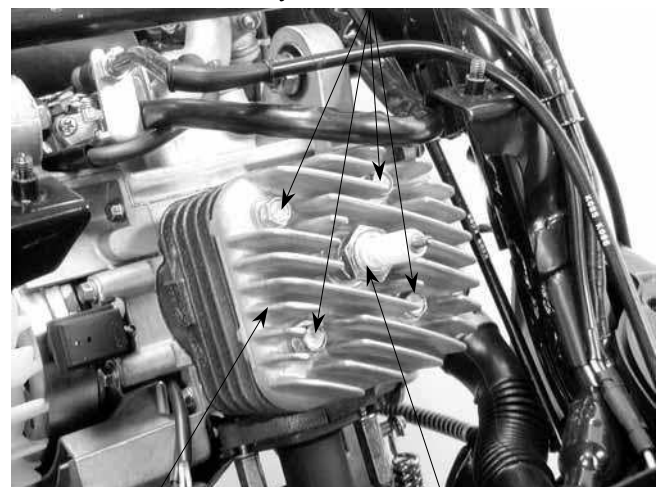

Remove the cylinder head gasket.

Cylinder Head

Spark Plug

## 6. CYLINDER HEAD/CYLINDER/PISTON

### COMBUSTION CHAMBER DECARBONIZING

Remove the carbon deposits from the combustion chamber

- \* Avoid damaging the combustion chamber wall and cylinder mating surface.

Combustion Chamber

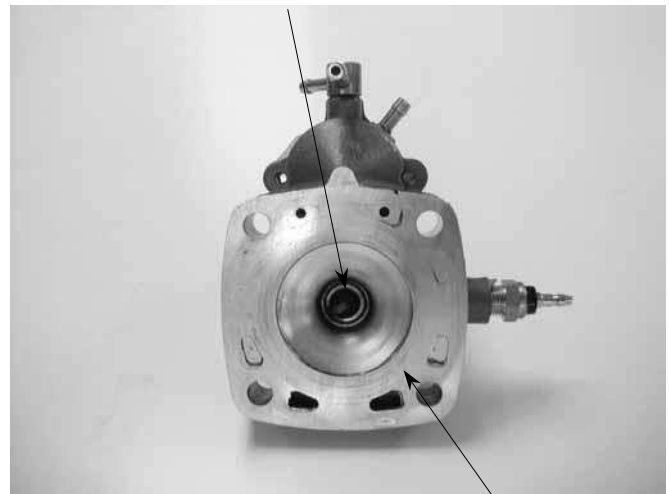

Mating Surface

### CYLINDER HEAD INSPECTION

Check the cylinder head for warpage with a straight edge and feeler gauge.

#### Service Limit:

SH10DA: 0.10mm replace if over

SF10DA: 0.10mm replace if over



### CYLINDER HEAD INSTALLATION

Install the cylinder head on the cylinder properly.

- \* Be careful not to damage the mating surfaces.

Install a new cylinder head gasket onto the cylinder.

Cylinder head Gasket



## 6. CYLINDER HEAD/CYLINDER/PISTON

### Cylinder Head Bolts Installation

Install and tighten the cylinder head bolts diagonally in 2 or 3 times.

**Torque:** 14.7~16.66N-m

Install the spark plug.

**Torque:** 10.78~16.66N-m

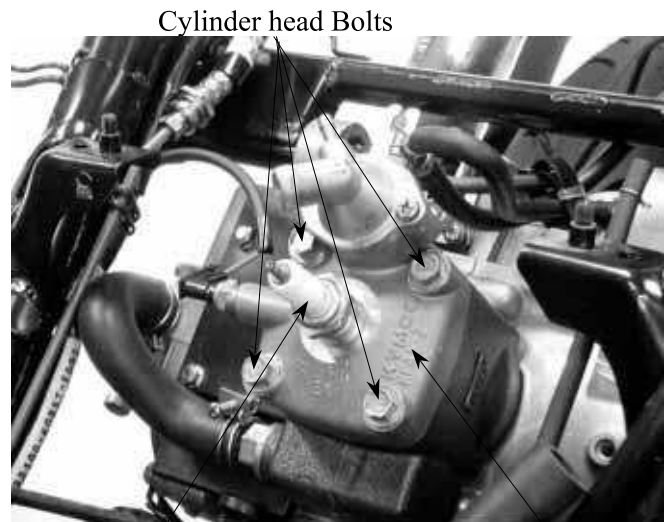

Spark Plug

Cylinder Head

### Engine Hood Installation

Install the engine hood. (⇒6-3)

Install the spark plug cap. (⇒6-3)

Perform the following inspections after installation:

- Compression test
- Abnormal engine noise
- Cylinder air leaks

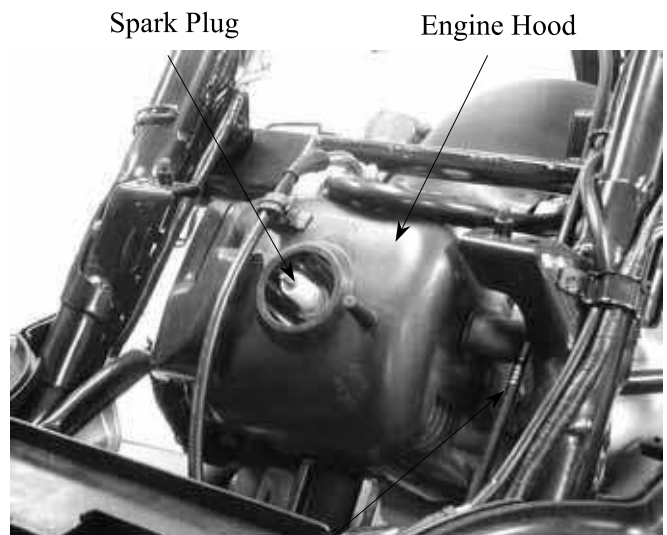

Spark Plug

Engine Hood

Bolts



Bolts

## 6. CYLINDER HEAD/CYLINDER/PISTON

### CYLINDER/PISTON

#### CYLINDER REMOVAL

Remove the met-in box and seat.  
Remove the frame body cover.  
Remove the cylinder head. (6-3)  
Remove the two exhaust muffler joint lock nuts and two exhaust muffler lock bolts.  
Remove the exhaust muffler.  
Remove the cylinder.  
Remove the cylinder gasket.

\* Do not pry between the cylinder and crankcase or strike the fins.



Exhaust Muffler Lock Bolts

Joint Lock Nuts

#### PISTON REMOVAL

Remove the piston pin clip to remove the piston pin and piston.

\*

- Do not damage or scratch the piston.
- Do not apply side force to the connecting rod when removing the piston pin.
- Place clean shop towels in the crankcase to keep the piston pin clip from falling into the crankcase.

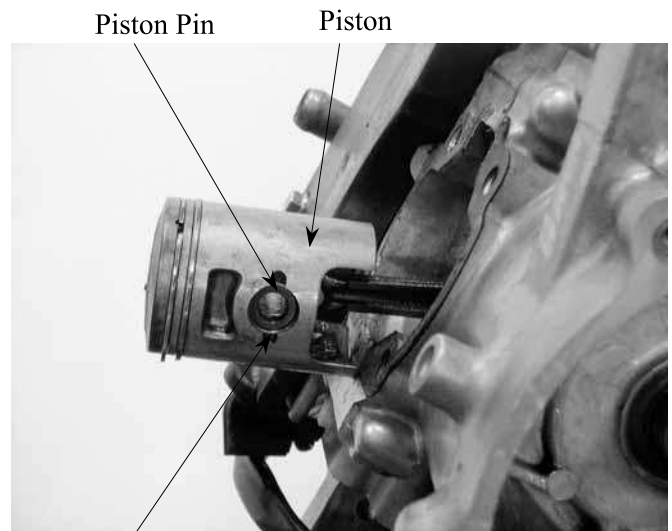

Piston Pin Clip

Spread each piston ring and remove by lifting it up at a point just opposite the gap.  
Remove the expander.



## 6. CYLINDER HEAD/CYLINDER/PISTON

### CYLINDER/PISTON INSPECTION

Check the cylinder and piston for wear or damage.

Clean carbon deposits from the exhaust port area.

\*

Be careful not to damage the cylinder inside wall.



Measure the cylinder bore at three levels of A, B and C in both X and Y directions. Avoid the port area. Take the maximum figure measured to determine the cylinder bore.

#### Service Limit:

SH10DA: 39.05mm replace if over

SF10DA: 39.05mm replace if over

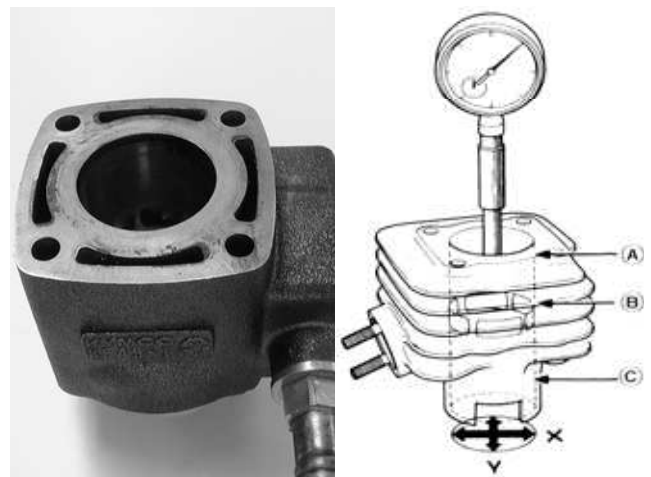

Inspect the top of the cylinder for warpage.

#### Service Limit:

SH10DA: 0.10mm replace if over

SF10DA: 0.10mm replace if over



## 6. CYLINDER HEAD/CYLINDER/PISTON

\*

The cylinder has an A mark or no mark on it. When replacing the cylinder with a new one, use a cylinder having the same mark as the old one.



A Mark

Measure the piston O.D. at a point 5mm from the bottom of the piston skirt.

**Service Limit:**

SH10DA: 38.90mm replace if below

SF10DA: 38.90mm replace if below

Measure the piston-to-cylinder clearance.

**Service Limit:**

SH10DA: 0.10mm replace if over

SF10DA: 0.10mm replace if over



Measure the piston pin hole I.D.

**Service Limit:**

SH10DA: 12.03mm replace if over

SF10DA: 12.03mm replace if over

Measure the piston pin O.D.

**Service Limit:**

SH10DA: 11.98mm replace if below

SF10DA: 11.98mm replace if below

Measure the piston-to-piston pin clearance.

**Service Limit:**

SH10DA: 0.03mm replace if over

SF10DA: 0.03mm replace if over



## 6. CYLINDER HEAD/CYLINDER/PISTON

### PISTON RING INSPECTION

Measure each piston ring end gap.

**Service Limits:** Top/Second

SH10DA: 0.40mm replace if over

SF10DA: 0.40mm replace if over

\* Set each piston ring squarely into the cylinder using the piston and measure the end gap.

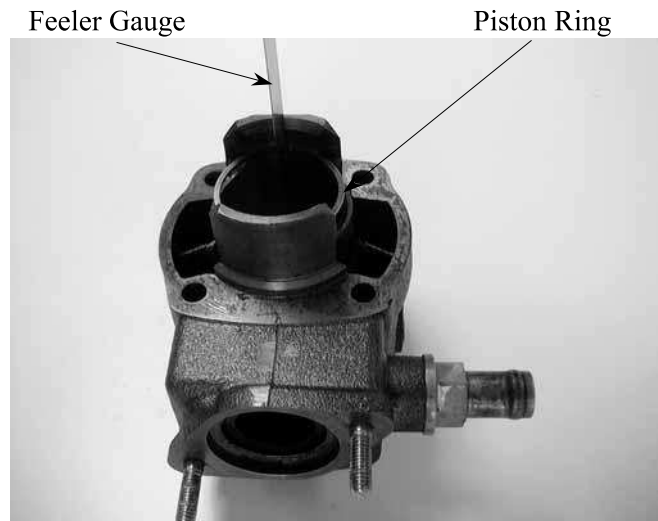

### CONNECTING ROD SMALL END INSPECTION

Install the piston pin and bearing in the connecting rod small end and check for excessive play.

Measure the connecting rod small end I.D.

**Service Limit:**

SH10DA: 17.03mm replace if over

SF10DA: 17.03mm replace if over



### PISTON/CYLINDER INSTALLATION

First install the expander in the second ring groove.

Then install the top and second rings in their respective ring grooves.

The piston rings should be pressed into the grooves with even force.

After installation, check and make sure that each ring is flush with the piston at several points around the ring.

A ring that will not compress means that the ring groove has carbon deposits in it and should be cleaned.

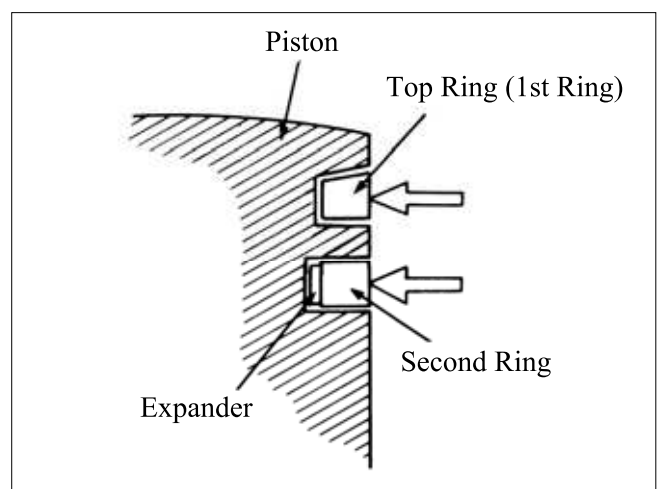



## 6. CYLINDER HEAD/CYLINDER/PISTON

Install a new cylinder gasket on the mating surface between the cylinder and crankcase.

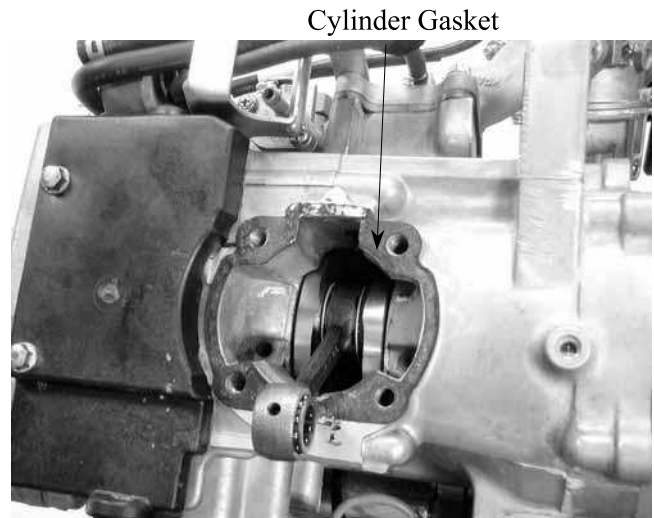

Make sure that the ring end gaps are aligned with the piston ring pins in the ring grooves.



Lubricate the cylinder inside and piston rings with engine oil and install the piston into the cylinder while compressing the piston rings.

\* Be careful not to damage the piston.

Install the cylinder head.

**Torque:** 14.7~16.66N-m

Install the exhaust muffler and tighten the exhaust muffler joint lock nuts.

**Torque:** 9.8~13.72N-m

Tighten the exhaust muffler lock bolts.

**Torque:** 29.4~35.28N-m

Install the frame covers.

---

---

---

---

---

---

---

**KICK STARTER/DRIVE PULLEY/  
CLUTCH/DRIVEN PULLEY**

**7**

SERVICE INFORMATION .....	7- 1
TROUBLESHOOTING .....	7- 1
KICK STARTER.....	7- 2
DRIVE BELT .....	7- 6
DRIVE PULLEY .....	7- 8
STARTER PINION.....	7-10
CLUTCH/DRIVEN PULLEY.....	7-11

# 7. KICK STARTER/DRIVE PULLEY/ CLUTCH/DRIVEN PULLEY

## SERVICE INFORMATION

### GENERAL INSTRUCTIONS

- Avoid getting grease and oil on the drive belt and pulley faces.

SPECIFICATIONS	Standard (mm)		Service Limit (mm)	
	SH10DA	SF10DA	SH10DA	SF10DA
Drive pulley collar O.D.	20.01~20.025		19.97	
Movable drive face I.D.	20.035~20.085		20.21	
Weight roller O.D.	13.0		12.4	
Clutch outer I.D.	107~107.2		107.5	
Driven face spring free length	87.9		82.6	
Driven face O.D.	33.965~33.985		33.94	
Movable driven face I.D.	34.0~34.025		34.06	
Drive belt width	18		17	

### TORQUE VALUES

Drive face nut	34.3~39.2N-m
Clutch outer nut	34.3~44.1N-m
Clutch drive plate nut	49.0~58.8N-m

### SPECIAL TOOLS

Lock nut wrench, 28mm	Universal holder
Clutch spring compressor	Lock nut socket wrench, 32mm
Bearing outer driver 37x40mm	Bearing driver pilot, 17mm
One-way clutch puller	Outer driver, 24x26mm

### TROUBLESHOOTING

#### Engine starts but motorcycle won't move

- Worn drive belt
- Broken ramp plate
- Worn or damaged clutch lining

#### Poor performance at high speed or lack of power

- Worn drive belt
- Weak driven face spring
- Worn weight roller
- Faulty driven face

#### Engine stalls or motorcycle creeps

- Broken clutch weight spring

## 7. KICK STARTER/DRIVE PULLEY/ CLUTCH/DRIVEN PULLEY

### KICK STARTER

#### LEFT CRANKCASE COVER REMOVAL

Remove the drive belt cooling air tube connector circlip.  
Remove the nine left crankcase cover bolts, left crankcase cover and dowel pins.  
Inspect the left crankcase cover seal rubber for damage or deterioration.

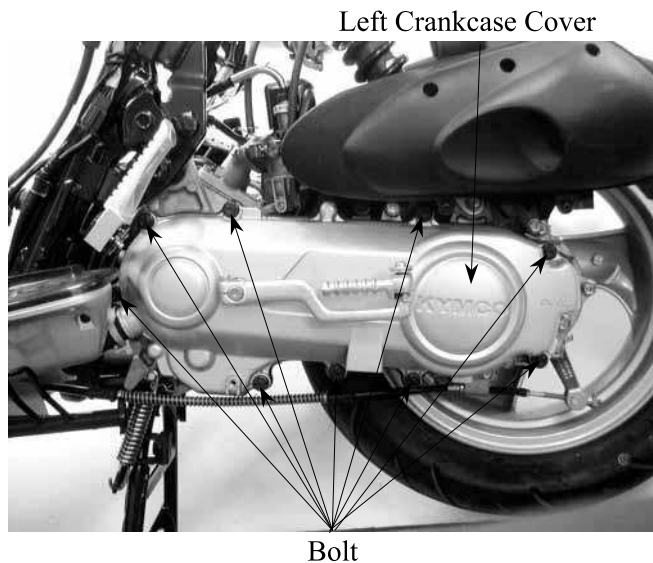

#### KICK STARTER SPINDLE REMOVAL

Remove the kick lever from the kick starter spindle.  
Remove the circlip and washer from the kick starter spindle.

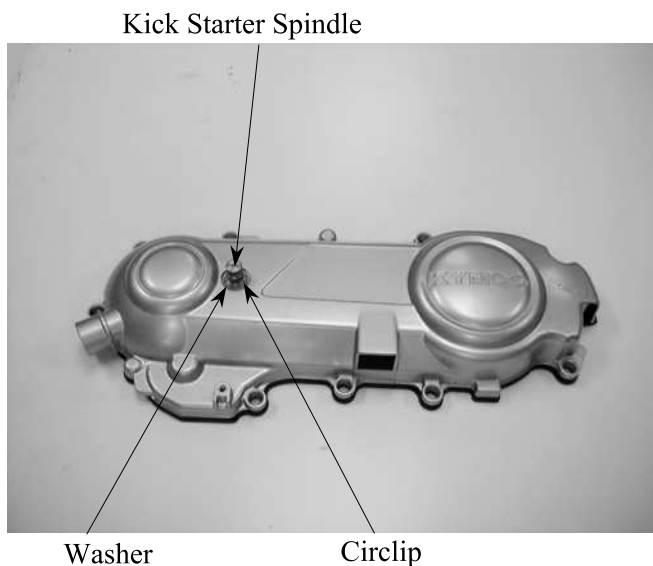

Slightly rotate the kick starter spindle to remove the kick starter driven gear together with the friction spring.

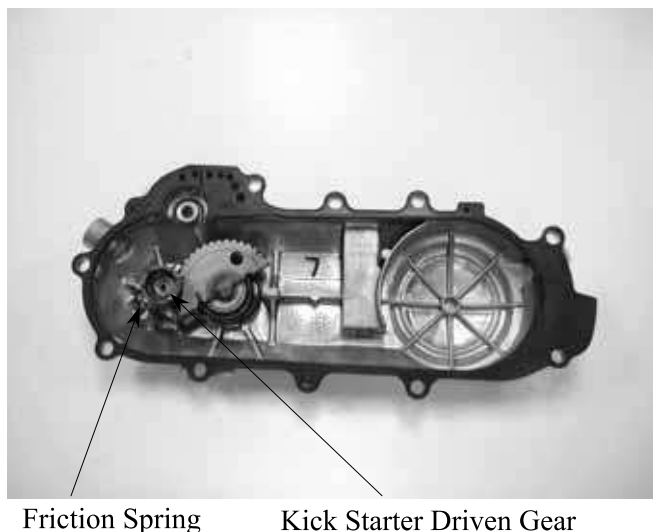

## 7. KICK STARTER/DRIVE PULLEY/ CLUTCH/DRIVEN PULLEY

Remove the kick starter spindle and return spring from the left crankcase cover.  
Remove the kick starter spindle bushing.

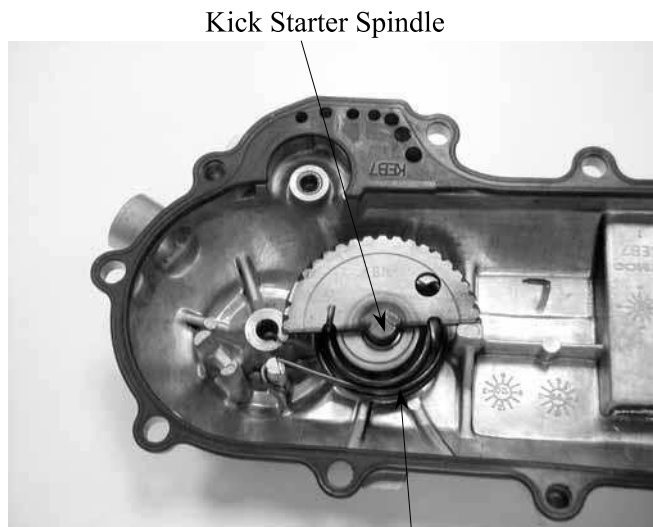

Kick Starter Spindle

Return Spring

### **KICK STARTER SPINDLE INSPECTION**

Inspect the kick starter spindle and gear for wear or damage.  
Inspect the return spring for weakness or damage.  
Inspect the kick starter spindle bushing for wear or damage.



Spindle

Return Spring

Plastic Bushing

Spindle Bushing

Check the kick starter driven gear for wear or damage.  
Check the friction spring for wear or damage.



Friction Spring

Kick Starter Driven Gear

## 7. KICK STARTER/DRIVE PULLEY/ CLUTCH/DRIVEN PULLEY

Inspect the kick starter spindle and driven gear forcing parts for wear or damage.

Kick Starter Spindle Forcing Part

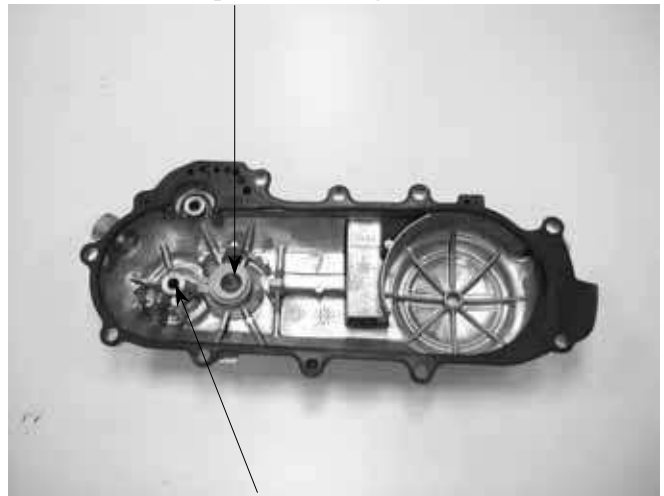

Kick Starter Driven Gear Forcing Part

### KICK STARTER INSTALLATION

Install the kick starter spindle bushing and return spring onto the left crankcase cover.

\* If the hooks of the return spring can not be installed properly, use a screw driver to press them into their locations respectively.



Kick Starter Spindle

Friction Spring

Properly install the kick starter driven gear and friction spring as the figure shown.

Friction Spring



Kick Starter Driven Gear

## 7. KICK STARTER/DRIVE PULLEY/ CLUTCH/DRIVEN PULLEY

First install the washer and then the circlip onto the kick starter spindle.  
Install the kick lever.



Washer

Circlip

### LEFT CRANKCASE COVER INSTALLATION

First install the dowel pins and then the seal rubber.

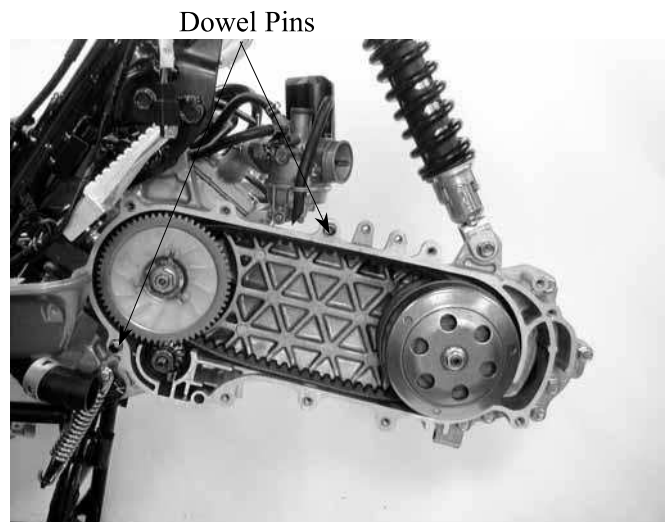

Dowel Pins

Install the left crankcase cover and tighten the nine bolts diagonally.  
Connect the drive belt cooling air tube and install the circlip.



Left Crankcase Cover

## 7. KICK STARTER/DRIVE PULLEY/ CLUTCH/DRIVEN PULLEY

### DRIVE BELT

Remove the left crankcase cover.

### INSPECTION

Check the drive belt for cracks, separation or abnormal or excessive wear.  
Measure the drive belt width.

### Service Limit:

SH10DA: 17mm replace if below

SF10DA: 17mm replace if below

\* Use specified genuine parts for replacement.

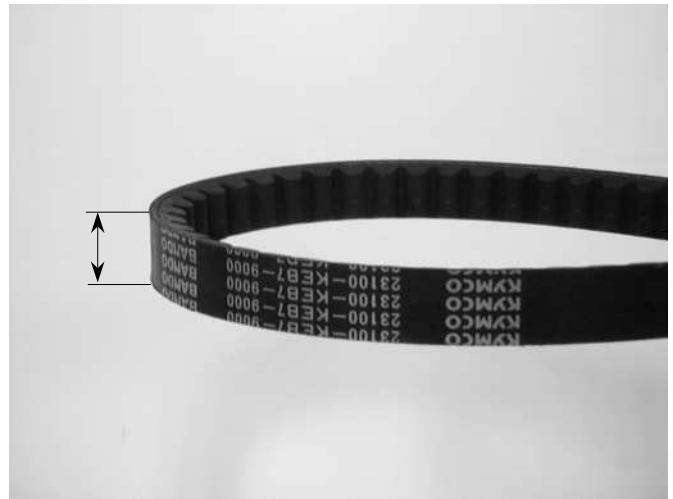

### REPLACEMENT

Remove the nine left crankcase cover bolts and left crankcase cover. (⇒7-2)  
Hold the clutch outer with the universal holder and remove the 14mm clutch outer nut and clutch outer.

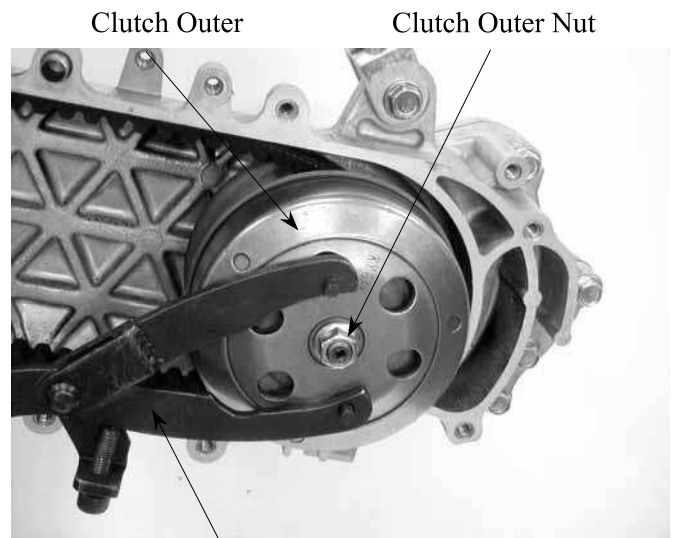

Universal Holder

Hold the drive pulley with the holder and remove the 17mm drive face nut.  
Remove the starting ratchet.  
Remove the drive pulley face.

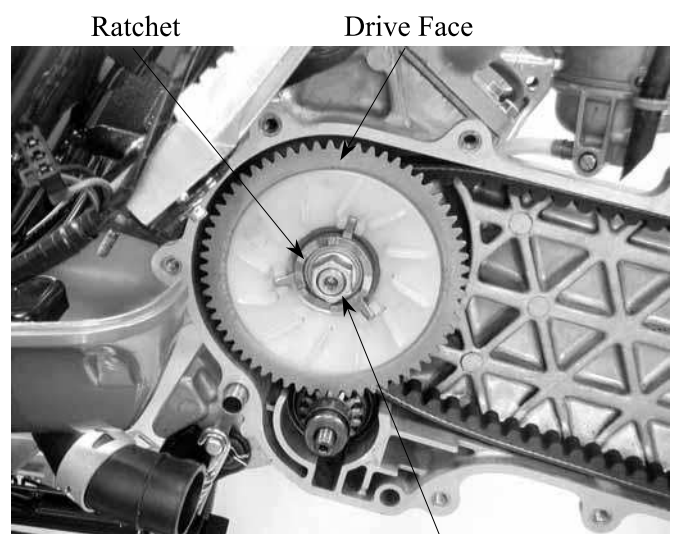

Drive Face Nut



## 7. KICK STARTER/DRIVE PULLEY/ CLUTCH/DRIVEN PULLEY

Remove the drive belt from the clutch/  
driven pulley.

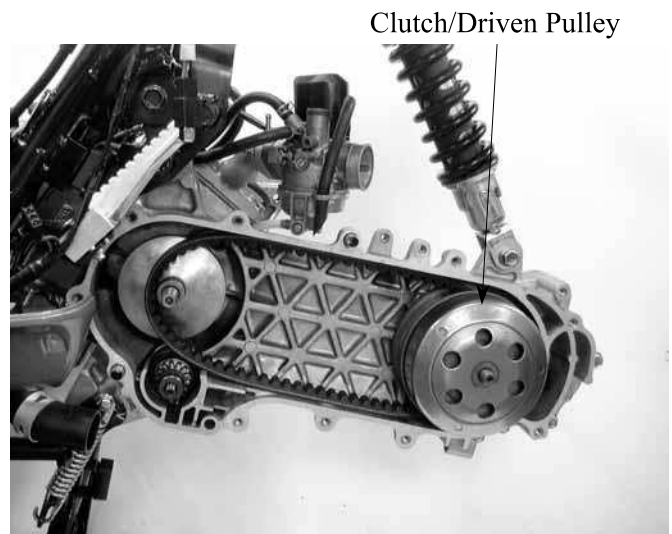

### DRIVE BELT INSTALLATION

Turn the driven pulley clockwise and lift it  
up to expand the drive belt groove and then  
install a new drive belt.



Set the drive belt on the drive pulley.  
Install the drive pulley face, starting ratchet  
and 17mm washer, then tighten the drive  
face nut.

**Torque:** 34.3~39.2N-m

\* When installing the drive face nut, make  
sure that the tooth spaces of the drive  
pulley face and starting ratchet align  
with the teeth of the crankshaft.

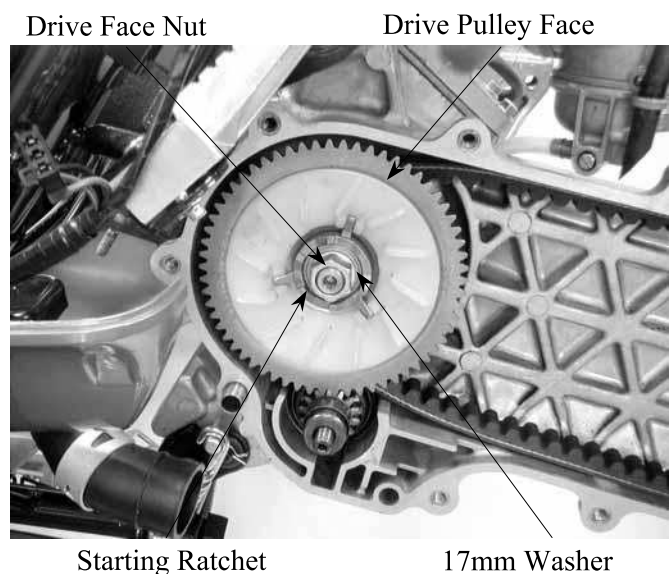

## 7. KICK STARTER/DRIVE PULLEY/ CLUTCH/DRIVEN PULLEY

### DRIVE PULLEY

#### REMOVAL

Hold the drive pulley with the holder and remove the 17mm drive face nut. Remove the starting ratchet, 17mm washer and drive pulley face.

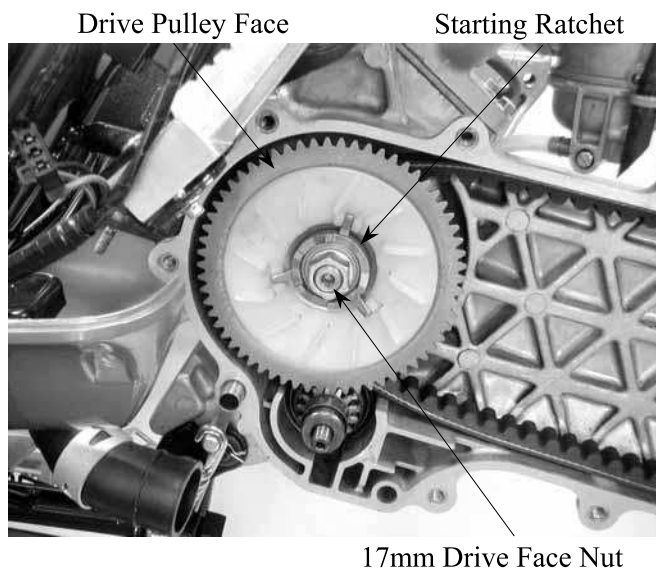

#### MOVABLE DRIVE FACE DISASSEMBLY

Remove the movable drive face and drive pulley collar from the crankshaft.

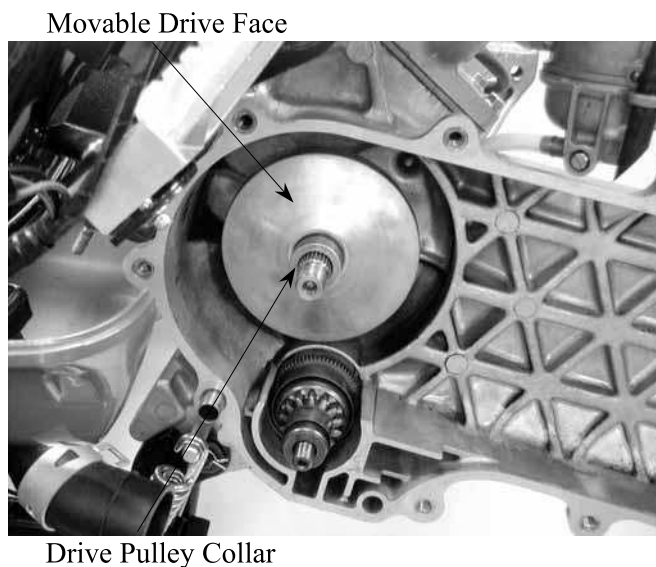

Remove the ramp plate.

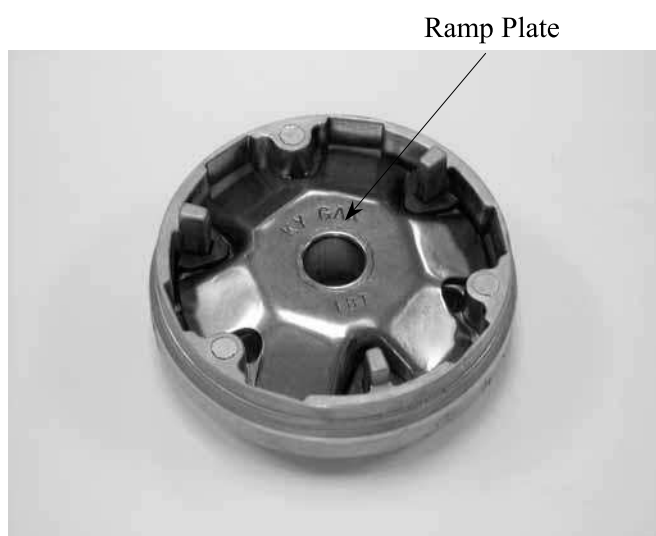

## 7. KICK STARTER/DRIVE PULLEY/ CLUTCH/DRIVEN PULLEY

Remove the weight rollers.

Weight Roller

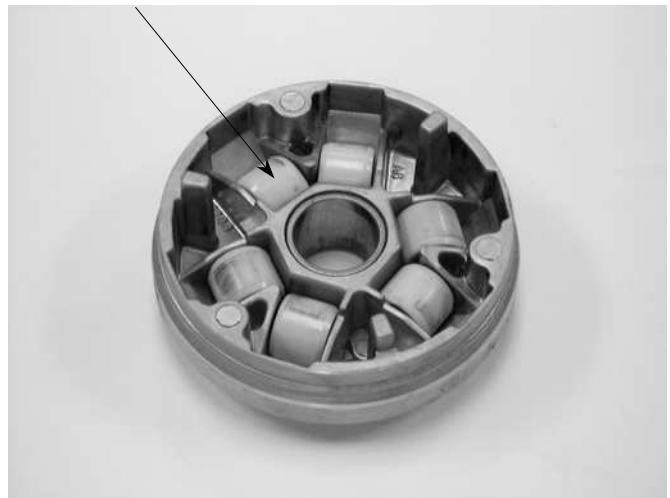

### MOVABLE DRIVE FACE INSPECTION

Check each weight roller for wear or damage.

Measure each roller O.D.

#### Service Limit:

SH10DA: 12.4mm replace if below

SF10DA: 12.4mm replace if below

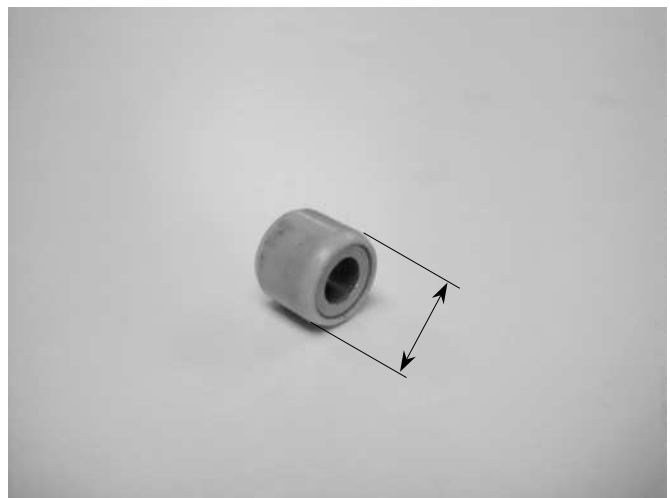

### DRIVE PULLEY INSTALLATION

Install the drive pulley collar and movable drive face onto the crankshaft.

Movable Drive Face

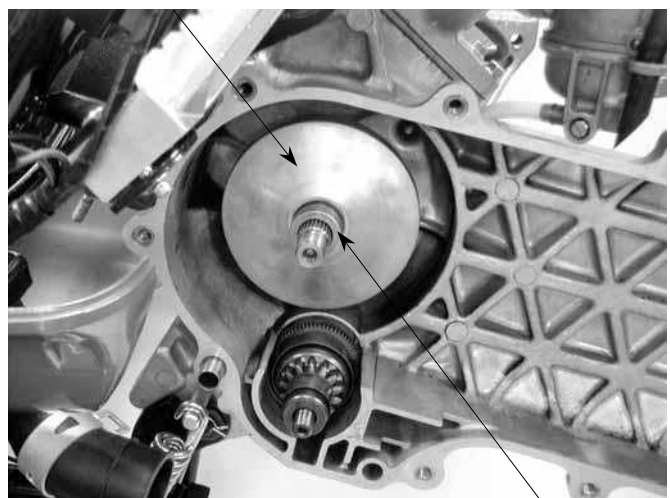

Drive Pulley Collar

## 7. KICK STARTER/DRIVE PULLEY/ CLUTCH/DRIVEN PULLEY

Install the drive belt on the crankshaft.  
Install the drive face, starting ratchet and  
washer, then tighten the 17mm drive face  
nut.

**Torque:** 34.3~39.2N·m

\*

Keep grease or oil off the drive belt and  
drive pulley faces.

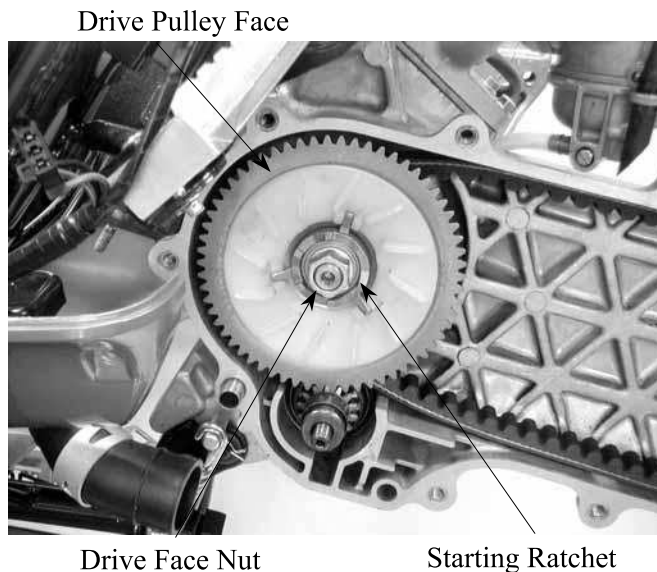

### STARTER PINION

#### REMOVAL

Remove the left crankcase cover. (⇒7-2)  
Remove the drive pulley. (⇒7-6)  
Remove the starter pinion.



Starter Pinion

#### INSPECTION

Inspect the starter pinion seat for wear.  
Inspect the starter pinion for smooth  
operation.  
Inspect the starter pinion shaft forcing parts  
for wear and damage.

#### INSTALLATION

Apply a small amount of grease to the  
starter pinion teeth.  
Install the starter pinion in the reverse order  
of removal.



Starter Pinion

## 7. KICK STARTER/DRIVE PULLEY/ CLUTCH/DRIVEN PULLEY

**KYMCO**  
SUPER 9 50

### CLUTCH/DRIVEN PULLEY

#### CLUTCH/DRIVEN PULLEY REMOVAL

Remove the drive pulley. (⇒7-6)  
Hold the clutch outer with the universal holder and remove the 14mm clutch outer nut.  
Remove the clutch outer.

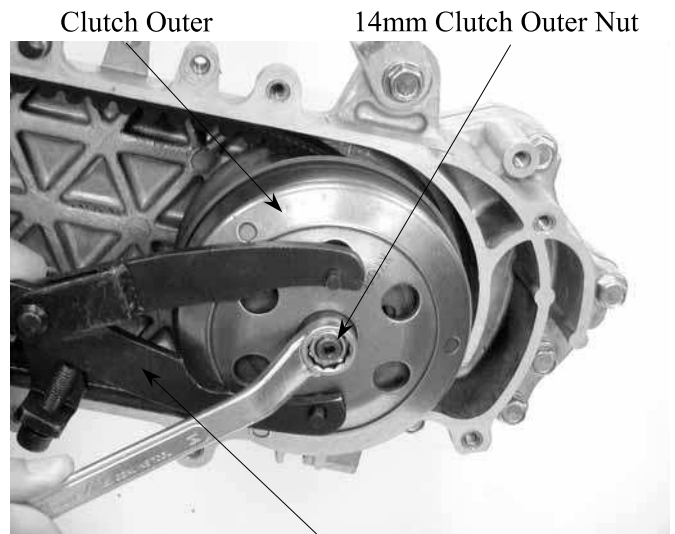

Universal Holder

Remove the clutch/driven pulley.  
Remove the drive belt from the clutch/driven pulley.

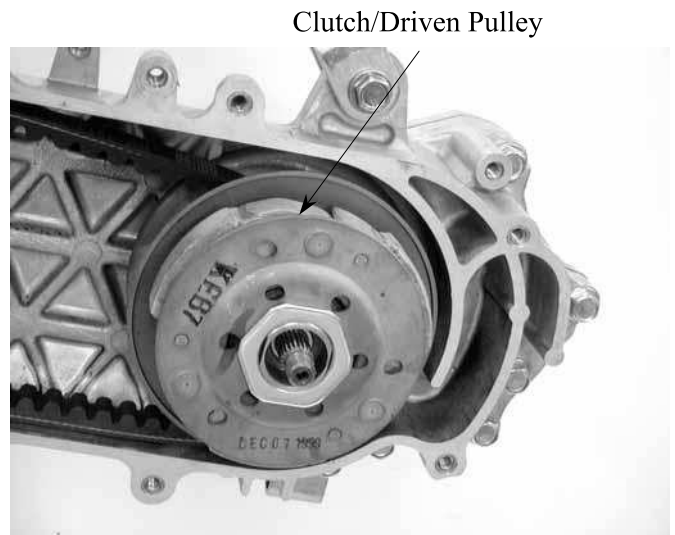

Clutch/Driven Pulley

#### CLUTCH/DRIVEN PULLEY DISASSEMBLY

Compress the clutch/driven pulley spring with the clutch spring compressor and remove the 28mm drive plate nut.  
Remove the driven face spring.

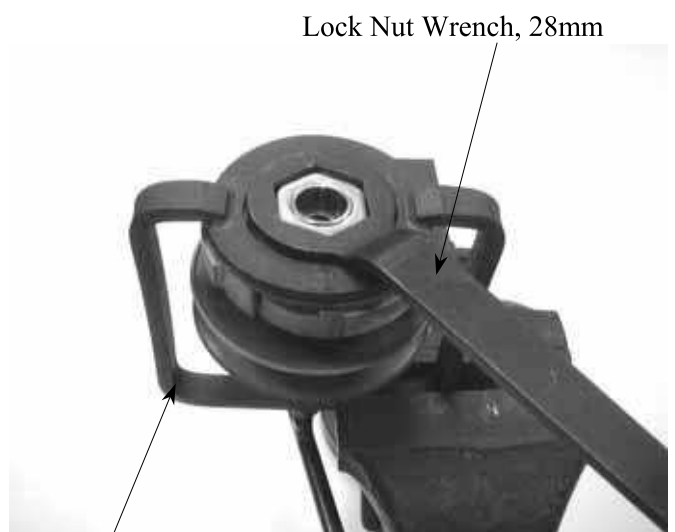

Clutch Spring Compressor

## 7. KICK STARTER/DRIVE PULLEY/ CLUTCH/DRIVEN PULLEY

Remove the seal collar.



Seal Collar

Pull out the guide roller pins from the driven pulley and then remove the O-rings and oil seal from the driven pulley.

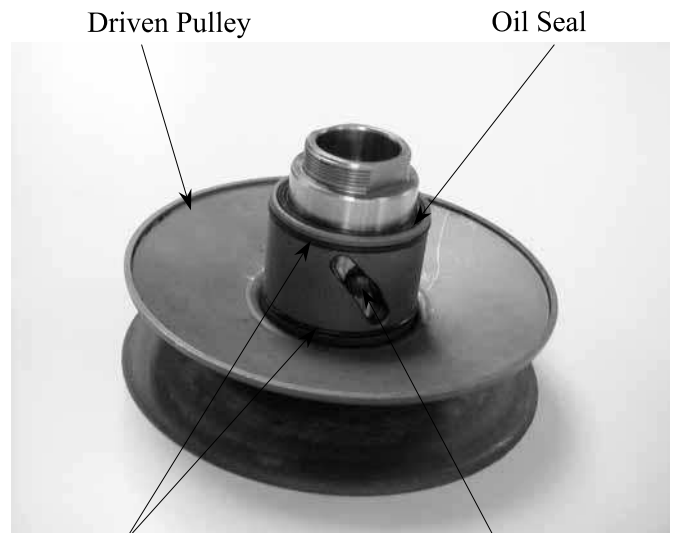

O-rings

Guide Roller Pin

### CLUTCH/DRIVEN PULLEY INSPECTION

Inspect the clutch outer for wear or damage.  
Measure the clutch outer I.D.

#### Service Limit:

SH10DA: 107.5mm replace if over

SF10DA: 107.5mm replace if over



## 7. KICK STARTER/DRIVE PULLEY/ CLUTCH/DRIVEN PULLEY

Check the clutch shoes for wear or damage.  
Measure the clutch lining thickness.

**Service Limit:** 2.0mm replace if below



Measure the driven face spring free length.

**Service Limit:**

SH10DA: 82.6mm replace if below

SF10DA: 82.6mm replace if below

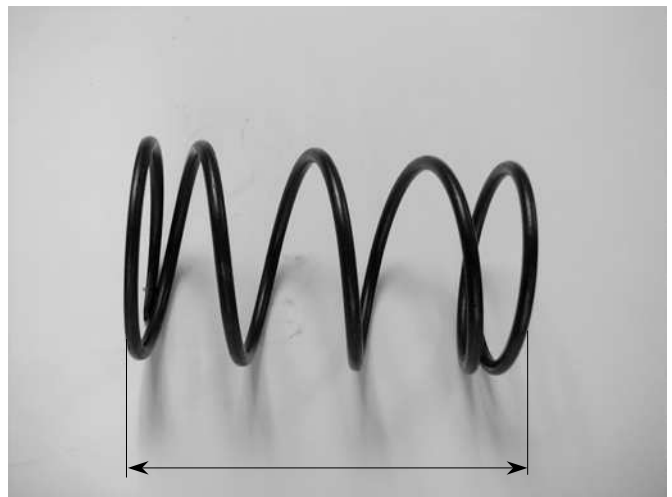

Check the driven face assembly for wear or damage.

Measure the driven face O.D.

**Service Limit:** 33.94mm replace if below

Check the movable driven face for wear or damage.

Measure the movable driven face I.D.

**Service Limit:** 34.06mm replace if over

Check the guide roller pins for stepped wear.

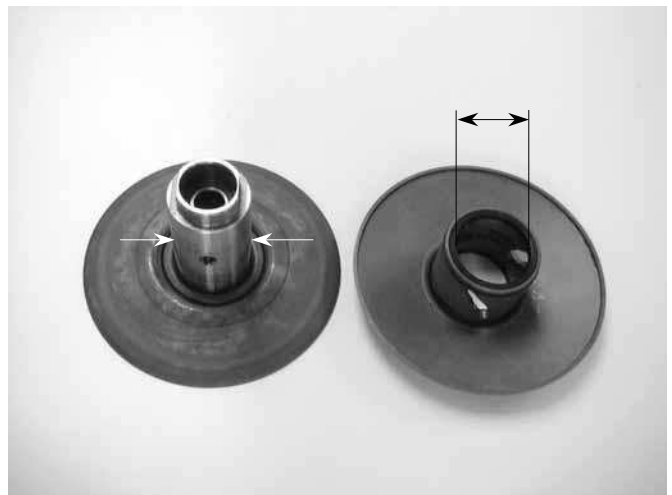

## 7. KICK STARTER/DRIVE PULLEY/ CLUTCH/DRIVEN PULLEY

### DRIVEN PULLEY FACE BEARING REPLACEMENT

Check the needle bearings in the driven face and replace them if they have excessive play, damage or abnormal noise. Drive the inner bearing out of the driven pulley face.

Inner Bearing



Remove the drive outer bearing out of the driven face.



Outer Bearing

Drive a new outer bearing into the driven face with the sealed end facing up. Seat the snap ring in its groove.

- \* Pack all bearing cavities with 5.0~5.6g grease.  
Specified grease: 230°C Heat-resistant grease

Bearing Outer Driver





## 7. KICK STARTER/DRIVE PULLEY/ CLUTCH/DRIVEN PULLEY

Drive in a new needle bearing into the driven face with the mark facing up.



### CLUTCH/DRIVEN PULLEY ASSEMBLY

First install the movable driven face onto the driven face. Then, install the guide roller pins, O-rings and a new oil seal.

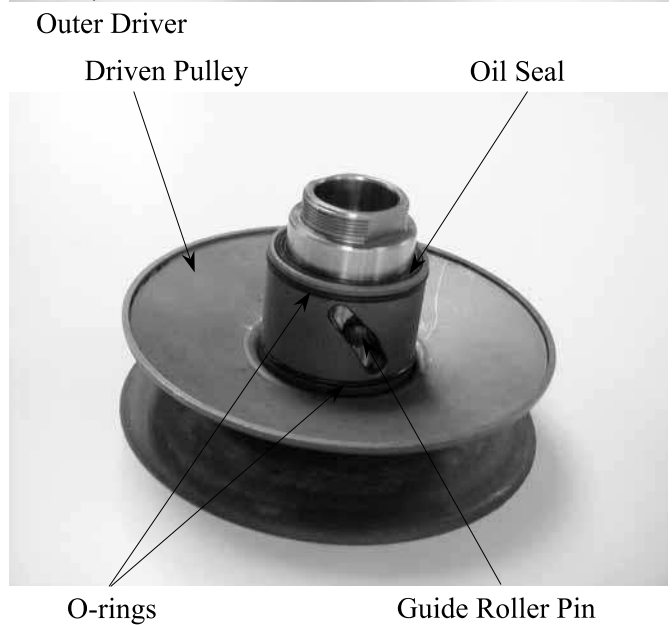

Install the seal collar.



## 7. KICK STARTER/DRIVE PULLEY/ CLUTCH/DRIVEN PULLEY

Set the driven pulley, driven face spring and clutch assembly onto the clutch spring compressor. Compress the tool and install the 28mm drive plate nut. Tighten the 28mm nut to the specified torque.

**Torque:** 49.0~58.8N-m



### CLUTCH/DRIVEN PULLEY INSTALLATION

Install the drive belt on the clutch/driven pulley and then install the clutch/driven pulley onto the drive shaft.

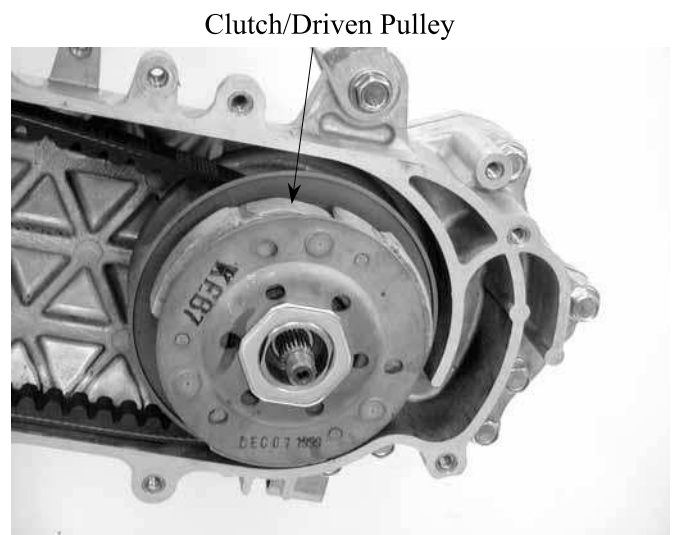

Install the clutch outer.  
Hold the clutch outer with the universal holder.  
Install and tighten the 10mm clutch outer nut.

**Torque:** 34.3~44.1N-m

Install the left crankcase cover. (⇒7-5)

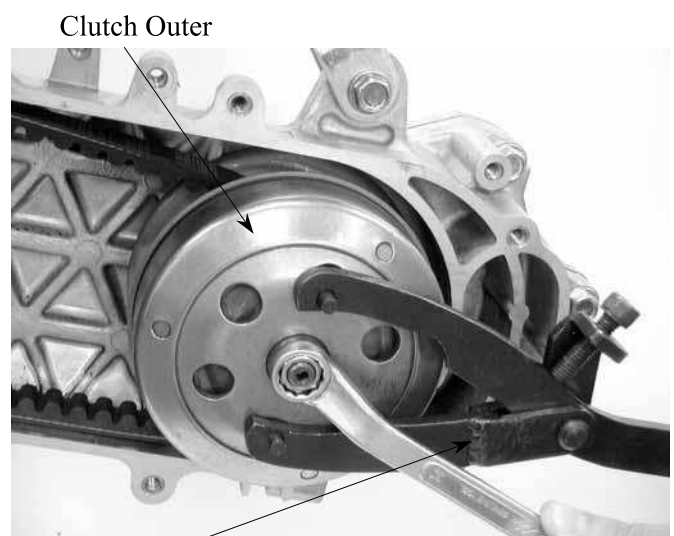

Universal Holder

# 8. FINAL REDUCTION

---



## FINAL REDUCTION

---

SERVICE INFORMATION ..... 8-1  
TROUBLESHOOTING ..... 8-1  
FINAL REDUCTION DISASSEMBLY ..... 8-2  
FINAL REDUCTION INSPECTION..... 8-2  
FINAL REDUCTION ASSEMBLY ..... 8-5



## 8. FINAL REDUCTION

### SERVICE INFORMATION

Specified Oil: SAE90#  
At disassembly: 0.12 liter  
At change: 0.1 liter

### SPECIAL TOOLS

Bearing remover set, 12mm  
Bearing remover set, 15mm  
Crankcase assembly collar  
Crankcase assembly shaft  
Bearing outer driver, 37x40mm  
Bearing outer driver, 32x35mm  
Bearing driver pilot, 17mm  
Bearing driver pilot, 15mm  
Bearing driver pilot, 12mm  
Bearing outer driver handle A

### TROUBLESHOOTING

#### Engine starts but motorcycle won't move

- Damaged transmission
- Seized or burnt transmission

#### Abnormal noise

- Worn, seized or chipped gears
- Worn bearing

#### Oil leaks

- Oil level too high
- Worn or damaged oil seal

# 8. FINAL REDUCTION

## FINAL REDUCTION DISASSEMBLY

- Remove the rear wheel. (⇒14-2)
- Remove the left crankcase cover. (⇒7-2)
- Remove the clutch/driven pulley. (⇒7-11)
- Drain the transmission gear oil into a clean container.
- Remove the transmission case cover attaching bolts.
- Remove the transmission case cover.
- Remove the gasket and dowel pins.

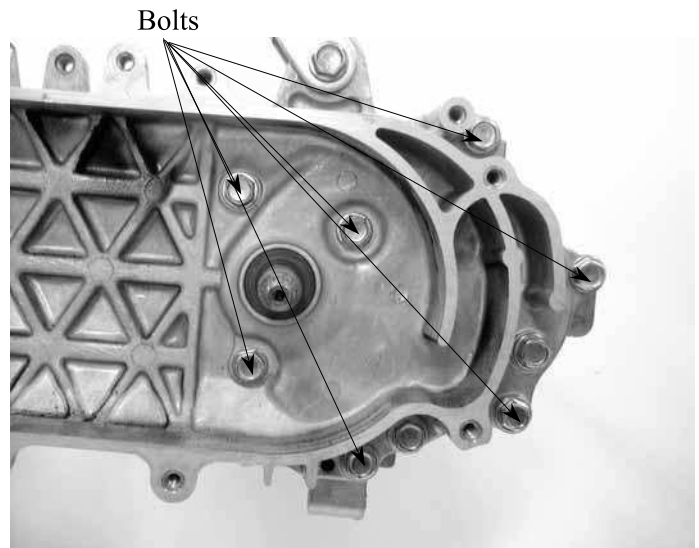

Remove the final gear and countershaft.

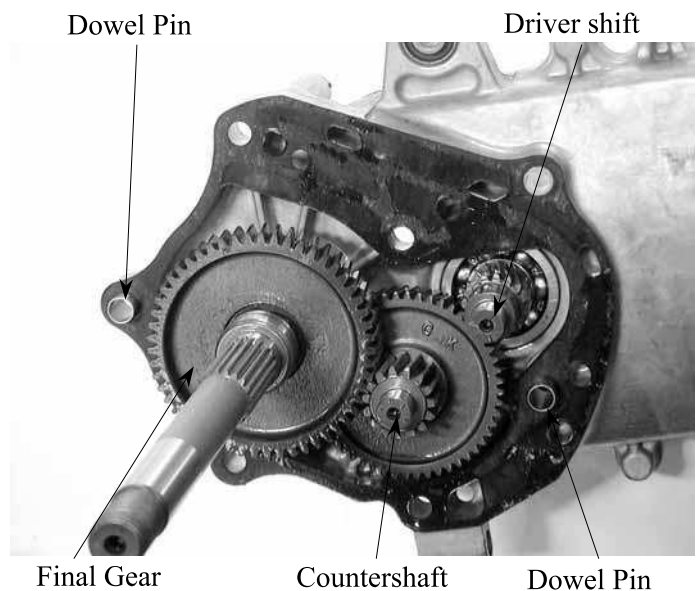

## FINAL REDUCTION INSPECTION

Inspect the countershaft and gear for wear or damage.



Countershaft

## 8. FINAL REDUCTION

Inspect the final gear and final shaft for wear, damage or seizure.



Check the left crankcase bearings for excessive play and inspect the oil seal for wear or damage.

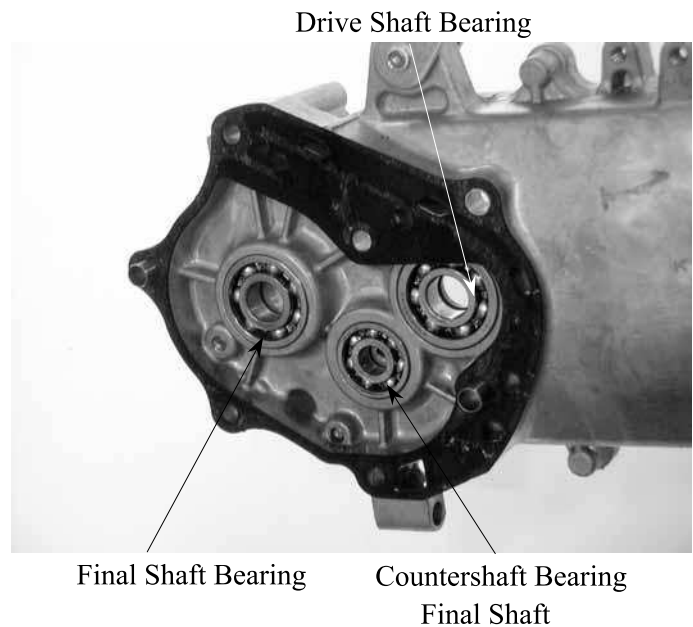

Inspect the drive shaft and gear for wear or damage.  
Check the transmission case cover bearings for excessive play and inspect the final shaft bearing oil seal for wear or damage.

\* Do not remove the transmission case cover except for necessary part replacement. When replacing the drive shaft, also replace the bearing and oil seal.

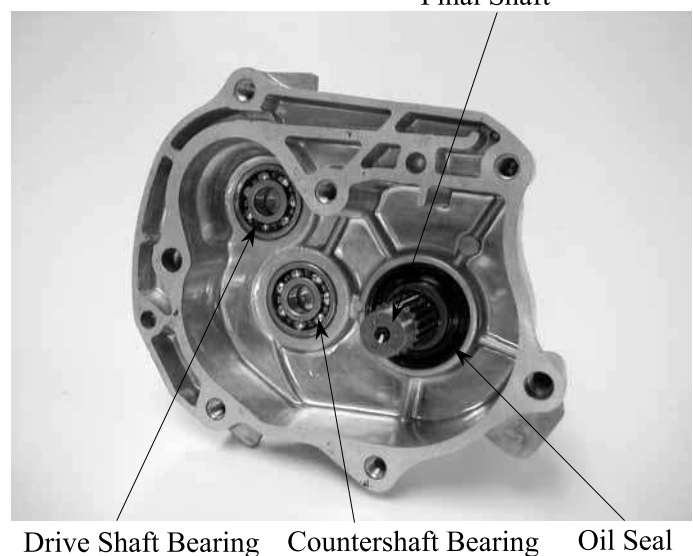

## 8. FINAL REDUCTION

### BEARING REPLACEMENT (Transmission Case Cover)

Remove the transmission case cover bearings using the bearing remover.  
Remove the final shaft oil seal.



Bearing Remover Set

Drive new bearings into the transmission case cover.



Bearing Outer Driver

### BEARING REPLACEMENT (Left Crankcase Cover)

Remove the drive shaft.  
Remove the drive shaft oil seal.  
Remove the left crankcase bearings using the bearing remover.

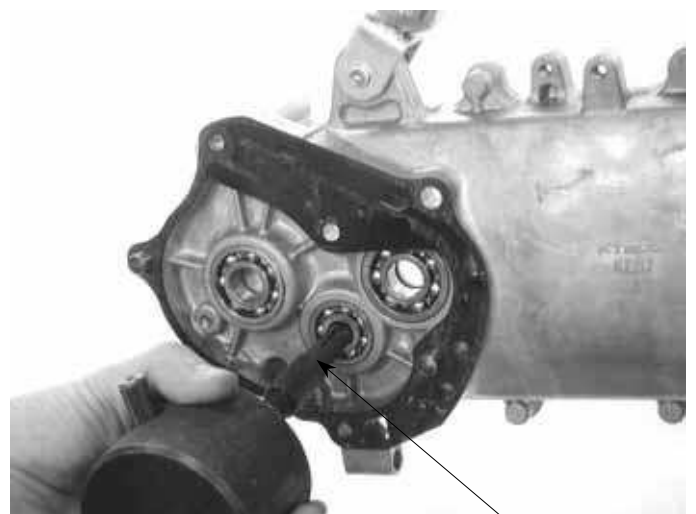

Bearing Remover Set

## 8. FINAL REDUCTION

Drive new bearings into the left crankcase.  
Install a new drive shaft oil seal.

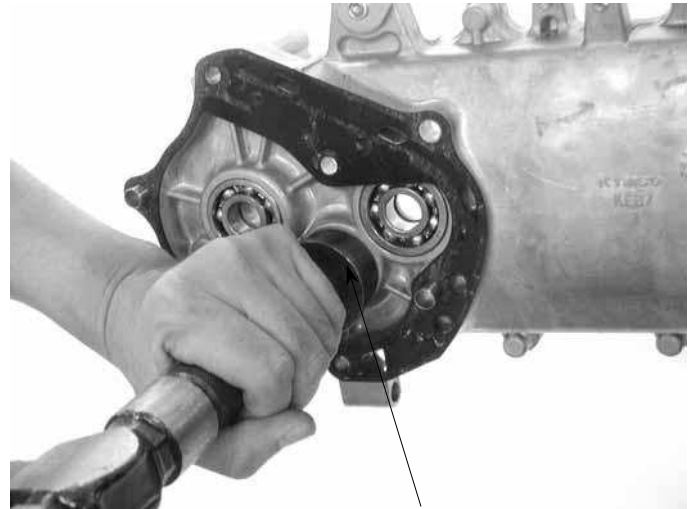

Bearing Outer Driver

### FINAL REDUCTION ASSEMBLY

Install the drive shaft into the left crankcase.



Drive Shaft

Install the countershaft gear into the left crankcase.

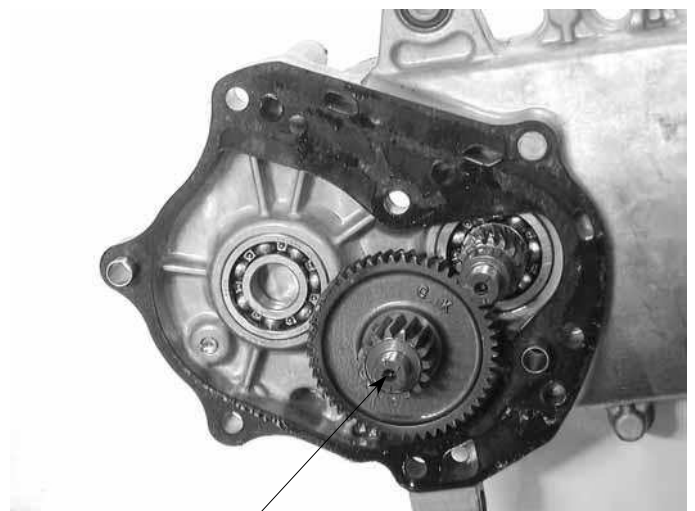

Countershaft Gear



## 8. FINAL REDUCTION

Install the final gear and final shaft into the left crankcase.  
Install the dowel pins and a new gasket.

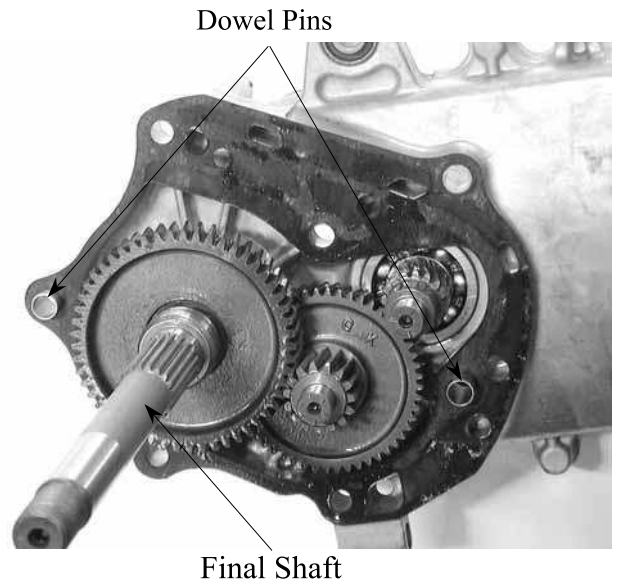

Install the transmission case cover.

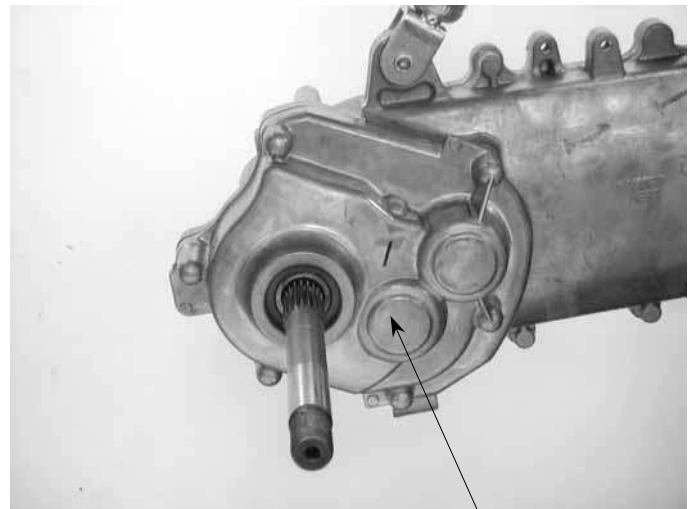

Install and tighten the transmission case cover bolts.  
Install the clutch/driven pulley. (⇒7-15)  
Install other removed parts in the reverse order of removal.

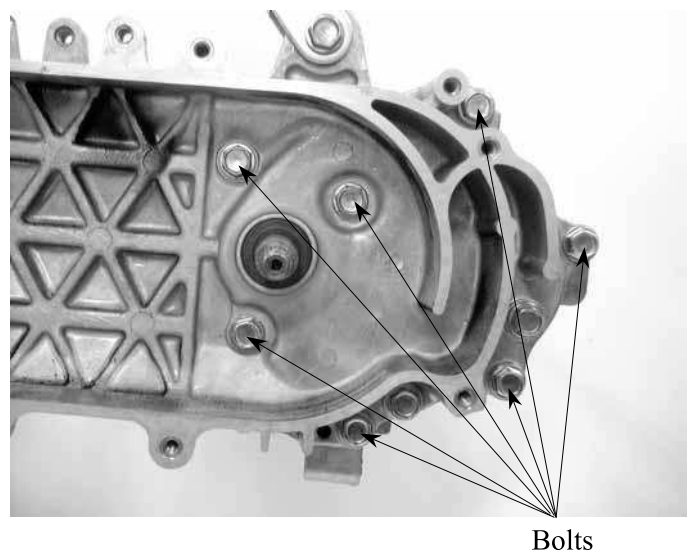

## 8. FINAL REDUCTION

After installation, fill the transmission case with the specified oil.

\*

- Place the motorcycle on its main stand on level ground.
- Check the sealing washer for wear or damage.

**Specified Gear Oil:** SAE90#

**Oil Capacity:** at disassembly: 0.12 liter  
at change: 0.1 liter

Install and tighten the oil check bolt.

**Torque:** 9.8~14.7N-m

Start the engine and check for oil leaks.

Check the oil level from the oil check bolt hole and add the specified oil to the proper level if the oil level is low.



Drain Bolt

Oil Check Bolt Hole/Filler

# **9. A.C. GENERATOR**

---



## **A.C. GENERATOR**

---

SERVICE INFORMATION ..... 9-1  
A.C. GENERATOR REMOVAL..... 9-2  
A.C. GENERATOR INSTALLATION ..... 9-5



## **9. A.C. GENERATOR**

### **SERVICE INFORMATION**

#### **GENERAL INSTRUCTIONS**

- All A.C. generator maintenance and inspection can be made with the engine installed.
- Refer to Section 15 for A.C. generator inspection.

#### **TORQUE VALUE**

Flywheel nut : 34.3~39.2N-m

#### **SPECIAL TOOLS**

Flywheel puller  
Universal holder

## 9. A.C. GENERATOR

〈 SH10DA 〉

### A.C. GENERATOR REMOVAL

Disconnect the water hoses from the right crankcase cover.

Remove the three bolts attaching the right crankcase cover and the cover.

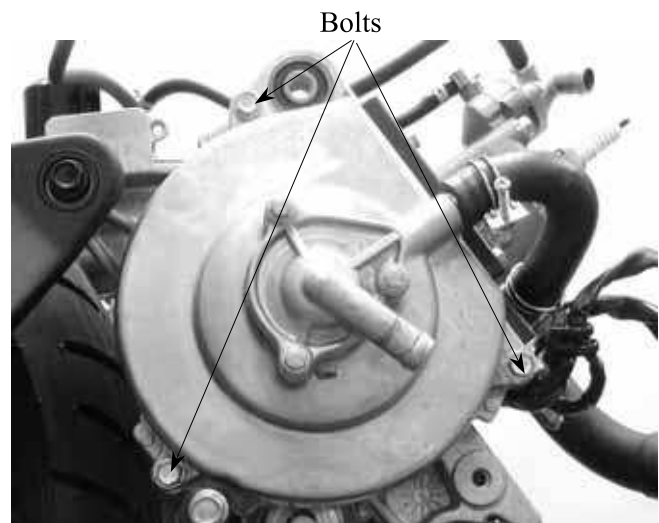

Hold the flywheel with an universal holder and then remove the flywheel nut.

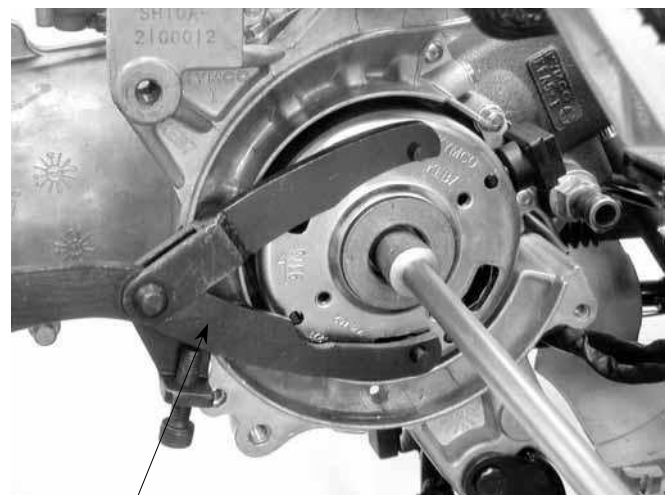

Universal Holder

## 9. A.C. GENERATOR

〈SF10DA〉

### A.C. GENERATOR REMOVAL

Remove the three bolts attaching the fan cover to remove the fan cover.

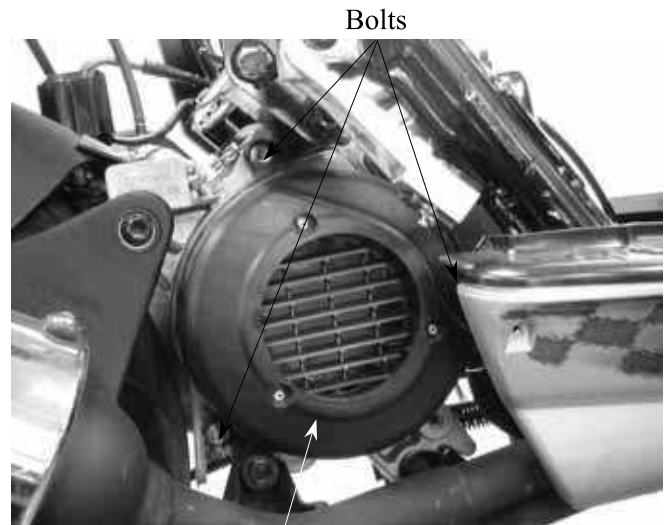

Fan Cover

Remove the cooling fan by removing the four bolts.

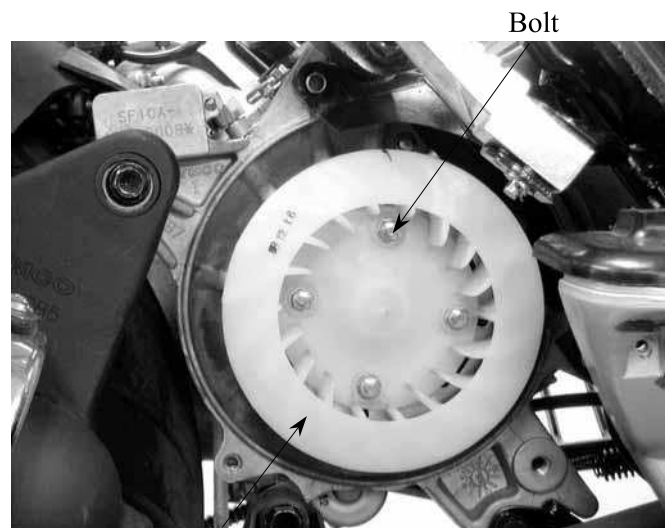

Cooling Fan

Hold the flywheel with an universal holder and then remove the flywheel nut.



Universal Holder

## 9. A.C. GENERATOR

Remove the A.C. generator flywheel using the flywheel puller.



Lock Nut Wrench

Flywheel Puller

Remove the A.C. generator wire connector.

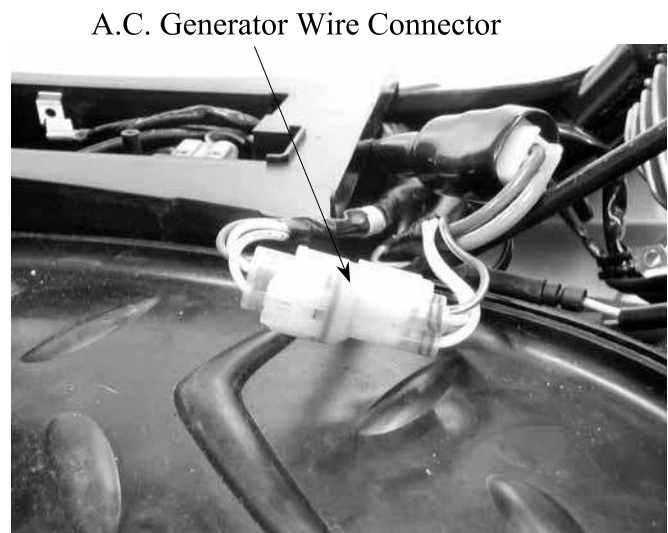

A.C. Generator Wire Connector

Remove the two pulser coil bolts and pulser coil from the right crankcase.  
Remove the pulser coil wire clamp from the right crankcase.  
Remove the two bolts attaching the A.C. generator stator.

\* Be careful not to damage the disconnected wire.

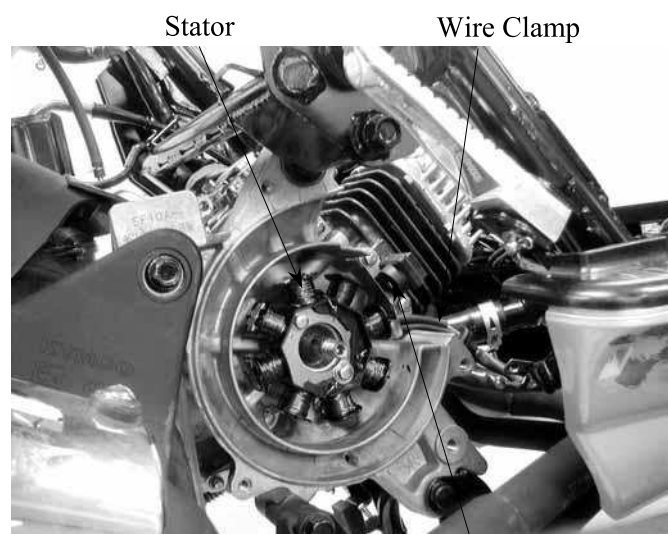

Stator

Wire Clamp

Pulser Coil

## 9. A.C. GENERATOR

### A.C. GENERATOR INSTALLATION

Install the A.C. generator stator and pulser coil wire clamp onto the right crankcase, and then install the pulser coil.

Connect the A.C. generator wire connector.

A.C. Generator Wire Connector



Clean the taper hole in the flywheel off any burrs and dirt.

Install the woodruff key in the crankshaft keyway.

Woodruff Key



Install the flywheel onto the crankshaft with the flywheel groove aligned with the crankshaft woodruff key.

Hold the flywheel with the universal holder and install the flywheel flange nut.

**Torque:** 34.3~39.2N-m

Start the engine and check the ignition timing. (⇒3-7)

Install other removed parts in the reserve order of removal.

Universal Holder





## **10. CRANKCASE/CRANKSHAFT**

---

## 10. CRANKCASE/CRANKSHAFT

---

g rod big end radial clearance	—	0.04
Crankshaft runout A/B	—	0.15/0.10

### SPECIAL TOOLS

Crankcase puller

Universal bearing puller

Crankcase assembly collar

Crankcase assembly tool

Bearing outer driver handle A

Bearing outer driver, 42x47mm

Bearing driver pilot, 20mm

Bearing outer driver, 37x40mm

Bearing driver pilot, 17mm

### TROUBLESHOOTING

#### Abnormal engine noise

- Excessive crank journal bearing play
- Excessive crankpin bearing play
- Excessive transmission bearing play

# 10. CRANKCASE/CRANKSHAFT

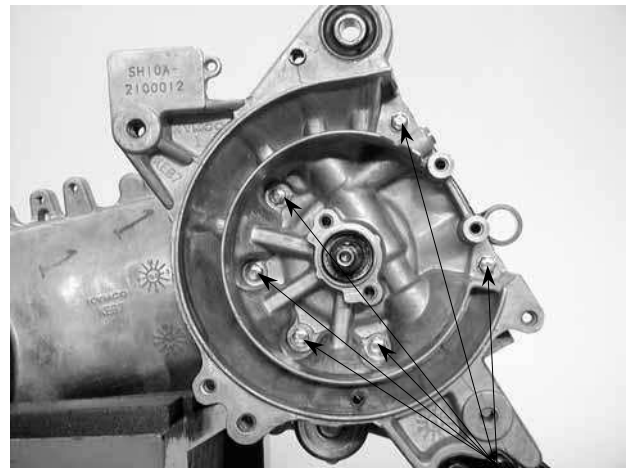

Bolts

r



Crankcase Puller



When removing the crankshaft, do it slowly and gently.

# 10. CRANKCASE/CRANKSHAFT

---



Universal Bearing Puller

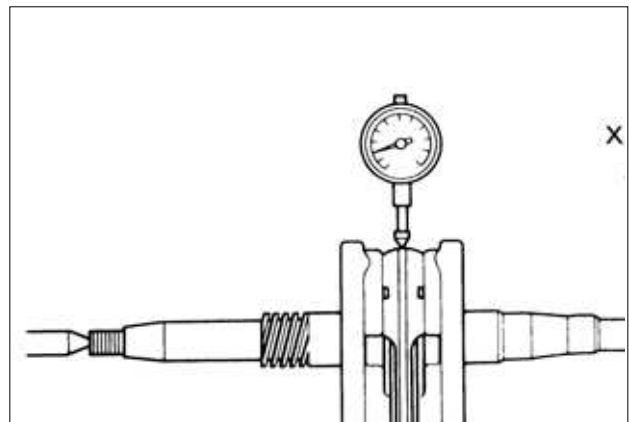
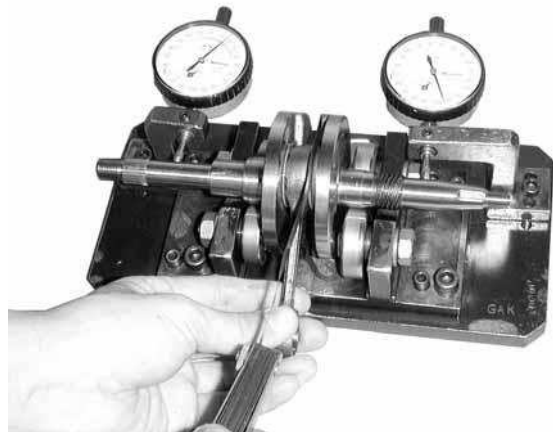

# 10. CRANKCASE/CRANKSHAFT

---

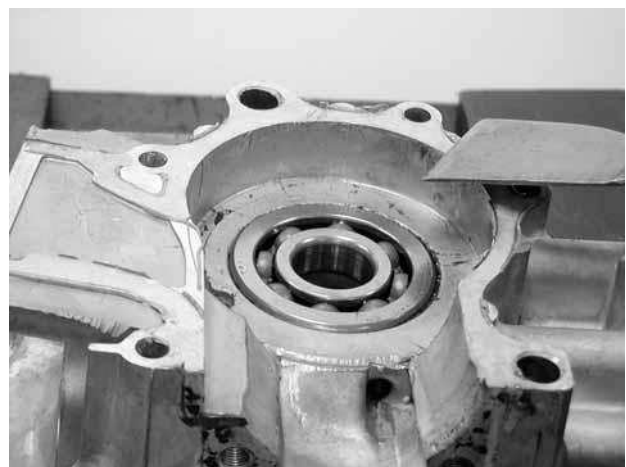
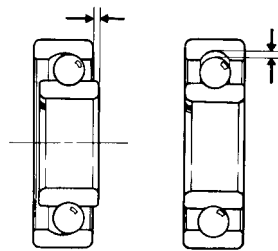

## 10. CRANKCASE/CRANKSHAFT

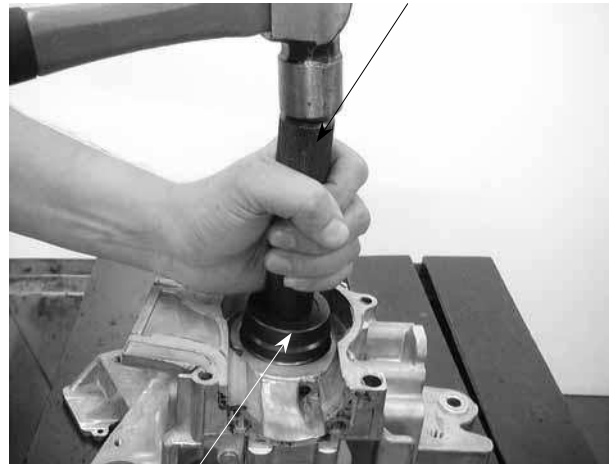

Bearing Driver Pilot, 17mm m



Bearing Outer Driver, 42x47mm  
Pilot, 20mm

Crankcase Assembly Tool



Crankcase Assembly Collar

- Apply KYMCO ULTRA motor oil or molybdenum disulfide to the crankshaft bearings and connecting rod big end.
- Apply grease to the lip of the oil seal and then install it.

# 10. CRANKCASE/CRANKSHAFT

---

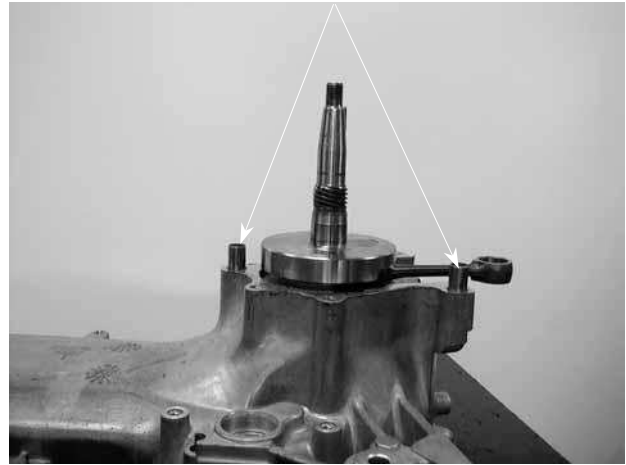

## 10. CRANKCASE/CRANKSHAFT

---

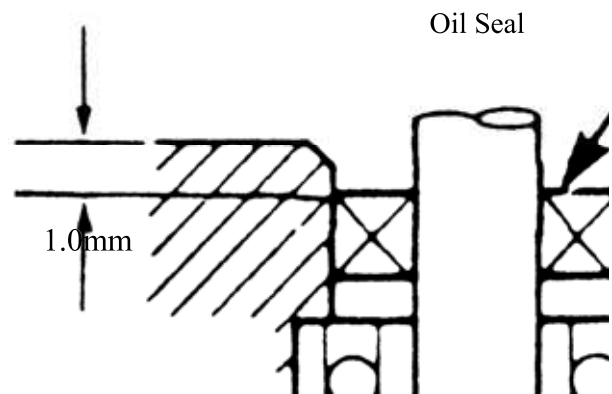

After assembly, check the crankshaft for smooth operation.

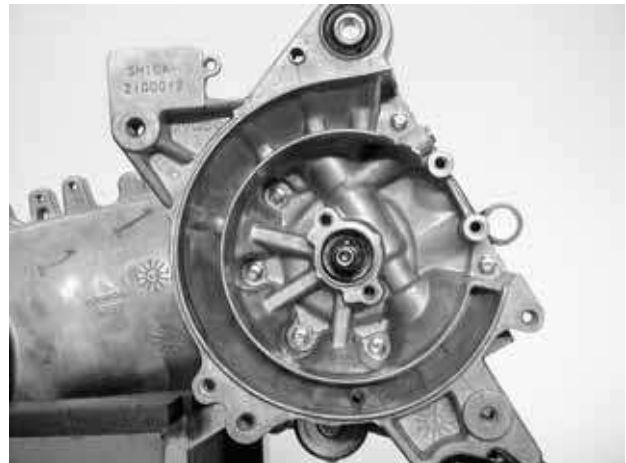



# 11. COOLING SYSTEM

---



## COOLING SYSTEM

---

SERVICE INFORMATION-----	11- 1
TROUBLESHOOTING-----	11- 1
RADIATOR -----	11- 3
WATER PUMP -----	11- 6
THERMOSENSOR-----	11-12
THERMOSTAT-----	11-13

# 11. COOLING SYSTEM

---

## SERVICE INFORMATION

### GENERAL INSTRUCTIONS

- The water pump must be serviced after removing the engine. Other cooling system service can be done with the engine installed in the frame.
- The engine must be cool before servicing the cooling system.  
When the coolant temperature is over 100°C, never remove the radiator cap to release the pressure because the boiling coolant may cause danger.
- Avoid spilling coolant on painted surfaces because the coolant will corrode the painted surfaces. Wash off any spilled coolant with fresh water as soon as possible.
- After servicing the system, check for leaks with a cooling system tester.

### SPECIAL TOOL

Mechanical seal driver

### TORQUE VALUES

Water pump impeller	9.8~13.72N-m
Water pump cover bolt	7.84~11.76N-m

## TROUBLESHOOTING

### Engine temperature too high

- Faulty temperature gauge or thermosensor
- Faulty radiator cap
- Faulty thermostat
- Insufficient coolant
- Passages blocked in hoses or water jacket
- Clogged radiator fins
- Passages blocked in radiator
- Faulty water pump

### Temperature gauge pointer does not register the correct coolant temperature

- Faulty temperature gauge or thermosensor
- Faulty thermostat

### Coolant leaks

- Faulty pump mechanical (water) seal
- Deteriorated O-rings
- Damaged or deteriorated water hoses

# 11. COOLING SYSTEM

## SPECIFICATIONS

Thermostat temperature	Begins to open	80±2°C	
	Full-open	90°C	
	Valve lift	3.5~4.5mm	
Coolant capacity		Total system 1165cc	Radiator: 825cc Reserve tank: 340cc

## COOLANT GRAVITY

Temp. °C \ Coolant concentration	0	5	10	15	20	25	30	35	40	45	50
5%	1.009	1.009	1.008	1.008	1.007	1.006	1.005	1.003	1.001	0.009	0.997
10%	1.018	1.107	1.017	1.016	1.015	1.014	0.013	1.011	1.009	1.007	1.005
15%	1.028	1.027	1.026	1.025	1.024	1.022	1.020	1.018	1.016	1.014	1.012
20%	1.036	1.035	1.034	1.033	1.031	1.029	1.027	1.025	1.023	1.021	1.019
25%	1.045	1.044	1.043	1.042	1.040	1.038	1.036	1.034	1.031	1.028	1.025
30%	1.053	1.051	1.051	1.049	1.047	1.045	1.043	1.041	1.038	1.035	1.032
35%	1.063	1.062	1.060	1.058	1.056	1.054	1.052	1.049	1.046	1.043	1.040
40%	1.072	1.070	1.068	1.066	1.064	1.062	1.059	1.056	1.053	1.050	1.047
45%	1.080	1.078	1.076	1.074	1.072	1.069	1.056	1.063	1.062	1.057	1.054
50%	1.086	1.084	1.082	1.080	1.077	1.074	1.071	1.068	1.065	1.062	1.059
55%	1.095	1.093	1.091	1.088	1.085	1.082	1.079	1.076	1.073	1.070	1.067
60%	1.100	1.098	1.095	1.092	1.089	1.086	1.083	1.080	1.077	1.074	1.071

## COOLANT MIXTURE (WITH ANTI-RUST AND ANTI-FREEZING EFFECTS)

Freezing Point	Mixing Rate	KYMCO SIGMA Coolant Concentrate	Distilled Water
-9°C	20%		
-15°C	30%	360cc	825cc
-25°C	40%		
-37°C	50%		
-44.5°C	55%		

### Cautions for Using Coolant:

- Use coolant of specified mixing rate. (The mixing rate of 360cc KYMCO SIGMA coolant concentrate + 825cc distilled water is 30%.)
- Do not mix coolant concentrate of different brands.
- Do not drink the coolant which is poisonous.
- The freezing point of coolant mixture shall be 5°C lower than the freezing point of the riding area.

# 11. COOLING SYSTEM

## RADIATOR

### RADIATOR INSPECTION

Remove the front upper cover. (⇒2-3)

Remove the front lower cover. (⇒2-3)

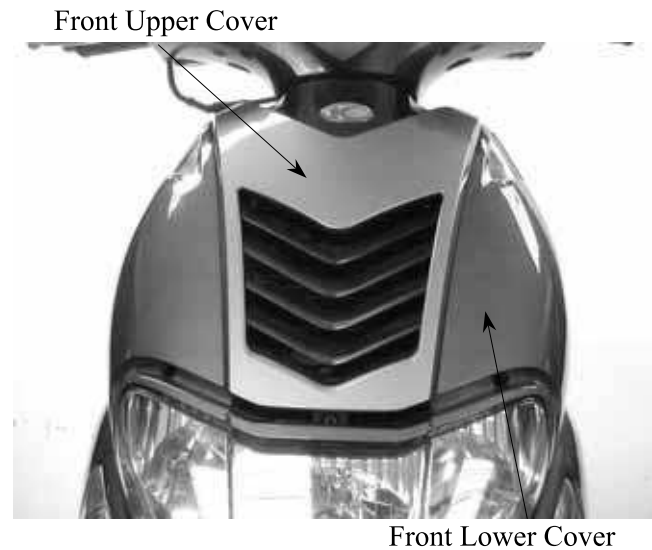

Inspect the radiator soldered joints and seams for leaks.  
 Blow dirt out from between core fins with compressed air. If insects, etc., are clogging the radiator, wash them off. Carefully straighten any bent fins.



### RADIATOR REMOVAL

Drain the coolant. (⇒3-10)

Loosen the hose band and disconnect the upper and lower hose from connect the radiator and reserve tank.

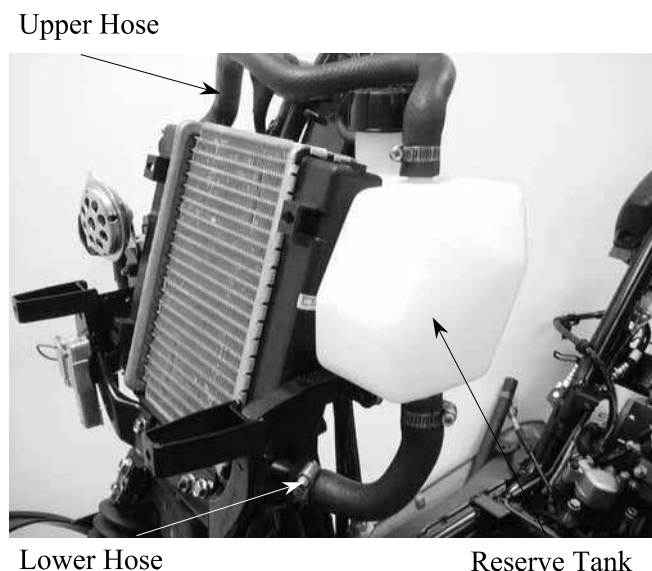

## 11. COOLING SYSTEM

Loosen the hose band and disconnect the upper hose from the radiator.

Upper Hose



Radiator

Loosen the hose band and disconnect the lower hose from the radiator.



Lower Hose

Remove the two bolts and the radiator.

Radiator

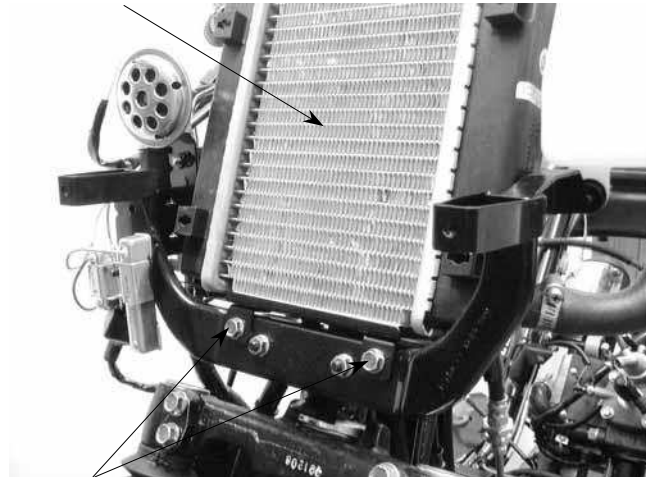

Bolts

# 11. COOLING SYSTEM

## RADIATOR BRACKET REMOVAL/ INSTALLATION

Remove the two nuts to remove the radiator bracket.  
The installation sequence is the reverse of removal.

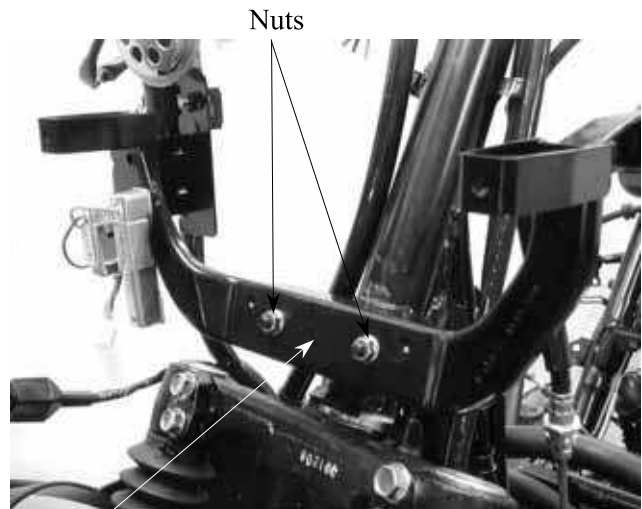

Radiator Bracket

## RADIATOR INSTALLATION

Install the radiator on the radiator bracket with the two bolts.

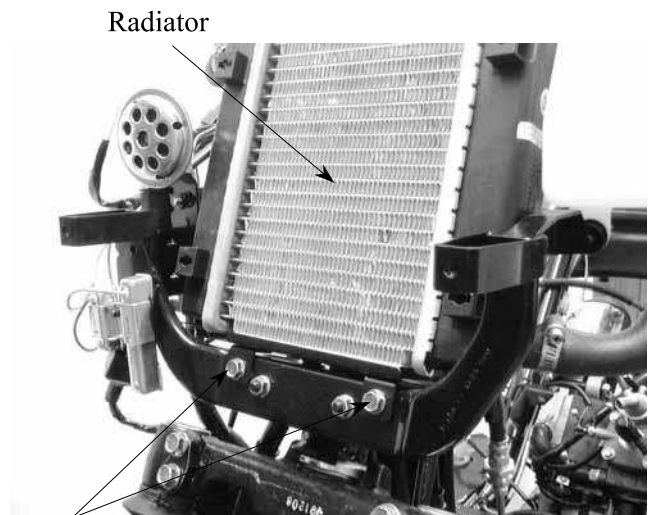

Bolts

Connect the upper and lower hoses and secure them with hose bands.

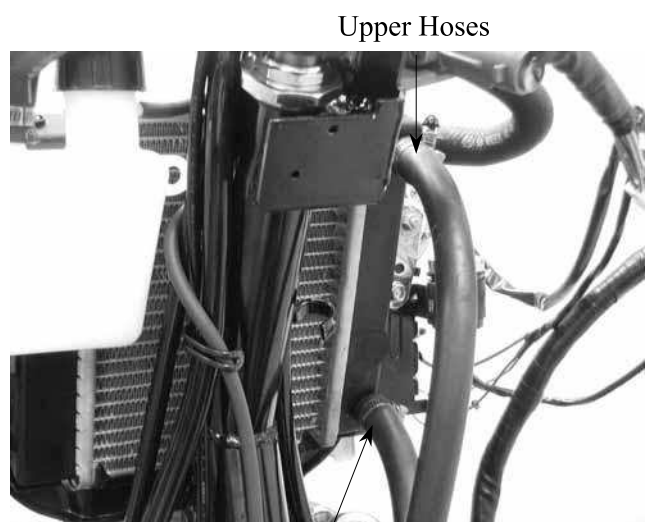

Lower Hoses

# 11. COOLING SYSTEM

Reinstall the upper and lower hoses, make sure the bands are secured.

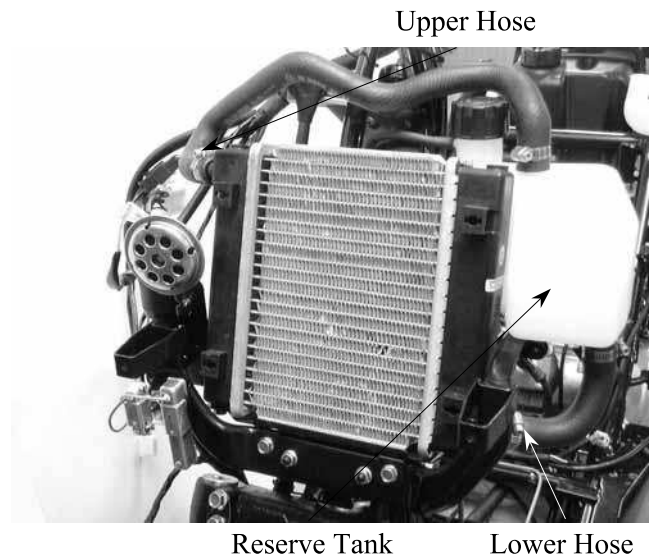

Fill the reserve tank with coolant. (⇒3-10)  
Check for coolant leaks.  
Install the front upper and lower cover.

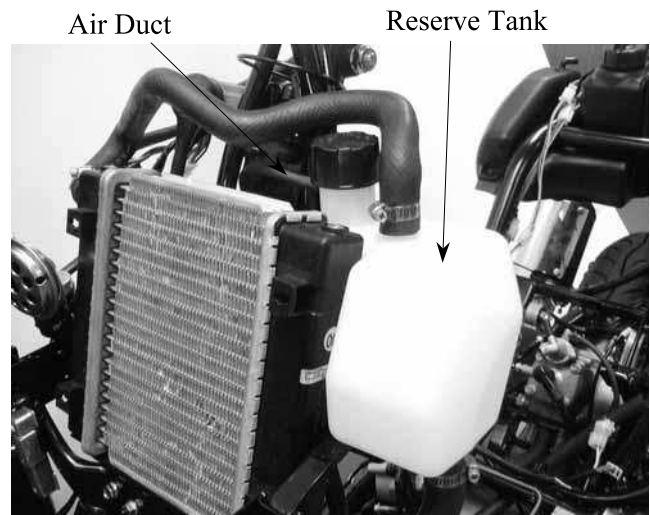

## WATER PUMP

### MECHANICAL SEAL (WATER SEAL) INSPECTION

Inspect the telltale hole for signs of mechanical seal coolant leakage.  
If the mechanical seal is leaking, remove the right crankcase cover and replace the mechanical seal.

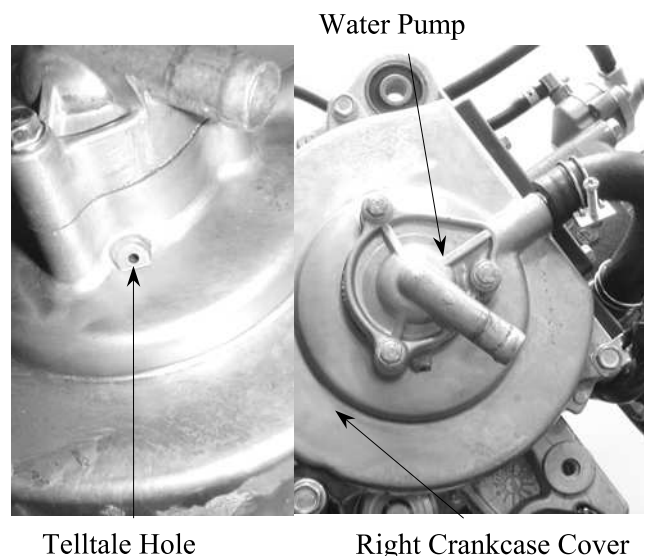

# 11. COOLING SYSTEM

## WATER PUMP/IMPELLER REMOVAL

Remove the engine from the frame. (⇒5-2)



Remove the three bolts and the water pump cover, gasket and two dowel pins.

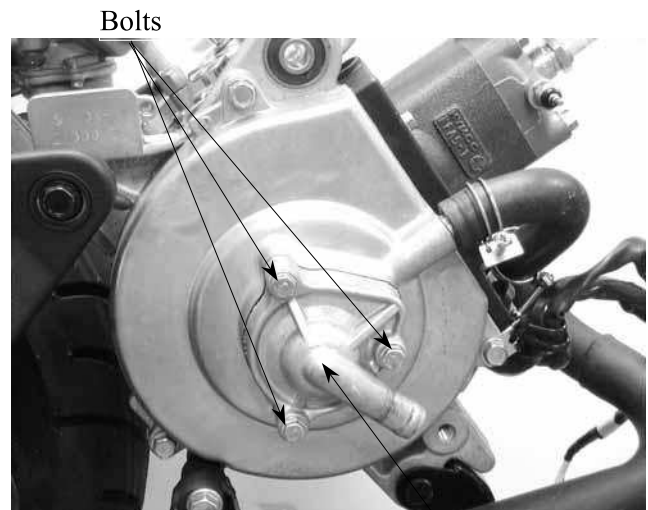

Water Pump Cover

Remove the water pump impeller.

\* The impeller has left hand threads.

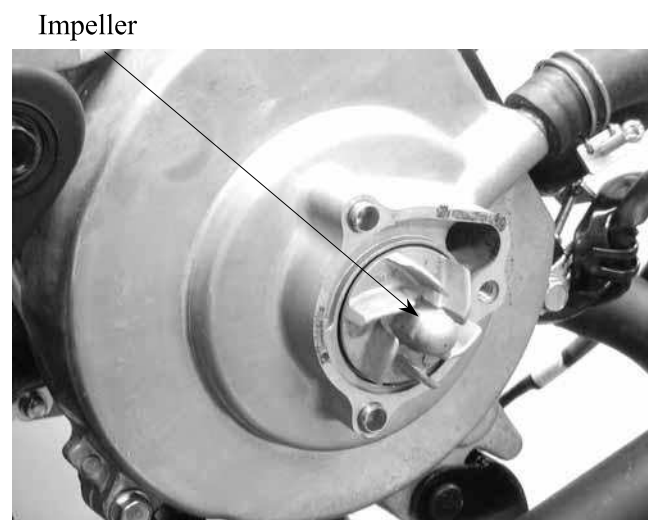



# 11. COOLING SYSTEM

Inspect the mechanical (water) seal and seal washer for wear or damage.

\* The mechanical seal and seal washer must be replaced as a set.

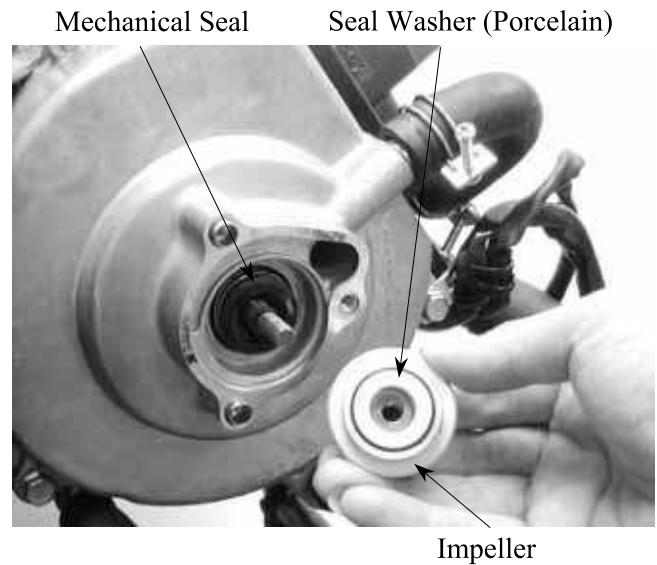

## WATER PUMP SHAFT REMOVAL

Disconnect the water hose from the right crankcase cover.  
 Remove the two timing cap bolts and the timing cap.  
 Remove the three bolts attaching the water pump assembly.  
 Remove the water pump assembly and dowel pins.

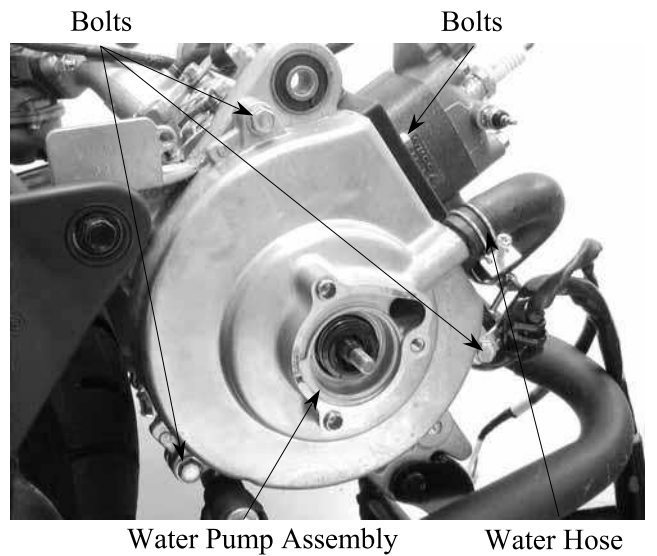

Remove the water pump shaft from the water pump assembly.

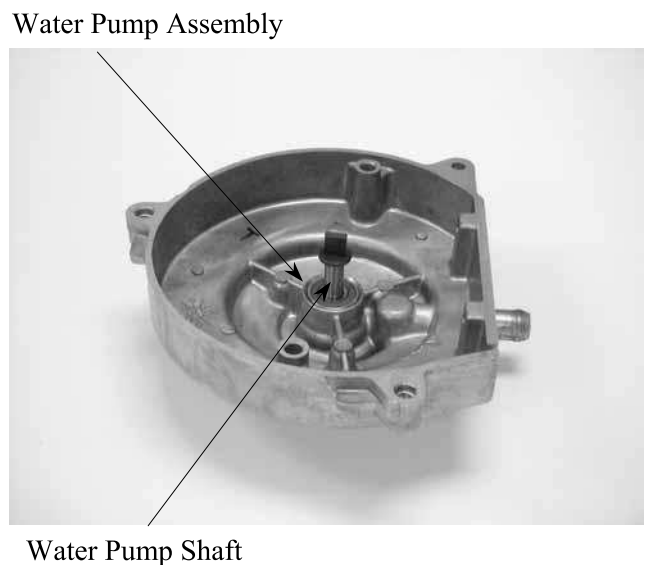

# 11. COOLING SYSTEM

**WATER PUMP BEARING/  
MECHANICAL SEAL REMOVAL**  
Remove the water pump shaft inside bearing.

Water Pump Assembly

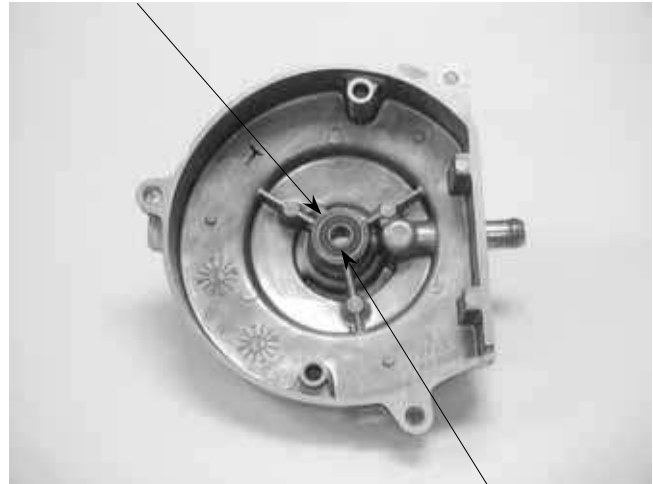

Inside Bearing

Drive the mechanical seal out of the water pump assembly from the outer.

Water Pump Assembly

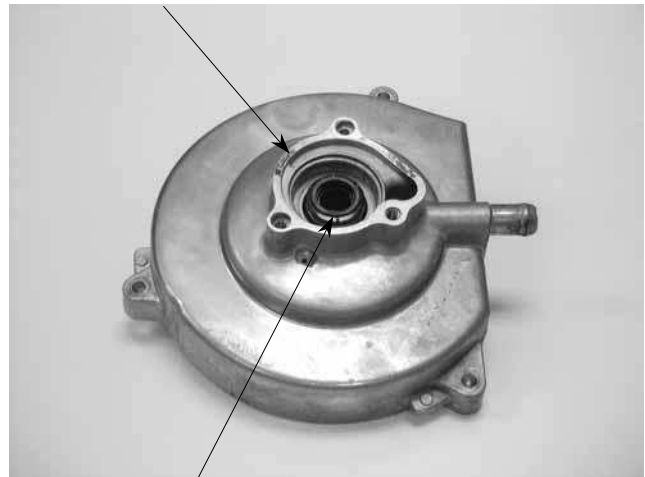

Mechanical Seal (Water Seal)

Remove the water pump shaft outer bearing.

Outer Bearing



# 11. COOLING SYSTEM

## WATER PUMP BEARING/ MECHANICAL SEAL INSTALLATION

Drive a new water pump shaft outer bearing into the water pump assembly from the inside.

Drive a new water pump shaft inside bearing into the water pump assembly from the inside.

Water Pump Assembly

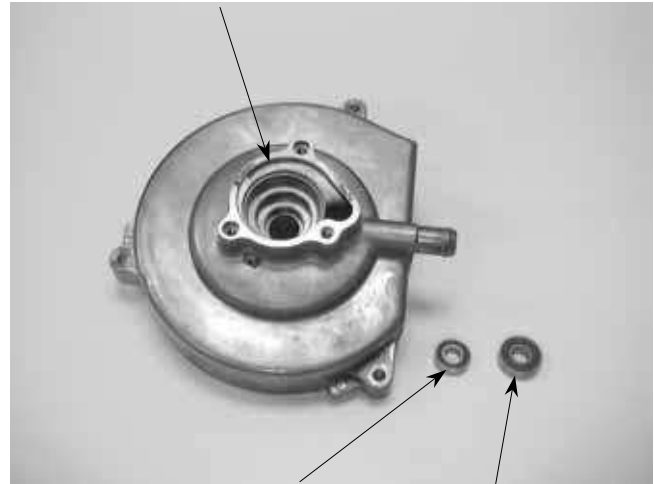

Outer Bearing

Inside Bearing

Drive in a new mechanical seal using a mechanical seal driver.

\* Apply sealant to the right crankcase cover fitting surface of a new mechanical seal and then drive in the mechanical seal.



Mechanical Seal

Install the water pump shaft into the water pump assembly.

Water Pump Shaft



# 11. COOLING SYSTEM

Install the dowel pins and then install the water pump assembly to the right crankcase.

Tighten the three bolts to secure the water pump assembly.

Install the two timing cap bolts and the timing cap.

\* When installing the water pump assembly, aligning the tab on the water pump shaft with the groove on the A.C. generator nut.



Water Pump Assembly  
 Bolts

## WATER PUMP/IMPELLER INSTALLATION

When the mechanical seal is replaced, a new seal washer must be installed to the impeller.

Install the impeller onto the water pump shaft.

**Torque:** 9.8 ~ 13.72N-m

\* The impeller has left hand threads.

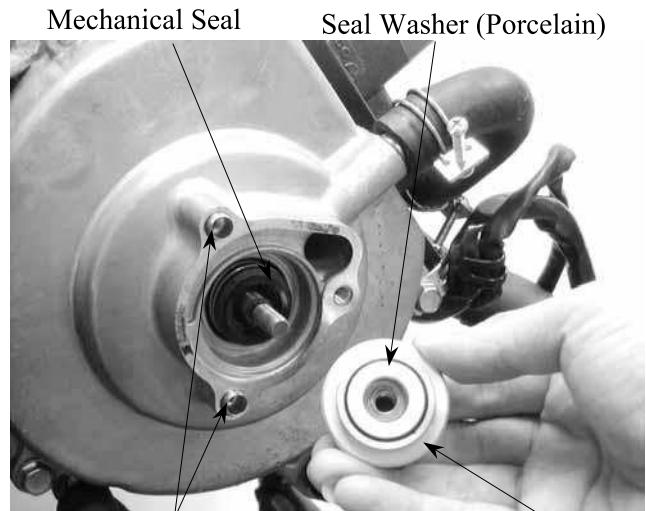

Mechanical Seal  
 Seal Washer (Porcelain)  
 Dowel Pins

Impeller

Install the two dowel pins and a new gasket. Install the water pump cover and tighten the three bolts.

**Torque:** 7.84 ~ 11.76N-m



Water Pump Cover  
 Bolts

# 11. COOLING SYSTEM

## THERMOSENSOR

### THERMOSENSOR REMOVAL

Remove the seat, met-in box and frame body cover.  
 Drain the coolant.  
 Disconnect the thermosensor wire.  
 Remove the thermosensor.

Thermosensor

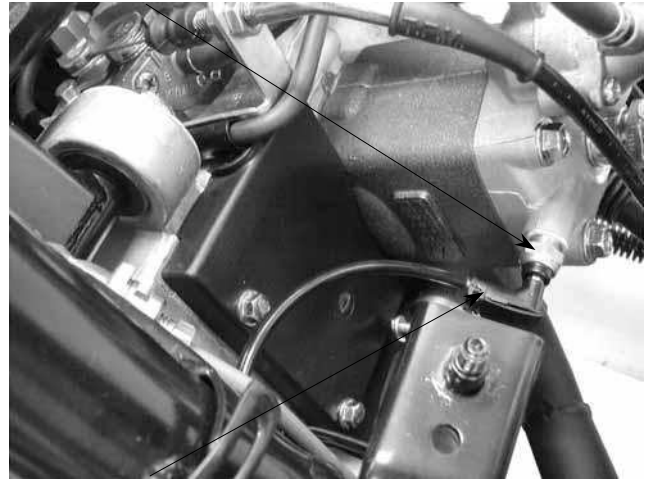

Thermosensor Wire

### THERMOSENSOR INSPECTION

Suspend the thermosensor in a pan of water over a burner and measure the resistance through the sensor as the water heats up.

Temperature(°C)	50	80	100	120
Resistance(Ω)	154	52	27	16

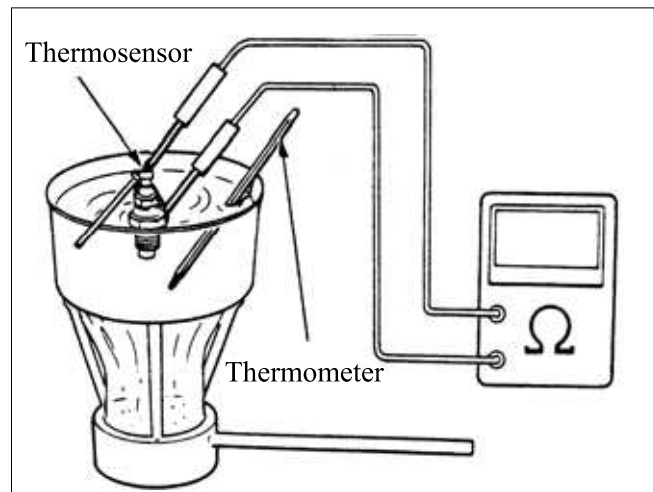

### THERMOSENSOR INSTALLATION

Apply 3-BOND No. 1212 sealant or equivalent to the cylinder head threads and install it into the thermostat housing.  
 Connect the thermosensor wire.  
 Fill the reserve tank with coolant. (⇒3-10)  
 Install the frame body cover, met-in box and seat. (⇒2-3)

\* Be sure to bleed air from the cooling system.

Thermosensor



# 11. COOLING SYSTEM

## THERMOSTAT

### THERMOSTAT REMOVAL

Remove the seat, met-in box and frame body cover.  
 Drain the coolant.  
 Disconnect the water hose from the thermostat housing.

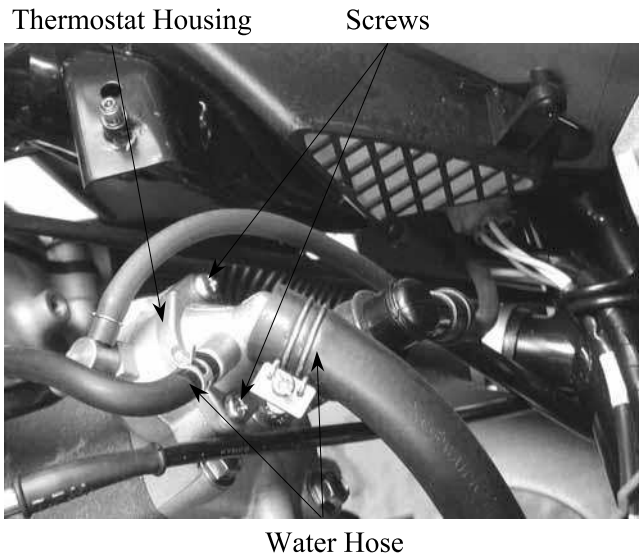

Remove the two screws and separate the thermostat housing cover .  
 Remove the thermostat from the thermostat housing.



Thermostat

### THERMOSTAT INSPECTION

Suspend the thermostat in a pan of water over a burner and gradually raise the water temperature to check its operation.

#### Technical Data

Begins to open	80±2°C
Full-open	90°C
Valve lift	3.5~4.5mm

- \* Do not let the thermostat touch the pan as it will give a false reading.  
 • Replace the thermostat if the valve stays open at room temperature.  
 • Test the thermostat after it is opened for about 5 minutes and holds the temperature at 70°C.

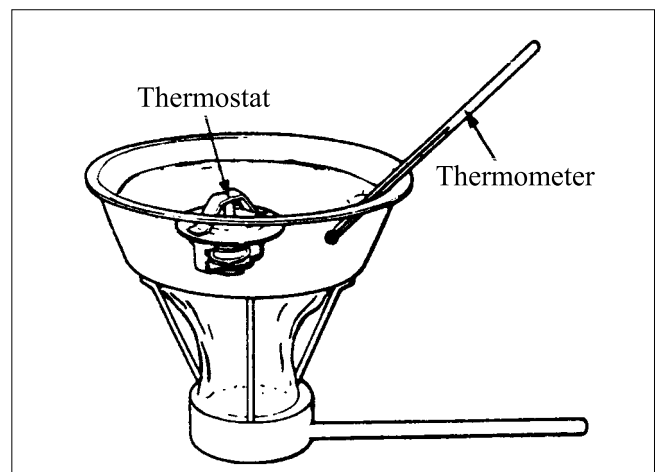

# 11. COOLING SYSTEM

---

## THERMOSTAT INSTALLATION

The installation sequence is the reverse of removal.

Fill the cooling system with the specified coolant. (⇒3-10)



Thermostat Housing

## 12. CARBURETOR

---

---

---

---

---

---

---

---

---

---

### CARBURETOR

---

SERVICE INFORMATION .....	12- 1
TROUBLESHOOTING .....	12- 1
THROTTLE VALVE DISASSEMBLY .....	12- 2
THROTTLE VALVE INSTALLATION.....	12- 3
CARBURETOR REMOVAL .....	12- 4
AUTO BYSTARTER.....	12- 5
FLOAT CHAMBER .....	12- 7
FLOAT LEVEL INSPECTION .....	12- 9
CARBURETOR INSTALLATION .....	12-10
AIR SCREW ADJUSTMENT .....	12-10
REED VALVE .....	12-11





# 12. CARBURETOR

## SERVICE INFORMATION

### GENERAL INSTRUCTIONS

- When working with gasoline, keep away from sparks and flames..
- Note the locations of O-rings when disassembling and replace them with new ones during assembly.
- All cables, fuel lines and wires must be routed and secured at correct locations.
- Bleed air from the oil lines whenever they are disconnected.

### SPECIFICATIONS

	SH10DA	SF10DA
Venturi dia.	14mm	
Identification number	PB093 	PB058 
Float level	8.6mm	
Main jet(Unlimited/limited speed)	#92/#78	
Slow jet	#35	
Air screw opening	1¼± ½	
Idle speed	2000±100rpm	1900±100rpm
Throttle grip free play	2~6mm	

### SPECIAL TOOL

Float level gauge

### TROUBLESHOOTING

#### Engine does not start

- No fuel in tank
- Too much fuel getting to cylinder
- Clogged fuel filter
- Clogged air cleaner

#### Lean mixture

- Clogged fuel jets
- Clogged fuel cap vent
- Clogged fuel filter
- Bent, kinked or restricted fuel line

- Faulty float valve
- Float level too low
- Clogged air cleaner

#### Engine idles roughly, stalls or runs poorly

- Incorrect idle speed
- Ignition malfunction
- Compression too low
- Incorrectly adjusted air screw
- Incorrect float level
- Clogged air cleaner
- Intake air leaks
- Fuel contaminated
- Faulty reed valve
- Clogged fuel jets

#### Rich mixture

- Faulty float valve
- Float level too high
- Clogged air jets

## 12. CARBURETOR

### THROTTLE VALVE DIS-ASSEMBLY

Remove the rear carrier. (⇒2-3)  
Remove the met-in box. (⇒2-4)  
Loosen the carburetor cap and remove the throttle valve.



Carburetor Cap

Disconnect the throttle cable from the throttle valve.



Throttle Valve

Remove the throttle valve spring, carburetor cap and rubber seal.

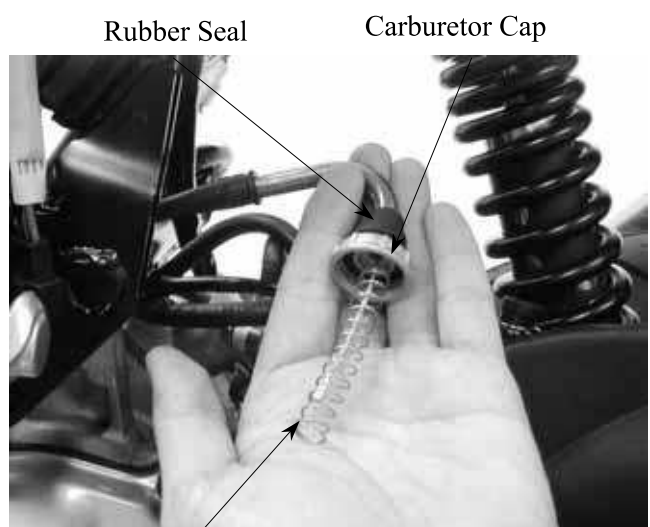

Rubber Seal

Carburetor Cap

Spring

## 12. CARBURETOR

Remove the jet needle by removing the needle clip.  
 Check the jet needle and throttle valve for wear or damage.

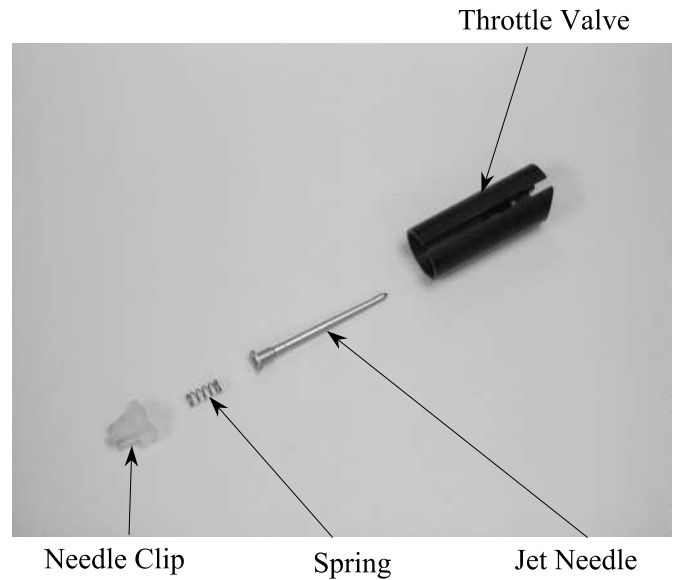

### THROTTLE VALVE INSTALLATION

Install the jet needle on the throttle valve and secure with the needle clip.

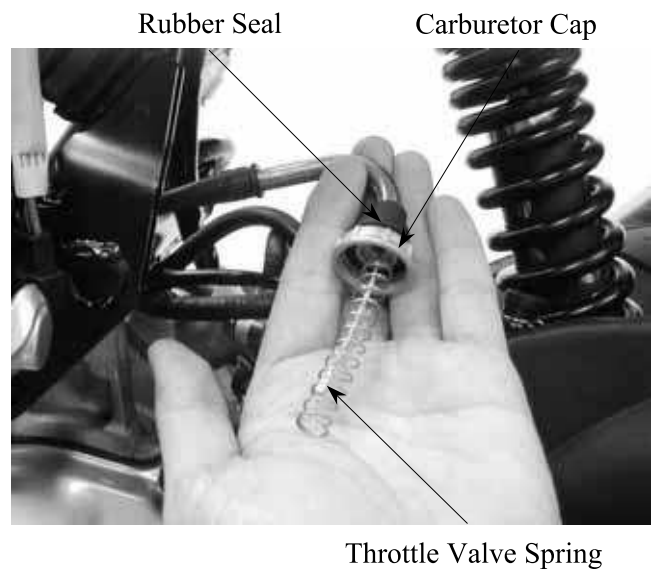

Install the rubber seal on the throttle cable and then install the carburetor cap and throttle valve spring.  
 Connect the throttle cable to the throttle valve.

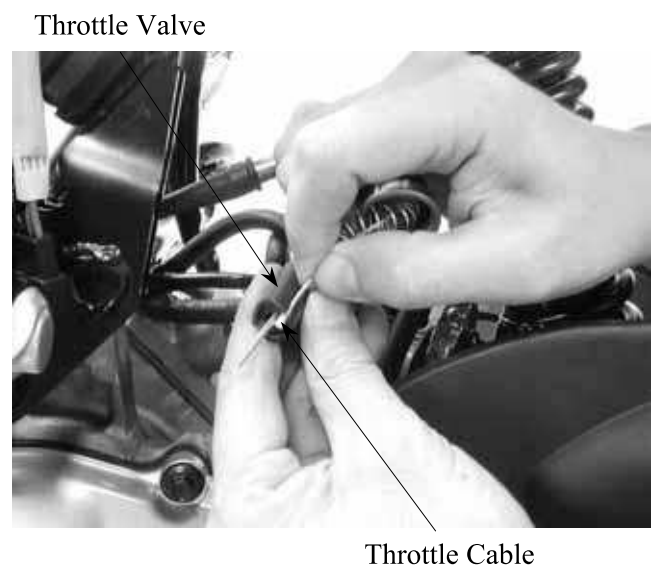

## 12. CARBURETOR

Install the throttle valve by aligning the groove in the throttle valve with the throttle stop screw.

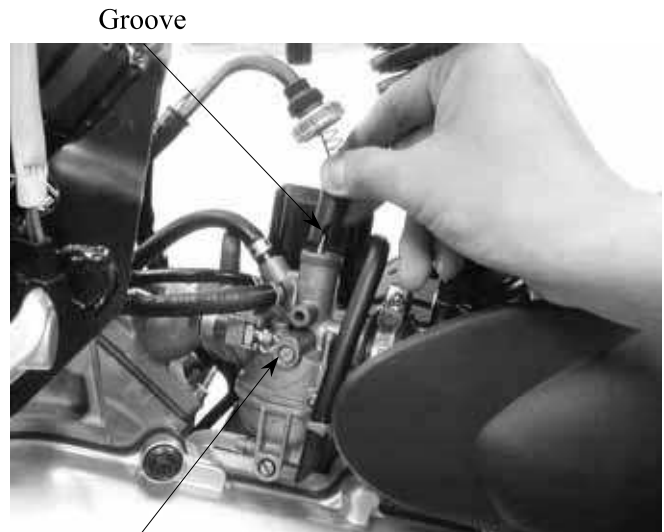

Groove  
 Throttle Stop Screw

Tighten the carburetor cap.  
 After installation, perform the following adjustments and inspections.

- Throttle cable free play (⇒3-12)
- Idle speed adjustment (⇒3-11)

Install the met-in box.



Carburetor Cap

### CARBURETOR REMOVAL

Remove the met-in box. (⇒2-3)  
 Remove the air cleaner by removing the air cleaner band screw and attaching bolts.  
 Disconnect the fuel tube.  
 Loosen the drain bolt to drain fuel from the carburetor.  
 Disconnect the auto bystarter wire connector.

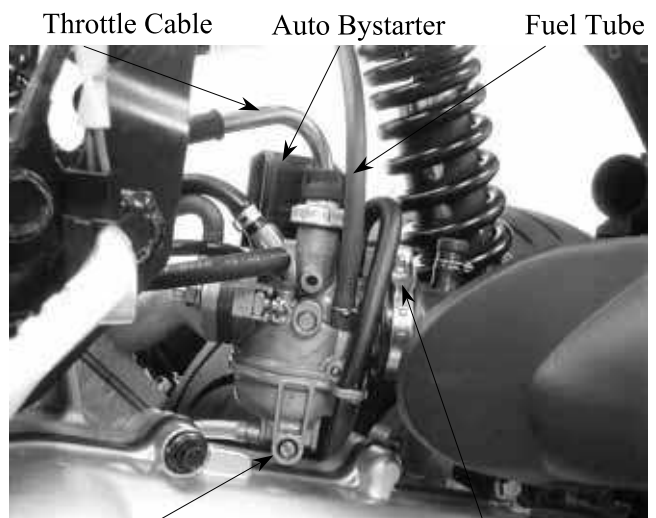

Throttle Cable  
 Auto Bystarter  
 Fuel Tube  
 Drain Bolt

Band

## 12. CARBURETOR

Remove the two carburetor lock nuts.  
 Remove the carburetor and water hose.

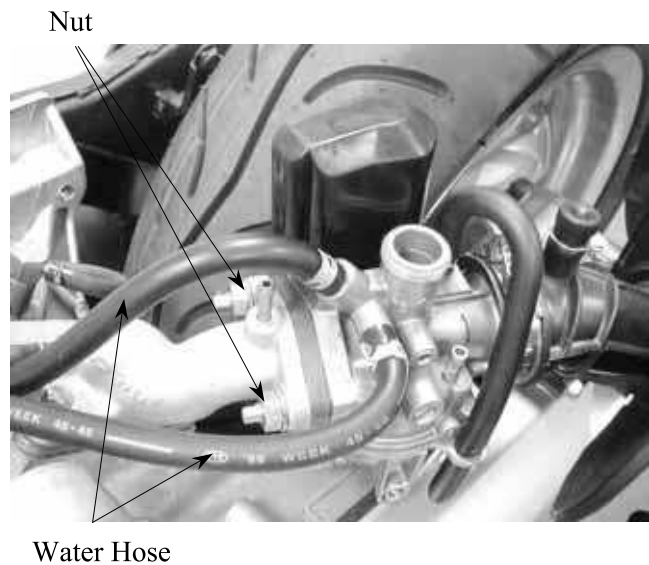

### AUTO BYSTARTER

#### AUTO BYSTARTER INSPECTION

Measure the resistance between the auto bystarter wire terminals.

**Resistance:**  $5\Omega$  (10 minutes minimum after stopping the engine)

If the resistance exceeds  $5\Omega$ , replace the auto bystarter with a new one.

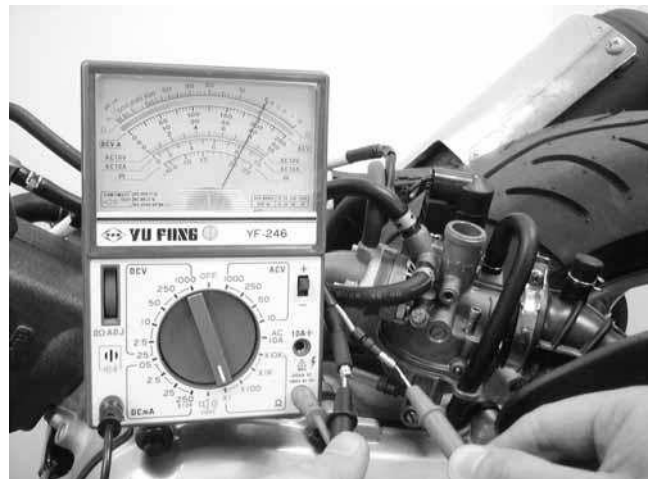

After the engine stops for 30 minutes, connect a hose to the fuel enriching circuit and blow the hose with mouth.  
 If air cannot be blown into the hose (clogged), the auto bystarter is faulty.  
 Replace it with a new one.

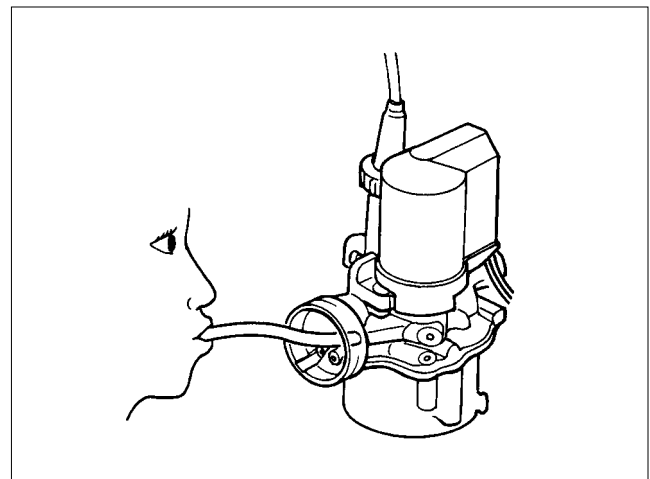

## 12. CARBURETOR

Connect the auto bystarter yellow wire to the battery positive (+) terminal and green/black wire to the battery negative (-) terminal and wait 5 minutes.  
 Connect a hose to the fuel enriching circuit and blow the hose with mouth.  
 If air can be blown into the hose, the auto bystarter is faulty and replace it with a new one.

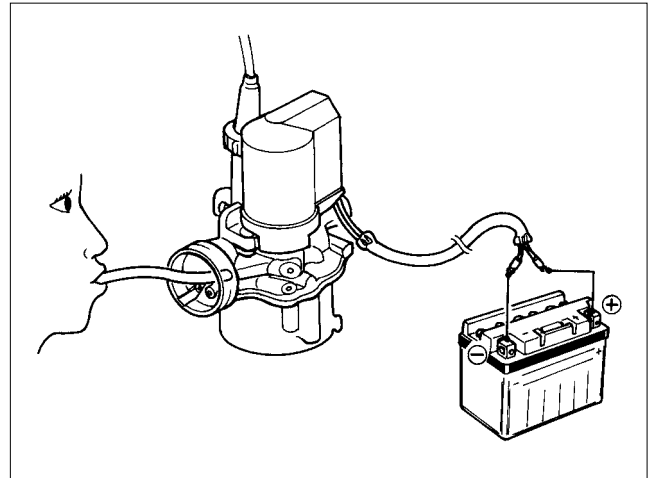

### AUTO BYSTARTER REMOVAL

Remove the auto bystarter cover.  
 Remove the two auto bystarter set plate screws to remove the auto bystarter.

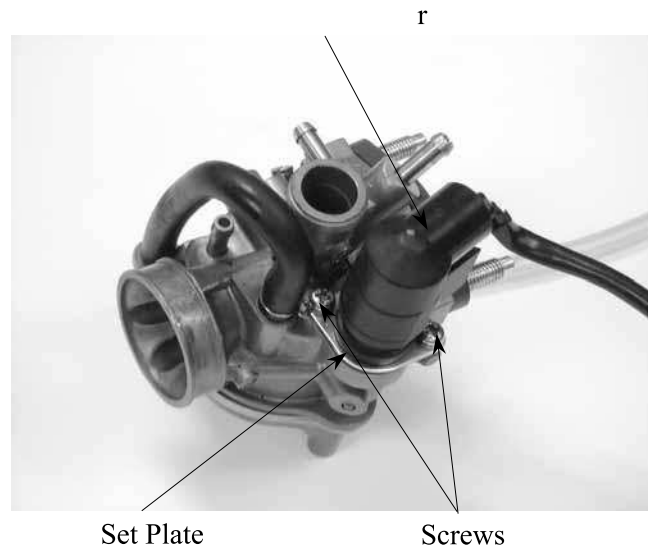

Check the auto bystarter valve and needle for wear or damage.  
 Check the O-ring for wear or damage.

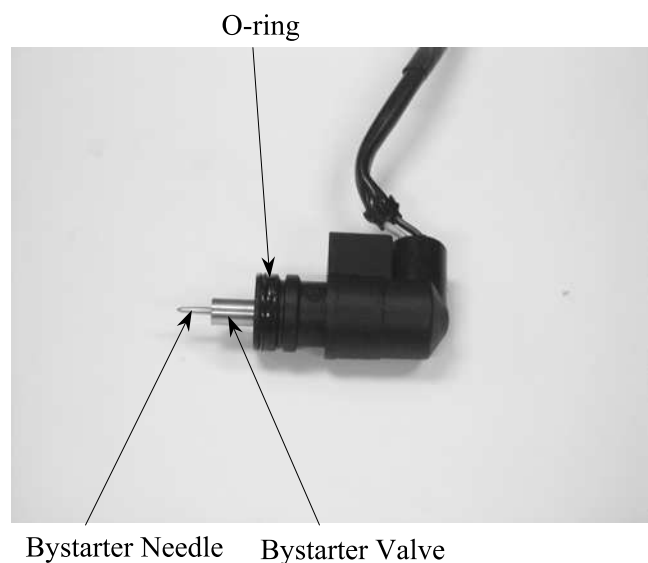

## 12. CARBURETOR

### AUTO BYSTARTER INSTALLATION

Install the auto bystarter into the carburetor body until it bottoms..  
Install the set plate and then tighten the two screws.

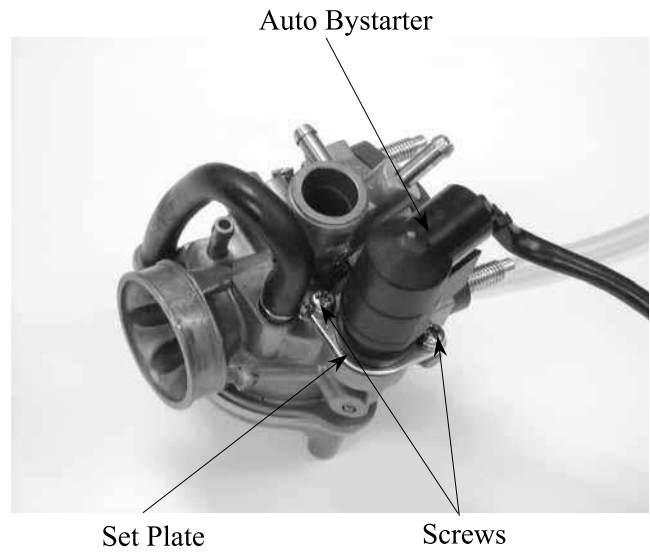

### FLOAT CHAMBER

Remove the two float chamber screws and the float chamber.

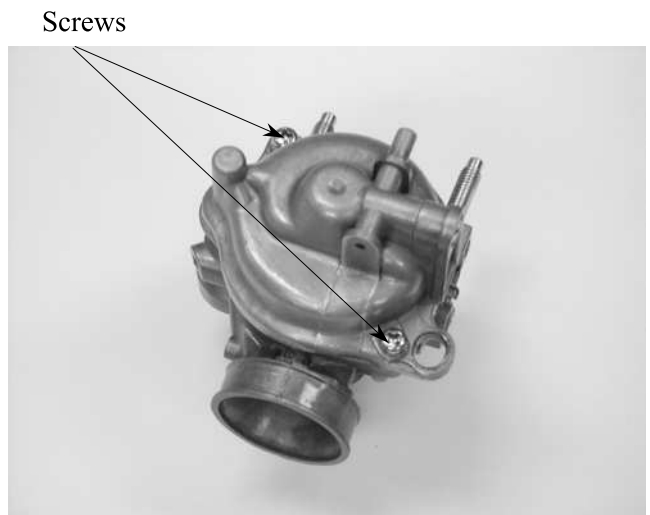

Remove the screw and O-ring.  
Remove the float pin, float and float valve.

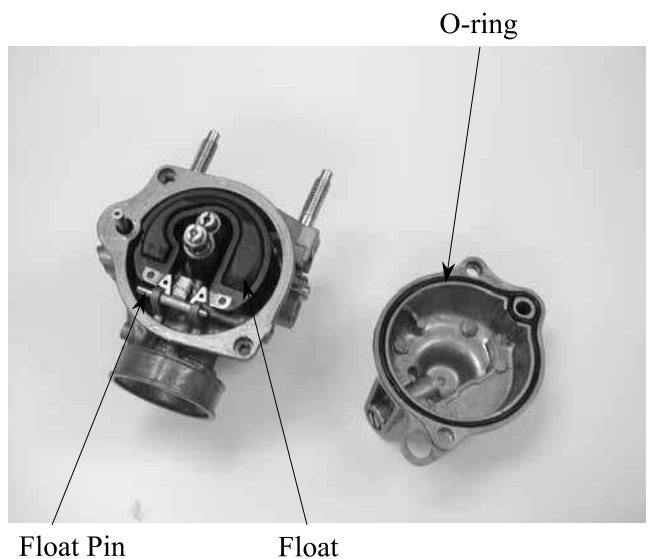

## 12. CARBURETOR

### FLOAT/FLOAT VALVE INSPECTION

Inspect the float for damage or fuel inside the float.  
Check the float valve seat for wear or damage.

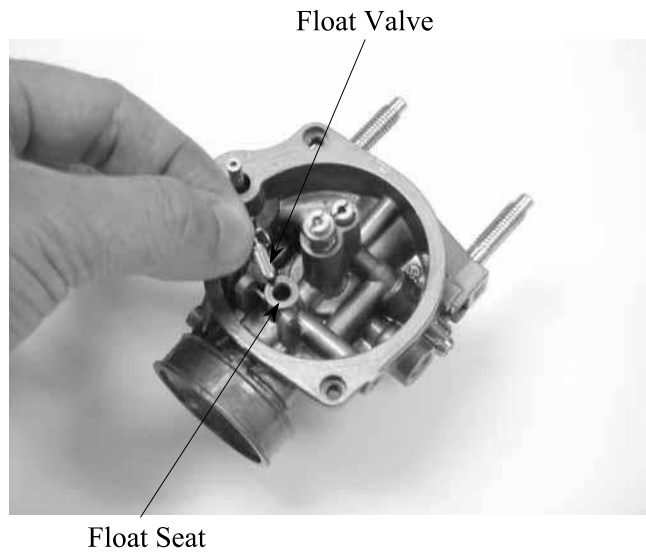

### JETS/SCREWS REMOVAL

Before removing the throttle stop screw or air screw, record the number of rotations until it seats lightly. Then, remove them.

\* Do not force the air screw against its seat to prevent damage.

Remove the main jet and needle jet holder.

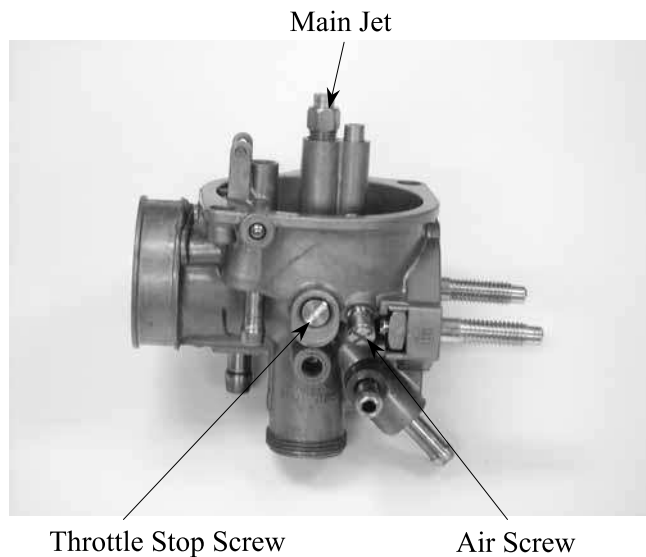

### CARBURETOR PASSAGES CLEANING

Blow compressed air through all passages of the carburetor body with an air gun.

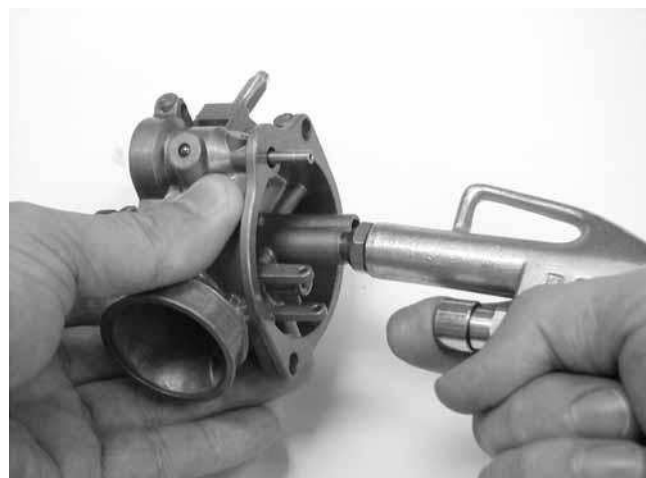



# 12. CARBURETOR

## FLOAT CHAMBER ASSEMBLY

Install the main jet and needle jet holder.  
Install the air screw and throttle stop screw according to the rotations recorded.

\* If the air screw must be replaced, be sure to perform the air screw adjustment again.

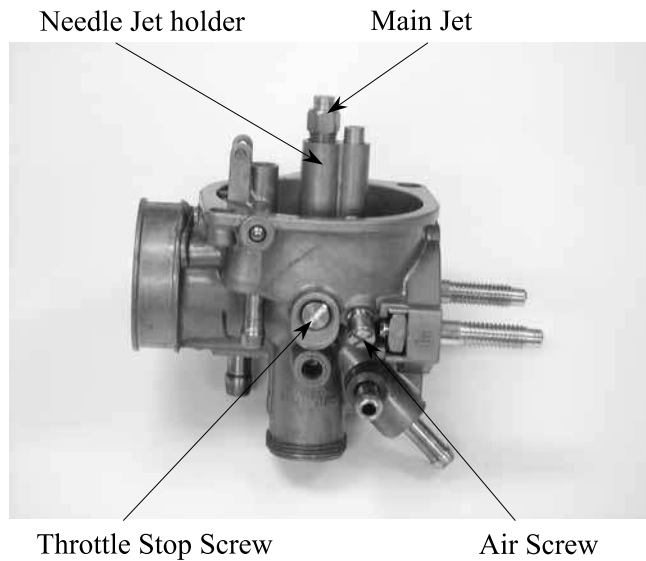

Install the float valve, float and float pin.  
Tighten the float screw securely.

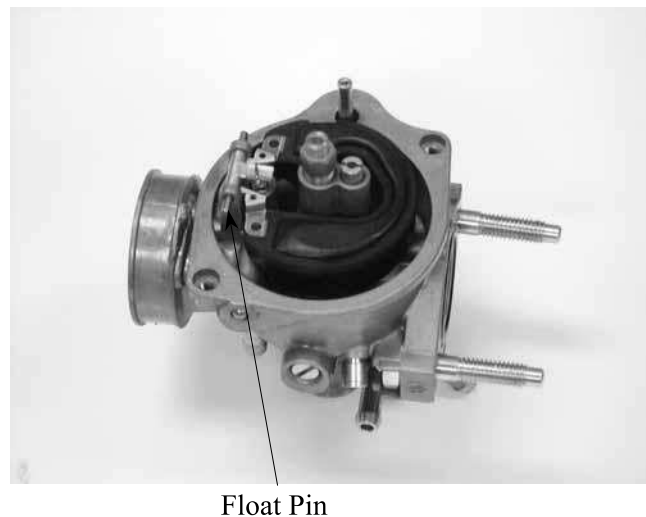

## FLOAT LEVEL INSPECTION

Slightly tilt the carburetor and measure the float level with the float valve just connecting the float arm.

**Float Level:** 8.6 mm

Replace the float if the level is out of the specified level range.

Install the O-ring.

Check the operation of the float and install the float chamber.

Tighten the screws.

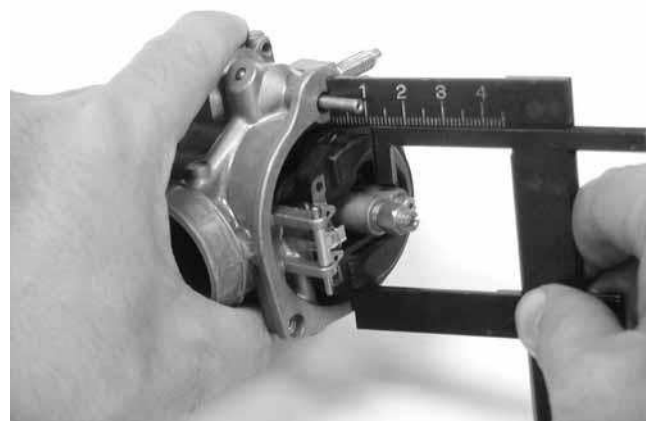

## 12. CARBURETOR

### CARBURETOR INSTALLATION

- \* When installation, do not allow foreign particles to enter the carburetor.

Check the carburetor insulator and O-ring for wear or damage.  
Install the carburetor and insulator onto the intake manifold and tighten the two lock nuts.  
Connect the fuel tube and auto bystarter wire connector.

- \* Route the auto bystarter wire correctly and properly.

Install the carburetor cap. (⇒12-4)  
Install the air cleaner onto the carburetor and tighten the band screw.  
Install the met-in box. (⇒2-3)

### AIR SCREW ADJUSTMENT

Remove the met-in box. (⇒2-3)

- \* Warm up the engine before air screw adjustment.

Turn the air screw clockwise until it seats lightly and back it to the specification given.

#### Air Screw Opening:

SH10DA:  $1\frac{1}{4} \pm \frac{1}{2}$  turns

Start the engine and turn the air screw in or out slowly to obtain the highest engine speed.

- \* Do not force the air screw against its seat to prevent damage.

Turn the throttle stop screw to obtain the specified idle speed.

#### Idle Speed:

SH10DA:  $2000 \pm 100$ rpm

Slightly increase the engine speed and make sure that the engine does not miss or run erratic.  
If the adjustment of the air screw within the range of  $\pm\frac{1}{2}$  turn makes no difference to the engine performance, check other related items.

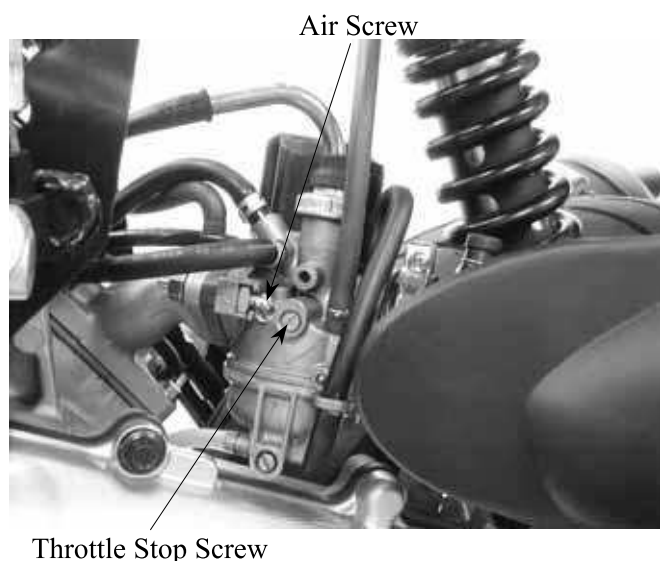
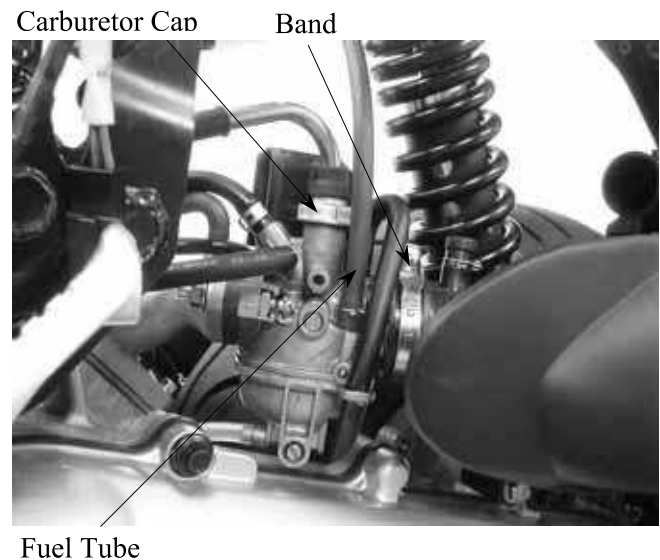
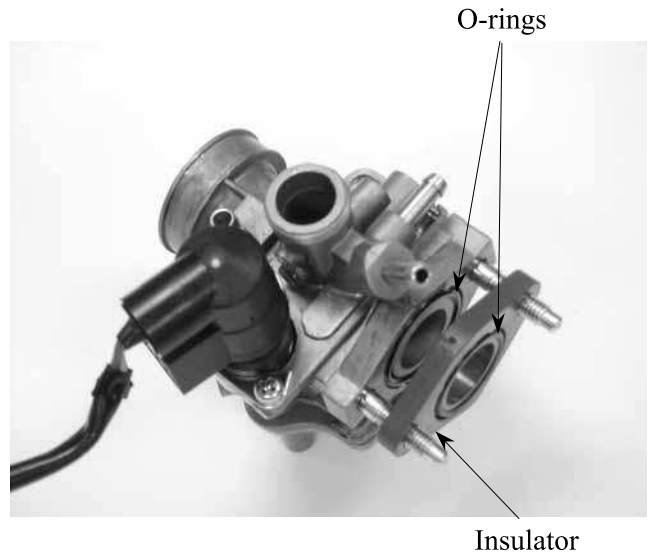

## 12. CARBURETOR

### REED VALVE

#### REMOVAL

Remove the rear carrier.  
Remove the frame body cover.  
Remove the four intake manifold bolts and gasket.  
Remove the reed valve and gasket.

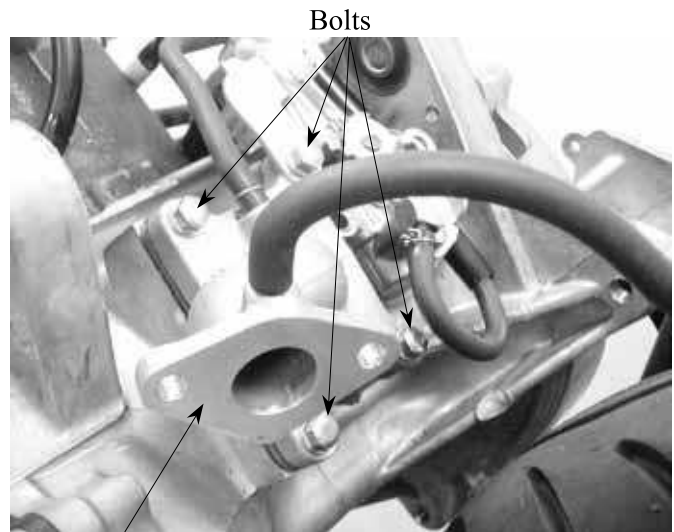

Intake Manifold

#### INSPECTION

Check the reed valve for damaged or weak reeds.  
Check the reed valve seat for cracks, damage or clearance between the seat and reed.  
Replace the valve if necessary.

\* Do not disassemble or bend the reed stopper. To do so can cause loss of engine power and engine damage. If any of the stopper, reed or valve seat is faulty, replace them as a unit.

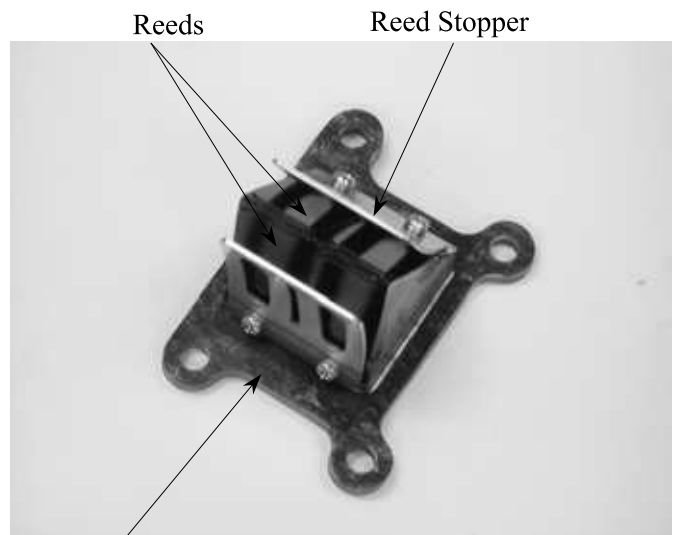

Reed Valve Seat

#### INSTALLATION

Install the reed valve in the reverse order of removal.

\*

- Install a new gasket with the gasket indentation aligned with the reed valve.
- After installation, check for intake air leaks.

---

**STEERING HANDLEBAR/FRONT WHEEL/FRONT BRAKE/FRONT SHOCK ABSORBER/FRONT FORK**

---

SERVICE INFORMATION-----	13- 1
TROUBLESHOOTING-----	13- 2
STEERING HANDLEBAR -----	13- 3
FRONT WHEEL -----	13- 5
FRONT BRAKE -----	13- 8
BRAKE CALIPER -----	13-11
FRONT SHOCK ABSORBER-----	13-14
FRONT FORK -----	13-18

## SERVICE INFORMATION

### GENERAL INSTRUCTIONS

- Remove the motorcycle frame covers before removing the front wheel, steering handlebar, front shock absorber and front fork. Jack the motorcycle front wheel off the ground and be careful to prevent the motorcycle from falling down.
- During servicing, keep oil or grease off the brake pads and brake disk.

### SPECIFICATIONS

Item		Standard (mm)	Service Limit (mm)
Axle shaft runout		—	0.2
Front wheel rim runout	Radial	—	2.0
	Axial	—	2.0
Front brake pad thickness		4.0	2.0
Front shock absorber spring free length		221.5	204.3
Brake disk thickness		3.8~4.2	3.0
Brake disk runout		—	0.30
Brake master cylinder I.D.		11.0~11.043	11.055
Brake master cylinder piston O.D.		10.957~10.970	10.945
Brake caliper piston O.D.		25.335~25.368	25.30
Brake caliper cylinder I.D.		25.400~25.45	25.485

### TORQUE VALUES

Steering stem lock nut	78.4~117.6N-m
Steering top cone race	4.9~12.74N-m
Front shock absorber bolt	19.6~24.5N-m
Front axle nut	44.1~49.0N-m
Brake caliper bolt	24.5~34.3N-m

### SPECIAL TOOLS

Lock nut wrench  
 Front shock absorber compressor  
 Ball race remover  
 Driver handle  
 Outer driver  
 Bearing remover  
 Bearing remover head, 12mm

## **TROUBLESHOOTING**

### **Hard steering (heavy)**

- Excessively tightened steering stem top cone race
- Broken steering balls
- Insufficient tire pressure

### **Steers to one side or does not track straight**

- Uneven front shock absorbers
- Bent front fork
- Bent front axle or uneven tire

### **Poor brake performance**

- Worn brake pads
- Contaminated brake pad surface
- Deformed brake disk
- Air in brake system
- Deteriorated brake fluid
- Worn brake master cylinder piston oil seal
- Clogged brake fluid line
- Unevenly worn brake caliper

### **Front wheel wobbling**

- Bent rim
- Loose front axle
- Bent spoke plate
- Faulty tire
- Improperly tightened axle nut

### **Soft front shock absorber**

- Weak shock springs
- Insufficient damper oil

### **Front shock absorber noise**

- Slider bending
- Loose fork fasteners
- Lack of lubrication

### STEERING HANDLEBAR

#### REMOVAL

- Remove the handlebar front and rear covers. (⇒2-7)
- Remove the front and rear brake master cylinder attaching bolts.
- Remove the front upper cover. (⇒2-3)
- Remove the front lower cover. (⇒2-3)
- Remove the leg shield. (⇒2-4)
- Remove the floor board. (⇒2-5)

Brake Master Cylinders

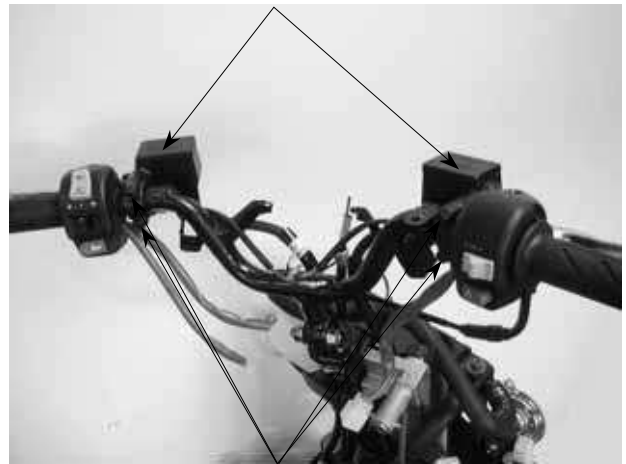

Bolts

- Remove the four screws attaching the right and left handlebar switches.
- Disconnect the throttle cable from the throttle grip and remove the throttle grip from the handlebar.

Throttle Grip



Screws

Throttle Cable

- Remove the handlebar lock nut and take out the bolt.
- Remove the handlebar.



Lock Nut

Bolt

# 13. STEERING HANDLEBAR/FRONT WHEEL/FRONT BRAKE/FRONT SHOCK ABSORBER/FRONT FORK

## INSTALLATION

Install the handlebar onto the steering stem and install the handlebar lock nut and bolt. Tighten the bolt to the specified torque.

**Torque:** 39.2~49.0N-m



Lock Nut

Bolt

Lubricate the throttle grip front end with grease and then install the throttle grip. Connect the throttle cable to the throttle grip. Install the right and left handlebar switches and tighten the screws.

- \* • Adjust the throttle grip free play to the specified range of 2~6mm.

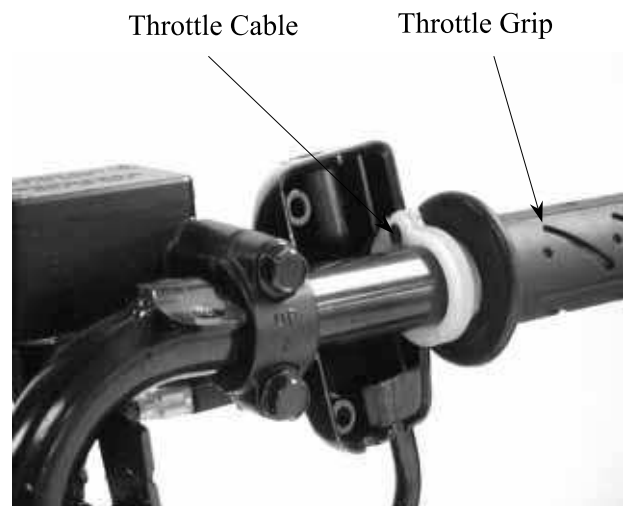

Throttle Cable

Throttle Grip

Install the front and rear brake master cylinders.

- \* • Install the brake master cylinders by aligning the index marks.

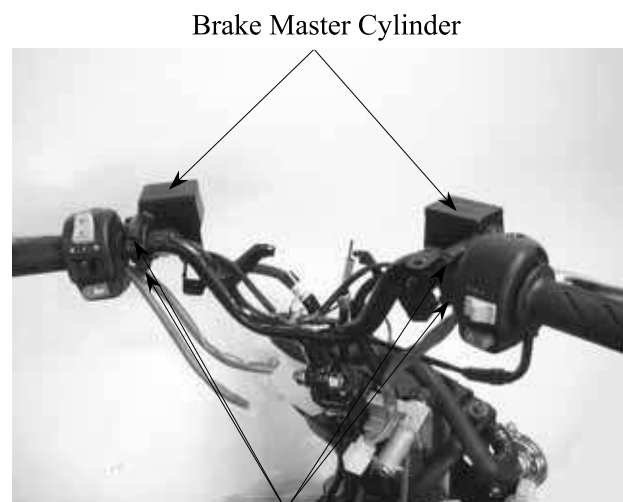

Brake Master Cylinder

Bolt



## FRONT WHEEL

### REMOVAL

Jack the motorcycle front wheel off the ground.  
Remove the front axle nut to pull out the axle.  
Remove the front wheel and the speedometer gear unit.



Axle Nut

Speedometer Gear Unit

### INSPECTION

#### AXLE RUNOUT

Set the axle in V blocks and measure the runout using a dial gauge.  
The actual runout is  $\frac{1}{2}$  of the total indicator reading.

**Service Limit:** 0.2mm replace if over

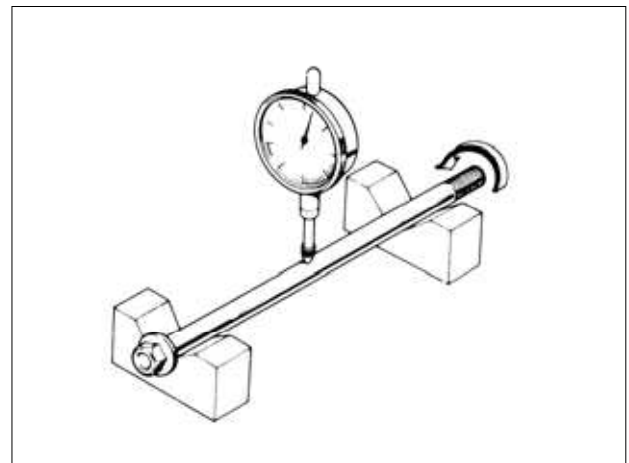

#### WHEEL RIM

Check the wheel rim runout.

#### Service Limits:

**Radial:** 2.0mm replace if over

**Axial:** 2.0mm replace if over

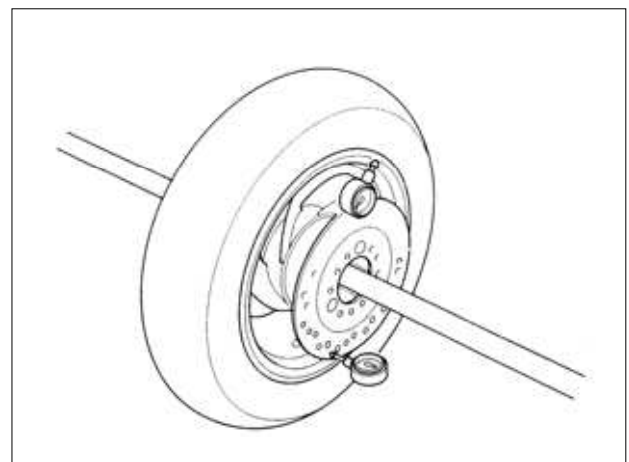

**FRONT WHEEL BEARING**

Remove the side collar and dust seal.



Turn the inner race of each bearing with your finger to see if they turn smoothly and quietly. Also check if the outer race fits tightly in the hub. Replace the bearings if the races do not turn smoothly, quietly, or if they fit loosely in the hub.



Wheel Bearing

**BEARING REPLACEMENT**

Remove the front wheel bearings and distance collar.

**Special Tools**

Bearing Remover

Bearing Remover Head, 12mm



Pack all bearing cavities with grease.  
 Drive in the left bearing.  
 Install the distance collar.  
 Drive in the right bearing.

- \* • Do not allow the bearings to tilt while driving them in.
- Drive in the bearing squarely with the sealed end facing out.

### Special Tools

Outer driver  
 Driver handle



Outer Driver

### INSTALLATION

Apply grease to the speedometer gear unit.  
 Install the speedometer gear unit by aligning its retaining pawl with the hub cutout.

- \* • If not aligned, the retaining pawl will be deformed when the axle nut is tightened.
- After installing the axle, turn the wheel to make sure that the speedometer drive shaft rotates freely.



Hub Cutout Pawl

Install the front wheel by aligning the speedometer gear unit groove with the front shock absorber tab.  
 Insert the axle and tighten the axle nut.

- \* When installing the front wheel, position the brake disk between the two brake pads.

**Torque:** 44.1 ~ 49.0N-m

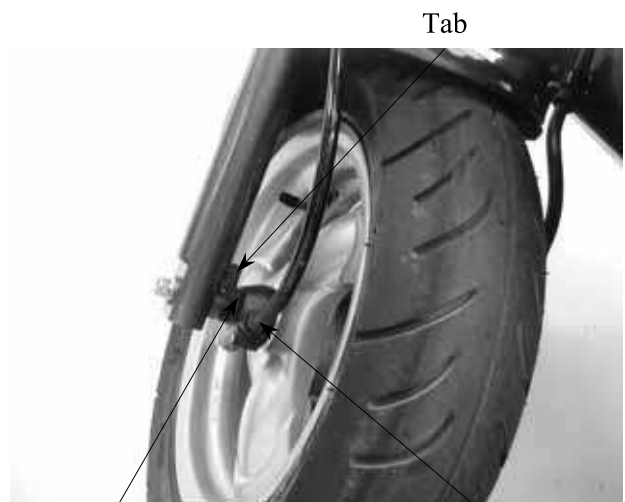

Groove Tab Speedometer Gear Unit

### FRONT BRAKE

#### BRAKE MASTER CYLINDER

##### REMOVAL

Remove the handlebar covers. (⇒2-7)  
 First drain the brake fluid from the hydraulic brake system.

Disconnect the front stop switch wire connector.

Remove the brake fluid tube bolt.

Remove the two bolts attaching the brake master cylinder

Remove the brake master cylinder.

- \* 
 • When servicing the brake system, use shop towels to cover rubber and plastic parts and coated surfaces to avoid being contaminated by brake fluid.  
 • When removing the brake fluid tube bolt, be sure to plug the tube end to avoid brake fluid leakage.

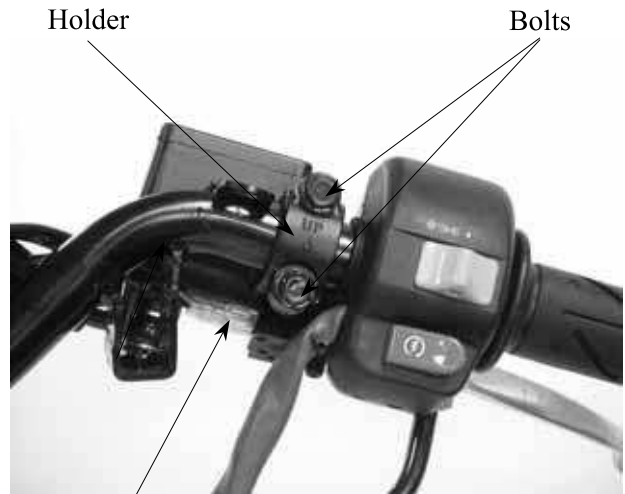

Stop Switch Wire Connector



Snap Ring Pliers (Close)

#### DISASSEMBLY

Remove the brake lever bolt and the brake lever.

Remove the piston rubber cover and snap ring from the brake master cylinder.

Remove the washer, main piston and spring from the brake master cylinder.

Clean the inside of the master cylinder and brake reservoir with brake fluid.

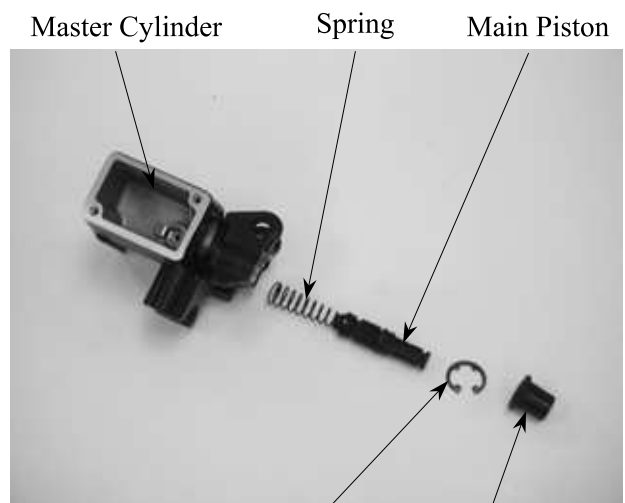

Snap Ring Rubber Cover

### INSPECTION

Measure the brake master cylinder I.D.  
Inspect the master cylinder for scratches or cracks.

**Service Limit:** 12.75mm



Measure the brake master cylinder piston O.D.

**Service Limit:** 12.645mm

Before assembly, inspect the 1st and 2nd rubber cups for wear.

### ASSEMBLY

Before assembly, apply brake fluid to all removed parts.  
Install the spring together with the 1st rubber cup.

- \*
- During assembly, the main piston and spring must be installed as a unit without exchange.
  - When assembling the piston, soak the cups in brake fluid for a while.
  - Install the cups with the cup lips facing the correct direction.

Install the main piston, spring and snap ring.  
Install the rubber cover.  
Install the brake lever.

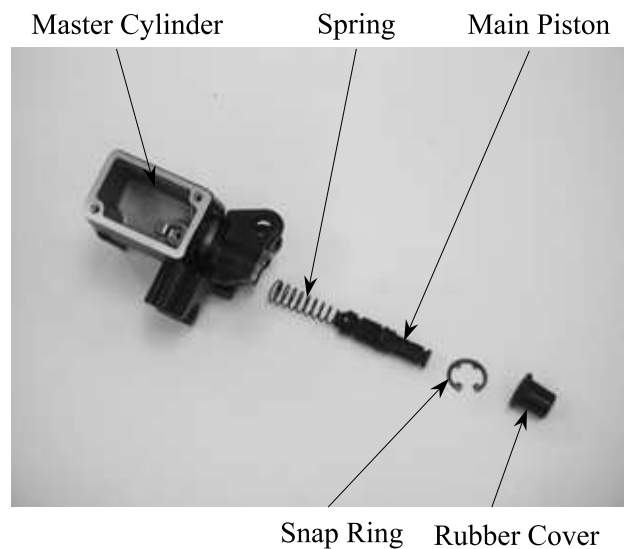

Place the brake master cylinder on the handlebar and install the holder with the “up” mark facing up. Also align the punch mark with the holder joint seam.

First tighten the upper bolt and then tighten the lower bolt.

**Torque:** 9.8~13.72N-m



Fluid Tube Bolt

“Up” Mark

Install the brake fluid tube with the attaching bolt and two sealing washers.

Connect the front stop switch wire connector. Install the handlebar covers. (⇒2-7)



Stop Switch Wire Connector

## BRAKE FLUID REFILLING

Keep the handlebar upright and remove the brake reservoir cover and diaphragm.

Add DOT-3 brake fluid to the brake reservoir.

- \* • When bleeding, be careful not to allow air in the brake reservoir flowing into the brake system.
- When using a brake bleeder, follow the manufacturer's instructions.
- Never use dirty or unspecified brake fluid or mix different brake fluids because it will damage the brake system.



## BRAKE FLUID BLEEDING

Keep the handlebar upright and remove the brake reservoir cover and diaphragm. Add the specified brake fluid to the upper limit.

- \*
- Do not allow dust or water to enter the brake system during refilling.
  - When servicing the brake system, use shop towels to cover plastic parts and coated surfaces to avoid damage caused by splash of brake fluid.

In order to avoid spilling brake fluid, connect a transparent hose to the bleed valve.

### Warning

Brake fluid spilled on brake pads or brake disk will reduce the braking effect. Clean the brake pads and brake disk with a high quality brake degreaser.

Fully apply the brake lever and then loosen the brake caliper bleed valve to drain the brake fluid until there is no air bubbles in the brake fluid. Then, tighten the bleed valve. Repeat these steps until the brake system is free of air.

## BRAKE CALIPER

### REMOVAL

First drain the brake fluid from the hydraulic brake system.

Remove the brake fluid tube bolt.

Remove the two bolts attaching the brake caliper.

Remove the brake caliper.

### DISASSEMBLY

Remove the two brake pads dowel pins from the brake caliper.

Remove the brake pads.



Bleed Valve



Fluid Tube Bolt

Bolts

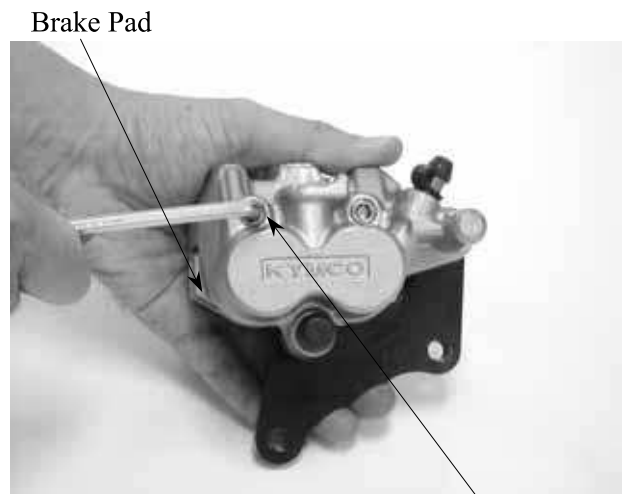

Brake Pad

Dowel Pin

Remove the piston from the brake caliper. If necessary, use compressed air to squeeze out the piston through the brake fluid inlet opening and place a shop towel under the caliper to avoid contamination caused by the removed piston. Check the piston cylinder for scratches or wear and replace if necessary.



Compressed Air

Push the piston oil seal outward to remove it. Clean the oil seal groove with brake fluid.

\* Be careful not to damage the piston surface.



Piston Oil Seal

Check the piston for scratches or wear. Measure the piston O.D. with a micrometer gauge.

**Service Limit:** 25.30mm

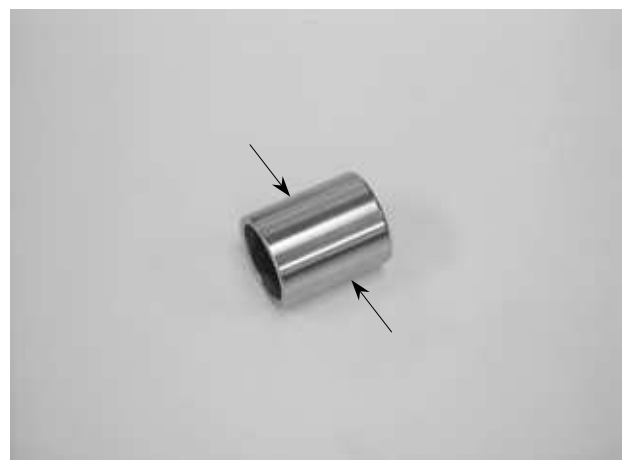



Check the caliper cylinder for scratches or wear and measure the cylinder bore.

**Service Limit:** 25.45mm



### ASSEMBLY

Clean all removed parts.

Apply silicon grease to the piston and oil seal.

Lubricate the brake caliper cylinder inside wall with brake fluid.

Install the brake caliper piston with grooved side facing out.

\* Install the piston with its outer end protruding 3~5mm beyond the brake caliper.

Wipe off excessive brake fluid with a clean shop towel. Apply silicon grease to the brake caliper seat pin and caliper inside. Install the brake caliper seat.



### INSTALLATION

Install the brake caliper to the shock absorber and tighten the two bolts.

**Torque:** 24.5~34.3N-m

\* When installing the brake caliper, be sure to position the brake disk between the two brake pads.



Fluid Tube Bolt

Brake Caliper

Connect the brake fluid tube to the brake caliper and tighten the fluid tube bolt.

**Torque:** 24.5~34.3N-m

Fill the brake reservoir with the specified brake fluid and bleed air from the brake system. (⇒13-11)

\* When installing the brake fluid tube, be sure to install the two sealing washers.

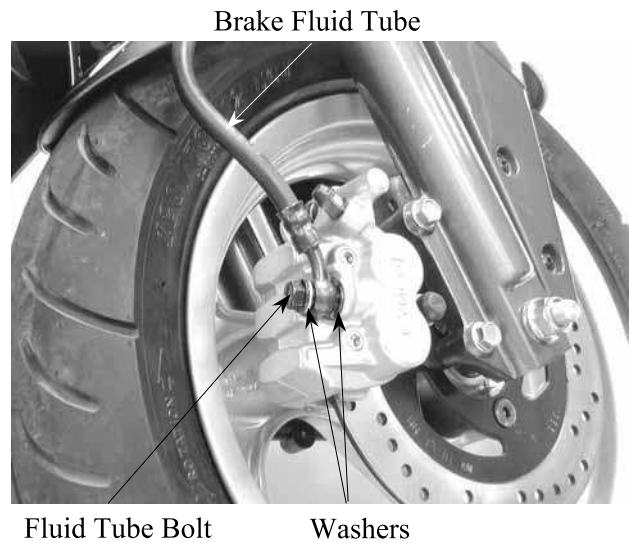

### FRONT SHOCK ABSORBER

#### REMOVAL

Remove the front upper cover. (⇒2-3)

Remove the front lower cover. (⇒2-3)

Remove the front wheel. (⇒13-5)

Remove the front brake caliper. (⇒13-11)

Remove the front shock absorber upper mount bolts.

Loosen the lower mount bolts to remove the front shock absorbers.

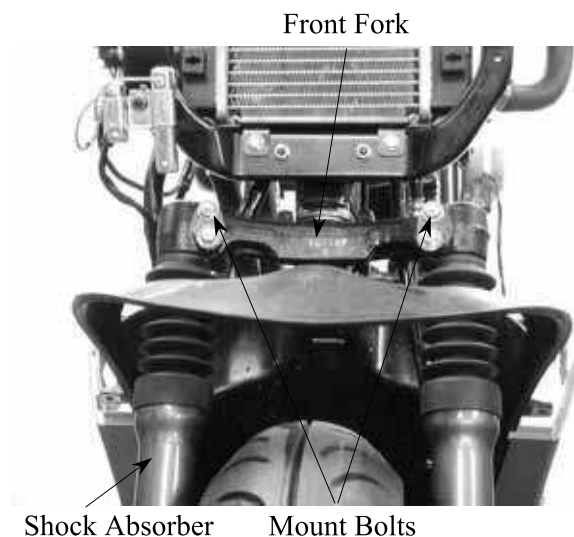

#### DISASSEMBLY

Remove the dust boot.

Remove the dust seal.

Remove the circlip.

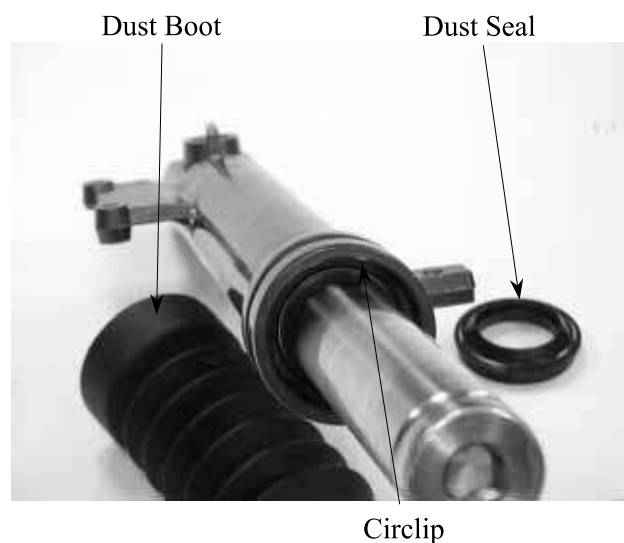

Set the front shock absorber in a vise.  
Remove the damper rod hex bolt and copper washer.  
Pull out the front shock absorber tube.

\* After the hex bolt is removed, place a container under the front shock absorber to drain the engine oil from it.

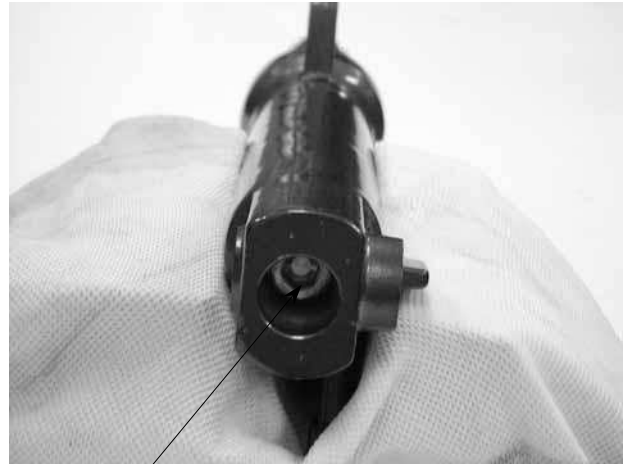

Hex Bolt

Set the front shock absorber tube in a vise.  
Remove the lock nut on the front shock absorber tube.  
Take out the shock absorber spring and damper rod.

\* When holding the shock absorber tube, place a shop towel to protect it and do not apply too much force.



Lock Nut

Shock Absorber Tube

### INSPECTION

Inspect the following items and replace if necessary.

- Front shock absorber tube bending, damage or wear
- Weak front shock absorber spring
- Damper and damper rod bending
- Oil seal damage or wear

Shock Absorber Tube



Measure the front shock absorber spring free length.

**Service Limit:** 233mm replace if below



## ASSEMBLY

Install the damper spring onto the damper rod and then install them into the front shock absorber tube.

Install the shock absorber spring onto the front shock absorber tube.

Set the front shock absorber tube in a vise and then tighten the lock nut.

\* When holding the shock absorber tube, place a shop towel to protect it and do not apply too much force.



Set the front shock absorber in a vise. Insert the shock absorber tube into the shock absorber and then install the copper washer and tighten the damper rod hex bolt.

\* Apply locking agent to the washer and hex bolt and install them together.

Add engine oil into the front shock absorber.

**Torque:** 14.7~29.4N-m

**Specified Oil:** SS#8

**Oil Capacity:** 52cc



Hex Bolt

Install the oil seal  
Install the circlip.  
Install the dusts seal and dust boot.

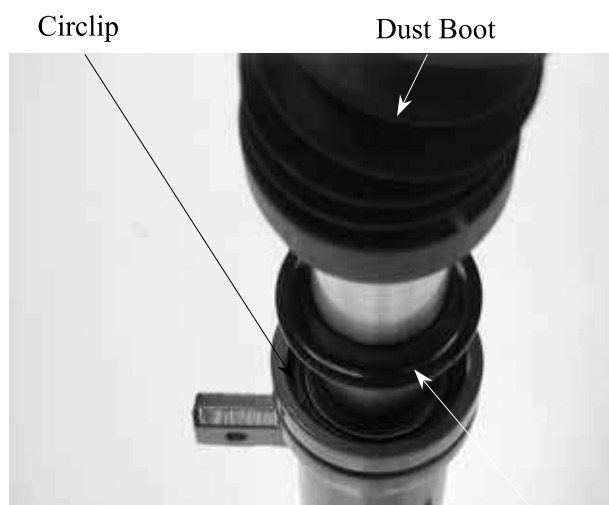

Dust Seal

### INSTALLATION

Install the front shock absorbers onto the front fork.  
Install and tighten the front shock absorber upper mount bolts.  
Tighten the lower mount bolts.

\* Align the upper mount bolt hole with the groove on the front fork.

Install the front wheel. (⇒13-7)



## FRONT FORK

### REMOVAL

- Remove the handlebar covers. (⇒2-6)
- Remove the steering handlebar. (⇒13-4)
- Remove the front upper cover. (⇒2-5)
- Remove the front lower cover. (⇒2-5)
- Remove the front inner fender. (⇒2-6)
- Remove the front wheel. (⇒13-5)
- Remove the front brake caliper. (⇒13-11)
- Hold the steering stem top cone race and remove the steering stem lock nut.

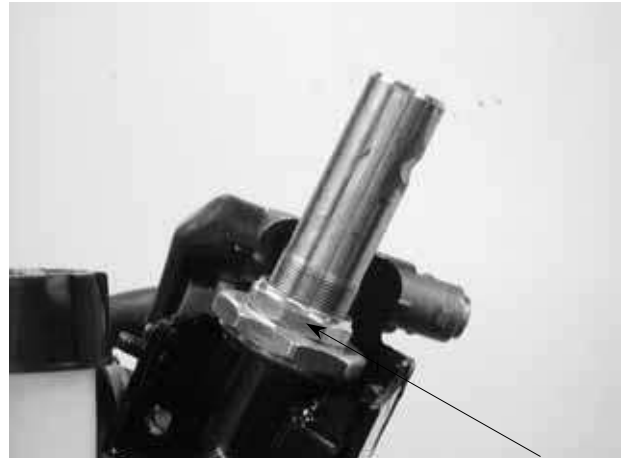

Lock Nut

Remove the top cone race and remove the front fork.

\* Be careful not to lose the steel balls (26 on top race and 29 on bottom race).

Inspect the ball races, cone races and steel balls for wear or damage. Replace if necessary.



Top Cone Race

### BOTTOM CONE RACE REPLACEMENT

Remove the bottom cone race using a chisel. Drive a new bottom cone race into place with a proper driver.

\* Be careful not to damage the steering stem and front fork.



Bottom Cone Race

### BALL RACE REPLACEMENT

Drive out the ball races.

Ball Race Remover



Drive in new ball races.

\*

Be sure to drive the ball races into place completely.

Outer Driver



### INSTALLATION

Apply grease to the top and bottom ball races and install 26 steel balls on the top ball race and 29 steel balls on the bottom ball race. Then, install the front fork.

Top Cone Race



Ball Race

Apply grease to the top cone race and install it.

Tighten the top cone race and then turn the steering stem right and left several times to make steel balls contact each other closely.

\* Check that the steering stem rotates freely without vertical play.



Install the steering stem lock nut and tighten it while holding the top cone race.

**Torque:** 78.4~117.6N-m

Install the front wheel. (⇒13-7)

Install the front brake caliper. (⇒13-12)

Install the front inner fender. (⇒2-6)

Install the throttle grip and the right and left handlebar switches. (⇒13-5)

Install the right and left brake master cylinders. (⇒13-5)

Lock Nut Wrench

Lock Nut Socket





---

**REAR BRAKE/REAR FORK/REAR WHEEL/  
REAR SHOCK ABSORBER**

---

SERVICE INFORMATION-----	14-1
TROUBLESHOOTING-----	14-1
REAR BRAKE -----	14-2
REAR FORK -----	14-3
REAR WHEEL-----	14-3
REAR BRAKE DRUM -----	14-5
REAR SHOCK ABSORBER -----	14-7

## SERVICE INFORMATION

### GENERAL INSTRUCTIONS

- When performing the services stated in this section, the engine and exhaust muffler must be cold to avoid scalding.
- During servicing, keep oil or grease off the brake pads and brake disk.

### SPECIFICATIONS

Item	Standard (mm)	Service Limit (mm)
Rear wheel rim runout	—	2.0
Rear shock absorber spring free length	214.7	197.7
Rear brake drum I.D.	110	111
Rear brake disk/ lining thickness	3.5~3.8/4.0	3.0/2.0
Rear brake disk runout	—	0.30
Rear brake master cylinder I.D.	12.700~12.743	12.755
Rear brake master cylinder piston O.D.	12.657~12.684	12.645
Rear brake caliper cylinder I.D.	33.895~33.928	33.860
Rear brake caliper piston O.D.	33.960~34.010	34.045

### TORQUE VALUES

Exhaust muffler lock bolt	29.4~39.2N-m
Rear axle nut	78.4~98.0N-m
Rear shock absorber lower mount bolt	19.6~29.4N-m
Rear shock absorber upper mount bolt	39.2N-m
Rear damper lock nut	14.7~24.5N-m (apply locking agent)
Rear brake caliper bolt	19.6~29.4N-m

### SPECIAL TOOLS

Rear shock absorber remover  
Shock absorber spring compressor

## TROUBLESHOOTING

### Rear wheel wobbling

- Bent rim
- Faulty tire
- Axle not tightened properly

### Soft rear shock absorber

- Weak shock absorber spring
- Damper oil leaks

### Rear wheel noise

- Worn rear wheel axle bearings
- Worn rear fork bearings
- Deformed rear fork

### Poor brake performance

- Air in brake system
- Deteriorated brake fluid
- Contaminated brake pad surface
- Worn brake pads
- Clogged brake fluid line
- Deformed brake disk
- Unevenly worn brake caliper

# 14. REAR BRAKE/REAR FORK/REAR WHEEL/REAR SHOCK ABSORBER

## REAR BRAKE (SH10DA)

### REAR BRAKE CALIPER REMOVAL

First remove the exhaust muffler. (⇒2-6)  
Remove the rear brake fluid tube bolt and disconnect the brake fluid tube.  
Remove the two bolts attaching the rear brake caliper.  
Remove the rear brake caliper.

\* When removing the brake fluid tube, use shop towels to cover plastic parts and coated surfaces to avoid damage.

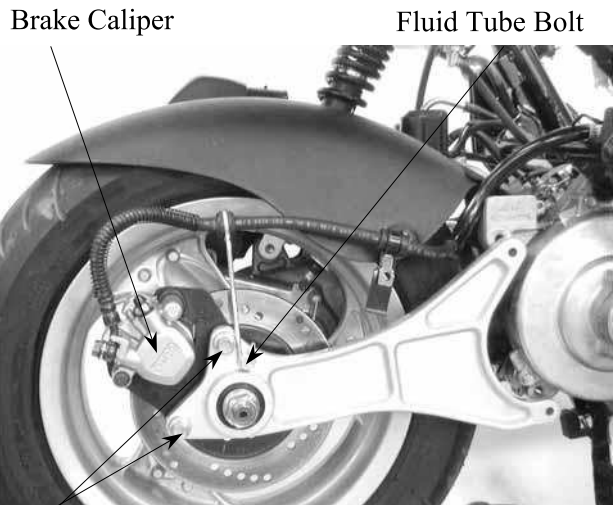

Bolts

### INSPECTION

Inspect the brake pads and brake disk.  
Visually check the brake pad thickness and it should not exceed the wear indicator mark.  
Measure the brake disk thickness.

**Service Limit:** 3.0mm replace if below

### DISASSEMBLY

Disassemble the rear brake caliper. (⇒14-11)  
Inspect and assemble the rear brake caliper. (⇒14-12)

Note: The rear brake caliper and front brake caliper have the same specification.



Wear Indicator Mark

Brake Disk

### INSTALLATION

Install the brake caliper to the rear fork and tighten the two bolts.

**Torque:** 24.5~34.3N-m

Connect the brake fluid tube to the brake caliper and tighten the fluid tube bolt.  
Fill the brake reservoir with the specified brake fluid and bleed air from the brake system. (⇒13-11)

\* When installing the brake fluid tube, be sure to install the two copper sealing washers.

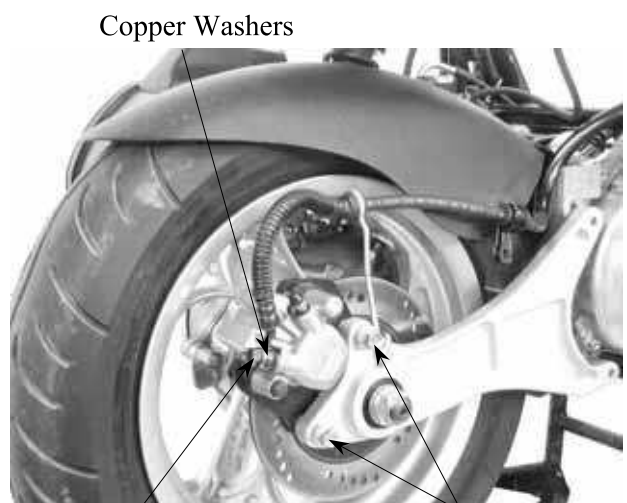

Fluid Tube Bolt

Bolts

# 14. REAR BRAKE/REAR FORK/REAR WHEEL/REAR SHOCK ABSORBER

## REAR FORK (SF10DA)

### REMOVAL

Remove the exhaust muffler. (⇒2-6)  
Remove the rear brake caliper. (⇒14-2)  
Remove the rear axle nut and remove the collar.  
Remove the rear fork.

The installation sequence is the reverse of removal.

### Torque:

Rear fork bolt: 19.6~29.4N-m

Rear axle nut: 78.4~98.0N-m



Collar

Rear Fork Bolts

## REAR WHEEL

### REMOVAL

Remove the exhaust muffler. (⇒2-6)  
Remove the rear brake caliper. (⇒14-2)  
Remove the rear fork.  
Remove the rear axle collar.  
Remove the rear wheel.



Rear Brake Disk

Rear Axle Collar

### REMOVAL

Remove the exhaust muffler. (⇒2-6)  
Remove the rear axle nut to remove the rear wheel.



Rear Axle Nut

# 14. REAR BRAKE/REAR FORK/REAR WHEEL/REAR SHOCK ABSORBER

## INSPECTION

Measure the rear wheel rim runout.

### Service Limits:

**Radial:** 2.0mm replace if over

**Axial:** 2.0mm replace if over

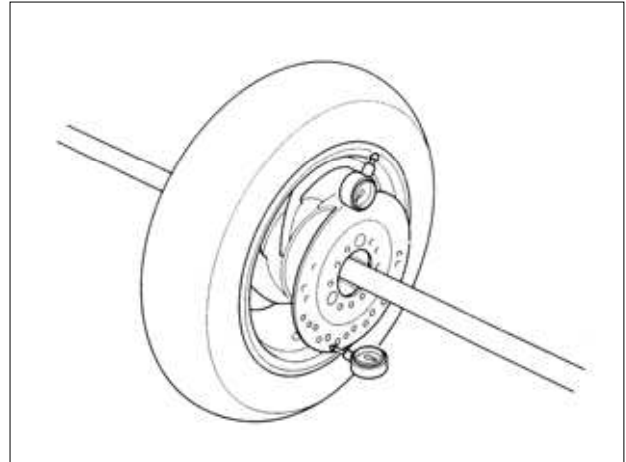

## INSTALLATION

The installation sequence is the reverse of removal.

### Torque:

Rear axle nut: 78.4~98.0N-m



Brake Caliper Bolts

Axle Nut

## INSTALLATION

Install the rear wheel and apply SAE30# engine oil to the axle threads. Then, tighten the rear axle nut.

### Torque values:

Rear axle nut: 107.8~127.4N-m



Rear Axle Nut

# 14. REAR BRAKE/REAR FORK/REAR WHEEL/REAR SHOCK ABSORBER

## REAR BRAKE DRUM

Remove the rear wheel. (⇒14-3)  
Inspect the rear brake drum.  
Measure the rear brake drum I.D.  
**Service Limit:** 95.5mm replace if over

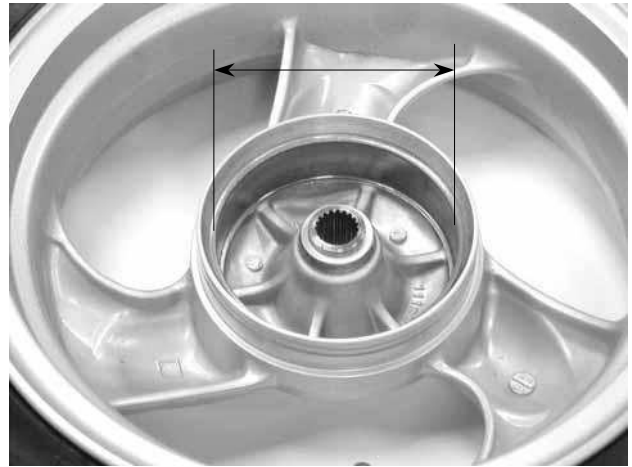

## BRAKE LINING INSPECTION

Measure the brake lining thickness.  
**Service Limit:** 2.0mm replace if below

\* Keep oil or grease off the brake linings.



## REAR BRAKE DISASSEMBLY

Remove the rear brake adjusting nut and disconnect the rear brake cable.  
Remove the rear brake shoes.

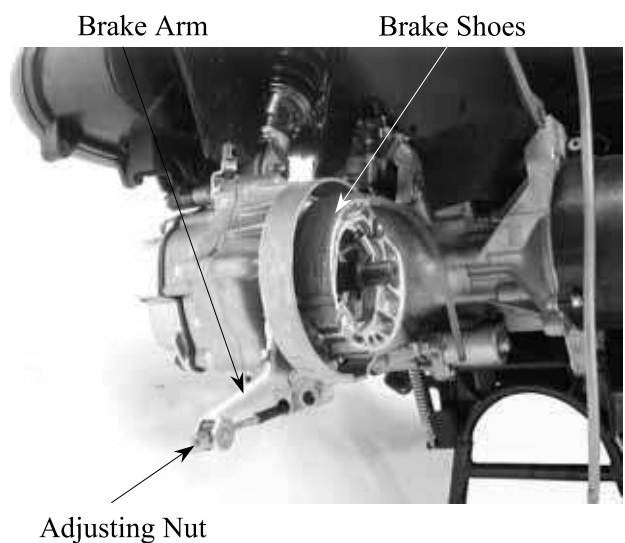

# 14. REAR BRAKE/REAR FORK/REAR WHEEL/REAR SHOCK ABSORBER

Remove the brake arm bolt to remove the brake arm, wear indicator plate and felt seal. Remove the brake cam.

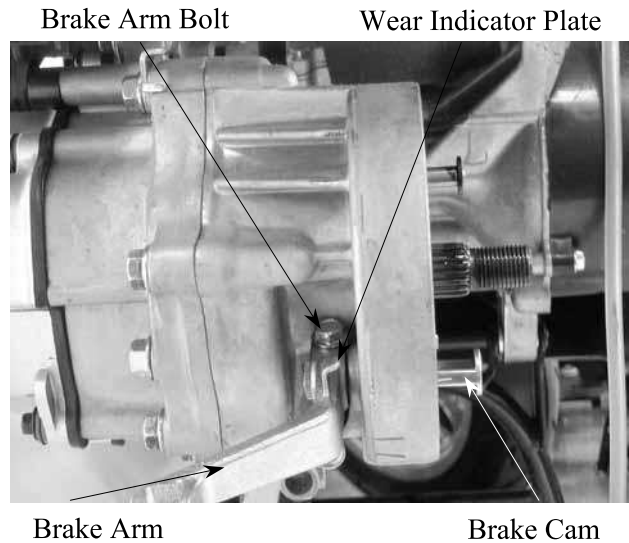

## REAR BRAKE ASSEMBLY

Apply grease to the anchor pin and brake shoe moving parts.  
Apply grease to the brake cam and install it.



Apply engine oil to the felt seal and install it to the brake cam.  
Install the wear indicator plate.

\* Align the wide tooth of the wear indicator plate with the wide groove on the brake cam.

Install the brake arm onto the brake cam.

\* Align the punch mark on the brake arm with the scribed line on the brake cam.

Install and tighten the brake arm bolt.  
Install the brake arm return spring.  
Install the brake shoes.

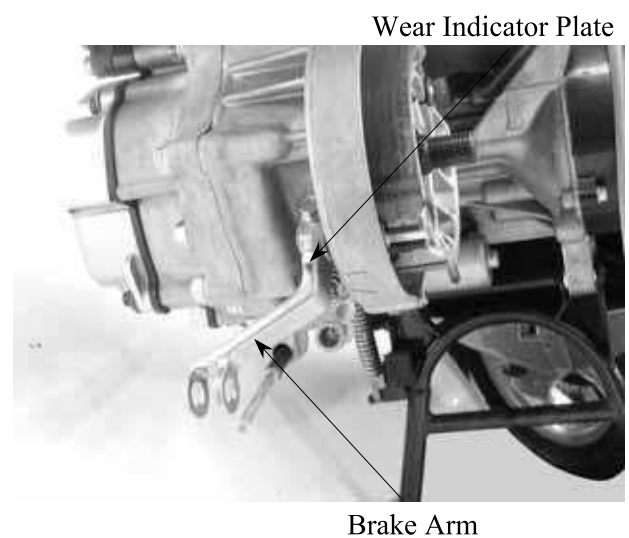

# 14. REAR BRAKE/REAR FORK/REAR WHEEL/REAR SHOCK ABSORBER

Install the brake arm pin.  
Connect the brake cable and install the adjusting nut.  
Install the rear wheel.  
Adjust the rear brake lever free play. (⇒3-12)

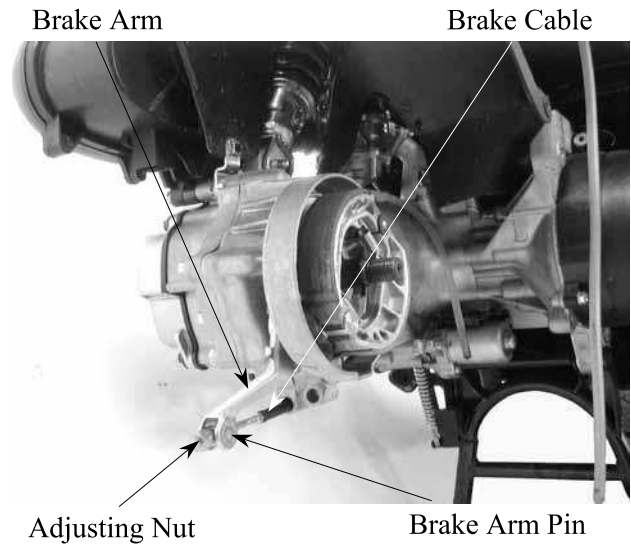

## REAR SHOCK ABSORBER

### REMOVAL

Remove the rear carrier and frame body cover. (⇒2-2)  
Remove the met-in box. (⇒2-2)  
Remove the two air cleaner bolts.

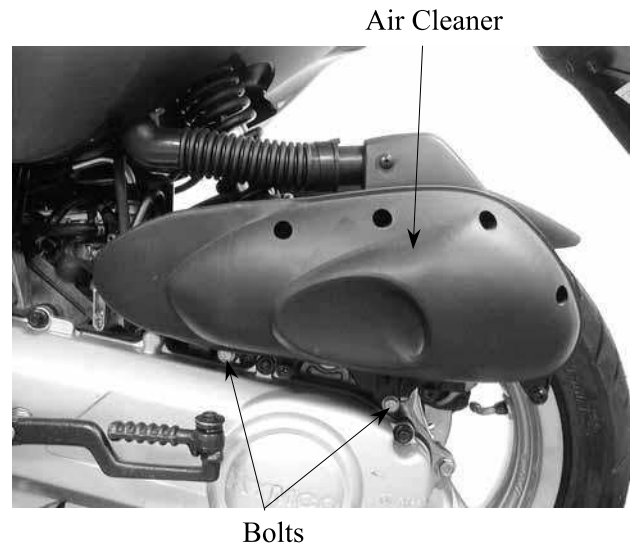

Remove the rear shock absorber upper mount bolt.  
Remove the left rear shock absorber upper and lower mount bolts.  
Remove the left rear shock absorbers.

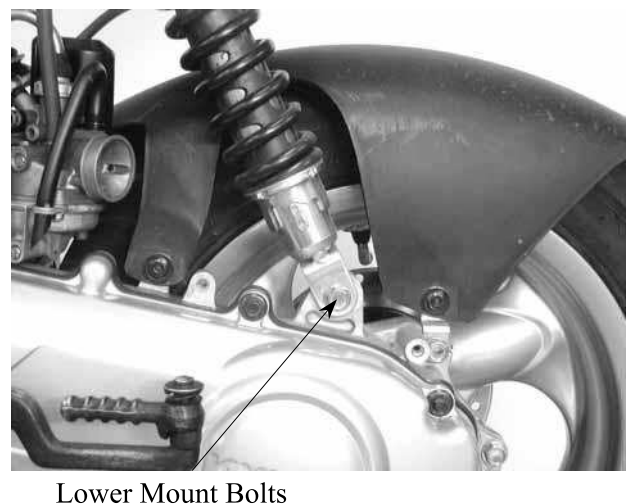



# 14. REAR BRAKE/REAR FORK/REAR WHEEL/REAR SHOCK ABSORBER

## DISASSEMBLY

Disassemble the left rear shock absorbers using the rear shock absorber remover.

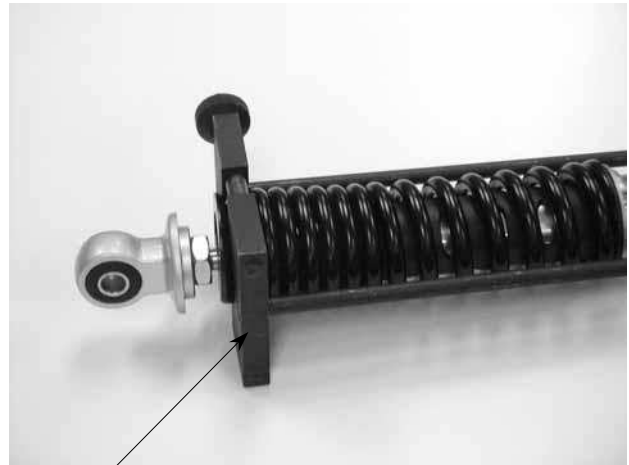

Rear Shock Absorber Remover

## INSPECTION

Inspect the damper rod for bending or damage.  
Inspect the damper for oil leaks.  
Inspect the damper rubber for deterioration or damage.

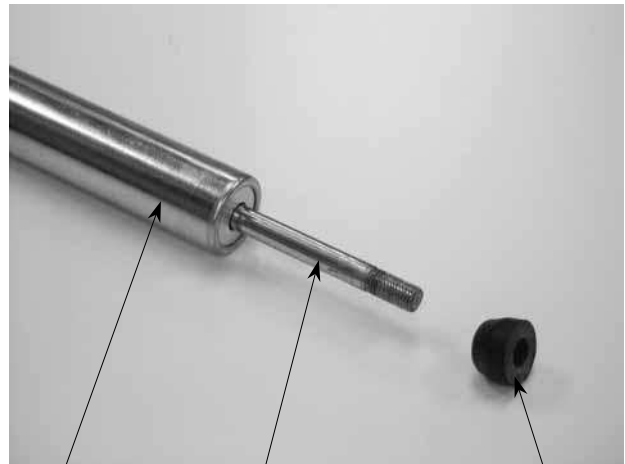

Damper

Damper Rod

Rubber

Measure the front shock absorber spring free length.

### Service Limit:

Left : 226mm

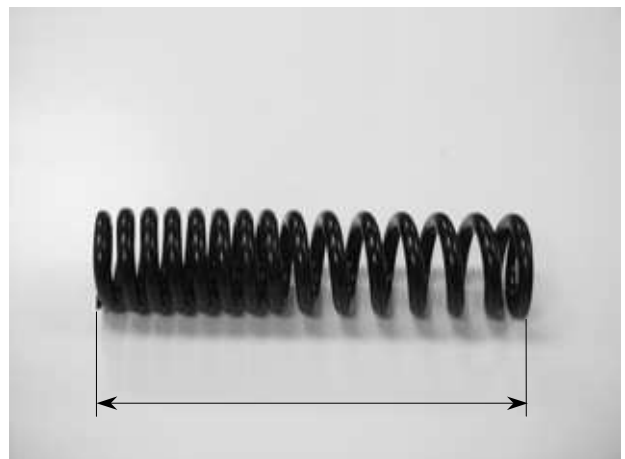

# 14. REAR BRAKE/REAR FORK/REAR WHEEL/REAR SHOCK ABSORBER

## ASSEMBLY

Assemble the rear shock absorbers in the reverse order of disassembly.



## INSTALLATION

Install the rear shock absorbers in the reverse order of removal.

### Torque:

Upper Mount Bolt: 39.2N-m

Lower Mount Bolt: 19.6~29.4N-m



Lower Mount Bolts

---

## ELECTRICAL EQUIPMENT

---

SERVICE INFORMATION .....	15- 1
TROUBLESHOOTING .....	15- 1
CHARGING SYSTEM .....	15- 3
BATTERY .....	15- 4
IGNITION SYSTEM .....	15- 7
STARTING SYSTEM.....	15-11

## SERVICE INFORMATION

### GENERAL INSTRUCTIONS

- It is not necessary to check the battery electrolyte or fill with distilled water.
- Remove the battery from the motorcycle for charging. Do not remove the electrolyte cap..
- Do not quick charge the battery. Quick charging should only be done in an emergency..
- Charge the battery according to the charging current and time specified on the battery.
- When charging, check the voltage (open voltage) with an electric tester.
- When replacing the battery, do not use a traditional battery.

### SPECIFICATIONS

		SH10DA	SF10DA
Battery	Capacity	12V4AH	12V4AH
	Voltage	13.0~13.2V	13.0~13.2V
	Charging current	Standard	0.4A/5H
Quick		5A/0.5H	4A/0.5H
Spark plug	(NGK)	BR8HSA	BR8HSA
Spark plug gap		0.6~0.7mm	0.6~0.7mm
Ignition coil resistance	Primary coil	0.153~0.187Ω	0.153~0.187Ω
	Secondary coil (with plug cap)	6.99~10.21KΩ	6.99~10.21KΩ
	Secondary coil (without plug cap)	3.24~3.96KΩ	3.24~3.96KΩ
Pulser coil resistance (20°C)		80~160Ω	80~160Ω
Ignition timing		13.5°±2°BTDC/1800rpm	13.5°±2°BTDC/2000rpm

## TROUBLESHOOTING

### CHARGING SYSTEM

#### No power

- Dead battery
- Disconnected battery cable
- Fuse burned out
- Faulty ignition switch

#### Low power

- Weak battery
- Loose battery connection
- Charging system failure
- Faulty regulator/rectifier

#### Intermittent power

- Loose battery cable connection
- Loose charging system connection
- Loose connection or short circuit in ignition system
- Loose connection or short circuit in lighting system

#### Charging system failure

- Loose, broken or shorted wire or connector
- Faulty regulator/rectifier
- Faulty A.C. generator

## IGNITION SYSTEM

### No spark at plug

- Faulty spark plug
- Poorly connected, broken or shorted wire
  - Between A.C. generator and CDI unit
  - Between CDI unit and ignition coil
  - Between CDI unit and ignition switch
  - Between ignition coil and spark plug
- Faulty ignition switch
- Faulty ignition coil
- Faulty CDI unit
- Faulty A.C. generator

### Engine starts but turns poorly

- Ignition primary circuit
  - Faulty ignition coil
  - Poorly connected wire or connector
- Ignition secondary circuit
  - Faulty ignition coil
  - Faulty spark plug
  - Poorly insulated plug cap
- Improper ignition timing
  - Battery voltage too low (6V max.)
  - Faulty CDI unit

## STARTING SYSTEM

### Starter motor won't turn

- Fuse burned out
- Weak battery
- Faulty ignition switch
- Faulty starter switch
- Faulty front or rear stop switch
- Faulty starter relay
- Poorly connected, broken or shorted wire
- Faulty starter motor

### Lack of power

- Weak battery
- Loose wire or connection
- Foreign matter stuck in starter motor or pinion

### Starter motor rotates but engine does not start

- Faulty starter pinion
- Starter motor rotates reversely
- Faulty starter clutch
- Weak battery

## CHARGING SYSTEM

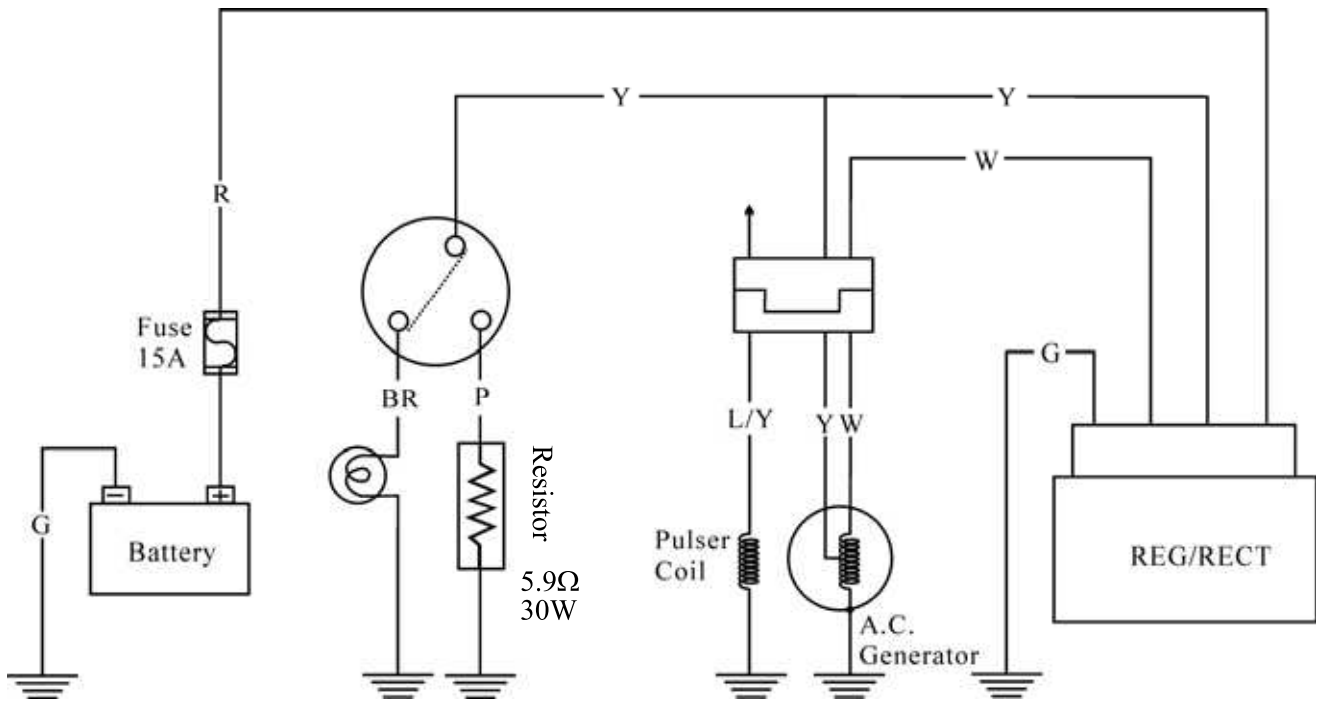

## BATTERY

### BATTERY REMOVAL

Open the front tool box and remove the bolt.  
 Remove the front tool box. (⇒2-4)  
 Disconnect the battery cables.

\* First disconnect the battery negative (-) cable and then the positive (+) cable.

Remove the bolt and battery bracket.  
 Remove the battery.  
 The installation sequence is the reverse of removal.

### BATTERY CHARGING (OPEN CIRCUIT VOLTAGE) INSPECTION

Remove the battery cover and disconnect the battery cables.  
 Measure the voltage between the battery terminals.  
 Fully charged : 13.0V ~ 13.2V  
 Undercharged : 12.3V max.

\* Battery charging inspection must be performed with an electric tester.

### CHARGING METHOD

Connect the charger positive (+) cable to the battery positive (+) cable.  
 Connect the charger negative (-) cable to the battery negative (-) cable.

\* 

- Keep flames and sparks away from a charging battery.
- Turn power ON/OFF at the charger, not at the battery terminals to prevent sparks near the battery.
- Charge the battery according to the current specified on the battery surface.

Charging current: Standard : 0.4A  
                                     Quick : 4A  
 Charging time : Standard : 5 hours  
                                     Quick : 0.5 hours  
 After charging: Open circuit voltage: 12.8V min.

\* 

- Quick charging should only be done in an emergency.
- During quick charging, the battery temperature should not exceed 45°C.
- Measure the voltage 30 minutes after the battery is charged.

Front Tool Box

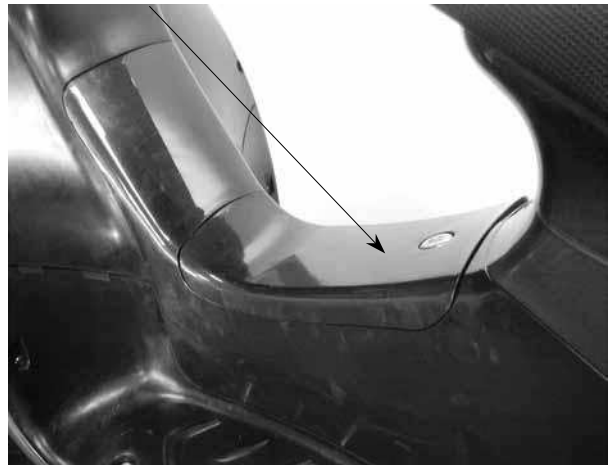

Battery

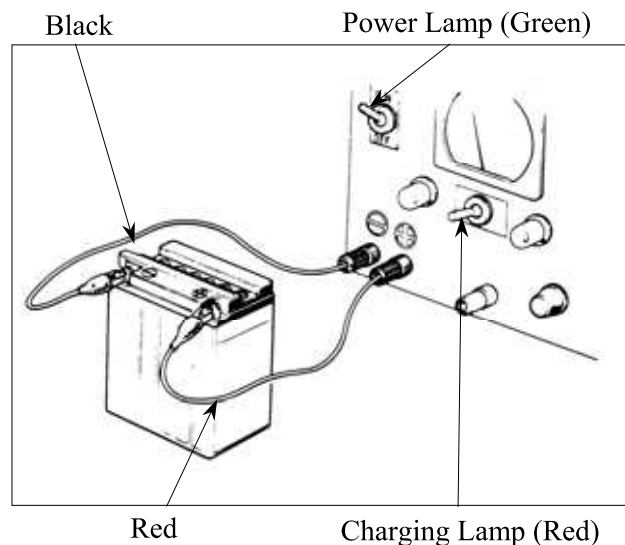
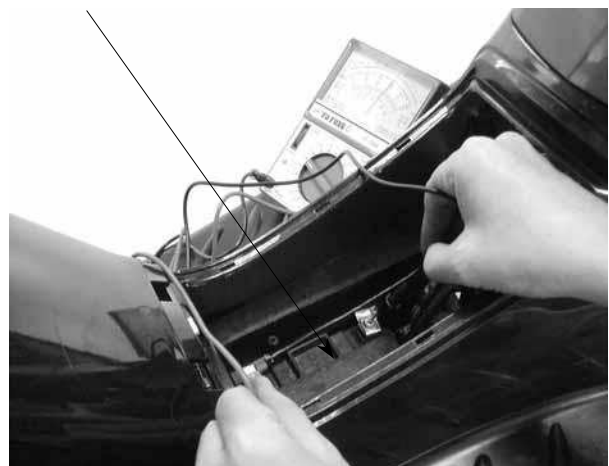

## PERFORMANCE TEST

Warm up the engine.  
Remove the floor mat and battery cover.

\* Use a fully charged battery to check the charging system output.

Stop the engine and open the fuse box.  
Disconnect the wire lead from the fuse terminal. Connect an ammeter between the wire lead and fuse terminal as shown.  
Connect the battery positive (+) terminal to the voltmeter positive (+) probe and battery negative (-) terminal to the voltmeter negative (-) probe.  
Start the engine, gradually increase engine speed to test the output:

Position \ RPM	Day	Night
2500	1.3A min.	1.0A min.
6000	2.0A min.	2.0A min.

**Charging Limit Voltage:**  $14.5 \pm 0.5V/8000rpm$   
If the limit voltage is not within the specified range, check the regulator/ rectifier.

## A.C. GENERATOR (CHARGING COIL) INSPECTION

\* Inspect with the engine installed.

Remove the met-in box, rear carrier and frame body cover. (⇒2-2)  
Disconnect the A.C. generator connector.  
Measure the resistances between the charging coil terminals (white-green) and lighting coil terminals (yellow-green).

**Resistances:**

Charging coil	white-green	0.2 ~ 1.2Ω
Lighting coil	yellow-green	0.3 ~ 1.0Ω

Refer to 8-3 for A.C. generator removal.

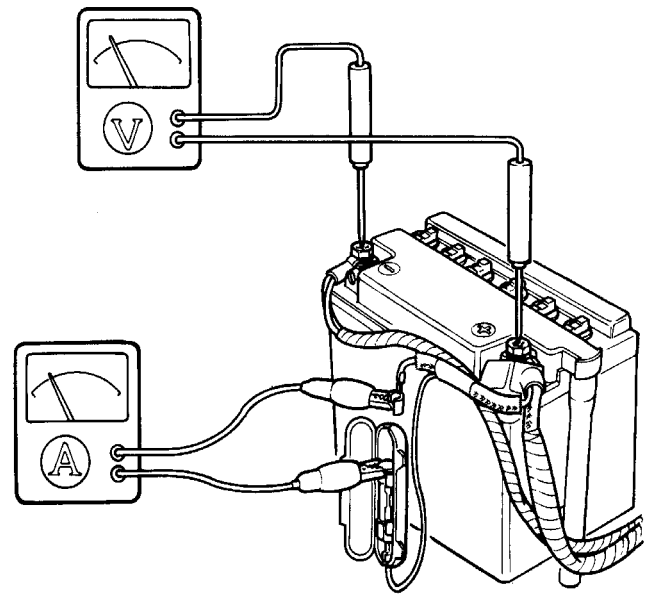

r



# 15. ELECTRICAL EQUIPMENT

## RESISTOR INSPECTION

Remove the front upper/lower cover. (⇒2-3)  
 Measure the resistance between the resistor B pink wire and ground.  
 Measure the resistance between the resistor A green/black wire and ground.

### Resistances:

- Resistor A: 9.9 ~ 10.5Ω
- Resistor B: 5.6 ~ 6.2Ω

\* Faulty resistor is the cause of faulty operation of the auto bystarter.

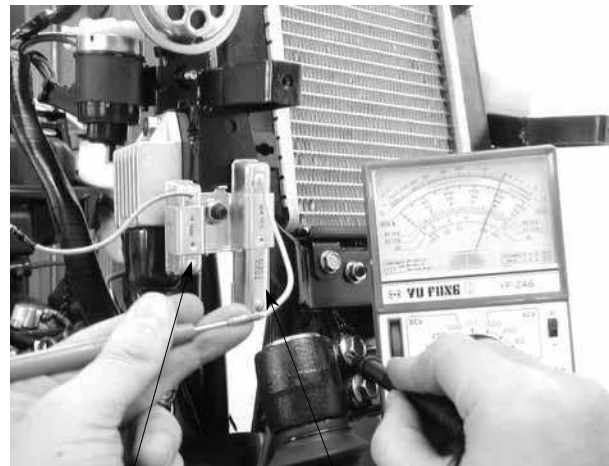

Resistor A      Resistor B

## REGULATOR/RECTIFIER INSPECTION

Remove the front upper/lower cover. (⇒2-3)  
 Disconnect the regulator/rectifier wire coupler and remove the bolt to remove the regulator/rectifier.

Measure the resistances between the terminals.

Replace the regulator/rectifier if the readings are not within the specifications in the table below.

\* Due to the semiconductor in circuit, it is necessary to use a specified tester for accurate testing. Use of an improper tester in an improper range may give false readings.

- Use a Sanwa Electric Tester (07208-0020000) or Kowa Electric Tester (TH-5H). The proper range for testing is listed below.

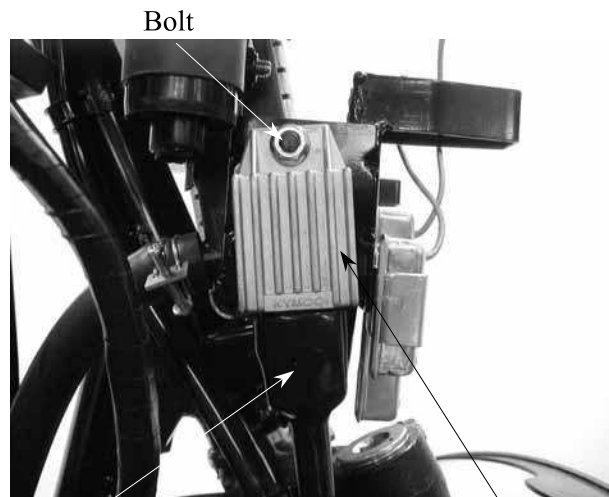

Bolt      Coupler      Regulator/Rectifier

Model	Brand	Range
SP-10D	Sanwa	KΩ
TH-5H	Kowa	100Ω

Probe⊕ / Probe(-)	A (R)	B (W)	C (Y)	D (G)
A (R)		∞	∞	∞
B (W)	3-10KΩ		∞	∞
C (Y)	∞	∞		33-35KΩ
D (G)	∞	∞	33-35KΩ	

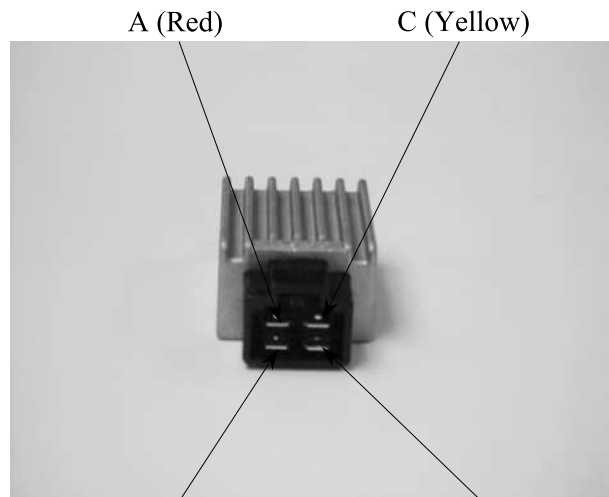

A (Red)      B (White)      C (Yellow)      D (Green)

## IGNITION SYSTEM

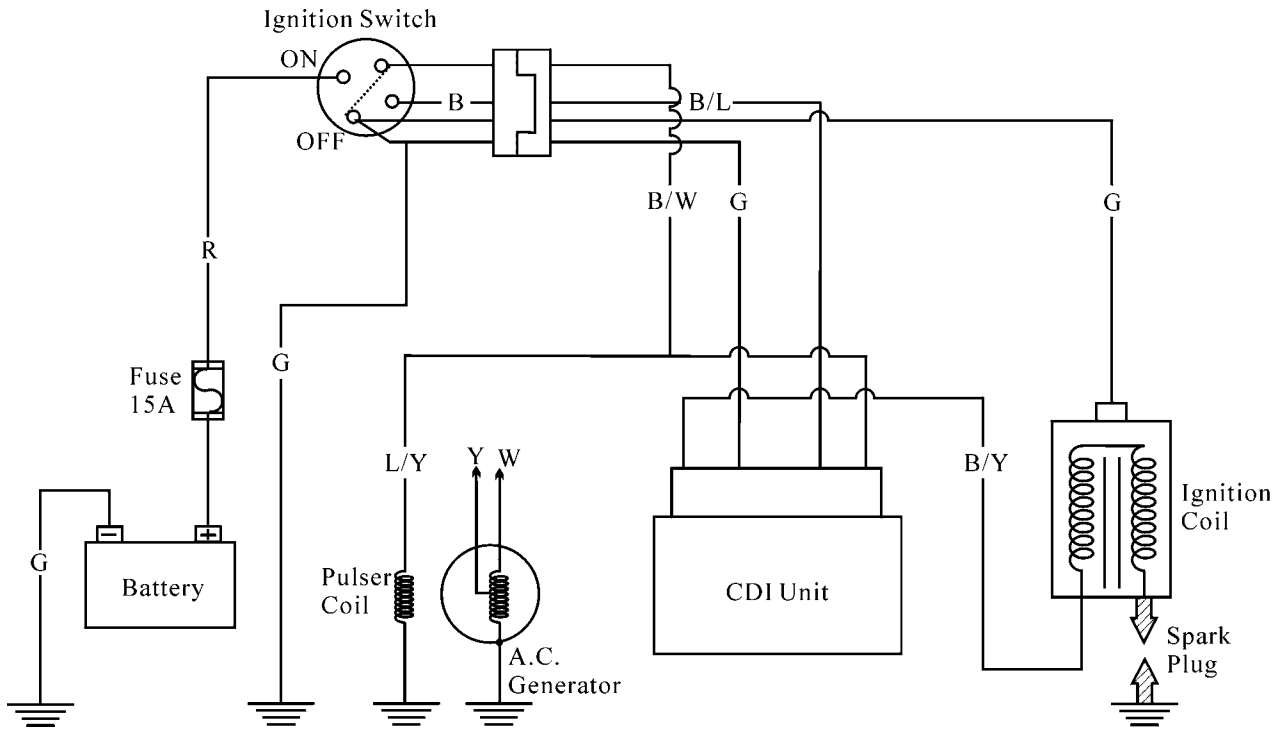

## IGNITION COIL INSPECTION

### Continuity Test

\* This test is to inspect the continuity of ignition coil.

Remove the met-in box. (⇒12-4)  
Measure the resistance between the ignition coil primary coil terminals.

**Resistance** (20°C): 0.153 ~ 0.187Ω

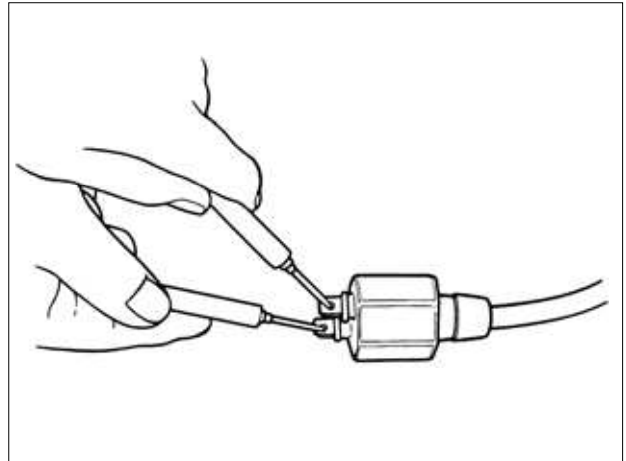

Measure the secondary coil resistance between the spark plug cap and the primary coil terminal as Figure A shown.

**Resistance** (20°C) (with plug cap): 6.99 ~ 10.21KΩ

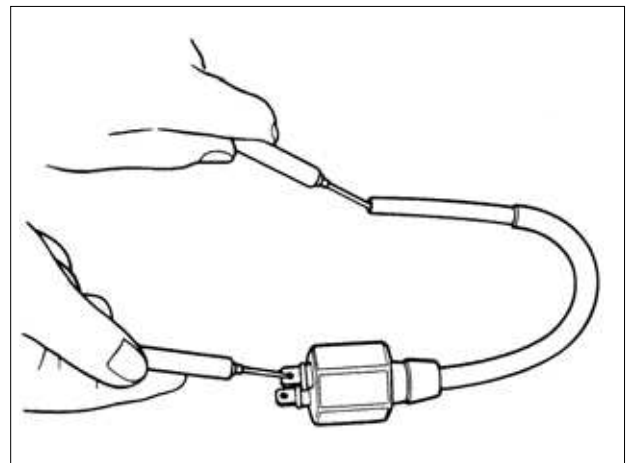

Measure the secondary coil resistance between the ignition coil terminal and the primary coil terminal as Figure B shown.

**Resistance** (20°C) (without plug cap): 3.24 ~ 3.96KΩ

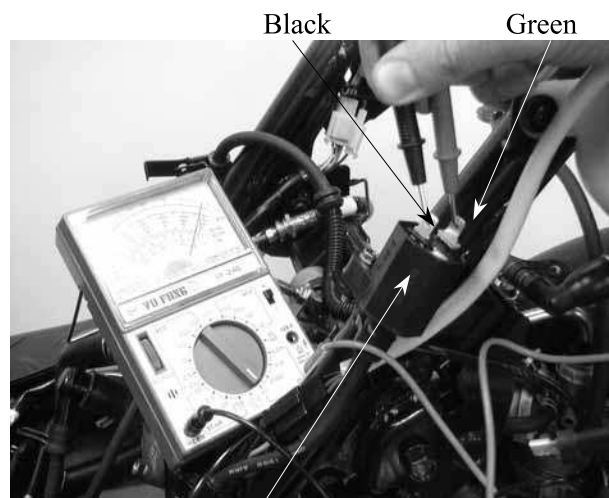

Ignition Coil

## Performance Test

Remove the ignition coil.



Inspect the ignition coil with an ignition coil tester.

\* Follow the ignition coil tester manufacturer's instructions.

1. Turn the changeover switch to 12V and connect the ignition coil to the tester.
2. Turn the power switch ON and check the spark from the watch window.
  - Good : Normal and continuous spark
  - Faulty : Weak or intermittent spark

\* The test is performed at both conditions that the ignition coil is cold and hot.

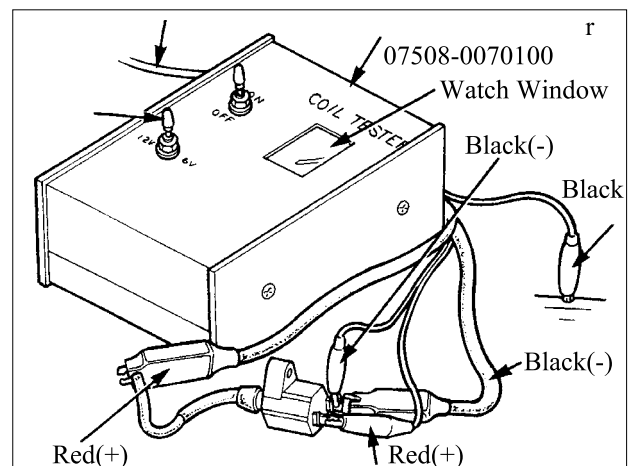

## A.C. GENERATOR

### Exciter Coil/Pulser Coil Inspection

\* This test is performed with the stator installed in the engine.

Remove the met-in box. (⇒ 12-4)  
Disconnect the A.C. generator wire connector.  
Measure the pulser coil resistance between the blue/yellow wire and ground.

**Resistance (20°C):** 80~160Ω

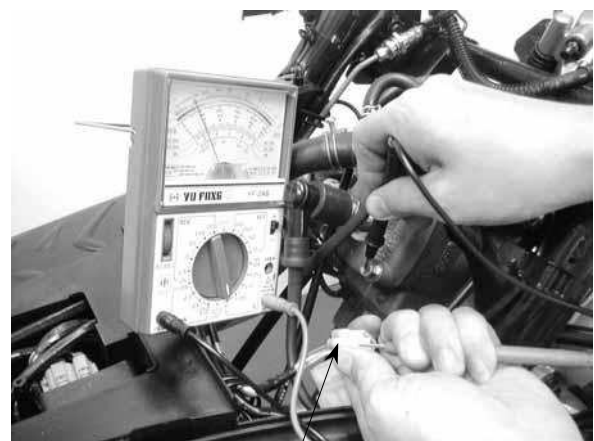

Blue/Yellow

# 15. ELECTRICAL EQUIPMENT

## CDI UNIT INSPECTION

Open the front tool box and remove the bolt.  
 Remove the front tool box. (⇒2-4)  
 Disconnect the CDI coupler and remove the CDI unit.

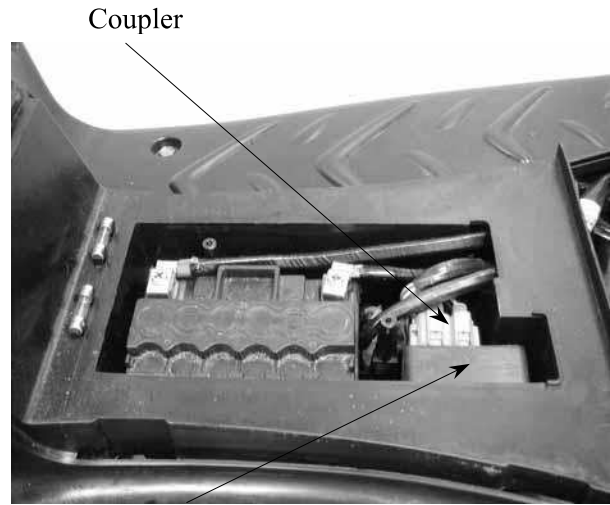

## CDI CIRCUIT INSPECTION

Measure the resistance between the terminals.  
 Replace the CDI unit if the readings are not within the specifications in the table below.

- \*
- Due to the semiconductor in circuit, it is necessary to use a specified tester for accurate testing. Use of an improper tester in an improper range may give false readings.
  - Use a Sanwa Electric Tester or Kowa Electric Tester (TH-5H).
  - In this table, “Needle swings then returns” indicates that there is a charging current applied to a condenser. The needle will then remain at “∞” unless the condenser is discharged.

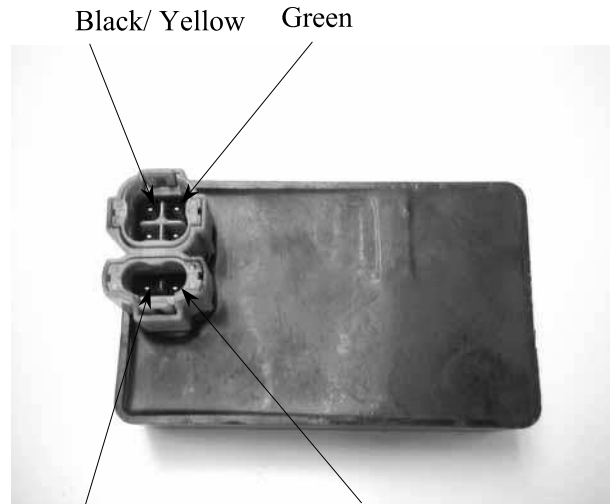

Use the x KΩ range for the Sanwa Tester.  
 Use the x 100Ω range for the Kowa Tester.

Unit: KΩ

Probe⊕ (-)Probe	Black/ Blue	Blue/ Yellow	Green	Black/ Yellow
Black/ Blue		∞	1~100	∞
Blue/ Yellow	100~∞		1~100	∞
Green	1~∞	∞		∞
Black/ Yellow	1~100	∞	0.1~50	

## STARTING SYSTEM

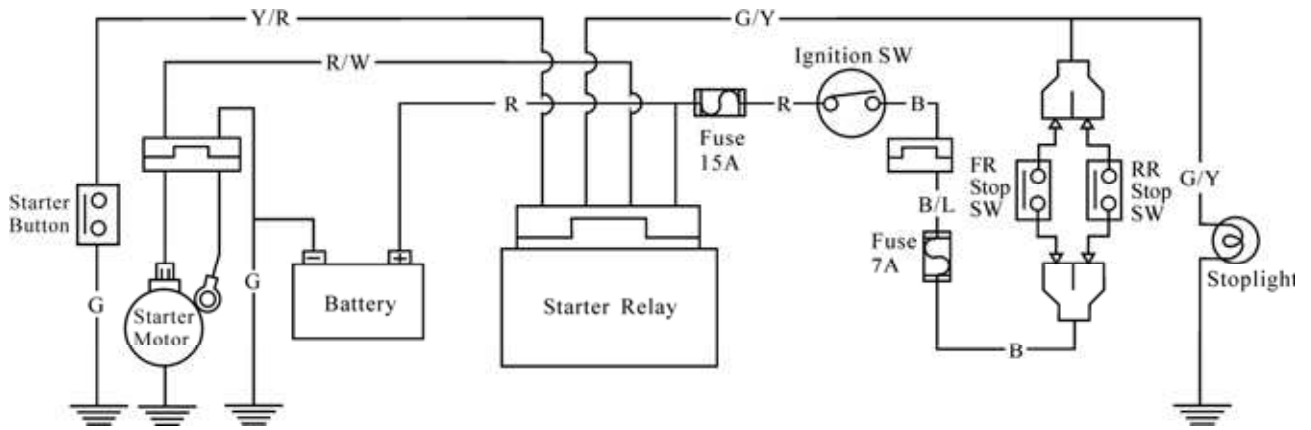

## STARTER RELAY INSPECTION

Open the front tool box and remove the bolt.  
Remove the front tool box. (⇒2-4)  
Disconnect the starter relay coupler and then  
remove the starter relay.



Connect the starter relay green/yellow terminal to the 12V battery positive (+) terminal and the relay yellow/red terminal to the battery negative (-) terminal. Check for continuity between the starter relay red and red/white terminals. The relay is normal if there is continuity.

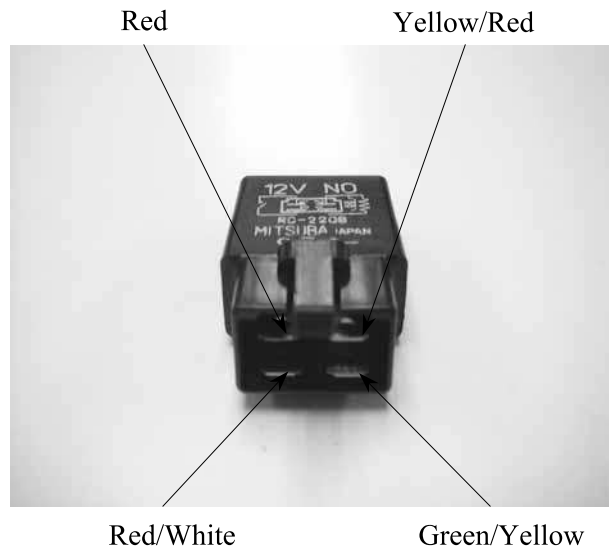

## STARTER MOTOR REMOVAL

Disconnect the starter motor cable.  
Remove the two bolts attaching the starter motor and remove the starter motor.  
The installation sequence is the reverse of removal.

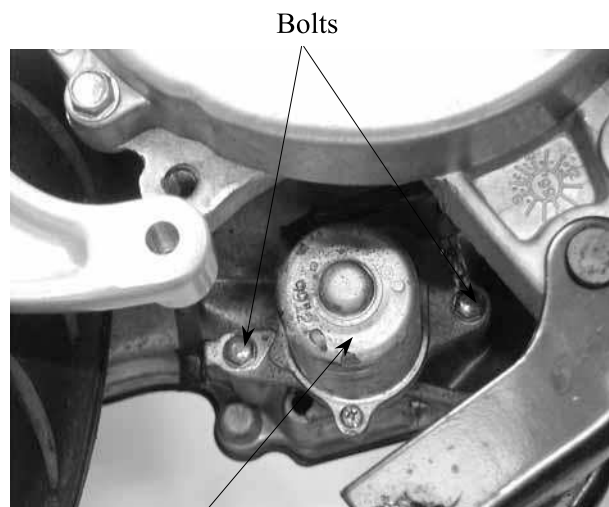

## STARTER MOTOR INSPECTION

Connect a battery across the starter motor and check for its operation.

\*

1. Do not turn the starter motor for a long time.
2. This inspection should be done with a fully charged battery.

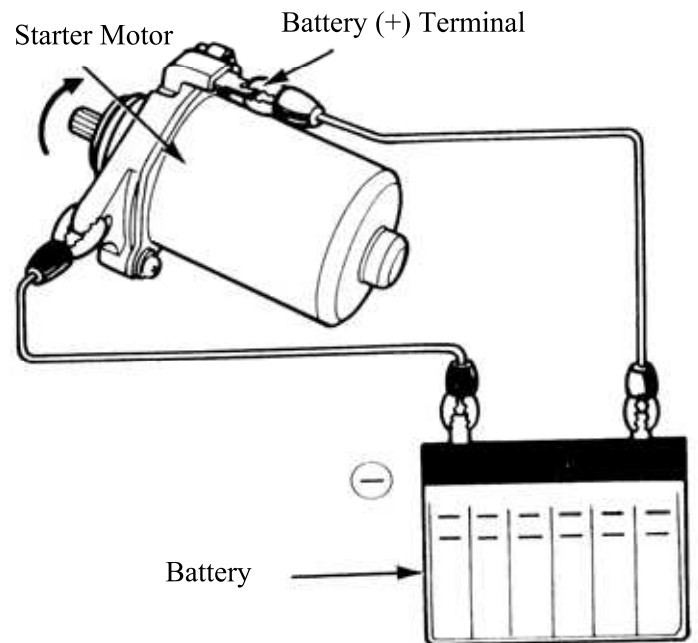



---

## INSTRUMENT/SWITCHES/LIGHTS

---

SERVICE INFORMATION .....	16-1
TROUBLESHOOTING .....	16-1
FUEL UNIT.....	16-2
OIL METER.....	16-3
SWITCHES .....	16-4
STOP SWITCH INSPECTION/HORN .....	16-6
BULB REPLACEMENT .....	16-7
INSTRUMENT/HEADLIGHT .....	16-8

## SERVICE INFORMATION

### GENERAL INSTRUCTIONS

- Wires should be connected to other wires of the same color. Couplers must be connected to other couplers of the same color.
- All plastic plugs have locking tabs that must be released before disconnecting, and must be aligned when reconnecting.
- After installation of each switch, a continuity check must be performed.

## TROUBLESHOOTING

### Lights do not come on when ignition switch is "ON"

- Burned bulb
- Faulty switch
- Broken or shorted wire
- Fuse burned out
- Weak battery
- Poorly connected wire
- Faulty winker

### Light dims

- Faulty ignition coil
- Wire or switch resistance too high
- Faulty regulator/rectifier

### Headlight does not change when dimmer switch is turn to Hi or Lo

- Faulty or burned bulb
- Faulty dimmer switch

### Motor oil indicator light does not come on (when motor oil is insufficient)

- Fuse burned out
- Dead battery
- Faulty ignition switch
- Faulty instrument
- Faulty oil meter

### Motor oil indicator light winks

- Loose wire connection
- Broken wire
- Faulty oil meter

### Fuel gauge pointer does not register correctly

- Disconnected wire or connector
- Broken wire
- Faulty float
- Faulty fuel unit
- Faulty instrument

### Fuel gauge pointer fluctuates or swings

- Loose wire connection
- Faulty fuel unit
- Faulty instrument

## FUEL UNIT

\* No Smoking!

### REMOVAL

Remove the frame body cover. (⇒2-3)  
 Disconnect the fuel unit wire connectors.  
 Turn the fuel unit retainer counterclockwise to remove it.

\* Do not damage the fuel unit wire.

Remove the fuel unit.

\* Be careful not to bend or damage the fuel unit float arm.

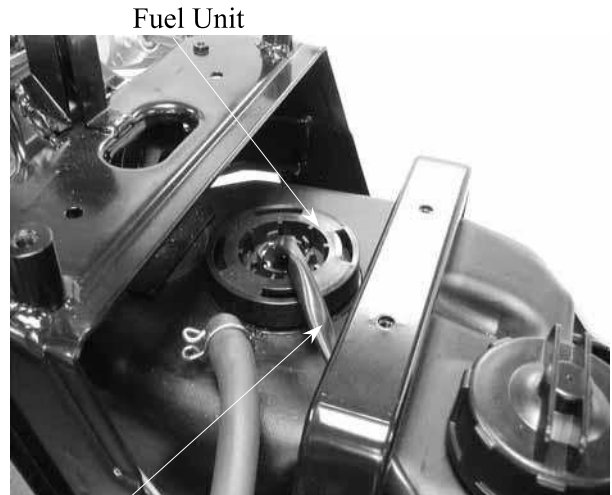

Fuel Unit Wire

### INSPECTION

Remove the fuel unit.  
 Measure the resistance between the fuel unit wire terminals with the float at upper and lower positions.

Wire Terminals	Upper	Lower
G~Y/W	33Ω	686Ω
G~L/W	566Ω	53Ω
Y/W~L/W	600Ω	600Ω

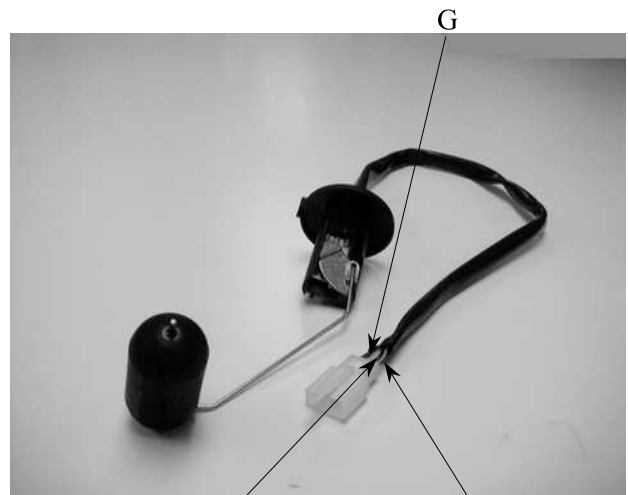

Y/W

L/W

### FUEL GAUGE INSPECTION

Connect the fuel unit wire connectors and turn the ignition switch "ON".

\* Before performing the following test, operate the turn signals to determine that the battery circuit is normal.

Check the fuel gauge needle for correct indication by moving the fuel unit float up and down.

Float Position	Needle Position
Upper	"F" (Full)
Lower	"E" (Empty)



## INSTALLATION

The installation sequence is the reverse of removal.

- \* 

<ul style="list-style-type: none"> <li>• Align the tab on the fuel unit with the groove on the fuel tank.</li> <li>• Turn the retainer clockwise to secure it.</li> </ul>
---

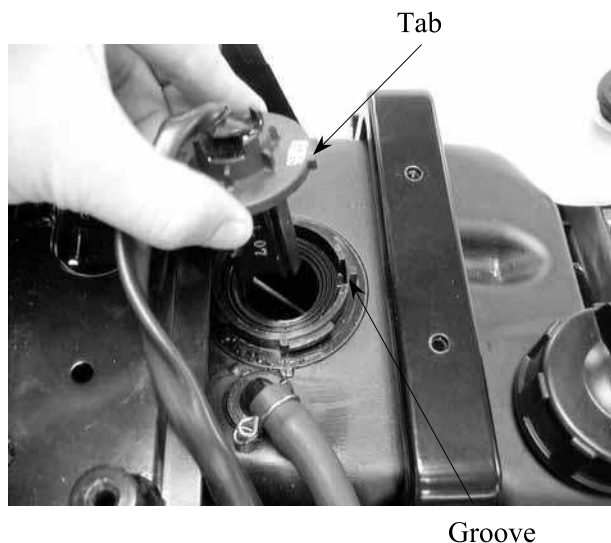

## OIL METER

### INSPECTION

Remove the met-in box. (⇒2-2)  
 Remove the frame body cover. (⇒2-2)  
 Disconnect the oil meter wire connectors and remove the oil meter. Keep the oil meter float at the lower position.  
 Measure the resistances between the wire terminals as ① and ② shown in the left figure.

Wire Terminals	Resistance
Green/Red(+) ~ Black(-)	5 ~ 16Ω
Green(-) ~ Black(+)	∞

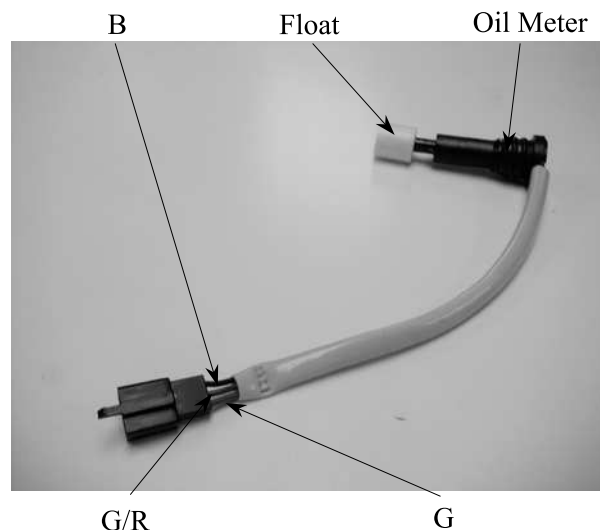

- \* Before removing the oil meter, be sure to drain the motor oil and do not allow sparks or flames near the working area.

### Oil Meter Operation Inspection

Connect the oil meter wire connectors and turn the ignition switch ON.  
 Measure the resistance between the wire terminals with the float at upper position.

Green/Red(+) ~ Black(-)	About 340Ω
-------------------------	------------

- \* Before performing the following test, operate the turn signals to determine that the battery circuit is normal.



Move the oil meter float up and down to see if the oil indicator light will go out and come on.

\* If the oil indicator light does not light, check for burned bulb, loose wire or connector. After correction, check again according to the method mentioned above.

Oil Indicator Light



## SWITCHES

### IGNITION SWITCH INSPECTION

Remove the front upper/lower cover. (⇒2-3)  
Disconnect the ignition switch wire couplers and check for continuity between the wire terminals.

Color	Red	Black/White	Green	Black
Symbol	BAT <sub>1</sub>	IG	E	BAT <sub>2</sub>
LOCK		○	○	
OFF		○	○	
ON	○			○

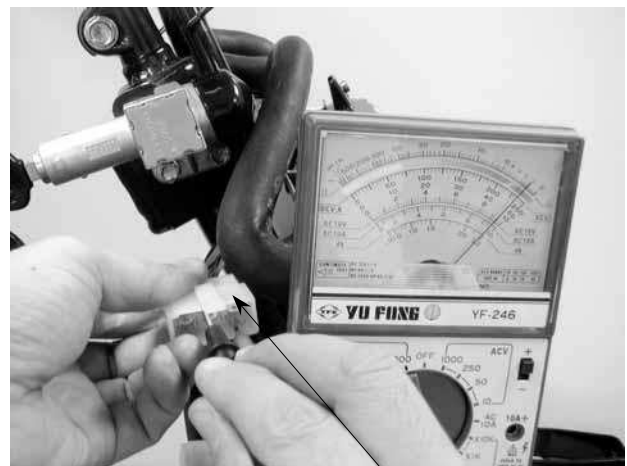

Ignition Switch Coupler

### IGNITION SWITCH REPLACEMENT

Remove the front upper/lower cover. (⇒2-3)  
Disconnect the ignition switch wire couplers.  
Remove the two mounting bolts and remove the ignition switch.  
The installation sequence is the reverse of removal.



Bolts

# 16. INSTRUMENT/SWITCHES/LIGHTS

## HEADLIGHT SWITCH INSPECTION

Remove the handlebar lower cover. (⇒2-7)  
 Disconnect the headlight switch wire coupler and check for continuity between wire terminals.

Color	Blue/White	Yellow	Brown	Pink
Symbol	HL	CI	TL	RE
OFF		○	—	○
P		○	○	
H	○	○	○	

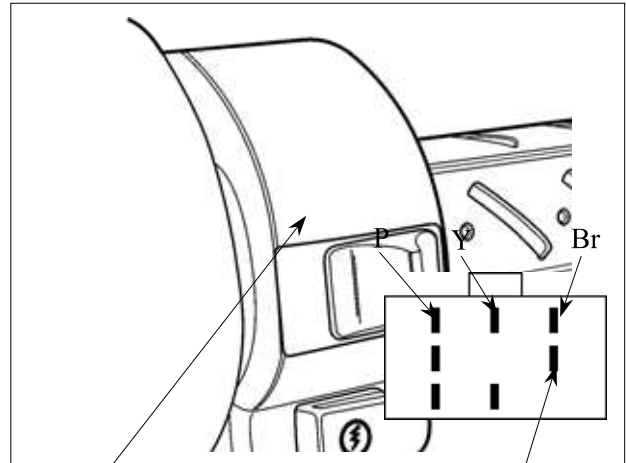

Headlight Switch

L/W

## DIMMER SWITCH INSPECTION

Check for continuity between wire terminals.

Color	White/Blue	Blue	White	Black
Symbol	HL	HI	LO	BAT <sub>2</sub>
HI	○	○		
LO	○		○	
PASSING		○		○

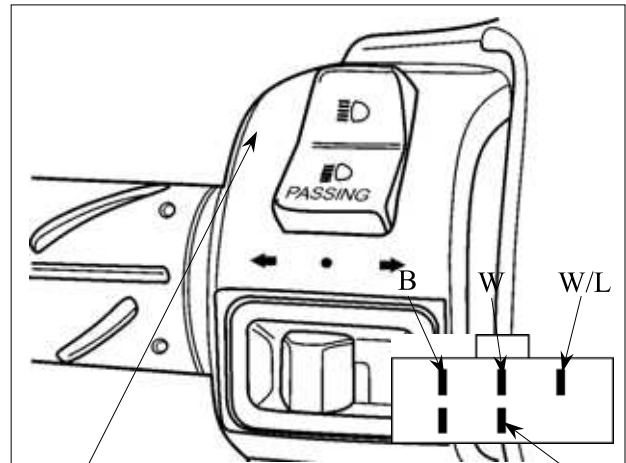

Dimmer Switch

L

## TURN SIGNAL SWITCH INSPECTION

Check for continuity between the wire terminals.

Color	Light Blue	Orange	Gray
Symbol	R	L	WR
R	○		○
L		○	○

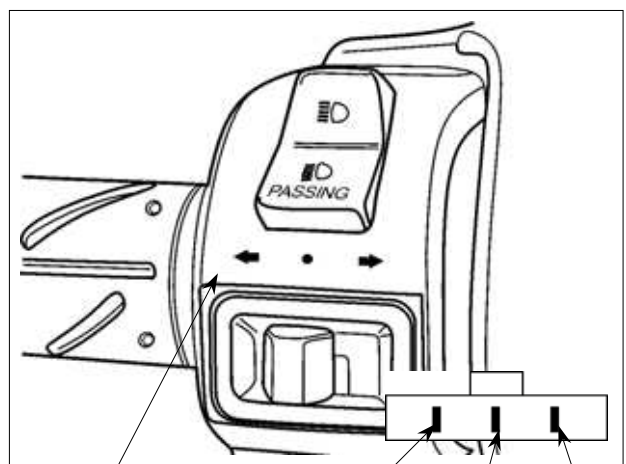

Turn Signal Switch

SB

O

Gr

# 16. INSTRUMENT/SWITCHES/LIGHTS

## STARTER SWITCH INSPECTION

Check for continuity between wire terminals.  
Push the starter button when measuring.

Color	Yellow/Red	Green
Symbol	ST	E
FREE		
PUSH		

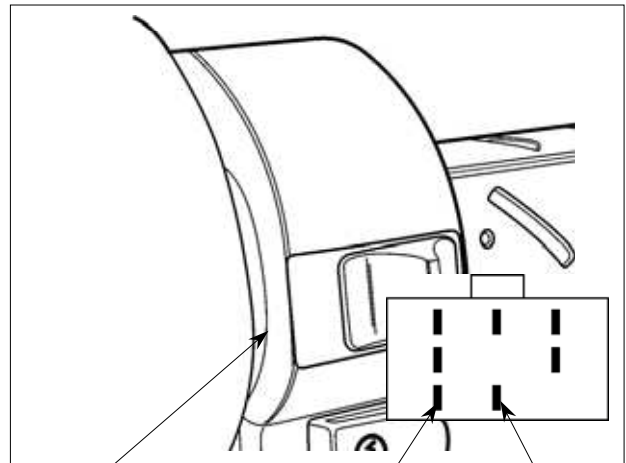



Starter Switch

G

Y/R

## HORN SWITCH INSPECTION

Check for continuity between wire terminals.  
Push the horn button when measuring.

Color	Light Green	Black
Symbol	HO	BAT <sub>2</sub>
FREE		
PUSH		

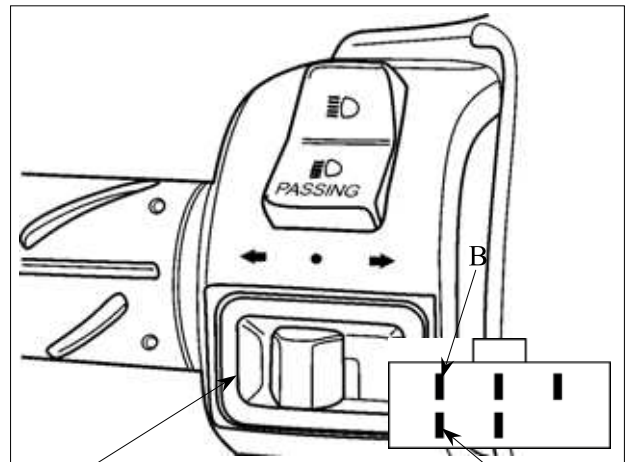

Horn Switch

Lg

## STOP SWITCH INSPECTION

Remove the handlebar lower cover. (⇒2-7)  
Disconnect the front and rear stop switch wire couplers.

Check for continuity between the wire terminals when the front/rear brake lever is applied.



## HORN INSPECTION

Remove the front upper/lower cover. (⇒2-3)  
Disconnect the horn wire couplers. The horn is normal if it sounds when a 12V battery is connected across the horn wire terminals.

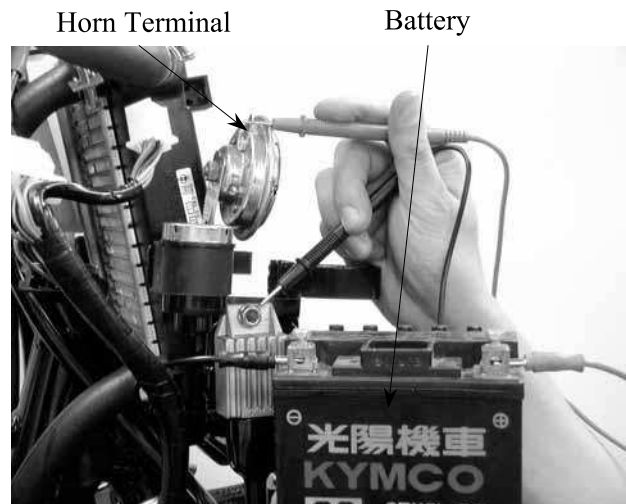

## FRONT TURN SIGNAL LIGHT REPLACEMENT

Remove the turn signal light shell and the bulb.  
Replace with new ones.

\* Replace with new bulbs of the same specifications.



Turn Signal Light Bulb

## TAILLIGHT/STOPLIGHT/REAR TURN SIGNAL LIGHT BULB REPLACEMENT

Taillight Shell Removal:  
Remove two screws attaching the taillight shell.  
Remove the taillight shell and stop light bulb.  
Remove the rear turn signal light bulbs.  
The installation sequence is the reverse of removal.



Screws



## INSTRUMENT

### Instrument Bulbs Replacement

Remove three screws attaching the instrument bulbs.  
Remove the instrument bulbs cover.  
Remove the bulbs and replace with new ones.

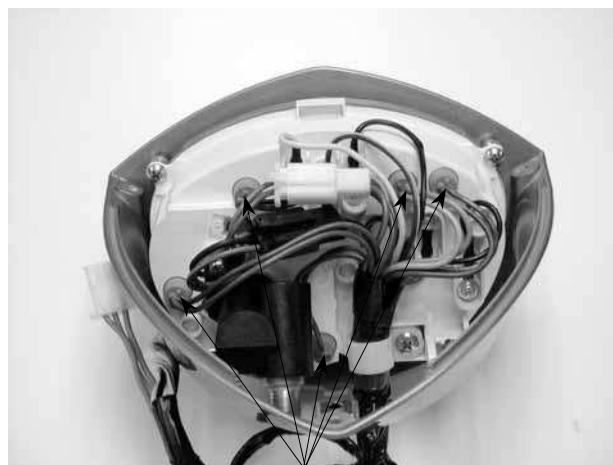

Bulb Sockets

### SPEEDOMETER REMOVAL

Disconnect the speedometer cable.  
Disconnect the speedometer wire connector.  
Remove the two screws attaching the speedometer.  
Remove the speedometer.  
The installation sequence is the reverse of removal.



Screws

Wire Couplers

## HEADLIGHT

### REMOVAL/BULB REPLACEMENT

Remove the front upper/lower cover. (⇒2-3)  
Remove the bulb sockets and bulbs.

\*

- The model adopts krypton gas bulb. When installing, do not directly touch the bulb glass with fingers.
- Use bulbs of the same specifications for replacement.

The installation sequence is the reverse of removal.

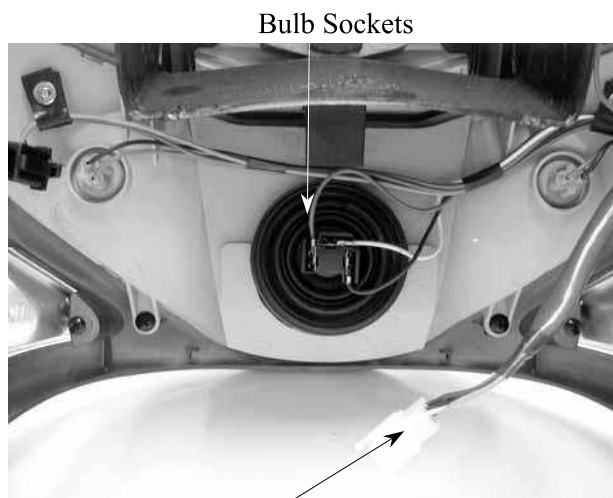

Bulb Sockets

Coupler

# 17. EVAPORATIVE/EXHAUST EMISSION CONTROL SYSTEM

---



# 17. EVAPORATIVE/EXHAUST EMISSION CONTROL SYSTEM

---

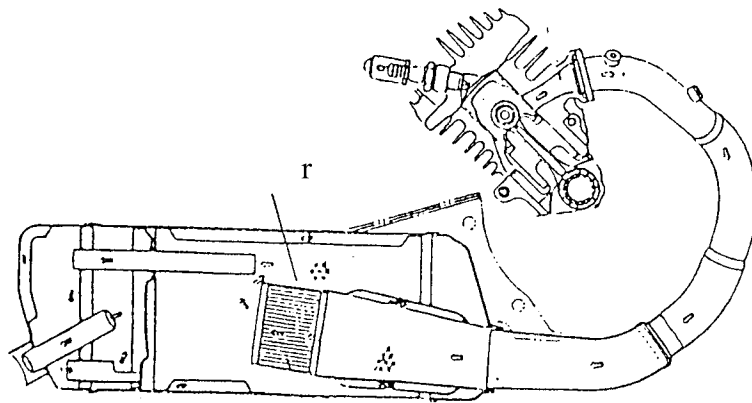

## 17. EVAPORATIVE/EXHAUST EMISSION CONTROL SYSTEM



\*

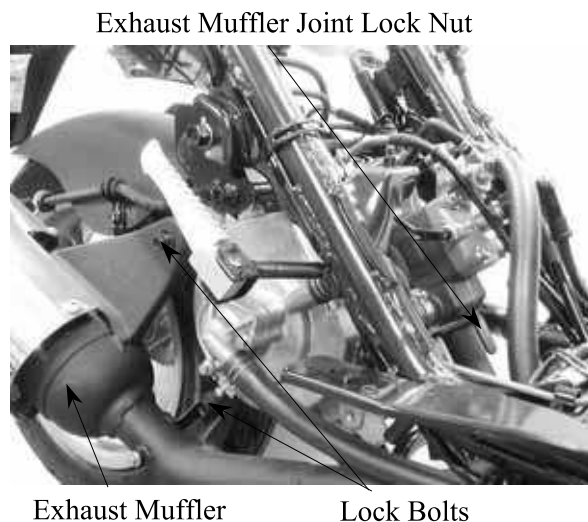

\*

- A large amount of unburned mixture flowing into the high-heat catalytic converter will burn again and cause damage to the converter due to overheating. Pay attention to the following.
- Use 92# or 95# nonleaded gasoline only. (Leaded gasoline will cause catalytic converter failure.)
- During riding, do not turn the ignition switch OFF to avoid a large amount of unburned mixture flowing into the exhaust muffler.
- Faulty ignition system or fuel system will cause overheating and damage to the catalytic converter.

# 17. EVAPORATIVE/EXHAUST EMISSION CONTROL SYSTEM

---

