

## **PREFACE**

This Service Manual describes the technical features and servicing procedures for the KYMCO *VITALITY 50*.

In this manual, many illustrations and drawings are used to help servicemen have better understanding.

Section 2 contains the service precautions for all operations and troubleshooting stated in this manual. Read them carefully before starting any operation.

Section 3 describes the inspection/adjustment procedures, safety rules and service information for each part, starting from periodic maintenance.

Sections 4 through 17 give instructions for disassembly, assembly and inspection of lubrication system, engine, fuel system and electrical equipment.

Section 18 is the KYMCO clean air system (for EURO 2)

**By KWANG YANG Motor Co., Ltd.  
First Edition, May 2004  
All rights reserved. Any reproduction or  
unauthorized use without the written permission of  
KWANG YANG Motor Co., Ltd.  
is expressly prohibited.  
4121-LBD5/6-S00**

---

**TABLE OF CONTENTS**

<b>SPECIFICATIONS .....</b>	<b>1</b>
<b>GENERAL INFORMATION .....</b>	<b>2</b>
<b>INSPECTION/ADJUSTMENT .....</b>	<b>3</b>
<b>LUBRICATION SYSTEM.....</b>	<b>4</b>
<b>ENGINE REMOVAL/INSTALLATION .....</b>	<b>5</b>
<b>4-STROKE: CYLINDER HEAD/VALVES .....</b>	<b>6</b>
<b>CYLINDER HEAD (2-STROKE)/CYLINDER/PISTON.....</b>	<b>7</b>
<b>A.C. GENERATOR.....</b>	<b>8</b>
<b>KICK STARTER/DRIVE PULLEY/CLUTCH/DRIVEN PULLEY.....</b>	<b>9</b>
<b>FINAL REDUCTION .....</b>	<b>10</b>
<b>CRANKCASE/CRANKSHAFT.....</b>	<b>11</b>
<b>CARBURETOR.....</b>	<b>12</b>
<b>FRAME COVERS/EXHAUST MUFFLER .....</b>	<b>13</b>
<b>STEERING HANDLEBAR/FRONT WHEEL/FRONT BRAKE/ FRONT SHOCK ABSORBER/FRONT FORK.....</b>	<b>14</b>
<b>REAR WHEEL/REAR BRAKE/REAR SHOCK ABSORBER.....</b>	<b>15</b>
<b>ELECTRICAL EQUIPMENT .....</b>	<b>16</b>
<b>INSTRUMENT/SWITCHES/LIGHTS.....</b>	<b>17</b>
<b>KCAS (FOR EURO 2) .....</b>	<b>18</b>



# 1. SPECIFICATIONS

## SPECIFICATIONS

### (2-Stroke)

Name & Model		SF10FA	
Overall length (mm)		1870	
Overall width (mm)		700	
Overall height (mm)		1120	
Wheel base (mm)		1296	
Engine type		Air cooled 2-stroke	
Displacement (cc)		49.4 cc	
Net weight (kg)		97	
Seating capacity		1 riders (75kg)	
Gross weight(kg)		173 (1 rider)	
Tires	Front wheel	120/70-12	
	Rear wheel	130/70-12	
Ground clearance (mm)		150	
Braking distance (m) (Initial speed Km/h)		4.4m (30km/h)	
Min. turning radius (mm)		1920	
Starting system		Starting motor & Kick starter	
Fuel type		#92 or higher unleaded gasoline	
Cylinder arrangement		Single cylinder, flat	
Combustion chamber type		Semi-sphere	
Valve arrangement		Reed valve & piston	
Bore x stroke (mm)		39 x 41.4	
Compression ratio		7.2 : 1	
Compression pressure (kg/cm <sup>2</sup> rpm)		11.8kg/cm <sup>2</sup>	
Max. horsepower (ps/rpm)		4.5/6000 (Speed limited type:3.9/6000)	
Max. torque (kg-m/rpm)		0.5/6000 (Speed limited type:0.48/6000)	
Port timing	Intake	Open	Automatic controlled
		Close	Automatic controlled
	Exhaust	Open	—
		Close	—
	Scavenge	Open	—
		Close	—
Idle speed (rpm)		2000±100	
Lubrication type		Separate type	
Oil pump type		Plunger type	
Oil filter type		Full-flow filtration	

Lubrication oil capacity (liter)		1.3	
Air cleaner type & No.		Wet, single	
Fuel capacity (liter)		5.0	
Carburetor	Type	PB	
	Piston dia. (mm)	—	
	Venturi dia. (mm)	14	
Ignition system type		CDI electromagnetic Ignition	
Ignition timing F mark		13.5°±2°/3000rpm	
Spark plug		NGK	BR8HSA
		ND	—
Spark plug gap (mm)		0.6□0.7	
Battery capacity		12V3AH	
Power to transmission gear		Power-transmission gear-clutch	
Reduction ratio of power to transmission		—	
Clutch type		Dry multi-disc clutch	
Transmission gear operation type		Automatic centrifugal type	
Transmission ratio		1 speed	—
Reduction gear	Type	Two-stage reduction	
	1st reduction ratio	—	
	2nd reduction ratio	—	
Transmission gear type		Non-stage transmission	
Tire pressure (kg/cm <sup>2</sup> )	Front/Rear wheel	1.50/2.0 (1 rider)	
		1.75/2.25 (2 rider)	
Turning angle		Right & left 45°	
Brake system type	Front wheel	hydraulic	
	Rear wheel	Expanding	
Suspension type	Front wheel	Telescope	
	Rear wheel	Unit swing	
Shock absorber type	Front wheel	Telescope	
	Rear wheel	Unit swing	
Frame type		Pipe under bone	
Exhaust emission concentration	MASS CO	1.0 g/km	
	MASS HC+NOX	1.2 g/km	

# 1. SPECIFICATIONS

## SPECIFICATIONS

### (4-Stroke)

Name & Model No.		SG10AA		
Overall length (mm)		1870		
Overall width (mm)		700		
Overall height (mm)		1120		
Wheel base (mm)		1296		
Engine type		O.H.C.		
Displacement (cc)		49.5		
Fuel Used		92# nonleaded gasoline		
Dry weight (kg)		91		
Seating capacity		1 riders (75kg)		
Net weight(kg)		97		
Tires	Front wheel	120/70-12 56J		
	Rear wheel	130/70-12 59J		
Ground clearance (mm)		150		
Breaking distance (m)(30KPH)		4.4 below		
Engine	Starting system		Motor & Kick starter	
	Type		Gasoline, 4-stroke	
	Cylinder arrangement		Single cylinder	
	Combustion chamber type		Semi-sphere	
	Valve arrangement		O.H.C., chain drive	
	Bore x stroke (mm)		39X41.4	
	Compression ratio		10.5:1	
	Compression pressure		14.0	
	Max. horsepower		3.8/8000 (ps/rpm)	
	Max. torque (kg m/rpm)		0.35/7000	
	Port timing	Intake	Open	3°
			Close	11°
		Exhaust	Open	-9°
			Close	19°
	Valve clearance (cold) (mm)		Intake	0.04
			Exhaust	0.04
	Idle speed (rpm)		1800rpm	
	Lubrication System	Lubrication type		Forced pressure & Wet sump
		Oil pump type		Inner/outer rotor type
		Oil filter type		Full-flow filtration
Oil capacity		0.85 liter		
Oil exchanging capacity		0.7 liter		
Cooling Type		Air cooling		

Fuel System	Air cleaner type & No		Wet paper	
	Fuel capacity		5.0 liters	
	Carburetor	Type	CVK	
		Main jet No.	#82 (speed limited: #80)	
		Venturi dia.(mm)	φ17	
Throttle type		PISTON		
Electrical Equipment System	Ignition System		Type	CDI
	Ignition timing		28°BTDC/4000rpm	
	Contact breaker		Non-contact point type	
	Spark plug		NGK C7HSA	
	Spark plug gap		0.6□0.7mm	
Battery		Capacity	12V4AH	
Power Drive System	Clutch	Type	CVT	
		Transmission Gear	Type	Helical gear
	Operation		Automatic centrifugal Type	
	Reduction Gear	Type	V-Belt	
		Primary reduction	0.75~2.47	
Final reduction		13.61		
Moving Device	FR/RR tire rolling circumference(mm)		1485/1515	
	Tire pressure (kgf/cm <sup>2</sup> )	Front	1.5	
		Rear	2.0	
	Turning angle	Left	45°	
Right		45°		
Brake system type		Front	Disk brake	
		Rear	Drum brake	
Damping Device	Suspension type		Front	Telescope
			Rear	Under-swing
Frame type		Under bone		

## 2. GENERAL INFORMATION

---

---

### GENERAL INFORMATION

---

MODEL IDENTIFICATION .....	2- 1
SERVICE PRECAUTIONS .....	2- 2
SERVICE INFORMATION (2-STROKE).....	2- 6
SERVICE INFORMATION (4-STROKE).....	2- 8
TORQUE VALUES (2-STROKE) .....	2-10
TORQUE VALUES (4-STROKE) .....	2-11
SPECIAL TOOLS (2-STROKE) .....	2-12
SPECIAL TOOLS (4-STROKE) .....	2-12
LUBRICATION POINTS .....	2-13
WIRING DIAGRAM .....	2-15
CABLE & HARNESS ROUTING (2-STROKE) .....	2-17
CABLE & HARNESS ROUTING (4-STROKE).....	2-21
TROUBLESHOOTING (2-STROKE).....	2-25
TROUBLESHOOTING (2-STROKE)-----	2-36

## 2. GENERAL INFORMATION

### MODEL IDENTIFICATION

The read serial frame number (2), please remove the cover on inner cover (1) with a flat head screwdriver.

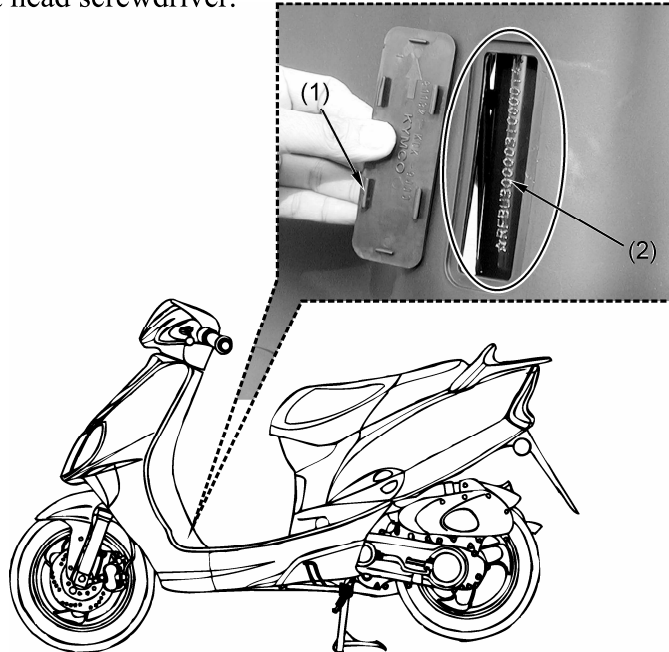

The engine serial number is stamped on right engine case.

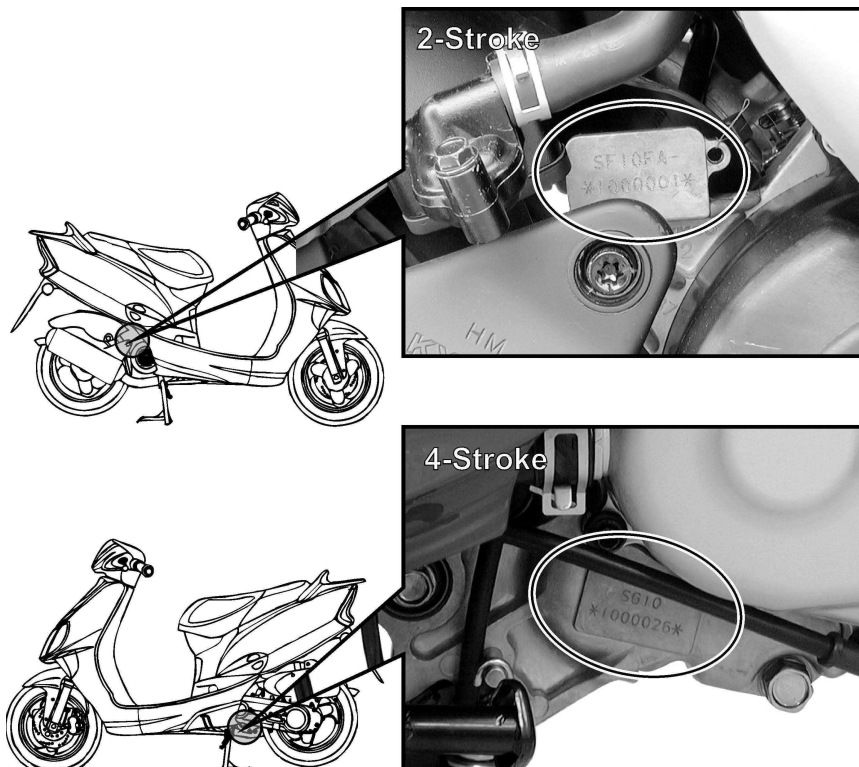

## 2. GENERAL INFORMATION

### SERVICE PRECAUTIONS

- Make sure to install new gaskets, O-rings, circlips, cotter pins, etc. when reassembling.

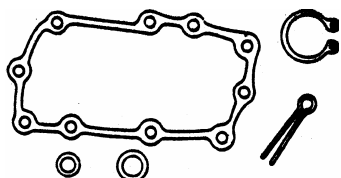

- When tightening bolts or nuts, begin with larger-diameter to smaller ones at several times, and tighten to the specified torque diagonally.

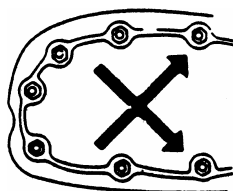

- Use genuine parts and lubricants.

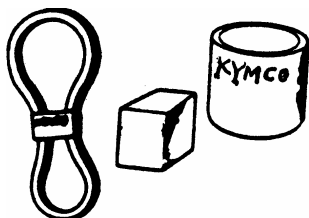

- When servicing the motorcycle, be sure to use special tools for removal and installation.



- After disassembly, clean removed parts. Lubricate sliding surfaces with engine oil before reassembly.



- Apply or add designated greases and lubricants to the specified lubrication points.

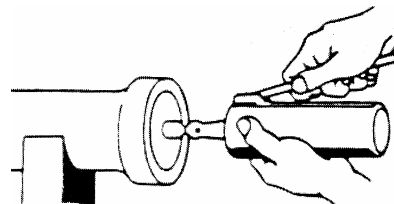

- After reassembly, check all parts for proper tightening and operation.

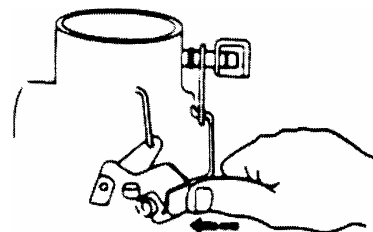

- When two persons work together, pay attention to the mutual working safety.

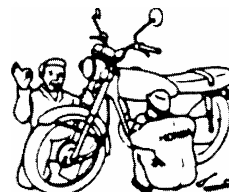

- Disconnect the battery negative (-) terminal before operation.
- When using a spanner or other tools, make sure not to damage the motorcycle surface.

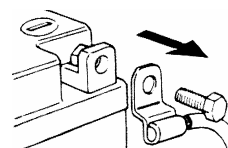

- After operation, check all connecting points, fasteners, and lines for proper connection and installation.
- When connecting the battery, the positive (+) terminal must be connected first.
- After connection, apply grease to the battery terminals.
- Terminal caps shall be installed securely.

## 2. GENERAL INFORMATION

- If the fuse is burned out, find the cause and repair it. Replace it with a new one according to the specified capacity.

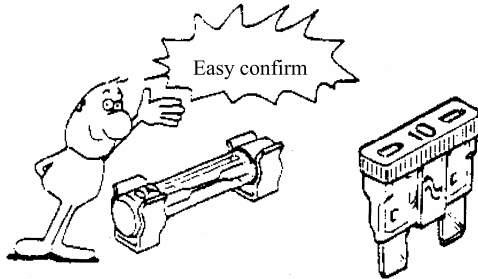

- After operation, terminal caps shall be installed securely.

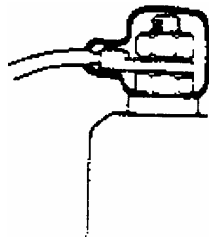

- When taking out the connector, the lock on the connector shall be released before operation.

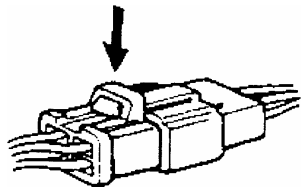

- Hold the connector body when connecting or disconnecting it.
- Do not pull the connector wire.

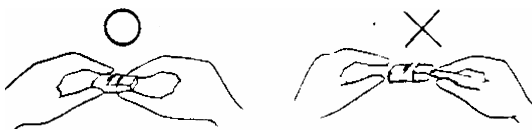

- Check if any connector terminal is bending, protruding or loose.

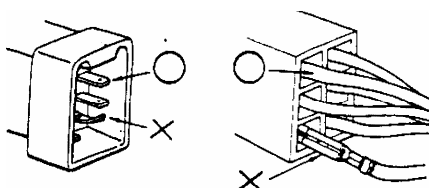

- The connector shall be inserted completely.
- If the double connector has a lock, lock it at the correct position.
- Check if there is any loose wire.

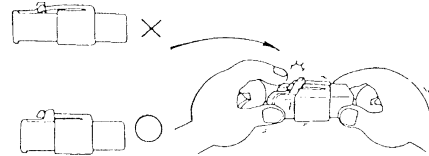

- Before connecting a terminal, check for damaged terminal cover or loose negative terminal.

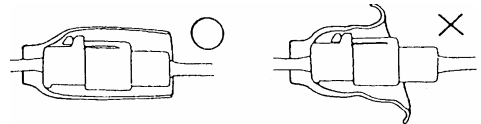

- Check the double connector cover for proper coverage and installation.



- Insert the terminal completely.
- Check the terminal cover for proper coverage.
- Do not make the terminal cover opening face up.

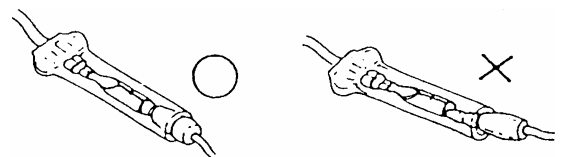

- Secure wire harnesses to the frame with their respective wire bands at the designated locations. Tighten the bands so that only the insulated surfaces contact the wire harnesses.

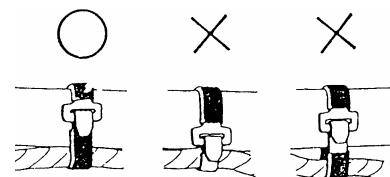

## 2. GENERAL INFORMATION

- After clamping, check each wire to make sure it is secure.

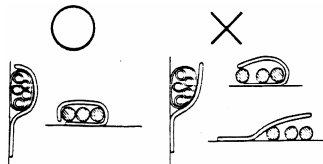

- Do not squeeze wires against the weld or its clamp.



- After clamping, check each harness to make sure that it is not interfering with any moving or sliding parts.

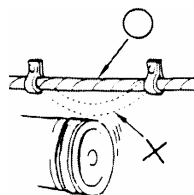

- When fixing the wire harnesses, do not make it contact the parts which will generate high heat.

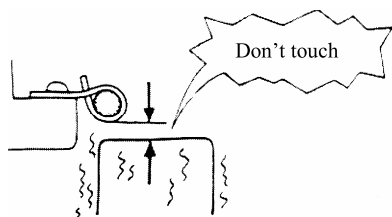

- Route wire harnesses to avoid sharp edges or corners. Avoid the projected ends of bolts and screws.
- Route wire harnesses passing through the side of bolts and screws. Avoid the projected ends of bolts and screws.

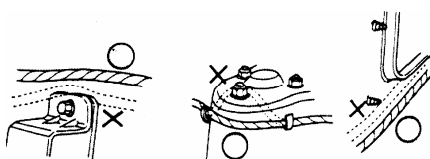

- Route harnesses so they are neither pulled tight nor have excessive slack.

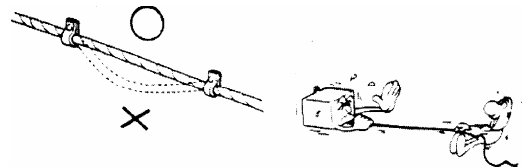

- Protect wires and harnesses with electrical tape or tube if they contact a sharp edge or corner.

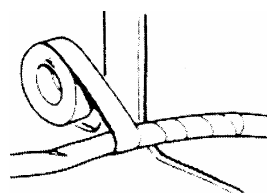

- When rubber protecting cover is used to protect the wire harnesses, it shall be installed securely.

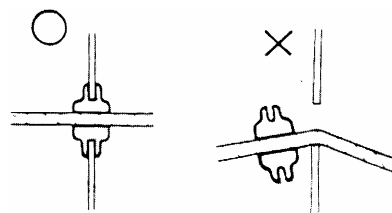

- Do not break the sheath of wire.
- If a wire or harness is with a broken sheath, repair by wrapping it with protective tape or replace it.

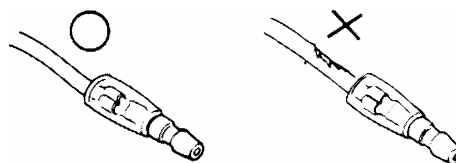

- When installing other parts, do not press or squeeze the wires.

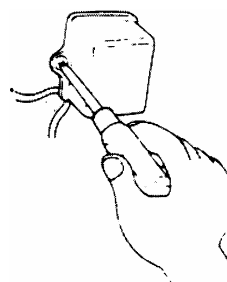

## 2. GENERAL INFORMATION

- After routing, check that the wire harnesses are not twisted or kinked.

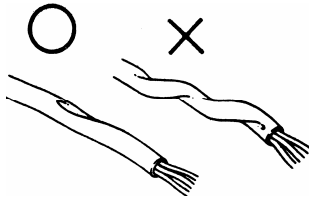

- Wire harnesses routed along with handlebar should not be pulled tight, have excessive slack or interfere with adjacent or surrounding parts in all steering positions.

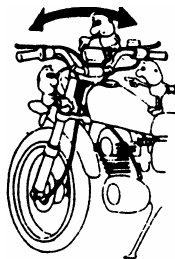

- When a testing device is used, make sure to understand the operating methods thoroughly and operate according to the operating instructions.

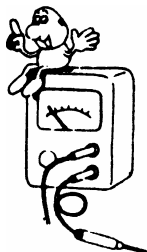

- Be careful not to drop any parts.



- When rust is found on a terminal, remove the rust with sand paper or equivalent before connecting.



- Symbols:

The following symbols represent the servicing methods and cautions included in this service manual.



Apply engine oil to the specified points. (Use designated engine oil for lubrication.)



Apply grease for lubrication.



Use special tool.



Caution



Warning

(⇒12-3)

Refer to page 12-3.



## 2. GENERAL INFORMATION

### SERVICE INFORMATION (2-STROKE)

ENGINE	Standard (mm)	Service Limit (mm)
Item	VITALITY 50	
Cylinder head warpage	—	0.10
Piston O.D.(5mm from bottom of piston skirt)	38.955□38.970	38.90
Cylinder-to- piston clearance		0.10
Piston pin hole I.D.	12.002□12.008	12.03
Piston pin O.D.	11.994□12.0	11.98
Piston-to-piston pin clearance	—	—
Piston ring end gap (top/second)	0.10□0.25	0.40
Connecting rod small end I.D.	17.005□17.017	17.03
Cylinder bore	39.0□39.025	39.05
Drive belt width	18	17
Drive pulley collar O.D.	19.96□19.974	19.94
Movable drive face ID.	20.011□20.052	20.6
Weight roller O.D.	15.92□16.08	15.4
Clutch outer I.D.	107□107.2	107.5
Driven face spring free length	87.9	82.6
Driven face O.D.	33.965□33.985	33.94
Movable driven face I.D.	34.000□34.025	34.06
Connecting rod big end side clearance	—	—
Connecting rod big end radial clearance	—	—
Crankshaft runout A/B	—	—

CARBURETOR	VITALITY
Setting mark	PB168A
Type	PB 14
Float level	8.6mm
Main jet	#85 (Speed limit type: #72)
Slow jet	#35
Air screw opening	2 1/2±1/2
Idle speed	1850±100rpm
Throttle grip free play	2□6mm
Jet needle clip notch	1st notch

## 2. GENERAL INFORMATION

FRAME		Standard (mm)	Service Limit (mm)
Item		VITALITY 50	
Axle shaft runout		—	0.2
Front wheel rim runout	Radial		
	Axial		
Front shock absorber spring free length		214.7	
Rear wheel rim runout			2.0
Brake drum I.D.	Front/rear	110	111
Brake lining thickness	Front/rear	6.4/4.0	2.0/2.0
Brake disk runout	Front/rear	—	0.30
Rear shock absorber spring free length		209	

ELECTRICAL EQUIPMENT			VITALITY 50
Battery	Capacity		12V3AH
	Voltage		13.0□13.2V
	Charging current	Standard	0.4A/5H~10H
		Quick	4A/0.5H
Spark plug	(NGK)		BR8HAS
Spark plug gap			0.6□0.7mm
Ignition coil resistance	Primary coil		0.153□0.187Ω
	Secondary coil (with plug cap)		6.99K□10.21KΩ
	Secondary coil (without plug cap)		3.24K□3.96KΩ
Pulser coil resistance (20□)			80□160Ω
Ignition timing			13.5°±2°BTDC/3000 rpm

## 2. GENERAL INFORMATION

### SERVICE INFORMATION (4-STROKE)

ENGINE	Standard (mm)	Service Limit (mm)
Item	VITALITY 50 (4-Stroke)	
Cylinder head warpage	—	0.10
Piston O.D.(4.55mm from bottom of piston skirt)	38.975□38.99	38.90
Cylinder-to- piston clearance	0.010□0.040	0.10
Piston pin hole I.D.	13.002□13.008	13.04
Piston pin O.D.	12.994□13.0	12.96
Piston-to-piston pin clearance	0.002□0.014	0.02
Ring-to-groove (top/second)	0.15□0.55	0.09
Connecting rod small end I.D.	13.016□13.034	13.06
Cylinder bore	39.0□39.01	39.1
Drive belt width	18	17
Drive pulley collar O.D.	19.96□19.974	19.94
Movable drive face ID.	20.011□20.052	20.6
Weight roller O.D.	15.92□16.08	15.4
Clutch outer I.D.	107□107.2	107.5
Driven face spring free length	95	90
Driven face O.D.	33.965□33.985	33.94
Movable driven face I.D.	34.000□34.025	34.06
Connecting rod small end free play	0.05□0.4	0.6
Connecting rod big end radial clearance	0□0.008	0.05
Run out	—	0.10

CARBURETOR	Standard
Setting mark	CVK104□A
Type	CVK 18
Float level	20.5
Main jet	#82 (speed limited: #80)
Slow jet	#35
Pilot screw opening	2±1/2
Idle speed	1800±100rpm
Throttle grip free play	2□6mm

## 2. GENERAL INFORMATION

FRAME		Standard (mm)	Service Limit (mm)
Item		VITALITY 50 4-stroke	
Axle shaft runout		—	0.2
Front wheel rim runout	Radial		
	Axial		
Front shock absorber spring free length		214.7	
Rear wheel rim runout			2.0
Brake drum I.D.	Front/rear	110	111
Brake lining thickness	Front/rear	6.4/4.0	2.0/2.0
Brake disk runout	Front/rear	—	0.30
Rear shock absorber spring free length		209	

ELECTRICAL EQUIPMENT			VITALITY 50 (4-stroke)
Battery	Capacity		12V4AH
	Voltage		13.0□13.2V
	Charging current	Standard	0.5A/5H~10H
		Quick	4A/0.5H
Spark plug	(NGK)		C7HAS
Spark plug gap			0.6□0.7mm
Ignition coil resistance	Primary coil		0.5Ω
	Secondary coil (with plug cap)		8.12KΩ
	Secondary coil (without plug cap)		3KΩ
Pulser coil resistance (20□)			118.1□118.2Ω
Ignition timing			28°±2°BTDC/4000 rpm



## 2. GENERAL INFORMATION

### TORQUE VALUES

#### ENGINE (2-STROKE)

Item	Thread dia. (mm)	Torque (kgf-m)	Remarks
Cylinder head bolt	BF7x115	1.0□1.2	(cold)
Clutch drive plate nut	10	3.5□4.0	
Clutch outer nut	NH10	3.5□4.5	
Drive face nut	NH12	5.0□6.0	
Oil check bolt	10	1.0□1.5	
Engine mounting bolt	BF10x95	4.5□5.5	
Engine hanger bracket bolt	BF10x50	3.5□4.5	
Exhaust muffler joint lock nut	NC6mm	1.0□1.4	
Exhaust muffler lock bolt	BF8x35	3.0□3.6	
Spark plug		1.1□1.7	(cold)

#### ENGINE (4-STROKE)

Item	Q'ty	Thread dia.(mm)	Torque (kgf-m)	Remarks
Stud bolt	4	8	0.7□1.1	
Oil filter screen cap	1	30	1.0□2.0	
L cover	8	6	1.0□1.4	
Cam shaft holder	4	8	1.2□1.6	Apply oil 
Tappet ADJ nut	2	5	0.7□1.1	Apply oil 
Pivot tensioner bolt	1	6	0.8□1.2	
Lifter tensioner bolt	2	6	1.0□1.4	
Cam chain adjust bolt	1	8	0.4□0.7	
Mission case bolt	7	8	2.4□3.0	
Mission fill bolt	1	8	0.8□1.2	
Driver face nut	1	12	5.5□6.5	Apply oil 
Clutch outer nut	1	10	3.5□4.5	
Drive plate nut	1	28	5.0□6.0	
ACG flywheel nut	1	10	3.5□4.5	
Spark plug	1	10	1.0□1.4	
Mission drain plug	1	10	2.0□3.0	
Oil pump screw	1	3	0.1□0.3	
Head CYL stud bolt (IN pipe)	2	6	0.7□1.1	
Head CYL stud bolt (EX pipe)	2	8	0.7□1.1	
A.C.G Startor	3	5	0.8□1.0	
Fan	4	6	0.6□1.0	

## 2. GENERAL INFORMATION

### FRAME

Item	Thread dia. (mm)	Torque (kgf-m)	Remarks
Handlebar lock nut	10	5.0□6.0	Flange bolt/U-nut
Steering stem lock nut	25.4	6.0□8.0	
Steering top cone race	25.4	0.5□1.3	
Front axle nut	12	5.0□7.0	Flange U-nut
Rear axle nut	16	11.0□13.0	Flange U-nut
Rear brake arm bolt	6	1.0□1.4	
Front fork			
upper mount bolt	8	3.0□3.6	
lower mount bolt	8	3.0□3.6	
Front brake caliper bolt	8	2.9□3.5	Apply locking agent
Brake fluid bolt	10	3.0□4.0	
Front pivot arm bolt	5	0.3□0.5	
Rear shock absorber:			
upper mount bolt	10	3.5□4.5	
lower mount bolt	8	2.4□3.0	
Engine hanger bolt	10	4.5□5.5	Flange bolt/U-nut

Torque specifications listed above are for important fasteners. Others should be tightened to standard torque values below.

### STANDARD TORQUE VALUES

SH bolt: 8mm      Flange 6mm

bolt

Item	Torque (kgf-m)	Item	Torque (kg-m)
5mm bolt, nut	0.45□0.6	5mm screw	0.35□0.5
6mm bolt, nut	0.8□1.2	6mm screw, SH bolt	0.7□1.1
8mm bolt, nut	1.8□2.5	6mm flange bolt, nut	1.0□1.4
10mm bolt, nut	3.0□4.0	8mm flange bolt, nut	2.4□3.0
12mm bolt, nut	5.0□6.0	10mm flange bolt, nut	3.5□4.5

## 2. GENERAL INFORMATION

### SPECIAL TOOLS (2-STROKE)

Tool Name	Tool No.	Remarks
Universal bearing puller	E037	
Lock nut socket wrench	F001	
Lock nut wrench,	F007	
Race cone install	F005	
Crankcase puller	E026	
Crankshaft bearing puller	E030	
Oil seal & bearing install	E014	
Clutch spring compressor	E034	
Crankcase assembly collar	E023	
Crankcase assembly tool	E024	
Universal holder	E017	
Flywheel puller	E001	

### SPECIAL TOOLS (4-STROKE)

Tool Name	Tool No.	Remarks
Universal bearing puller	E037	
Lock nut socket wrench	F001	
Lock nut wrench,	F007	
Race cone install	F005	
Oil seal & bearing install	E014	
Clutch spring compressor	E034	
Universal holder	E017	
Flywheel puller	E001	
Valve adjuster	E036	

## 2. GENERAL INFORMATION

### LUBRICATION POINTS

#### ENGINE (2-STROKE)

NO.	Lubrication Points	Lubricant
1	Crankcase sliding & movable	KYMCO 2-STROKE OIL or QUIVALENT
2	Cylinder movable parts	KYMCO 2-STROKE OIL or QUIVALENT
3	Transmission gear (final gear)	SAE-90#
4	Kick starter spindle bushing	Grease
5	Drive pulley movable parts	Grease
6	Starter pinion movable parts	Grease

### LUBRICATION POINTS

#### ENGINE (4-STROKE)

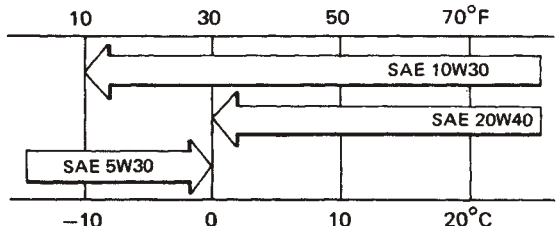
Lubrication Points	Lubricant
Valve guide/valve stem movable part Cam lobes Valve rocker arm friction surface Cam chain Cylinder lock bolt and nut Piston surroundings and piston ring grooves Piston pin surroundings Cylinder inside wall Connecting rod/piston pin hole Connecting rod big end Crankshaft right side oil seal Crankshaft one-way clutch movable part Oil pump drive chain Balance gear A.C. generator Starter one-way clutch Bearing movable part O-ring face Oil seal lip	<ul style="list-style-type: none"> <li>•Genuine KYMCO Engine Oil (SAE15W-40)</li> <li>•API SG Engine Oil</li> </ul> 
Transmission gear and movable parts	Gear oil: SAE90#



## 2. GENERAL INFORMATION

### FRAME

Apply clean engine oil or grease to cables and movable parts not specified. This will avoid abnormal noise and rise the durability of the motorcycle.

- (1) Front/Rear Brake Lever
- (2) Throttle Cable
- (3) Seat Lock
- (4) Rear Wheel Splines
- (5) Brake Cam/Anchor Pin
- (6) Rear Brake Cable
- (7) Main Stand Pivot
- (8) Side Stand Pivot
- (9) Speedometer Gear /Lower Mount Bushings/Pivot

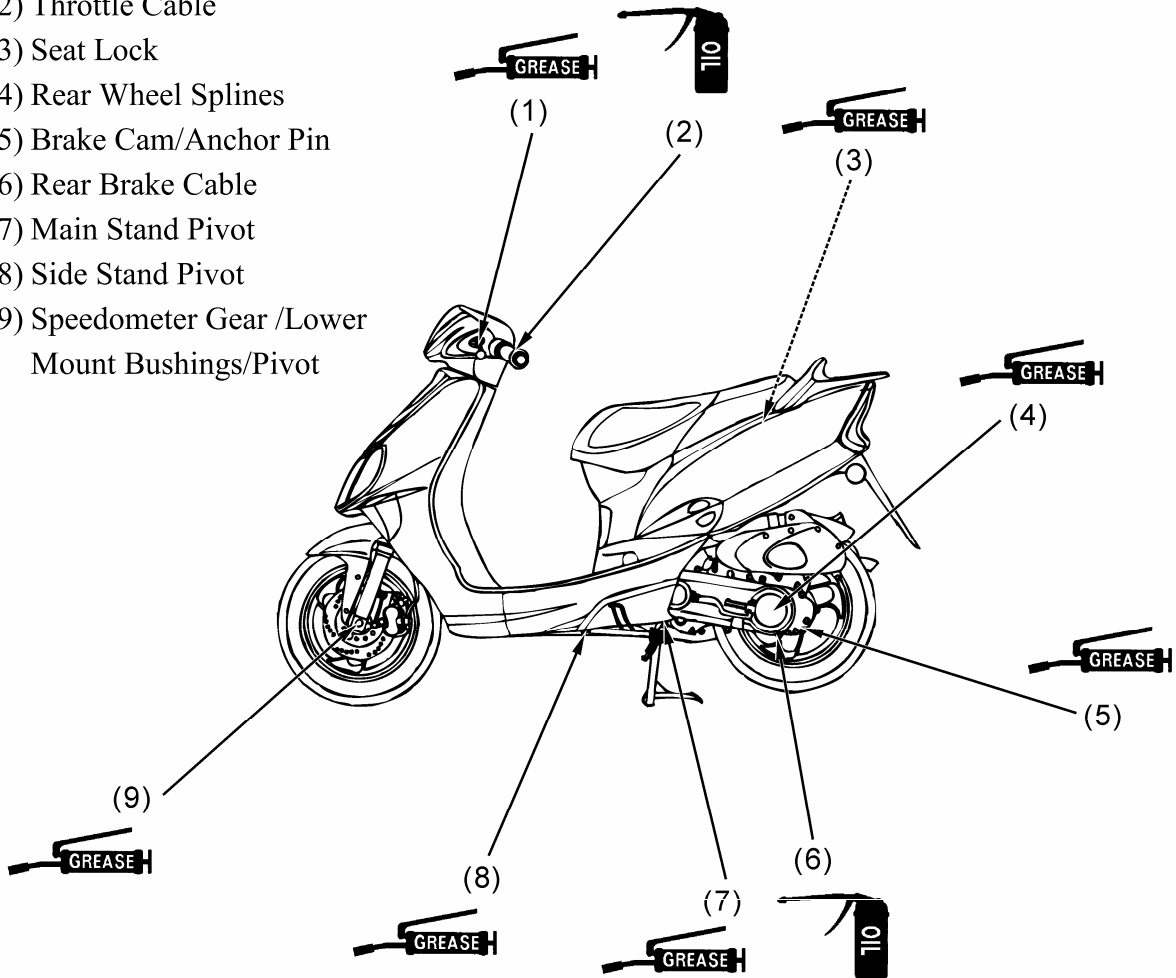

# 2. GENERAL INFORMATION

## WIRING DIAGRAM (2-STROKE)

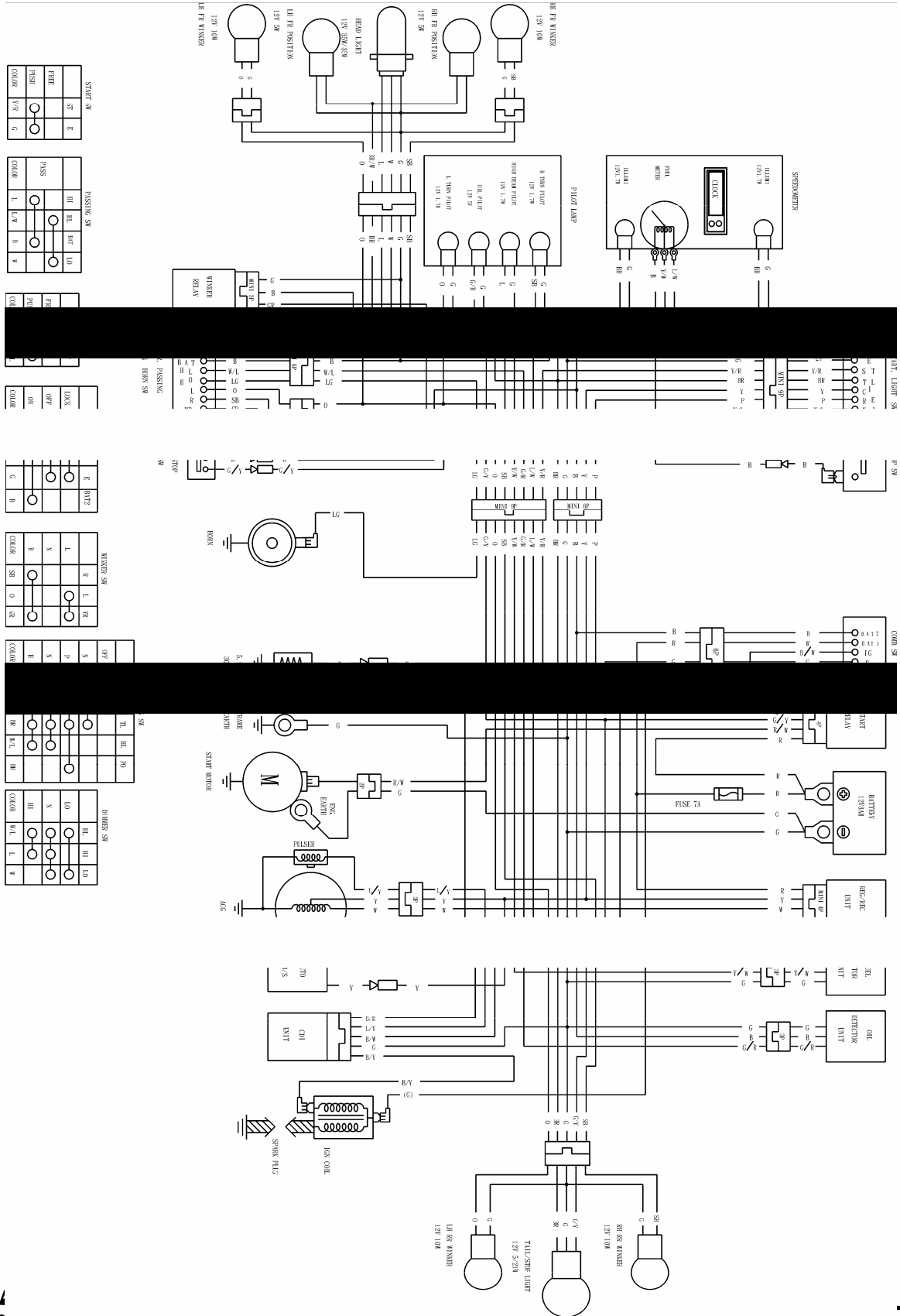

## 2. GENERAL INFORMATION

### WIRING DIAGRAM (4-STROKE)

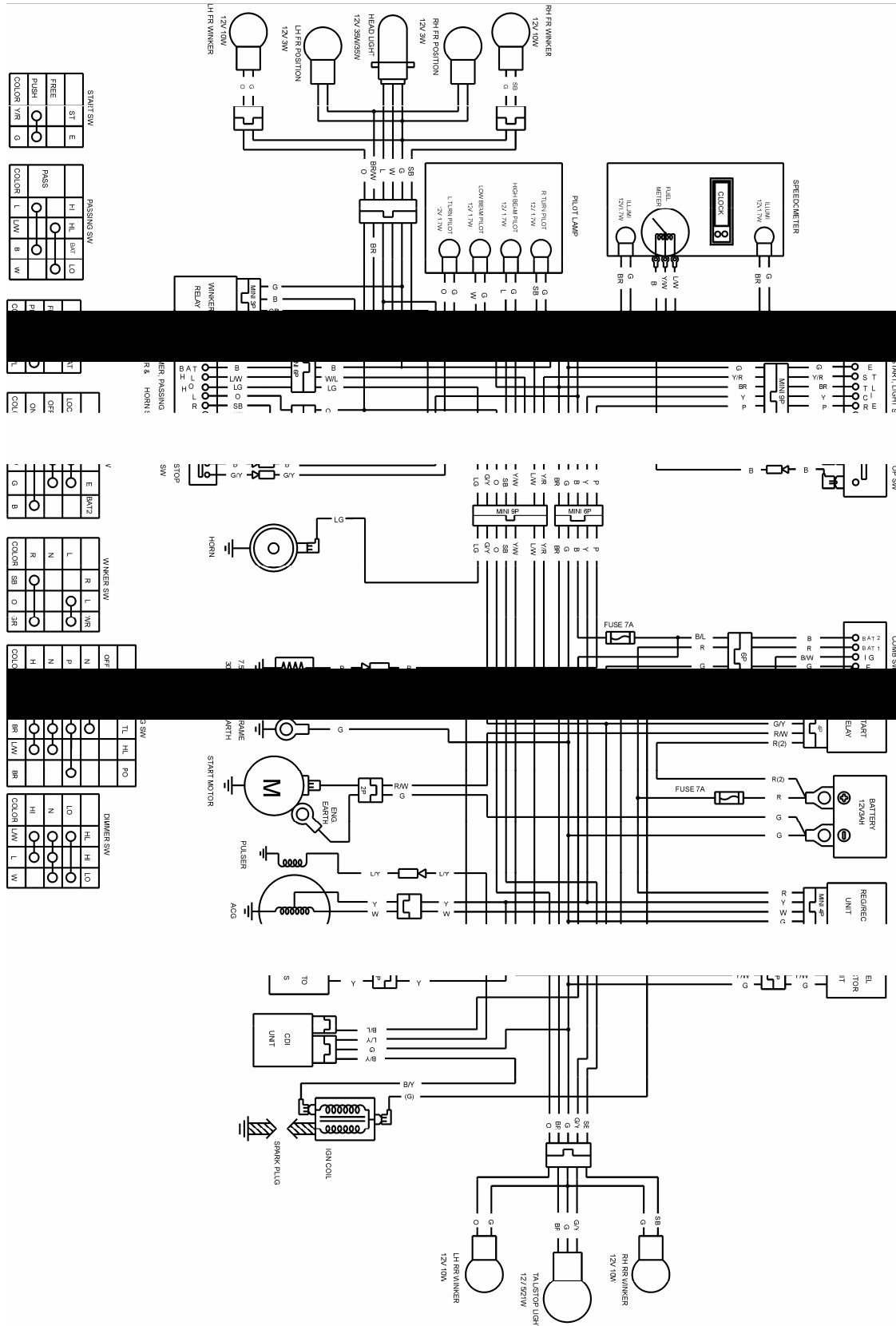

## 2. GENERAL INFORMATION

### CABLE & HARNESS ROUTING (2-STROKE)

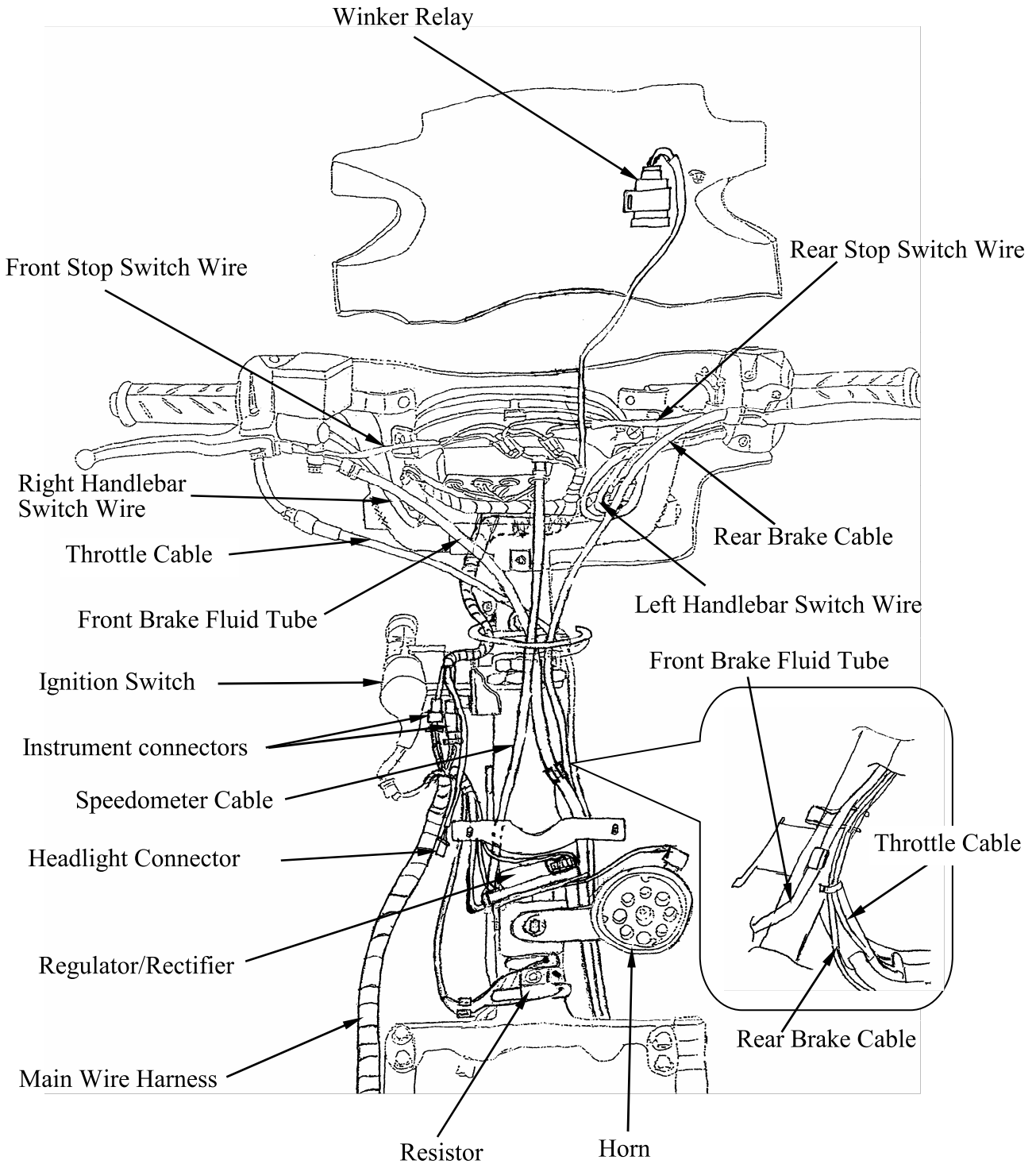

## 2. GENERAL INFORMATION

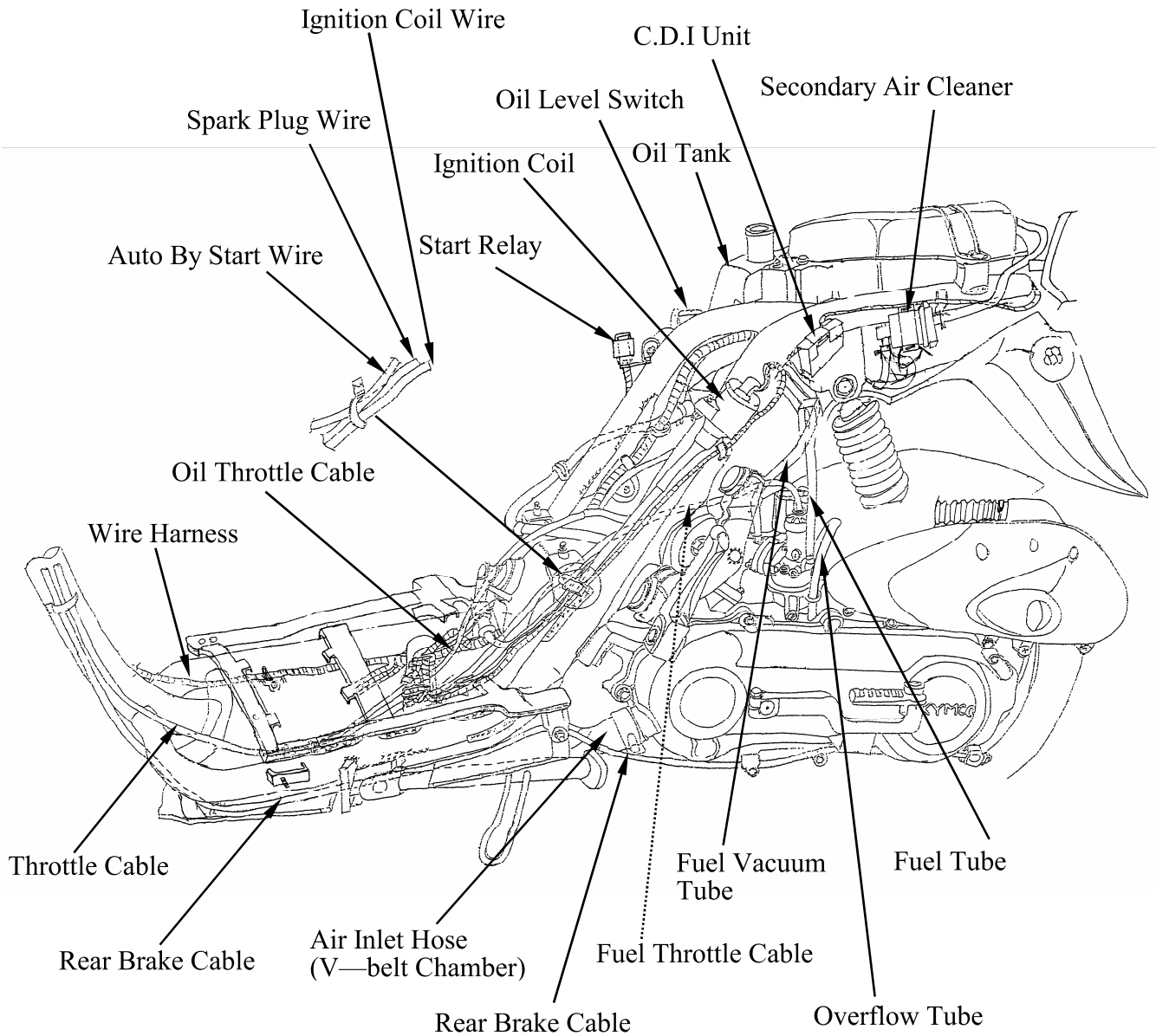

## 2. GENERAL INFORMATION

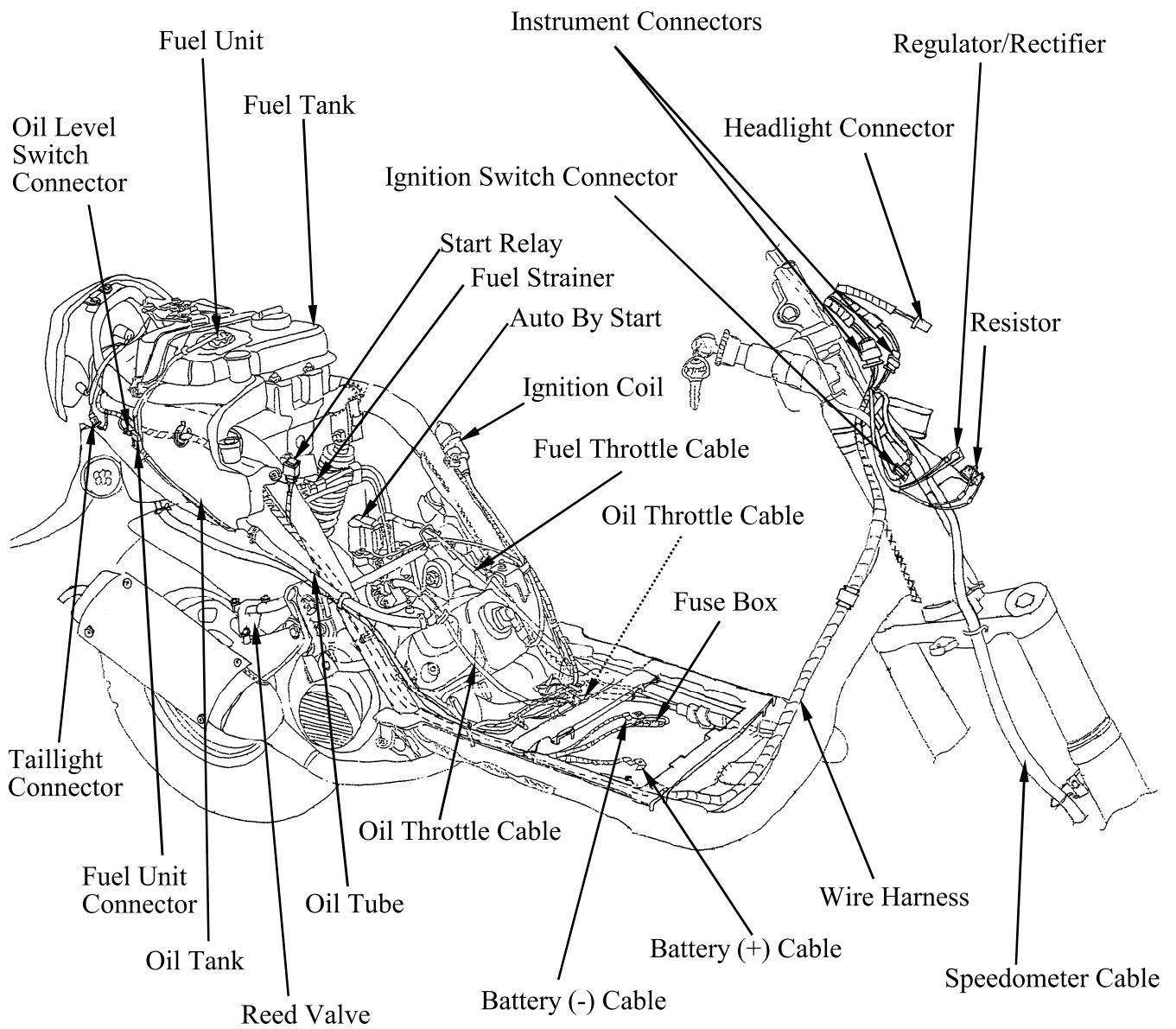

## 2. GENERAL INFORMATION

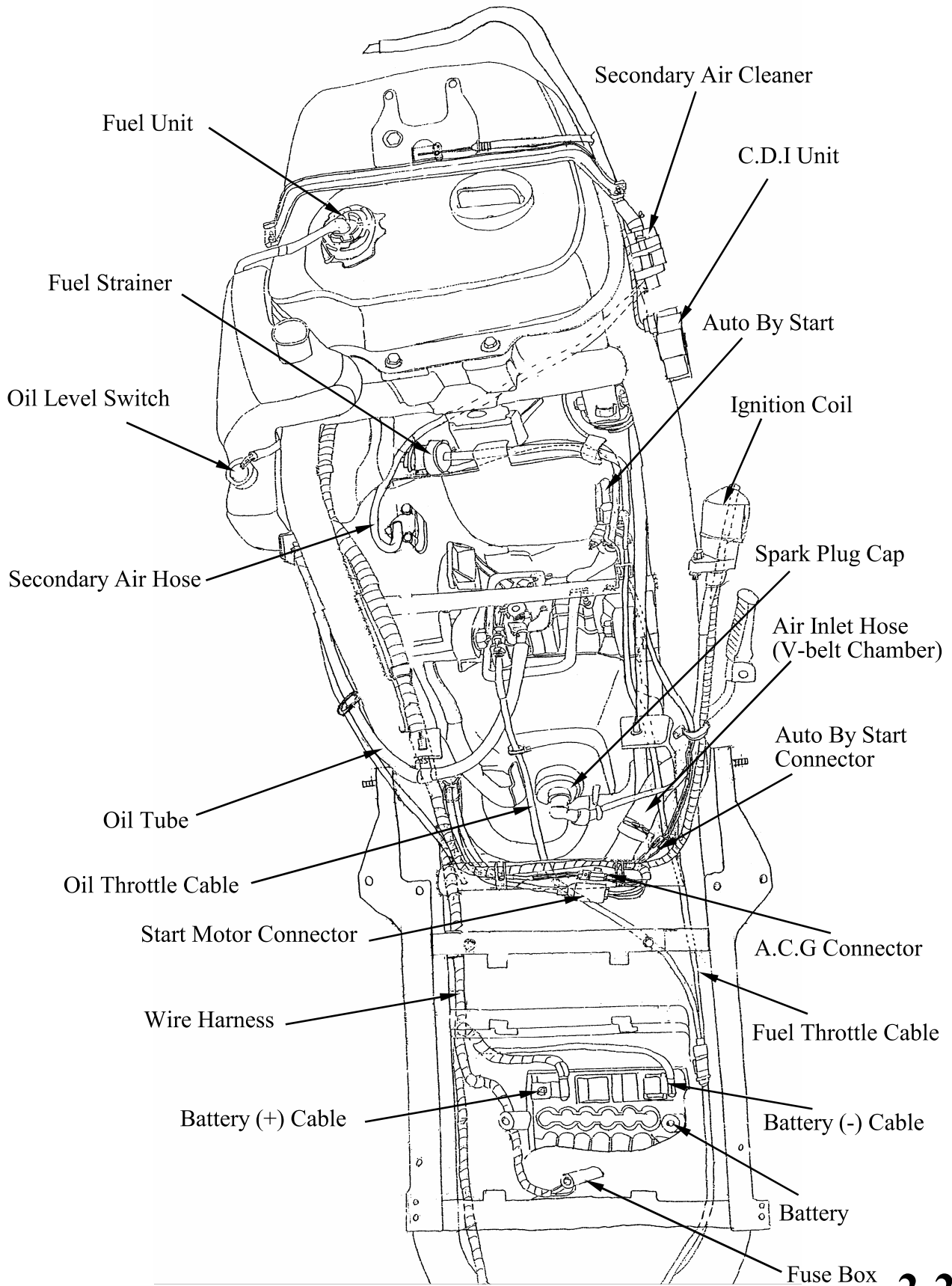

## 2. GENERAL INFORMATION

### CABLE & HARNESS ROUTING (4-STROKE)

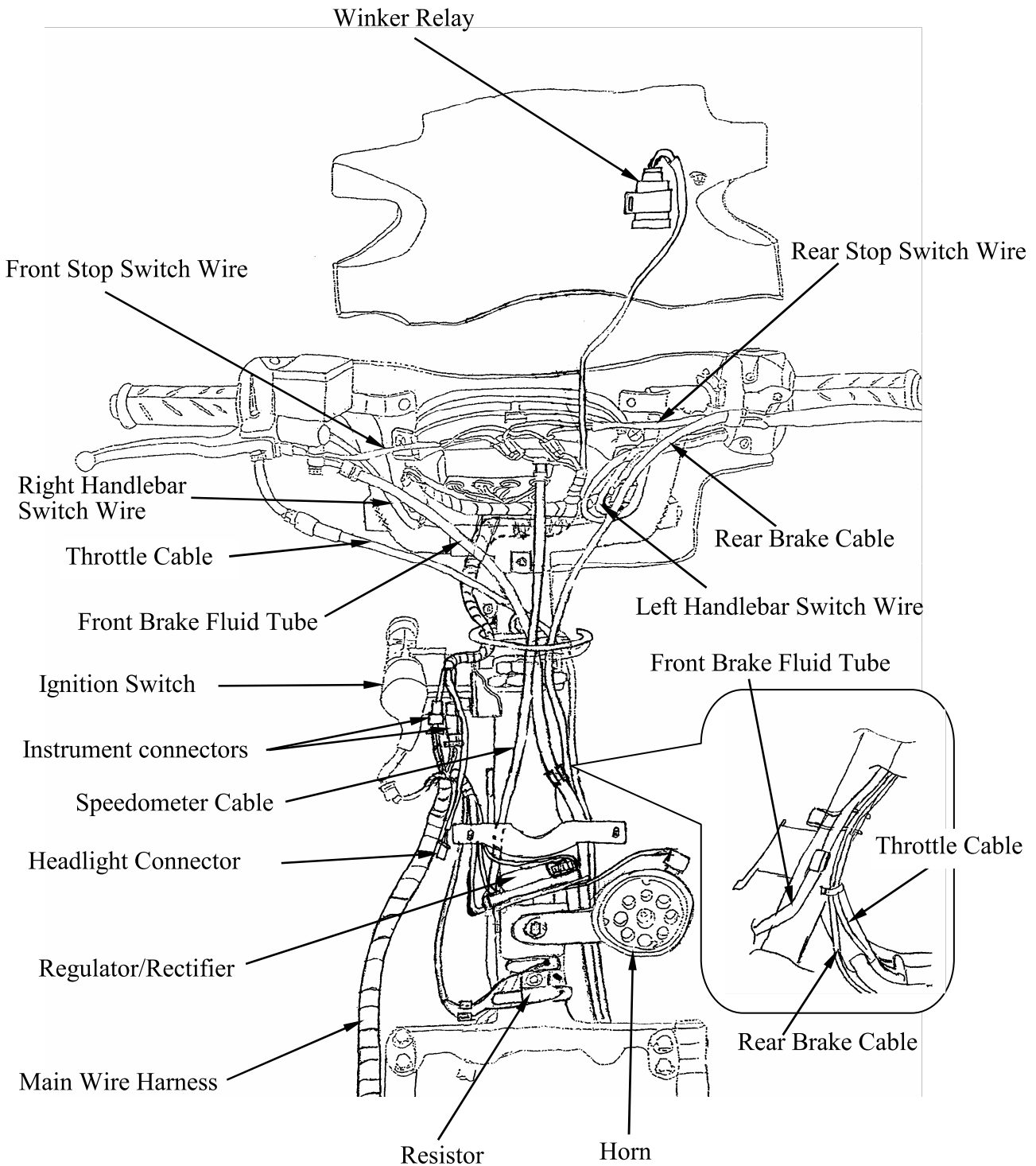



## 2. GENERAL INFORMATION

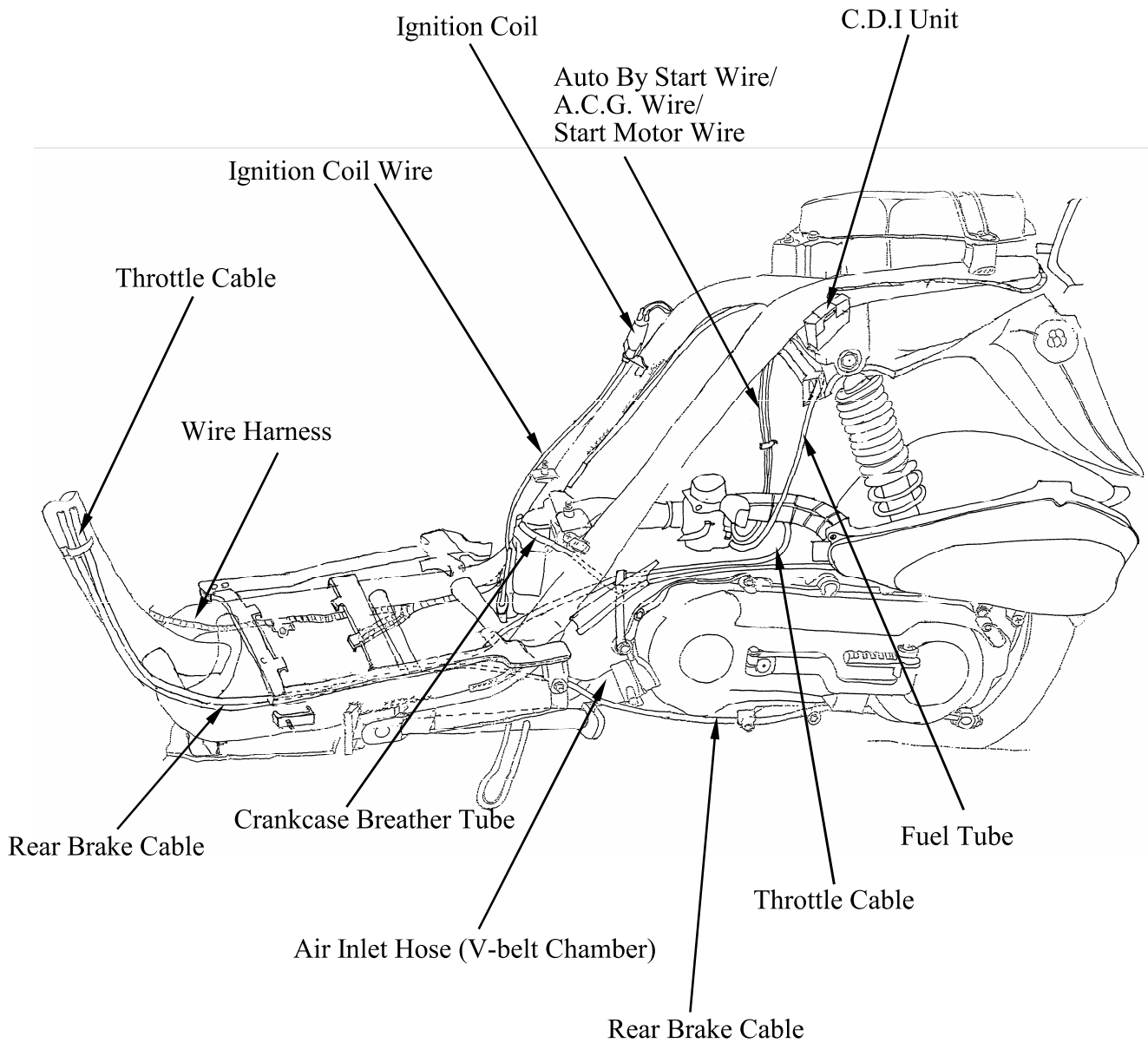

## 2. GENERAL INFORMATION

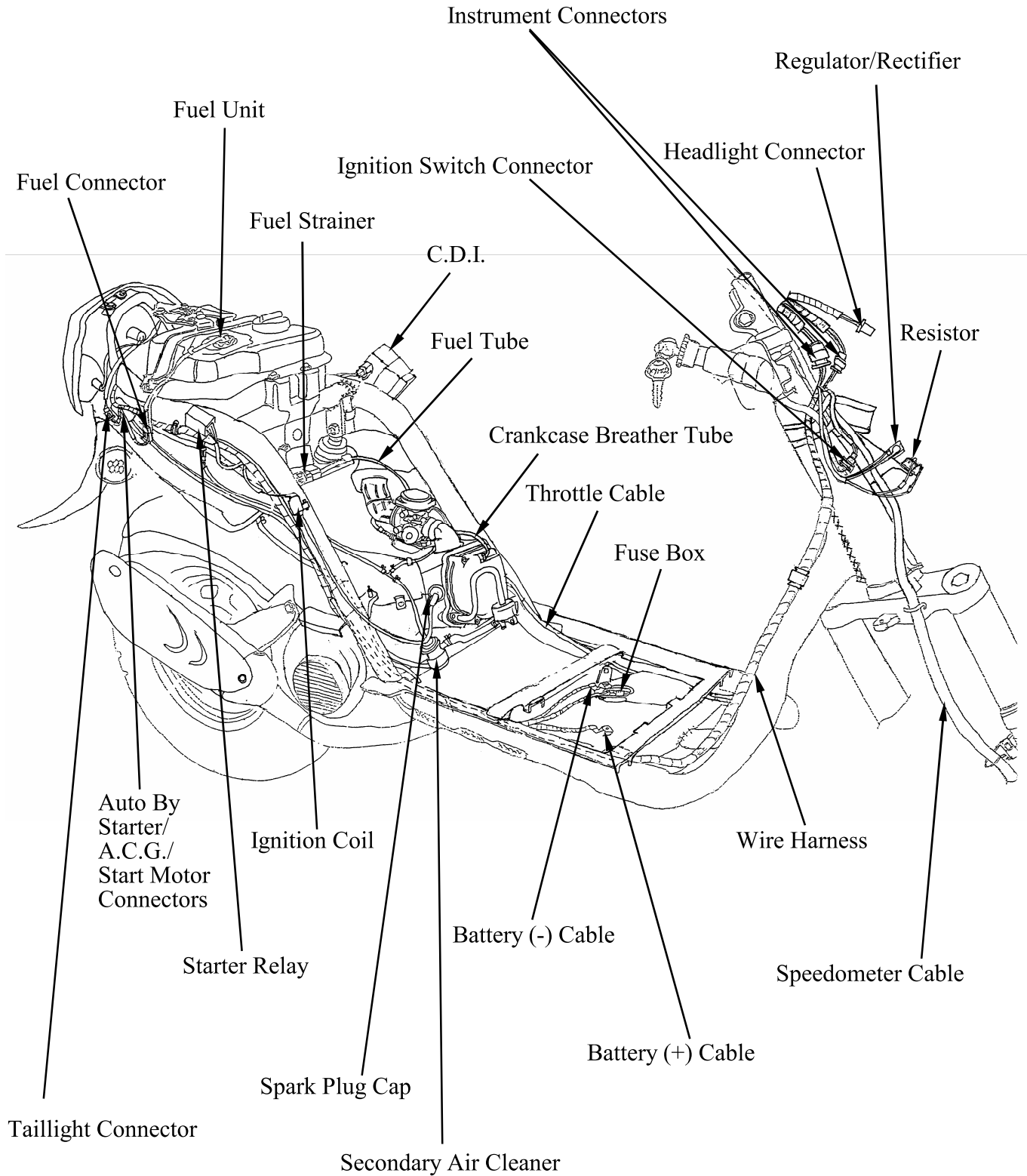

## 2. GENERAL INFORMATION

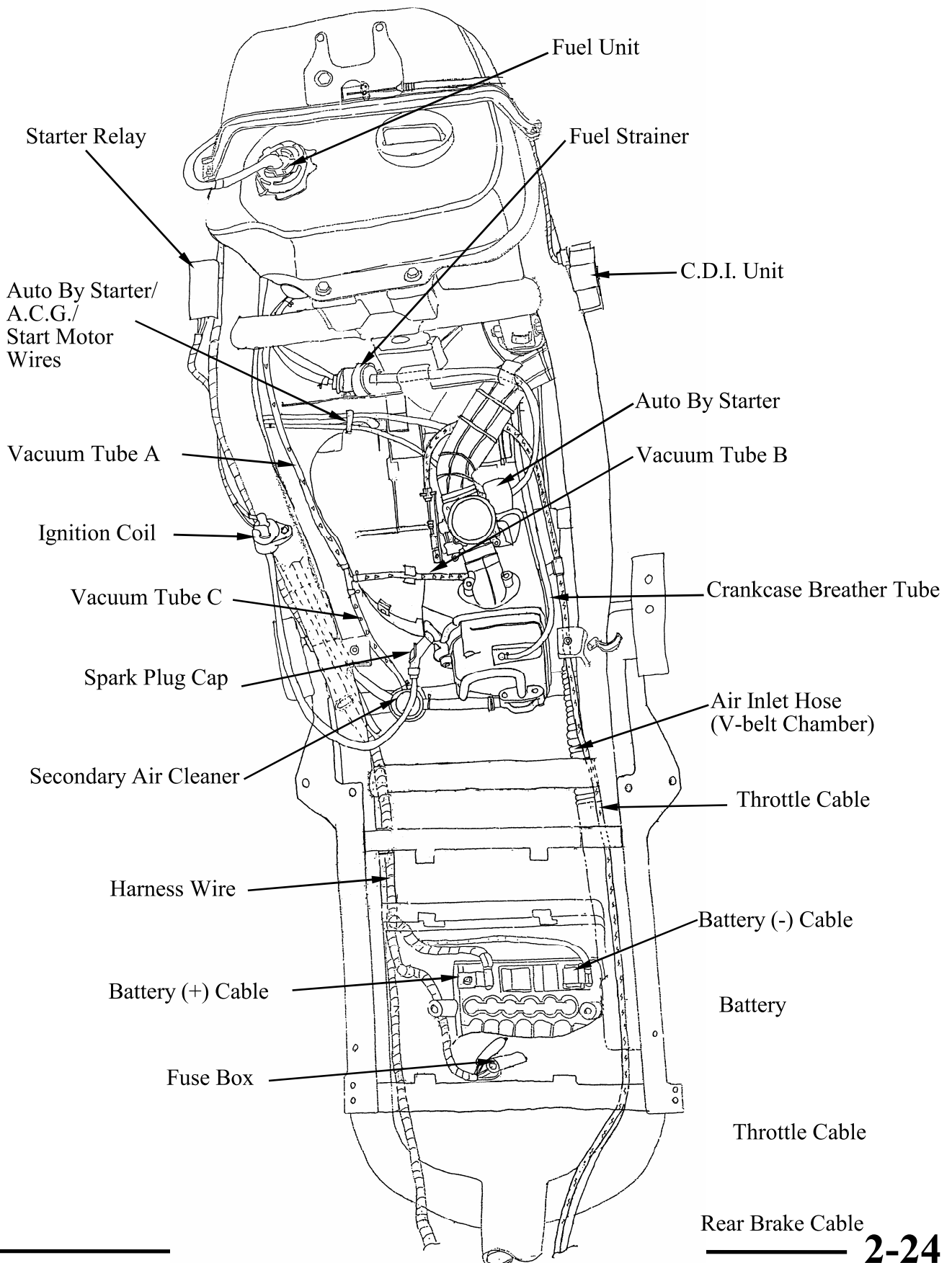

## 2. GENERAL INFORMATION

### TROUBLESHOOTING (2-STROKE)

#### ENGINE WILL NOT START OR IS HARD TO START

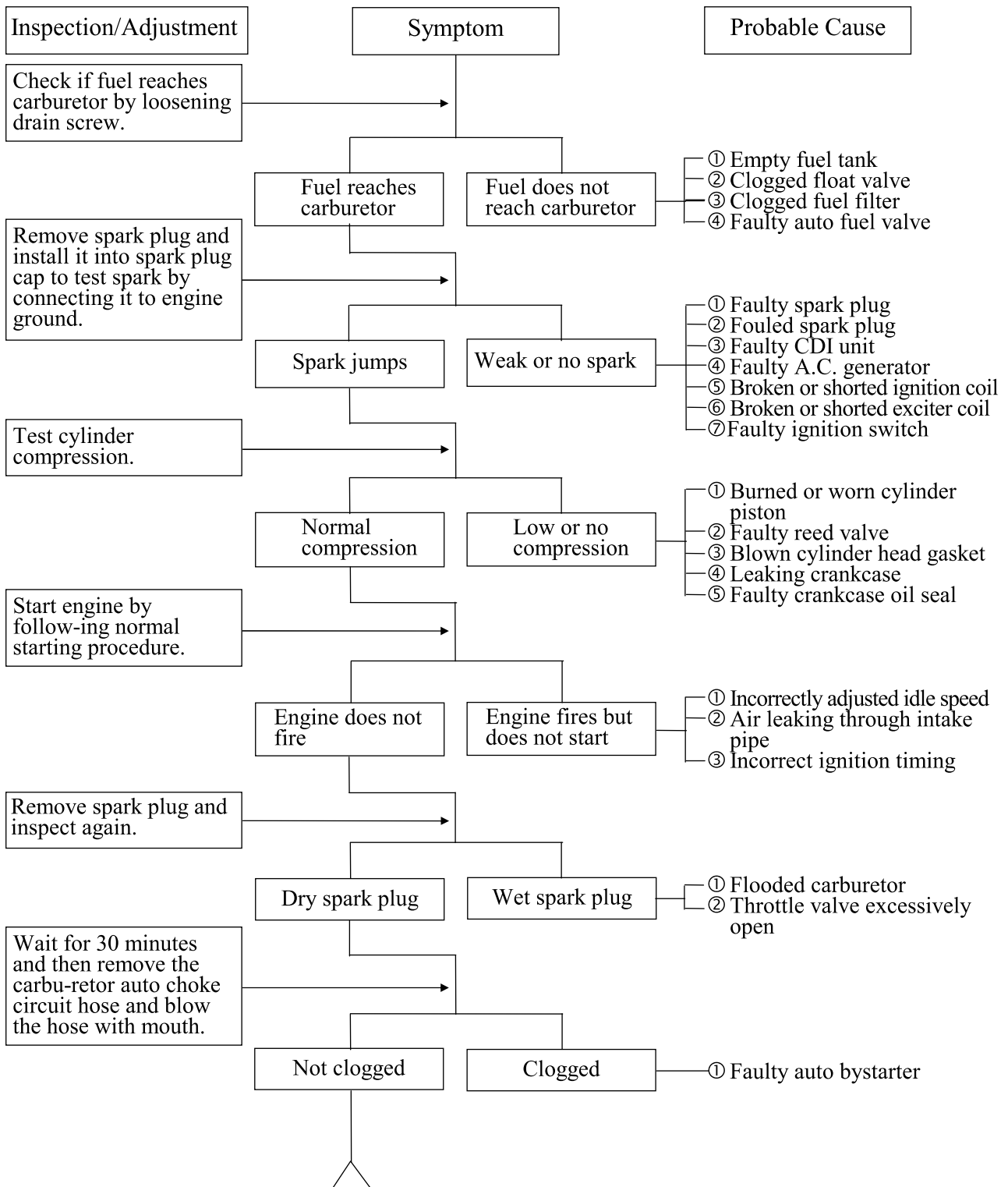

## 2. GENERAL INFORMATION

### ENGINE STOPS IMMEDIATELY AFTER IT STARTS

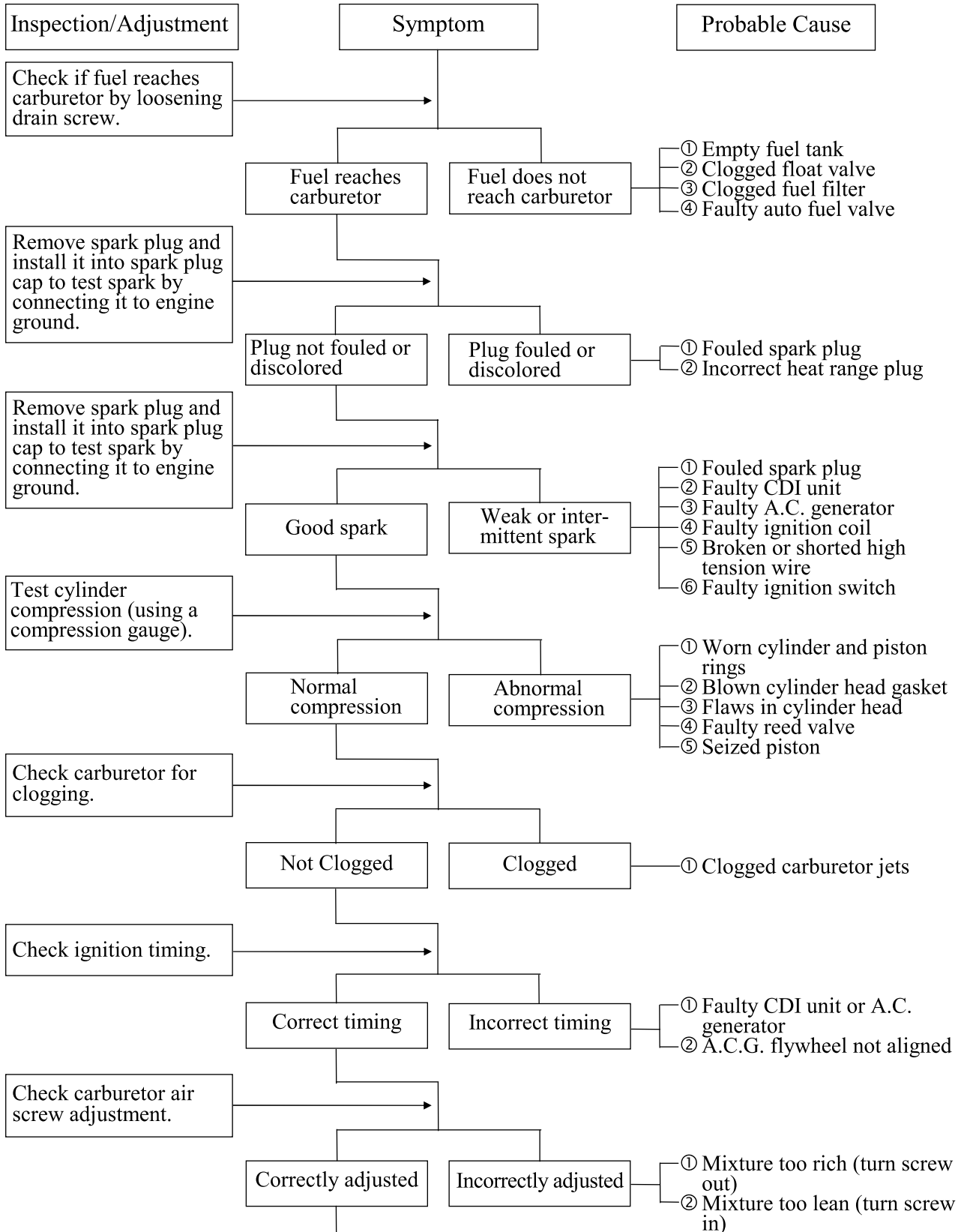

## 2. GENERAL INFORMATION

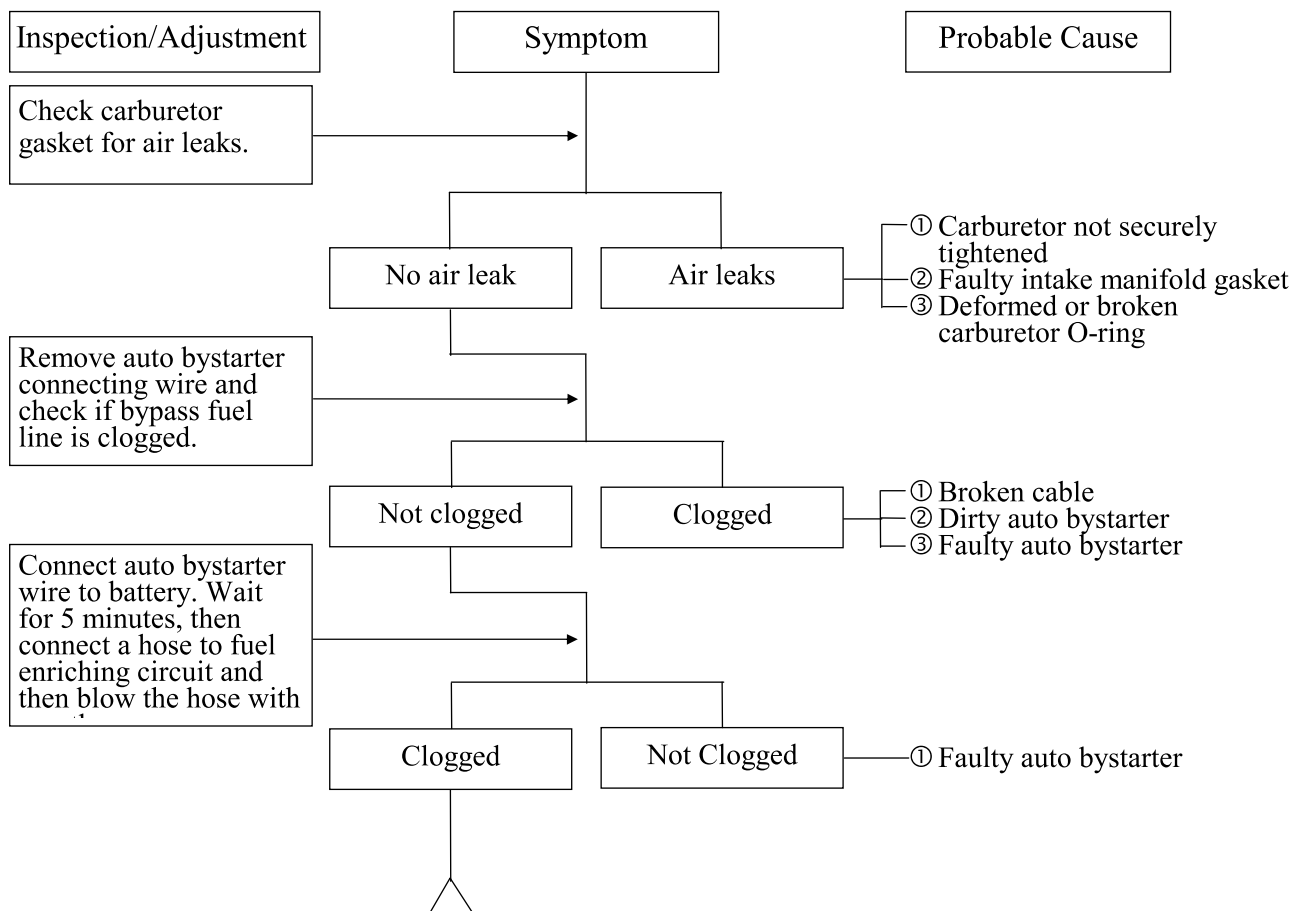

## 2. GENERAL INFORMATION

### ENGINE LACKS POWER

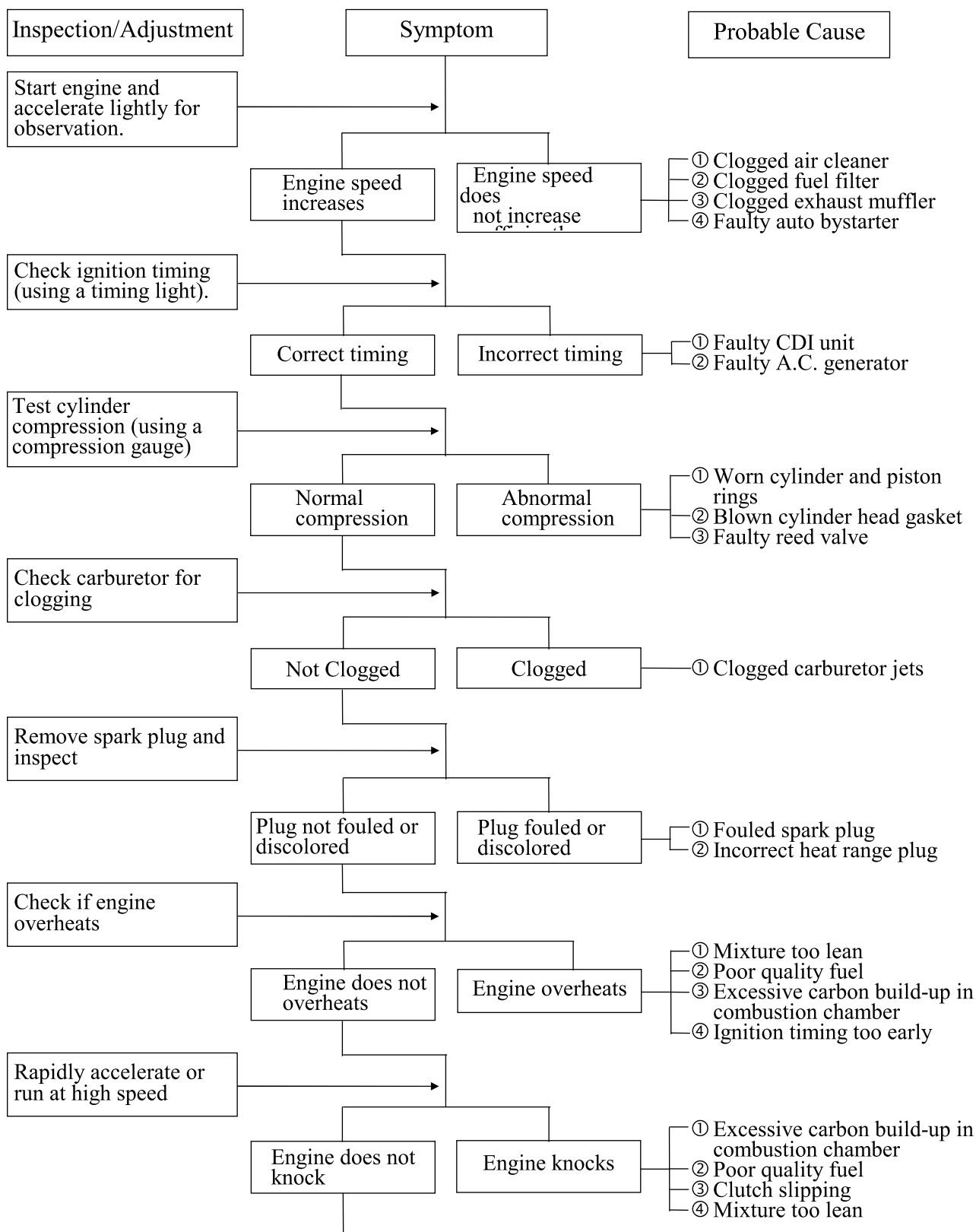

## 2. GENERAL INFORMATION



### POOR PERFORMANCE (ESPECIALLY AT IDLE AND LOW SPEEDS)

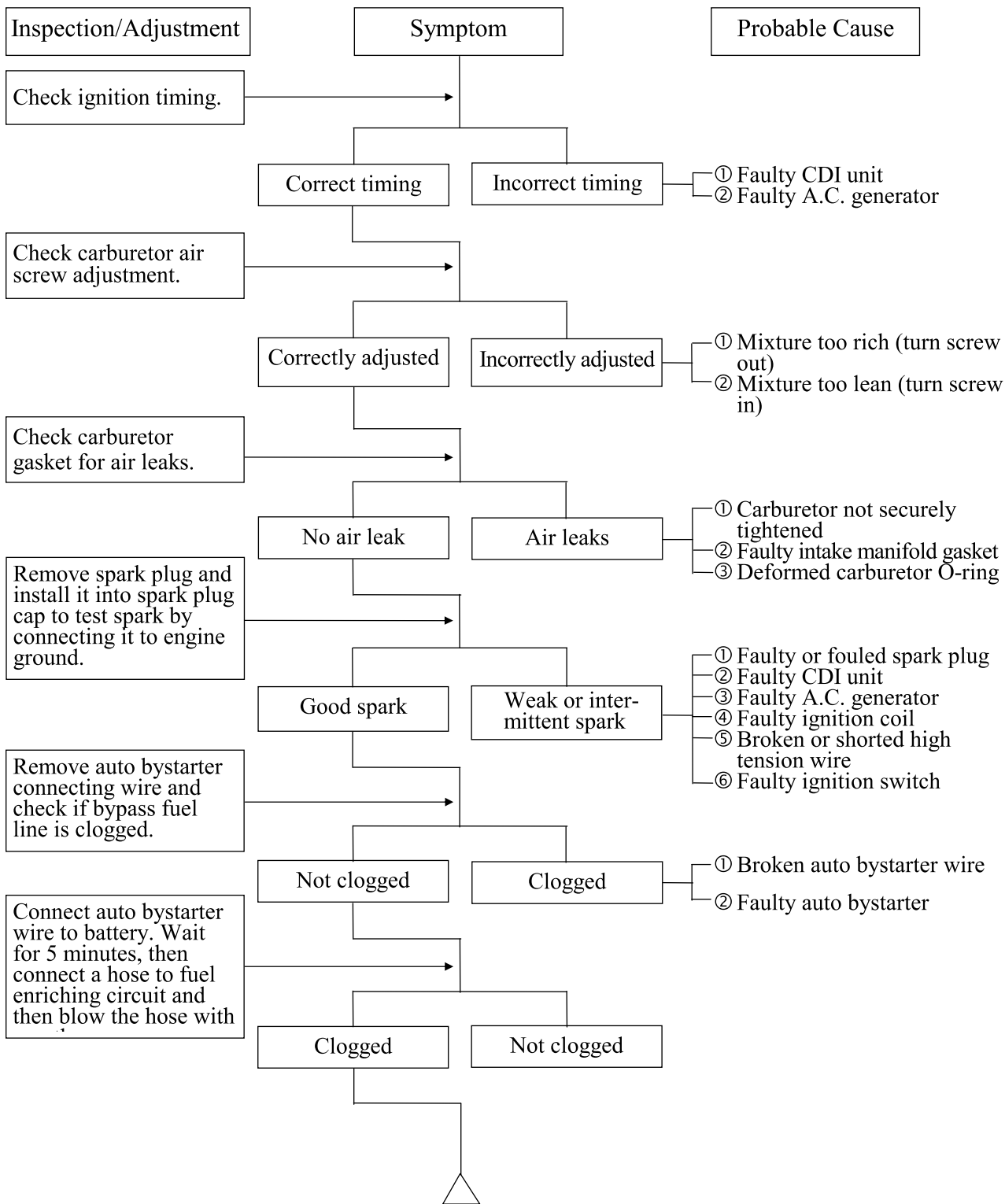



## 2. GENERAL INFORMATION

### POOR PERFORMANCE (AT HIGH SPEED)

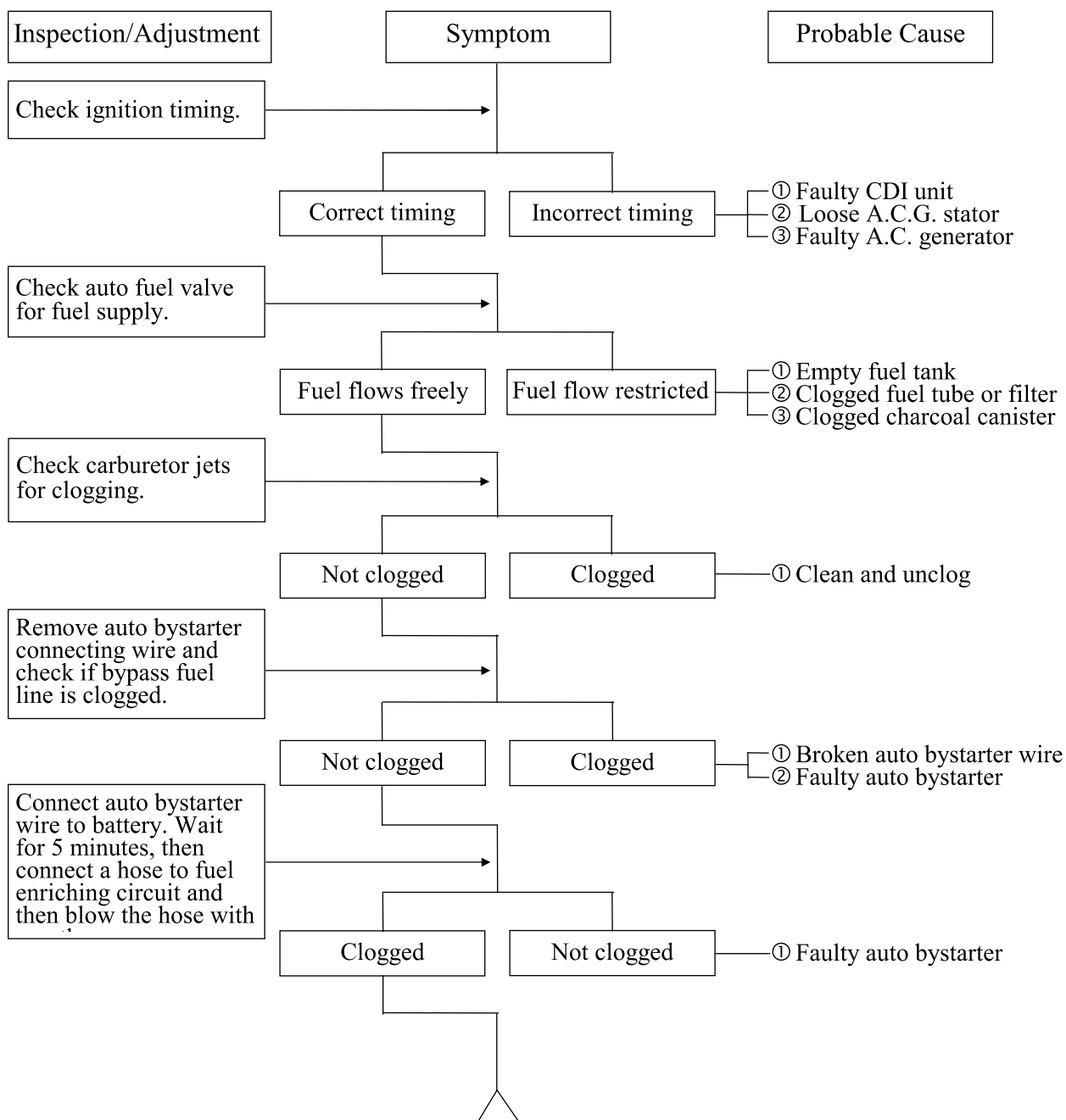

## 2. GENERAL INFORMATION

### CLUTCH, DRIVE AND DRIVEN PULLEYS

Symptom	Probable Cause
Engine starts but motor-cycle does not	<ul style="list-style-type: none"> <li>① Worn or slipping drive belt</li> <li>② Broken ramp plate</li> <li>③ Broken driven face spring</li> <li>④ Separated clutch lining</li> <li>⑤ Damaged driven pulley shaft splines</li> <li>⑥ Damaged final gear</li> <li>⑦ Seized final gear</li> </ul>
Motorcycle creeps or engine starts but soon stops or seems to rush out (Rear wheel rotates when engine idles)	<ul style="list-style-type: none"> <li>① Broken shoe spring</li> <li>② Clutch outer and clutch weight stuck</li> <li>③ Seized pivot</li> </ul>
Engine lacks power at start of a grade (poor slope performance)	<ul style="list-style-type: none"> <li>① Worn or slipping drive belt</li> <li>② Worn weight rollers</li> <li>③ Seized drive pulley bearings</li> <li>④ Weak driven face spring</li> <li>⑤ Worn or seized driven pulley bearings</li> </ul>
Engine lacks power at high speed	<ul style="list-style-type: none"> <li>① Worn or slipping drive belt</li> <li>② Worn weight rollers</li> <li>③ Worn or seized driven pulley bearings</li> </ul>
There is abnormal noise or smell while running	<ul style="list-style-type: none"> <li>① Oil or grease fouled drive belt</li> <li>② Worn drive belt</li> <li>③ Weak driven face spring</li> <li>④ Worn or seized driven pulley bearings</li> </ul>

### STEERING HANDLEBAR DOES NOT TRACK STRAIGHT

Symptom	Probable Cause
	(Front and rear tire pressures are normal)
Steering is heavy	<ul style="list-style-type: none"> <li>① Steering stem nut too tight</li> <li>② Broken steering steel balls</li> </ul>
Front or rear wheel is wobbling	<ul style="list-style-type: none"> <li>① Excessive wheel bearing play</li> <li>② Bent rim</li> <li>③ Loose axle nut</li> </ul>
Steering handlebar pulls to one side	<ul style="list-style-type: none"> <li>① Misaligned front and rear wheels</li> </ul>

## 2. GENERAL INFORMATION

—② Bent front fork



### POOR SUSPENSION PERFORMANCE

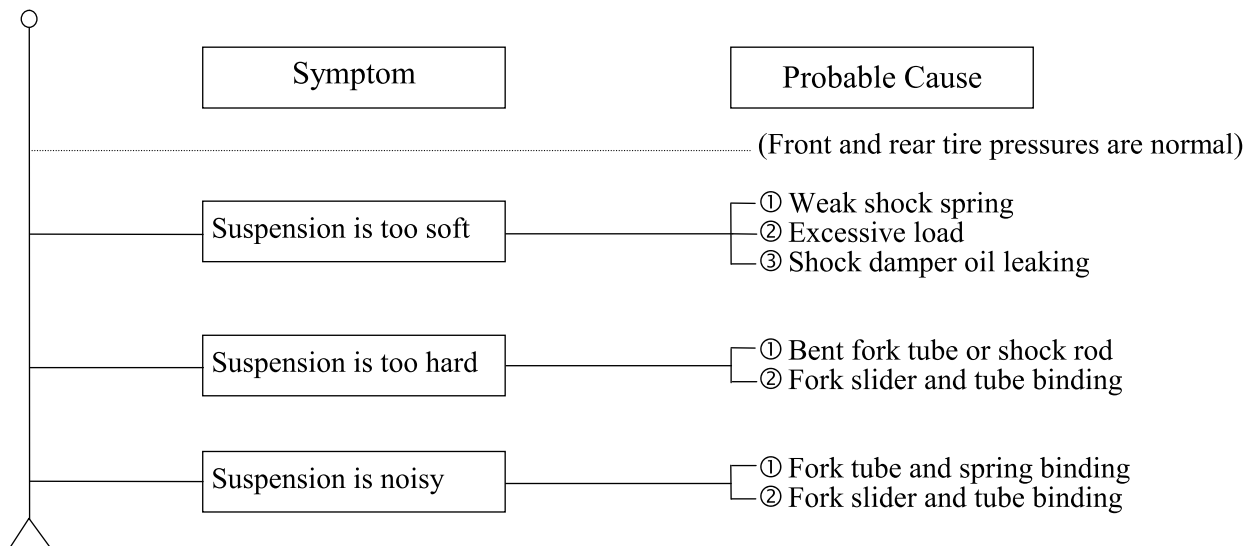

### POOR BRAKE PERFORMANCE

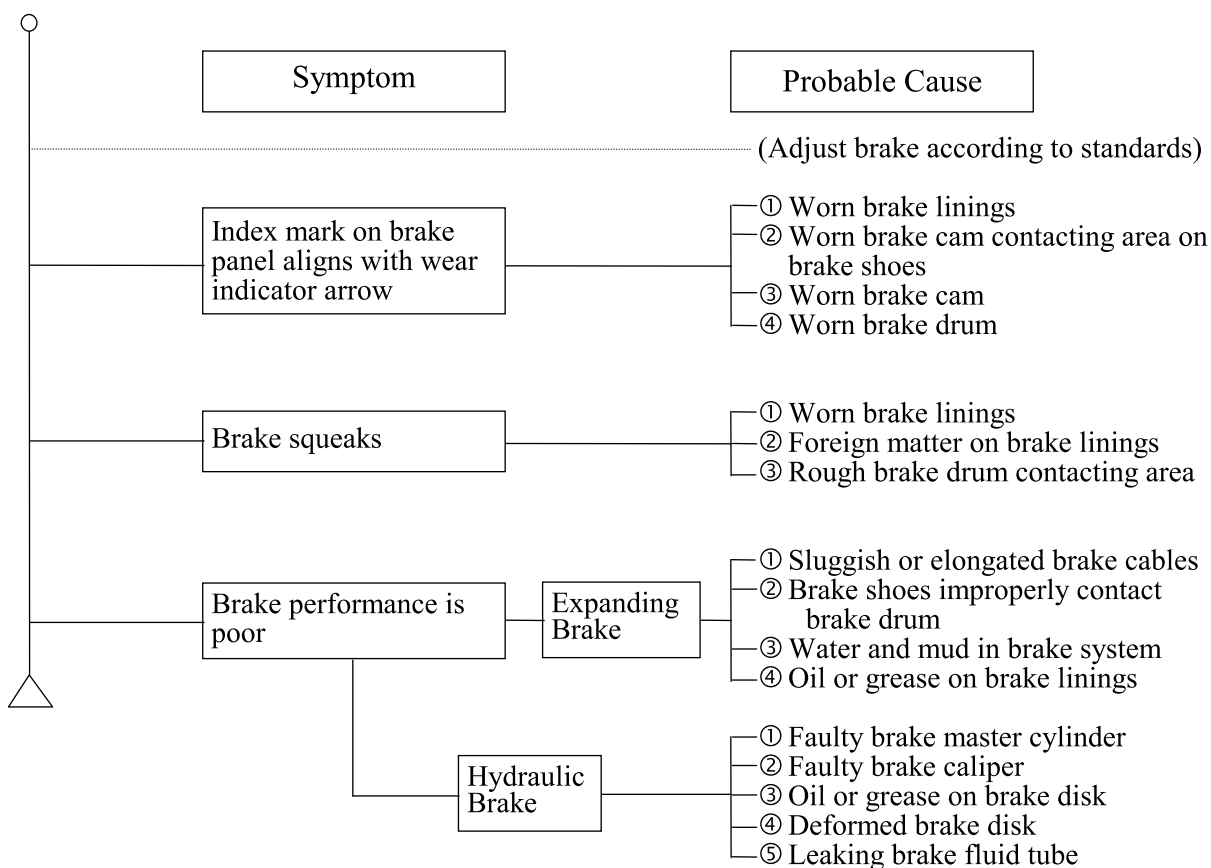

## 2. GENERAL INFORMATION

### OIL METER

1. Motor oil indicator light does not come on when there is no motor oil (Ignition switch ON)

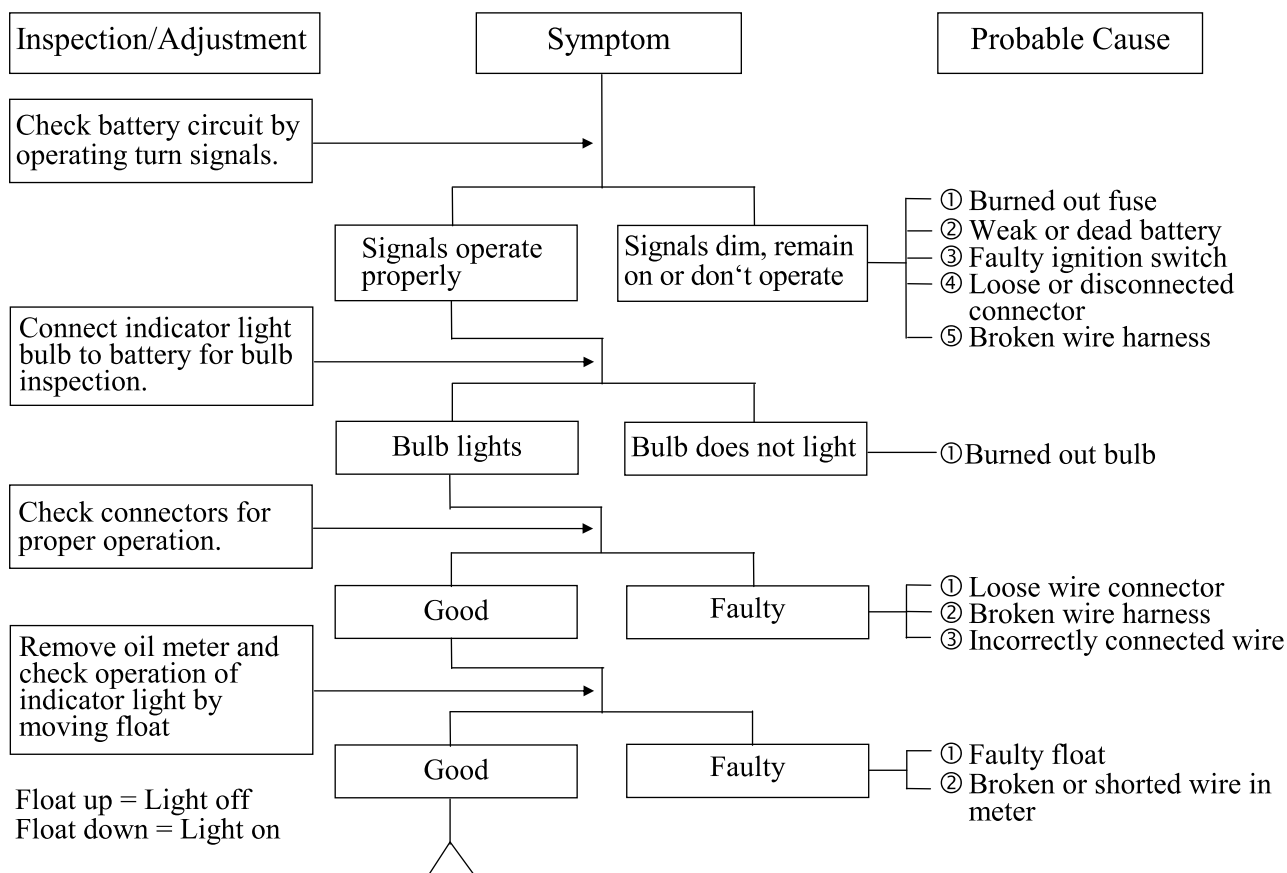

2. Motor oil is sufficient but the indicator light remains on (Ignition switch ON)

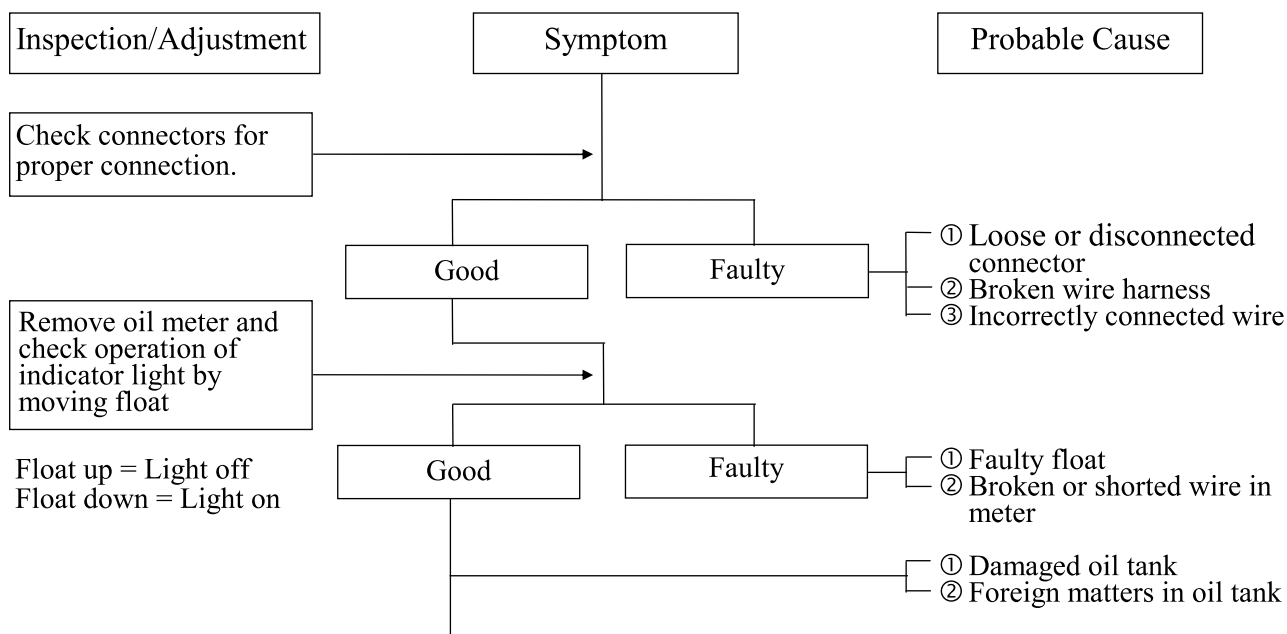

## 2. GENERAL INFORMATION



### FUEL GAUGE

#### 1. Pointer does not register correctly (Ignition switch ON)

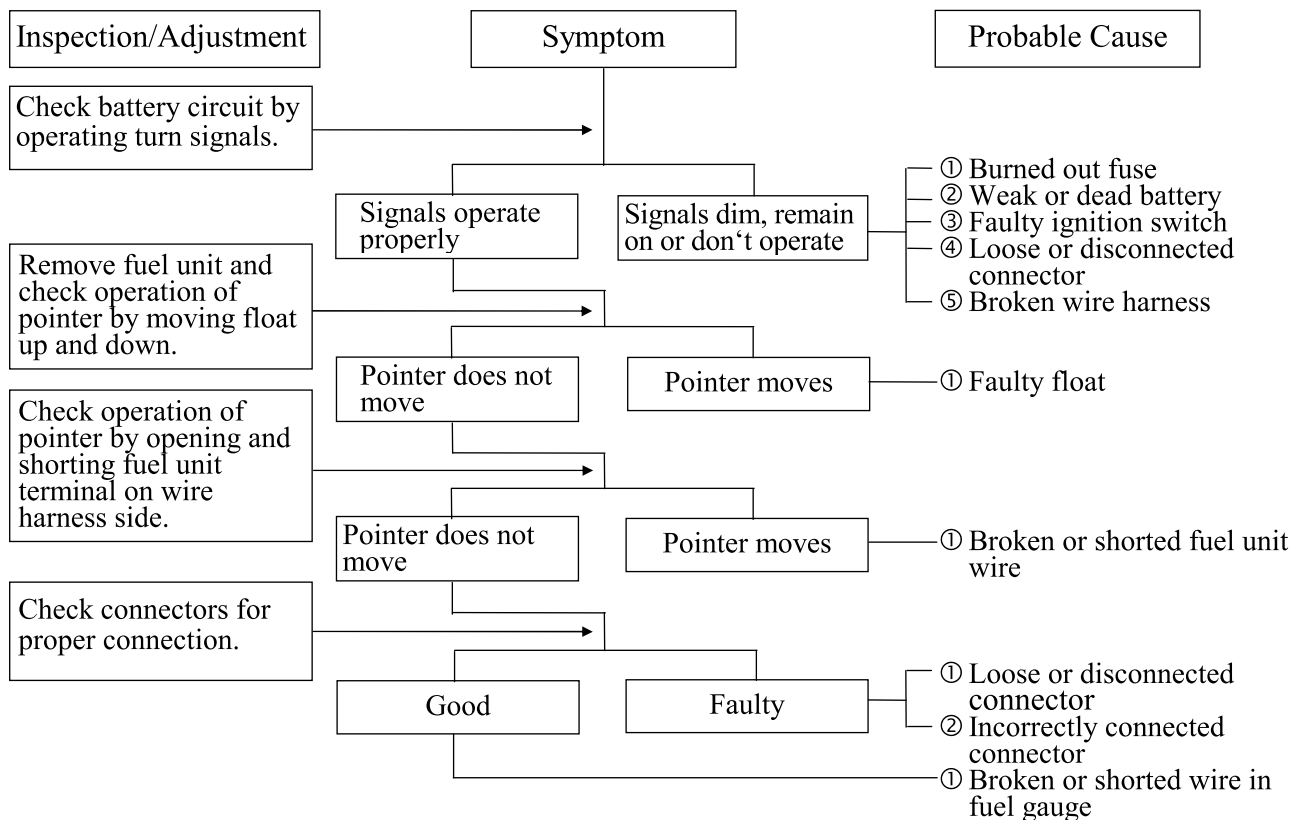

#### 2. Pointer fluctuates or swings (Ignition switch ON)

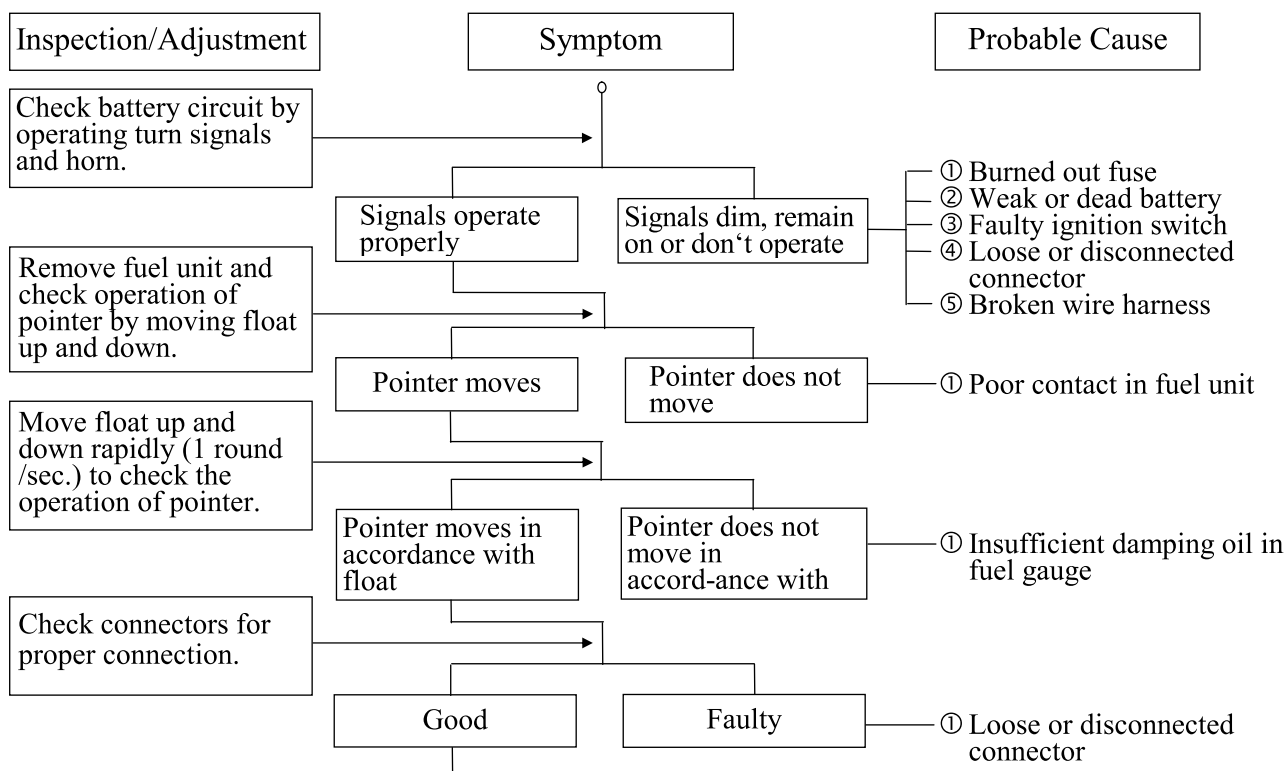

## 2. GENERAL INFORMATION

① Broken or shorted wire in fuel gauge

### STARTER MOTOR

#### 1. Starter motor won't turn

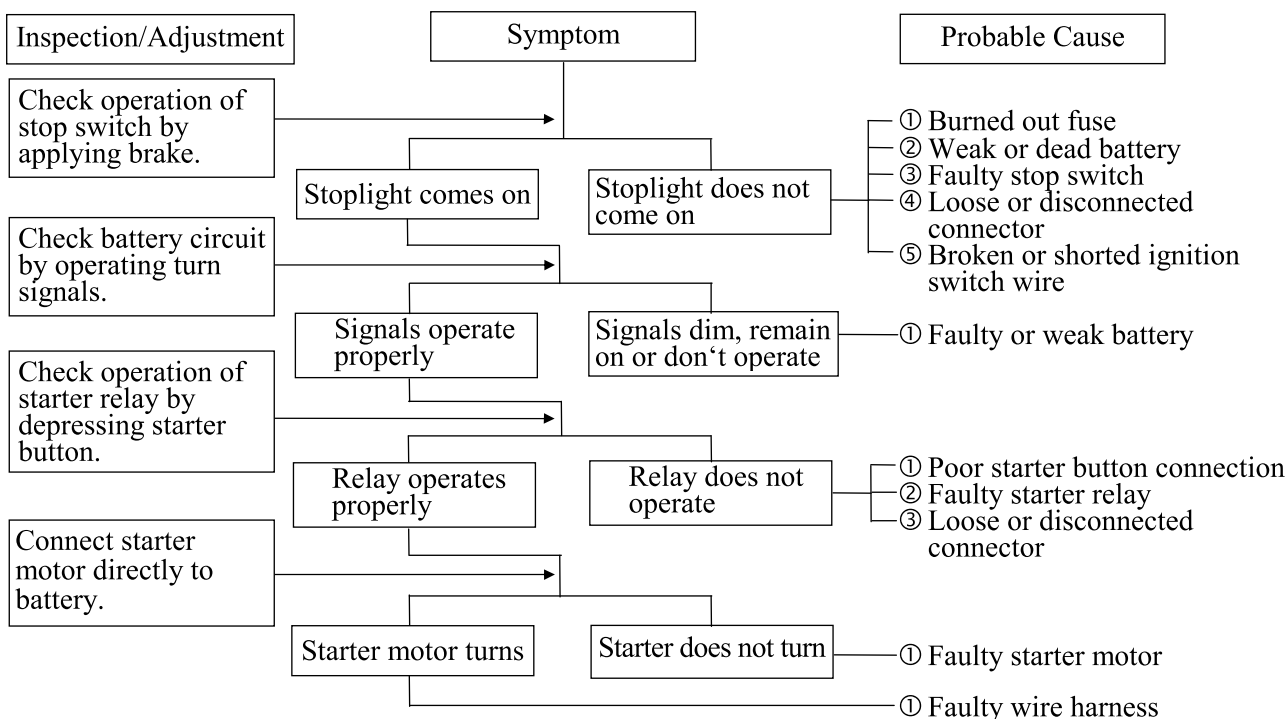

#### 2. Starter motor turns slowly or idles

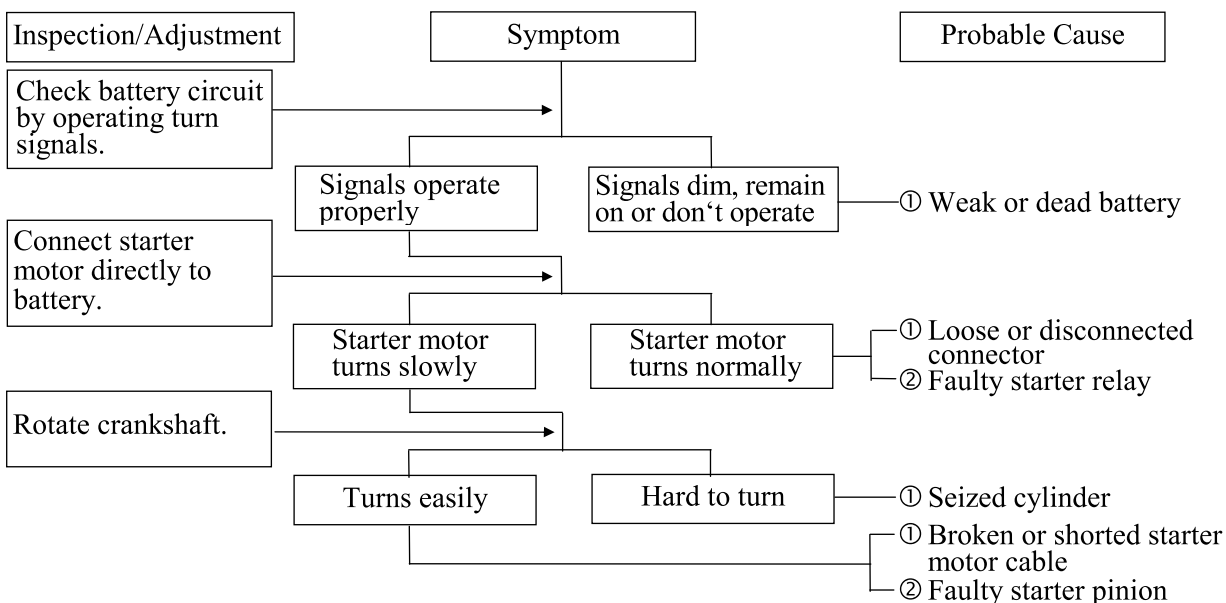

#### 3. Starter motor does not stop turning

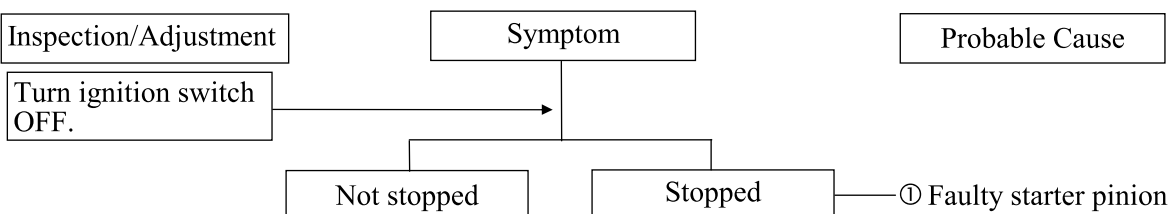

## 2. GENERAL INFORMATION

① Starter relay shorted or stuck closed

### TROUBLESHOOTING (4-STROKE)

#### ENGINE WILL NOT START OR IS HARD TO START

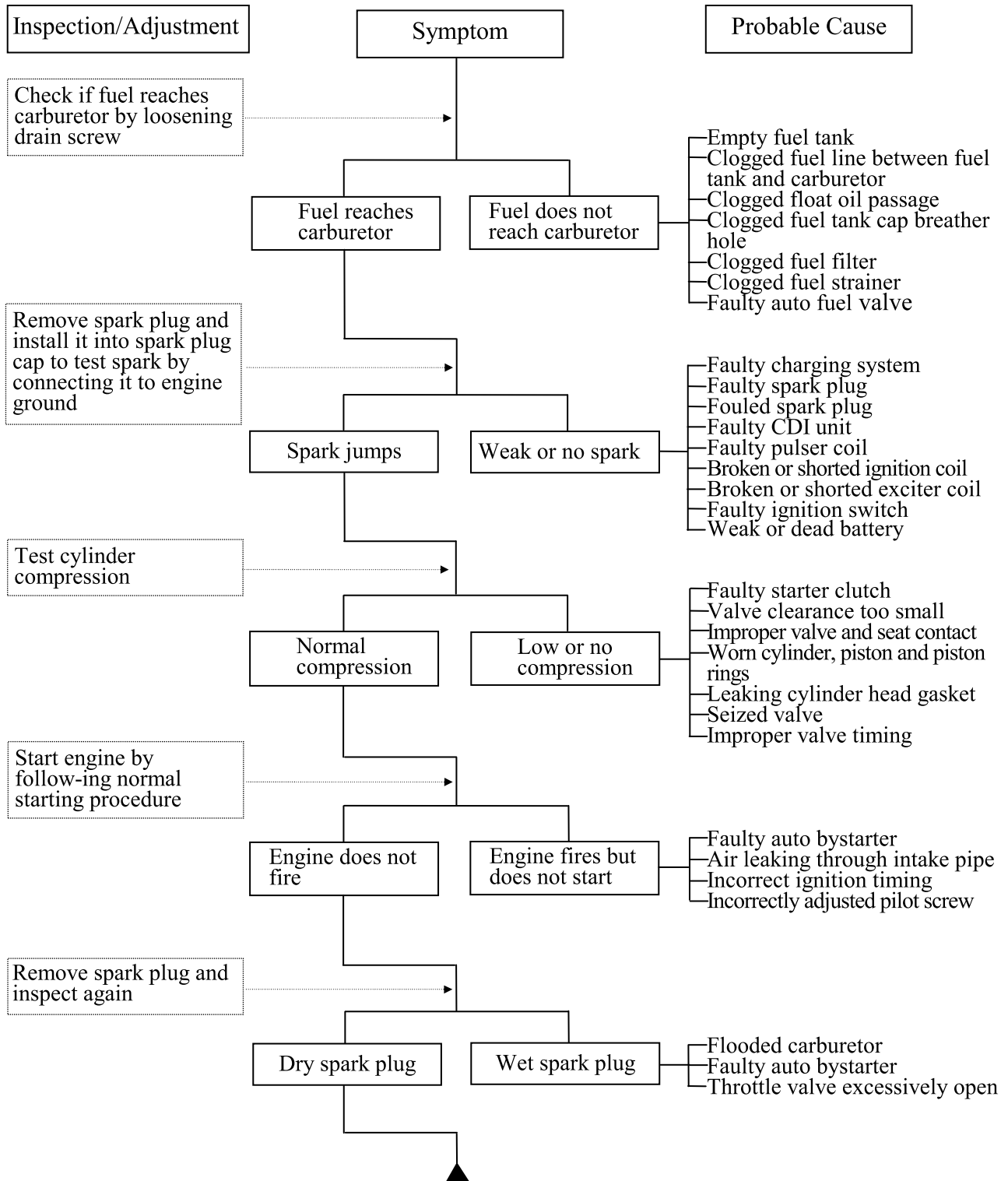

## 2. GENERAL INFORMATION

### ENGINE LACKS POWER

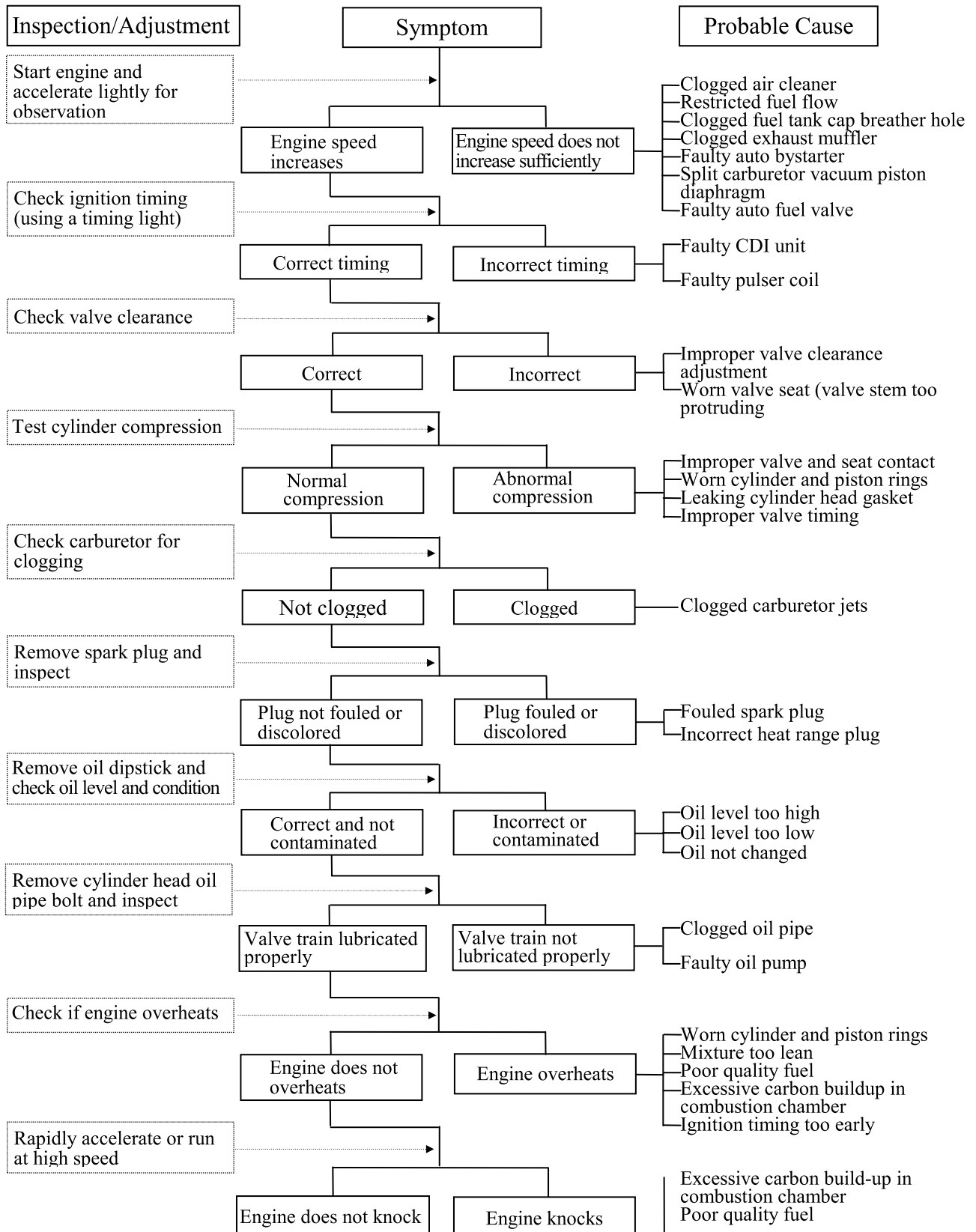



## 2. GENERAL INFORMATION

- Clutch slipping
- Mixture too lean
- Ignition timing too early

### POOR PERFORMANCE (ESPECIALLY AT IDLE AND LOW SPEEDS)

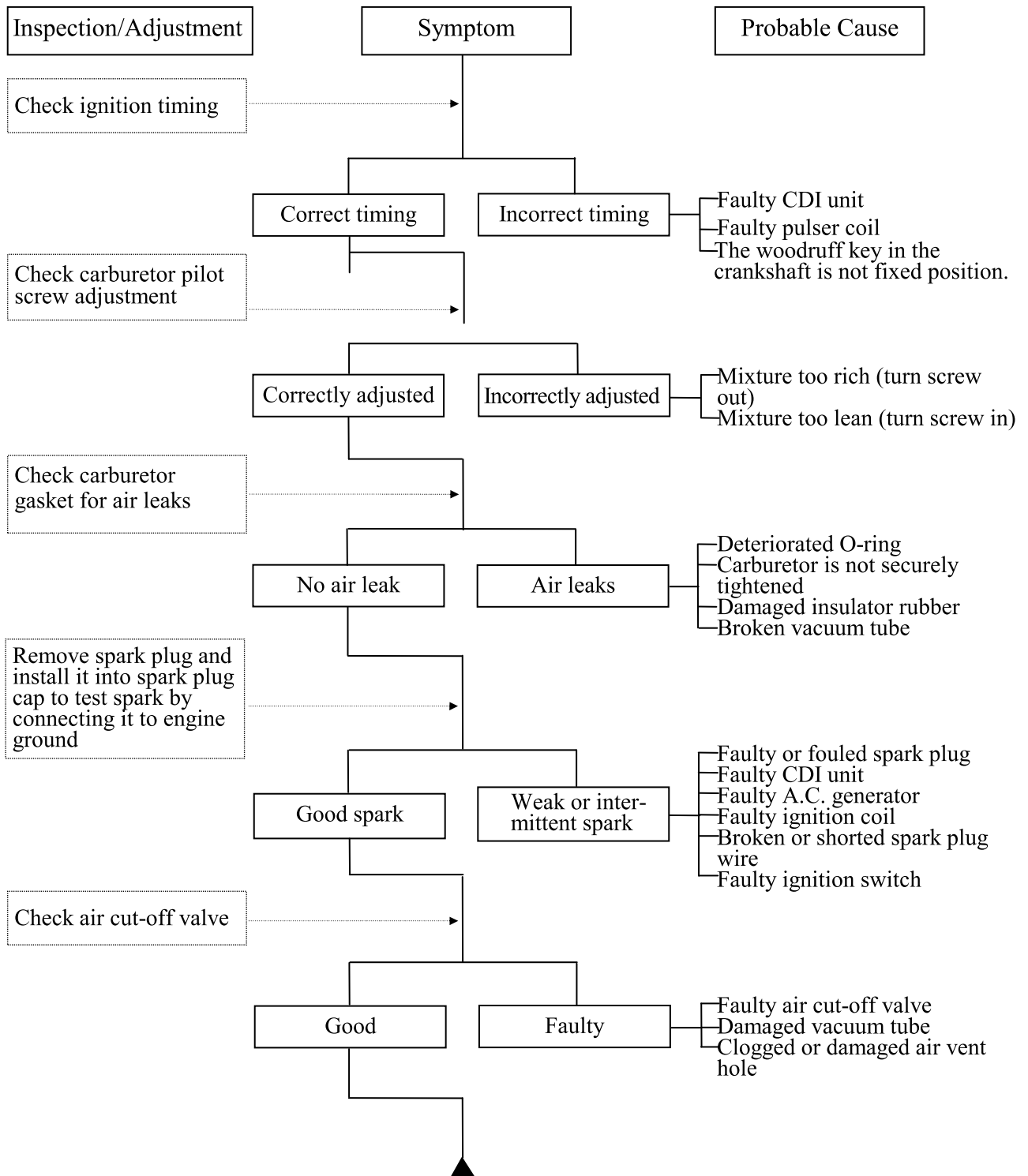

## 2. GENERAL INFORMATION

### POOR PERFORMANCE (AT HIGH SPEED)

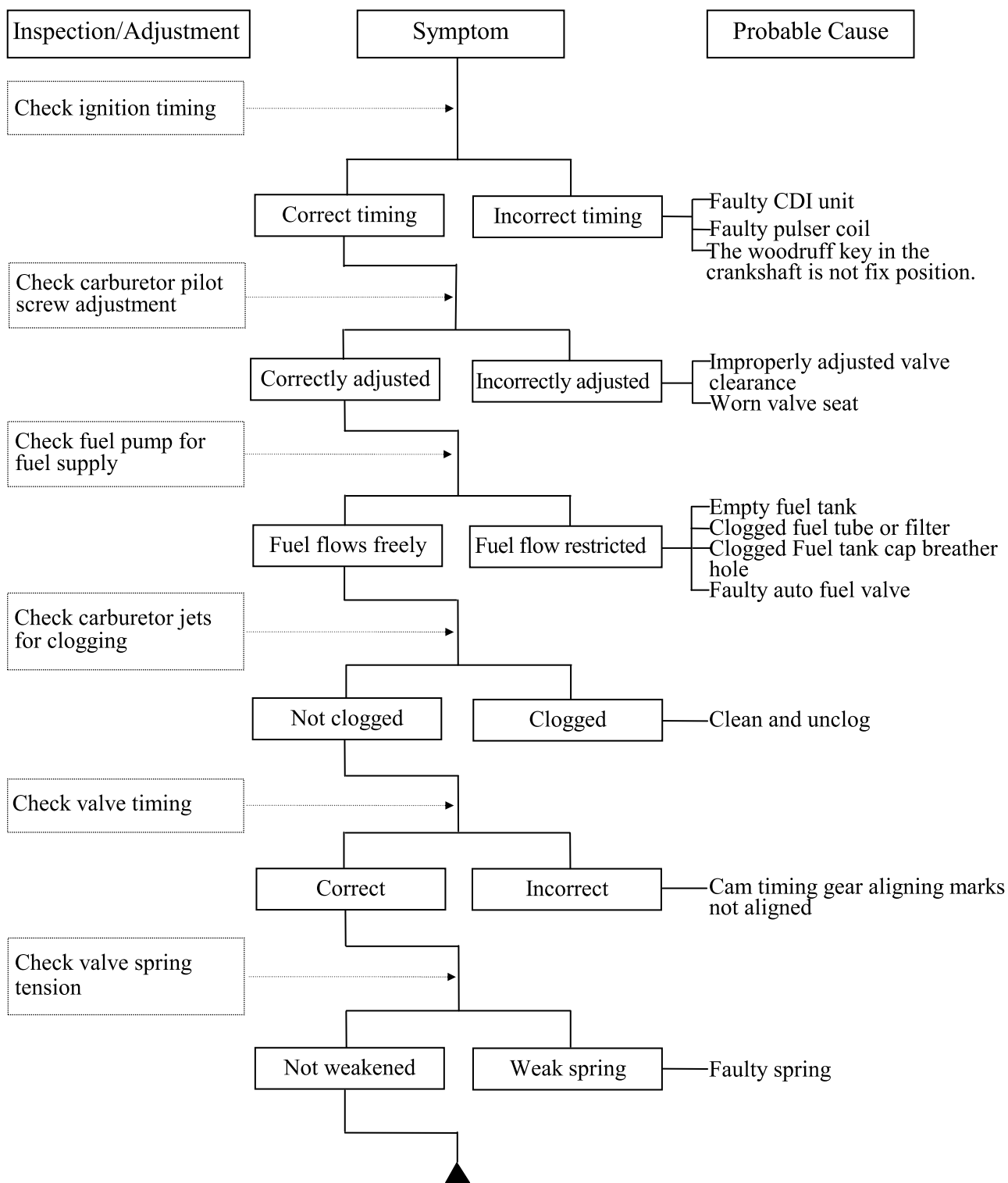

## 2. GENERAL INFORMATION

### POOR CHARGING (BATTERY OVER DISCHARGING OR OVERCHARGING)

#### Undercharging

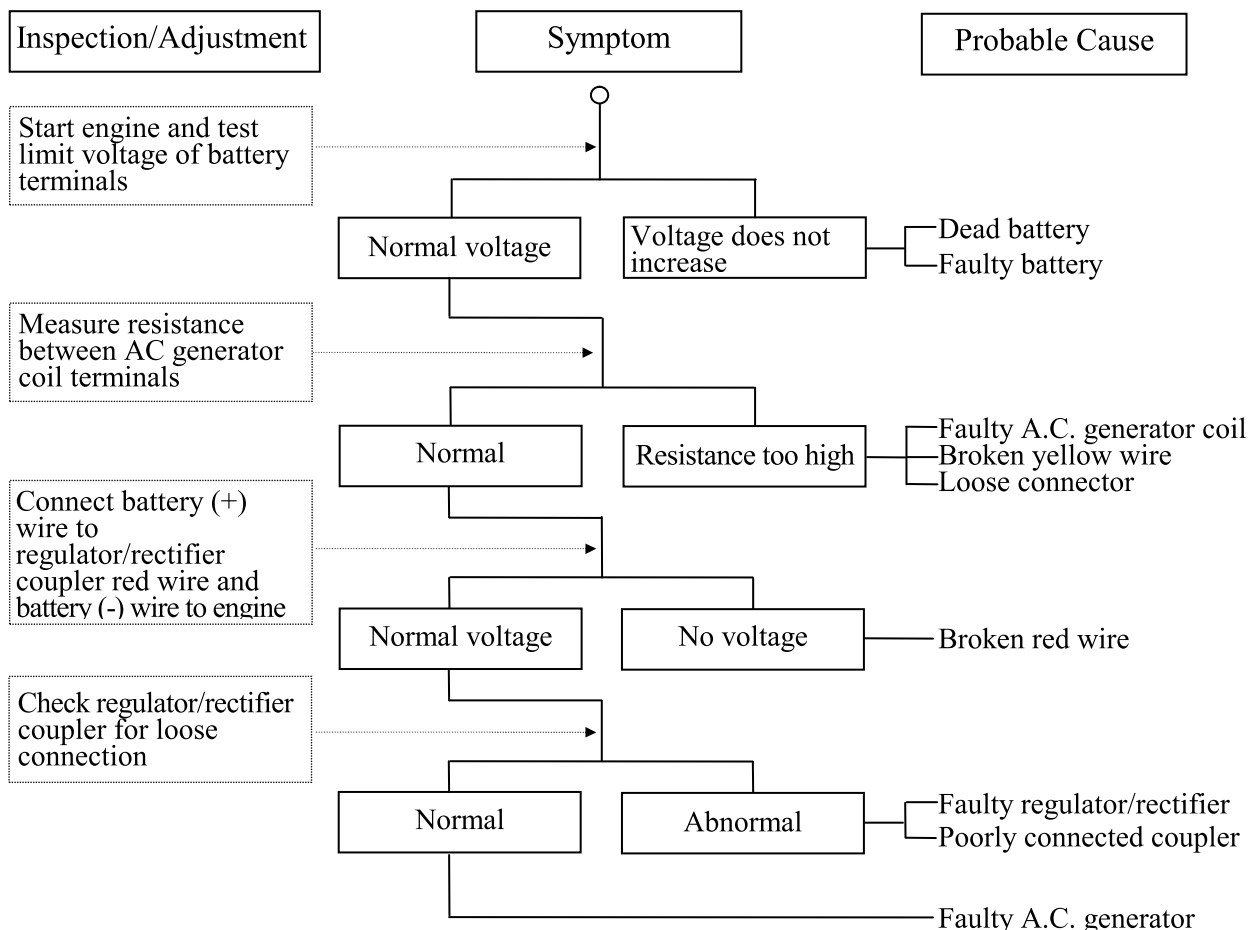

#### Overcharging

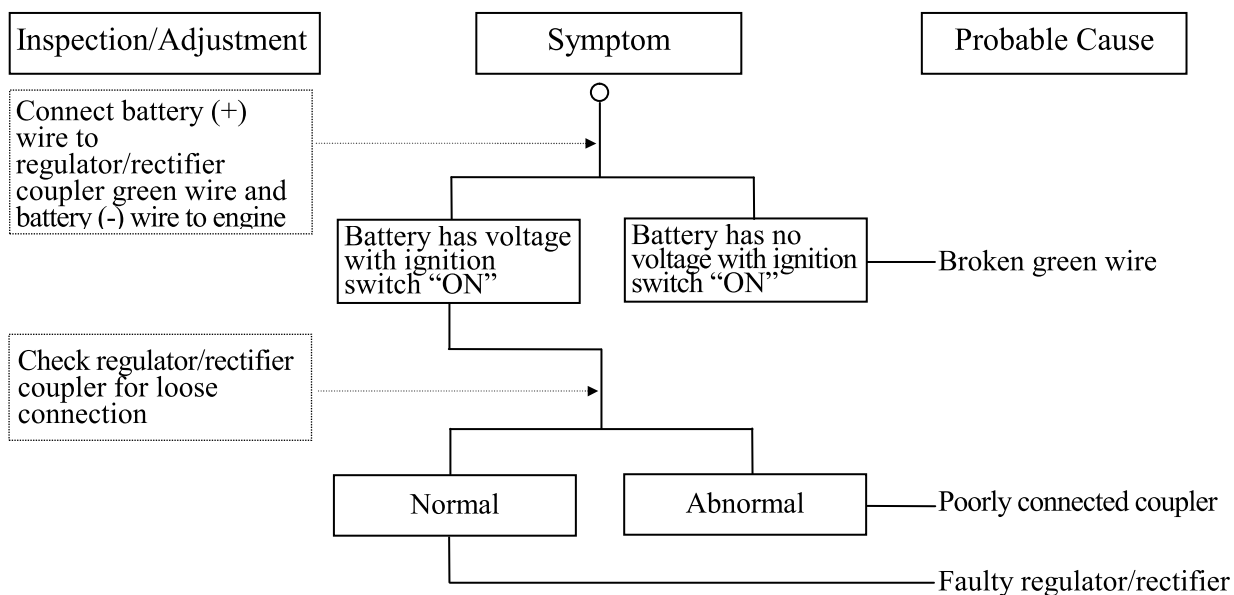

## 2. GENERAL INFORMATION

### NO SPARK AT SPARK PLUG

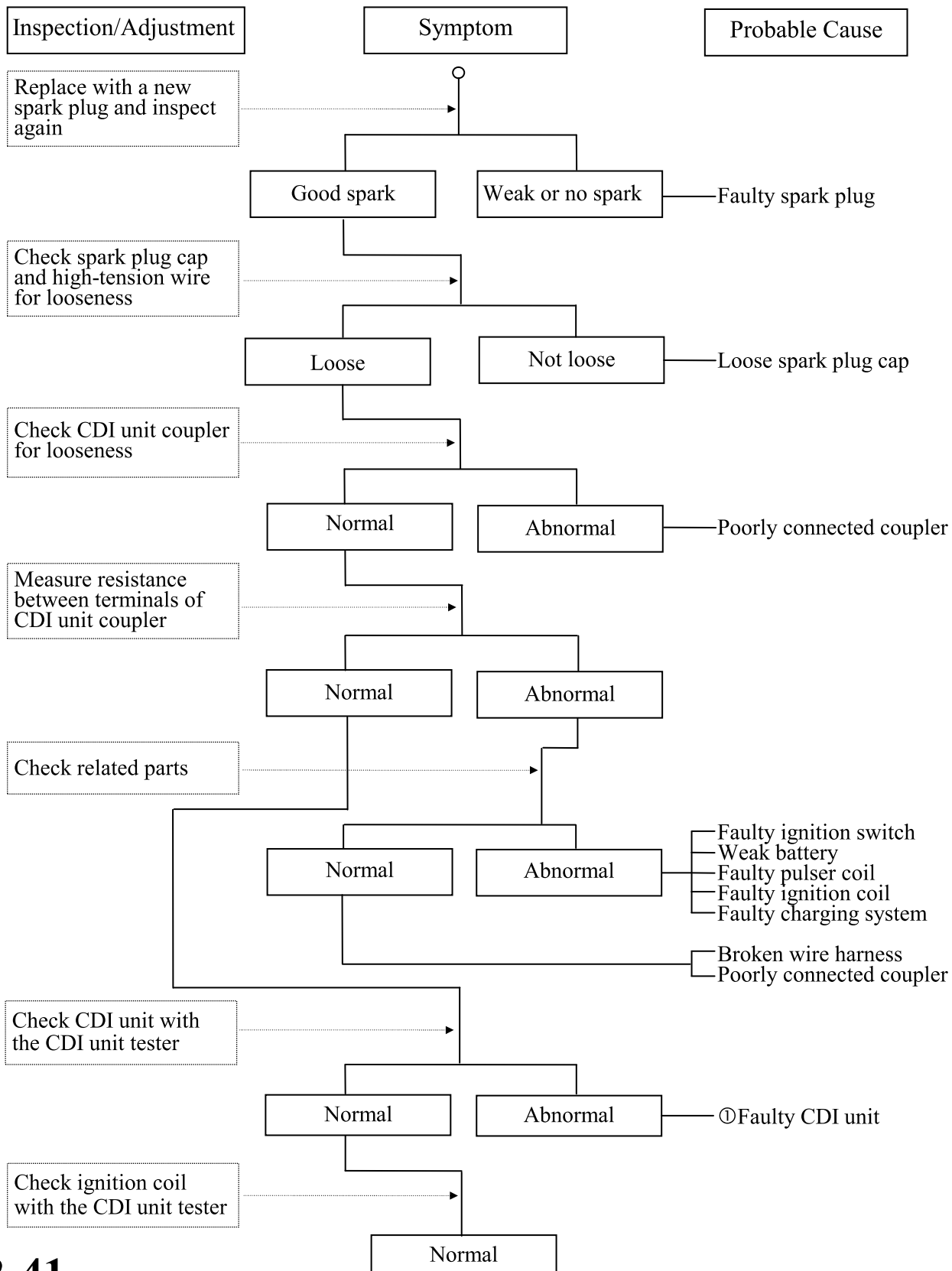

## 2. GENERAL INFORMATION

---

①Faulty ignition coil

### **3. INSPECTION/ADJUSTMENT**

---

---

### **INSPECTION/ADJUSTMENT**

---

MAINTENANCE SCHEDULE.....	3- 1
BRAKE SYSTEM.....	3- 2
MOVING DEVICE .....	3- 4
DAMPING DEVICE.....	3- 5
TRANSMISSION GEAR OIL .....	3- 5
LUBRICATION SYSTEM (2-STROKE) .....	3- 6
ENGINE OIL (4-STROKE).....	3- 8
ENGINE IDLE SPEED .....	3-10
AIR CLEANER.....	3-10
CYLINDER COMPRESSION.....	3-13
VALVE CLEARANCE (4-STROKE).....	3-14
IGNITION APPARATUS .....	3-15
THROTTLE GRIP PLAY .....	3-16
OTHERS.....	3-16

### 3. INSPECTION/ADJUSTMENT

#### MAINTENANCE SCHEDULE

Perform the periodic maintenance at each scheduled maintenance period.

I: Inspect, and Clean, Adjust, Lubricate or Replace if necessary.

A: Adjust C: Clean R: Replace T: Tighten

Item	Frequency	Whichever comes first ⇔ ↓	Regular Service Mileage (km)					
			300	1000	3000	5000	7000	9000
*Engine oil		Note 4	R <sup>New scooter</sup> 300km	R	R	R	R	R
Engine oil filter screen			C		C		C	
Fuel filter			Replace at every 6000km					
Gear oil		Note 3	R <sup>New scooter</sup> 300km		R		R	
*Valve clearance		Note 4	A		A		A	
Carburetor					I		I	
Air Cleaner		Note 2,3		I	R	I	R	I
Spark plug			Clean at every 2000km and replace if necessary					
Brake system			I	I	I	I	I	I
Drive belt							I	
Suspension					I		I	
Nut, bolt, fastener			T			T	I	
Tire					I		I	
Steering head bearing			I			I	I	
Brake fluid			Perform pre-ride inspection daily					
Brake lever					I			I
Brake shoe wear					I			I
Shock absorber					I			I

• In the interest of safety, we recommend these items be serviced only by an authorized KYMCO motorcycle dealer.

Note: 1. For higher odometer readings, repeat at the frequency interval established here.

2. Service more frequently when riding in dusty or rainy areas.

3. Service more frequently when riding in rain or at full throttle.

4. 4-stroke engine only.

### 3. INSPECTION/ADJUSTMENT

#### BRAKE SYSTEM

##### BRAKE LEVER FREE PLAY ADJUSTMENT

The rear brake lever free play should be adjusted to 10~20mm (0.4~0.8 in) at the tip of the brake lever. If the free play is incorrect, adjust as follows:

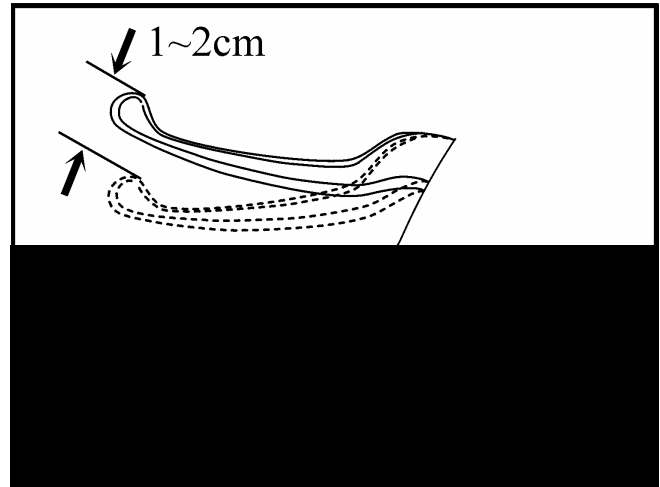

Place the scooter on its center stand.

Turn the adjusting nut in direction (A) to decrease play, and in direction (B) to increase play.

Turn the adjusting nut on the brake hub in direction (A) to decrease play, and in direction (B) to increase play.

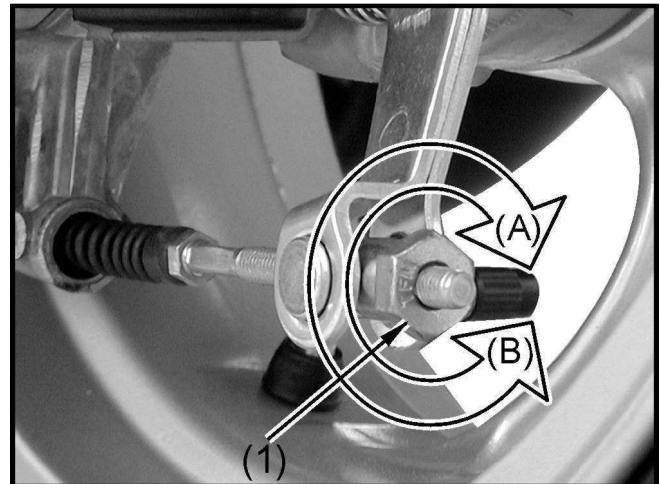

Make sure the cut-out on the adjusting nut (2) is seated on the brake arm pin (1) after making final free play adjustment.

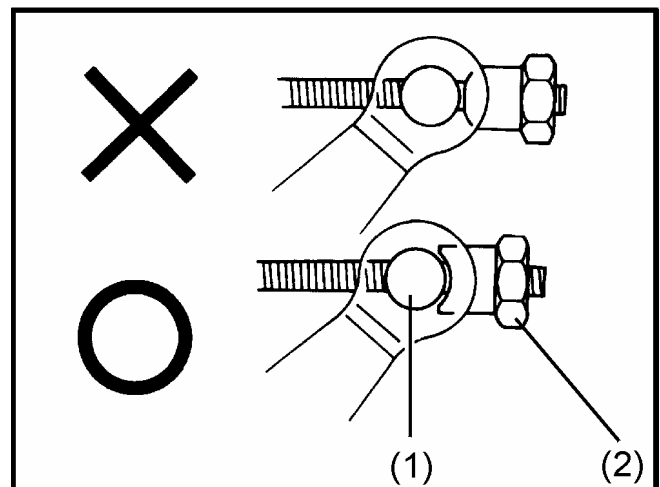



### 3. LUBRICATION SYSTEM

#### BRAKE DRUM/SHOE

##### □ Brake Shoe Wear □

Replace the brake shoes if the arrow on the brake arm (1) aligns with reference mark (2) on the brake panel when the brake is fully applied.

##### □ Brake Drum Wear/Damage □

Check the brake drum appearance for damage. Check if the brake lining wear is within the specified service limit. Check the brake operation for abnormal noise and brake drum inside for wear or damage.

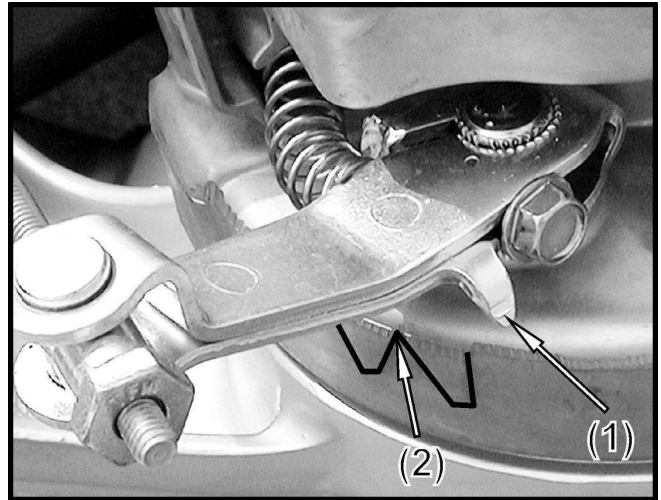

#### BRAKE DISK/LINING

##### □ Brake Disk Surface and Brake Pad Wear □

Check the brake disk surface for scratch. Check if the brake pad wear is within the specified service limit.

##### □ Brake Disk Runout Inspection □

Jack the scooter wheels off the ground and check if the brake disk runout is within the specified service limit.

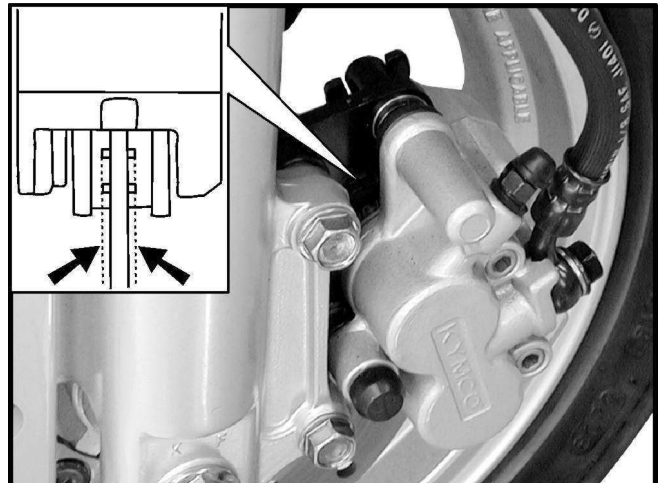

#### BRAKE FLUID LEVEL INSPECTION

##### □ Brake Master Cylinder Fluid Level Inspection □

Turn the steering handlebar upright and check if the front brake fluid level is within the specified limits through the front brake master cylinder check hole.

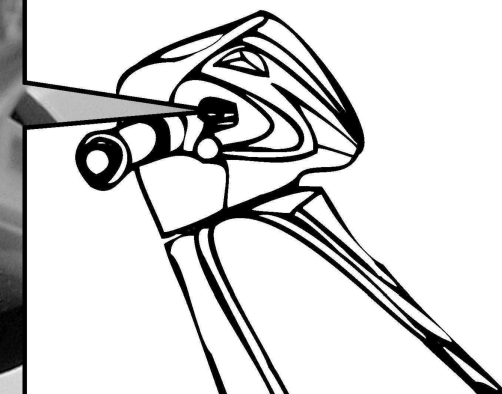
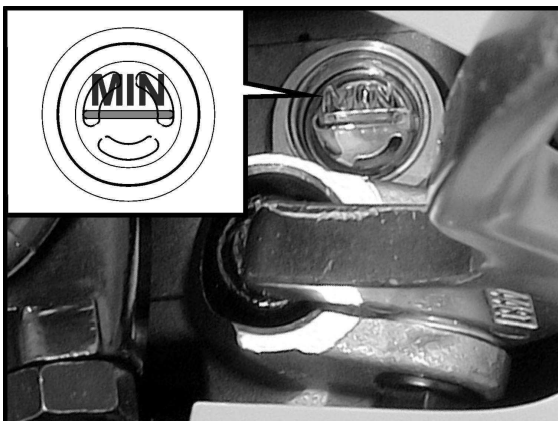

### 3. INSPECTION/ADJUSTMENT

#### MOVING DEVICE

##### TIRES

###### □ Tire Pressure □

Check the tire pressure.

□ Tire pressure should be checked when tires are cold.

Tire Pressure (one rider)

**Front:** 1.50 kg/cm<sup>2</sup>

**Rear:** 2.0 kg/cm<sup>2</sup>

Tire Size:

**Front:** 120/70-12

**Rear:** 130/70-12

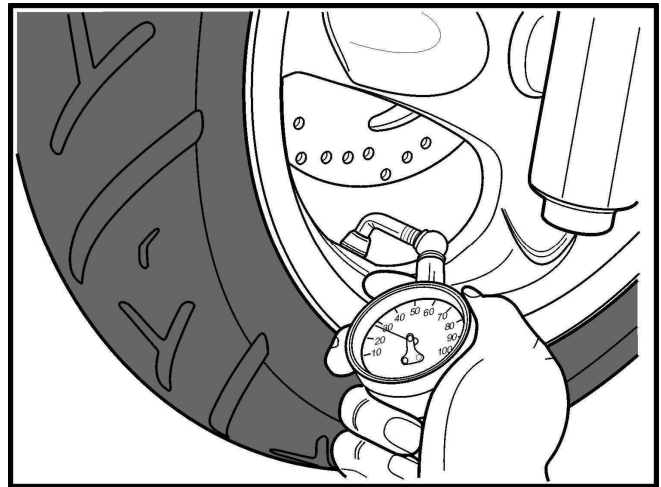

###### □ Axle Nut/Axle Shaft Looseness □

Check the front (1) and rear axle (2) nuts for looseness.

If the axle nuts are loose, tighten them to the specified torques.

Torque:

**Front:** 5.0□7.0kgf-m

**Rear:** 11.0□13.0kgf-m

###### □ Wheel Rim/Spoke Plate Damage □

Check the wheel rim and spoke plate for wear or damage and measure the rim runout.

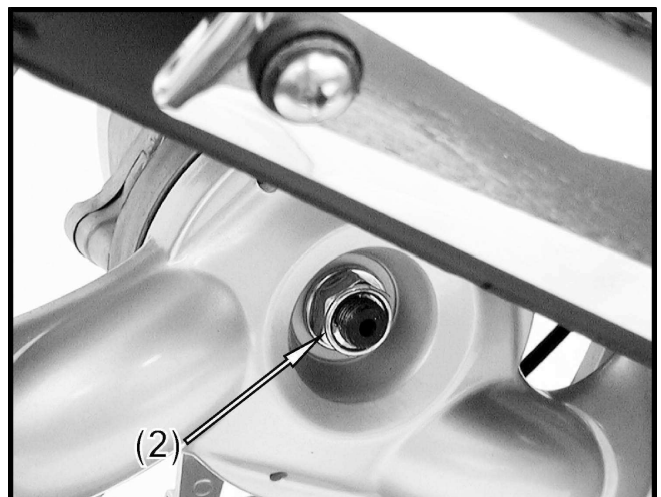

### 3. LUBRICATION SYSTEM

#### DAMPING DEVICE

##### SHOCK ABSORBERS

###### Oil Leak/Damage

Fully apply the front brake and check the action of the front shock absorber by compressing it several times.  
Check the entire shock absorber assembly for looseness or damage.  
Check the action of the rear shock absorber by compressing it several times.  
Check the entire shock absorber assembly for looseness or damage.

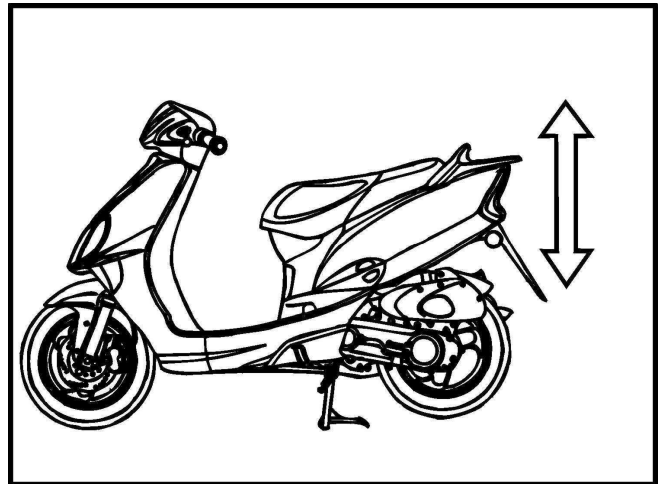
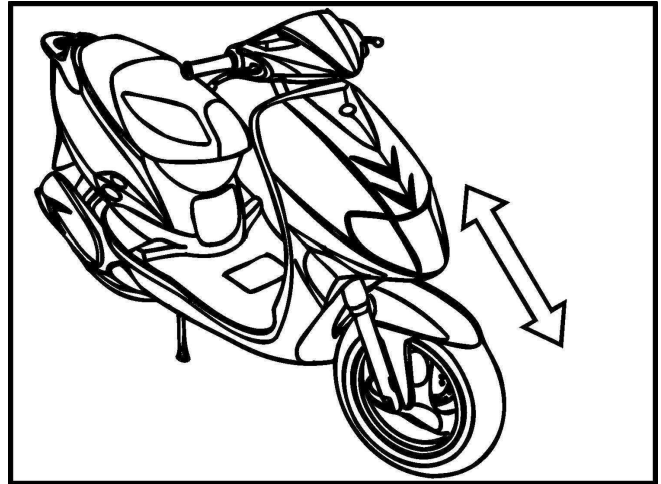

#### TRANSMISSION GEAR OIL

##### TRANSMISSION OIL MEASUREMENT

1. Place the scooter on its main stand on level ground. After the engine stops for 2~3 minutes.
2. Remove the oil filler bolt (1) and check the oil level (2). It should be up to the brim of the hole. If the level is low, add oil to raise it to the proper level.
3. After refilling, securely tighten the bolt (1).

**Torque:** 1.0~1.5kgf-m

**Specified Gear Oil:** SAE10W90#

2-Stroke

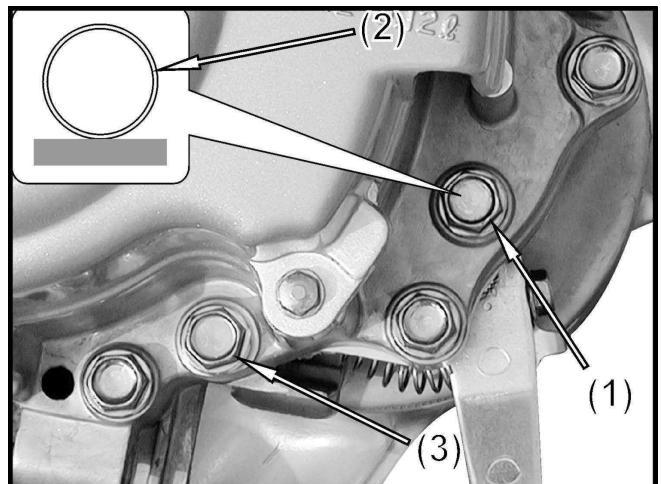

##### TRANSMISSION OIL REPLACEMENT

1. Place the scooter on a level place.
2. Place a container under the engine.

### 3. INSPECTION/ADJUSTMENT

3. Remove the oil filler bolt (1) and drain plug (3) to drain the oil.

4. Reinstall the drain plug and tighten it.

**Torque:** 1.0□1.5kgf-m

5. Fill the engine with oil and install the oil filler bolt.

6. Start the engine and warm up for a few minutes. While warming up, check for oil leakage. If oil leakage is found, stop the engine immediately and check for the cause.

- Add gear oil through the oil check bolt hole (2).
- After refilling, use a rag to wipe clean.
- Excess or insufficient gear oil will affect the engine performance.
- Never use gear oil of different brand or inferior quality which may result in engine breakdown.

4-Stroke

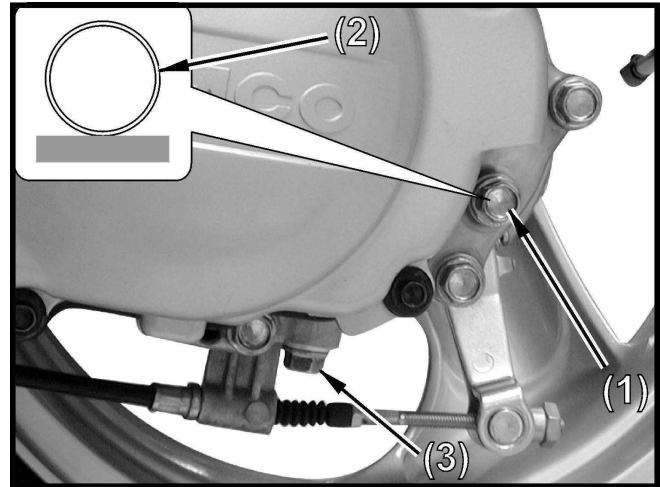

#### LUBRICATION SYSTEM (2-STROKE)

##### Oil Filter Cleaning

Remove:

Met-in box (⇒13-5)

Spark plug cover (⇒13-5)

Center cover (⇒13-6)

Disconnect the oil tube from the oil pump side and allow oil to drain into a clean container.

Remove the tube clip from the oil tank side and disconnect the oil tube.

Remove the oil filter.

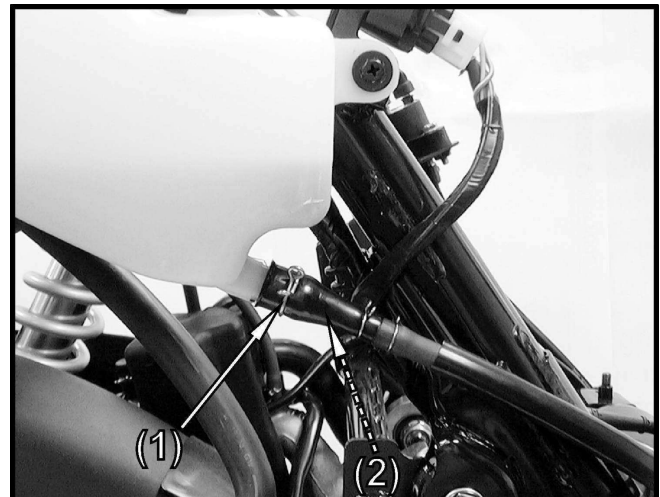

### 3. LUBRICATION SYSTEM

Clean the oil filter screen with compressed air.

Install the oil filter in the reverse order of removal and fill the oil tank with specified oil up to the proper level.

Bleed air from the oil pump and oil lines.

- Connect the oil tubes securely.
- Install the tube clip at the oil tank side and also install the clip to the lower oil tube that goes to the oil pump.
- Check for oil leaks.

#### Oil Pump Condition

Adjust oil pump control cable after the throttle grip free play is adjusted.

Remove:

Met-in box (⇒13-5), park plug cover (⇒13-5), Center cover (⇒13-6)

Open the throttle valve fully and check that the index mark on the pump body aligns with the aligning mark on the oil pump control lever.

Reference tip alignment within 1mm of index mark on open side is acceptable. Start and idle the engine, then slowly open the throttle to increase engine rpm and check the operation of the oil pump control lever.

If adjustment is necessary, adjust the oil pump control cable by loosening the control cable lock nut and turning the adjusting nut. After adjustment, tighten the lock nut.

Reference tip alignment within 1mm of index mark on open side is acceptable. However, the aligning mark on the control lever must never be on the closed side of the index mark, otherwise engine damage will occur because of insufficient lubrication.

If the oil pump is not synchronized properly, the following will occur:

- Excessive white smoke or hard starting due to pump control lever excessively open
- Seized piston due to pump control lever insufficiently open

Filter Screen

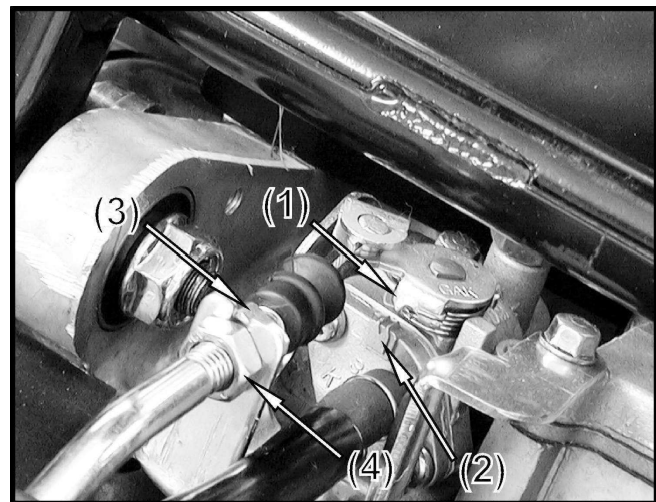
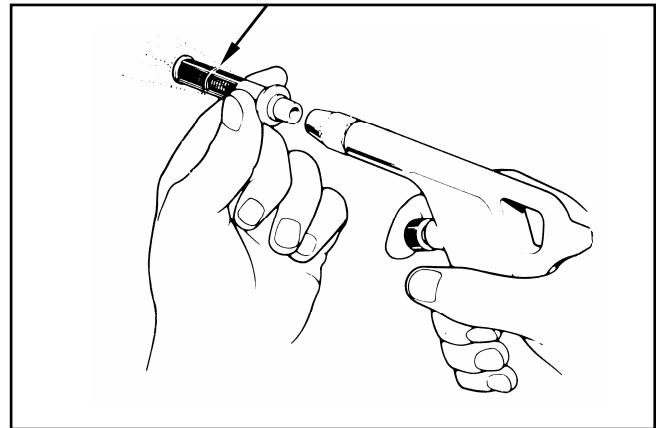

### 3. INSPECTION/ADJUSTMENT

#### ENGINE OIL (4-STROKE) OIL LEVEL

Place the scooter on a level place.  
Warm up the engine for several minutes and stop it.

Remove the dipstick and wipe it off with a clean rag. Insert the dipstick in the filler hole without screwing it in.

- Run the engine for 2-3 minutes and check the oil level after the engine is stopped for 2-3 minutes.

Remove the dipstick and inspect the oil level.

The oil level should be between the maximum and minimum marks. If the level is low, add oil to raise it to the proper level.

Dipstick/Oil Filler Cap

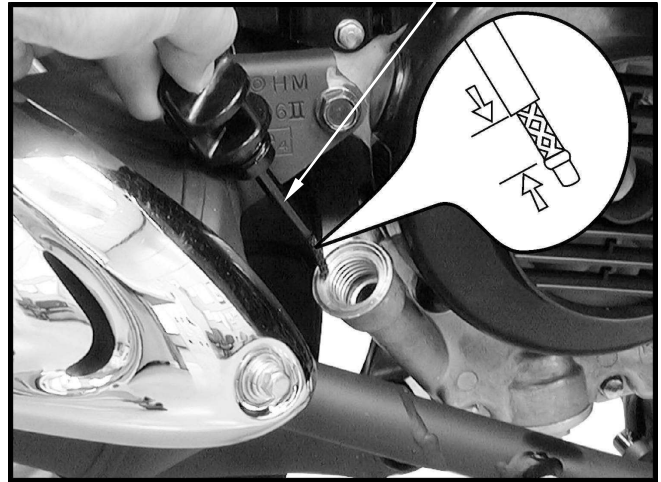

#### ENGINE OIL REPLACEMENT

Place the scooter on a level place.  
Warm up the engine for several minutes and stop it.

Place a container under the engine.

Remove the oil filler cap (1) and drain plug (2) to drain the oil.

Reinstall the drain plug and tighten the drain plug to specification.

**Torque:** 2.0-3.0kgf-m

Fill the engine with oil and install the oil filler cap.

Warm up the engine for several minutes at idle speed. Check for oil leakage while warming up.

- Be sure no foreign material enters the crankcase.

**Oil Capacity:** At disassembly: 0.85L

At change: 0.7L

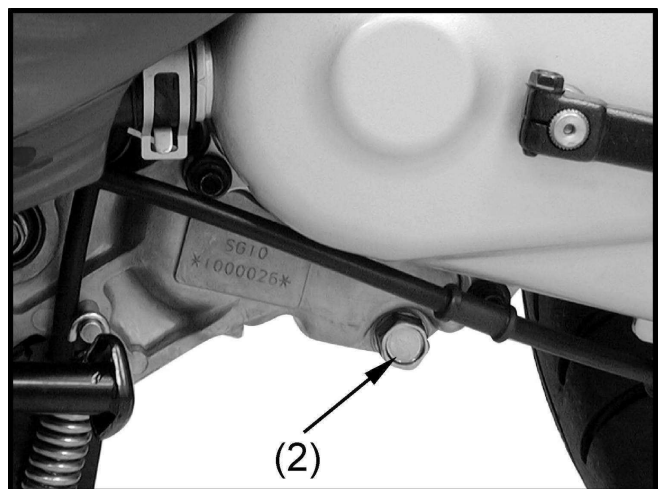
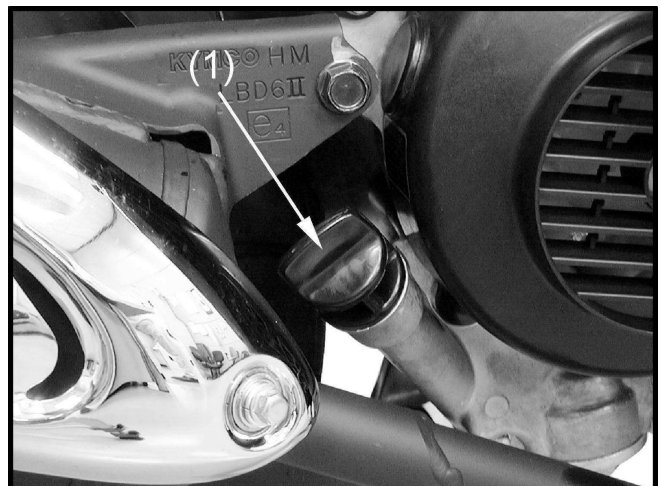

### 3. LUBRICATION SYSTEM

#### ENGINE OIL REPLACEMENT AND OIL FILTER CLEANING

- A. Place the machine on a level place.
- B. Warm up the engine for several minutes and stop it.
- C. Place a container under the engine.
- D. Remove the oil filler cap and oil filter cap to drain the oil.

- Be sure no foreign material enters the crankcase.
- When removing the drain plug, the compression spring, oil strainer and O-ring will fall out. Take care not to lose these parts.



Oil Filler Cap

- E. Clean the oil strainer with solvent.
- F. Inspect the O-ring and replace if damaged.
- G. Reinstall the O-ring, oil strainer, compression spring and drain plug. Tighten the drain plug to specification.  
**Torque:** 1.0□2.0kgf-m

- Before reinstalling the drain plug, be sure to install the O-ring, compression spring and oil strainer.

**Oil Capacity:**      At disassembly: 0.85L  
                              At change: 0.7L

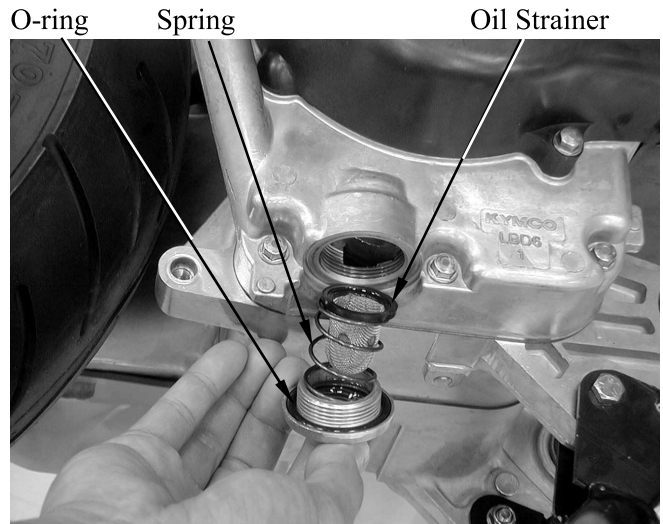



### 3. INSPECTION/ADJUSTMENT

#### ENGINE IDLE SPEED

□ At High and Low Speeds □

□ The engine must be warm for accurate idle speed adjustment.

Adjust the idle speed to the specified range by turning the throttle stop screw (2) and air screw (1).

**Idle Speed:**

2-Stroke: 1850±100rpm

2-Stroke

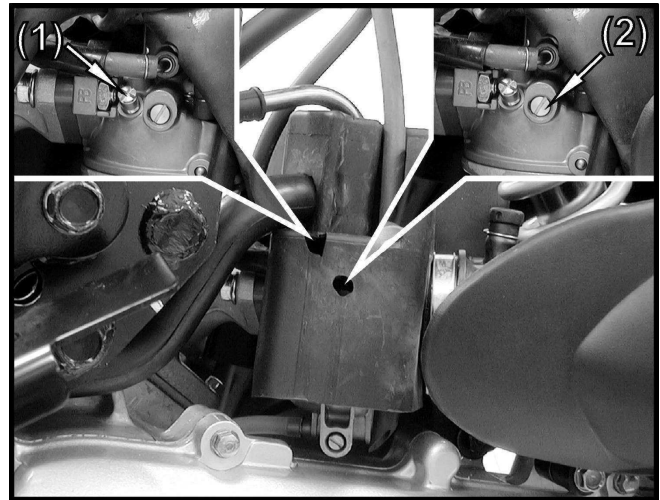

Adjust the idle speed to the specified range by turning the throttle stop screw and pilot screw.

**Idle Speed:**

4-Stroke: 1800±100rpm

4-Stroke

Throttle Stop Screw

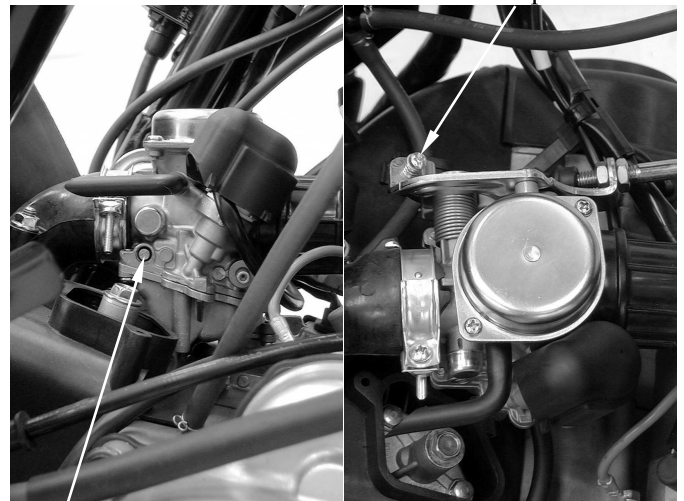

Pilot Screw

#### AIR CLEANER

□ Air Cleaner (2-Stroke) □

Remove the air cleaner cover by removing the 7 air cleaner cover screws and air cleaner housing cover (1).

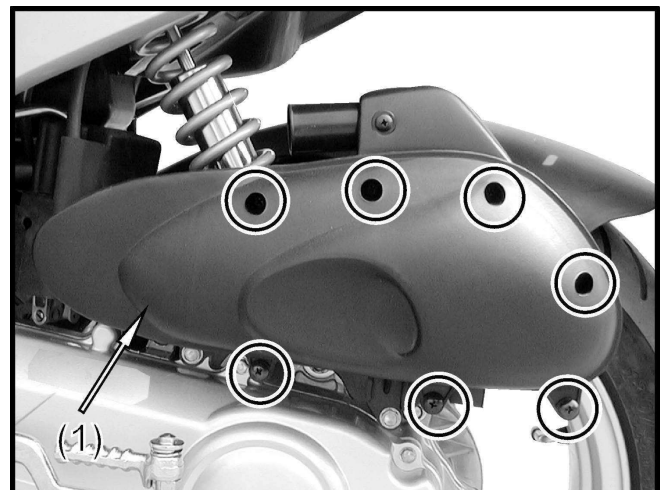



### 3. LUBRICATION SYSTEM

Remove the air cleaner element (1).

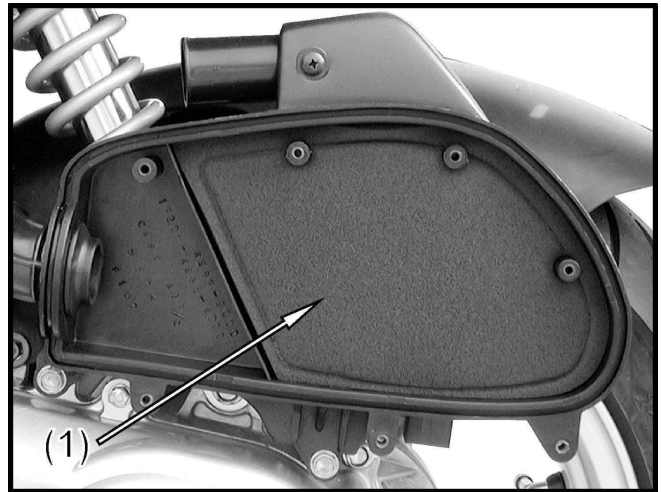

Wash the air cleaner element in detergent oil, squeeze out and allow to dry.

□ Never use gasoline or organic vaporable oil with acid or alkali for washing.

After washing, soak the element in clean engine oil SAE 15W-40# and squeeze out excess oil. Reinstall the element.

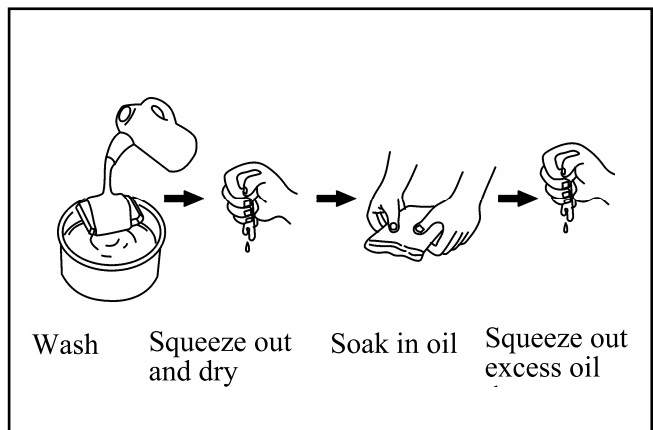

#### □ Air Cleaner (4-Stroke) □

1. Remove the air filter case cover by removing the 6 screws.

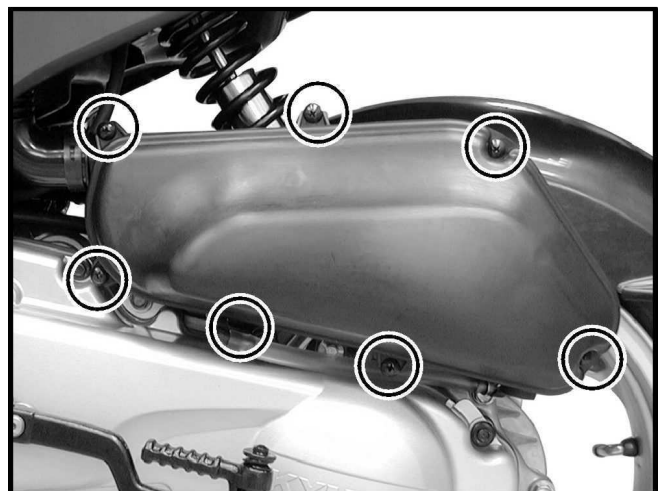

### 3. INSPECTION/ADJUSTMENT

2. Remove the air cleaner (1).

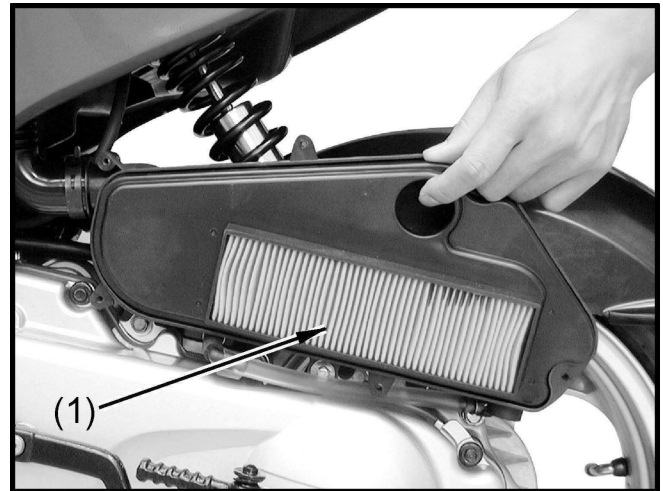

3. Clean the air cleaner element with compressed air.
4. Replace the air cleaner element at very 4000km.
5. For installation, reverse the removal procedures.

- - Never use oil or solvent to wash the wet type paper element.
  - Be careful not to allow water to enter the air cleaner; otherwise it may result in hard starting.
  - If the air cleaner is not installed properly, dust may be sucked into the cylinder directly to reduce engine horsepower and affect the engine life.

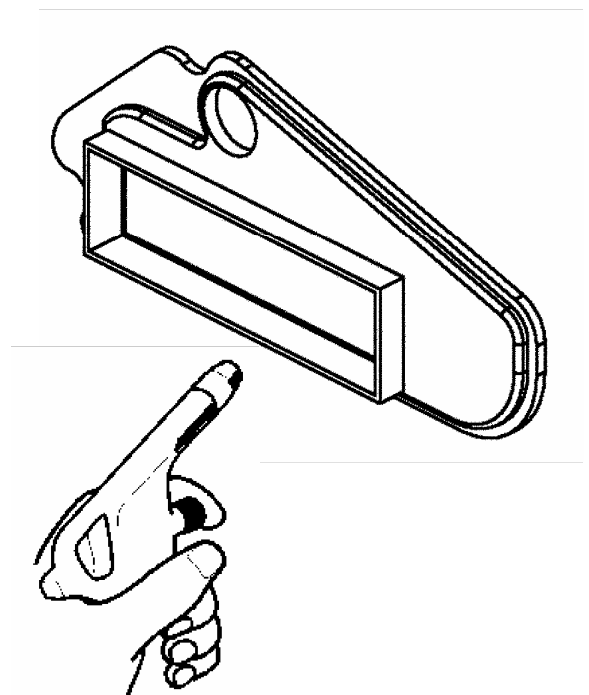

## 3. LUBRICATION SYSTEM

### CYLINDER COMPRESSION

□ Warm up the engine before compression test.

Remove spark plug cover. (⇒13-5)

Remove the spark plug and insert a compression gauge.

Open the throttle valve fully and push the starter button for 7□8 seconds to test the compression.

**Compression:**

2-Stroke: 11.8kg/cm<sup>2</sup>

4-Stroke: 14kg/cm<sup>2</sup>

If the compression is low, check for the following:

- Leaking cylinder head gasket
- Worn piston/cylinder

If the compression is high, it indicates that carbon deposits have accumulated on the combustion chamber and the piston head.

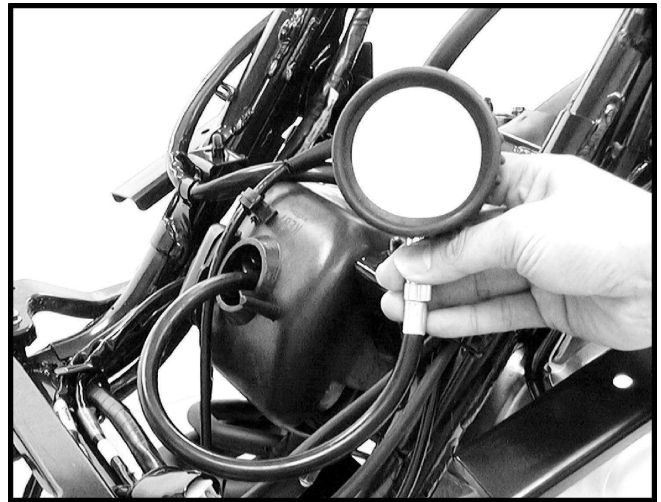

### 3. INSPECTION/ADJUSTMENT

#### VALVE CLEARANCE (4-STROKE)

- ☐ • Inspect and adjust valve clearance while the engine is cold (below 35°C).

Remove the met-in box (⇒13-5) and center cover. (⇒13-6)  
Remove cylinder head cover. (⇒6-4)

Turn the A.C. generator flywheel to the top dead center (TDC) on the compression stroke so that the “T” mark on the flywheel aligns with the index mark on the left crankcase cover.

The time marks on the cam sprocket must be flush with the cylinder head surface and round hole on the cam sprocket must be facing up as shown.

If the round hole on the cam sprocket are facing down, turn the crankshaft clockwise one full turn and realign the timing marks with the cylinder head surface so it is facing up.

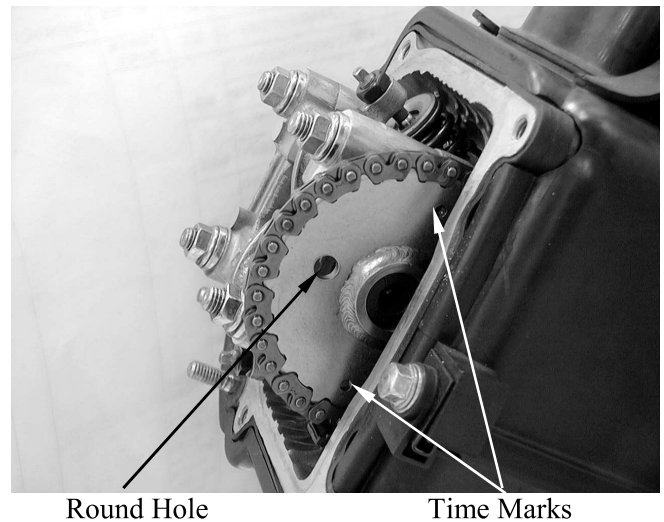
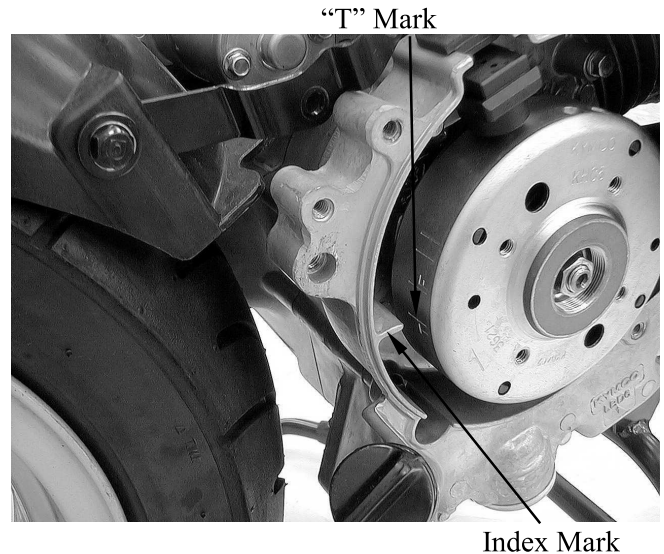

Insert a thickness gauge between the valve stem end and the adjusting screw on the rocker arm.

If the clearance is out of specification, bring it into the specified range.

**Valve Clearance:** IN: 0.04mm  
EX: 0.04mm

Loosen the lock nut and adjust by turning the adjusting nut

Special

Valve Adjuster    E036

- ☐ • Check the valve clearance again after the lock nut is tightened.

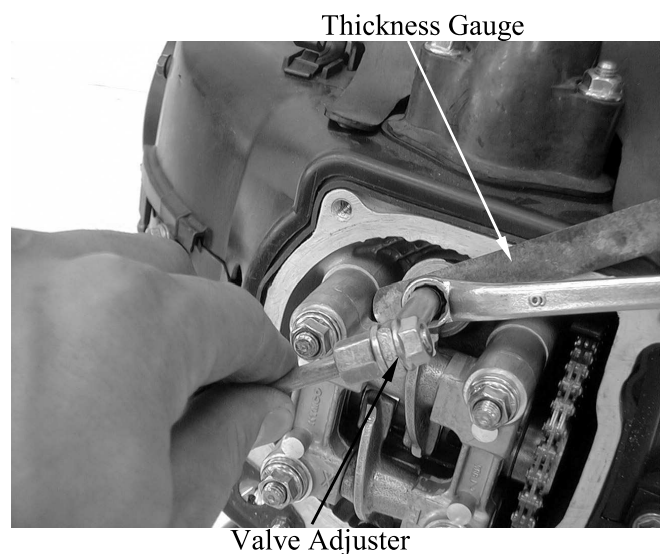

### 3. LUBRICATION SYSTEM

#### IGNITION APPARATUS

##### □ Spark Plug □

Remove the frame center cover.  
 Remove the spark plug cap and spark plug.  
 Check the spark plug for wear, fouling and carbon deposits.  
 Remove the fouling and carbon deposits with a spark plug cleaner or wire brush.

##### Specified:

2-Stroke: NGK-BR8HSA

4-Stroke: NGK-C7HSA

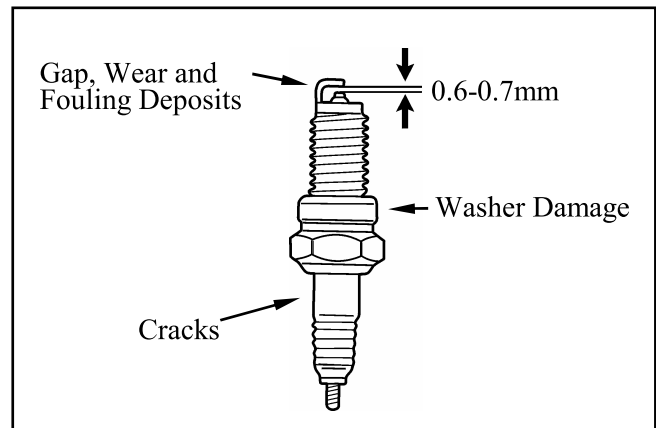

**Spark Plug Gap:** 0.6□0.7mm

##### □ Ignition Apparatus □

□ The CDI ignition timing is not adjust-able. If the timing is incorrect, check the CDI unit, ignition coil and A.C. generator and replace any faulty

Remove the A.C. generator fan cover.  
 (⇒8-3)

Remove the four bolts from the fan and then remove the fan. (⇒8-3)

Warm up the engine and check the ignition timing with a timing light.

When the engine is running at the specified rpm, the ignition timing is correct if the “F” mark on the flywheel aligns with the index mark on the crankcase within  $\pm 2^\circ$ .

##### Ignition Timing:

2-stroke:  $13.5^\circ \pm 2^\circ / 3000\text{rpm}$

4-stroke:  $28^\circ \pm 2^\circ / 4000\text{rpm}$

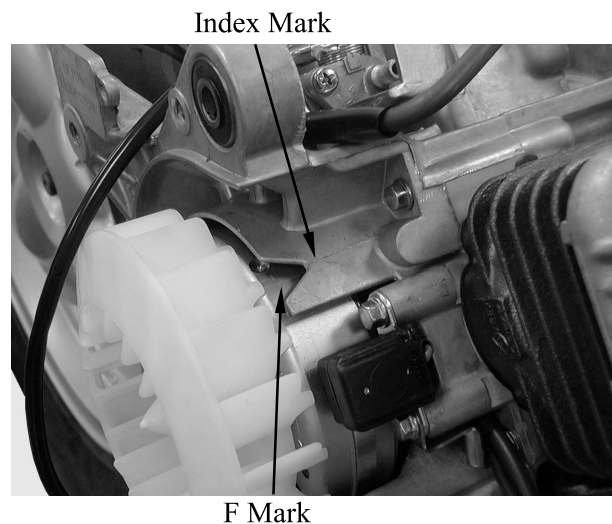

### 3. INSPECTION/ADJUSTMENT

#### THROTTLE GRIP FREE PLAY

Measure the throttle grip free play.

**Free Play:** 2~6mm

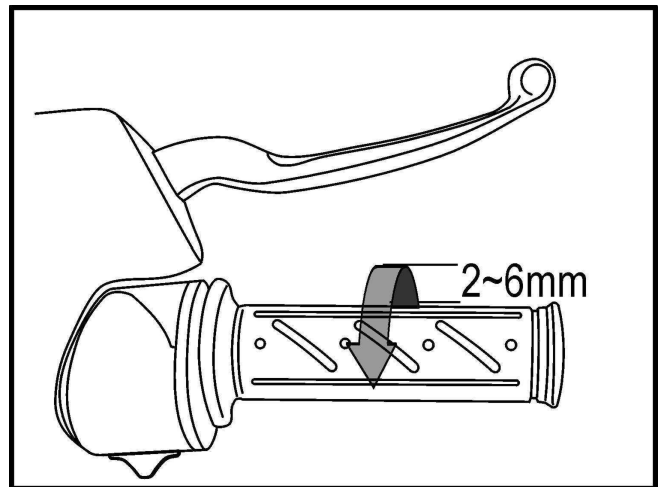

If the throttle grip free play does not fall within the specified range, adjust by loosening the lock nut (1) and turning the adjusting nut (2).

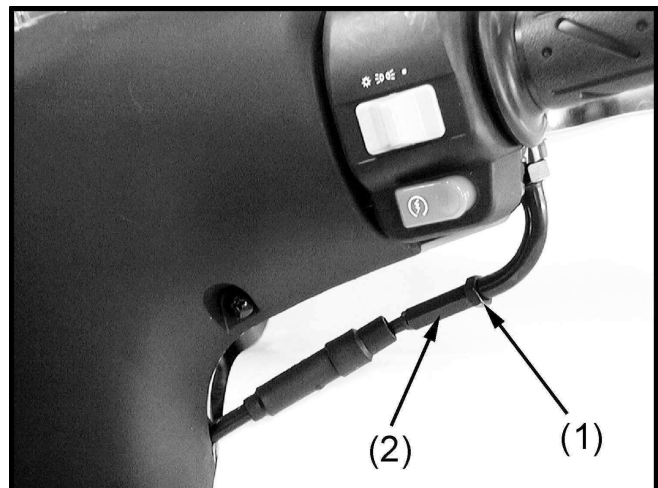

#### OTHERS

##### LIGHTS

###### □Headlight□

Turn on the headlight switch.

Adjust the headlight beam by turning the headlight beam adjusting screw (1).



## 4. LUBRICATION SYSTEM

---

---

### LUBRICATION SYSTEM

---

SERVICE INFORMATION (2-STROKE).....	4-3
SERVICE INFORMATION (4-STROKE).....	4-4
OIL PUMP (2-STROKE).....	4-5
OIL TANK (2-STROKE).....	4-8
ENGINE OIL/OIL FILTER (4-STROKE).....	4-9
OIL PUMP (4-STROKE).....	4-9

## 4. LUBRICATION SYSTEM

---

### LUBRICATION SYSTEM (2-STROKE)

---

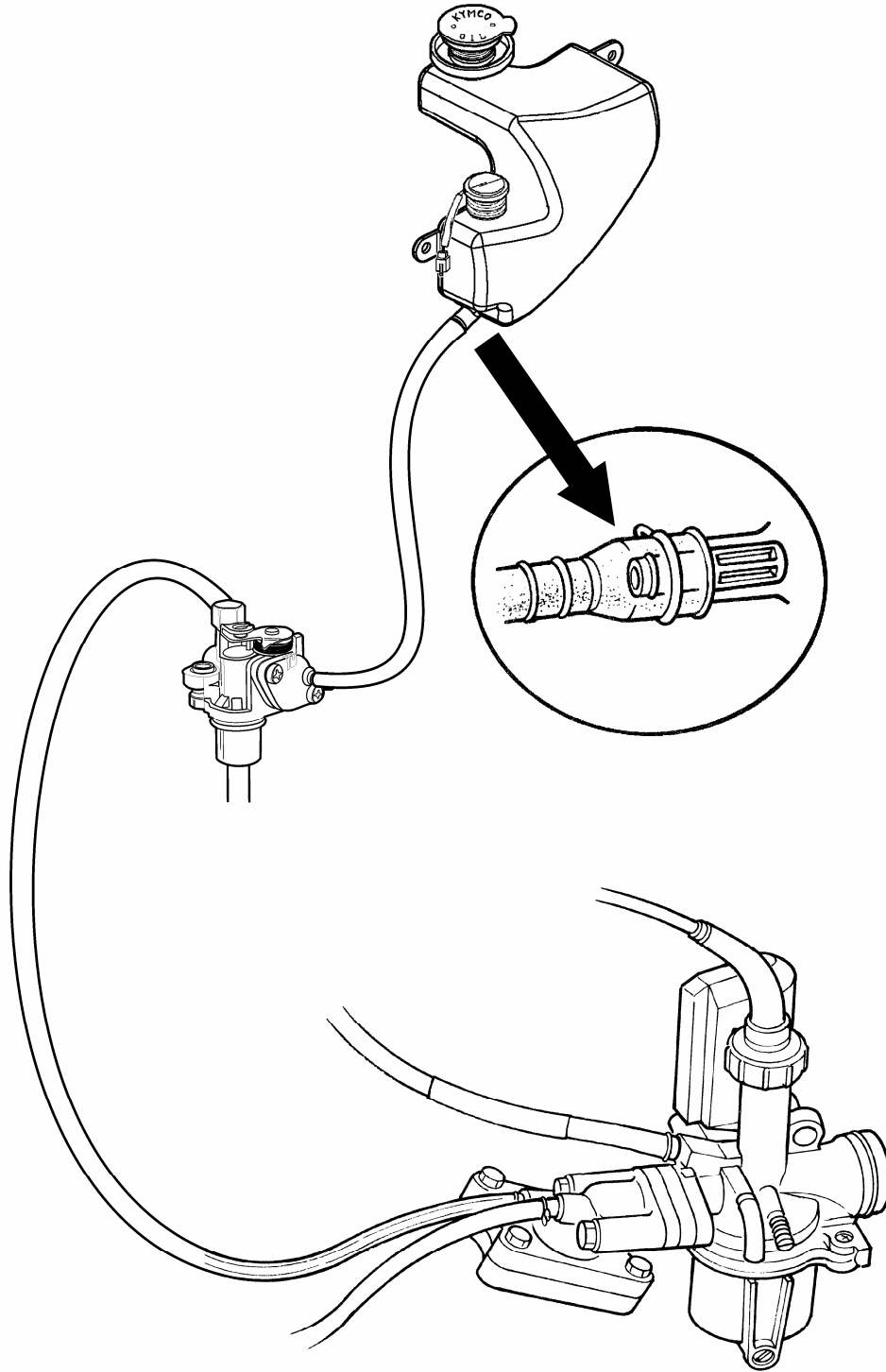



# 4. LUBRICATION SYSTEM

(4-STROKE)

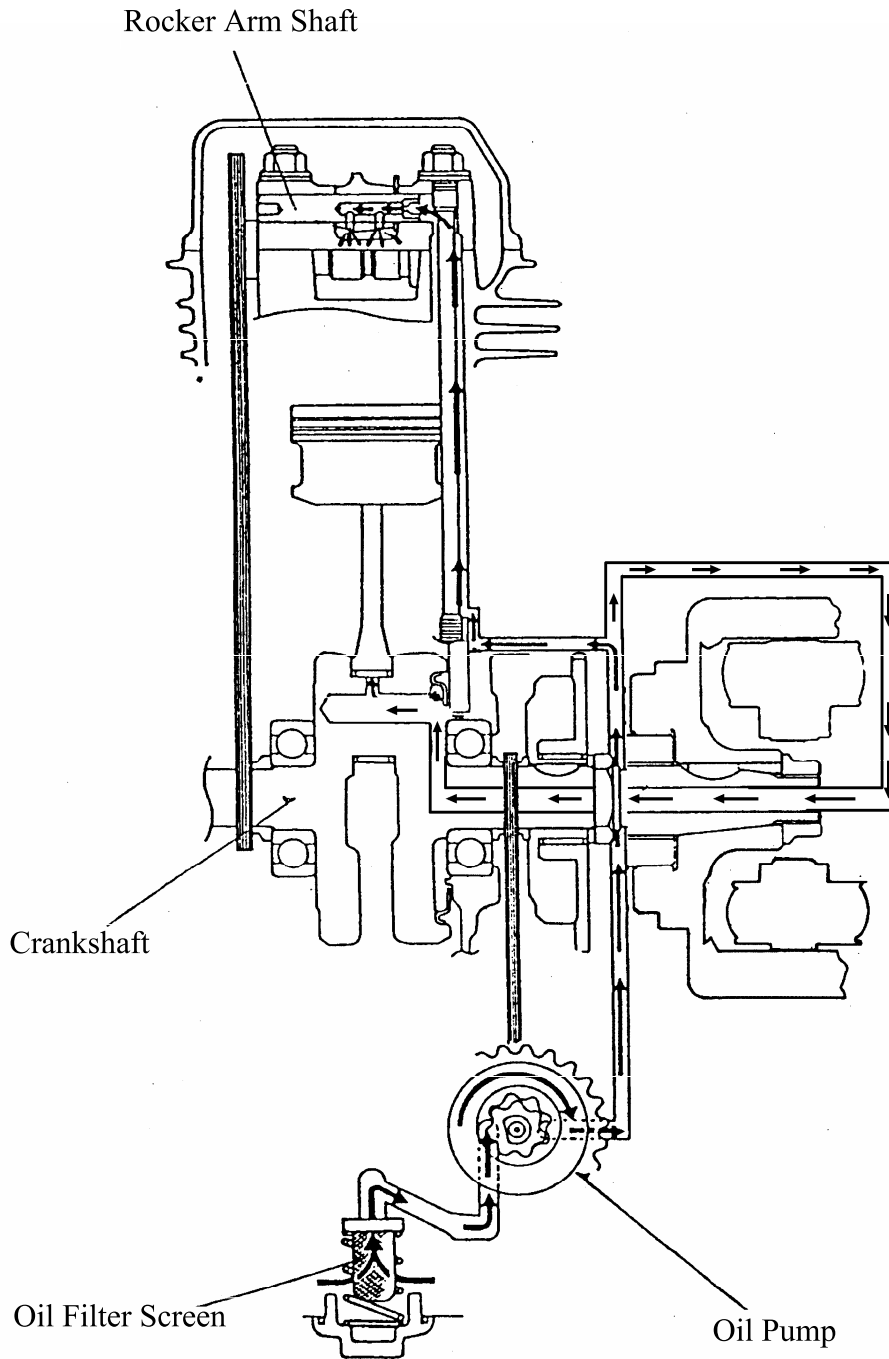

## 4. LUBRICATION SYSTEM

---

### SERVICE INFORMATION (2-STROKE)

#### GENERAL INSTRUCTIONS

- Use care when removing and installing the oil pump not to allow dust and dirt to enter the engine and oil line.
- Do not attempt to disassemble the oil pump.
- Bleed air from the oil pump if there is air between the oil pump and oil line.
- If the oil is disconnected, refill the oil line with motor oil before connecting it.

#### SPECIFICATIONS

- Recommended Motor Oil: SAE20W20# 2-stroke Motor Oil
- Oil Capacity : 1.3 liter  
Light comes on : 0.5 liter

#### TROUBLESHOOTING

##### Excessive white smoke or carbon deposits on spark plug

- Oil pump not properly synchronized (excessive oil)
- Poor quality oil

##### Engine overheating

- Oil pump not properly adjusted (insufficient oiling)
- Poor quality oil

##### Seized piston

- No oil in tank or clogged oil line
- Oil pump not properly adjusted (insufficient oiling)
- Air in oil line
- Faulty oil pump

##### Oil not flowing out of tank to engine

- Clogged oil tank cap breather hole
- Clogged oil filter

## 4. LUBRICATION SYSTEM

### SERVICE INFORMATION (4-STROKE)

#### GENERAL INSTRUCTIONS

- The maintenance of lubrication system can be performed with the engine installed in the frame.
- Use care when removing and installing the oil pump not to allow dust and foreign matters to enter the engine and oil line.
- Do not attempt to disassemble the oil pump. The oil pump must be replaced as a set when it reaches its service limit.
- After the oil pump is installed, check each part for oil leaks.

#### SPECIFICATIONS

Item		Standard (mm)	Service Limit (mm)
Oil pump	Inner rotor-to-outer rotor clearance	0.15	0.20
	Outer rotor-to-pump body clearance	0.15□0.20	0.25
	Rotor end-to-pump body clearance	0.04□0.09	0.12

#### TROUBLESHOOTING

##### Oil level too low

- Natural oil consumption
- Oil leaks
- Worn or poorly installed piston rings
- Worn valve guide or seal

##### Poor lubrication pressure

- Oil level too low
- Clogged oil filter or oil passages
- Not use the specified oil

## 4. LUBRICATION SYSTEM

### OIL PUMP (2-STROKE)

#### REMOVAL

Do not allow foreign matters to enter the crankcase. Before removing the oil pump, clean the oil pump and crankcase surfaces.

Remove the met-in box (⇒13-5), spark plug cover (⇒13-5), center cover (⇒13-6).

Disconnect the oil pump control cable (3) from the pump body.  
Disconnect the oil inlet line (1) from the oil pump.  
Then, disconnect the oil outlet line (2).

Before disconnecting the oil line, clip the oil line to avoid oil flowing out and then plug the oil line after it is disconnected.

Remove the two bolts and oil pump control cable plate (1).

Pull up and remove the oil pump (2) from the crankcase.

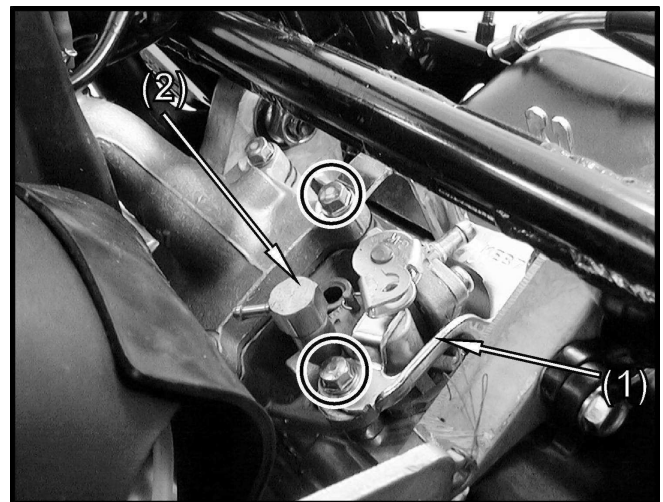
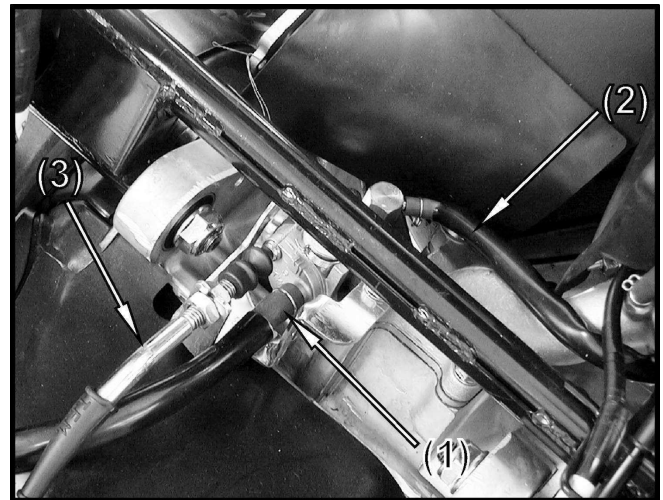

#### INSPECTION

Remove the oil pump and inspect the following items:

- Weakened O-ring (1)
- Damage to crankcase mating surface
- Damage to pump body
- Control lever operation (2)
- Oil leaks through oil seals
- Worn or damaged pump pinion (3)

Do not disassemble the oil pump which cannot be used after disassembly.

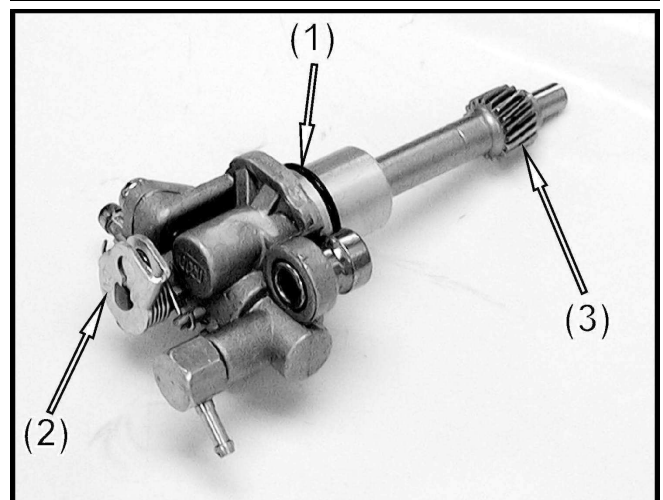

## 4. LUBRICATION SYSTEM

### INSTALLATION

- Lubricate the O-ring (1) with grease or engine oil before installation.
- Make sure that the oil pump is inserted into the crankcase.
- Apply molybdenum disulfide or grease to the pump pinion.

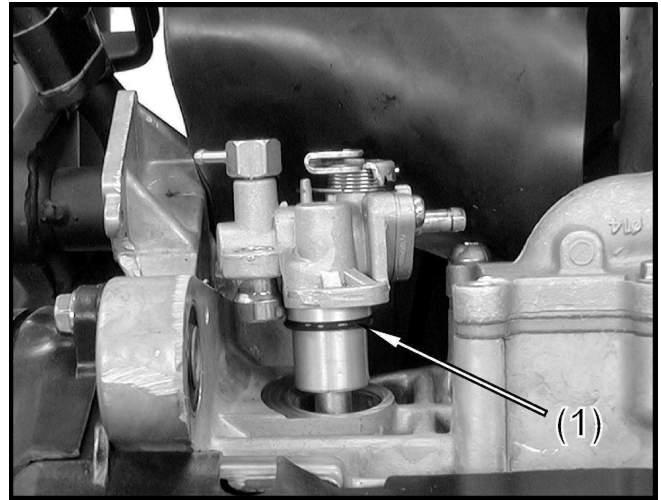

Install the oil pump into the crankcase.  
Install the oil pump control cable plate (1)  
and tighten the two bolts.

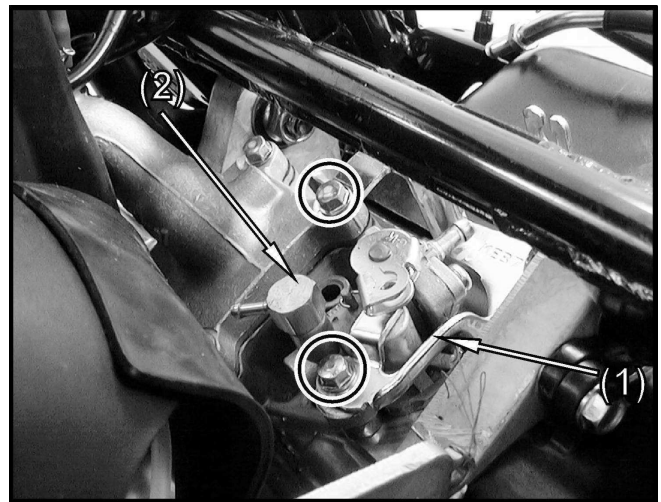

Connect the oil inlet line (1) and oil outlet  
line (2) properly.  
Connect the oil pump control cable (3).  
Bleed air from the oil pump.

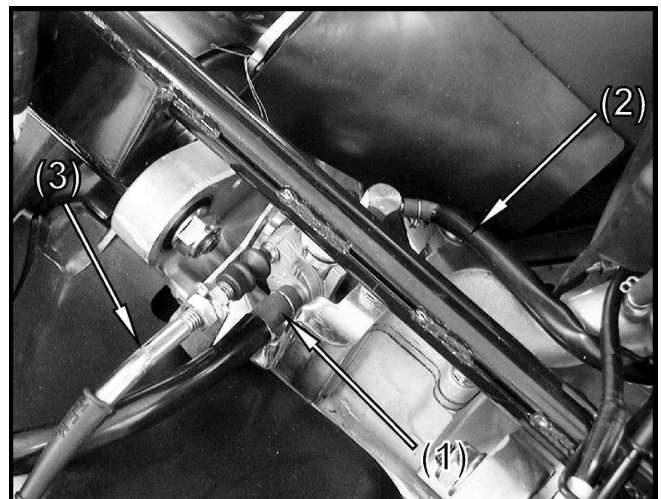

## 4. LUBRICATION SYSTEM

### BLEEDING



- Air in the oil lines will block oil flow and result in severe engine damage.
- Bleed air from the oil lines and oil pump whenever the oil lines or pump have been removed or there is air in the oil lines.

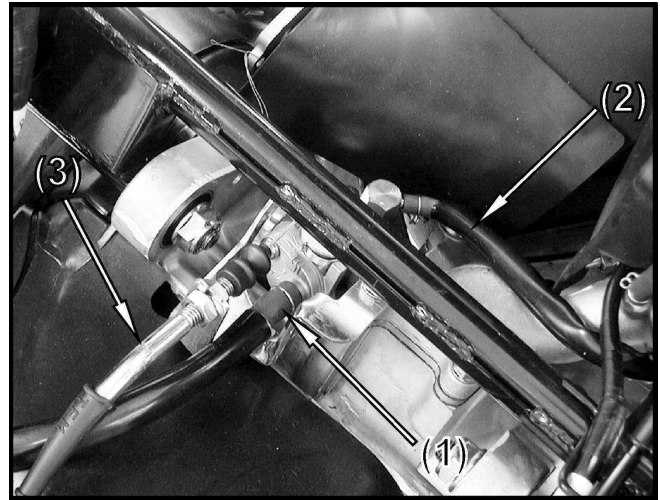

### OIL INLET LINE/OIL PUMP BLEEDING

Fill the oil tank with recommended oil.  
Place a shop towel around the oil pump.  
Disconnect the oil inlet line from the oil pump and clip it.  
Fill the oil pump with oil by squirting clean oil through the joint. (About 3cc)  
Fill the oil line with oil and connect it to the oil pump.



Bleed air from the oil inlet line first, then bleed air from the oil outlet line.

### OIL OUTLET LINE BLEEDING

1. Disconnect the oil outlet line and bend it into U shape. Force air out of the tube by filling it with oil.
2. Start the engine and allow it to idle with the oil control lever in the fully open position. Visually check the oil flow.
3. If there is no oil flowing out within 1 minute, bleed air from the oil inlet line and oil pump.



- Never run the engine in a closed area.
- Do not increase the engine speed at will.

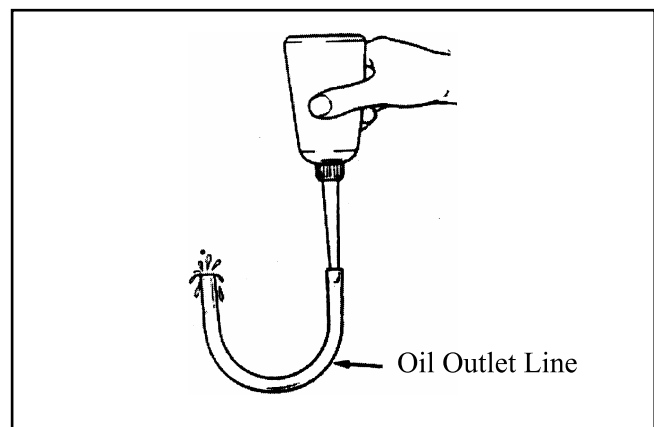

## 4. LUBRICATION SYSTEM

### OIL TANK (2-STROKE)

#### OIL TANK REMOVAL

Remove the rear body cover. (⇒13-6)

Disconnect the oil meter connector (1).  
Remove the two bolts from the oil tank.  
Disconnect the oil inlet line (2).  
Drain the oil inside the oil tank into a clean container.  
Remove the oil tank.  
The installation sequence is the reverse of removal.

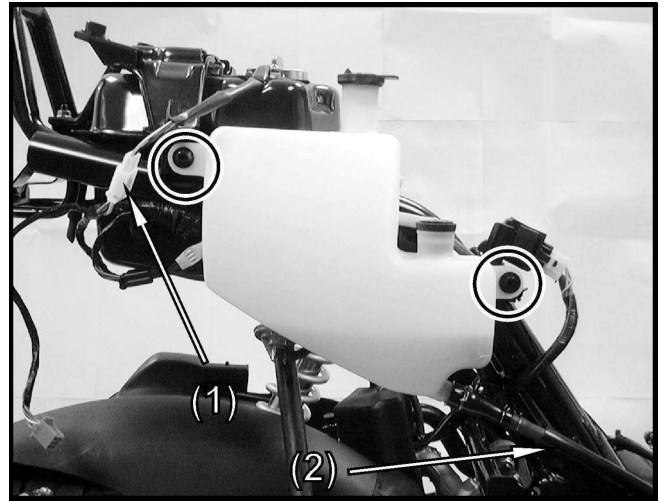

- Connect the oil line properly.
- Bleed air from the oil pump after installation.
- The oil tube clip (at the oil tank side) must be locked from inside of the oil tube joint.

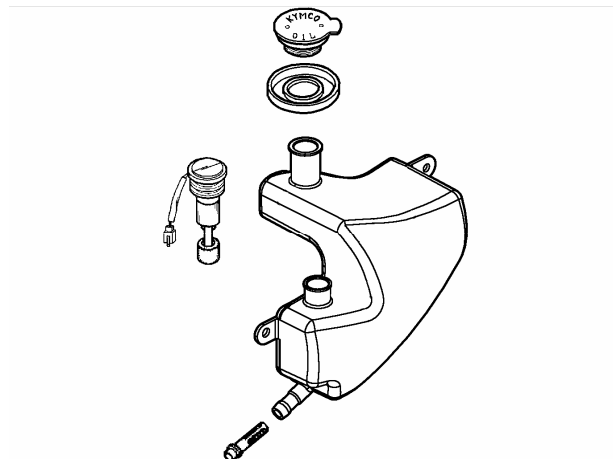

## 4. LUBRICATION SYSTEM

### ENGINE OIL/OIL FILTER

#### (4-STROKE)

#### OIL LEVEL AND OIL CHANGE

Refer to the “ENGINE OIL” section in the chapter 3 to check the oil level and replacement and oil filter cleaning.

### OIL PUMP (4-STROKE)

#### REMOVAL

Place a container under the engine.

Remove the drain plug to drain the oil.  
(⇒3-8)

Remove the A.C. generator flywheel. (⇒8-3)

Remove the A.C. generator stator and pulsar coil. (⇒8-3)

Remove the eight right crankcase cover bolts and the right crankcase cover.

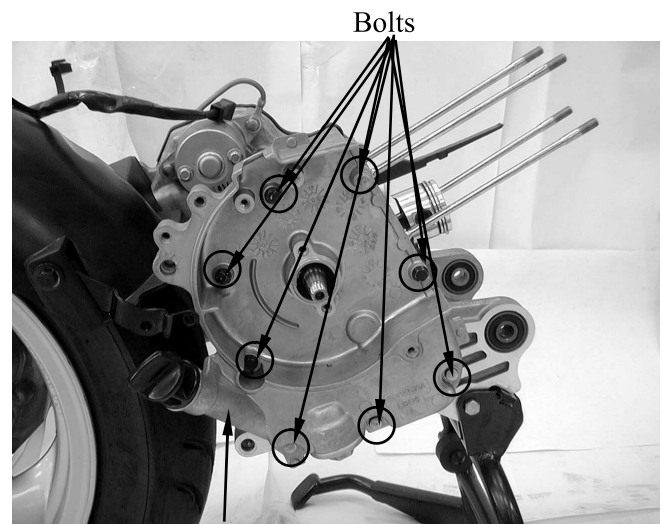

Right Crankcase Cover

Remove the oil pump gear nut and oil pump gear.

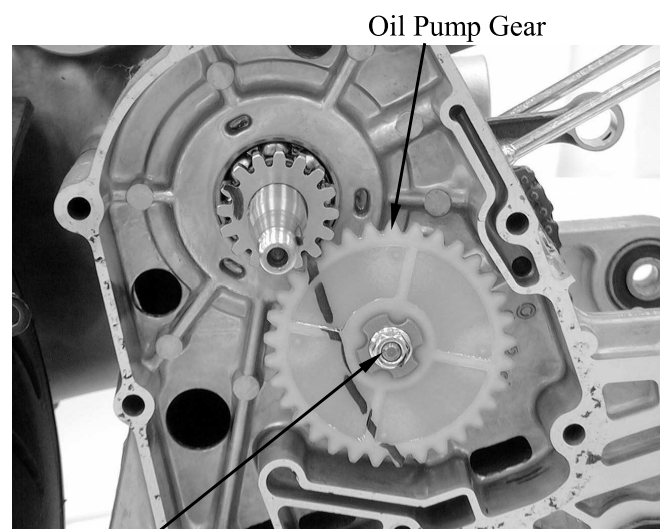

Nut



## 4. LUBRICATION SYSTEM

Remove three oil pump mounting bolts and the oil pump.

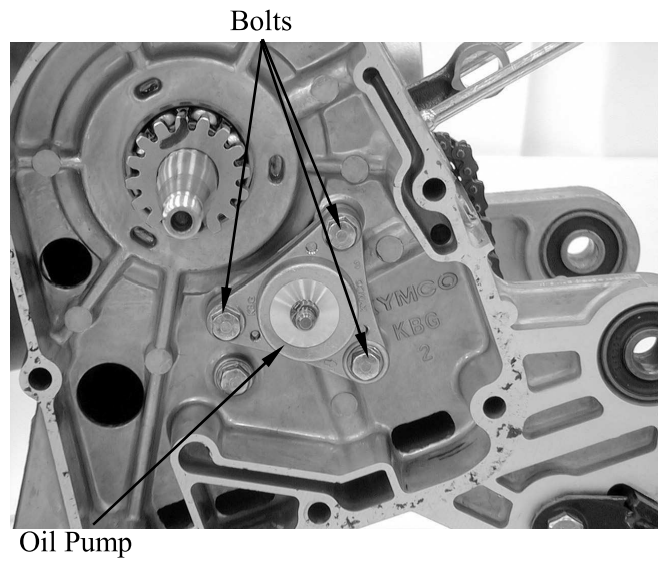

Remove O-rings and dowel pin.

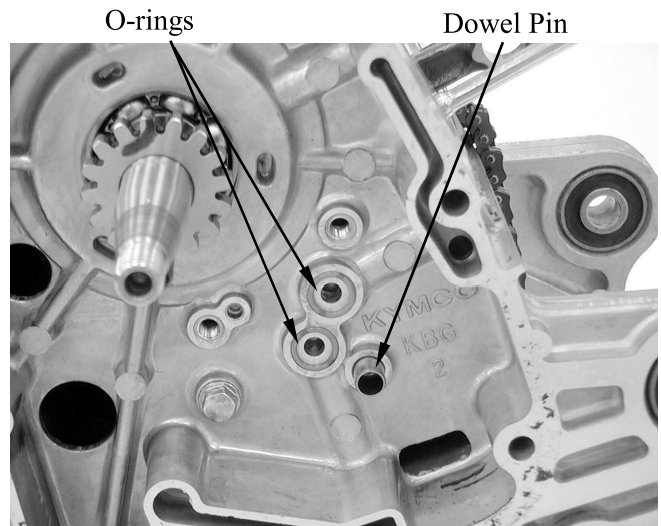

## 4. LUBRICATION SYSTEM

### DISASSEMBLY

Remove the screws and disassemble the oil pump.

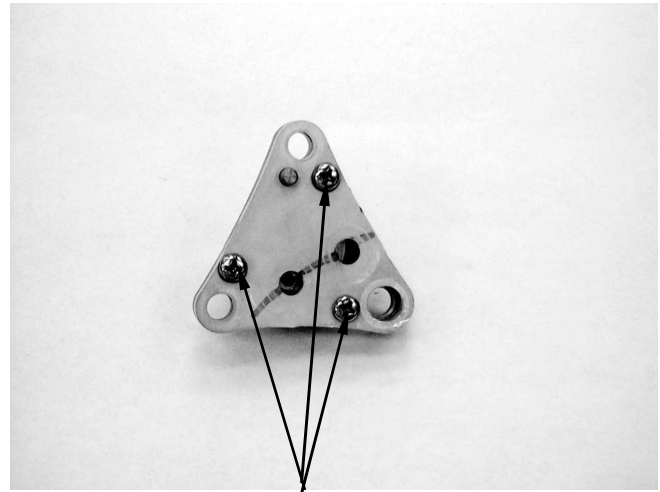

Screws

### INSPECTION

Measure the pump body-to-outer rotor clearance.

**Service Limit:** 0.25mm

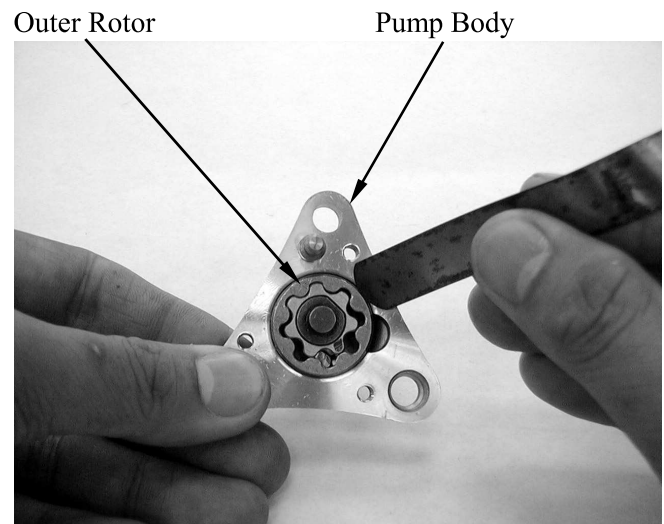

Outer Rotor

Pump Body

Measure the inner rotor-to-outer rotor clearance.

**Service Limit:** 0.2mm

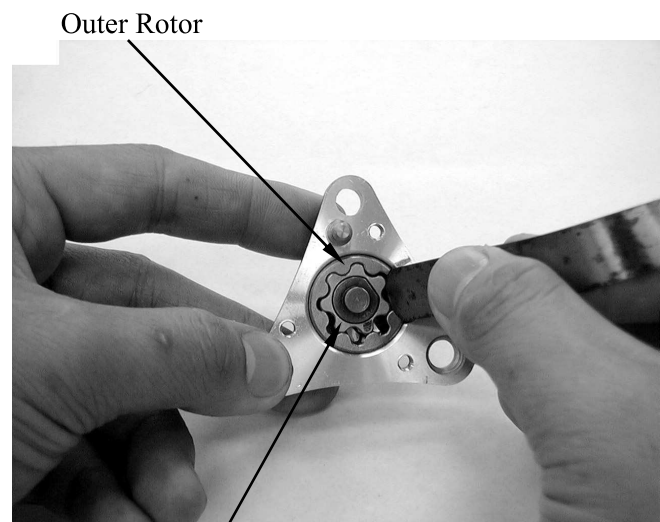

Outer Rotor

Inner Rotor

## 4. LUBRICATION SYSTEM

Measure the rotor end-to-pump body clearance.

**Service Limit:** 0.12mm

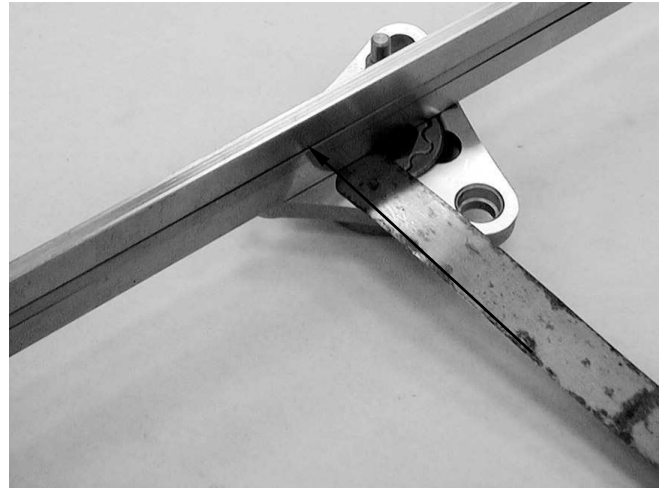

### ASSEMBLY

Install the outer rotor, inner rotor and pump shaft into the pump body.

- Insert the pump shaft by aligning the flat on the shaft with the flat in the inner rotor.

Install the dowel pin.

Install the pump cover by aligning the hole in the cover with the dowel pin.

Tighten the screw to secure the pump cover. Make sure that the pump shaft rotates freely without binding.

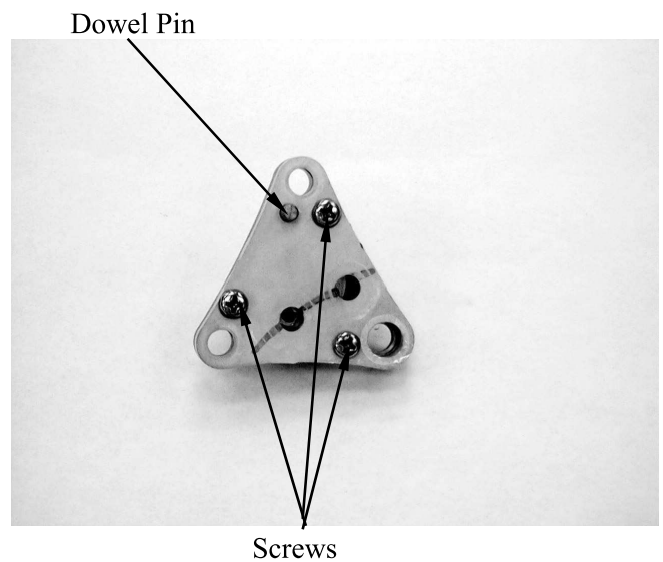

## 4. LUBRICATION SYSTEM

### INSTALLATION

Install the O-rings and dowel pin.

- Inspect the O-rings and replace if damaged.

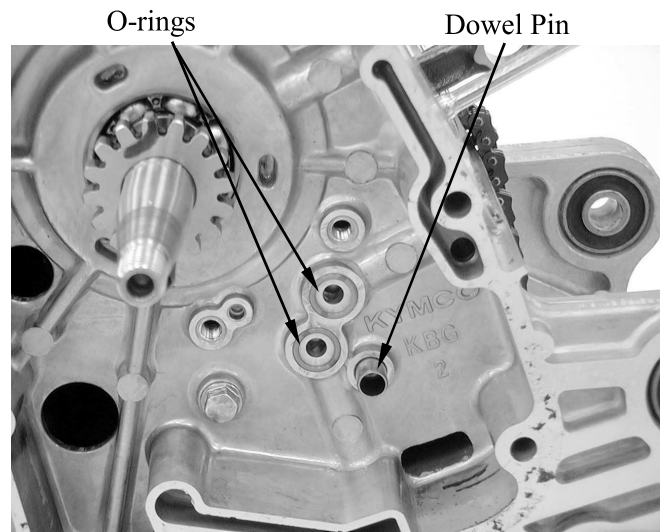

Install the oil pump and tighten the bolts.  
Make sure that the pump shaft rotates freely without binding.

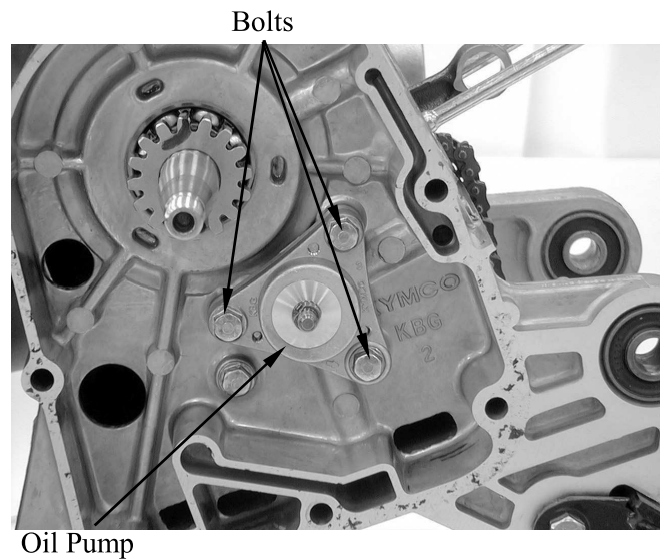

Install the oil pump gear and tighten the nut.

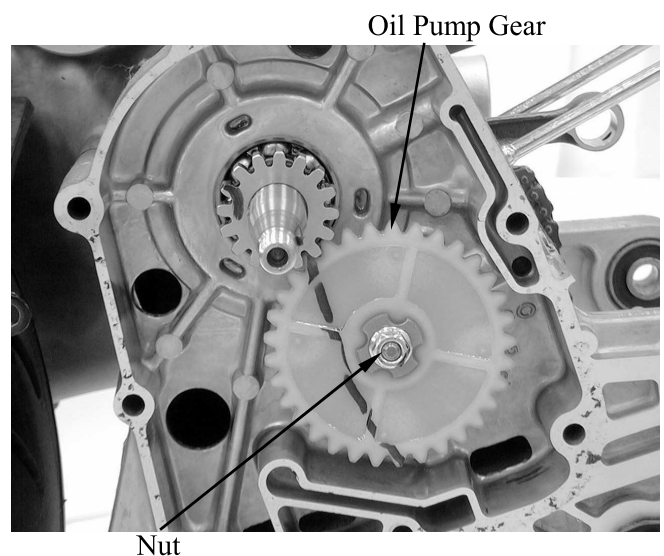

## 4. LUBRICATION SYSTEM

---

Install the right crankcase cover and tighten the bolts.

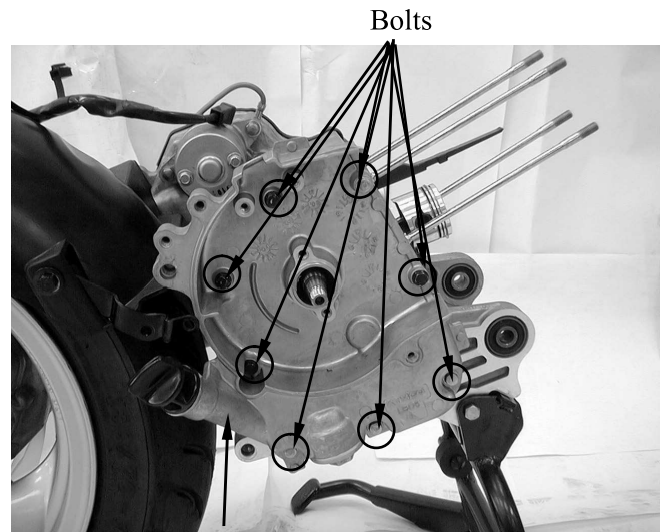

Right Crankcase Cover

## 5. ENGINE REMOVAL/INSTALLATION

---

5

---

### ENGINE REMOVAL/INSTALLATION

---

SERVICE INFORMATION .....	5- 1
ENGINE REMOVAL (2-STROKE).....	5- 2
ENGINE INSTALLATION (2-STROKE) .....	5- 5
ENGINE REMOVAL (4-STROKE).....	5- 6
ENGINE INSTALLATION (4-STROKE) -----	5-10

## **5. ENGINE REMOVAL/INSTALLATION**

---

### **SERVICE INFORMATION**

#### **GENERAL INSTRUCTIONS**

- Parts requiring engine removal for servicing:
  - Crankcase
  - Crankshaft

#### **TORQUE VALUES**

Engine mounting bolt	4.5□5.5kg-m
Rear shock absorber lower mount bolt	2.4□3.0kg-m
Engine hanger bracket bolt	4.5□5.5kg-m

## 5. ENGINE REMOVAL/INSTALLATION

### ENGINE REMOVAL

#### (2-STROKE)

Remove the frame body cover. (⇒13-6)  
 Disconnect the oil pump control cable from the pump body. (⇒4-5)  
 Disconnect the oil inlet line from the oil pump. (⇒4-5)

□ After the oil inlet line is disconnected, plug the oil line opening to prevent oil from flowing out.

Remove the spark plug cap (1).  
 Disconnect the auto bystarter, A.C. generator and starter motor wire connector (2).

Loosen the band screw (1) and remove the two mounting bolts (2), then remove air cleaner housing.

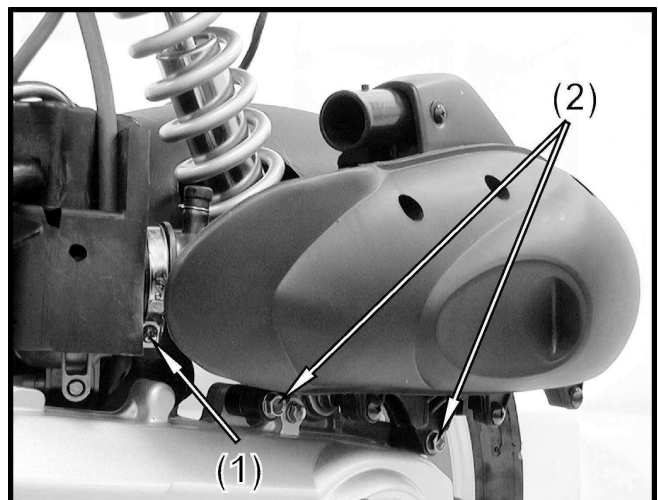
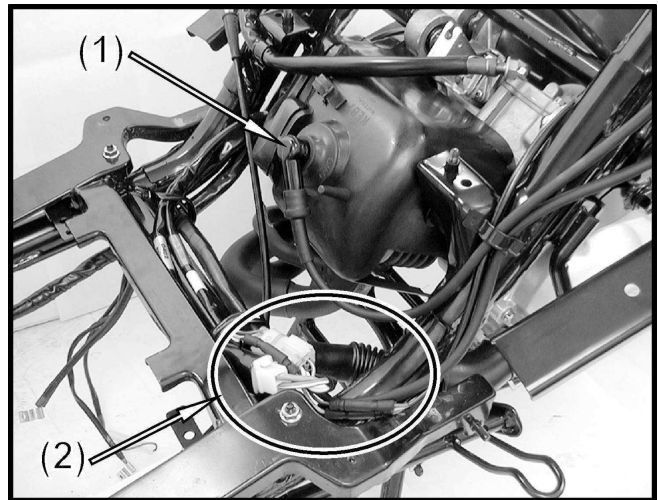

Slide the rubber sleeve up to expose the carburetor.  
 Disconnect the fuel tube (2) from the carburetor.  
 Disconnect the fuel vacuum tube from the intake manifold (3).  
 Loosen the carburetor top (1).  
 Remove the carburetor top and throttle valve from the carburetor. (⇒12-3)

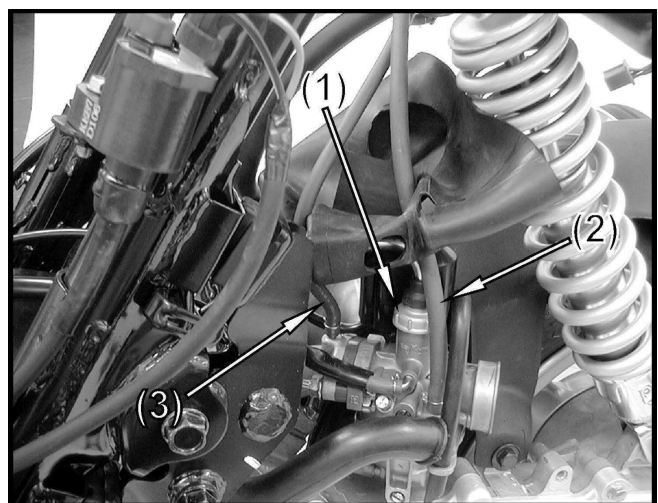



## 5. ENGINE REMOVAL/INSTALLATION

Remove the rear brake adjusting nut (1), brake arm pin (2) and retainer bolt (4) and disconnect the brake cable (3) from the crankcase.

Remove the cooling air tube band (6) from the left crankcase cover and disconnect the cooling air tube.

Remove the rear shock absorber lower mounting bolt (5).

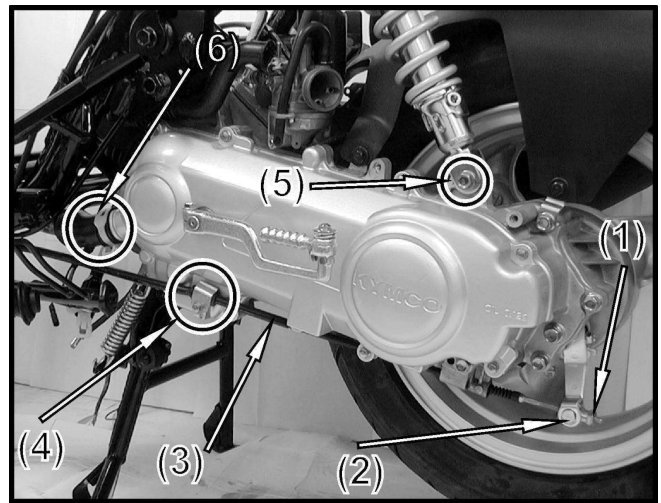

Remove the secondary air hose band (1) from the exhaust muffler and disconnect the secondary air hose.

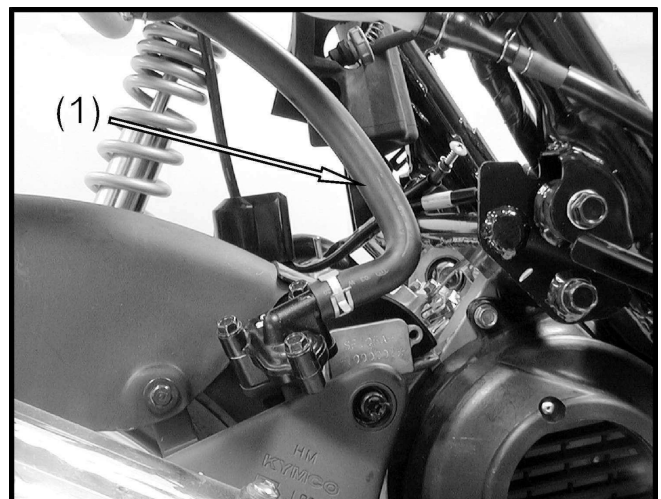

Remove the right and left engine mounting nuts (1).  
Take out the right and left engine mounting bolts.

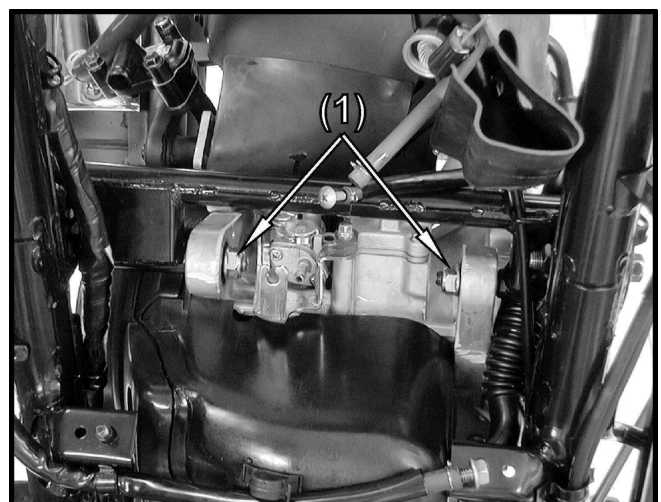

## 5. ENGINE REMOVAL/INSTALLATION

Lift the frame rear upward and move the frame forward to separate it from the engine and be careful not to damage the rear fender.

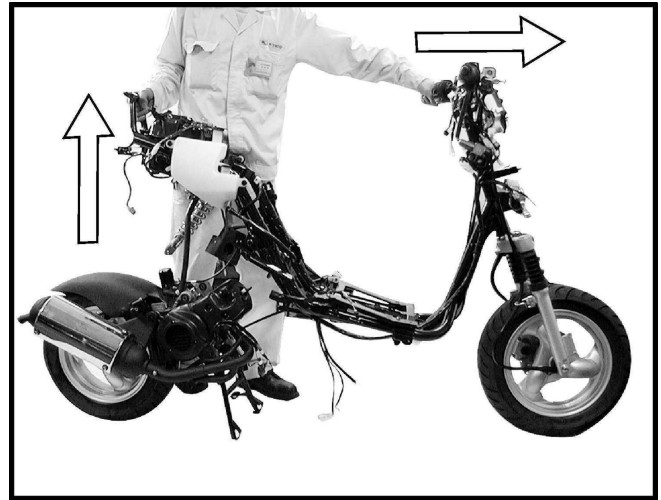

### ENGINE HANGER BRACKET REMOVAL

Remove the engine hanger bracket bolts and engine hanger bracket.  
The installation sequence is the reverse of removal.

**Torque:** 4.5□5.5kg-m



Engine Hanger Bracket Bolt

## 5. ENGINE REMOVAL/INSTALLATION

### ENGINE HANGER BRACKET INSPECTION

Inspect the stopper rubbers and bushings for damage and replace with new ones if necessary.

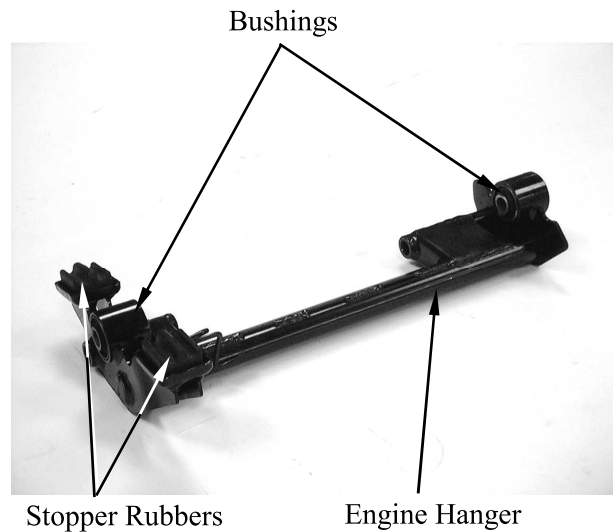

### ENGINE INSTALLATION

Install the engine in the reverse order of removal.

Cables and wires should be routed properly.

#### Torque Values:

Engine mounting bolt : 4.5□5.5kg-m

Rear shock absorber lower mount bolt:  
2.4□3.0kg-m

Perform the following inspections and adjustments after installation.

- Throttle cable
- Oil pump control cable (⇒3-7)
- Rear brake cable (⇒3-2)
- Oil pump bleeding (⇒4-7)

## 5. ENGINE REMOVAL/INSTALLATION

### ENGINE REMOVAL

#### (4-STROKE)

Remove the frame body cover. (⇒13-6)

Disconnect the auto bystarter, A.C. generator and starter motor wire connector

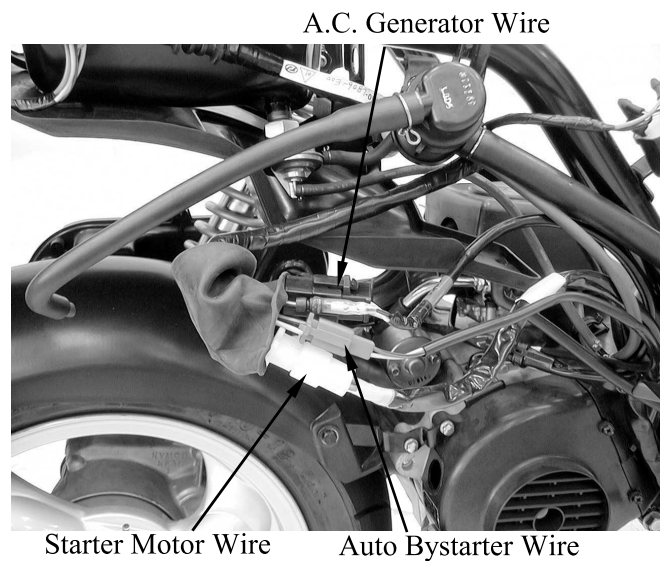

Remove the spark plug cap.  
Disconnect the secondary air apply hose and crankcase breather hose.

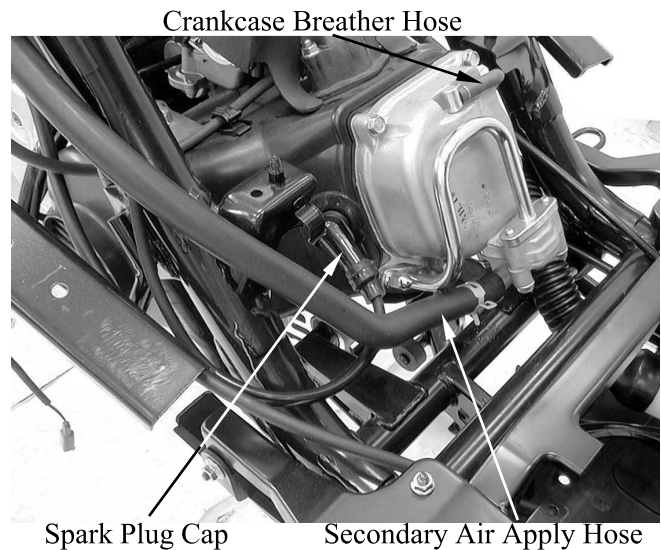

Disconnect vacuum tube.

Loosen the air cleaner connecting tube band screw and intake manifold band screw.

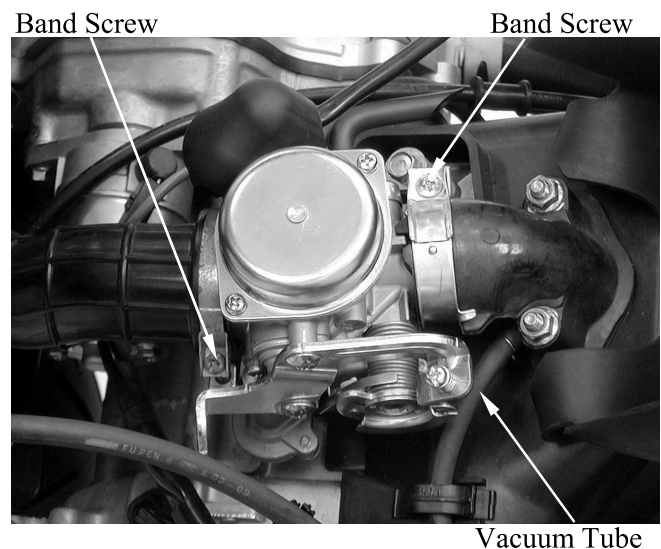

## 5. ENGINE REMOVAL/INSTALLATION

---

Remove the bolts from air cleaner housing.



Bolts

Release the wire band (auto bystarter/A.C. generator/starter motor wire).

Remove the carburetor.

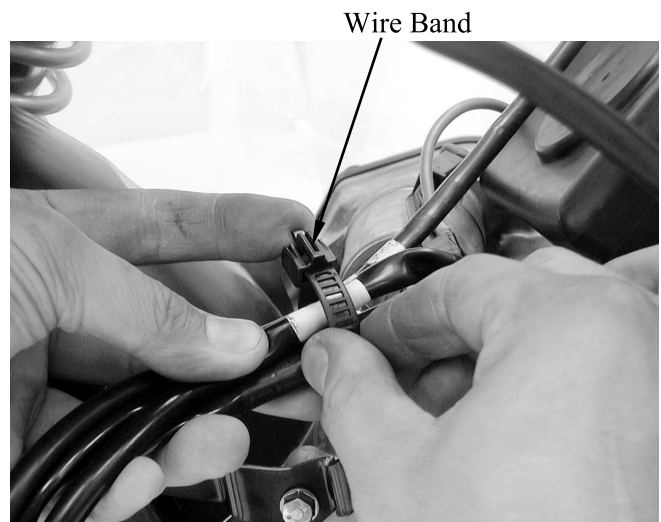

Wire Band

Remove rear brake adjusting nut, arm pin and spring.

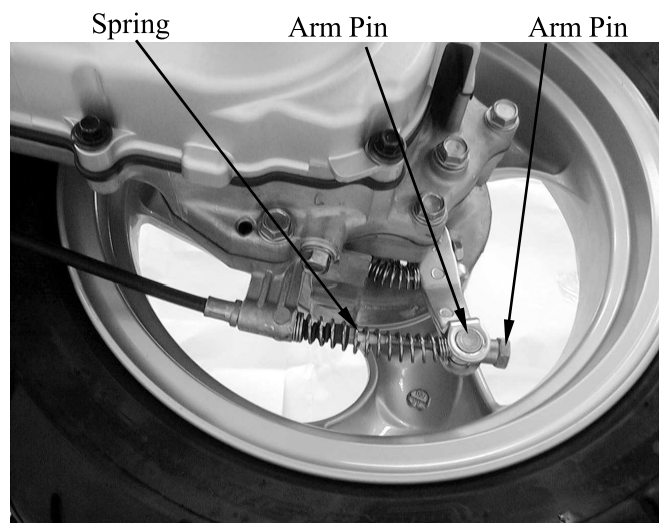

Spring

Arm Pin

Arm Pin

## 5. ENGINE REMOVAL/INSTALLATION

Disconnect the rear brake cable from the transmission cover.

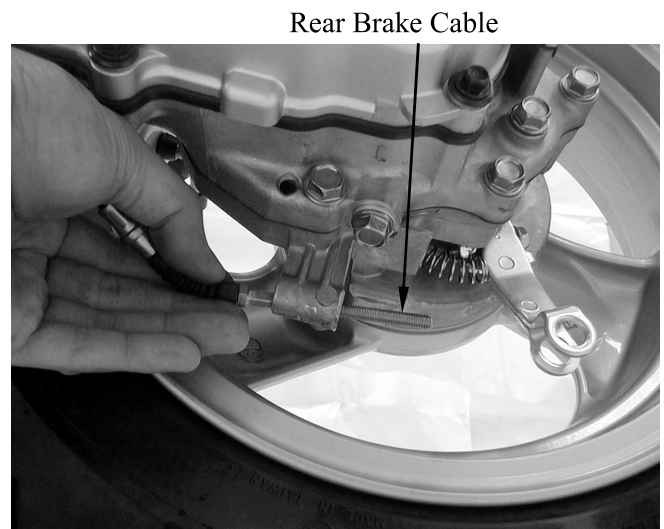

Remove the rear shock absorber lower mount bolt.  
Disconnect the inlet hose.

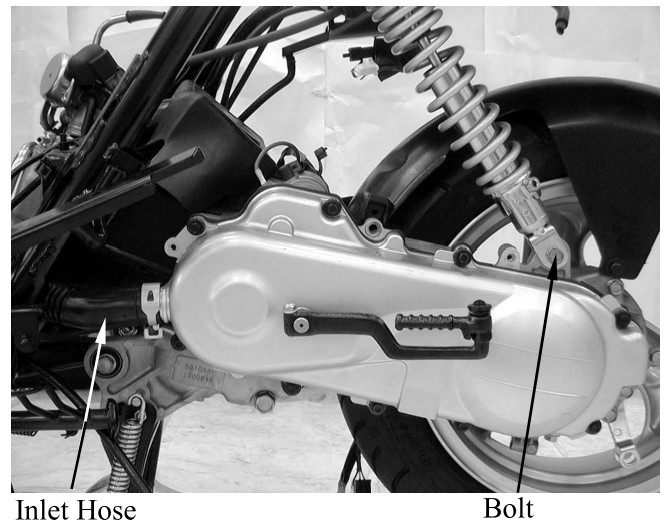

Remove the right and left engine mounting nuts..  
Take out the right and left engine mounting bolts.

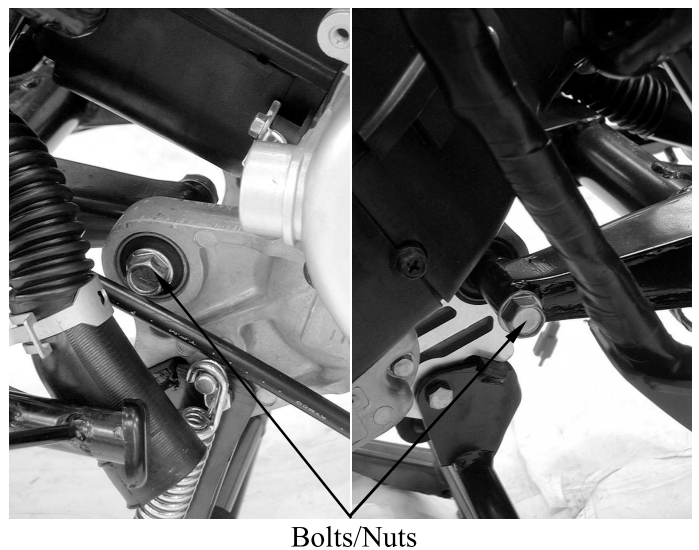

## 5. ENGINE REMOVAL/INSTALLATION

Lift the frame rear upward and move the frame forward to separate it from the engine and be careful not to damage the rear fender.

### ENGINE HANGER BRACKET REMOVAL

Remove the engine hanger bracket nuts.

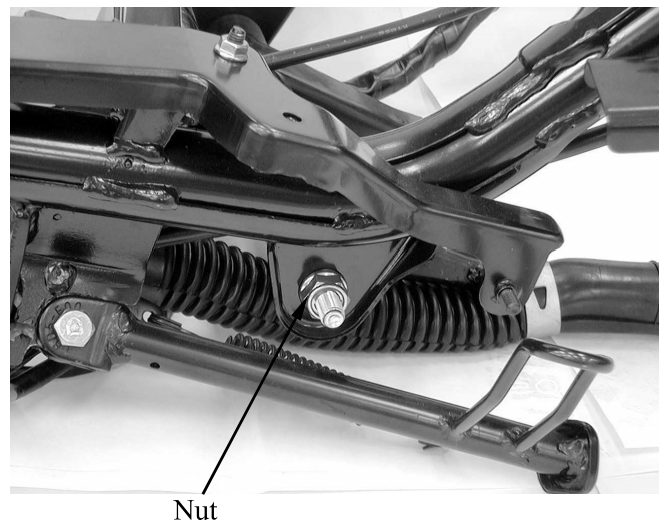

Remove the engine hanger bracket bolts and engine hanger bracket.

The installation sequence is the reverse of removal.

**Torque:** 4.5□5.5kg-m

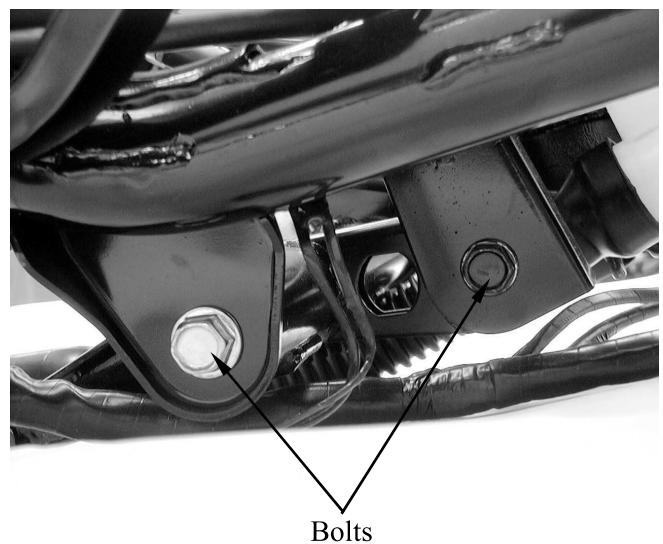

## 5. ENGINE REMOVAL/INSTALLATION

### ENGINE HANGER BRACKET INSPECTION

Inspect the stopper rubbers and bushings for damage and replace with new ones if necessary.

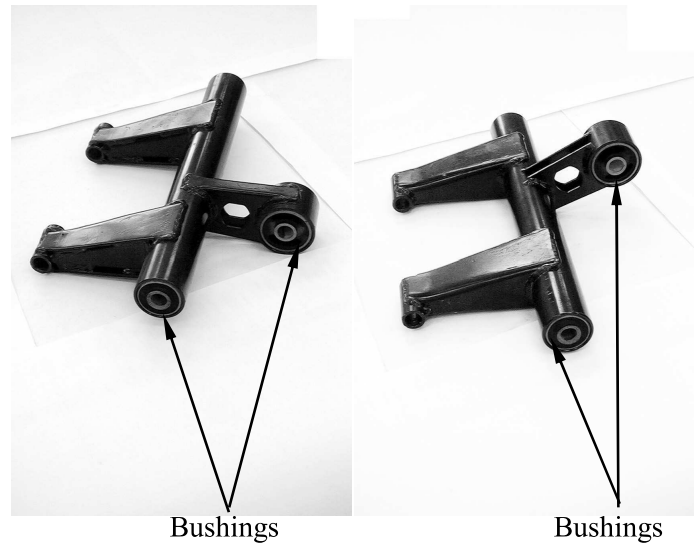

### ENGINE INSTALLATION

Install the engine in the reverse order of removal.

□ Cables and wires should be routed properly.

#### Torque Values:

Engine mounting bolt : 4.5□5.5kg-m

Rear shock absorber lower mount bolt:  
2.4□3.0kg-m

Perform the following inspections and adjustments after installation.

- Rear brake cable (⇒3-2)



**4-STROKE: CYLINDER HEAD/VALVES**

SERVICE INFORMATION-----	6- 2
CYLINDER HEAD COVER-----	6- 4
CAMSHAFT/CAMSHAFT HOLDER-----	6- 4
CYLINDER HEAD-----	6-10

**6. 4-STROKE: CYLINDER HEAD/VALVES**

---

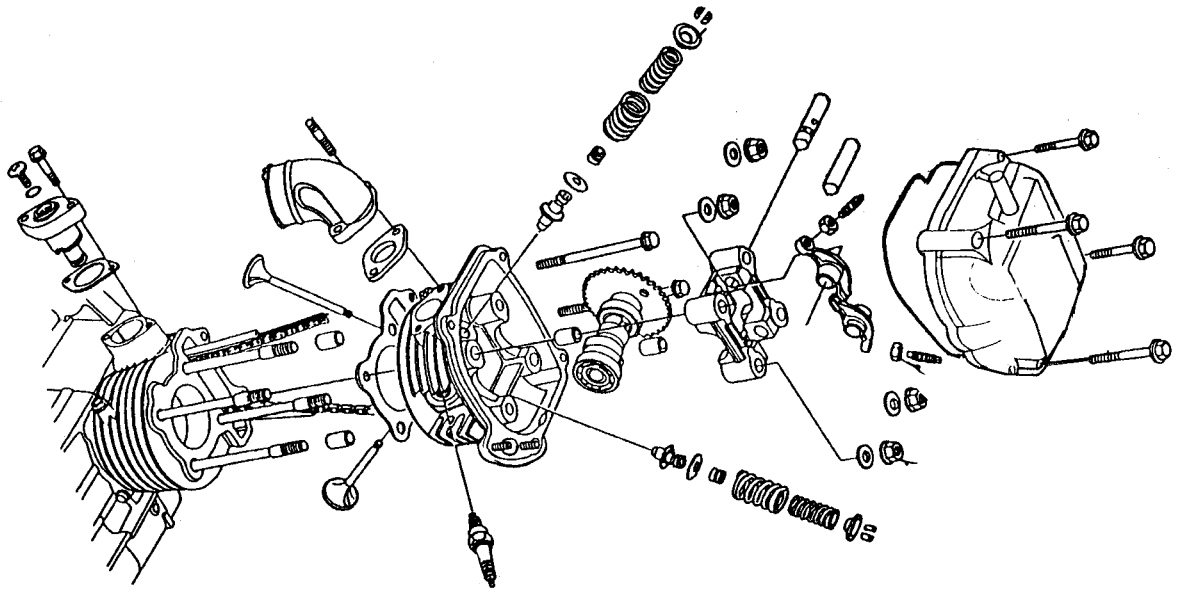

## 6. 4-STROKE: CYLINDER HEAD/VALVES

### SERVICE INFORMATION

#### GENERAL INSTRUCTIONS

- The cylinder head can be serviced with the engine installed in the frame.
- When assembling, apply molybdenum disulfide grease or engine oil to the valve guide movable parts, valve arm and camshaft sliding surfaces for initial lubrication.
- The camshaft is lubricated by engine oil through the cylinder head engine oil passages. Clean and unclog the oil passages before assembling the cylinder head.
- After disassembly, clean the removed parts and dry them with compressed air before inspection.
- After removal, mark and arrange the removed parts in order. When assembling, install them in the reverse order of removal.

#### SPECIFICATIONS

Item		Standard (mm)	Service Limit (mm)
Valve clearance (cold)	IN	0.04	—
	EX	0.04	—
Cylinder head compression pressure		14±2kg/cm <sup>2</sup>	
Cylinder head warpage		—	0.05
Camshaft cam height	IN	25.761	25.65
	EX	25.563	25.45
Valve rocker arm to shaft clearance		0.034~0.09	0.1
Valve stem-to-guide clearance	IN	0.010~0.037	0.06
	EX	0.025~0.052	0.08
Valve spring free length	IN	29.9	28.4
	EX	33.5	31.5
Valve spring compressed force	IN	5~6kg(at 20.45mm)	—
	EX	9.5~11.5kg(at 23.5mm)	—

## 6. 4-STROKE: CYLINDER HEAD/VALVES

---

### TORQUE VALUES

Cylinder head cover bolt	0.8~1.2kgf-m	
Cam shaft hold nut	1.2~1.6kgf-m	Apply engine oil to threads
Tappet adjusting nut	0.7~1.1kgf-m	

### SPECIAL TOOLS

Valve spring compressor	E040
Tappet adjuster	E036

### TROUBLESHOOTING

- The poor cylinder head operation can be diagnosed by a compression test or by tracing engine top-end noises.

#### Poor performance at idle speed

- Compression too low

#### Compression too low

- Incorrect valve clearance adjustment
- Burned or bent valves
- Incorrect valve timing
- Broken valve spring
- Poor valve and seat contact
- Leaking cylinder head gasket
- Warped or cracked cylinder head
- Poorly installed spark plug

#### Compression too high

- Excessive carbon build-up in combustion chamber

#### White smoke from exhaust muffler

- Worn valve stem or valve guide
- Damaged valve stem seal

#### Abnormal noise

- Incorrect valve clearance adjustment
- Sticking valve or broken valve spring
- Damaged or worn camshaft
- Worn cam chain guide
- Worn camshaft and rocker arm

## 6. 4-STROKE: CYLINDER HEAD/VALVES

### CYLINDER HEAD COVER

#### REMOVAL

Remove the rear body cover. (⇒13-6)  
 Disconnect the crankcase breather tube from the cylinder head cover. (⇒5-6)  
 Disconnect the secondary air apply hose from the cylinder head cover. (⇒5-6)

Remove the four bolts and two nuts from the cylinder head cover, then remove the cylinder head cover.

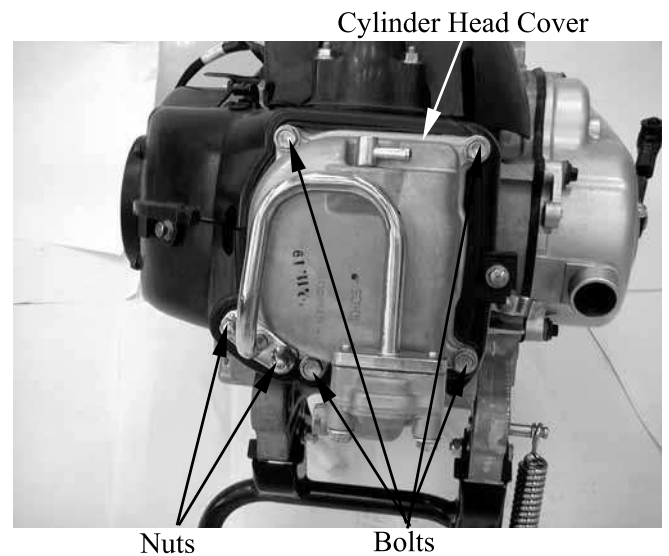

#### INSTALLATION

Install a new cylinder head cover O-ring and gasket.  
 Install the cylinder head cover.  
 Install and tighten the cylinder head cover bolts and nuts.

**Torque:** 0.8~1.2kgf-m

\* Be sure to install the O-ring into the groove properly.

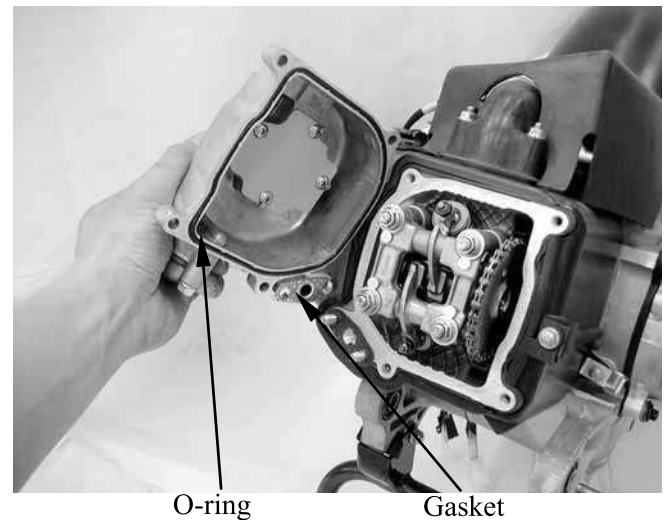

### CAMSHAFT/CAMSHAFT HOLDER

#### REMOVAL

Remove the cylinder head cover. (Refer to the "CYLINDER HEAD COVER REMOVAL")

Remove the cam chain tensioner cap/spring.  
 Remove two bolts and cam chain tensioner.

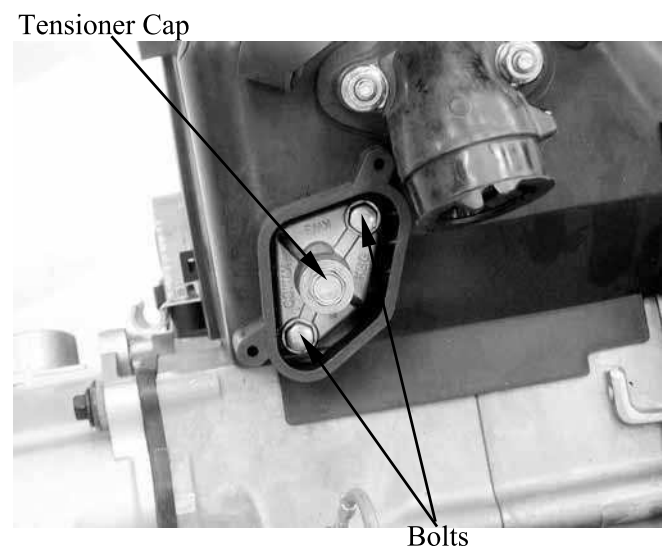

## 6. 4-STROKE: CYLINDER HEAD/VALVES

Turn the cooling fan clockwise so that the “T” mark on the flywheel aligns with the index mark on the crankcase to bring the round hole on the camshaft gear facing up to the top dead center on the compression stroke.

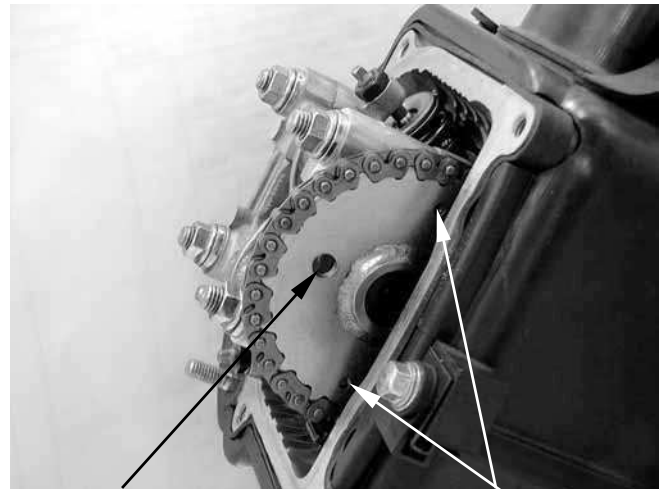

Round Hole

Time Marks

Remove the four camshaft holder nuts and washers.

\* Diagonally loosen the cylinder head nuts in 2 or 3 times.

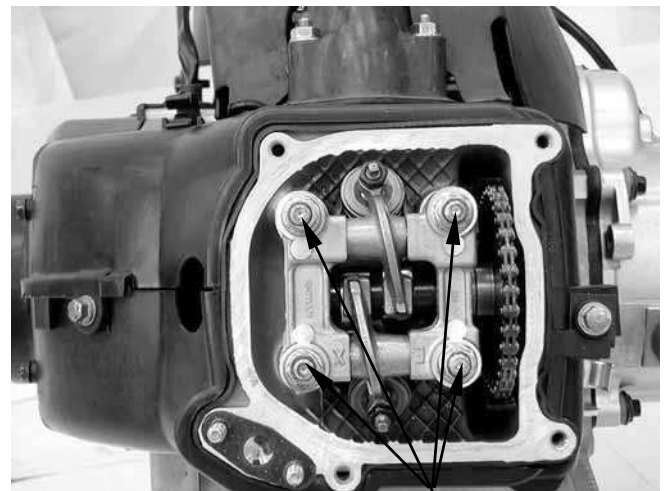

Nuts/Washers

Remove the camshaft holder and dowel pins.

Camshaft Holder

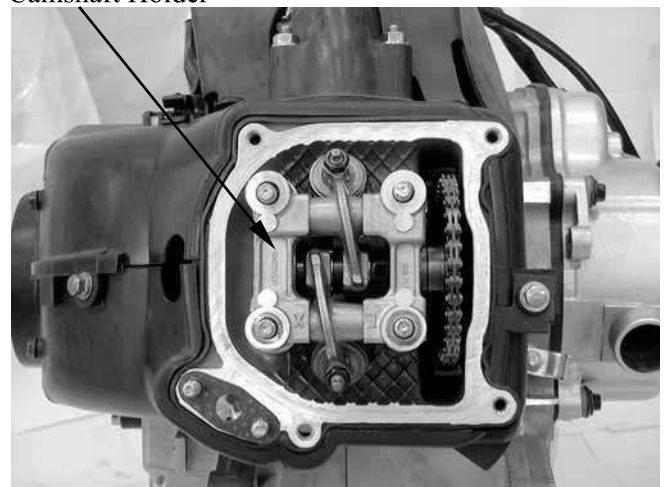

## 6. 4-STROKE: CYLINDER HEAD/VALVES

Remove the camshaft gear from the cam chain and remove the camshaft.

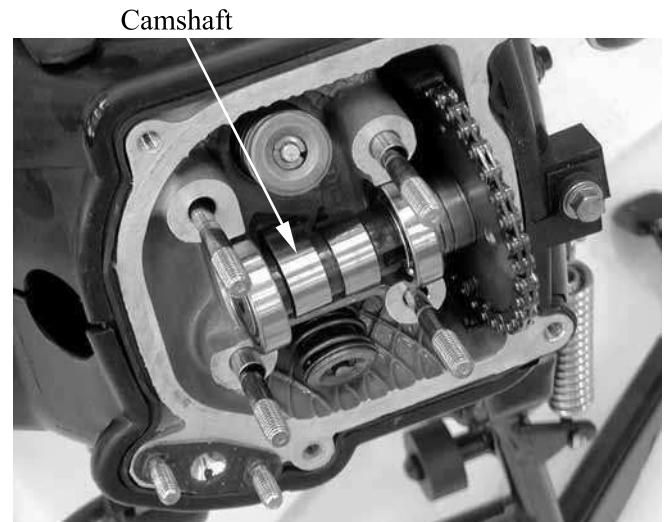

### CAMSHAFT HOLDER DISASSEMBLY

Take out the valve rocker arm shafts using a 5mm bolt.

Remove the valve rocker arms and arm shafts.

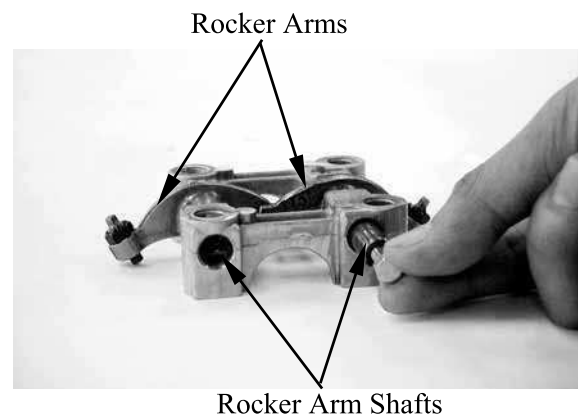

### CAMSHAFT HOLDER INSPECTION

Inspect the camshaft holder for wear or damage.

Inspect the rocker arm shaft for blue discoloration or grooves.

If any defects are found, replace the rocker arm shaft with a new one, then inspect lubrication system.

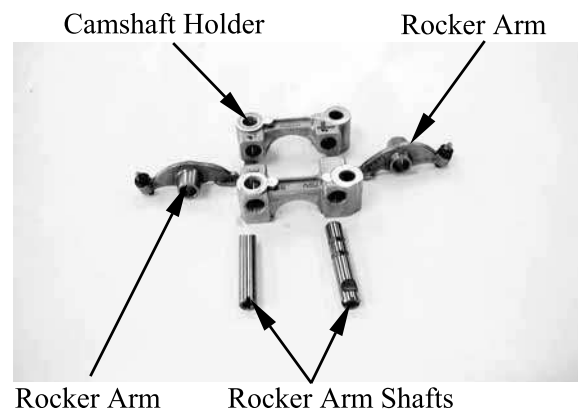

## 6. 4-STROKE: CYLINDER HEAD/VALVES

Inspect the rocker arm bore, cam lobe contact surface and adjuster surface for wear/pitting/scratches/blue discoloration.

If any defects are found, replace the rocker arm shaft with a new one, then inspect lubrication system.

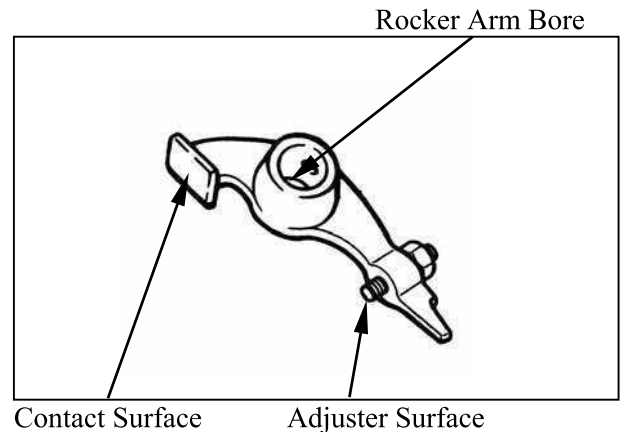

Measure each rocker arm shaft O.D.  
Measure the I.D. of each valve rocker arm.  
Measure arm to shaft clearance.  
Replace as a set if out of specification.

**Service limits:** 0.10mm

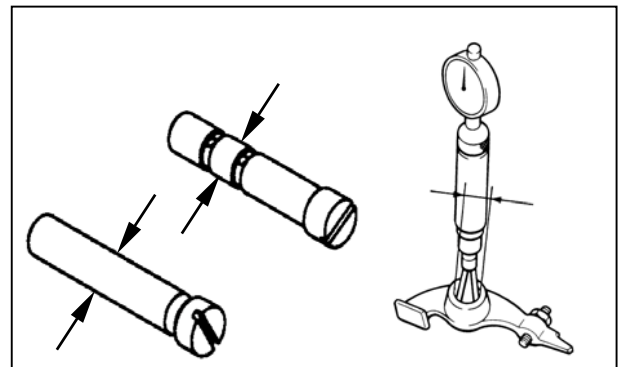

### CAMSHAFT HOLDER ASSEMBLY

Reverse the “CAMSHAFT HOLDER DISASSEMBLY” procedures.

\* Align the cross cutout on the exhaust valve rocker arm shaft with the bolt of the camshaft holder.



## 6. 4-STROKE: CYLINDER HEAD/VALVES

### CAMSHAFT INSPECTION

Check each camshaft bearing for play or damage. Replace the camshaft assembly with a new one if the bearings are noisy or have excessive play.

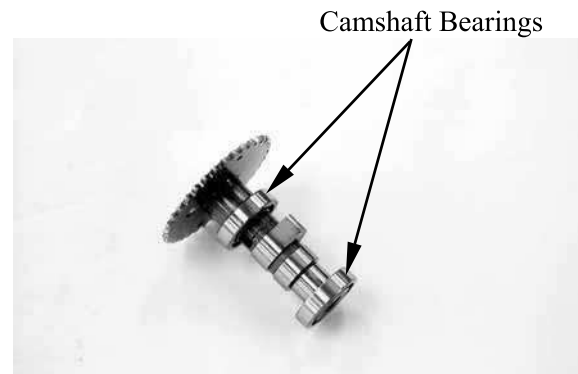

Inspect camshaft lobes for pitting/scratches/blue discoloration.

Measure the cam lobe height.

#### Service Limits:

IN : 25.65mm replace if below

EX: 25.45mm replace if below

If any defects are found, replace the camshaft with a new one, then inspect lubrication system.

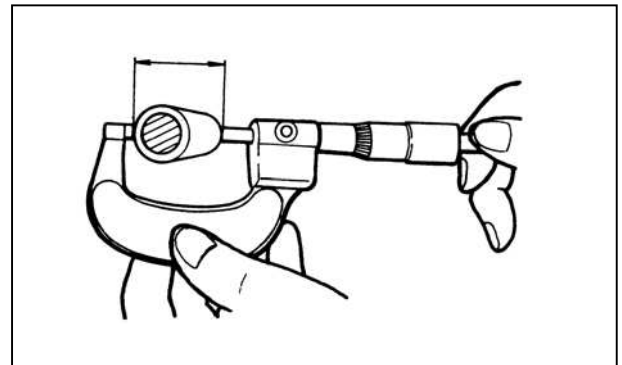

### INSTALLATION

Reverse the "CAMSHAFT REMOVAL" procedures.

Note the following points:

1. Turn the flywheel so that the "T" mark on the flywheel aligns with the index mark on the crankcase.  
Keep the round hole on the camshaft gear facing up and align the index marks on the camshaft gear with the cylinder head surface (Position the intake and exhaust cam lobes down.) and install the camshaft onto the cylinder head. (Refer to the "VALVE CLEARANCE" section in the chapter 3)

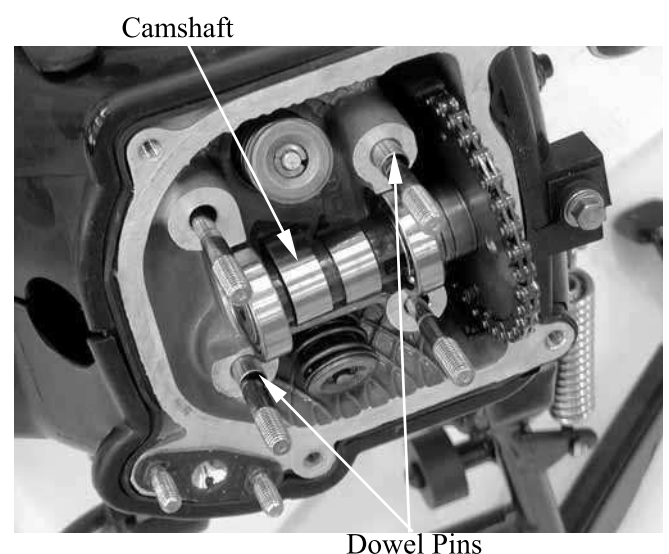

## 6. 4-STROKE: CYLINDER HEAD/VALVES

Install the camshaft dowel pins and holder.

- \*
- Apply engine oil to the threads of the cylinder head nuts.
  - Diagonally tighten the cylinder head nuts in 2~3 times.
  - Position the camshaft holder "EX" mark on the exhaust valve side.

**Torque:**

Cam shaft hold nut: 1.2~1.6kgf-m

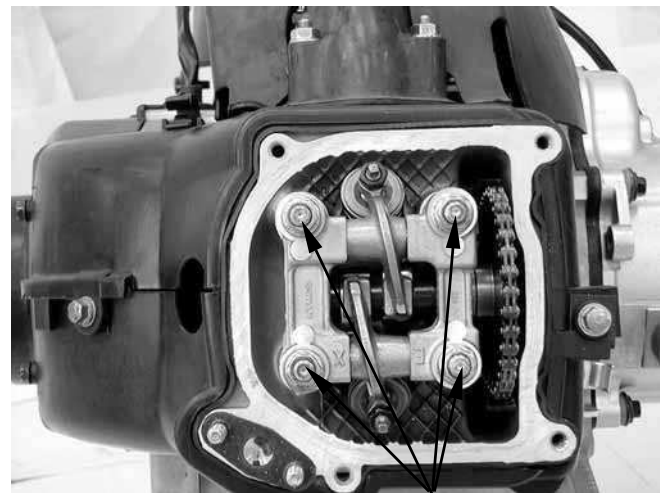

Nuts/Washers

2. Press the tensioner key to release it.

- \*
- Check one-way cam operation (tensioner) for unsmooth operation. If necessary replace the tensioner.

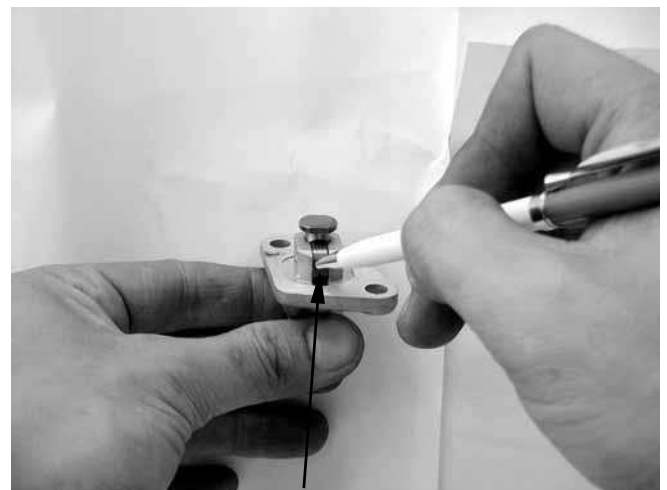

Tensioner Key

Install tensioner to cylinder and gasket.  
Install two bolts and tighten it.

Install spring and tensioner cap, then tighten the tensioner cap.

3. Adjust the valve clearance. (Refer to the "VALVE CLEARANCE" section in the chapter 3)

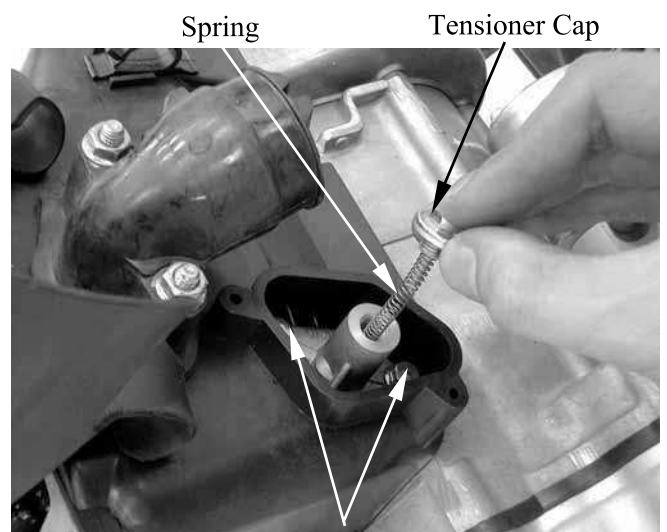

Bolts

## 6. 4-STROKE: CYLINDER HEAD/VALVES

### CYLINDER HEAD

#### REMOVE

Remove the camshaft. (Refer to the “camshaft remove” section in the chapter 6)  
Remove the carburetor. (Refer to the “CARBURETOR REMOVE” section in the chapter 12)  
Remove the exhaust muffler. (Refer to the “EXHAUST MUFFLER REMOVE” section in the chapter 13)

Remove the two nuts and then remove the carburetor intake manifold and insulator.

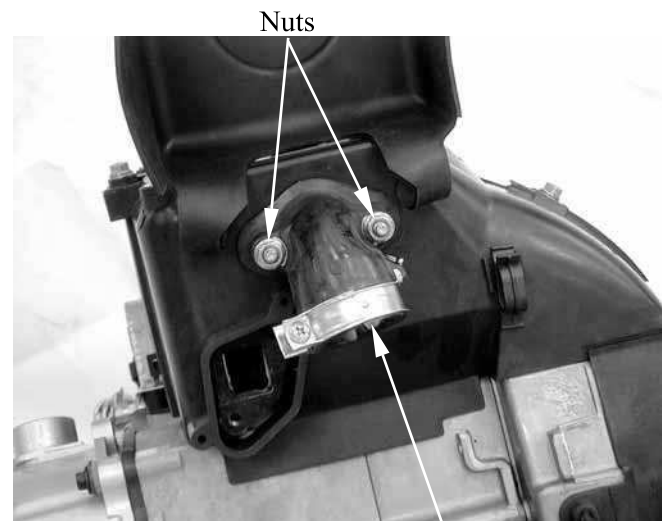

Intake Manifold

Remove the cooling fan cover. (⇒8-3)  
Remove the engine cover bolts and screws.  
Separate the engine cover joint claws.

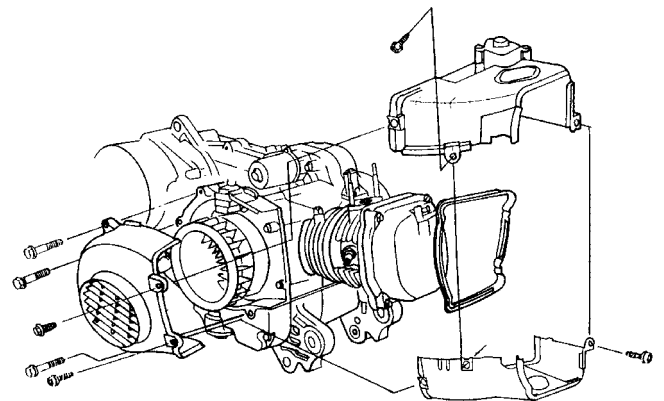

Remove seal shroud, then remove two bolts and cylinder head.



Bolts

## 6. 4-STROKE: CYLINDER HEAD/VALVES

### CYLINDER HEAD DISASSEMBLY

Remove the valve spring cotters, retainers, springs, spring seats, oil seals and valves using a valve spring compressor.

- \* Be sure to compress the valve springs with a valve spring compressor.
- Mark all disassembled parts to ensure correct reassembly.

Special

Valve Spring Compressor E040

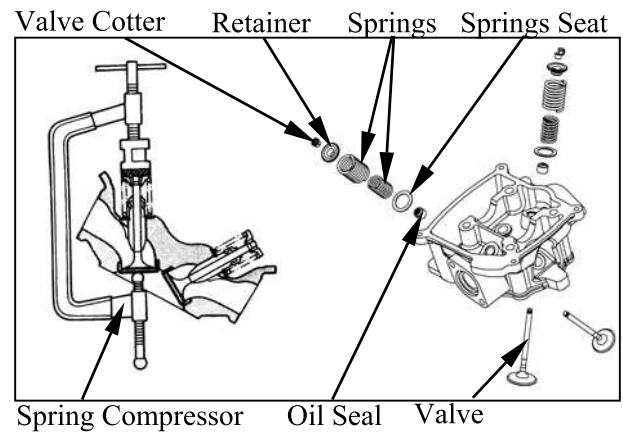

### VALVE/VALVE GUIDE INSPECTION

Inspect each valve for bending, burning, scratches or abnormal stem wear. If any defects are found, replace the valve with a new one.

Check valve movement in the guide.

Measure each valve stem O.D.

Measure each valve guide I.D.

Subtract each valve stem O.D. from the corresponding guide I.D. to obtain the stem-to-guide clearance.

**Service limits:** IN : 0.06mm replace if over  
EX: 0.08mm replace if over

- \* If the stem-to-guide clearance exceeds the service limits, replace the cylinder head as necessary.

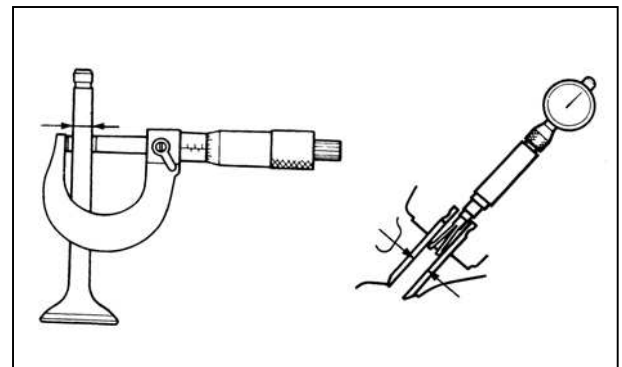

### CYLINDER HEAD INSPECTION

Check the spark plug hole and valve areas for cracks.

Check the cylinder head for warpage with a straight edge and feeler gauge.

**Service Limit:** 0.05mm repair or replace if over

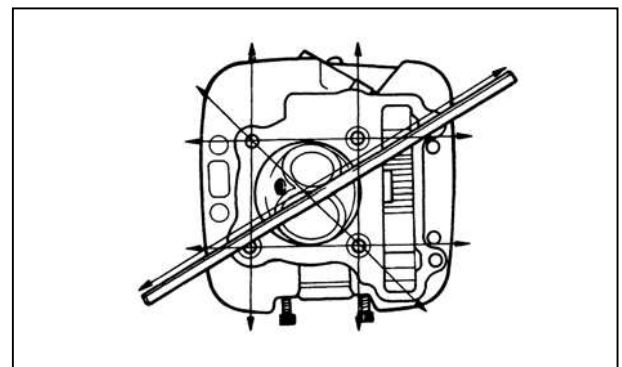

## 6. 4-STROKE: CYLINDER HEAD/VALVES

### VALVE SPRING INSPECTION

Measure the free length of the inner and outer valve springs.

**Service Limit:**

Inner: 28.4mm replace if below

Outer: 31.5mm replace if below

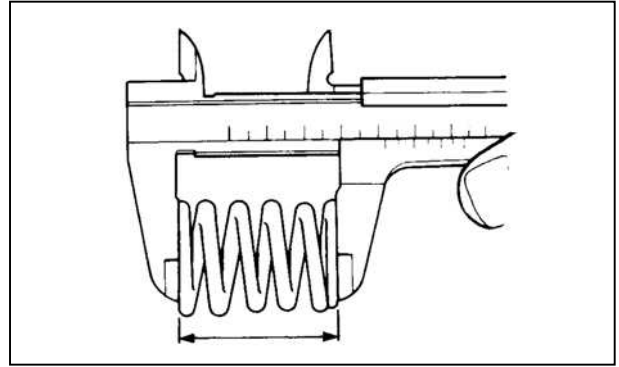

Measure compressed force (valve spring) and installed length.

Replace if out of specification.

**Service limits:**

IN : 5 ~ 6kg(at 20.45mm)

EX : 9.5 ~ 11.5kg(at 23.5mm)

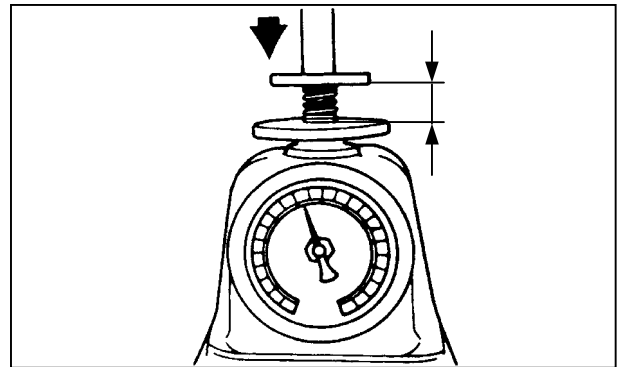

Check the intake manifold and O-rings for wear or damage.



O-ring

## 6. 4-STROKE: CYLINDER HEAD/VALVES

Check the insulator and O-rings for wear or damage.



### ASSEMBLY

Install the valve spring seats and oil seal.

- \* Be sure to install new oil seal.

Lubricate each valve with engine oil and insert the valves into the valve guides. Install the valve springs and retainers.

Compress the valve springs using the valve spring compressor, then install the valve cotters.

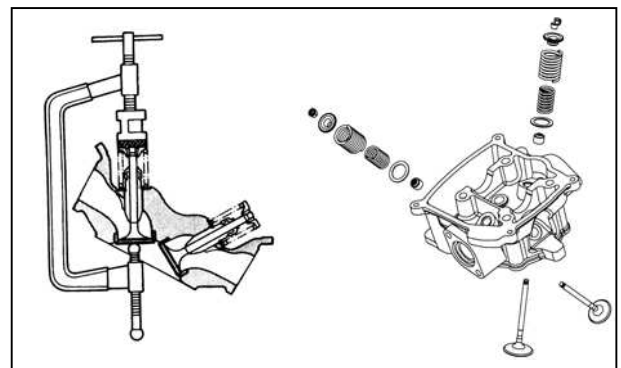

- \*
  - When assembling, a valve spring compressor must be used.
  - Install the cotters with the pointed ends facing down from the upper side of the cylinder head.

**Special**

Valve Spring Compressor E040

Tap the valve stems gently with a plastic hammer for 2~3 times to firmly seat the cotters.

- \* Be careful not to damage the valves.



## **6. 4-STROKE: CYLINDER HEAD/VALVES**

### **INSTALLATION**

Install the dowel pins and a new cylinder head gasket.

Reverse the “CYLINDER HEAD REMOVAL” procedures.

### **Torque:**

Cylinder head bolt: 0.8~1.2kgf-m

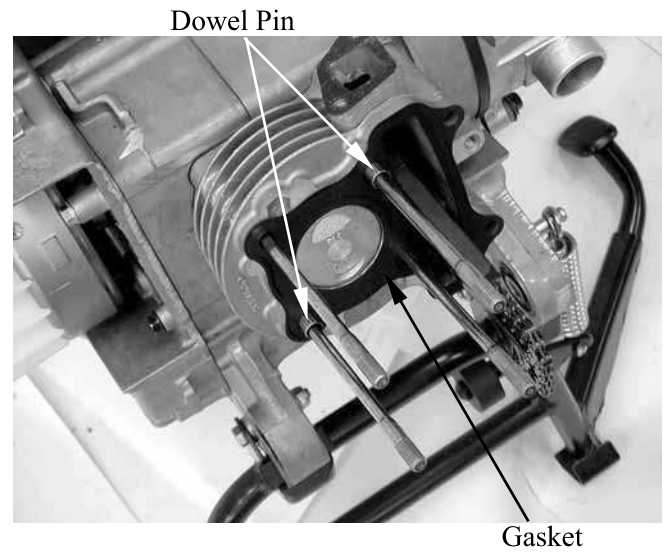

---

**CYLINDER HEAD(2-STROKE)/CYLINDER/PISTON**

---

SERVICE INFORMATION (2-STROKE).....	7- 3
SERVICE INFORMATION (4-STROKE).....	7- 4
CYLINDER HEAD (2-STROKE) .....	7- 5
CYLINDER/PISTON (2-STROKE) .....	7- 8
CYLINDER/PISTON (4-STROKE) -----	7-13





# 7. CYLINDER HEAD (2-STROKE)/ CYLINDER/PISTON

(4-STROKE)

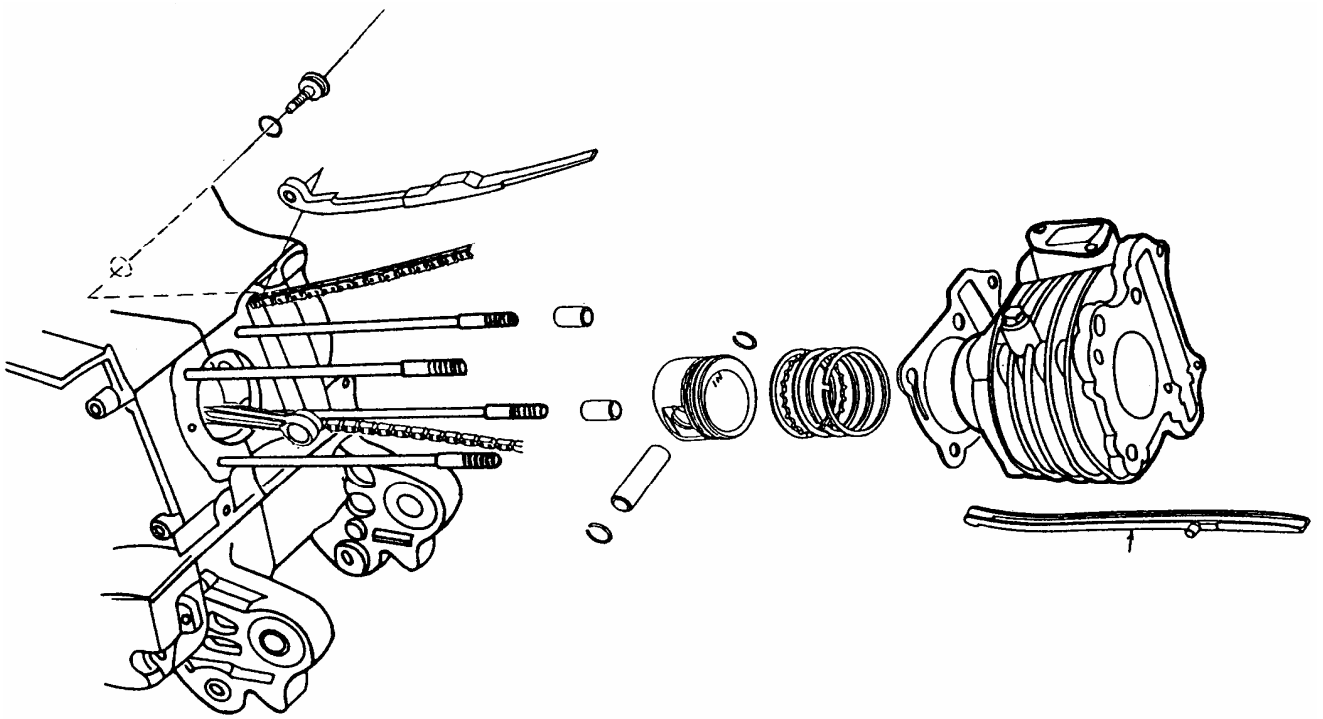

## 7. CYLINDER HEAD (2-STROKE)/ CYLINDER/PISTON



### SERVICE INFORMATION (2-STROKE)

#### GENERAL INSTRUCTIONS

- The cylinder head, cylinder and piston can be serviced with the engine installed in the frame.
- Before disassembly, clean the engine to prevent dust from entering the engine.
- Remove all gasket material from the mating surfaces.
- Do not use a driver to pry between the cylinder and cylinder head, cylinder and crankcase.
- Do not damage the cylinder inside and the piston surface.
- After disassembly, clean the removed parts before inspection. When assembling, apply the specified engine oil to movable parts.

SPECIFICATIONS	Standard (mm)	Service Limit (mm)
Item	2-Stroke	
Cylinder head warpage	—	0.10
Piston O.D.(5mm from bottom of piston skirt)	38.970□38.955	38.90
Cylinder-to- piston clearance	—	0.10
Piston pin hole I.D.	12.002□12.008	12.03
Piston pin O.D.	11.994□12.0	11.98
Piston-to-piston pin clearance	—	0.03
Piston ring end gap (top/second)	0.10□0.25	0.40
Connecting rod small end I.D.	17.005□17.017	17.03
Cylinder bore	39.0□39.025	39.05

#### TORQUE VALUES

Cylinder head bolt	1.0□1.2kg-m
Exhaust muffler joint lock nut	1.0□1.4kg-m
Exhaust muffler lock bolt	3.0□3.6kg-m
Spark plug	1.1□1.7kg-m

#### TROUBLESHOOTING

##### Compression too low, hard starting or poor performance at low speed

- Leaking cylinder head gasket
- Loose spark plug
- Worn, stuck or broken piston and piston rings
- Worn or damaged cylinder and piston

##### Compression too high, overheating or knocking

- Excessive carbon build-up in cylinder head or on piston head

##### Abnormal noisy piston

- Worn cylinder and piston
- Worn piston pin or piston pin hole
- Worn connecting rod small end bearing

##### Abnormal noisy piston rings

- Worn, stuck or broken piston rings
- Worn or damaged cylinder

## 7. CYLINDER HEAD (2-STROKE)/ CYLINDER/PISTON

### SERVICE INFORMATION (4-STROKE)

#### GENERAL INSTRUCTIONS

- The cylinder and piston can be serviced with the engine installed in the frame.
- Before disassembly, clean the engine to prevent dust from entering the engine.
- Remove all gasket material from the mating surfaces.
- Do not use a driver to pry between the cylinder and cylinder head, cylinder and crankcase.
- Do not damage the cylinder inside and the piston surface.
- After disassembly, clean the removed parts before inspection. When assembling, apply the specified engine oil to movable parts.

#### SPECIFICATIONS

		Standard (mm)	Service Limit (mm)	
Cylinder	I.D.	39.00□39.01	39.1	
	Warpage	—	0.05	
	Cylindricity	—	0.05	
	True roundness	—	0.05	
Piston, piston ring	Ring-to-groove clearance	Top	0.015□0.055	0.09
		Second	0.015□0.055	0.09
	Ring end gap	Top	0.15□0.3	0.5
		Second	0.3□0.45	0.65
		Oil ring	0.2□0.7	0.9
	Piston O.D.		38.975□38.99	38.9
	Piston O.D. measuring position		4.5mm from bottom of skirt	—
	Piston-to-cylinder clearance		0.010□0.040	0.1
Piston pin hole I.D.		13.002□13.008	13.04	
Piston pin O.D		12.994□13.000	12.96	
Piston-to-piston pin clearance		0.002□0.014	0.02	
Connecting rod small end I.D. bore		13.016□13.034	13.06	

#### TROUBLESHOOTING

- When hard starting or poor performance at low speed occurs, check the crankcase breather for white smoke. If white smoke is found, it means that the piston rings are worn, stuck or broken.

#### Compression too low or uneven compression

- Worn, stuck or broken piston rings
- Worn or damaged cylinder and piston

#### Compression too high

- Excessive carbon build-up in combustion chamber or on piston head

#### Excessive smoke from exhaust muffler

- Worn or damaged piston rings
- Worn or damaged cylinder and piston

#### Abnormal noisy piston

- Worn cylinder, piston and piston rings
- Worn piston pin hole and piston pin

## 7. CYLINDER HEAD (2-STROKE)/ CYLINDER/PISTON

### CYLINDER HEAD (2-STROKE)

#### REMOVAL

Remove the rear body cover. (⇒13-6)

Remove the spark plug cap

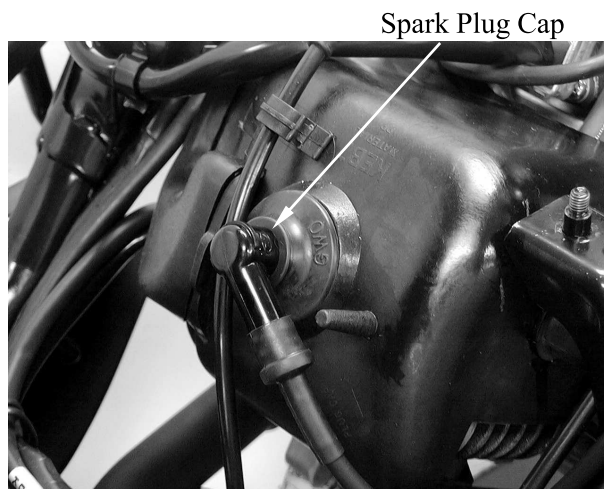

Remove the fan cover. (⇒8-3)

Remove the exhaust muffler. (⇒13-10)

Remove the bolt from the engine hood, then  
remove the engine hood.



Remove the spark plug.

Remove the cylinder head bolts and the  
cylinder head.



Loosen the bolts diagonally in 2 or 3  
times.

Remove the cylinder head gasket.

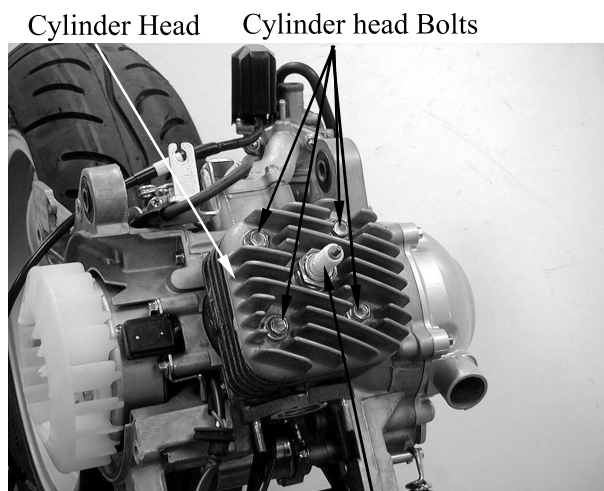

## 7. CYLINDER HEAD (2-STROKE)/ CYLINDER/PISTON

### COMBUSTION CHAMBER DECARBONIZING

Remove the carbon deposits from the combustion chamber

Avoid damaging the combustion chamber wall and cylinder mating surface.

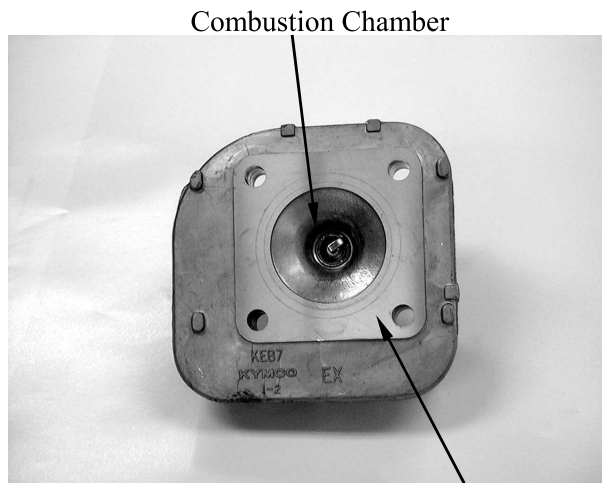

Mating Surface

### CYLINDER HEAD INSPECTION

Check the cylinder head for warpage with a straight edge and feeler gauge.

**Service Limit:** 0.10mm replace if over



### CYLINDER HEAD INSTALLATION

Install a new cylinder head gasket onto the cylinder.

Install the cylinder head on the cylinder properly.

Be careful not to damage the mating surfaces.

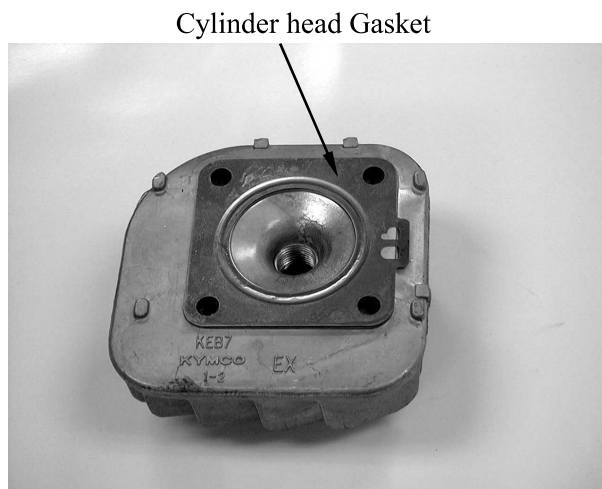

## 7. CYLINDER HEAD (2-STROKE)/ CYLINDER/PISTON

### Cylinder Head Bolts Installation

Install and tighten the cylinder head bolts diagonally in 2 or 3 times.

**Torque:** 1.0□1.2kg-m

Install the spark plug.

**Torque:** 1.1□1.7kg-m

Cylinder head Bolts      Spark Plug

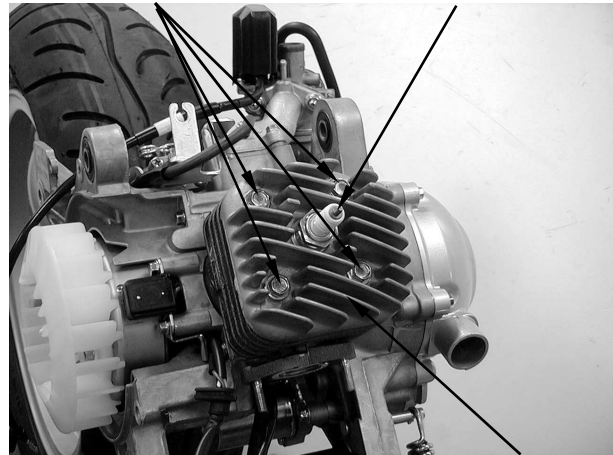

Cylinder Head

### Engine Hood Installation

Install the engine hood. (⇒7-5)

Install the spark plug cap. (⇒7-5)

Remove the exhaust muffler. (⇒13-10)

Perform the following inspections after installation:

- Compression test
- Abnormal engine noise
- Cylinder air leaks

Spark Plug

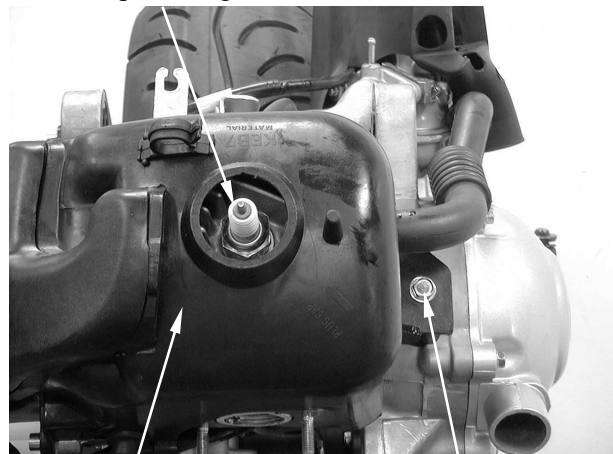

Engine Hood

Bolt



Bolts

## 7. CYLINDER HEAD (2-STROKE)/ CYLINDER/PISTON

### CYLINDER/PISTON (2-STROKE)

#### CYLINDER REMOVAL

Remove the cylinder head. (⇒7-5)  
Remove the exhaust muffler. (⇒13-10)

Remove the cylinder.  
Remove the cylinder gasket.

- Do not pry between the cylinder and crankcase or strike the fins.

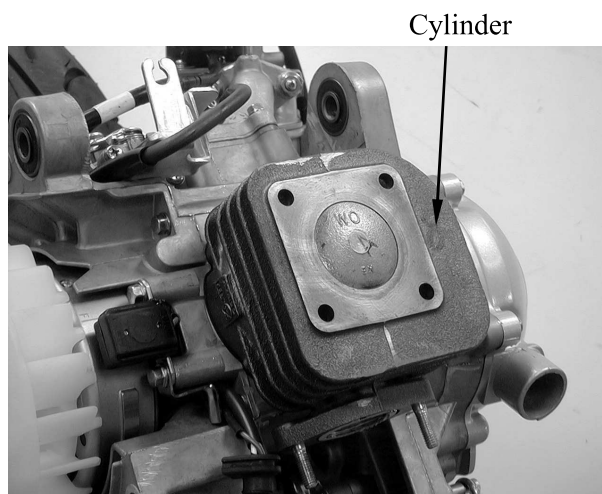

#### PISTON REMOVAL

Remove the piston pin clip to remove the piston pin and piston.

- - Do not damage or scratch the piston.
  - Do not apply side force to the connecting rod when removing the piston pin.
  - Place clean shop towels in the crankcase to keep the piston pin clip from falling into the crankcase.

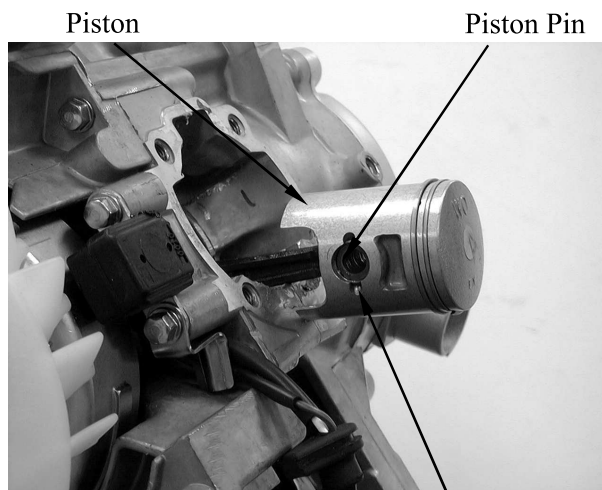

Piston Pin Clip

Spread each piston ring and remove by lifting it up at a point just opposite the gap.  
Remove the expander.





## 7. CYLINDER HEAD (2-STROKE)/ CYLINDER/PISTON

### CYLINDER/PISTON INSPECTION

Check the cylinder and piston for wear or damage.

Clean carbon deposits from the exhaust port area.



Be careful not to damage the cylinder inside wall.



Measure the cylinder bore at three levels of A, B and C in both X and Y directions. Avoid the port area. Take the maximum figure measured to determine the cylinder bore.

**Service Limit:** 39.05mm replace if over

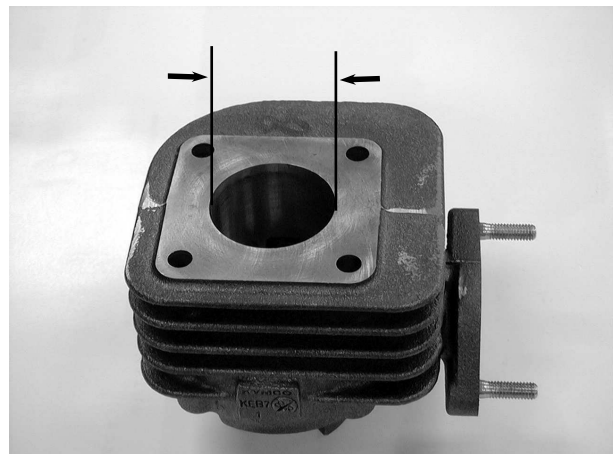

Inspect the top of the cylinder for warpage.

**Service Limit:** 0.10mm replace if over



## 7. CYLINDER HEAD (2-STROKE)/ CYLINDER/PISTON

□ The cylinder has a “A” mark or no mark on it. When replacing the cylinder with a new one, use a cylinder having the same mark as the old one.

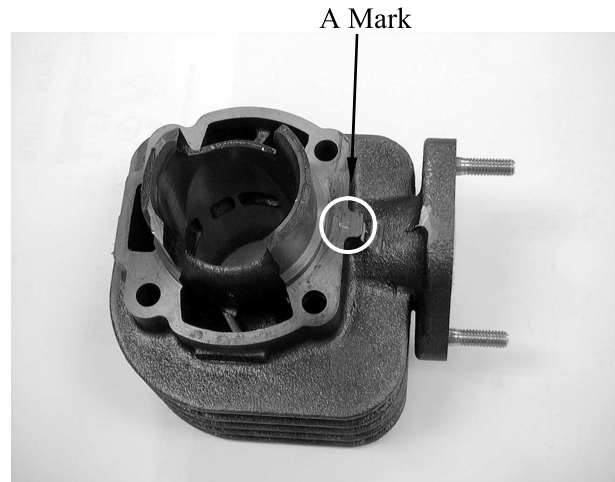

Measure the piston O.D. at a point 5mm from the bottom of the piston skirt.  
**Service Limit:** 38.90mm replace if below



Measure the piston-to-cylinder clearance.  
**Service Limit:** 0.10mm replace if over

Measure the piston pin hole I.D.  
**Service Limit:** 12.03mm replace if over

Measure the piston pin O.D.  
**Service Limit:** 11.98mm replace if below

Measure the piston-to-piston pin clearance.  
**Service Limit:** 0.03mm replace if over



## 7. CYLINDER HEAD (2-STROKE)/ CYLINDER/PISTON

### PISTON RING INSPECTION

Measure each piston ring end gap.

#### Service Limits:

Top/Second: 0.40mm replace if over

Set each piston ring squarely into the cylinder using the piston and measure the end gap.



### CONNECTING ROD SMALL END INSPECTION

Install the piston pin and bearing in the connecting rod small end and check for excessive play.

Measure the connecting rod small end I.D.

**Service Limit:** 17.03mm replace if over



### PISTON/CYLINDER INSTALLATION

First install the expander in the second ring groove.

Then install the top and second rings in their respective ring grooves.

The piston rings should be pressed into the grooves with even force.

After installation, check and make sure that each ring is flush with the piston at several points around the ring.

A ring that will not compress means that the ring groove has carbon deposits in it and should be cleaned.

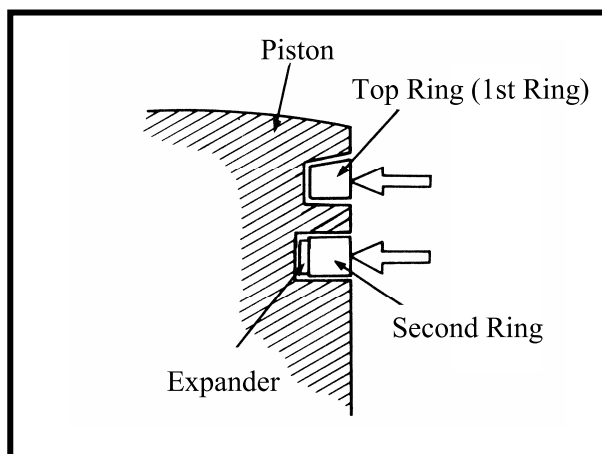

## 7. CYLINDER HEAD (2-STROKE)/ CYLINDER/PISTON

Install a new cylinder gasket on the mating surface between the cylinder and crankcase.

Cylinder Gasket

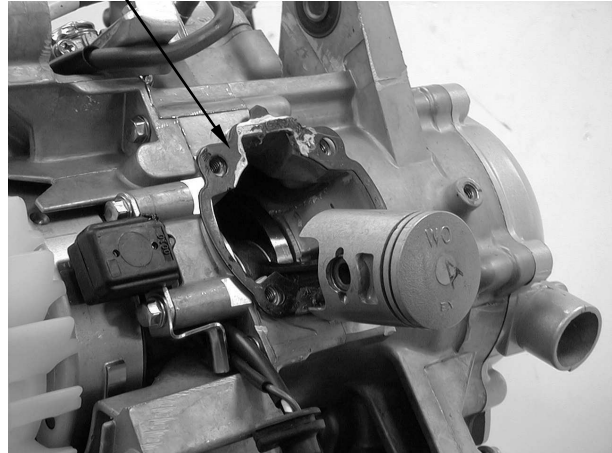

Make sure that the ring end gaps are aligned with the piston ring pins in the ring grooves.

Ring Pins

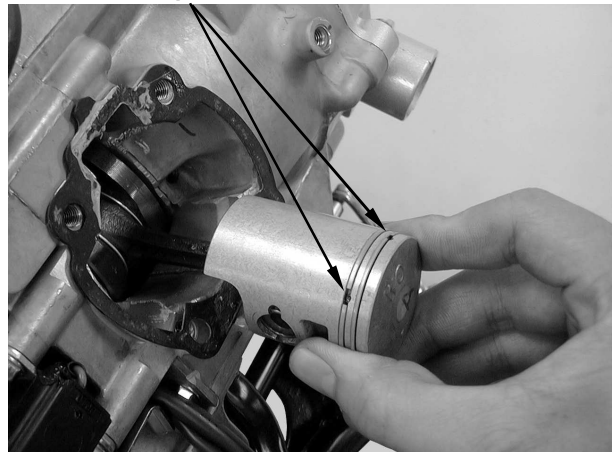

Lubricate the cylinder inside and piston rings with engine oil and install the piston into the cylinder while compressing the piston rings.

□ Be careful not to damage the piston.

Install the cylinder head.

**Torque:** 1.0□1.2kg-m

Install the exhaust muffler and tighten the exhaust muffler joint lock nuts.

**Torque:** 1.0□1.4kg-m

Tighten the exhaust muffler lock bolts.

**Torque:** 3.0□3.6kg-m

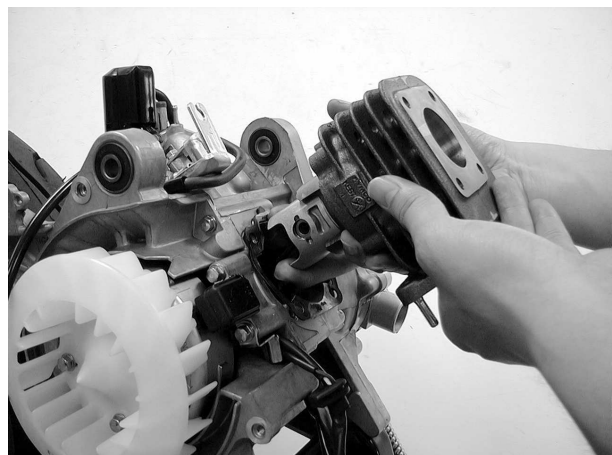

## 7. CYLINDER HEAD (2-STROKE)/ CYLINDER/PISTON

### CYLINDER/PISTON (4-STROKE)

#### REMOVAL

Remove the cylinder head. (Refer to the chapter 6)

Remove the two dowel pins and cylinder head gasket.

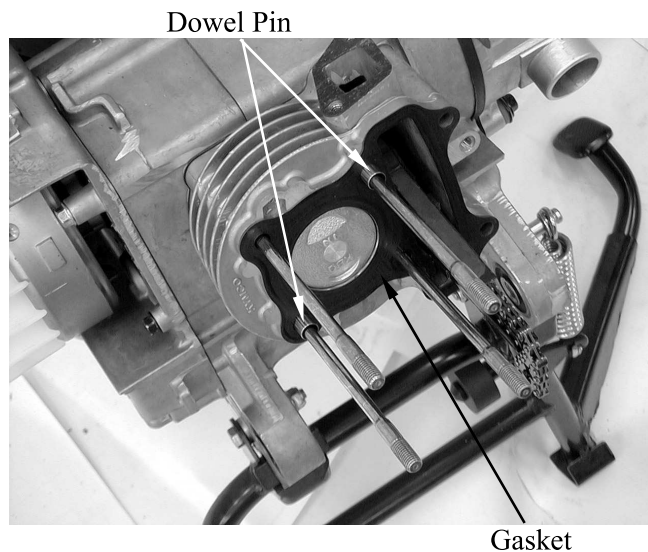

Remove cam chain guide and then remove cylinder.

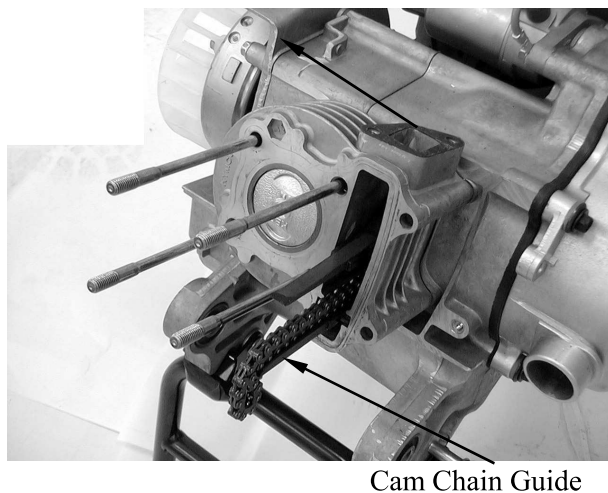

Remove the cylinder gasket and dowel pins. Clean any gasket material from the cylinder surface.

Be careful not to drop foreign matters into the crankcase.

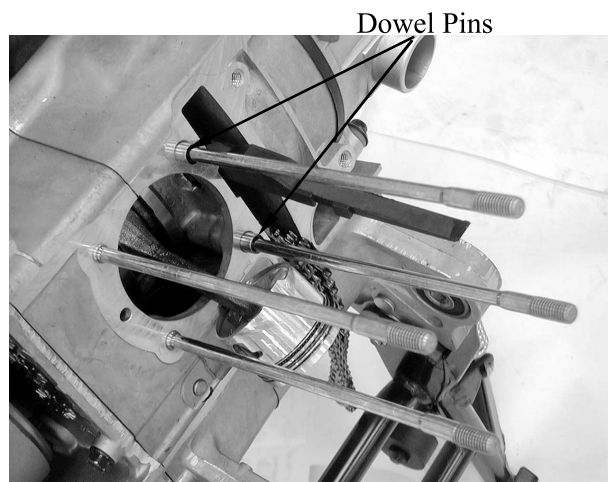

## 7. CYLINDER HEAD (2-STROKE)/ CYLINDER/PISTON

Remove the piston pin clip.

- Place a clean shop towel in the crankcase to keep the piston pin clip from falling into the crankcase.

Press the piston pin out of the piston and remove the piston.

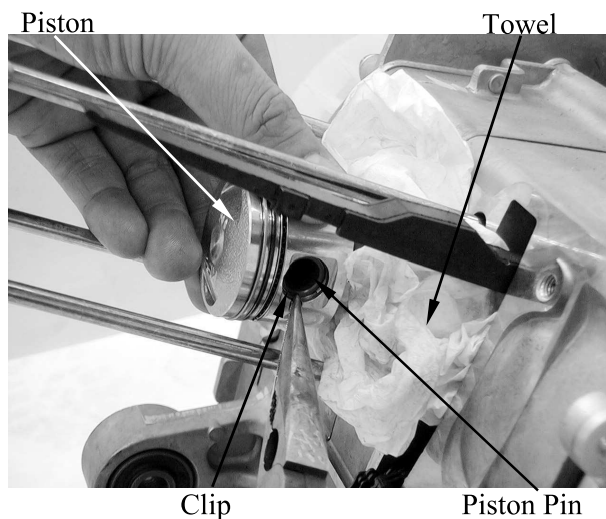

### INSPECTION

Inspect the piston, piston pin and piston rings.

Remove the piston rings.

- Take care not to damage or break the piston rings during removal.

Clean carbon deposits from the piston ring grooves.



Inspect the piston wall for wear/scratches/damage.

If any defects are found, replace the piston with a new one.

Install the piston rings onto the piston and measure the piston ring-to-groove clearance.

**Service Limits:** **Top:** 0.09mm replace if  
over  
**2nd:** 0.09mm replace if  
over

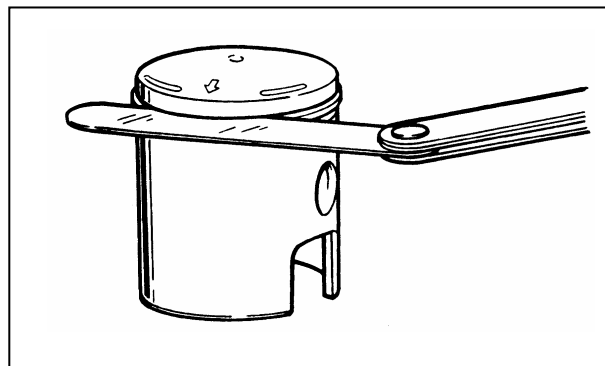

## 7. CYLINDER HEAD (2-STROKE)/ CYLINDER/PISTON

Remove the piston rings and insert each piston ring into the cylinder bottom.

- Use the piston head to push each piston ring into the cylinder.

Measure the piston ring end gap.

**Service Limit:** Top: 0.5mm replace if over  
2nd: 0.65mm replace if over

Oil ring: 0.9mm replace if over

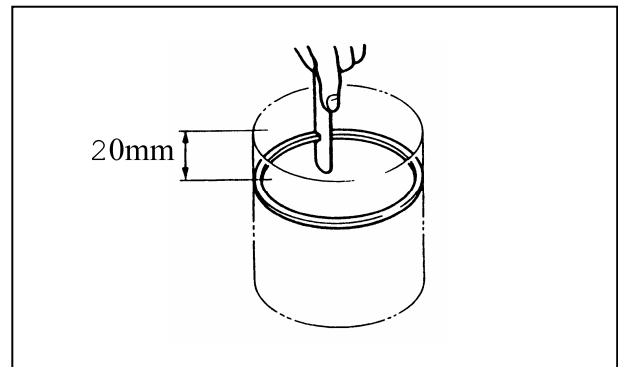

Measure the piston pin hole I.D.

**Service Limit:** 13.04mm replace if over

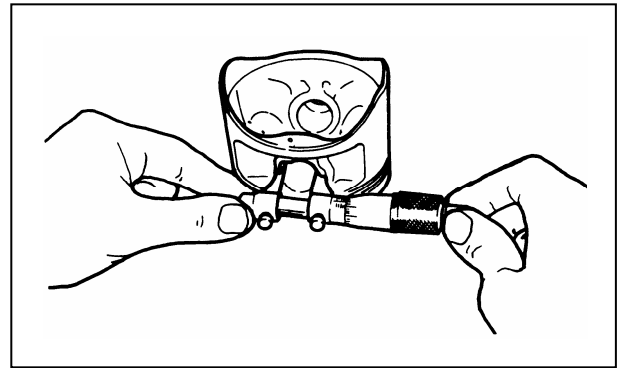

Measure the piston pin O.D.

**Service Limit:** 12.96mm replace if below

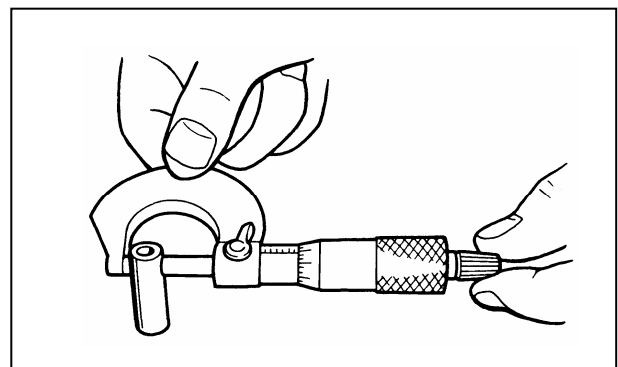

## 7. CYLINDER HEAD (2-STROKE)/ CYLINDER/PISTON

Measure the piston O.D.

- Take measurement at 4.5mm from the bottom and 90° to the piston pin hole.

**Service Limit:** 38.9mm replace if below

Measure the piston-to-piston pin clearance.

**Service Limit:** 0.02mm replace if over

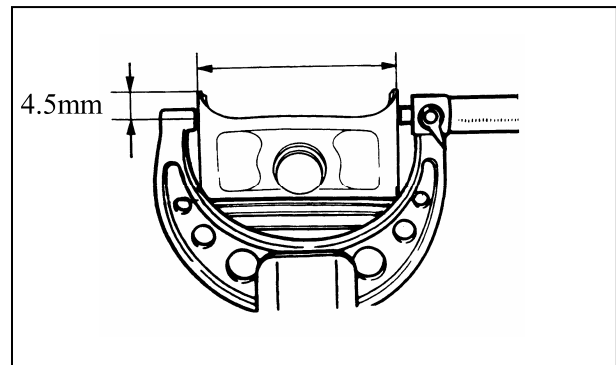

### CYLINDER INSPECTION

Inspect the cylinder bore for wear or damage. Measure the cylinder I.D. at three levels of top, middle and bottom at 90° to the piston pin (in both X and Y directions).

Cylinder I.D.:

**Service Limit:** 39.1mm replace if over

Measure the cylinder-to-piston clearance.

**Service Limit:** 0.1mm repair or replace if over

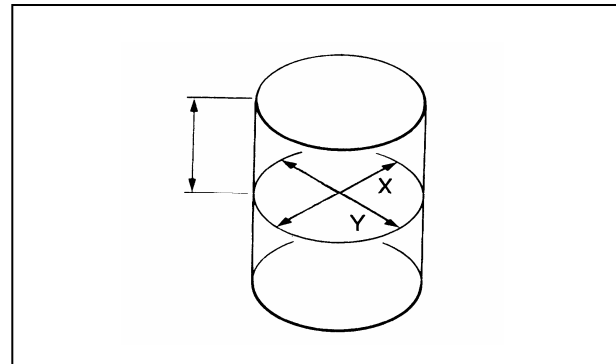

The true roundness is the difference between the values measured in X and Y directions. The cylindricity (difference between the values measured at the three levels) is subject to the maximum value calculated.

**Service Limits:**

**True Roundness:** 0.05mm repair or replace if over

**Cylindricity:** 0.05mm repair or replace if over





## 7. CYLINDER HEAD (2-STROKE)/ CYLINDER/PISTON

Inspect the exhaust side and intake side chain guides.

Wear/Damage → Replace.

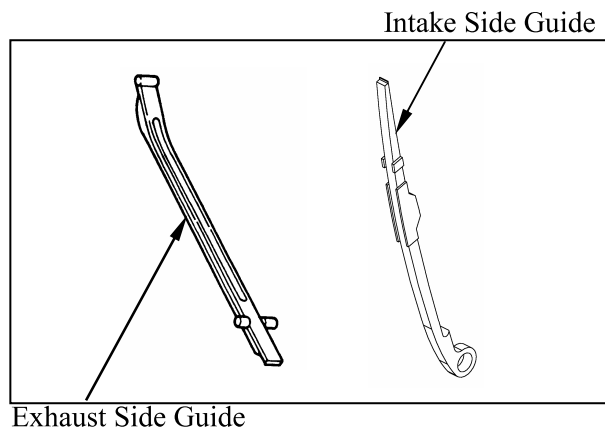

### PISTON INSTALLATION

Remove any gasket material from the crankcase surface.

- Be careful not to drop foreign matters into the crankcase.

Install the piston, piston pin and a new piston pin clip.

- - Position the piston “IN” mark on the intake valve side.
  - Place a clean shop towel in the crankcase to keep the piston pin clip from falling into the crankcase.



### CYLINDER INSTALLATION

Install the dowel pins and a new cylinder gasket on the crankcase.

Coat the cylinder bore, piston and piston rings with clean engine oil.

Carefully lower the cylinder over the piston by compressing the piston rings.

- - Apply proper clean engine oil around cylinder wall.
  - Be careful not to damage or break the piston rings.
  - Stagger the ring end gaps at 120° to the piston pin.

## 8. A.C. GENERATOR

---

8

---

### A.C. GENERATOR

---

SERVICE INFORMATION .....	8-2
A.C. GENERATOR .....	8-3

# 8. A.C. GENERATOR

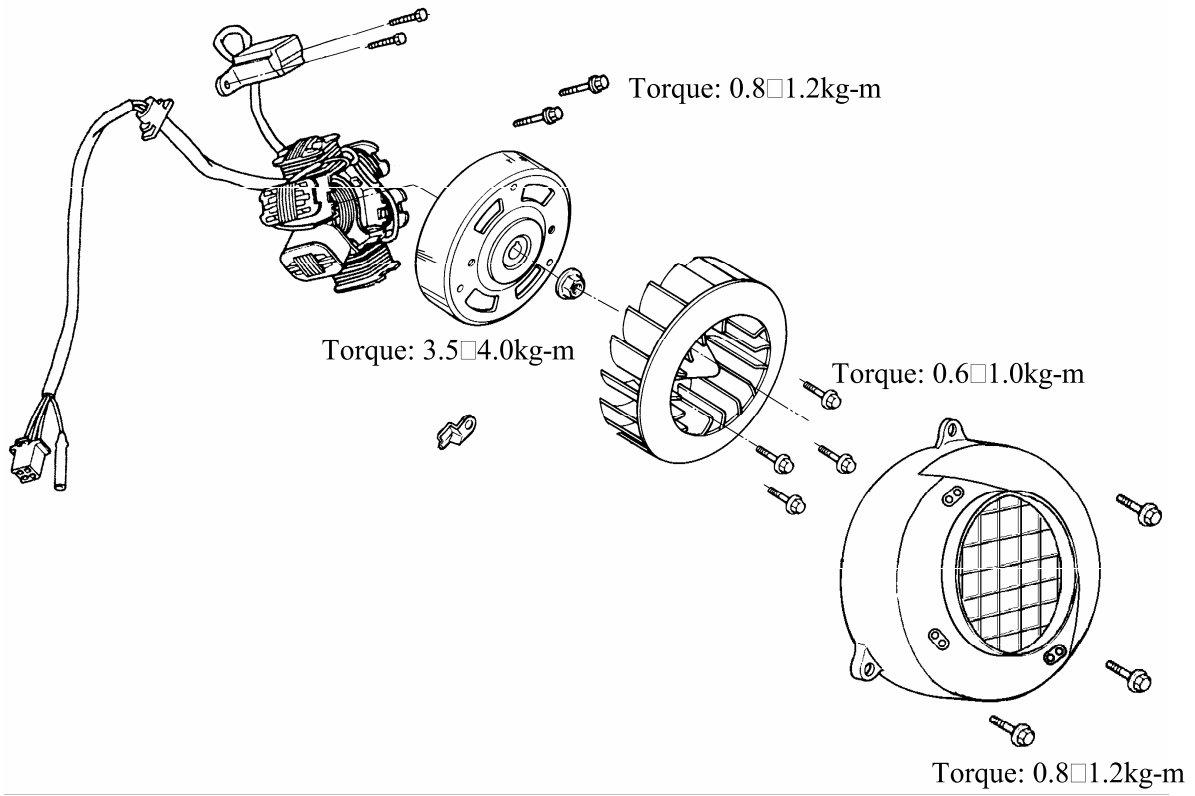

## **8. A.C. GENERATOR**

---

### **SERVICE INFORMATION**

#### **GENERAL INSTRUCTIONS**

- All A.C. generator maintenance and inspection can be made with the engine installed.
- Refer to Section 16 for A.C. generator inspection.

#### **TORQUE VALUE**

Flywheel nut : 3.5□4.0kg-m

#### **SPECIAL TOOLS**

Flywheel puller	E001
Universal holder	E017

## 8. A.C. GENERATOR

### A.C. GENERATOR

#### REMOVAL

Remove the right side cover. (⇒13-4)

Remove the three bolts attaching the fan cover to remove the fan cover.

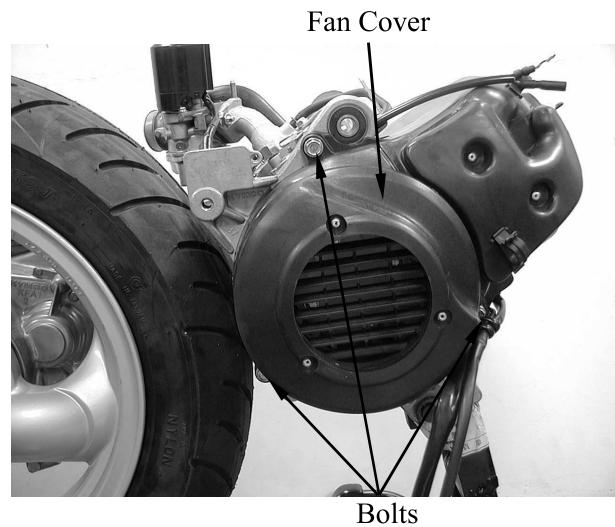

Remove the cooling fan by removing the four bolts.

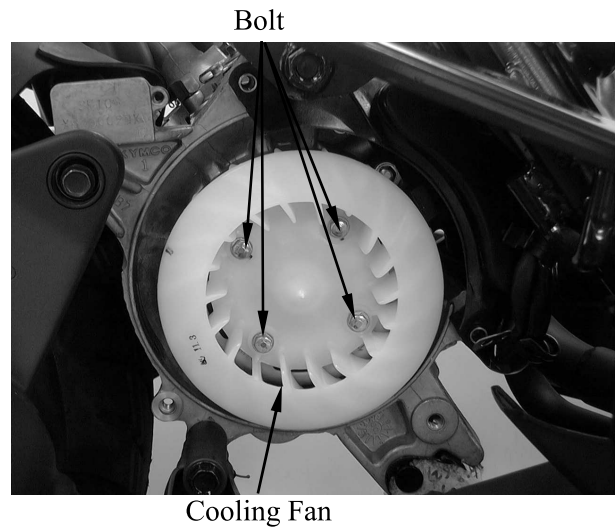

Hold the flywheel with an universal holder and then remove the 10mm flywheel nut.

Special

Universal holder

E017

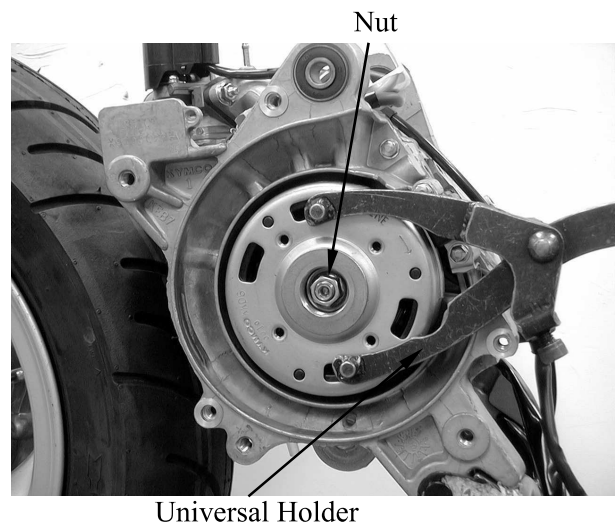

## 8. A.C. GENERATOR

Remove the A.C. generator flywheel using the flywheel puller.

Special

Flywheel puller

E001

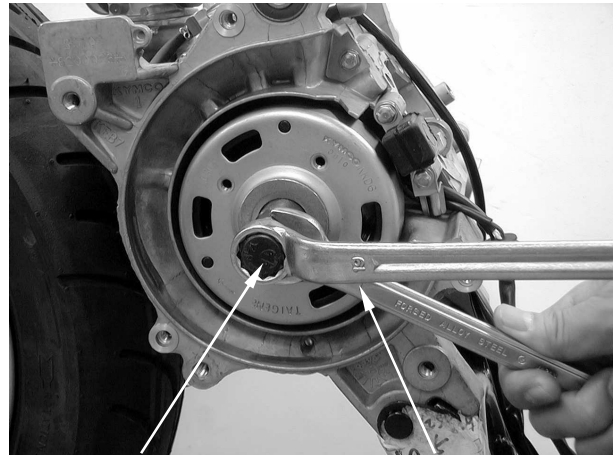

Flywheel Puller

Lock Nut Wrench

Remove the A.C. generator wire connector.

A.C. Generator Wire Connector

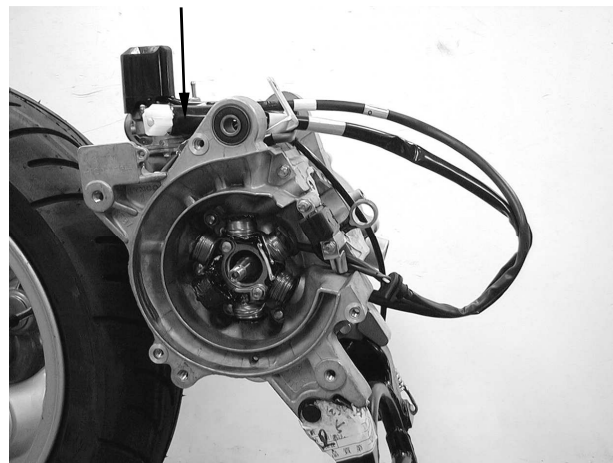

Remove the two pulser coil bolts and pulser coil from the right crankcase.  
Remove the pulser coil wire clamp from the right crankcase.  
Remove the two bolts attaching the A.C. generator stator.



Be careful not to damage the disconnected wire.

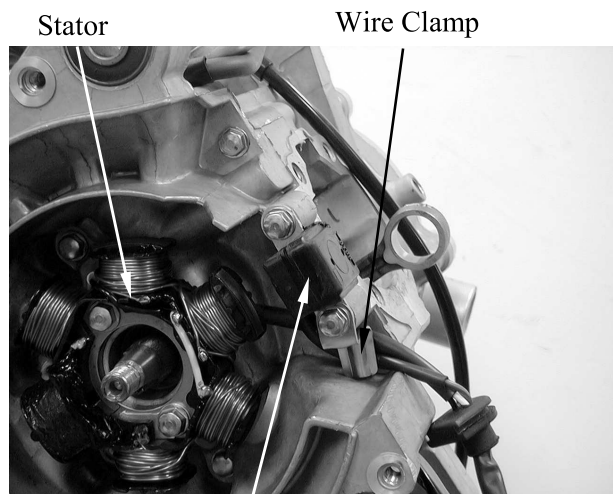

Stator

Wire Clamp

Pulser Coil

## 8. A.C. GENERATOR

### INSTALLATION

Install the A.C. generator stator and pulser coil wire clamp onto the right crankcase, and then install the pulser coil.

Connect the A.C. generator wire connector.

A.C. Generator Wire Connector

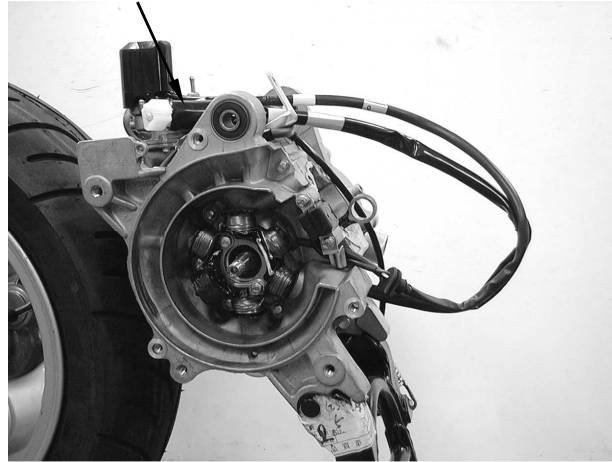

Clean the taper hole in the flywheel off any burrs and dirt.  
Install the woodruff key in the crankshaft keyway.

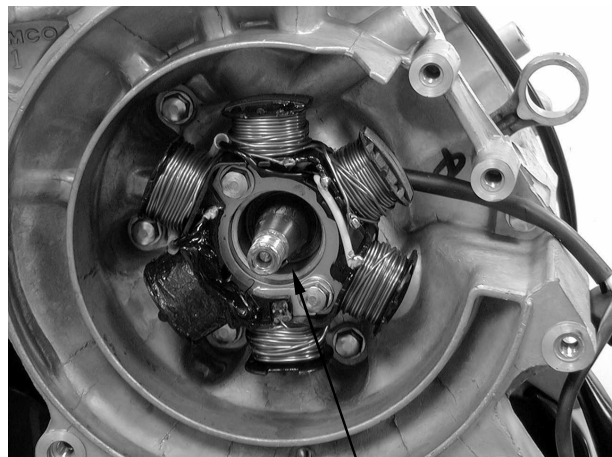

Woodruff Key

Install the flywheel onto the crankshaft with the flywheel groove aligned with the crankshaft woodruff key.  
Hold the flywheel with the universal holder and install the 10mm flywheel flange nut.

**Torque:** 3.5□4.0kg-m

Start the engine and check the ignition timing. (⇒3-14 or ⇒3-15)

Special

Universal holder

E017

Universal Holder

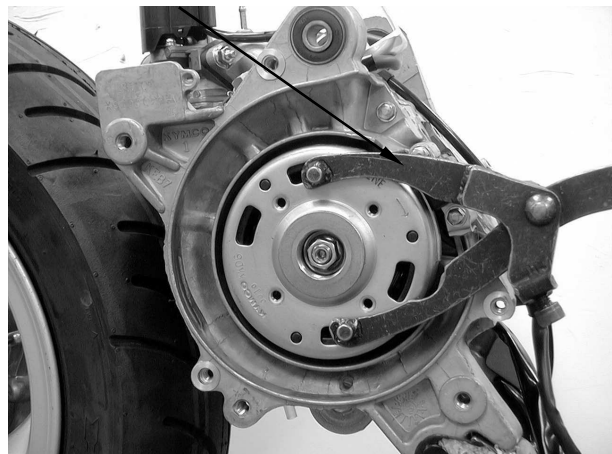



---

**KICK STARTER/DRIVE PULLEY/  
CLUTCH/DRIVEN PULLEY**

---

SERVICE INFORMATION .....	9- 2
TROUBLESHOOTING .....	9- 2
KICK STARTER.....	9- 3
DRIVE BELT .....	9- 7
DRIVE PULLEY .....	9- 9
STARTER PINION .....	9-11
CLUTCH/DRIVEN PULLEY.....	9-12

# 9. KICK STARTER/DRIVE PULLEY/ CLUTCH/DRIVEN PULLEY

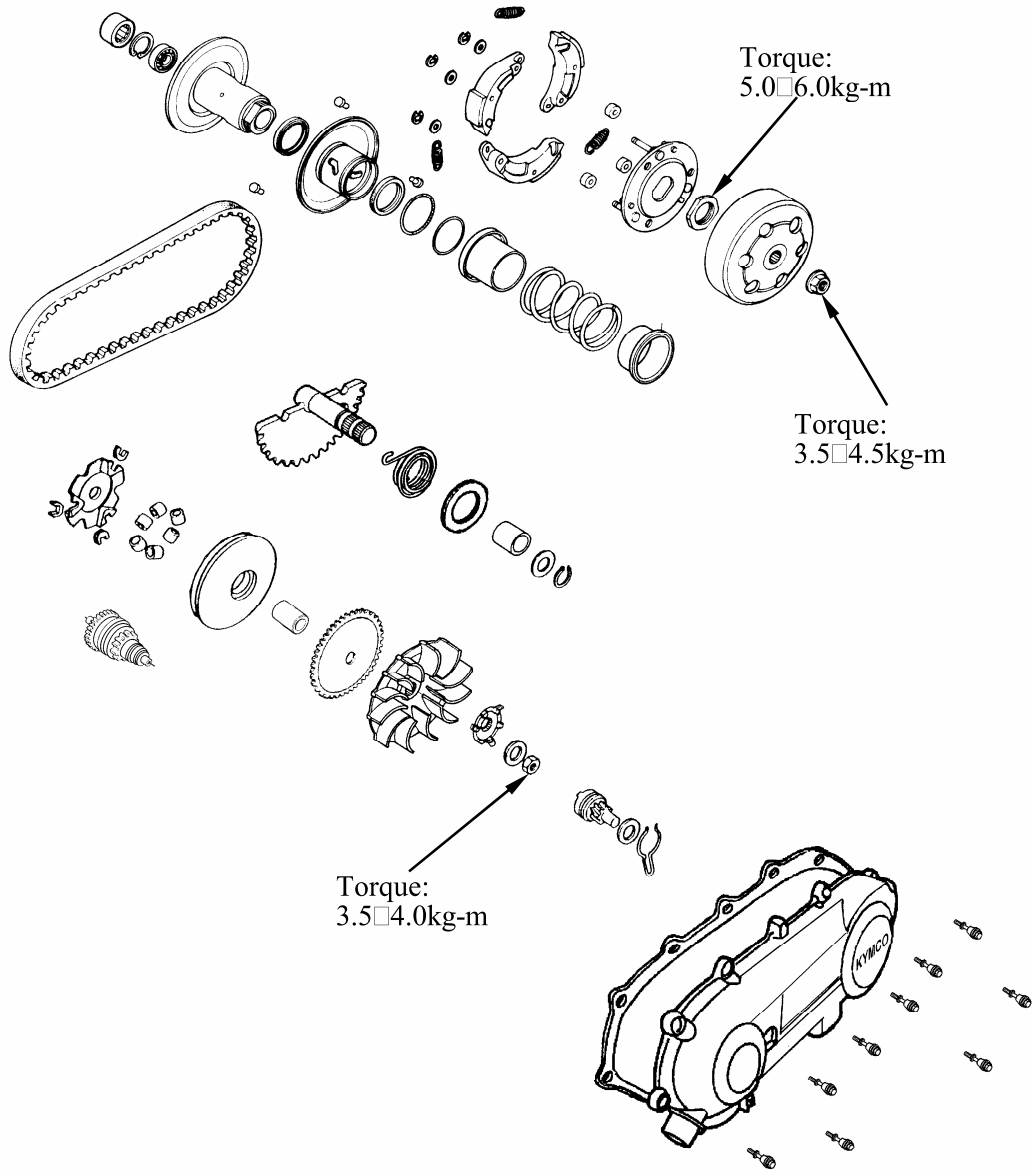

# 9. KICK STARTER/DRIVE PULLEY/ CLUTCH/DRIVEN PULLEY

## SERVICE INFORMATION

### GENERAL INSTRUCTIONS

- Avoid getting grease and oil on the drive belt and pulley faces.

SPECIFICATIONS	VITALITY 50	
	Standard (mm)	Service Limit (mm)
Drive pulley collar O.D.	19.96□19.974	19.94
Movable drive face I.D.	20.011□20.052	20.6
Weight roller O.D.	15.92□16.08	15.4
Clutch outer I.D.	107□107.2	107.5
Driven face spring free length	87.9 (2-stroke)	82.6 (2-stroke)
Driven face spring free length	95 (4-stroke)	90 (4-stroke)
Driven face O.D.	33.965□33.985	33.94
Movable driven face I.D.	34.0□34.25	34.06
Drive belt width	18	17

### TORQUE VALUES

Drive face nut	3.5□4.0kg-m
Clutch outer nut	3.5□4.5kg-m
Clutch drive plate nut	5.0□6.0kg-m

### SPECIAL TOOLS

Universal holder	E017
Clutch spring compressor	E034

### TROUBLESHOOTING

#### Engine starts but motorcycle won't move

- Worn drive belt
- Broken ramp plate
- Worn or damaged clutch lining

#### Engine stalls or motorcycle creeps

- Broken clutch weight spring

#### Poor performance at high speed or lack of power

- Worn drive belt
- Weak driven face spring
- Worn weight roller
- Faulty driven face

## 9. KICK STARTER/DRIVE PULLEY/ CLUTCH/DRIVEN PULLEY

### KICK STARTER

#### LEFT CRANKCASE COVER REMOVAL

Remove left side cover. (⇒13-4)

Remove the drive belt cooling air tube connector circlip. (⇒5-3)

Remove air cleaner housing. (⇒5-2)

Remove the nine left crankcase cover bolts, left crankcase cover and dowel pins.  
Inspect the left crankcase cover seal rubber for damage or deterioration.

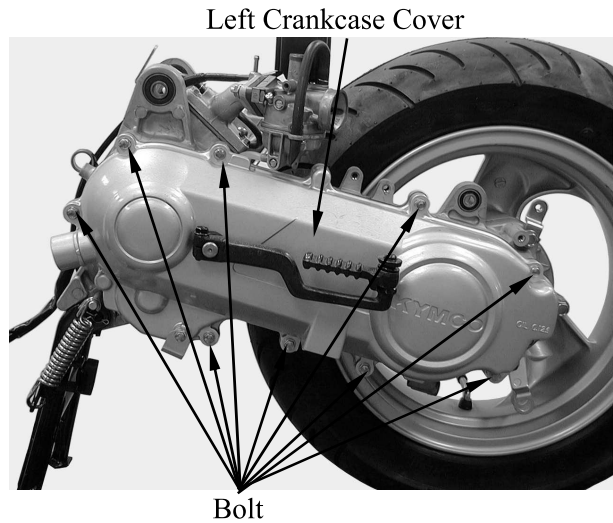

#### KICK STARTER SPINDLE REMOVAL

Remove the kick lever from the kick starter spindle.

Remove the circlip and washer from the kick starter spindle.



Slightly rotate the kick starter spindle to remove the kick starter driven gear together with the friction spring.

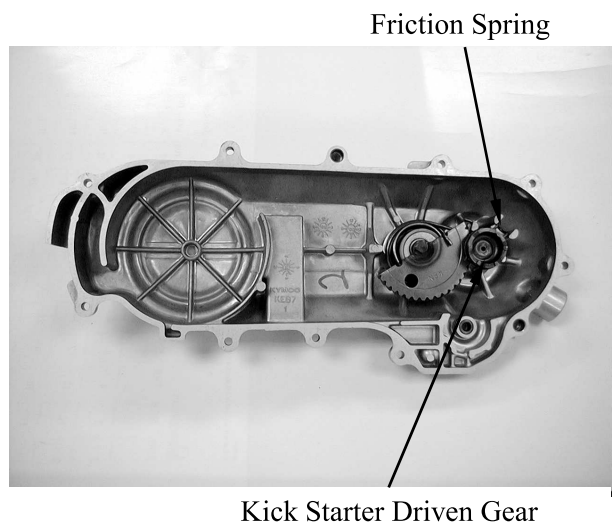

## 9. KICK STARTER/DRIVE PULLEY/ CLUTCH/DRIVEN PULLEY

Remove the kick starter spindle and return spring from the left crankcase cover.  
Remove the kick starter spindle bushing.

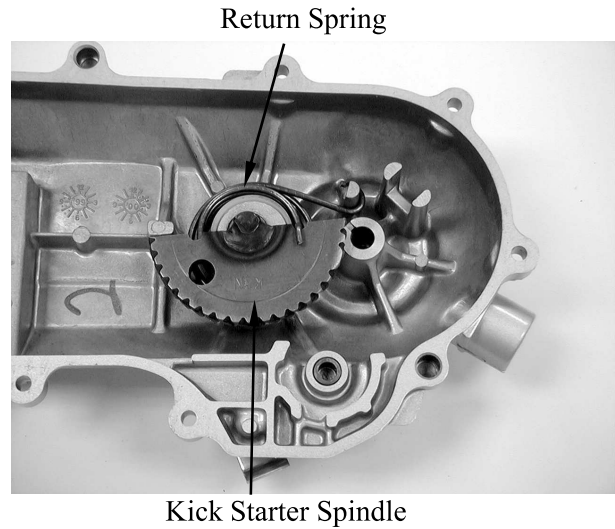

### KICK STARTER SPINDLE INSPECTION

Inspect the kick starter spindle and gear for wear or damage.  
Inspect the return spring for weakness or damage.  
Inspect the kick starter spindle bushing for wear or damage.

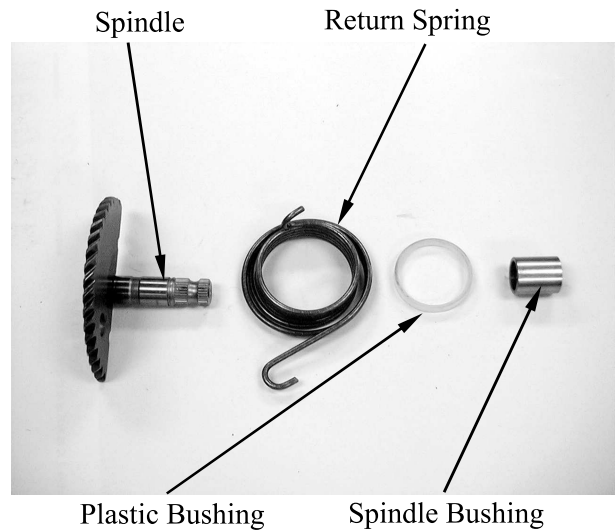

Check the kick starter driven gear for wear or damage.  
Check the friction spring for wear or damage.

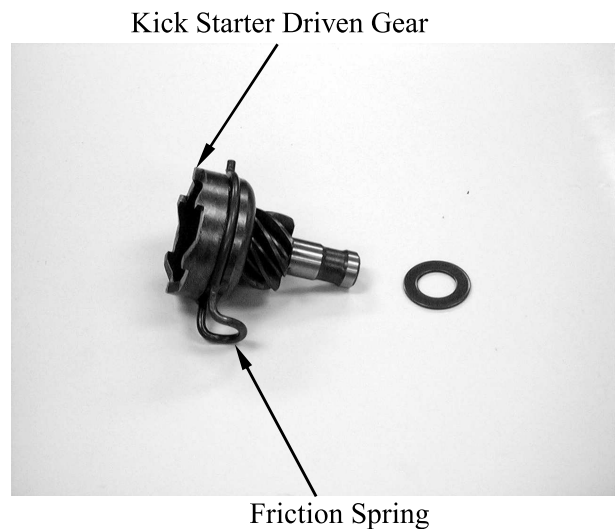

## 9. KICK STARTER/DRIVE PULLEY/ CLUTCH/DRIVEN PULLEY

Inspect the kick starter spindle and driven gear forcing parts for wear or damage.

Kick Starter Spindle Forcing Part

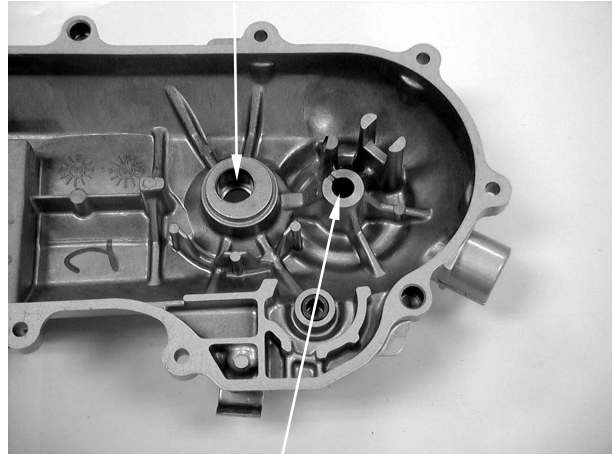

Kick Starter Driven Gear Forcing Part

### KICK STARTER INSTALLATION

Install the kick starter spindle bushing and return spring onto the left crankcase cover.

If the hooks of the return spring can not be installed properly, use a screw driver to press them into their locations respectively.

Friction Spring

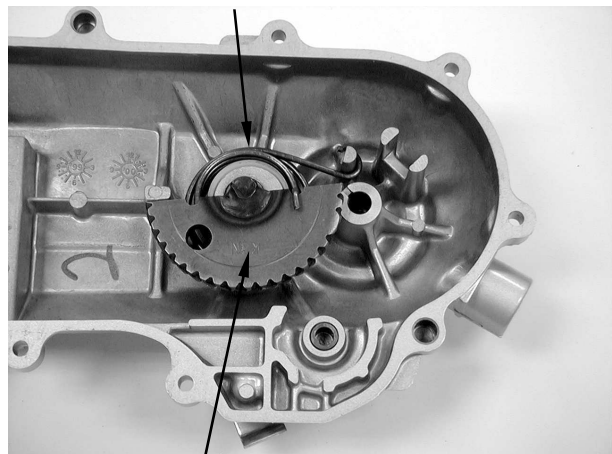

Kick Starter Spindle

Properly install the kick starter driven gear and friction spring as the figure shown.

Friction Spring

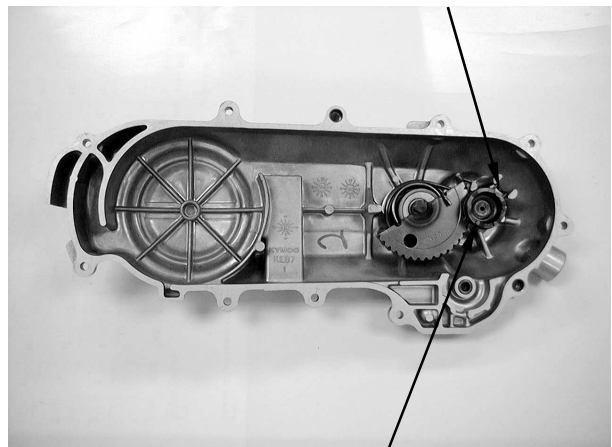

Kick Starter Driven Gear

## 9. KICK STARTER/DRIVE PULLEY/ CLUTCH/DRIVEN PULLEY

First install the washer and then the circlip onto the kick starter spindle.  
Install the kick lever.

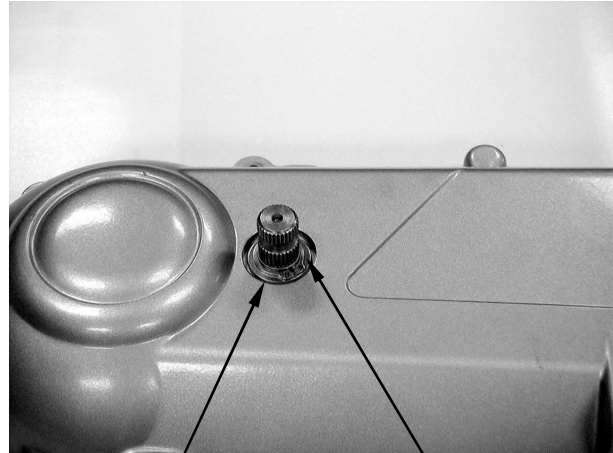

Washer

Circlip

### LEFT CRANKCASE COVER INSTALLATION

First install the dowel pins and then the seal gasket.

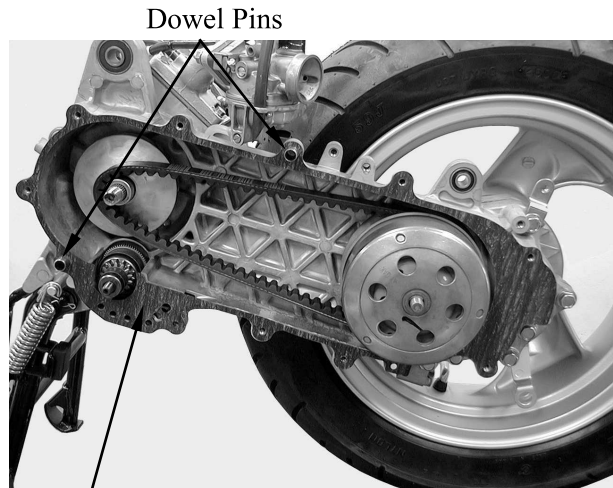

Dowel Pins

Seal Gasket

Install the left crankcase cover and tighten the ten bolts diagonally.  
Connect the drive belt cooling air tube and install the circlip.

□ For drum brake, note the location of the brake cable clamp and install the rear brake cable in place with the clamp.



Left Crankcase Cover

Rear Brake Cable Clamp

# 9. KICK STARTER/DRIVE PULLEY/ CLUTCH/DRIVEN PULLEY

## DRIVE BELT

Remove the left crankcase cover. (⇒9-3)

## INSPECTION

Check the drive belt for cracks, separation or abnormal or excessive wear.  
Measure the drive belt width.

**Service Limit:** 17mm replace if below

□ Use specified genuine parts for replacement.

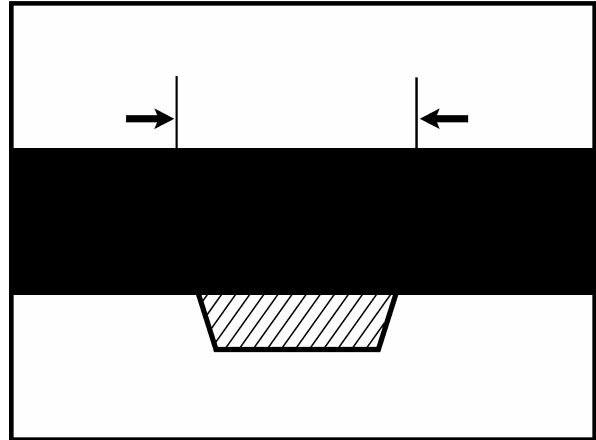

## REPLACEMENT

Remove the ten left crankcase cover bolts and left crankcase cover. (⇒9-3)

Hold the clutch outer with the universal holder and remove the 10mm clutch outer nut and clutch outer.

Special

Universal holder                      E017

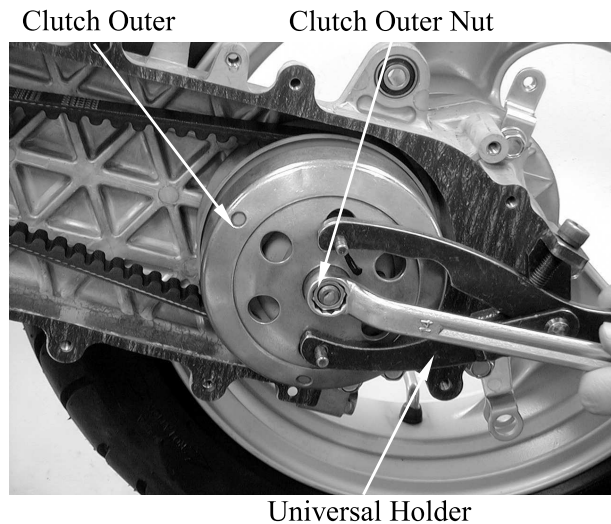

Hold the drive pulley with the holder and remove the 12mm drive face nut. Remove the starting ratchet. Remove the drive pulley face.

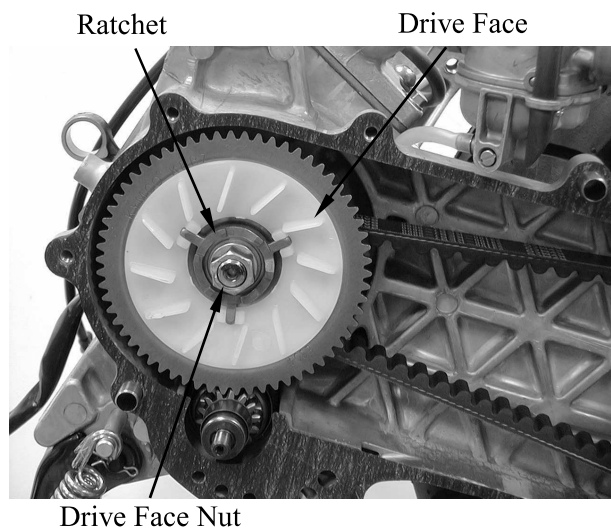



## 9. KICK STARTER/DRIVE PULLEY/ CLUTCH/DRIVEN PULLEY

Remove the drive belt from the clutch/  
driven pulley.

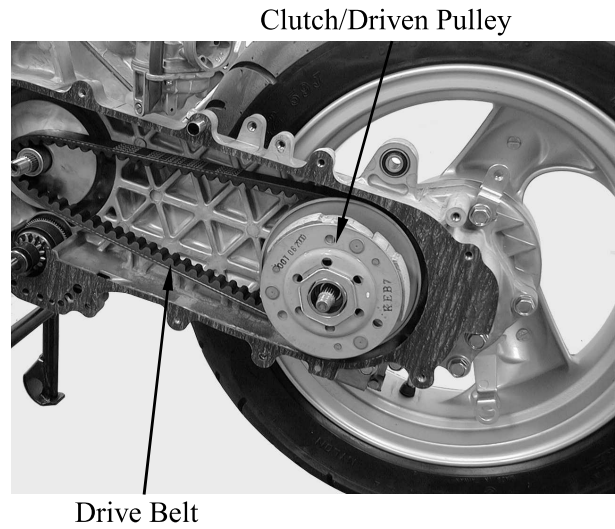

### DRIVE BELT INSTALLATION

Turn the driven pulley clockwise and lift it  
up to expand the drive belt groove and then  
install a new drive belt.



Set the drive belt on the drive pulley.  
Install the drive pulley face, starting ratchet  
and 12mm drive face nut, then tighten the  
drive face nut.

**Torque:** 3.5□4.0kg-m

When installing the drive face nut, make  
sure that the tooth spaces of the drive  
pulley face and starting ratchet align  
with the teeth of the crankshaft.

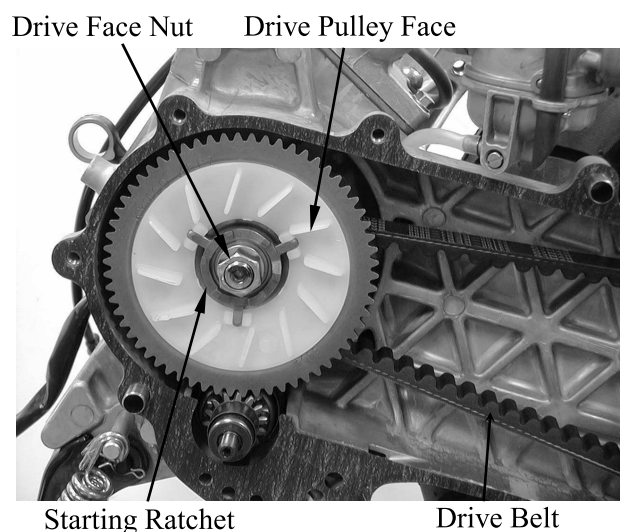

## 9. KICK STARTER/DRIVE PULLEY/ CLUTCH/DRIVEN PULLEY

### DRIVE PULLEY

#### REMOVAL

Hold the drive pulley with the holder and remove the 12mm drive face nut. Remove the starting ratchet and drive pulley face.

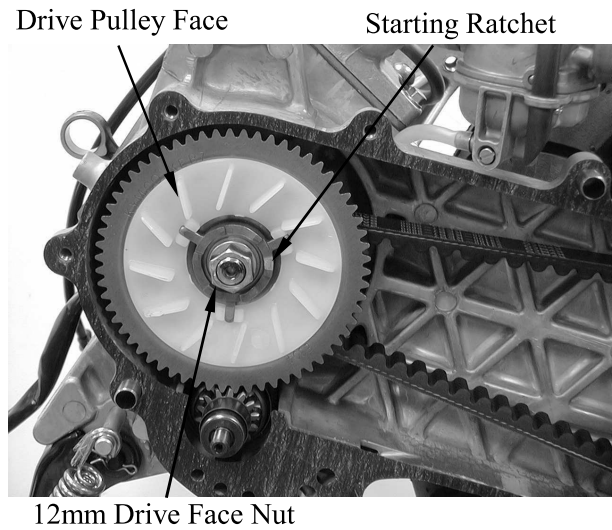

#### MOVABLE DRIVE FACE DISASSEMBLY

Remove the movable drive face and drive pulley collar from the crankshaft.

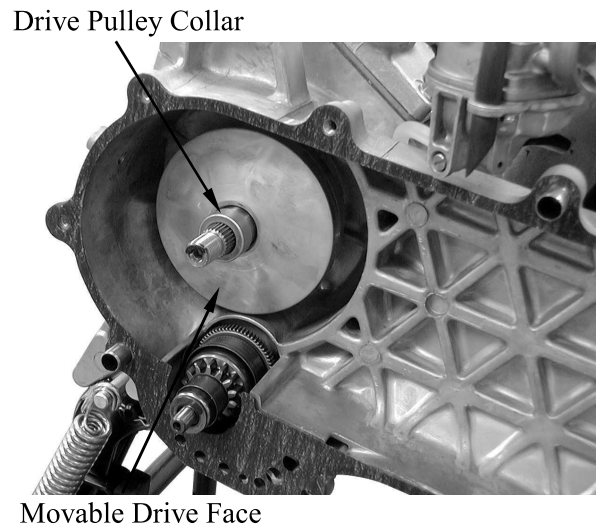

Remove the ramp plate.

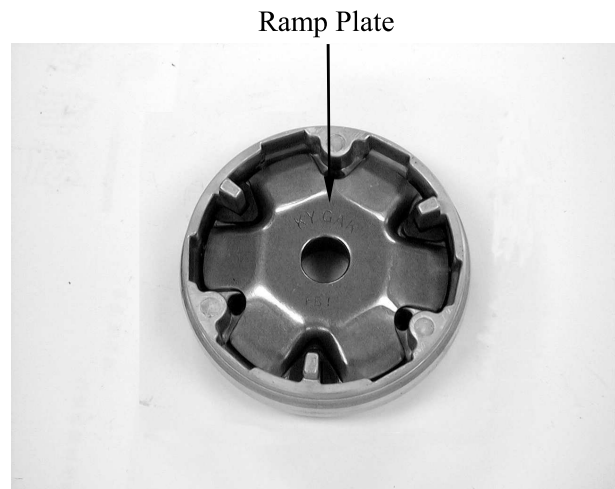

## 9. KICK STARTER/DRIVE PULLEY/ CLUTCH/DRIVEN PULLEY

Remove the weight rollers.



### MOVABLE DRIVE FACE INSPECTION

Check each weight roller for wear or damage.

Measure each roller O.D.

**Service Limit:** 15.4mm replace if below

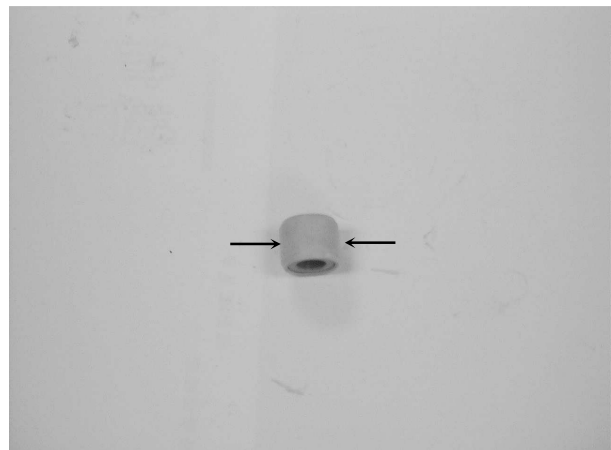

### DRIVE PULLEY INSTALLATION

Install the drive pulley collar and movable drive face onto the crankshaft.

Movable Drive Face

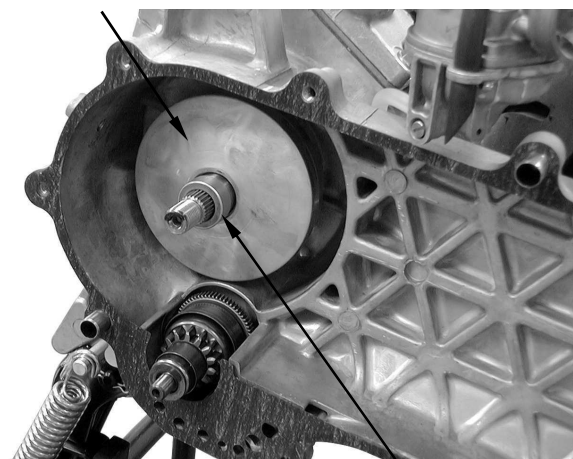

Drive Pulley Collar

## 9. KICK STARTER/DRIVE PULLEY/ CLUTCH/DRIVEN PULLEY

Install the drive belt on the crankshaft.  
Install the drive face, starting ratchet and  
washer, then tighten the 12mm drive face  
nut.

**Torque:** 3.5□4.0kg-m

Keep grease or oil off the drive belt and  
drive pulley faces.

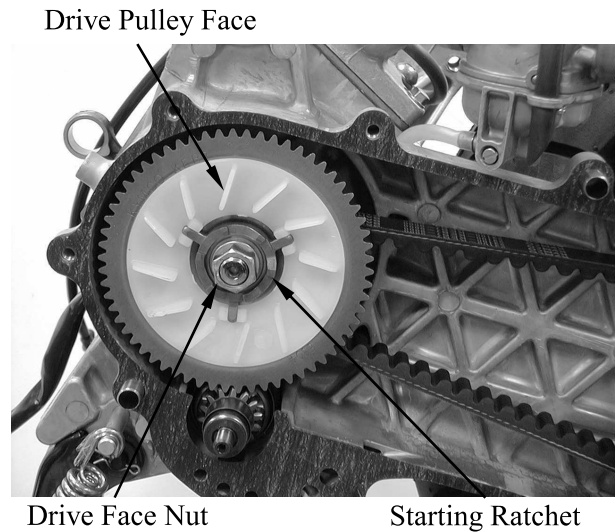

### STARTER PINION REMOVAL

Remove the left crankcase cover. (⇒9-3)  
Remove the drive pulley. (⇒9-9)  
Remove the starter pinion.



### INSPECTION

Inspect the starter pinion seat for wear.  
Inspect the starter pinion for smooth  
operation.  
Inspect the starter pinion shaft forcing parts  
for wear and damage.

### INSTALLATION

Apply a small amount of grease to the  
starter pinion teeth.  
Install the starter pinion in the reverse order  
of removal.

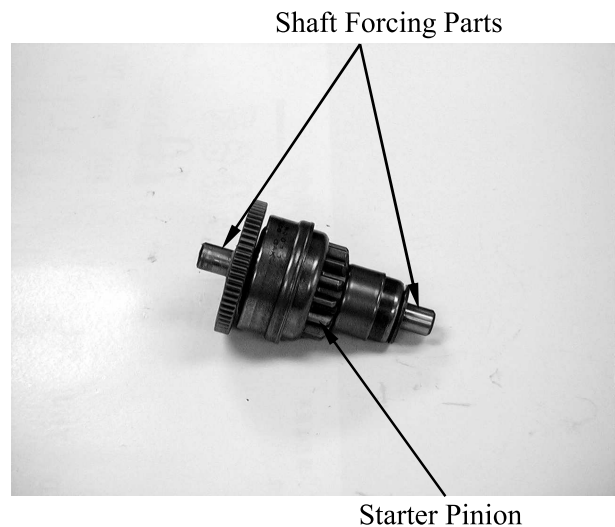

# 9. KICK STARTER/DRIVE PULLEY/ CLUTCH/DRIVEN PULLEY

## CLUTCH/DRIVEN PULLEY

### CLUTCH/DRIVEN PULLEY REMOVAL

Remove the drive pulley. (⇒9-9)

Hold the clutch outer with the universal holder and remove the 10mm clutch outer nut.

Remove the clutch outer.

Special

Universal holder

E017

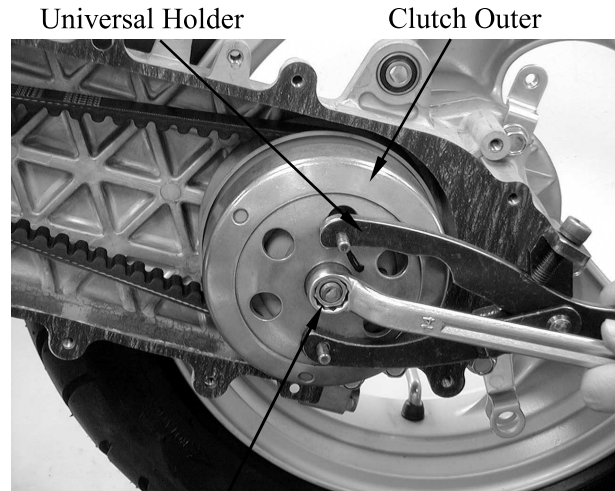

14mm Clutch Outer Nut

Remove the clutch/driven pulley.  
Remove the drive belt from the clutch/driven pulley.

Clutch/Driven Pulley

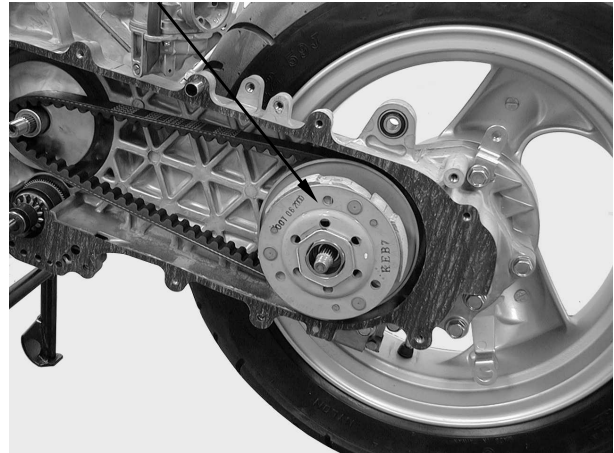

## CLUTCH/DRIVEN PULLEY DIS-ASSEMBLY

Compress the clutch/driven pulley spring with the clutch spring compressor and remove the 39mm drive plate nut.  
Remove the driven face spring.

Special

Universal holder

E034

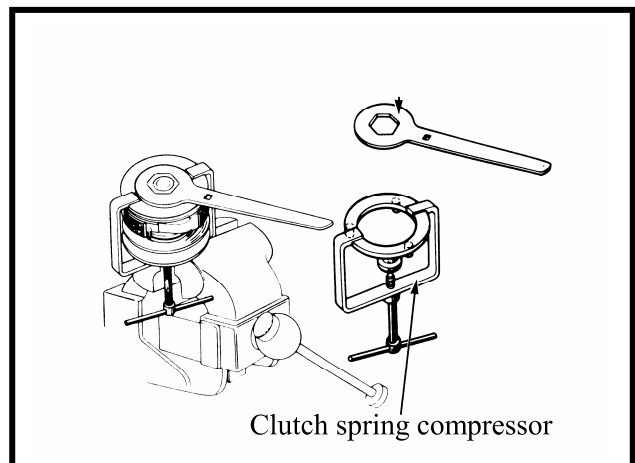

## 9. KICK STARTER/DRIVE PULLEY/ CLUTCH/DRIVEN PULLEY

Remove the seal collar.

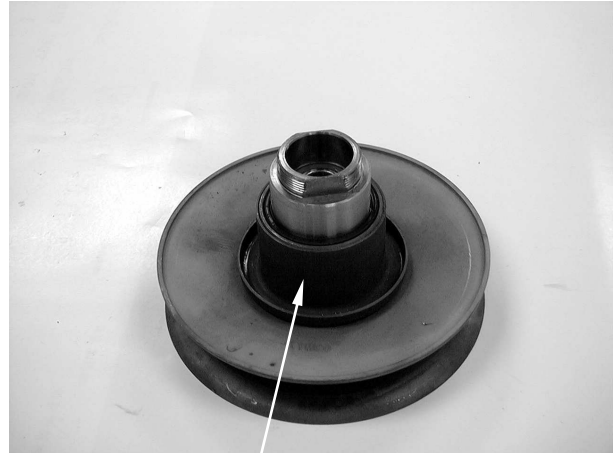

Seal Collar

Pull out the guide roller pins from the driven pulley and then remove the O-rings and oil seal from the driven pulley.

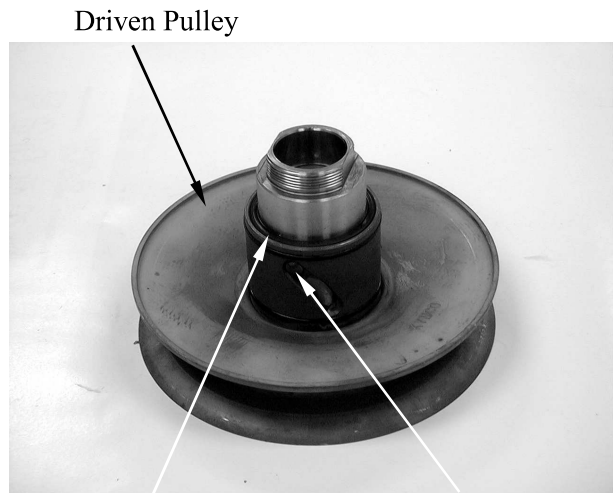

O-rings

Guide Roller Pin

### CLUTCH/DRIVEN PULLEY INSPECTION

Inspect the clutch outer for wear or damage.  
Measure the clutch outer I.D.

**Service Limit:** 107.5mm replace if below

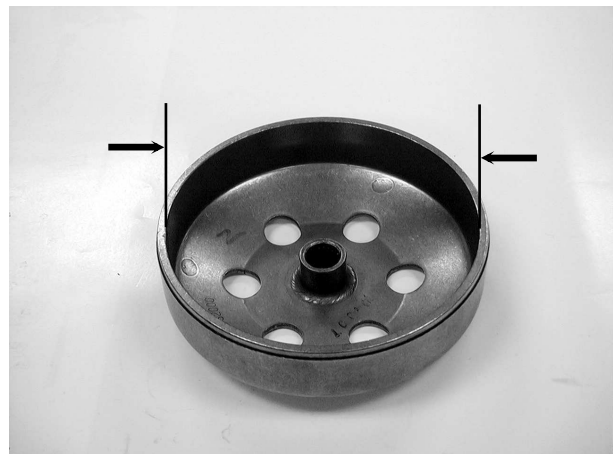

## 9. KICK STARTER/DRIVE PULLEY/ CLUTCH/DRIVEN PULLEY

Check the clutch shoes for wear or damage.  
Measure the clutch lining thickness.

**Service Limit:** 2.0mm replace if below



Measure the driven face spring free length.

**Service Limit:** 82.6mm replace if below

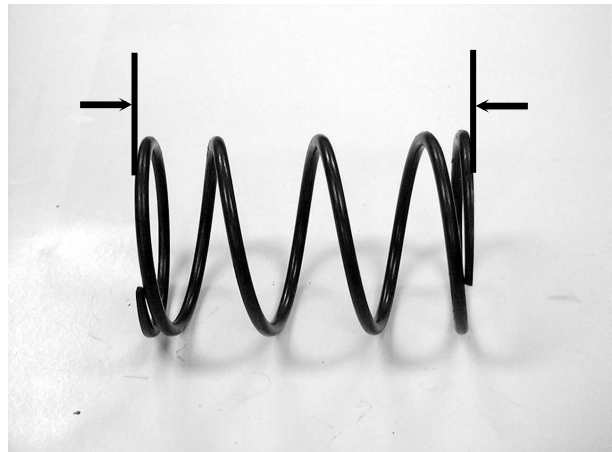

Check the driven face assembly for wear or damage.

Measure the driven face O.D.

**Service Limit:** 33.94mm replace if below

Check the movable driven face for wear or damage.

Measure the movable driven face I.D.

**Service Limit:** 34.06mm replace if below

Check the guide roller pins for stepped wear.

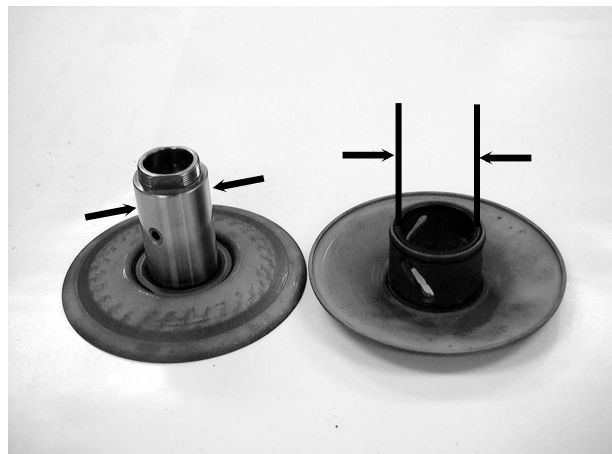

## 9. KICK STARTER/DRIVE PULLEY/ CLUTCH/DRIVEN PULLEY

### DRIVEN PULLEY FACE BEARING REPLACEMENT

Check the needle bearings in the driven face and replace them if they have excessive play, damage or abnormal noise. Drive the inner bearing out of the driven pulley face.

Inner Bearing



Remove the snap ring and drive the outer bearing out of the driven face.



Outer Bearing

Drive a new outer bearing into the driven face with the sealed end facing up. Seat the snap ring in its groove.

□ Pack all bearing cavities with 5.0□5.6g grease.  
Specified grease: 230□Heat-resistant grease



Bearing Outer Driver



## 9. KICK STARTER/DRIVE PULLEY/ CLUTCH/DRIVEN PULLEY

Drive in a new needle bearing into the driven face with the mark facing up.

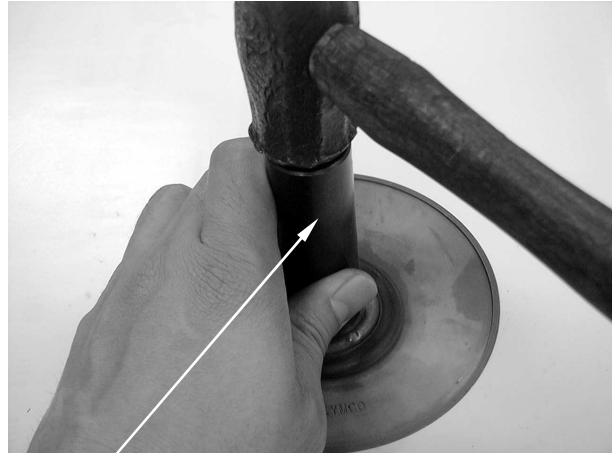

Bearing Driver Pilot

### CLUTCH/DRIVEN PULLEY ASSEMBLY

First install the movable driven face onto the driven face. Then, install the guide roller pins, O-rings and a new oil seal.

Driven Pulley

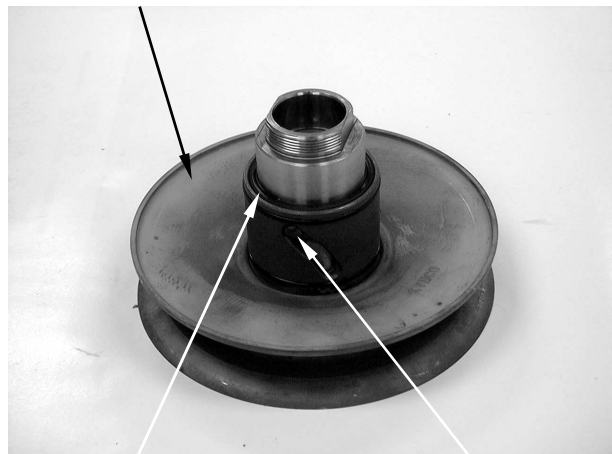

O-rings

Guide Roller Pin

Install the seal collar.

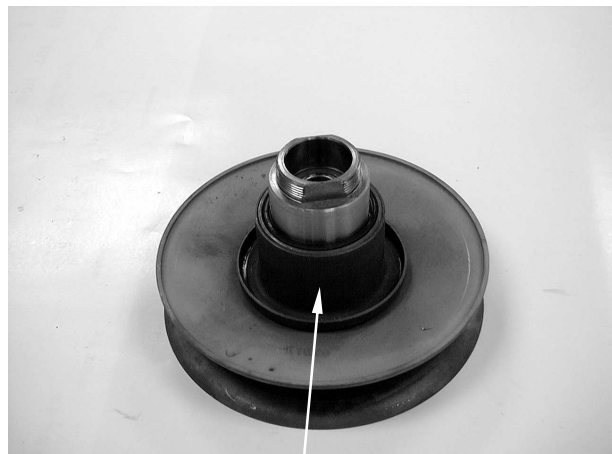

Seal Collar

## 9. KICK STARTER/DRIVE PULLEY/ CLUTCH/DRIVEN PULLEY

Set the driven pulley, driven face spring and clutch assembly onto the clutch spring compressor. Compress the tool and install the 39mm drive plate nut. Tighten the 39mm nut to the specified torque.

**Torque:** 5.0□6.0kg-m

Special

Universal holder

E034

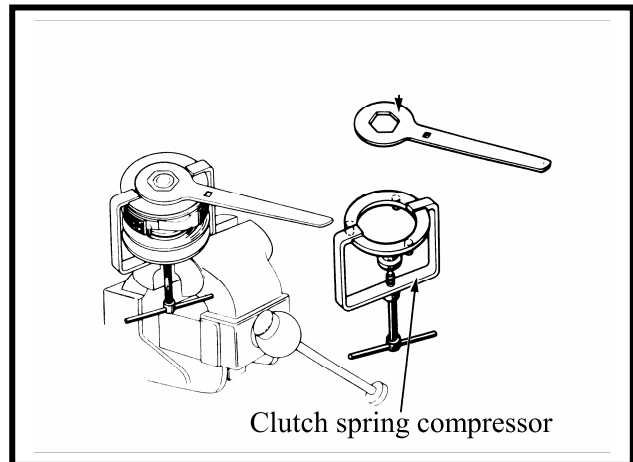

### CLUTCH/DRIVEN PULLEY INSTALLATION

Install the drive belt on the clutch/driven pulley and then install the clutch/driven pulley onto the drive shaft.

Clutch/Driven Pulley

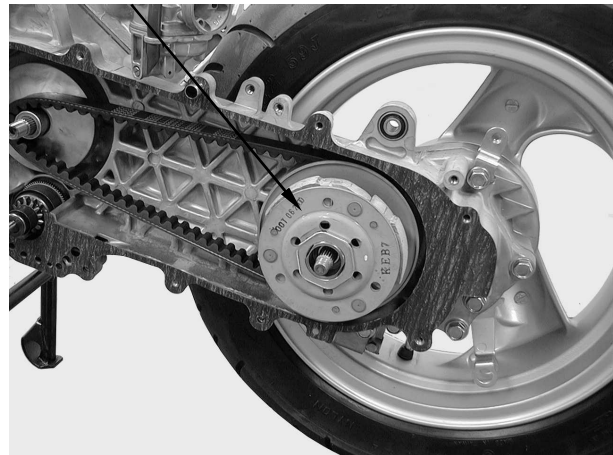

Install the clutch outer. Hold the clutch outer with the universal holder. Install and tighten the 14mm clutch outer nut.

**Torque:** 3.5□4.5kg-m

Special

Universal holder

E017

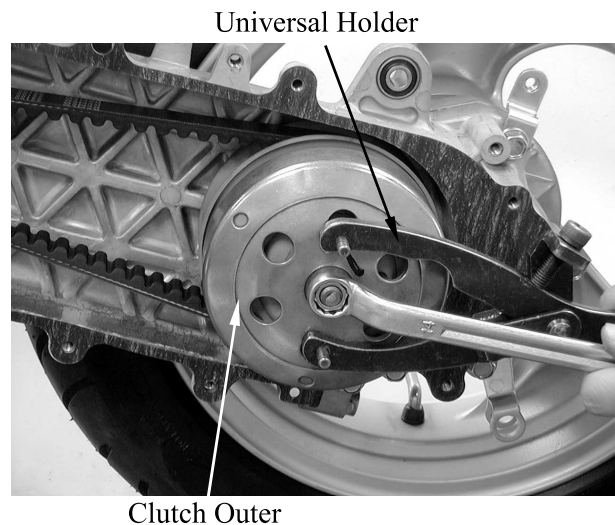

# 10. FINAL REDUCTION

---

**10**

---

## FINAL REDUCTION

---

SERVICE INFORMATION .....	10-2
TROUBLESHOOTING .....	10-2
FINAL REDUCTION DISASSEMBLY .....	10-3
FINAL REDUCTION INSPECTION.....	10-3
FINAL REDUCTION ASSEMBLY.....	10-6

# 10. FINAL REDUCTION

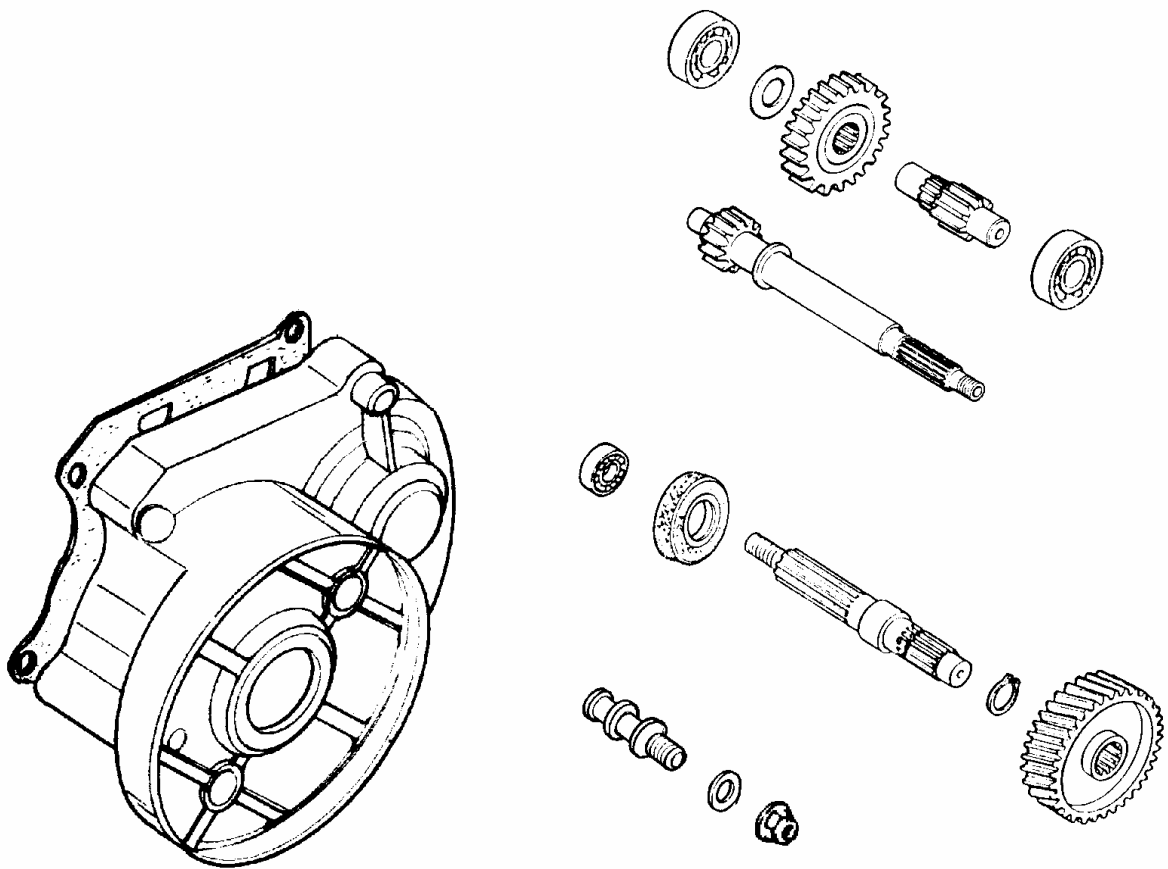

# 10. FINAL REDUCTION

---

## SERVICE INFORMATION

- These parts can be serviced with the engine installed in the frame.

Specified Oil: SAE90#

At disassembly: 0.12 liter

At change: 0.11 liter

## SPECIAL TOOLS

Universal bearing puller E037

Oil seal & bearing install E014

## TROUBLESHOOTING

### Engine starts but motorcycle won't move

- Damaged transmission
- Seized or burnt transmission

### Abnormal noise

- Worn, seized or chipped gears
- Worn bearing

### Oil leaks

- Oil level too high
- Worn or damaged oil seal

# 10. FINAL REDUCTION

## FINAL REDUCTION DISASSEMBLY

Remove the rear wheel. (⇒15-3)  
Remove the left crankcase cover. (⇒9-3)  
Remove the clutch/driven pulley. (⇒9-12)

Drain the transmission gear oil into a clean container.  
Remove the transmission case cover attaching bolts.  
Remove the transmission case cover.  
Remove the gasket and dowel pins.

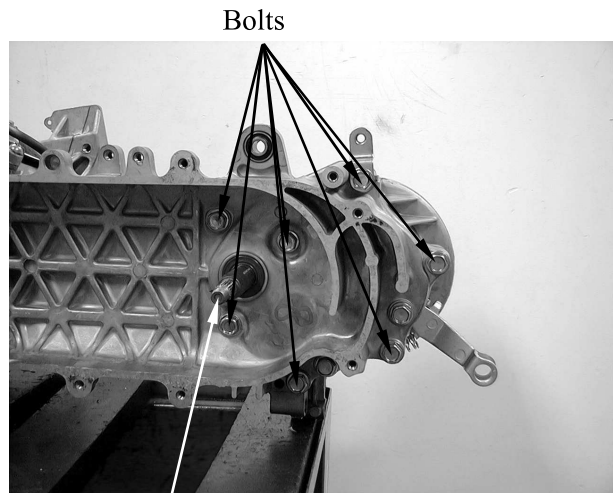

Driver shift

Remove the final gear and countershaft.

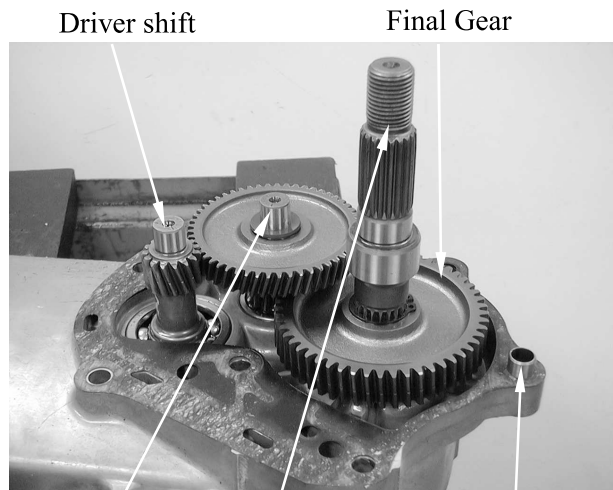

Countershaft Final Shaft Dowel Pin

## FINAL REDUCTION INSPECTION

Inspect the countershaft and gear for wear or damage.



## 10. FINAL REDUCTION

Inspect the final gear and final shaft for wear, damage or seizure.



Check the left crankcase bearings for excessive play and inspect the oil seal for wear or damage.

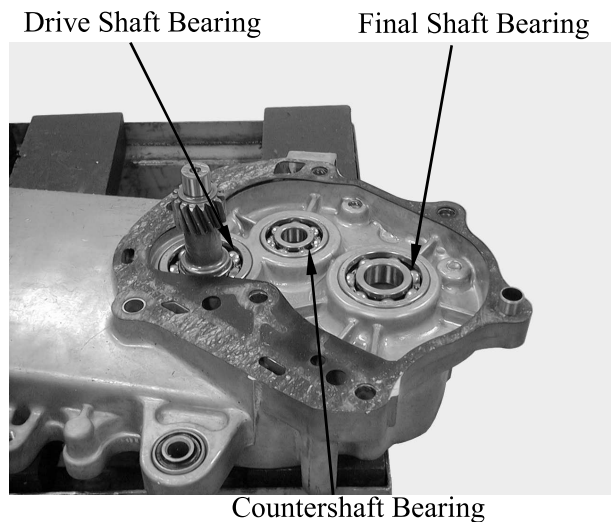

Inspect the drive shaft and gear for wear or damage.  
Check the transmission case cover bearings for excessive play and inspect the final shaft bearing oil seal for wear or damage.

Do not remove the transmission case cover except for necessary part replacement. When replacing the drive shaft, also replace the bearing and oil

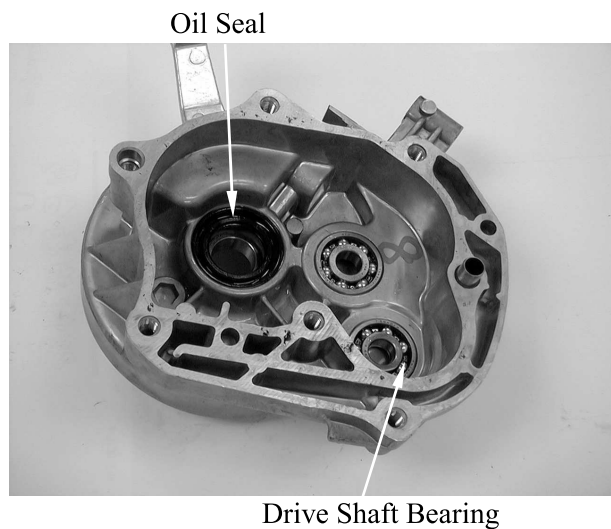

## 10. FINAL REDUCTION

### BEARING REPLACEMENT (Transmission Case Cover)

Remove the transmission case cover bearings using the bearing remover.  
Remove the final shaft oil seal.

Special

Universal bearing puller E037

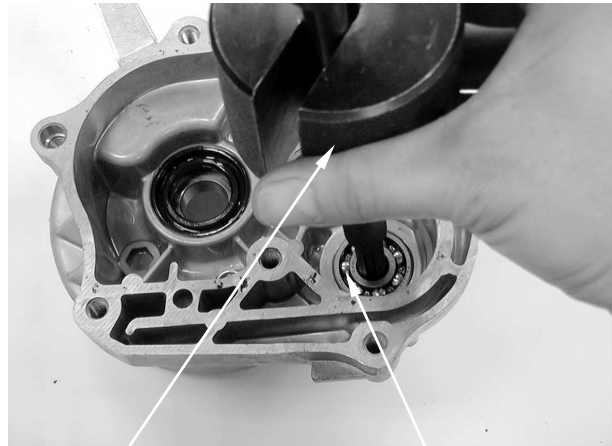

Bearing Remover Set

Drive Shaft Bearing

Drive new bearings into the transmission case cover.

Special

Oil seal & bearing install E014

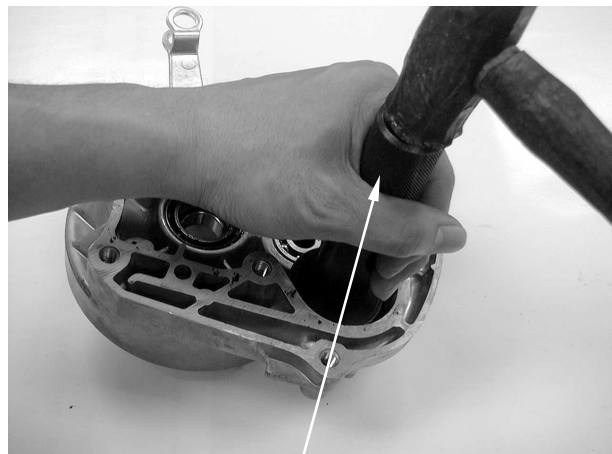

Bearing Outer Driver Handle

### BEARING REPLACEMENT (Left Crankcase Cover)

Remove the drive shaft.  
Remove the drive shaft oil seal.  
Remove the left crankcase bearings using the bearing remover.

Special

Universal bearing puller E037

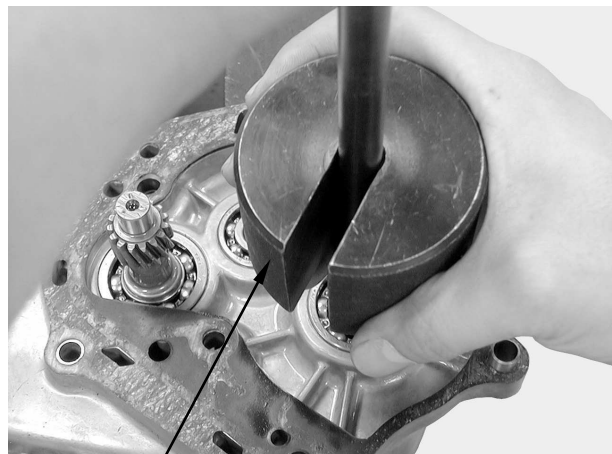

Bearing Remover Set, 15mm



## 10. FINAL REDUCTION

Drive new bearings into the left crankcase.  
Install a new drive shaft oil seal.

Special

Oil seal & bearing install E014

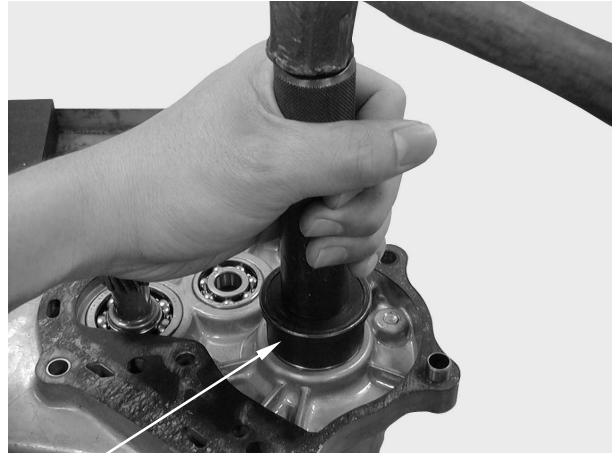

Bearing Outer Driver

### FINAL REDUCTION ASSEMBLY

Install the drive shaft into the left crankcase.

Drive Shaft

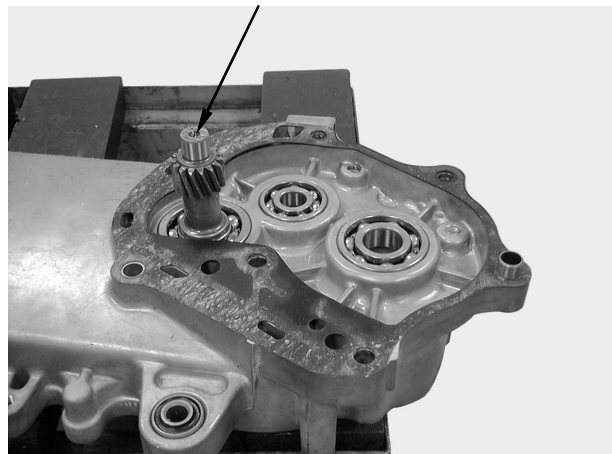

Install the final gear and final shaft into the left crankcase.



## 10. FINAL REDUCTION

Install the countershaft and gear into the left crankcase.  
Install the resin washer onto the counter-shaft.  
Install the dowel pins and a new gasket.

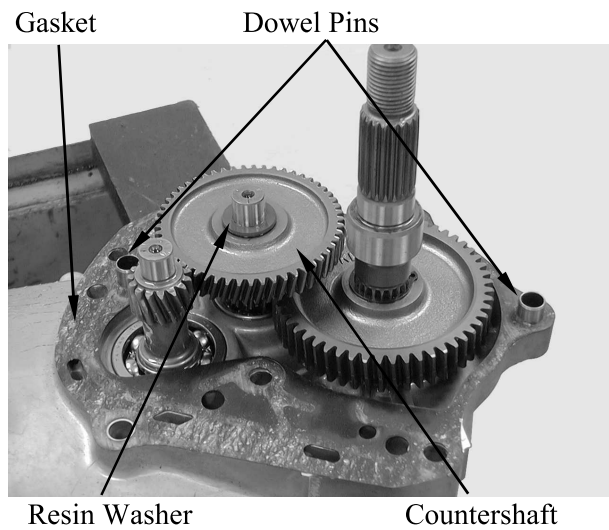

Install the transmission case cover.



Install and tighten the transmission case cover bolts.

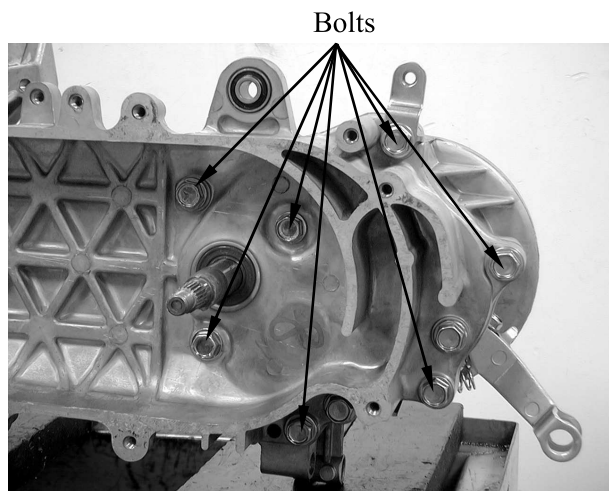

## 10. FINAL REDUCTION

After installation, fill the transmission case with the specified oil. (⇒3-5)



- Place the motorcycle on its main stand on level ground.
- Check the sealing washer for wear or damage.

**Specified Gear Oil:** SAE90#

**Oil Capacity:** at disassembly: 0.12 liter  
at change: 0.11 liter

Install and tighten the oil check bolt.

**Torque:** 1.0□1.5kg-m

Start the engine and check for oil leaks.

Oil Check Bolt Hole/Filler

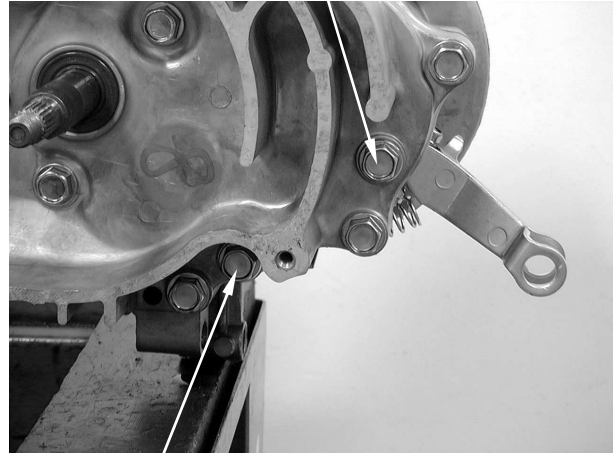

Drain Bolt

# 11. CRANKCASE/CRANKSHAFT

---

---

## CRANKCASE/CRANKSHAFT

---

SERVICE INFORMATION .....	11- 3
CRANKCASE/CRANKSHAFT (2-STROKE) .....	11- 4
CRANKCASE/CRANKSHAFT (4-STROKE) .....	11-10

# 11. CRANKCASE/CRANKSHAFT

(2-STROKE)

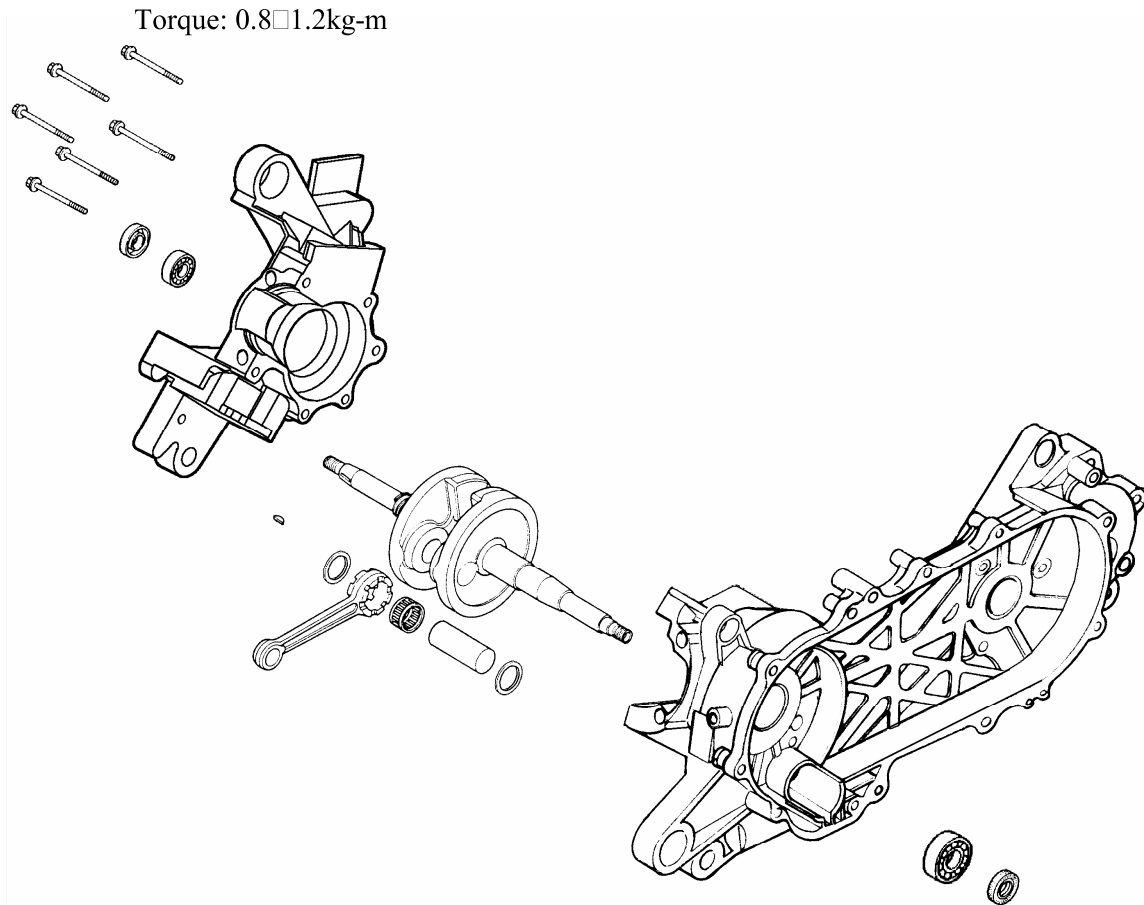

# 11. CRANKCASE/CRANKSHAFT

(4-STDROKE)

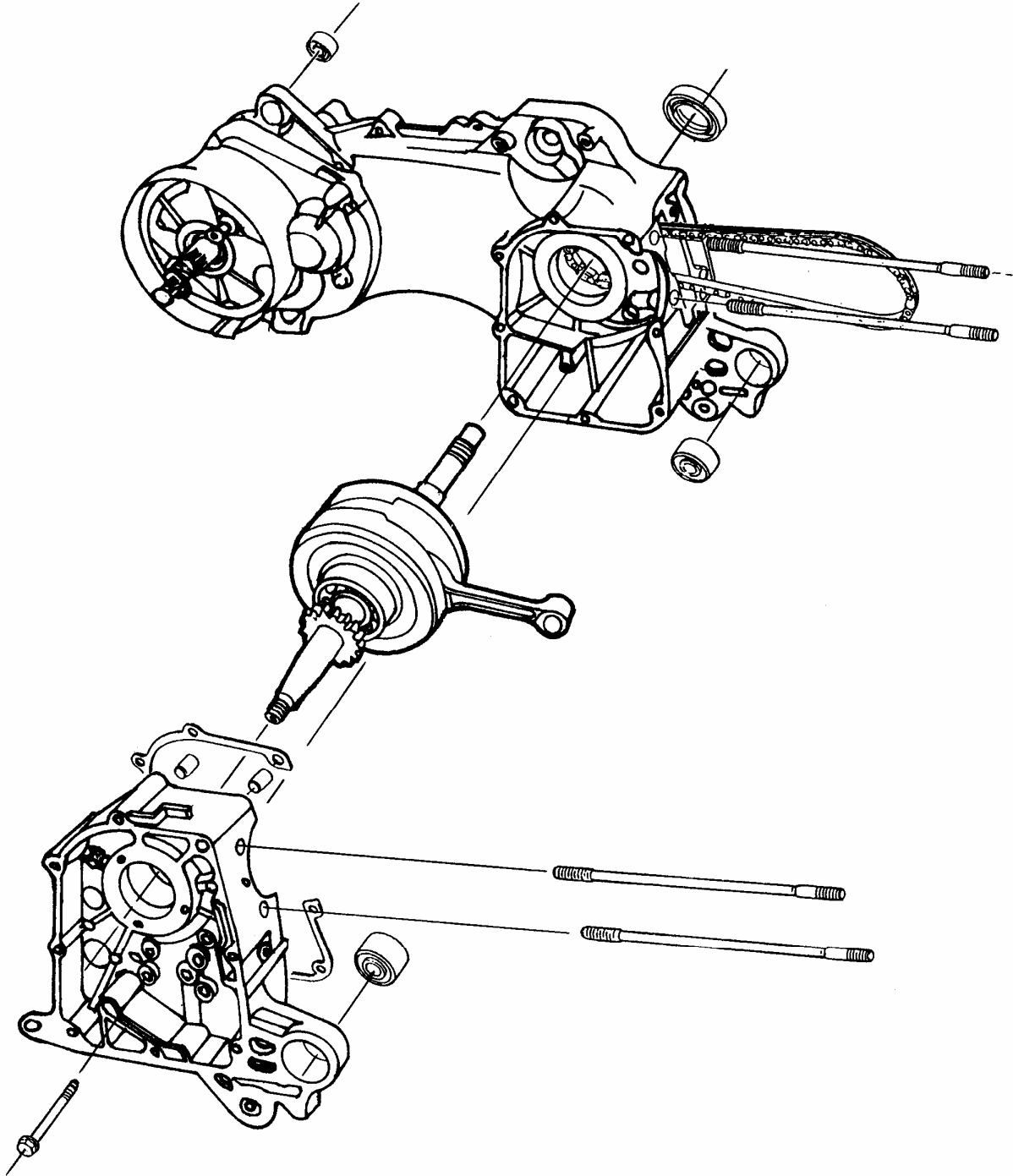

## SERVICE INFORMATION

### GENERAL INSTRUCTIONS

- This section covers crankcase separation to service the crankshaft. The engine must be removed for this operation.
- The following parts must be removed before separating the crankcase.
  - Cylinder head (⇒Chapter 6 (2-stroke))
  - Cylinder/piston (⇒Chapter 7)
  - Drive and driven pulleys (⇒Chapter 9)
  - A.C. generator (⇒Chapter 8)

### SPECIFICATIONS (2-Stroke)

	Item	Standard (mm)	Service Limit (mm)
Crankshaft	Connecting rod big end side clearance	—	0.6
	Connecting rod big end radial clearance	—	0.04
	Run out A/B	—	0.1/0.15

### SPECIFICATIONS (4-Stroke)

	Item	Standard (mm)	Service Limit (mm)
Crankshaft	Connecting rod small end free play	0.05□0.4	0.6
	Connecting rod big end radial clearance	0□0.008	0.05
	Run out	—	0.10

### TORQUE VALUES

- Crankcase bolt 0.8□1.2kgf-m  
Cam chain tensioner slipper bolt 0.8□1.2kgf-m (4-Stroke)

### SPECIAL TOOLS (2-stroke)

- Crankcase puller E026  
Universal bearing puller E030  
Crankshaft install tool E016  
Crankcase assembly tool E024  
Oil seal and bearing install tool E014

### TROUBLESHOOTING

#### Abnormal engine noise

- Excessive crank journal bearing play
- Excessive crankpin bearing play
- Excessive transmission bearing play

# 11. CRANKCASE/CRANKSHAFT

## CRANKCASE/CRANKSHAFT

### (2-STROKE)

#### SEPARATION

Remove the crankcase attaching bolts.

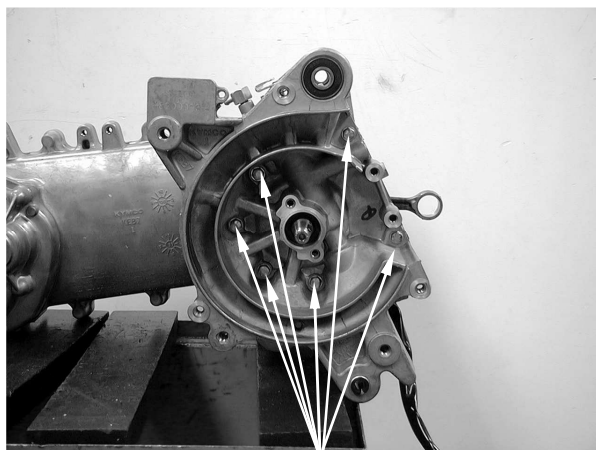

Bolt

Attach the crankcase puller on the right crankcase and remove the right crankcase from the left crankcase.

Special

Crankcase puller

E026

Crankcase Puller

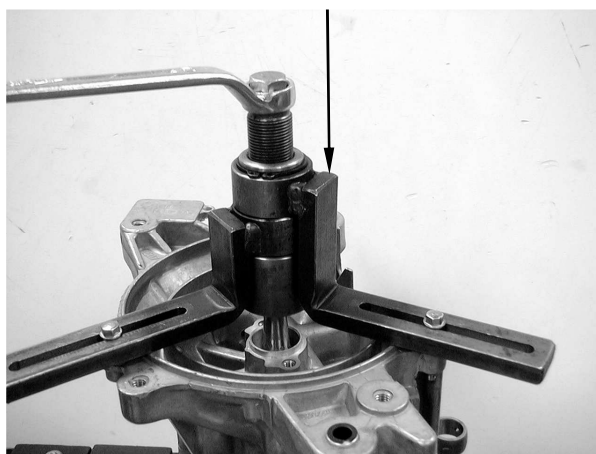

## CRANKSHAFT REMOVAL

Attach the crankcase puller on the left crankcase and remove the crankshaft from the left crankcase.

When removing the crankshaft, do it slowly and gently.

Special

Crankcase puller

E026

Crankcase Puller

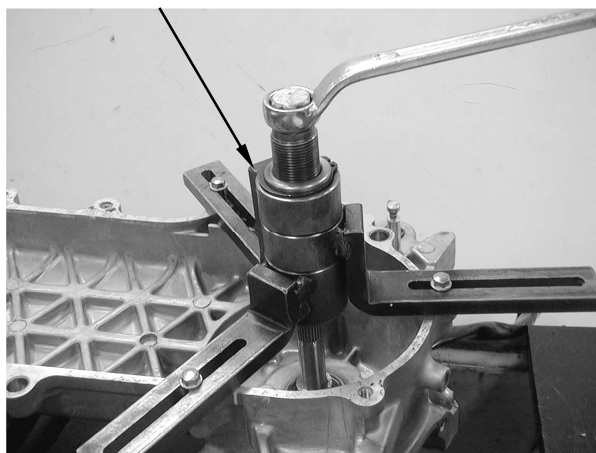



# 11. CRANKCASE/CRANKSHAFT

Remove the remaining bearing on the crankshaft side using the universal bearing puller.

When separating the crankcase, the oil seals must be removed. Replace the oil seals with new ones.

Special

Crankshaft bearing puller E030

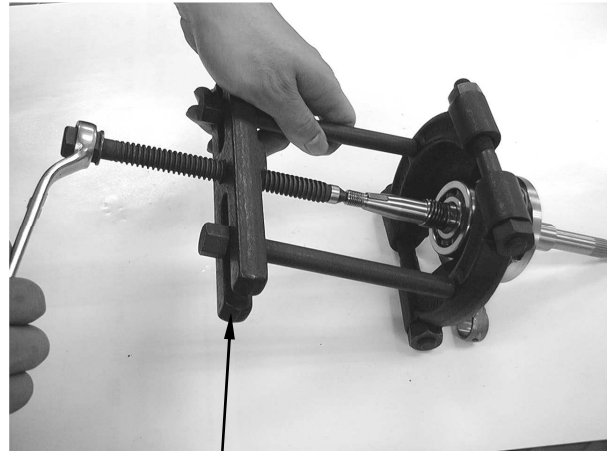

Universal Bearing Puller

## CRANKSHAFT INSPECTION

Measure the connecting rod big end side clearance.

**Service Limit:** 0.6mm replace if over

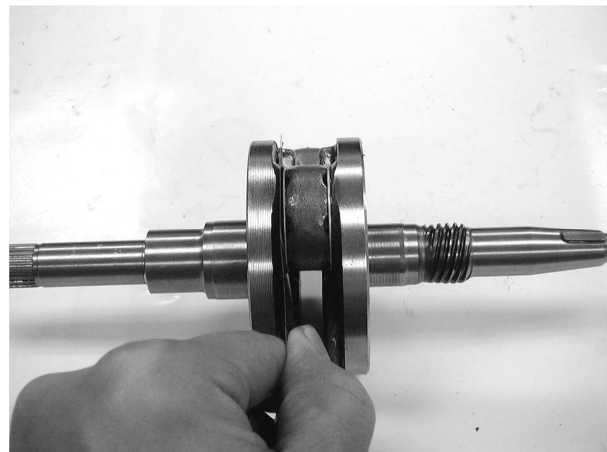

Measure the connecting rod big end radial clearance at two points in the X and Y directions.

**Service Limit:** 0.04mm replace if over

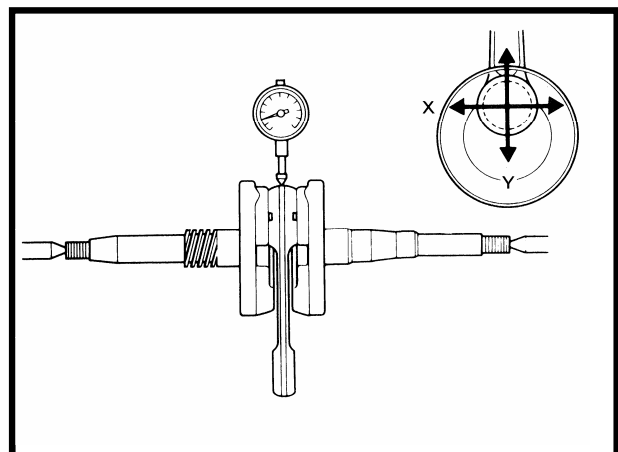

# 11. CRANKCASE/CRANKSHAFT

Measure the crankshaft runout.

Service Limit	
A	B
0.150mm replace if over	0.100mm replace if over

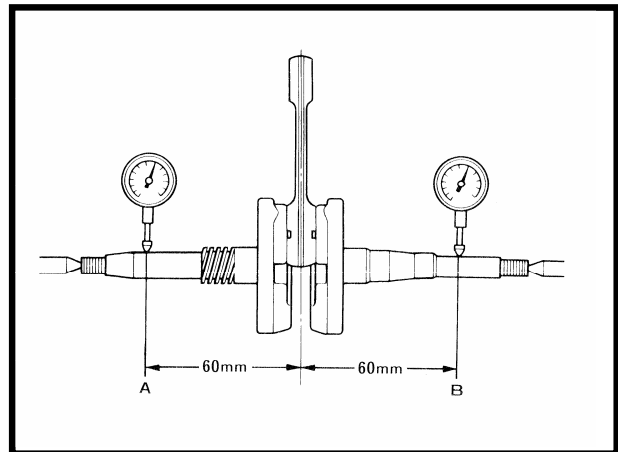

Check the crankshaft bearings for excessive play. The bearings must be replaced if they are noisy or have excessive play.

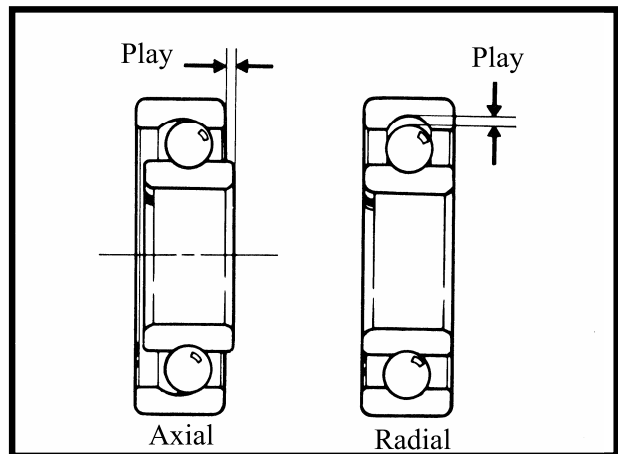

## CRANKSHAFT INSTALLATION

Wash the crankshaft in cleaning solvent and then check for cracks or other faults.

- After check, apply clean engine oil to all moving and sliding parts.
- Remove all gasket material from the crankcase mating surfaces. Dress any roughness or irregularities with an oil stone.



# 11. CRANKCASE/CRANKSHAFT

Drive a new crankshaft bearing into the right crankcase.

Special

Oil seal & bearing install E014

Bearing Outer Driver Handle A

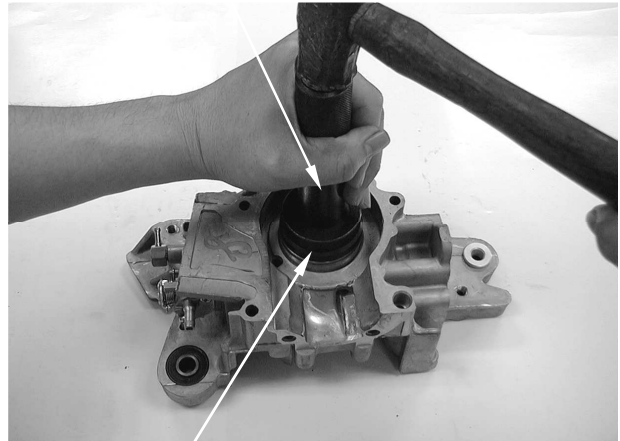

Bearing Outer Driver, 37x40mm  
Bearing Driver Pilot, 17mm

The distance between the left crankcase oil seal and crankcase surface is about 1.0mm.

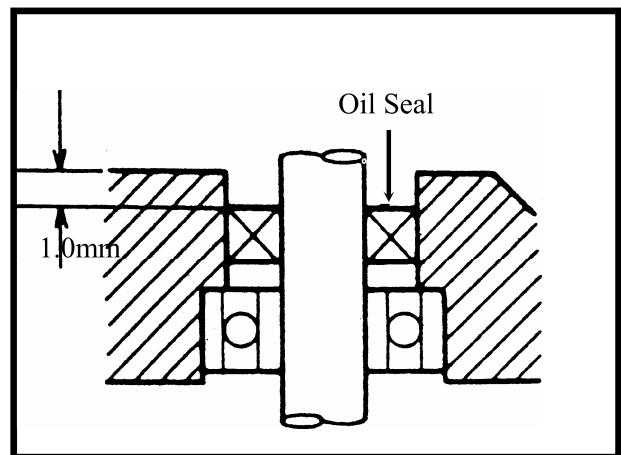

Drive a new crankshaft bearing into the left crankcase.

Special

Oil seal & bearing install E014

The distance between the right crankcase oil seal and crankcase surface is about  $12.5 \pm 0.5$  mm.

When installing the oil seal, be careful to press it with even force.

Bearing Outer Driver Handle A



Bearing Outer Driver, 42x47mm  
Pilot, 20mm

# 11. CRANKCASE/CRANKSHAFT

## ASSEMBLY

Install the dowel pins and a new gasket to the crankcase mating surface.

Dowel Pins

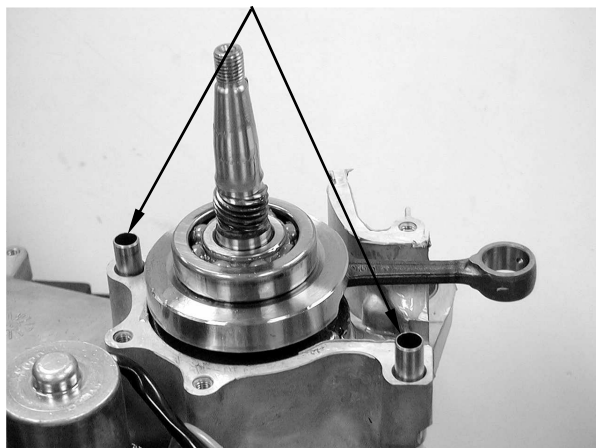

Assemble the crankcase halves.

Special

Crankcase assembly tool E024



Crankcase Assembly Tool

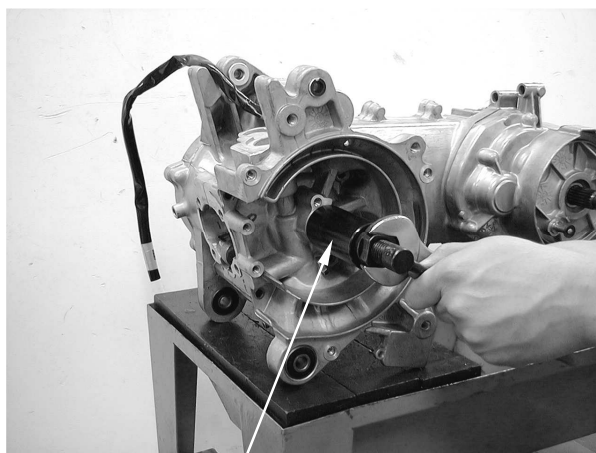

Crankcase Assembly Tool

# 11. CRANKCASE/CRANKSHAFT

Install and tighten the crankcase bolts in a crisscross pattern in several steps.

□ After assembly, check the crankshaft for smooth operation.

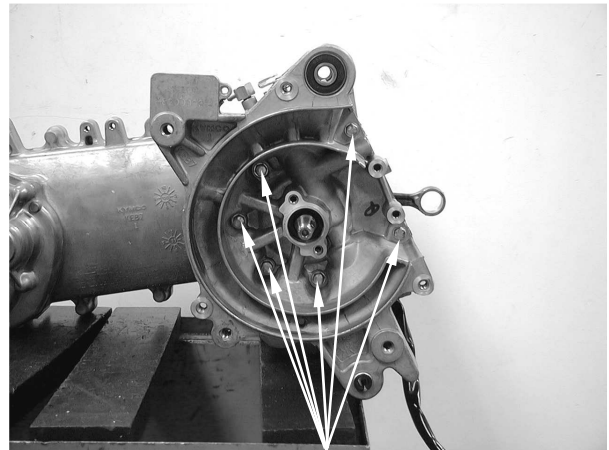

Bolt

# 11. CRANKCASE/CRANKSHAFT

## CRANKCASE/CRANKSHAFT

### (4-STROKE)

#### REMOVAL

Remove nuts and take out the bolts from center stand.

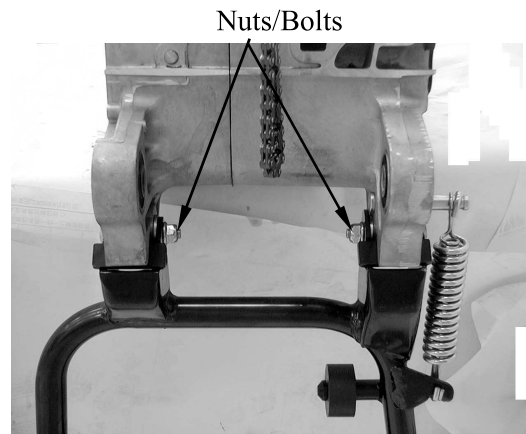

Remove spring and center stand from crankcase.

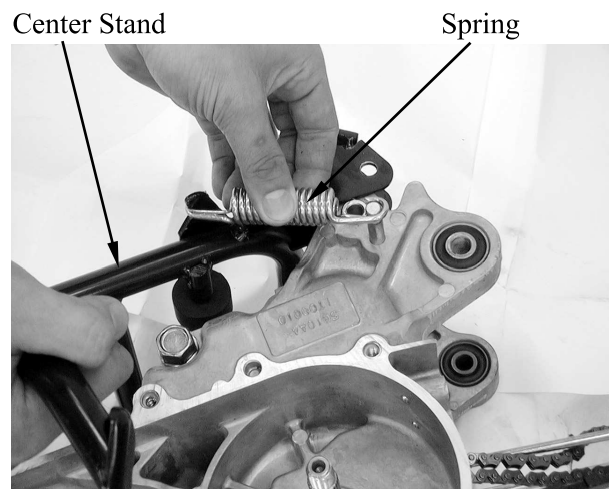

Remove the crankcase attaching bolt.  
Separate the left and right crankcase halves.

- Do not damage the crankcase gasket surface.
- Never use a driver to pry the crankcase mating surfaces apart.

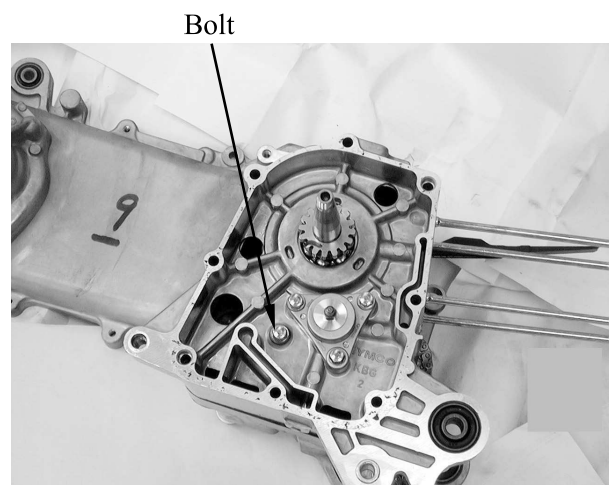

## 11. CRANKCASE/CRANKSHAFT

Remove the crankshaft from the left crankcase.

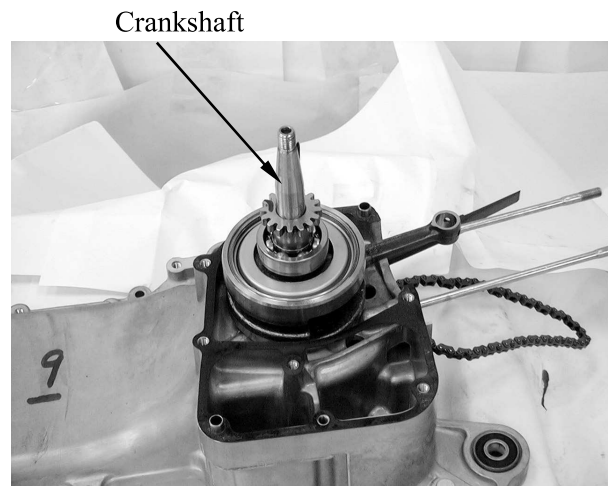

Remove the cam chain.  
Remove the gasket and dowel pins.

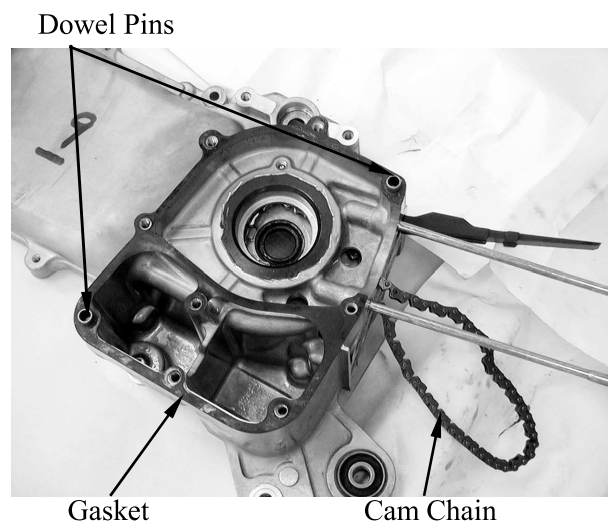

Clean off all gasket material from the crankcase mating surfaces.

□ Avoid damaging the crankcase mating surfaces.

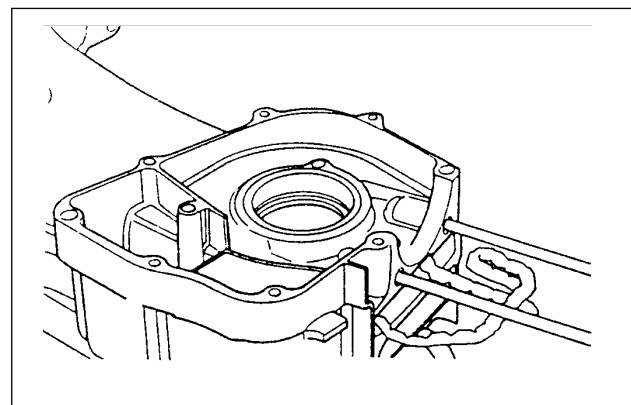

# 11. CRANKCASE/CRANKSHAFT

## CRANKSHAFT INSPECTION

Measure the connecting rod small end I.D.

**Service Limit:** 13.06 mm replace if over

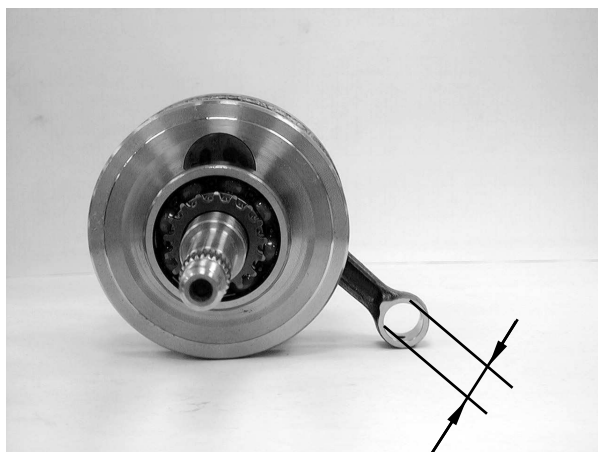

Measure the connecting rod small end free play (A).

Out of specification (0.05 ~ 0.4 mm) →  
Replace the crankshaft.

Measure the crankshaft run out (B).

**Service Limit:** 0.10mm replace if over

Measure the connecting rod big end side clearance (C).

**Service Limit:** 0.05mm replace if over

Measure the crank width (D).

Out of specification (42.2 ~ 42.15 mm) →  
Replace the crankshaft.

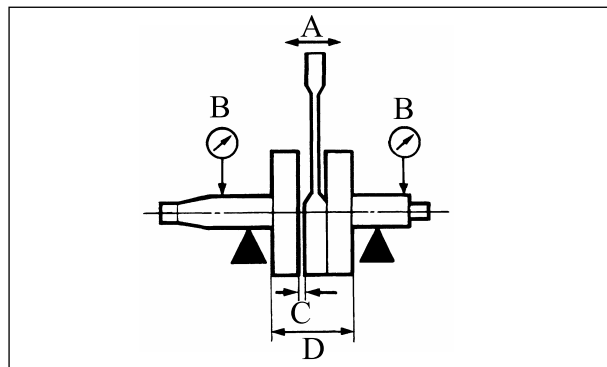

Turn the crankshaft bearings and check for excessive play.

Measure the crankshaft bearing play.

**Service Limit:**

Axial : 0.20mm replace if over

Radial : 0.05mm replace if over

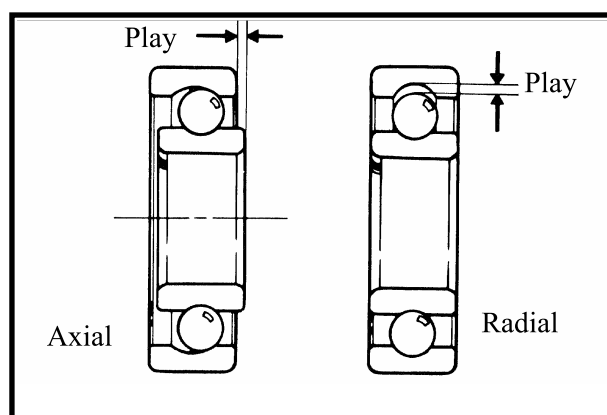



# 11. CRANKCASE/CRANKSHAFT

## CRANKCASE/BALANCER INSTALLATION

Install the cam chain into the left crankcase.

Install the dowel pins and a new gasket onto the left crankcase.

- Place the right crankcase over the crankshaft and onto the left crankcase.



Install the crankshaft into the left crankcase.

- When installing the crankshaft, be careful not to damage the oil seal.



Install the right crankcase.  
Tighten the crankcase attaching bolt.  
**Torque: 0.8~1.2kgf-m**

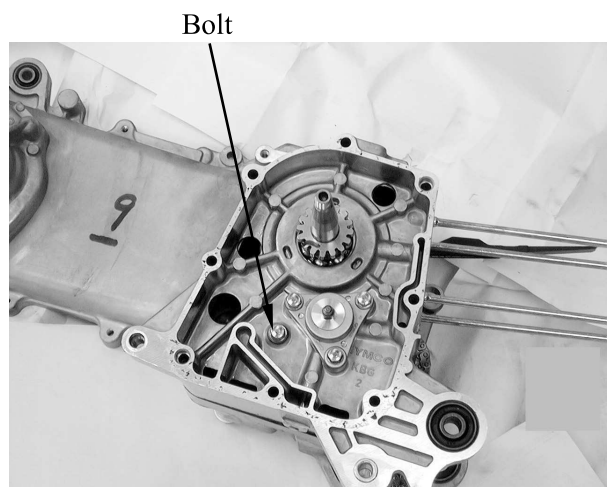

# 12. CARBURETOR

---

# 12

---

## CARBURETOR

---

SERVICE INFORMATION (2-STROKE).....	12- 2
SERVICE INFORMATION (4-STROKE).....	12- 3
THROTTLE VALVE (2-STROKE) .....	12- 5
CARBURETOR (2-STROKE).....	12- 7
AIR SCREW ADJUSTMENT (2-STROKE) .....	12-13
REED VALVE (2-STROKE).....	12-14
CARBURETOR (4-STROKE).....	12-15
FUEL TANK.....	12-28

# 12. CARBURETOR

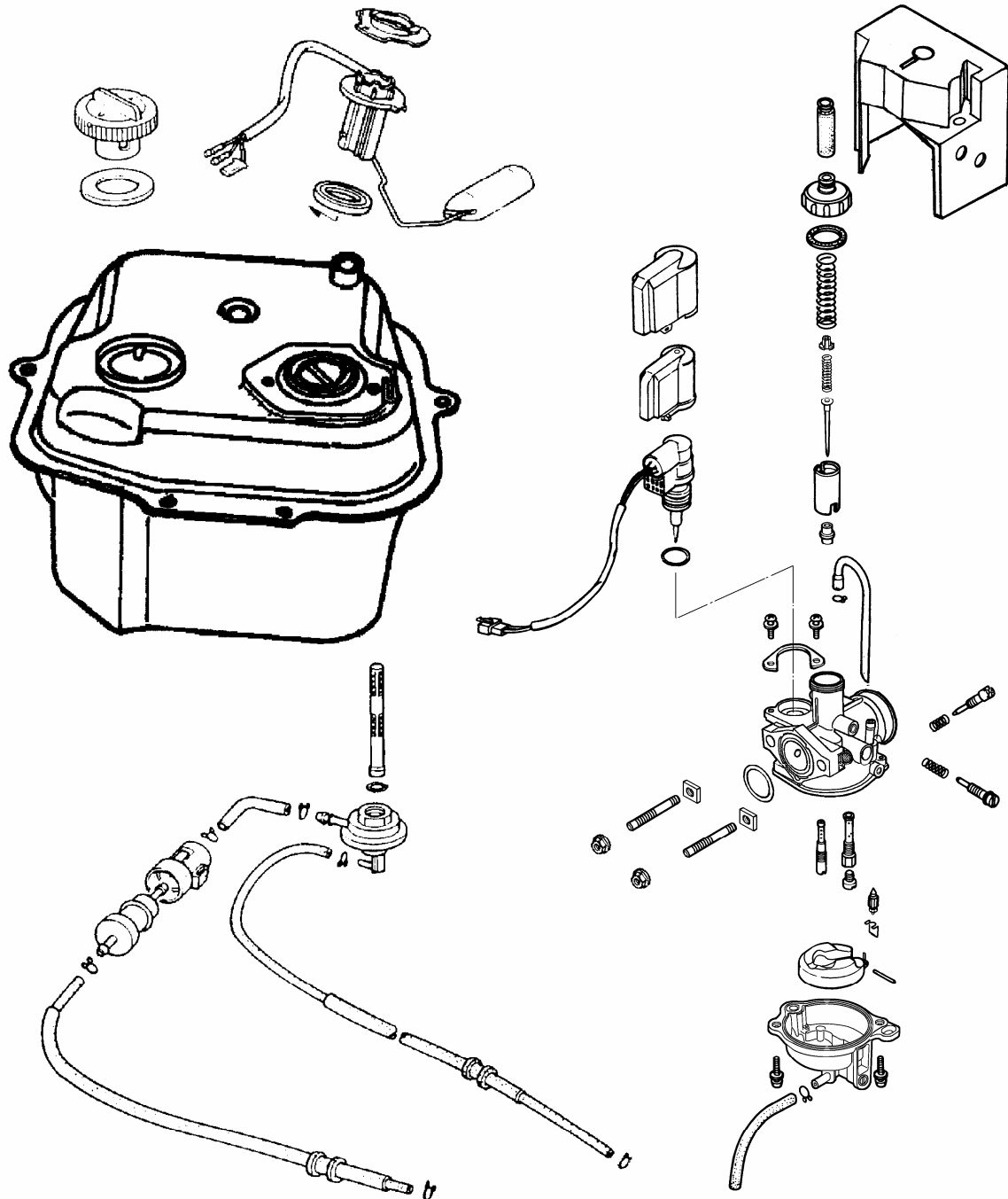

# 12. CARBURETOR

## SERVICE INFORMATION (2-STROKE)

### GENERAL INSTRUCTIONS

- When working with gasoline, keep away from sparks and flames..
- Note the locations of O-rings when disassembling and replace them with new ones during assembly.
- All cables, fuel lines and wires must be routed and secured at correct locations.
- Bleed air from the oil lines whenever they are disconnected.

SPECIFICATIONS	VITALITY 50
Setting mark	PB168 
Type	PB 14
Float level	8.6mm
Main jet	#80 (Speed limit type: #72)
Slow jet	#35
Air screw opening	2 1/2 ± 1/2
Idle speed	1850±100rpm
Throttle grip free play	2-6mm

### SPECIAL TOOL

Float level gauge

### TROUBLESHOOTING

#### Engine does not start

- No fuel in tank
- Too much fuel getting to cylinder
- Clogged fuel filter
- Clogged air cleaner

#### Lean mixture

- Clogged fuel jets
- Clogged fuel cap vent
- Clogged fuel filter
- Bent, kinked or restricted fuel line

- Faulty float valve
- Float level too low
- Clogged air cleaner

#### Engine idles roughly, stalls or runs poorly

- Incorrect idle speed
- Ignition malfunction
- Compression too low
- Incorrectly adjusted air screw
- Incorrect float level
- Clogged air cleaner
- Intake air leaks
- Fuel contaminated
- Faulty reed valve
- Clogged fuel jets

#### Rich mixture

- Faulty float valve
- Float level too high
- Clogged air jets

# 12. CARBURETOR

## SERVICE INFORMATION (4-STROKE)

### GENERAL INSTRUCTIONS



Gasoline is very dangerous. When working with gasoline, keep sparks and flames away from the working area.  
Gasoline is extremely flammable and is explosive under certain conditions. Be sure to work in a well-ventilated area.

- When disassembling the carburetor, be sure to service the vacuum piston and float chamber.
- Do not bend or twist control cables. Damaged control cables will not operate smoothly.
- When disassembling fuel system parts, note the locations of O-rings. Replace them with new ones during assembly.
- Before float chamber disassembly, loosen the drain screw to drain the residual gasoline into a clean container.
- After the carburetor is removed, plug the intake manifold side with a clean shop towel to prevent foreign matters from entering.
- Remove the vacuum diaphragm before cleaning the carburetor air and fuel passages with compressed air to avoid damaging the vacuum diaphragm.
- When the motorcycle is not used for over one month, drain the residual gasoline from the float chamber to avoid erratic idling and clogged slow jet due to deteriorated fuel.

### SPECIFICATIONS

Item	Standard
Setting mark	CVK104A
Type	CVK 18
Float level (mm)	20.5
Main jet	#82 (speed limited: #80)
Slow jet	#35
Idle speed	1800rpm
Throttle grip free play	2-6mm
Pilot screw opening	2±1/2

## 12. CARBURETOR

---

### TROUBLESHOOTING

#### Engine is hard to start

- No spark at plug (⇒Section 16)
- Compression too low
- No fuel to carburetor
  - Clogged fuel filter
  - Restricted fuel line
  - Faulty float valve
  - Incorrectly adjusted float level
- Engine flooded with fuel
  - Clogged air cleaner
  - Fuel overflowing
- Intake air leak
- Contaminated fuel
- Faulty auto bystarter
- Clogged idle system or auto bystarter passages

#### Rich mixture

- Faulty auto bystarter
- Faulty float valve
- Float level too high
- Clogged air jets
- Dirty air cleaner
- Flooded carburetor

#### Backfiring at deceleration

- Lean mixture in idle system
- Improper air cut-off valve operation

#### Misfiring during acceleration

- Faulty ignition system
- Lean mixture
- Faulty accelerating pump

#### Engine idles roughly, stalls or runs poorly

- Clogged fuel system
- Ignition malfunction
- Rich or lean mixture
- Contaminated fuel
- Intake air leak
- Incorrect idle speed
- Incorrectly adjusted pilot screw
- Clogged idle system or auto bystarter passages
- Incorrectly adjusted float level

#### Lean mixture

- Clogged fuel jets
- Faulty float valve
- Float level too low
- Clogged fuel system
- Intake air leak
- Improper vacuum piston operation
- Improper throttle operation

## THROTTLE VALVE

### (2-STROKE)

#### DISASSEMBLY

Remove the met-in box. (⇒13-5)

Remove the center cover and spark plug cover. (⇒13-6)

Loosen the carburetor top and remove the throttle valve.



Carburetor Top

Disconnect the throttle cable from the throttle valve.

Throttle Valve

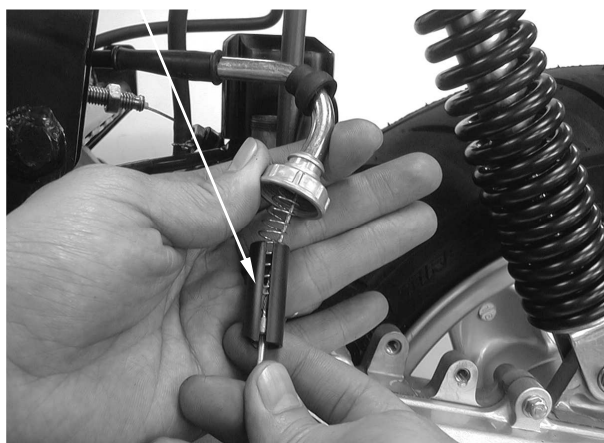

Remove the throttle valve spring, carburetor top and rubber seal.

Rubber Seal

Carburetor Top



Spring

## 12. CARBURETOR

Remove the jet needle by removing the needle clip.  
Check the jet needle and throttle valve for wear or damage.

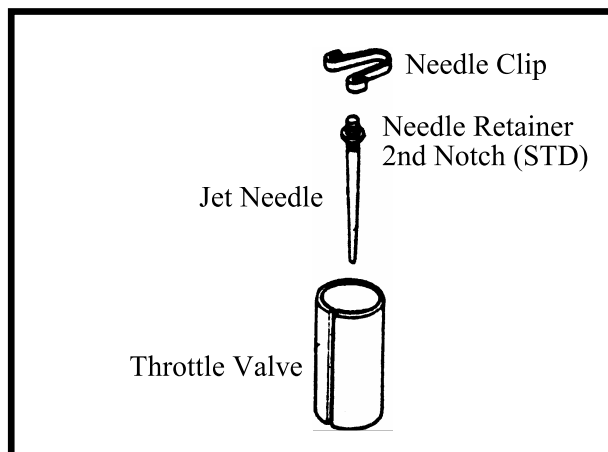

### THROTTLE VALVE INSTALLATION

Install the jet needle on the throttle valve and secure with the needle clip.

Install the rubber seal on the throttle cable and then install the carburetor top and throttle valve spring.

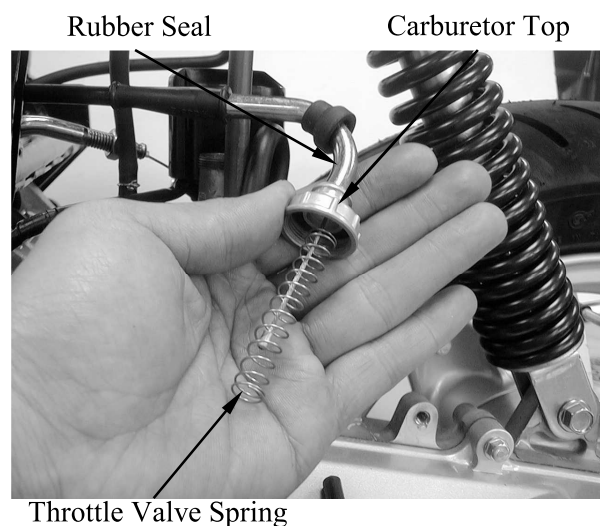

Connect the throttle cable to the throttle valve.

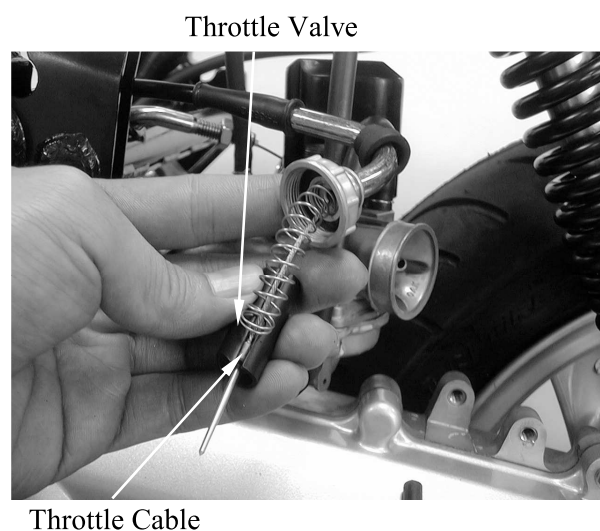



## 12. CARBURETOR

Install the throttle valve by aligning the groove in the throttle valve with the throttle stop screw.

Groove



Tighten the carburetor top.  
After installation, perform the following adjustments and inspections.

- Throttle cable free play (⇒3-16)
- Idle speed adjustment (⇒3-10)

Carburetor Top



### CARBURETOR (2-STROKE)

#### REMOVAL

Remove the met-in box. (⇒13-5)  
Remove the center cover. (⇒13-6)  
Remove the air cleaner housing. (⇒5-2)  
Disconnect the fuel tube. (⇒5-2)  
Disconnect the auto bystarter wire connector. (⇒5-2)  
Remove the carburetor top and throttle valve from the carburetor. (⇒12-5)

Loosen the drain bolt to drain fuel from the carburetor.

Disconnect oil outlet tube from carburetor.

Oil Outlet Tube

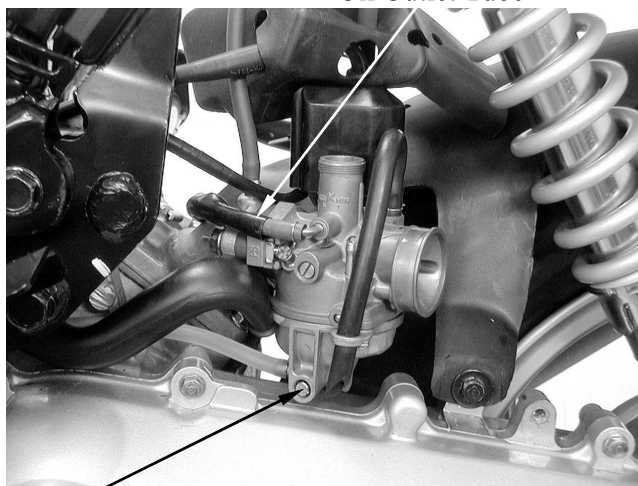

Drain Bolt

## 12. CARBURETOR

Remove the two carburetor lock nuts.  
Remove the carburetor and carburetor insulator.

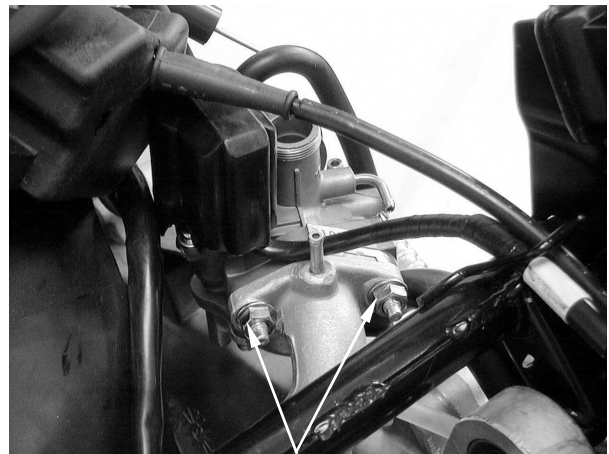

Nuts

### AUTO BYSTARTER

#### AUTO BYSTARTER INSPECTION

Measure the resistance between the auto bystarter wire terminals.

**Resistance:**  $5\Omega$  (10 minutes minimum after stopping the engine)

If the resistance exceeds  $5\Omega$ , replace the auto bystarter with a new one.

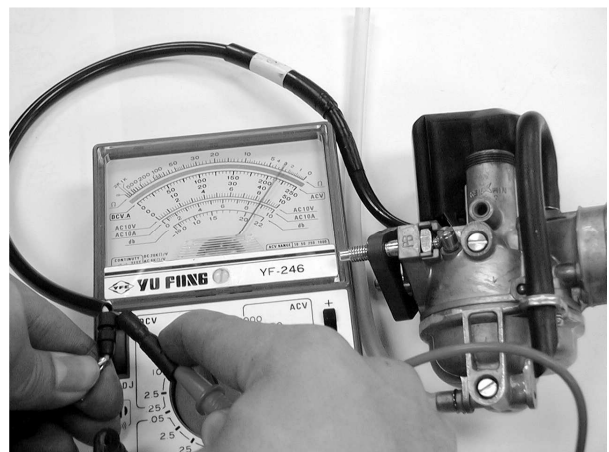

After the engine stops for 30 minutes, connect a hose to the fuel enriching circuit and blow the hose with mouth.  
If air cannot be blown into the hose (clogged), the auto bystarter is faulty. Replace it with a new one.

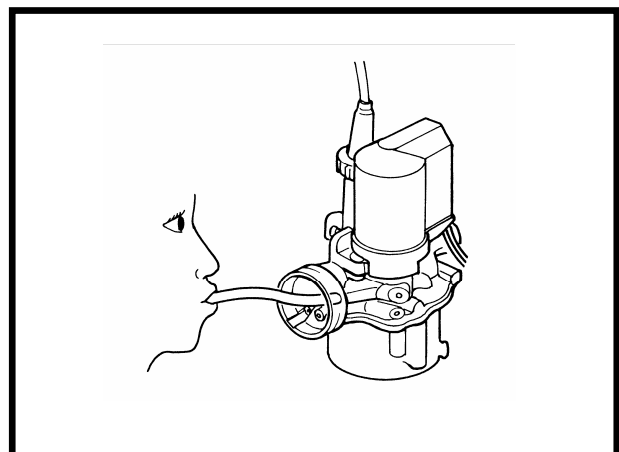

## 12. CARBURETOR

Connect the auto bystarter yellow wire to the battery positive (+) terminal and green/black wire to the battery negative (-) terminal and wait 5 minutes.

Connect a hose to the fuel enriching circuit and blow the hose with mouth.

If air can be blown into the hose, the auto bystarter is faulty and replace it with a new one.

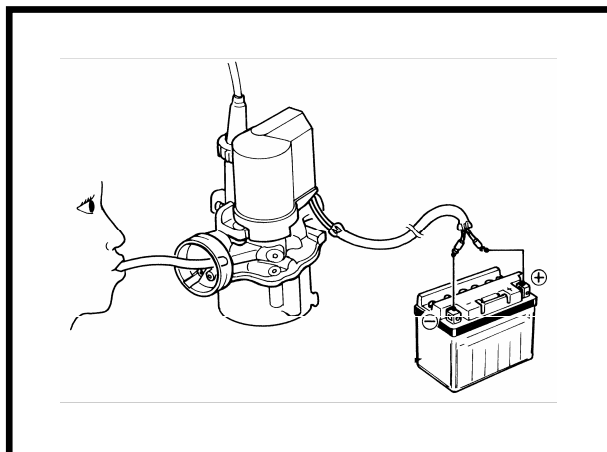

### AUTO BYSTARTER REMOVAL

Remove the auto bystarter cover.

Remove the two auto bystarter set plate screws to remove the auto bystarter.

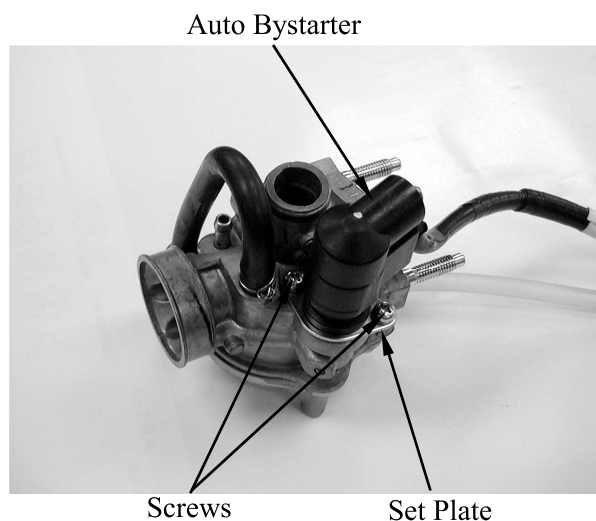

Check the auto bystarter valve and needle for wear or damage.

Check the O-ring for wear or damage.

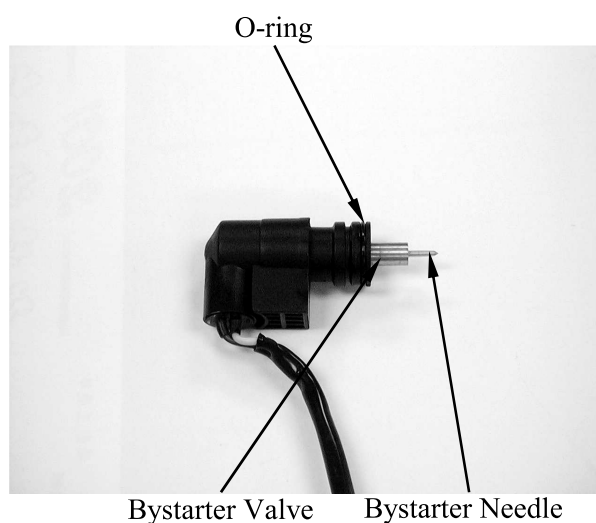

## 12. CARBURETOR

### AUTO BYSTARTER INSTALLATION

Install the auto bystarter into the carburetor body until it bottoms..  
Install the set plate and then tighten the two screws.

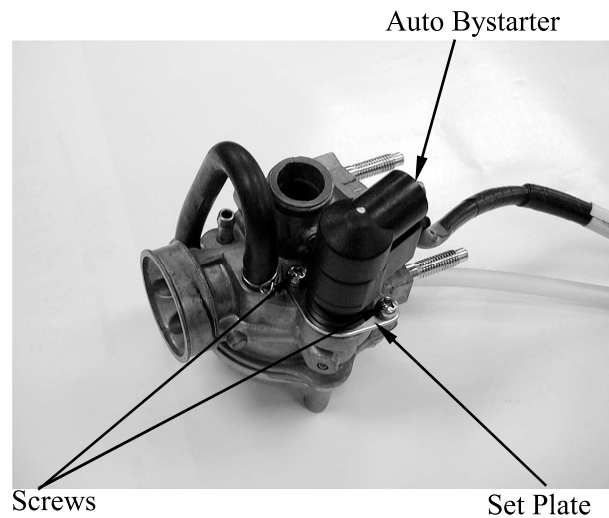

### FLOAT CHAMBER

Remove the two float chamber screws and the float chamber.

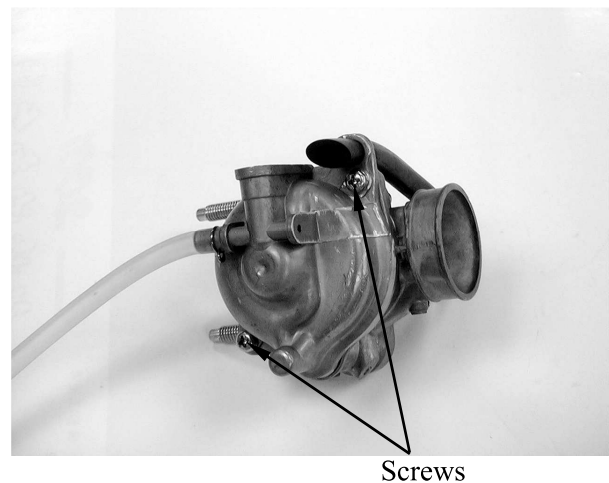

Remove the screw and O-ring.  
Remove the float pin, float and float valve.

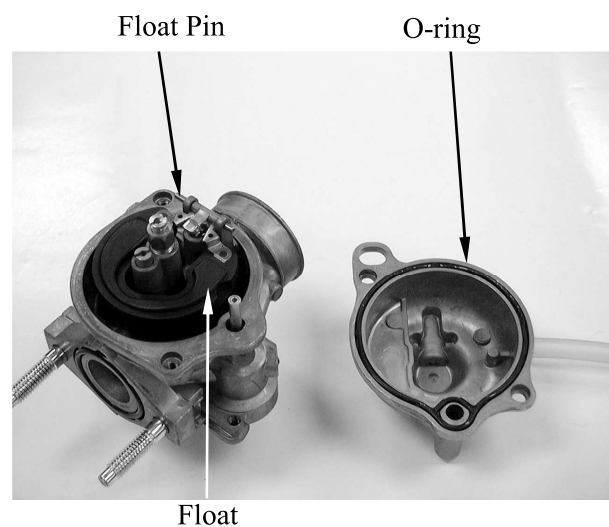

## 12. CARBURETOR

### FLOAT/FLOAT VALVE INSPECTION

Inspect the float for damage or fuel inside the float.  
Check the float valve seat for wear or damage.

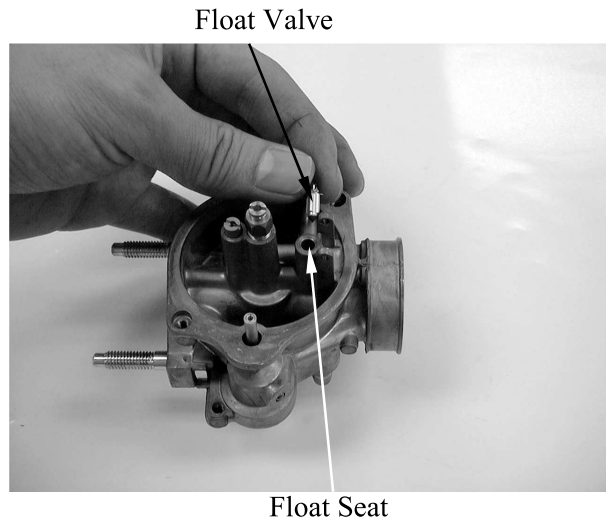

### JETS/SCREWS REMOVAL

Before removing the throttle stop screw or air screw, record the number of rotations until it seats lightly. Then, remove them.

□ Do not force the air screw against its seat to prevent damage.

Remove the main jet and needle jet holder.

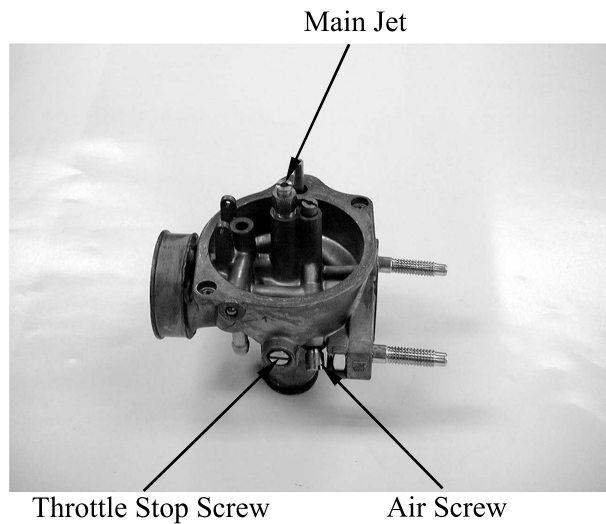

### CARBURETOR PASSAGES CLEANING

Blow compressed air through all passages of the carburetor body with an air gun.

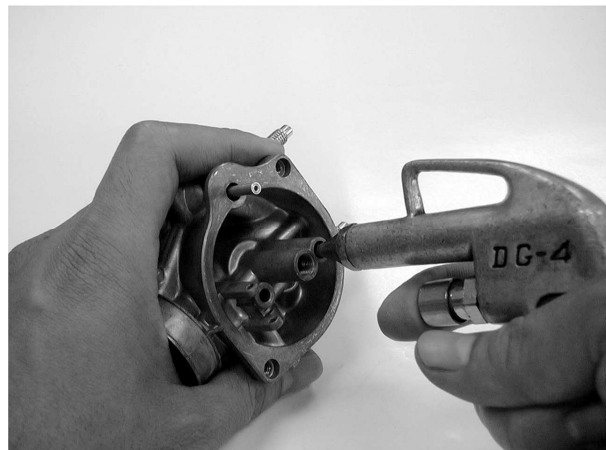

## 12. CARBURETOR

### FLOAT CHAMBER ASSEMBLY

Install the main jet and needle jet holder.  
Install the air screw and throttle stop screw according to the rotations recorded.

□ If the air screw must be replaced, be sure to perform the air screw adjustment again.

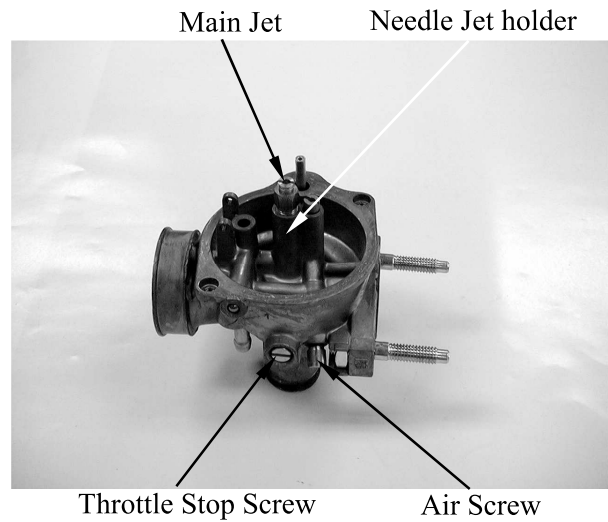

Install the float valve, float and float pin.  
Tighten the float screw securely.

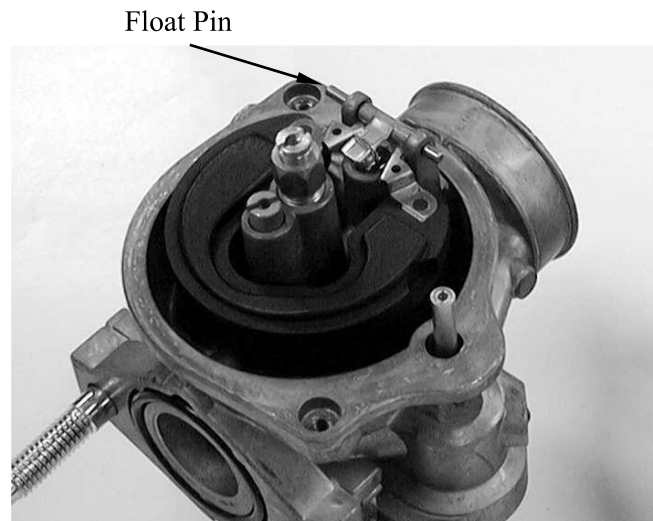

### FLOAT LEVEL INSPECTION

Slightly tilt the carburetor and measure the float level with the float valve just connecting the float arm.

**Float Level:** 8.6mm

Replace the float if the level is out of the specified level range.  
Install the O-ring.  
Check the operation of the float and install the float chamber.  
Tighten the screws.

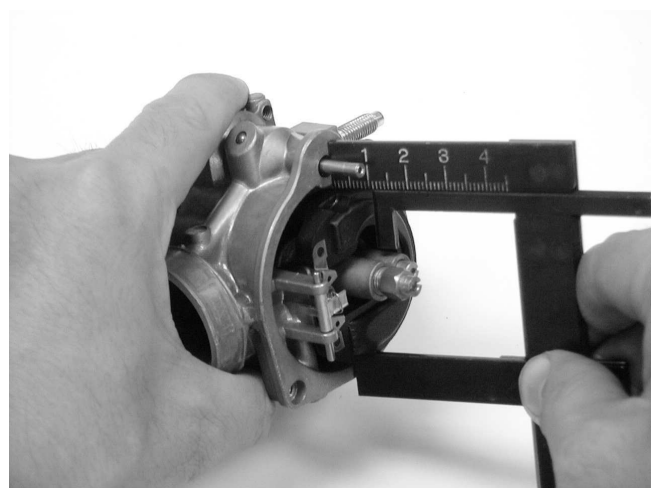

## 12. CARBURETOR

### CARBURETOR INSTALLATION

- When installation, do not allow foreign particles to enter the carburetor.

Check the carburetor insulator and O-ring for wear or damage.  
Install the carburetor and insulator onto the intake manifold and tighten the two lock nuts.  
Connect the fuel tube and auto bystarter wire connector.

- Route the auto bystarter wire correctly and properly.

Install the carburetor top. (⇒12-5)  
Install the air cleaner onto the carburetor and tighten the band screw.

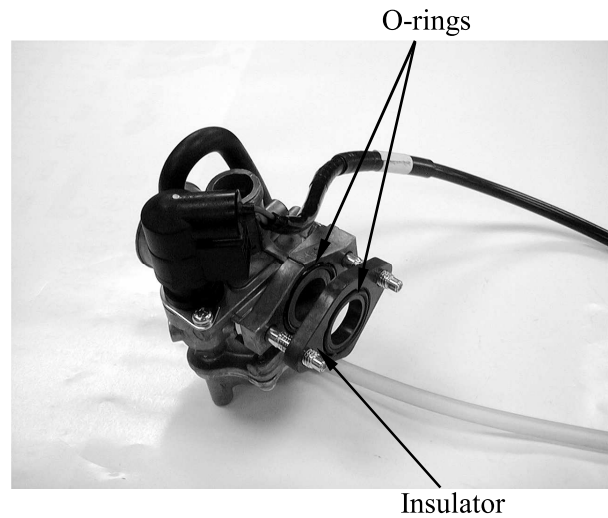

### AIR SCREW ADJUSTMENT (2-STROKE)

- Do not force the air screw against its seat to prevent damage.

Turn the air screw (1) clockwise until it seats lightly and back it to the specification given.

**Air Screw Opening:**  $2 \frac{1}{2} \pm \frac{1}{2}$  turns

Start the engine and turn the air screw in or out slowly to obtain the highest engine speed.

- Do not force the air screw against its seat to prevent damage.

Turn the throttle stop screw (2) to obtain the specified idle speed.

**Idle Speed:**  $1850 \pm 100$ rpm

Slightly increase the engine speed and make sure that the engine does not miss or run erratic.

If the adjustment of the air screw within the range of  $\pm \frac{1}{2}$  turn makes no difference to the engine performance, check other related items.

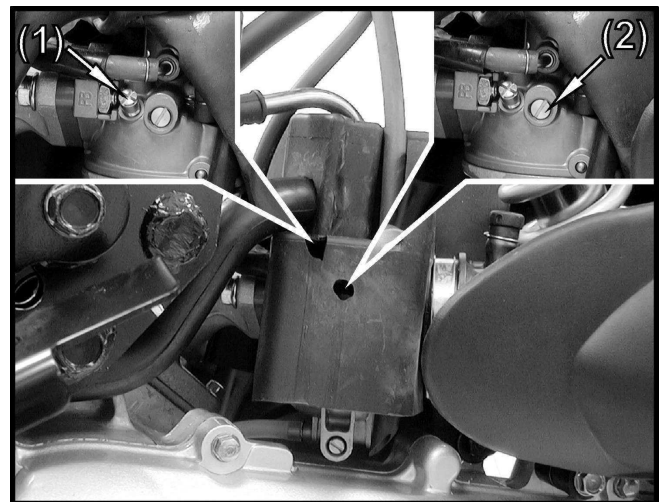

## 12. CARBURETOR

### REED VALVE (2-STROKE)

#### REMOVAL

Remove the rear body cover. (⇒13-6)  
Disconnect the fuel vacuum tube. (⇒5-2)  
Remove oil pump control cable plate.  
(⇒4-3)  
Remove carburetor. (⇒12-7)

Remove the three intake manifold bolts and gasket.  
Remove the reed valve and gasket.

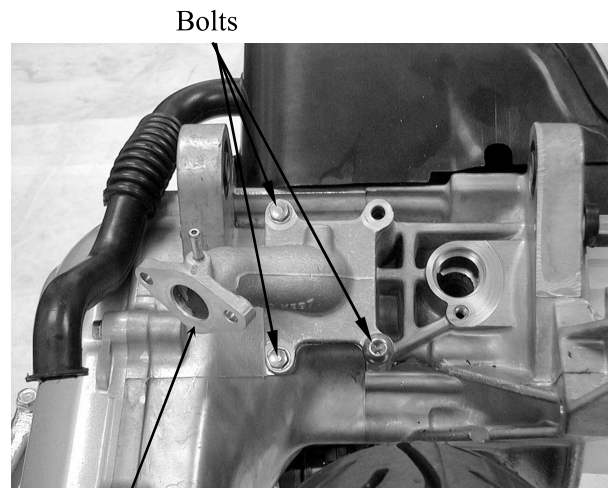

Intake Manifold

#### INSPECTION

Check the reed valve for damaged or weak reeds.  
Check the reed valve seat for cracks, damage or clearance between the seat and reed.  
Replace the valve if necessary.



Do not disassemble or bend the reed stopper. To do so can cause loss of engine power and engine damage. If any of the stopper, reed or valve seat is faulty, replace them as unit.

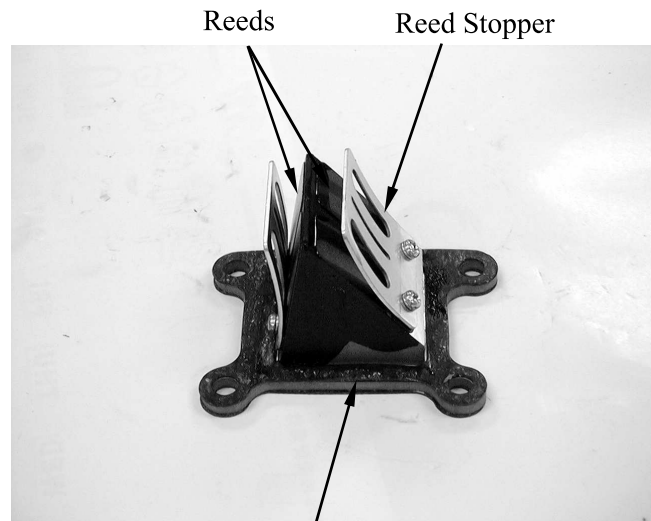

Reed Valve Seat

#### INSTALLATION

Install the reed valve in the reverse order of removal.



Install a new gasket with the gasket indentation aligned with the reed valve.  
After installation, check for intake air leaks.



## 12. CARBURETOR

### CARBURETOR (4-STROKE)

#### REMOVAL

Remove the met-in box. (⇒ 13-5)

Disconnect the auto bystarter connector.

Auto Bystarter Wire

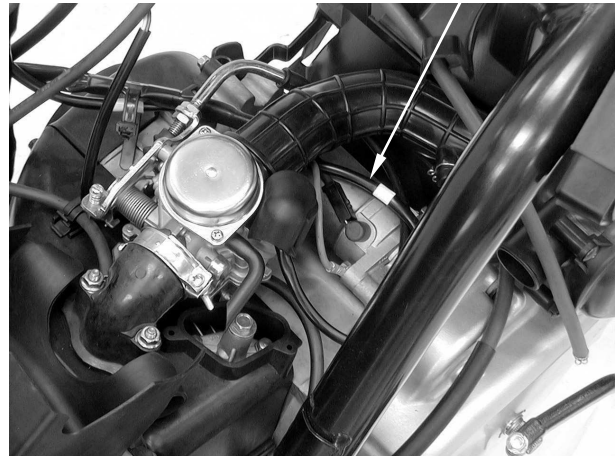

Disconnect the fuel tube from carburetor.



Fuel Tube

Loosen the throttle cable adjusting nut and lock nut, and disconnect the throttle cable from the carburetor.

Lock Nut      Throttle Cable

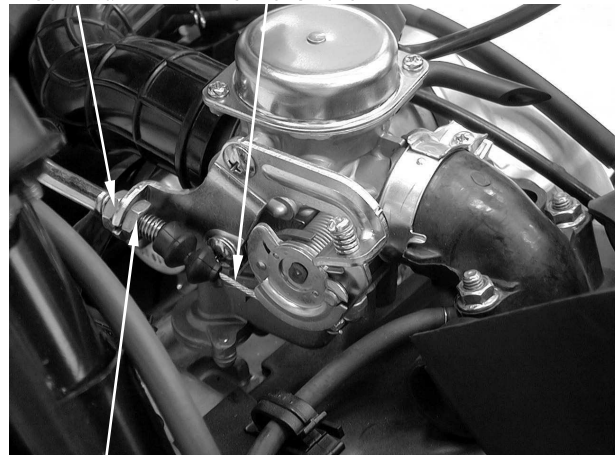

Adjusting Nut

## 12. CARBURETOR

Loosen the air cleaner connecting tube band screw and carburetor intake manifold band screw and then remove the carburetor.



Band Screws  
Vacuum Chamber Cover

### VACUUM CHAMBER DISASSEMBLY

Loosen the drain screw and drain the fuel from the float chamber.



Drain Screw

Remove the two vacuum chamber cover screws and the cover.

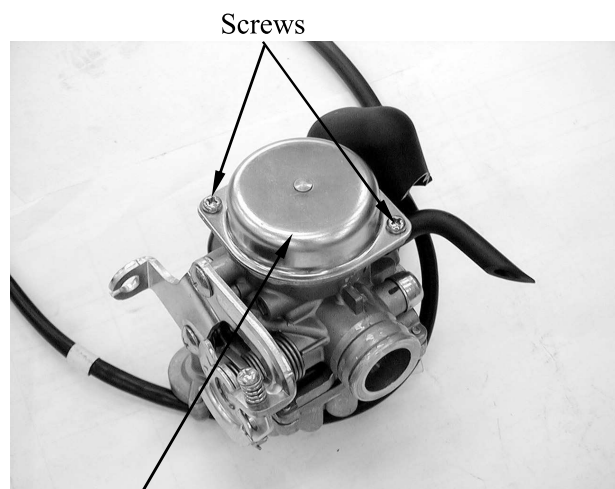

Screws  
Vacuum Chamber Cover

## 12. CARBURETOR

Remove the compression spring and vacuum piston.

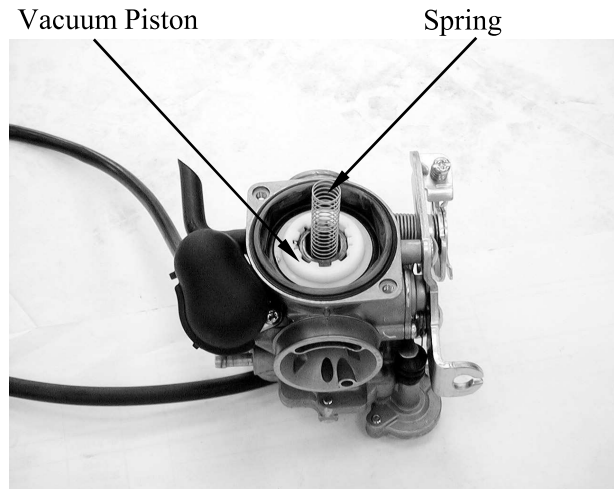

Remove the needle holder, spring and jet needle from the piston.

- Be careful not to damage the vacuum piston diaphragm.

### VACUUM PISTON INSPECTION

Inspect the vacuum piston and jet needle for wear or damage.  
Inspect the diaphragm for deterioration and tears.

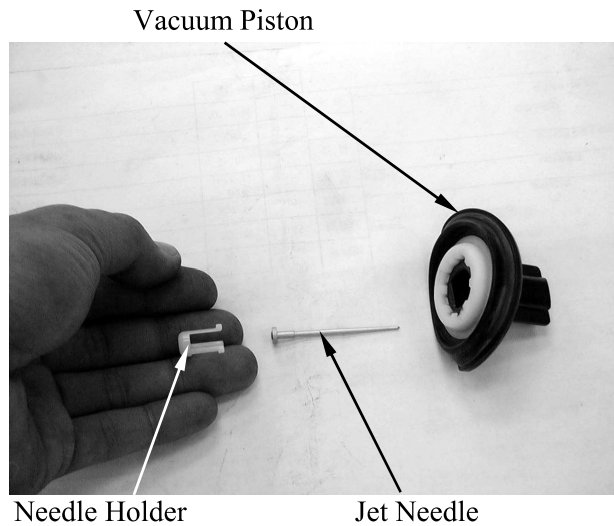

### FLOAT CHAMBER DISASSEMBLY

Remove the three float chamber screws and the float chamber.

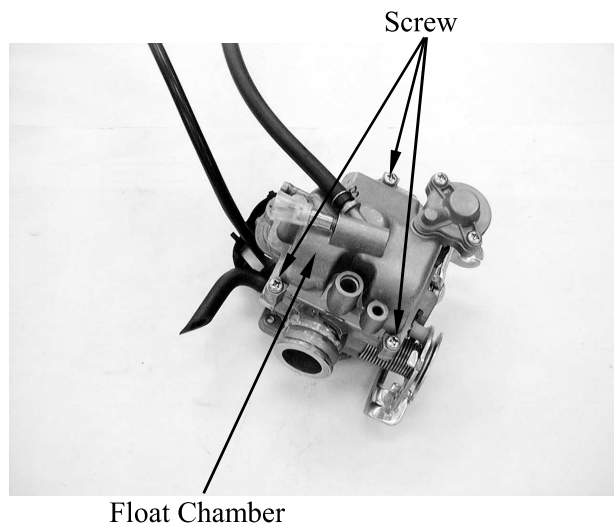

## 12. CARBURETOR

Remove screw, then remove float pin, float and float valve.

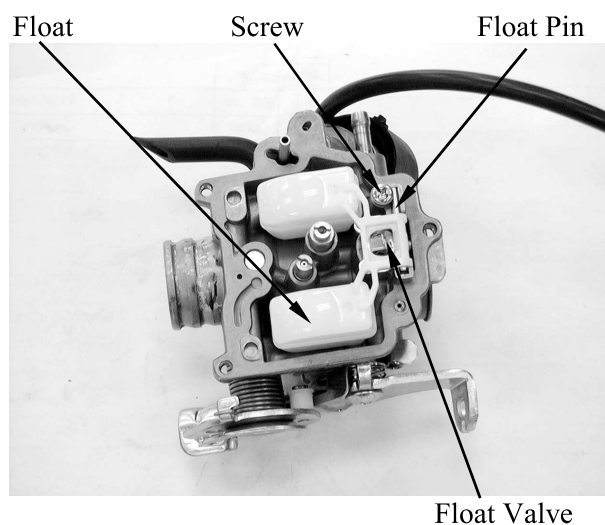

### FLOAT VALVE INSPECTION

Inspect the float valve seat contact area for wear.

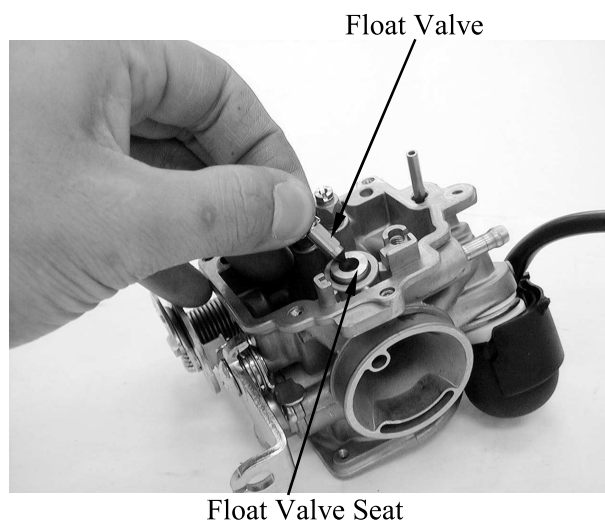

### JETS/SCREWS REMOVAL

- Before removing the pilot screw, turn the pilot screw clockwise until it seats lightly and record the rotating turns. Do not force the pilot screw against its seat to avoid seat damage.

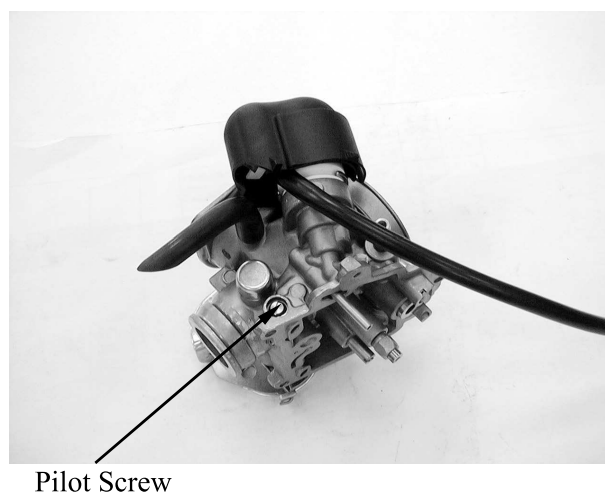

## 12. CARBURETOR

Remove the main jet, needle jet holder and needle jet.  
Remove the slow jet.

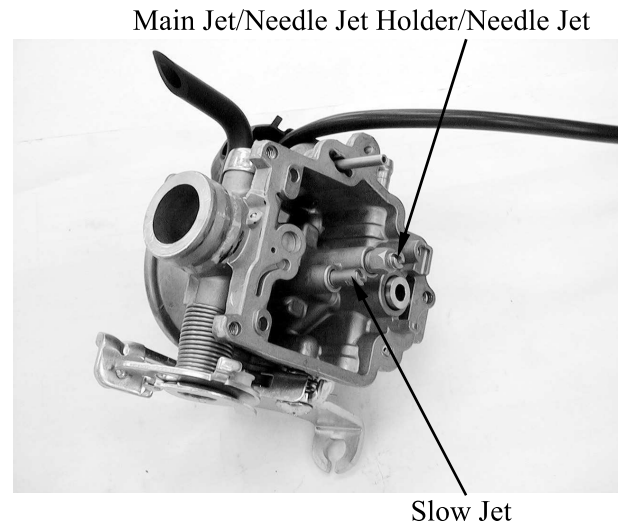

Clean the removed the main jet, needle jet holder, needle jet and slow jet with detergent oil.

- Be sure to use clean detergent oil.

Check the pilot screw, spring, washer and O-ring for bend, wear or damage.

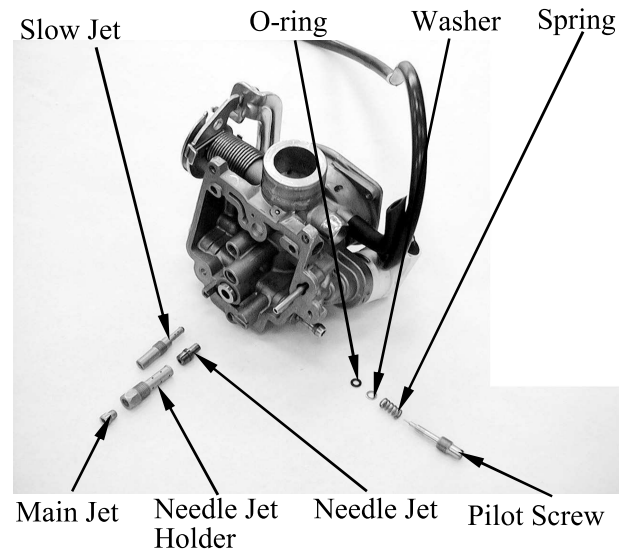

## 12. CARBURETOR

### AUTO BYSTARTER INSPECTION

Measure the resistance between the auto bystarter wire terminals.

**Resistance:**  $10\Omega$  (10 minutes minimum after stopping the engine)

If the reading is not within the limit, replace the auto bystarter with a new one.

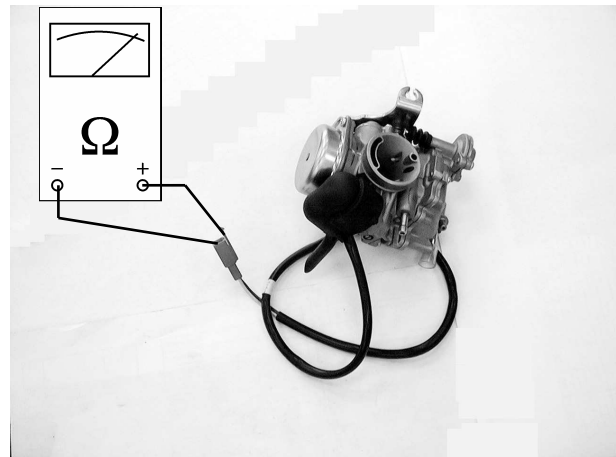

Connect a hose to the fuel enriching circuit of the carburetor. Connect the auto bystarter green/black wire to the positive (+) terminal of a battery and black/white wire to the negative (-) terminal. Wait 5 minutes and blow the hose with mouth. If the passage is blocked, the auto bystarter is normal. Disconnect the auto bystarter from the battery. Wait 30 minutes and blow the hose with mouth. If air can be blown into the hose, the auto bystarter is normal.

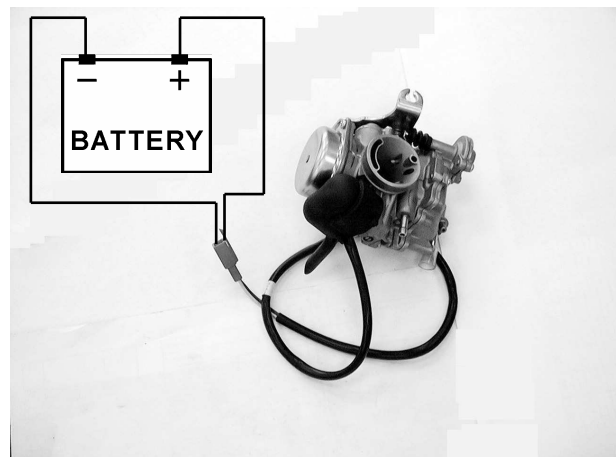

### AUTO BYSTARTER REMOVAL

Remove the bystarter cap.  
Remove the one set plate screw and set plate and then remove the auto bystarter from the carburetor body.

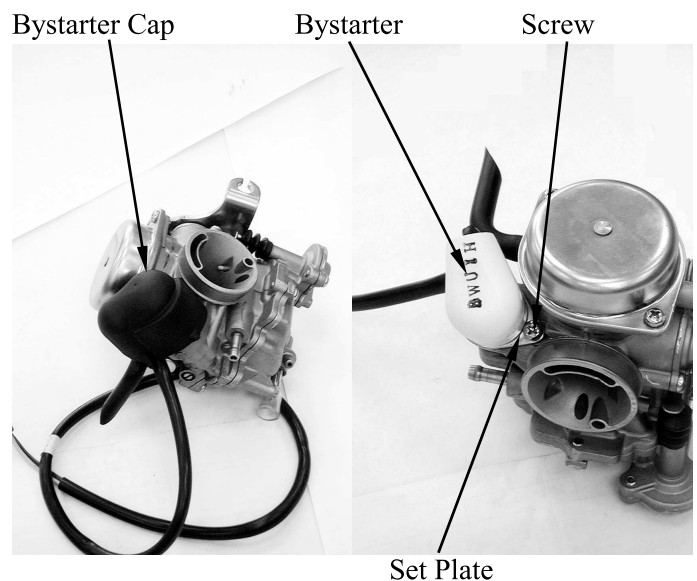

# 12. CARBURETOR

### AUTO BYSTARTER INSPECTION

Check the auto bystarter valve and needle for nicks, wear or damage.  
If any faulty part is found, replace the auto bystarter with a new one.

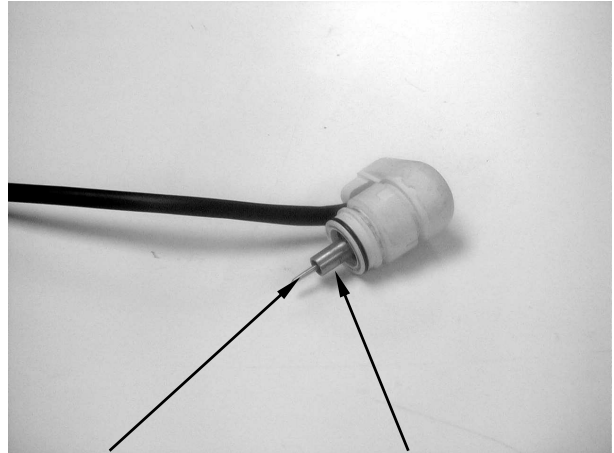

Bystarter Needle

Bystarter Valve

### AIR CUT-OFF VALVE (A.C.V.) REMOVAL

Remove the two screws and then remove throttle cable holder.  
Remove the two screws and the air cut-off valve cover.

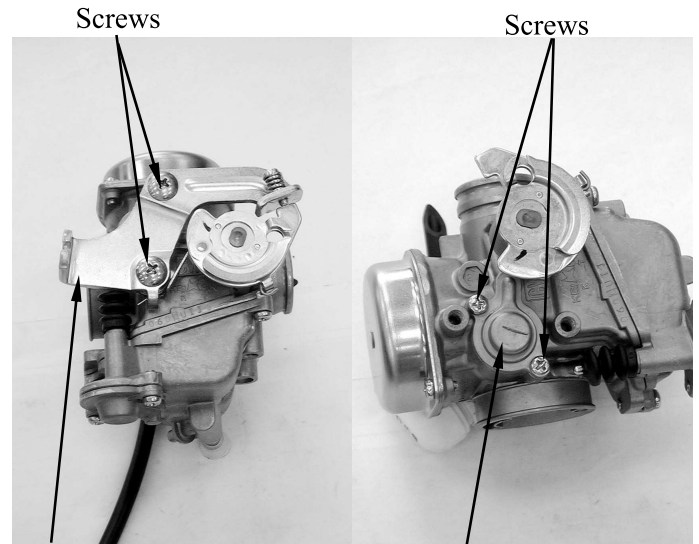

Throttle Cable

Cut-off Valve Cover

Remove the spring, diaphragm and O-rings.  
Inspect the diaphragm and spring for wear or damage.

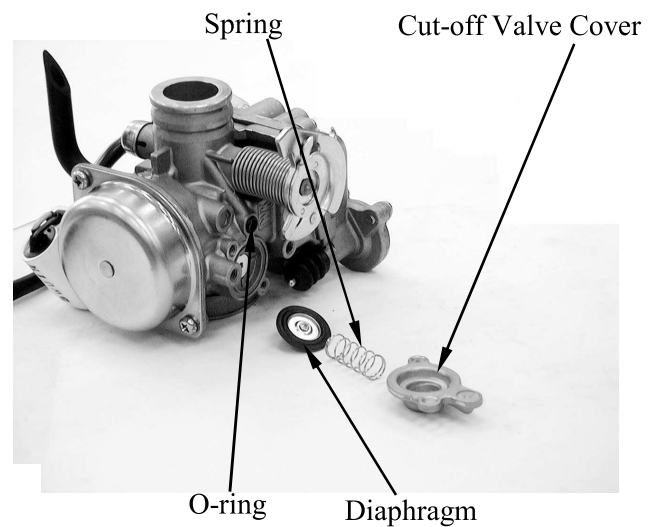

O-ring

Diaphragm

# 12. CARBURETOR

## CARBURETOR BODY CLEANING

Blow compressed air through all passages of the carburetor body.

- Make sure that no fuel jet is clogged.

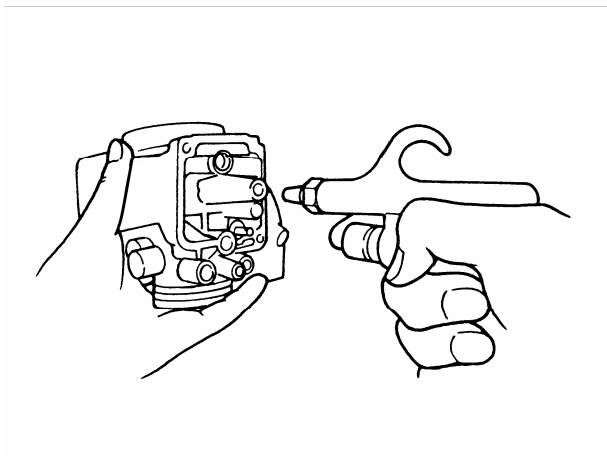

Install the O-ring onto the air-cut-off valve body securely.

- Install the O-ring with the flat face toward the valve body side.

Install the diaphragm, spring, and cover.

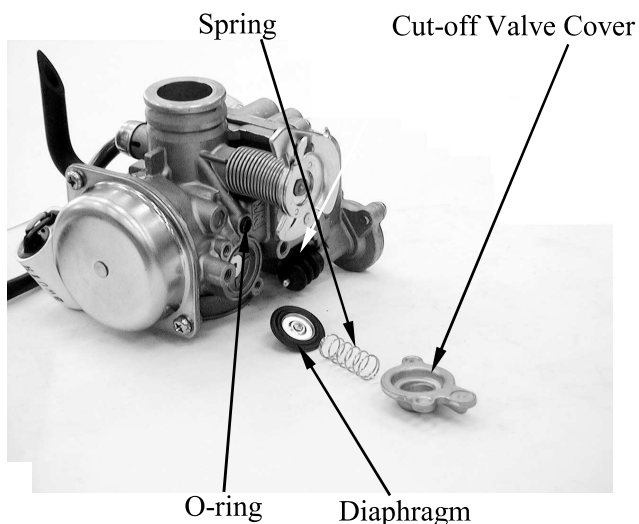

Install and tighten the two screws attaching the air cut-off valve cover.  
Install the throttle cable holder and tighten the two screws.

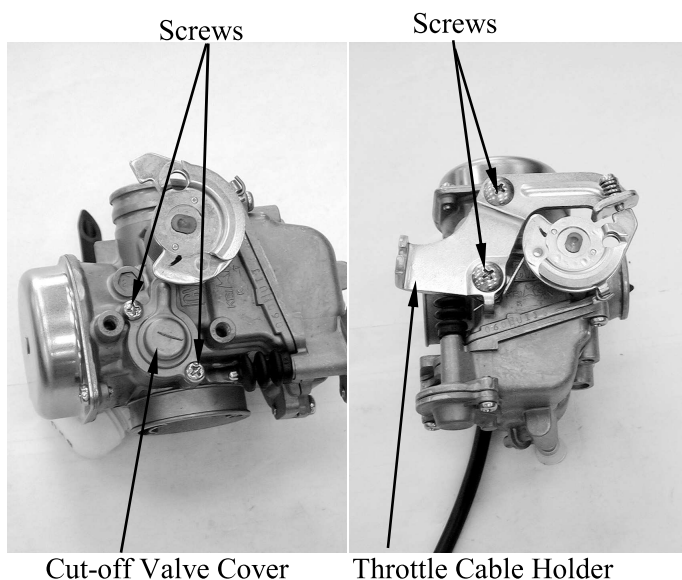



## 12. CARBURETOR

### ACCELERATING PUMP DISASSEMBLY

Remove the two accelerating pump cover screws and accelerating pump cover.  
Remove the spring and accelerating pump diaphragm.

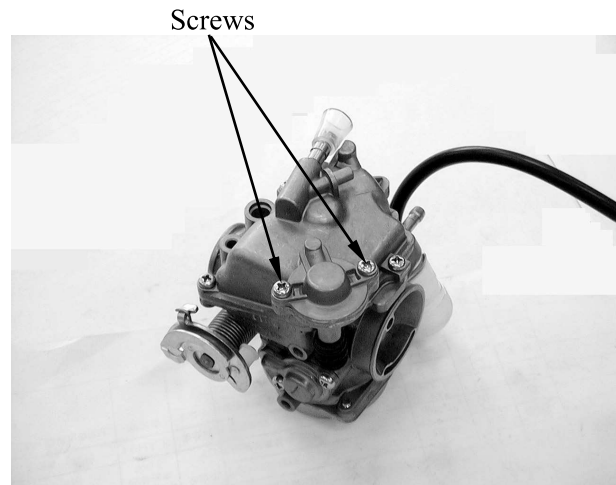

### INSPECTION

Inspect the accelerating pump diaphragm for cracks, damage or deterioration.  
Replace if necessary.  
Assemble the accelerating pump in the reverse order of disassembly.

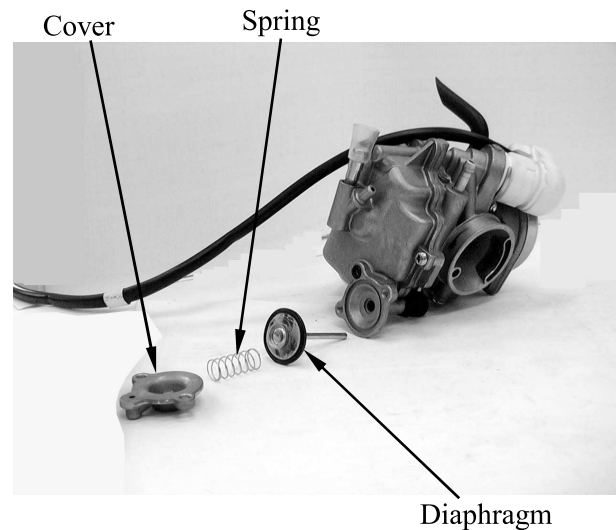

### AUTO BYSTARTER INSTALLATION

Install the auto bystarter and set plate.  
Install and tighten the two screws.

- Insert the auto bystarter into the carburetor body until it bottoms and position the set plate into the upper groove in the bystarter.
- Install the set plate with its round face facing down.

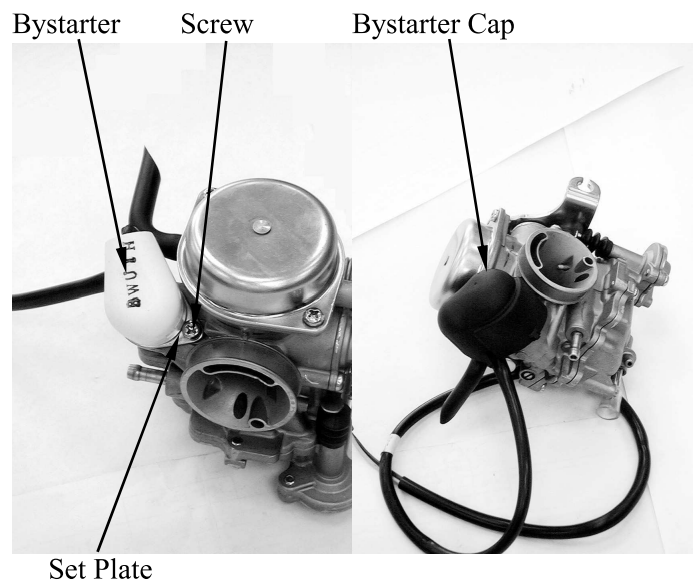

## 12. CARBURETOR

### FLOAT CHAMBER ASSEMBLY

Install the needle jet, needle jet holder and main jet.

Install the slow jet.

Main Jet/Needle Jet Holder/Needle Jet



Slow Jet

Install the pilot screw.

- Be sure to record the rotating turns when it is removed.



Pilot Screw

Install the float valve, float and float pin.  
Install and tighten the screw.

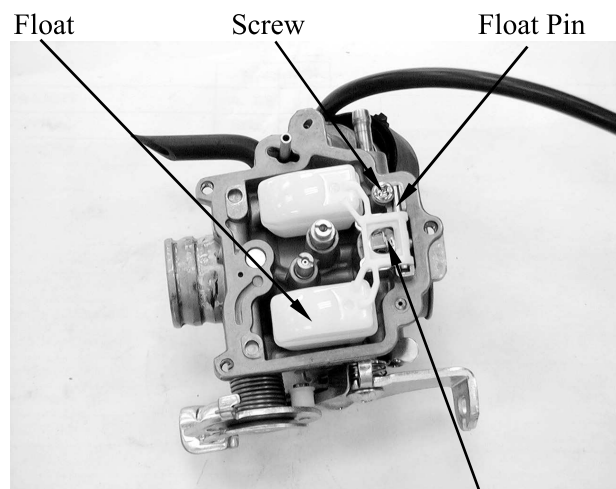

Float Valve

# 12. CARBURETOR

## FLOAT LEVEL INSPECTION

Measure the float level at the location of the main jet (just contacting the float valve).

**Float Level:** 20.5±1.0mm

Replace the float if the level is incorrect. Check the operation of the float and then reinstall the float chamber.

Datum plane

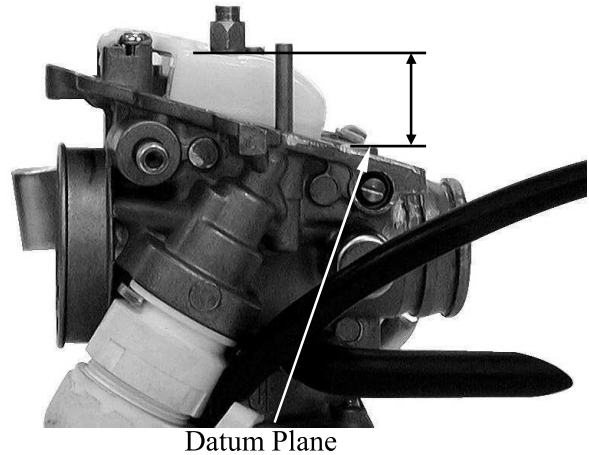

## VACUUM CHAMBER ASSEMBLY

First install the jet needle and spring into the vacuum chamber and then install the needle holder.

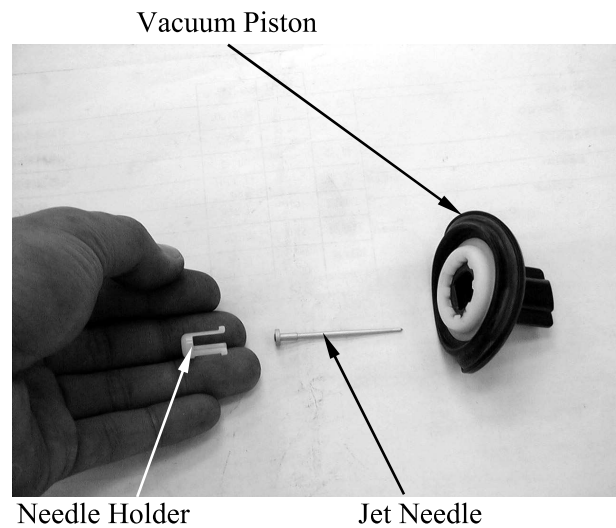

Install the vacuum piston into the carburetor body.

Install the spring.

Install the vacuum chamber cover and tighten it with the two screws.

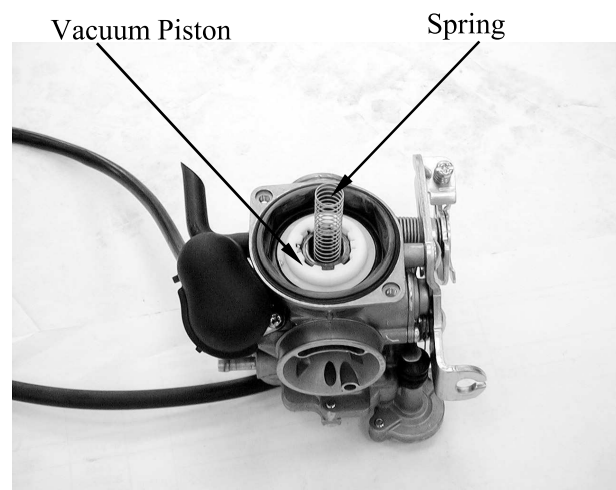

- Be careful not to let the diaphragm slip.
- If the diaphragm cannot be positioned correctly because of expansion, dry the diaphragm before installation.

## 12. CARBURETOR

### CARBURETOR INSTALLATION

Tighten the drain screw.  
Install the carburetor onto the intake manifold and tighten the band screw.  
Install the air cleaner connecting tube and tighten the band screw.

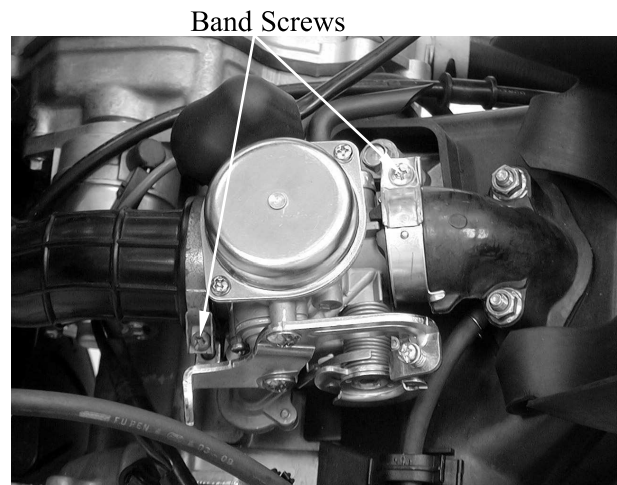

Connect the throttle cable to the carburetor.

- After connecting the throttle cable, adjust the throttle grip free play to 2□6mm.

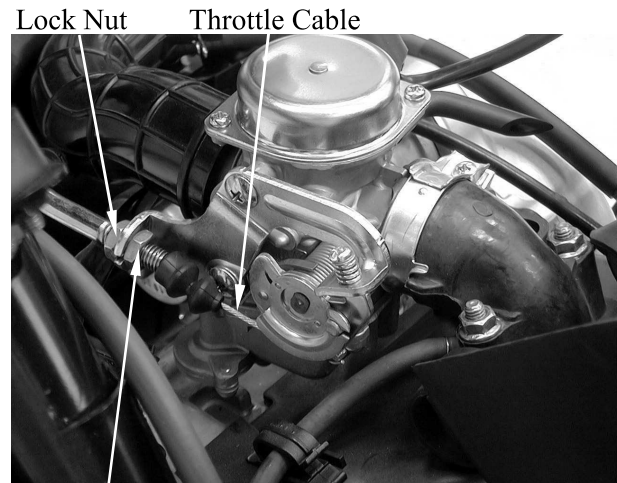

Adjusting Nut

Connect the fuel tube and vacuum tube to the carburetor.



Fuel Tube

## 12. CARBURETOR

---

Connect the auto bystarter connector.

Perform the following inspections and adjustments:

- Throttle grip free play (⇒3-16)
- Idle speed (⇒3-10)

**Idle Speed:** 1800±100rpm

Install the met-in box. (⇒13-5)

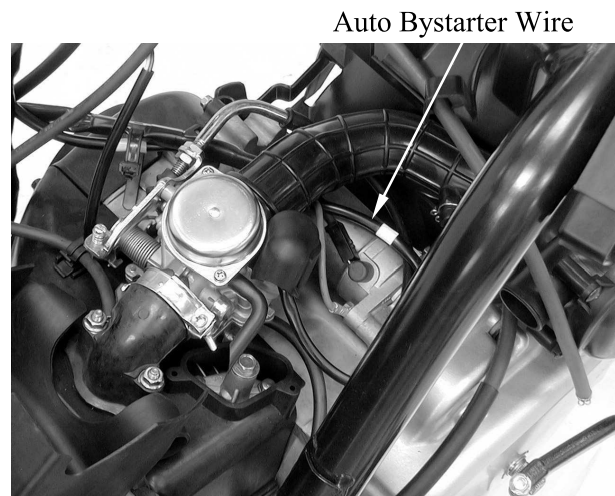

## 12. CARBURETOR

### FUEL TANK

#### REMOVAL

Remove the rear body cover. (⇒13-6)

Disconnect the fuel tube and vacuum tube at the auto fuel valve.



Vacuum Tube

Fuel Tube

Disconnect the fuel unit wire connector.  
Remove the three nuts and remove retainer plate.  
Remove the fuel tank mounting bolts and fuel tank.

Installation is in the reverse order of removal.

Inspect the fuel unit. (⇒17-2)

Replace the fuel unit if necessary. (⇒17-2)

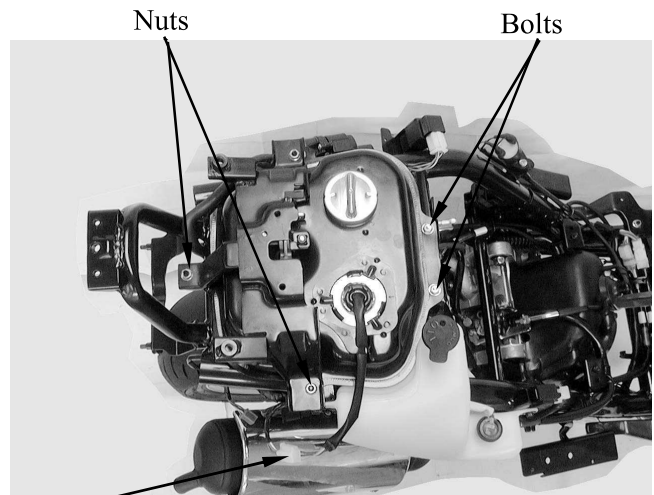

Fuel Unit Connector

---

**13. FRAME COVERS/EXHAUST MUFFLER**

---

**13**

---

**FRAME COVERS/EXHAUST MUFFLER**

---

SERVICE INFORMATION .....	13- 1
FRAME COVERS REMOVAL.....	13- 2
EXHAUST MUFFLER.....	13-10

## **13. FRAME COVERS/EXHAUST MUFFLER**

---

### **SERVICE INFORMATION**

- When removing frame covers, use care not to pull them by force because the cover joint claws may be damaged.

#### **Items Related for Removal**

- Handlebar front cover ——— Handlebar rear cover
- Front cover ——— Headlight wire
- Handlebar rear cover ——— Speedometer cable and instrument light wire connectors, etc.
- Frame body cover ——— Met-in box, rear carrier
- Floor board ——— Rear carrier, frame body cover, right and left side cover, battery
- Leg shield ——— Front body cover, front right and left side covers, rear body cover, floor board



# 13. FRAME COVERS/EXHAUST MUFFLER

## FRAME COVERS REMOVAL

### HANDLEBAR FRONT COVER REMOVAL/INSTALLATION

Remove the screw from the handlebar front cover.

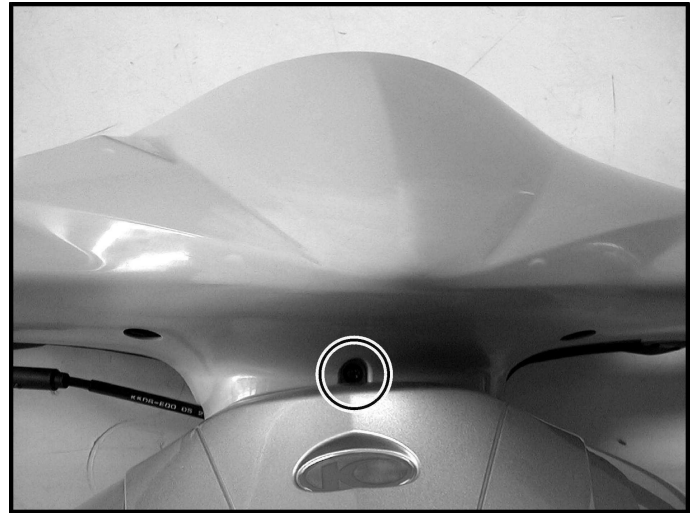

Remove the two screws from the handlebar rear cover.  
Separate the handlebar front cover from  
handlebar rear cover.

□ During removal, be careful not to pull  
the joint claws forcibly and remove the  
front cover downward.

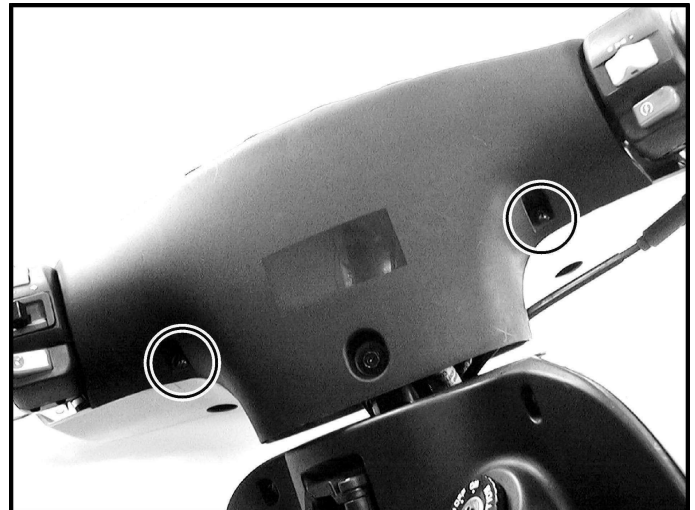

Disconnect the winker relay from the handlebar  
front cover and then remove handlebar front  
cover.

Installation is in the reverse order of removal.

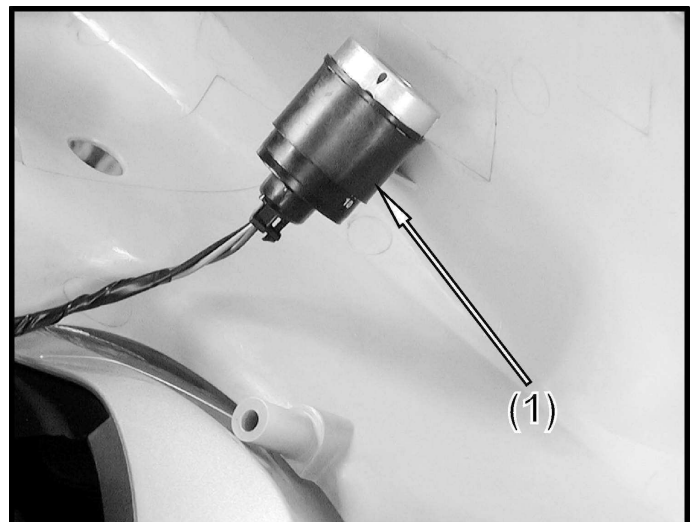

## 13. FRAME COVERS

### HANDLEBAR REAR COVER REMOVAL/INSTALLATION

Remove the handlebar front cover. (⇒13-2)

Remove the bolt from handlebar rear cover.



Remove the two mounting screws and disconnect speedometer cable (1).

Disconnect the wire connectors (2) and separate handlebar rear cover.

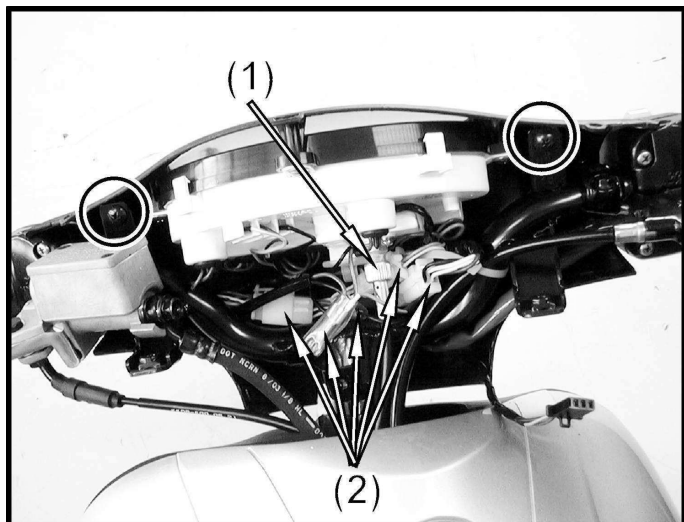

Remove the three screws from the instrument and then remove handlebar rear cover.

Installation is in the reverse order of removal.

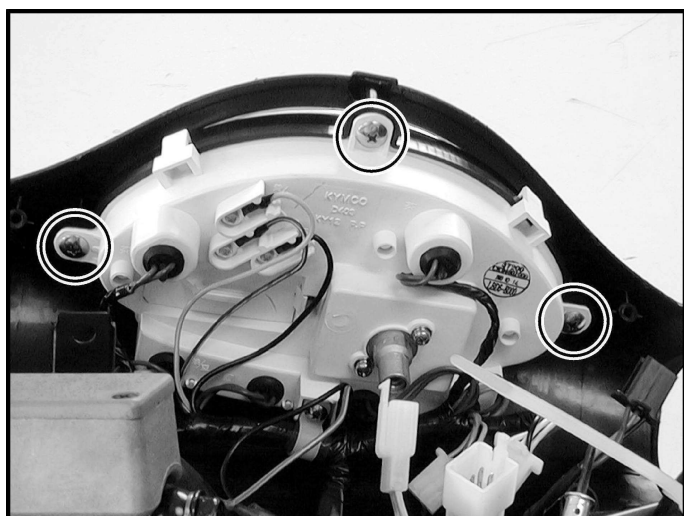

# 13. FRAME COVERS/EXHAUST MUFFLER

## FRONT COVER REMOVAL

Remove the screw and front cover (1).

□ During removal, be careful not to pull the joint claws forcibly and remove the front cover downward.

Installation is in the reverse order of removal.

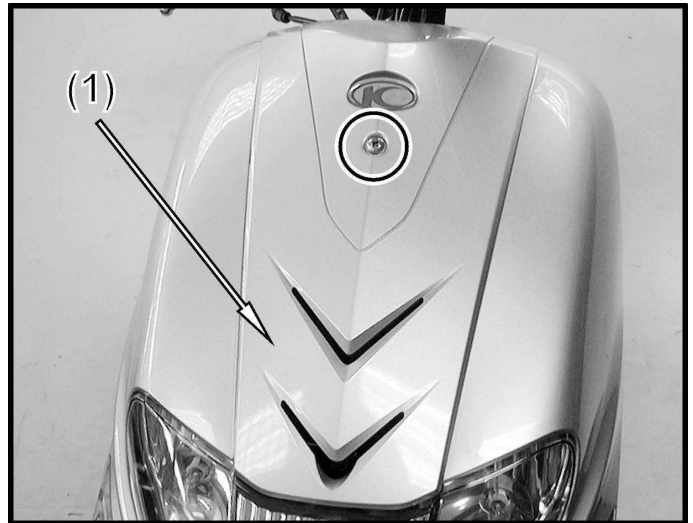

## RIGHT/LEFT SIDE COVERS REMOVAL/INSTALLATION

Remove the two screws and then remove right/left side cover (1).

□ During removal, be careful not to pull the joint claws forcibly and remove the front cover downward.

Installation is in the reverse order of removal.

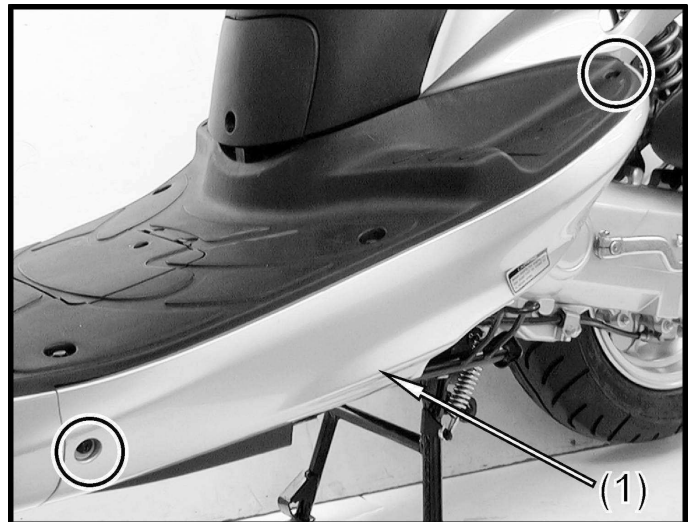

## FRONT FENDER REMOVAL/INSTALLATION

Remove the four screws and then remove front fender.

Installation is in the reverse order of removal.

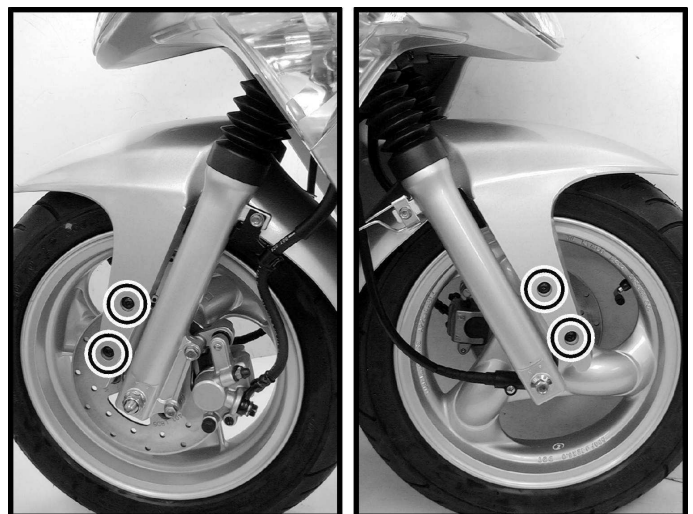

## 13. FRAME COVERS

### REAR CARRIER REMOVAL/INSTALLATION

Remove the three bolts and then remove rear carrier (1).

Installation is in the reverse order of removal.



### MET-IN BOX REMOVAL/INSTALLATION

Unlock the seat with ignition key and open the seat.

Remove the screw, two bolts and two nuts from met-in box.

Remove the oil tank cap (1) and then remove met-in box.

Installation is in the reverse order of removal.

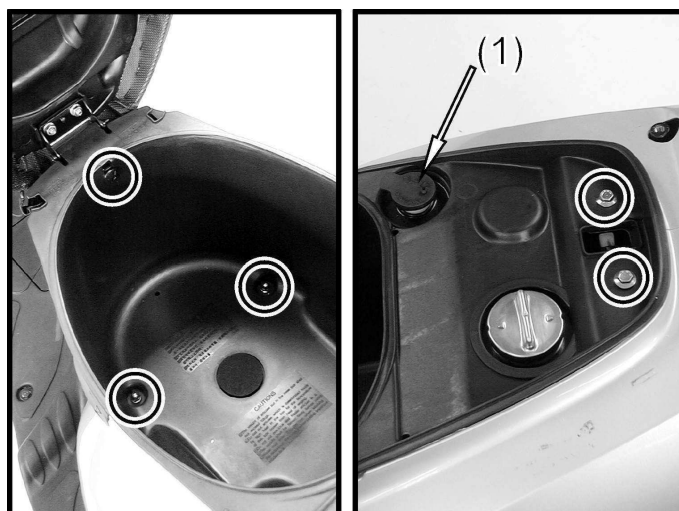

### SPARK PLUG COVER REMOVAL/INSTALLATION

Remove the screw and then remove spark plug cover (1).

Installation is in the reverse order of removal.

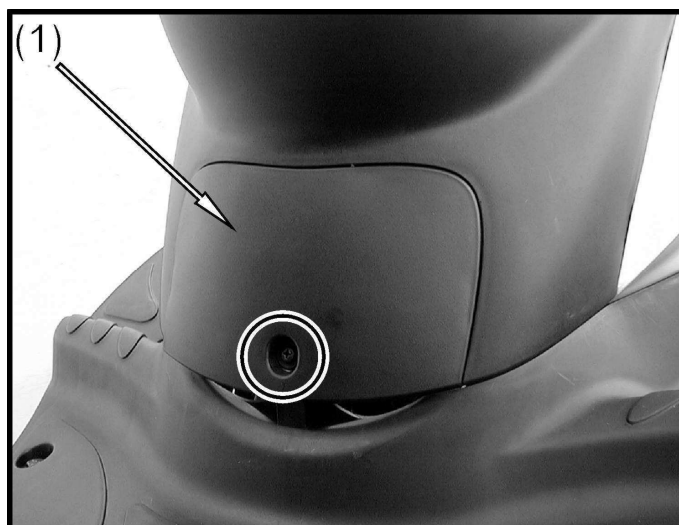

# 13. FRAME COVERS/EXHAUST MUFFLER

VITALITY 50

## CENTER COVER REMOVAL/INSTALLATION

Remove the met-in box. (⇒13-5)

Remove the two screws and then remove center cover.

□ When removing the right and left side rails, pull them backward not to damage the joint claws.

Installation is in the reverse order of removal.

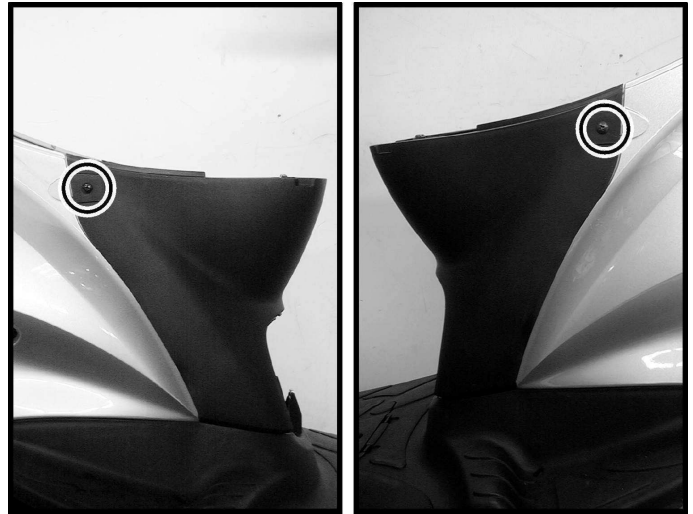

## REAR BODY COVER REMOVAL/INSTALLATION

Remove the following:

Met-in box (⇒13-5)

Center cover (⇒13-6)

Rear carrier (⇒13-5)

Remove the two screws from the rear fender.



Remove the two screws from the rear body cover.

Disconnect the seat lock cable and then remove rear body cover.

□ When removing the right and left side rails, pull them backward not to damage the joint claws.

Installation is in the reverse order of removal.

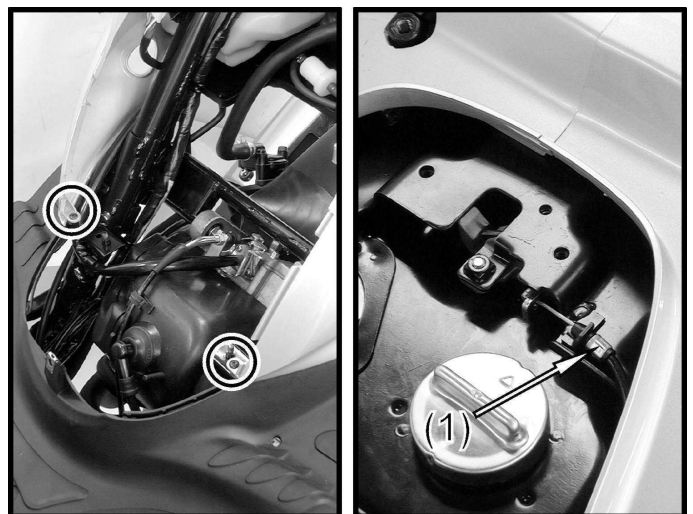

## 13. FRAME COVERS

### REAR UPPER FENDER & TAILLIGHT REMOVAL/INSTALLATION

Remove the following:

- Met-in box (⇒13-5)
- Rear carrier (⇒13-5)
- Center cover (⇒13-6)
- Rear body cover (⇒13-6)

Remove the two bolts from the taillight and two nuts from the rear upper fender.

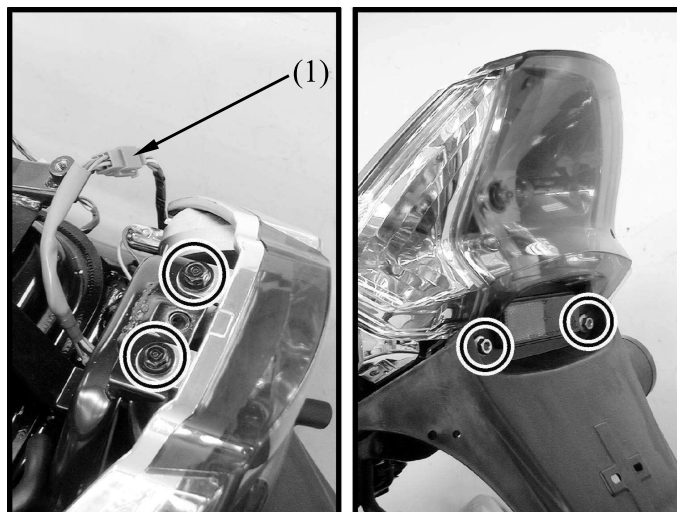

Slide the two clips (1) for disconnect fuel hose and vacuum hose (2).

Remove the rear upper fender/taillight.

Installation is in the reverse order of removal.

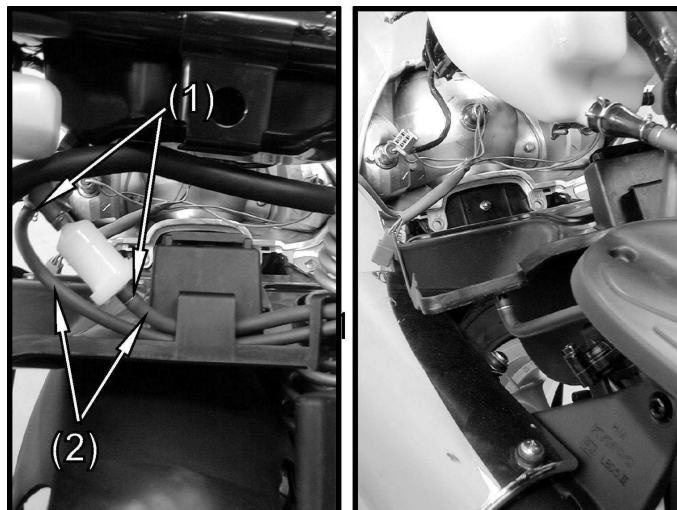

### BOTTOM COVER REMOVAL/INSTALLATION

Remove the right and left side covers. (⇒13-4)

Remove the nut from the bottom cover left side.

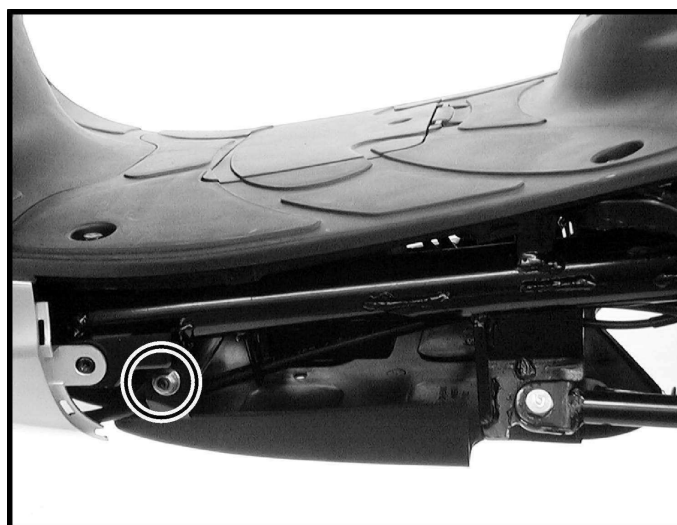

# 13. FRAME COVERS/EXHAUST MUFFLER

VITALITY 50

Remove the two nuts from the bottom cover right side and then remove bottom cover.

Installation is in the reverse order of removal.

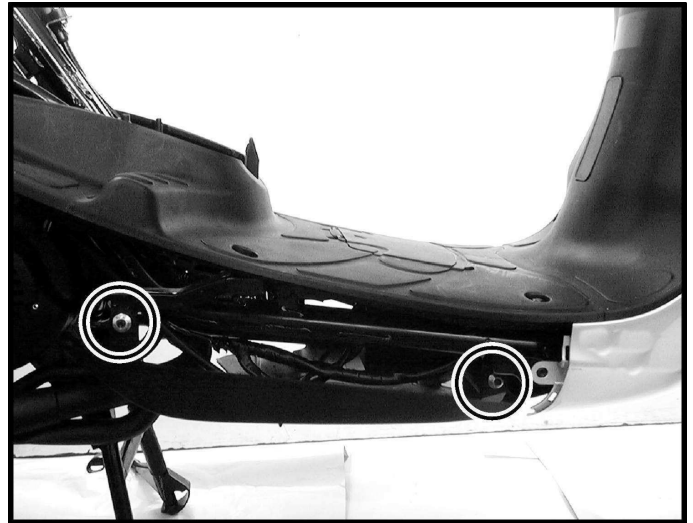

## FLOOR BOARD REMOVAL/INSTALLATION

Remove the following:

- Rear carrier (⇒13-5)
- Right and left side cover (⇒13-4)
- Met-in box (⇒13-5)
- Center cover (⇒13-6)
- Rear body cover (⇒13-6)
- Battery cover (1) (⇒16-5)
- Battery (2) (⇒16-5)
- Fuse (3) (⇒16-5)

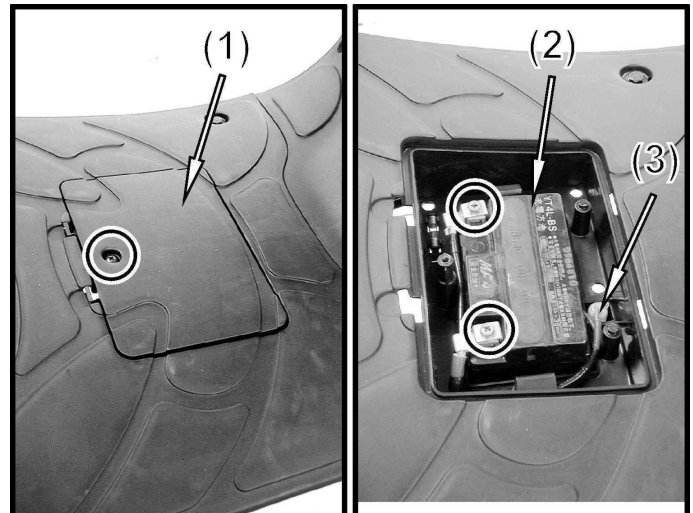

Remove the four bolts and then remove floor board.

Installation is in the reverse order of removal.

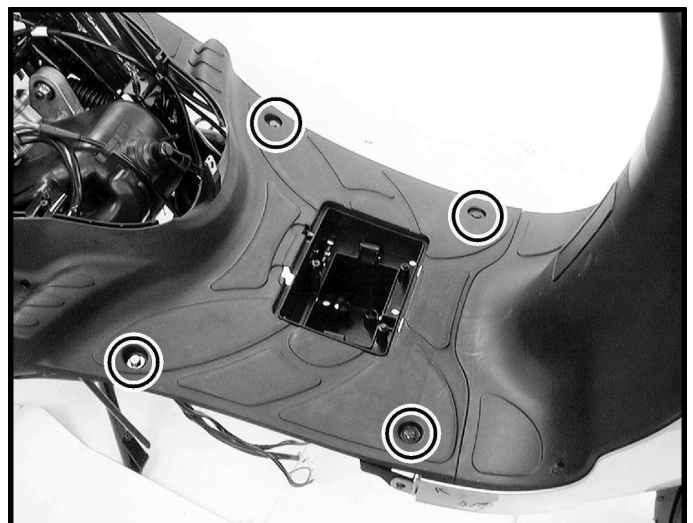



# 13. FRAME COVERS

## LEG SHIELD REMOVAL/INSTALLATION

Remove the following:

- Rear carrier (⇒13-5)
- Right and left side cover (⇒13-4)
- Met-in box (⇒13-5)
- Center cover (⇒13-6)
- Rear body cover (⇒13-6)
- Battery cover (⇒16-5)
- Battery (⇒16-5)
- Fuse (⇒16-5)
- Floor board (⇒13-8)

Remove the ten screws and one bolt from the leg shield.

Turn the ignition switch cover (1) counterclockwise and remove ignition switch cover, then remove leg shield.

□ When removing the right and left side rails, pull them backward not to damage the joint claws.

Installation is in the reverse order of removal.

## FRONT BODY COVER REMOVAL/INSTALLATION

Remove the following:

- Front cover (⇒13-4)
- Right and left side cover (⇒13-4)

Remove the two nuts from the front body cover.

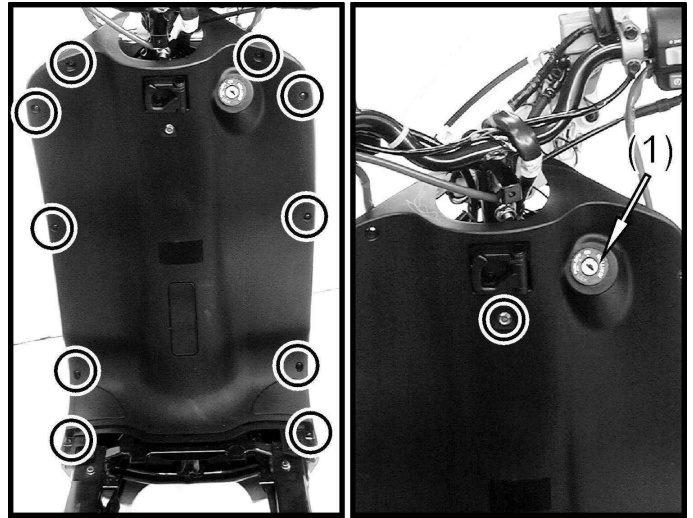



# 13. FRAME COVERS/EXHAUST MUFFLER

Remove the ten screws from the leg shield.  
Disconnect the headlight connector and then  
remove front body cover.

□ When removing the right and left side  
rails, pull them backward not to damage  
the joint claws.

Installation is in the reverse order of removal.

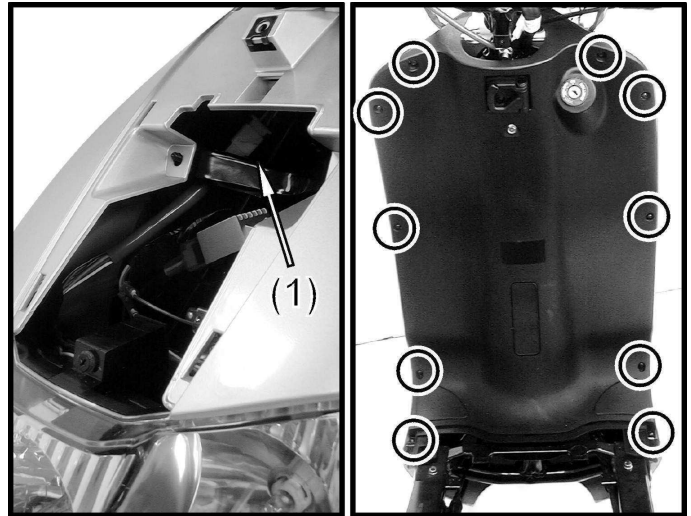

## EXHAUST MUFFLER REMOVAL/INSTALLATION

Disconnect the secondary air hose (2-stroke).  
(⇒5-3)

Remove the two exhaust pipe joint lock nuts  
(1).

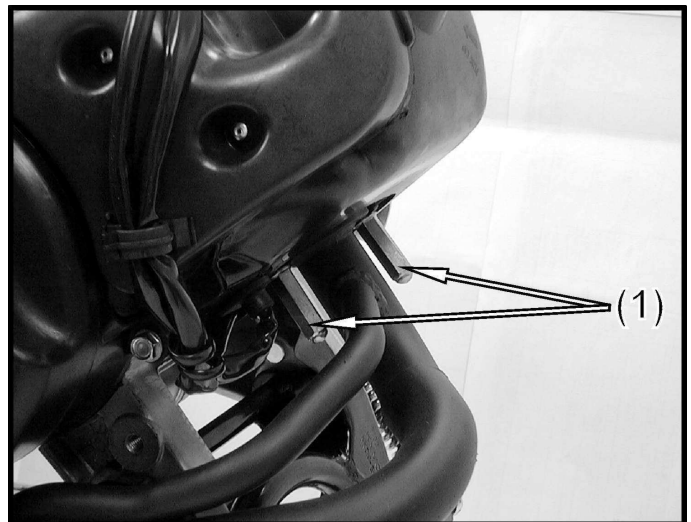

Remove the bolt from the rear lower fender and  
two Exhaust muffler lock bolts from the  
exhaust muffler.

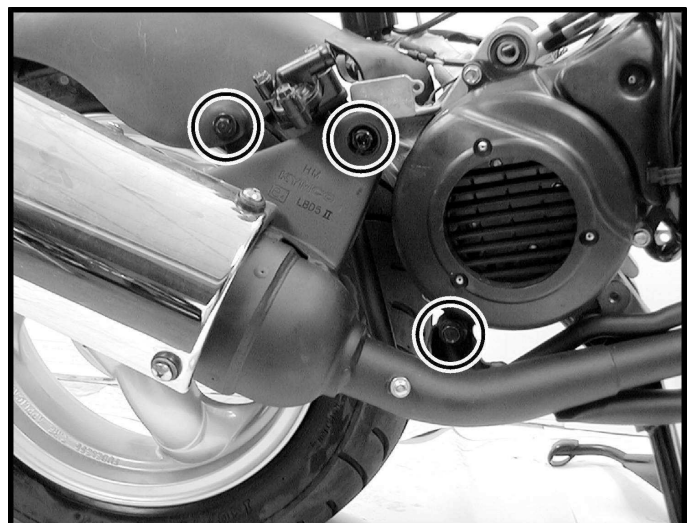

## 13. FRAME COVERS

---

Inspect the gasket (1).

If the exhaust gas leaks, the gasket should be replaced.

Installation is in the reverse order of removal.

- When installing the exhaust muffler, first tighten the two nuts on the front and then tighten the two bolts.

**Torque:**

Exhaust muffler lock bolt: 3.0□3.6kgf-m

exhaust pipe joint lock nuts: 1.0□1.4kgf-m

- Be sure to install a new exhaust gasket.

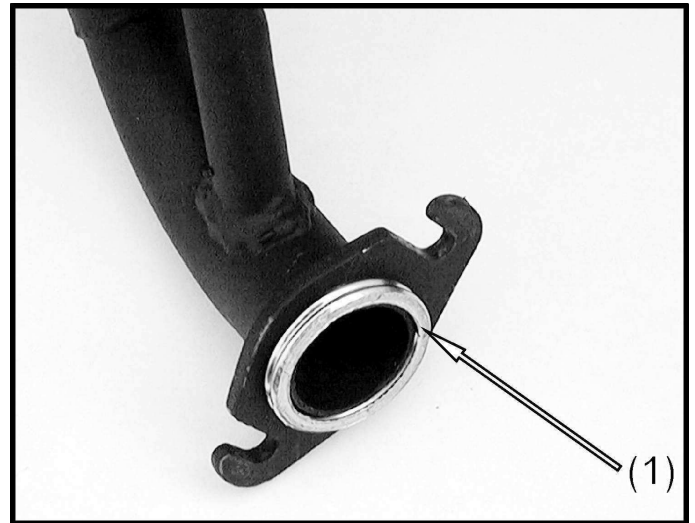

---

**STEERING HANDLEBAR/FRONT WHEEL/FRONT  
BRAKE/FRONT SHOCK ABSORBER/FRONT FORK**

---

SERVICE INFORMATION .....	14- 2
TROUBLESHOOTING .....	14- 2
STEERING HANDLEBAR .....	14- 3
FRONT WHEEL .....	14- 5
HYDRAULIC BRAKE .....	14- 8
FRONT SHOCK ABSORBER .....	14-16
FRONT FORK .....	14-19

# 14. STEERING HANDLEBAR/FRONT WHEEL/FRONT BRAKE/FRONT SHOCK ABSORBER/FRONT FORK

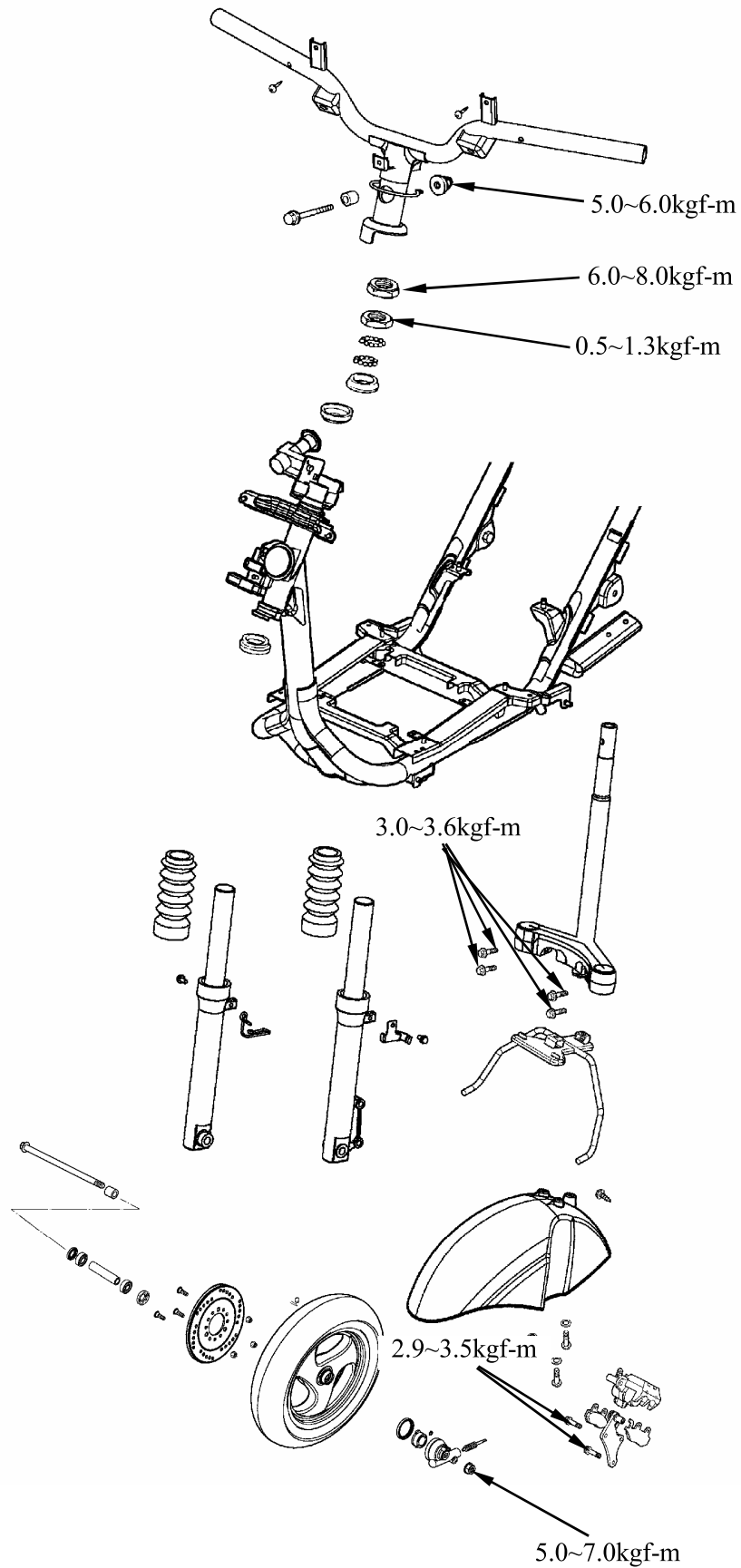

## SERVICE INFORMATION

### SPECIFICATIONS

Item	Standard (mm)	Service Limit (mm)
Axle shaft runout	—	0.2
Front wheel rim runout	Radial	2.0
	Axial	2.0
Front shock absorber spring free length	214.7	
Brake disk thickness	4.0	3.0
Brake disk runout	—	0.30
Brake master cylinder I.D.	12.700□12.743	12.75
Brake master cylinder piston O.D.	12.657□12.684	12.64
Brake caliper piston O.D.	25.400□25.405	25.45
Brake caliper piston I.D.	25.318□25.368	25.30

### TORQUE VALUES

Handlebar lock nut	5.0□6.0kgf-m	Front axle nut	5.0□7.0kgf-m
Steering stem lock nut	0.5~1.3kgf-m	Brake caliper bolt	2.9~3.5kgf-m
Steering top cone race	6.0~8.0kgf-m		

### SPECIAL TOOLS

Lock nut wrench	F007
Lock nut socket wrench	F001
Race cone install	F005

### TROUBLESHOOTING

#### Hard steering (heavy)

- Excessively tightened steering stem top cone race
- Broken steering balls
- Insufficient tire pressure

#### Steers to one side or does not track straight

- Broken clutch weight spring
- Bent front fork
- Bent front axle or uneven tire

#### Poor brake performance

- Incorrectly adjusted brake
- Worn brake linings
- Contaminated brake lining surface
- Worn brake cam
- Worn brake drum
- Poorly connected brake arm

#### Poor brake performance (disk brake)

- Air in brake system
- Deteriorated brake fluid

- Contaminated brake disk or disk pad
- Worn brake bushing
- Worn brake master cylinder piston oil seal
- Clogged brake fluid line
- Deformed brake disk
- Unevenly worn brake caliper

#### Front wheel wobbling

- Bent rim
- Loose front axle
- Bent spoke plate
- Faulty tire
- Improperly tightened axle nut

#### Soft front shock absorber

- Weak shock springs
- Insufficient damper oil

#### Front shock absorber noise

- Slider bending
- Loose fork fasteners
- Lack of lubrication

# 14. STEERING HANDLEBAR/FRONT WHEEL/FRONT BRAKE/FRONT SHOCK ABSORBER/FRONT FORK

## STEERING HANDLEBAR

### REMOVAL

Remove the handlebar front and rear covers.  
(⇒ 13-3)  
Remove front body cover. (⇒ 13-9)

Remove two bolts attaching the left brake lever holder.  
Remove two bolts attaching the brake master cylinder (disk brake) to the right brake lever.

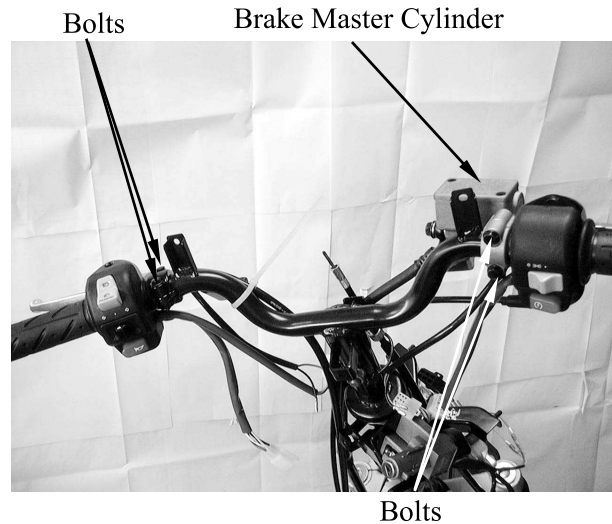

Remove the two right handlebar switch housing bolts and separate the housing.  
Disconnect the throttle cable and then remove the throttle grip from the handlebar.

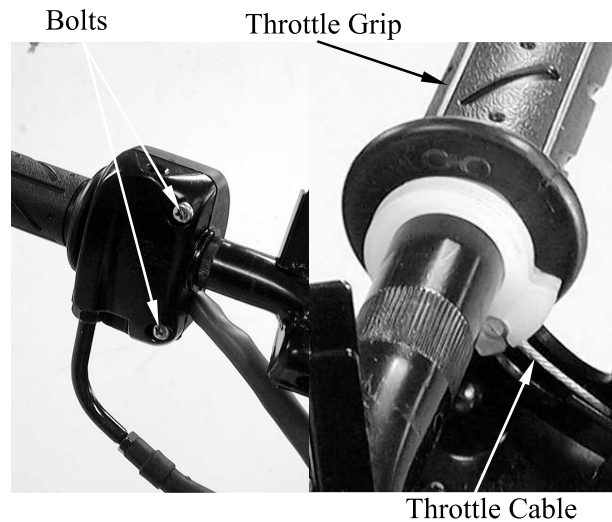

Remove the handlebar lock nut to remove the handlebar.

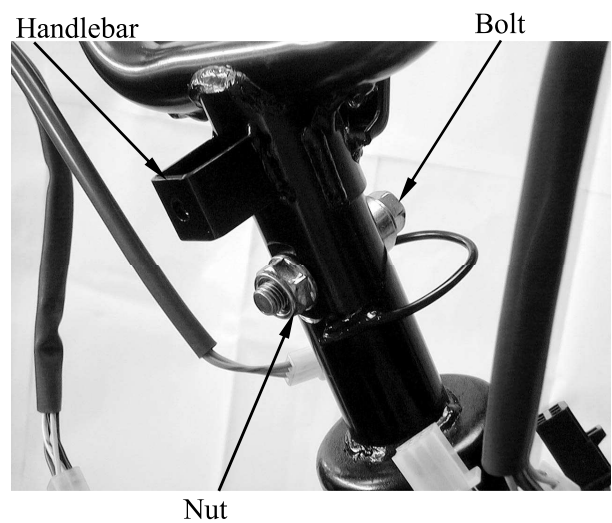

# 14. STEERING HANDLEBAR/FRONT WHEEL/FRONT BRAKE/FRONT SHOCK ABSORBER/FRONT FORK

## INSTALLATION

Install the handlebar and tighten the handlebar lock nut.

**Torque:** 5.0□6.0kg-m

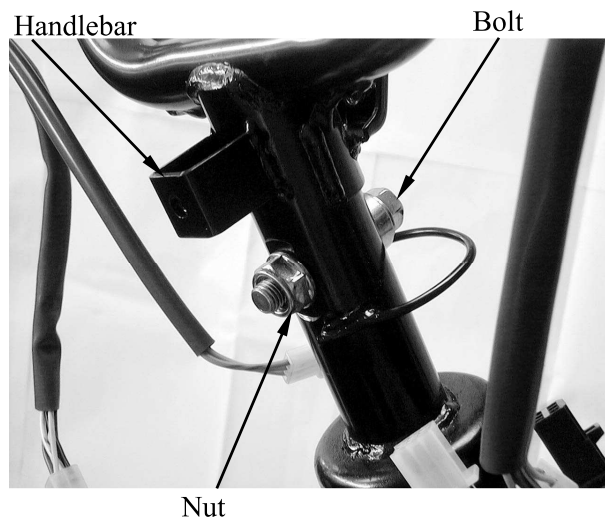

Lubricate the throttle cable front end with grease.  
Install the throttle grip and connect the throttle cable.



Install the rear brake lever holder.  
Install the front brake master cylinder (disk brake).

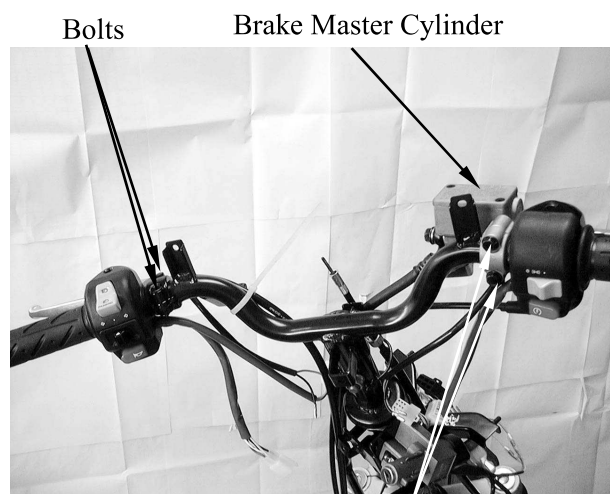

# 14. STEERING HANDLEBAR/FRONT WHEEL/FRONT BRAKE/FRONT SHOCK ABSORBER/FRONT FORK

## FRONT WHEEL

### REMOVAL

#### (DISK BRAKE)

Jack the scooter front wheel off the ground.  
Remove the speedometer cable set screw, then disconnect the speedometer cable.  
Remove the front axle nut and pull out the axle.  
Remove the front wheel.  
Remove the brake panel side collar.



### INSPECTION

Set the axle in V blocks and measure the runout.  
The actual runout is  $\frac{1}{2}$  of the total indicator reading.  
**Service Limit:** 0.2mm replace if over.

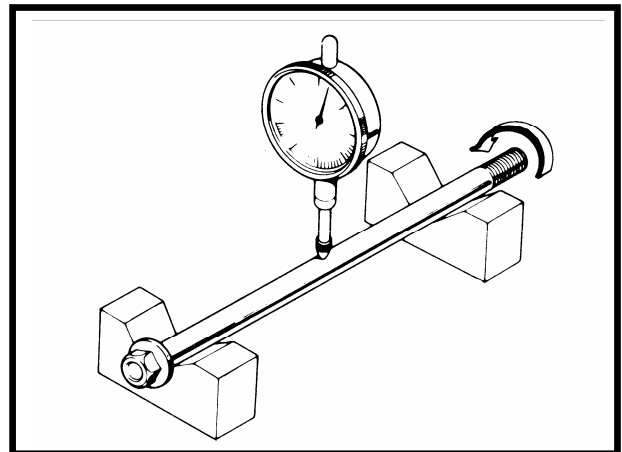

Check the wheel rim runout.

#### **Service Limits:**

**Radial:**2.0mm replace if over

**Axial:**2.0mm replace if over

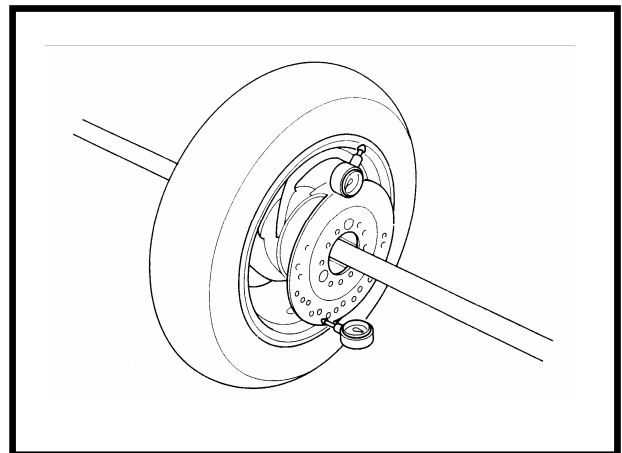



# 14. STEERING HANDLEBAR/FRONT WHEEL/FRONT BRAKE/FRONT SHOCK ABSORBER/FRONT FORK

Turn the wheel bearings and replace them if they have excessive play or noise.

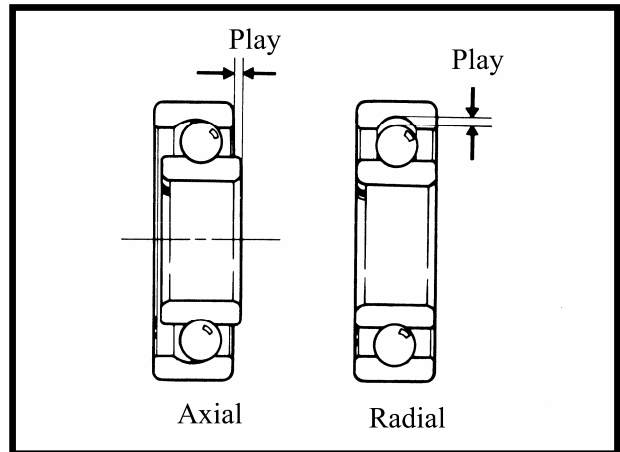

**DISASSEMBLY**  
Remove the dust seal.



Remove the wheel bearings and distance collar.



# 14. STEERING HANDLEBAR/FRONT WHEEL/FRONT BRAKE/FRONT SHOCK ABSORBER/FRONT FORK

## ASSEMBLY

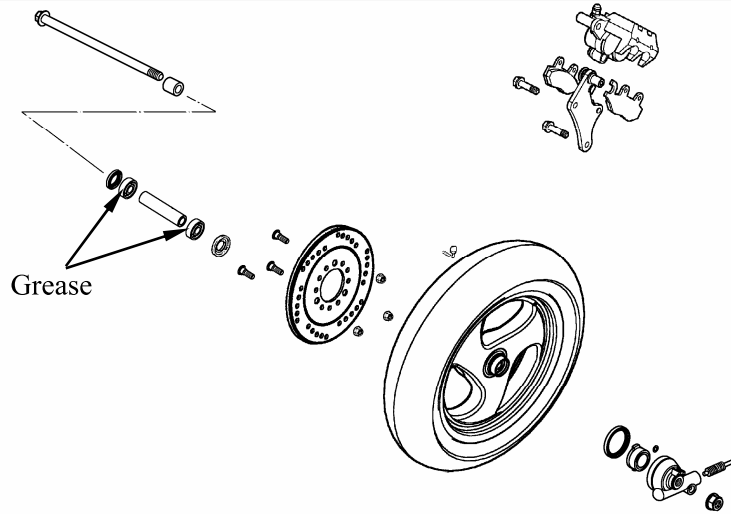

Pack all bearing cavities with grease.  
Drive in the left bearing .  
Install the distance collar.  
Drive in the right bearing.

□ Drive the bearing squarely with the sealed end facing out.



Pilot

Apply grease to the dust seal lip and install the dust seal.  
Install the side collar.

Side Collar

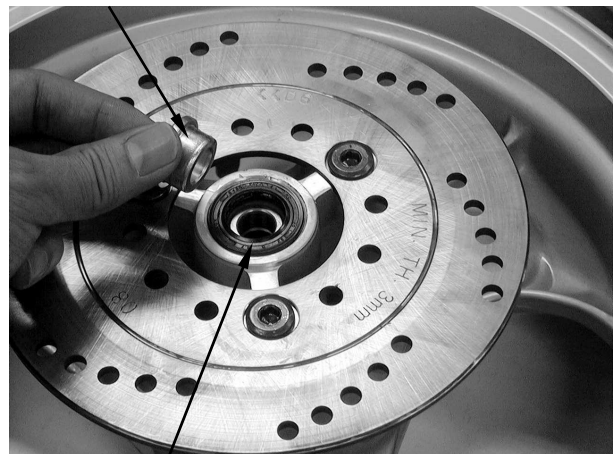

Dust Seal

# 14. STEERING HANDLEBAR/FRONT WHEEL/FRONT BRAKE/FRONT SHOCK ABSORBER/FRONT FORK

## FRONT WHEEL INSTALLATION

### (Disk Brake)

Install the front wheel, aligning the speedometer gear tab with the front fork groove.

Connect the speedometer cable.

**Torque:** 5.0□7.0kg-m

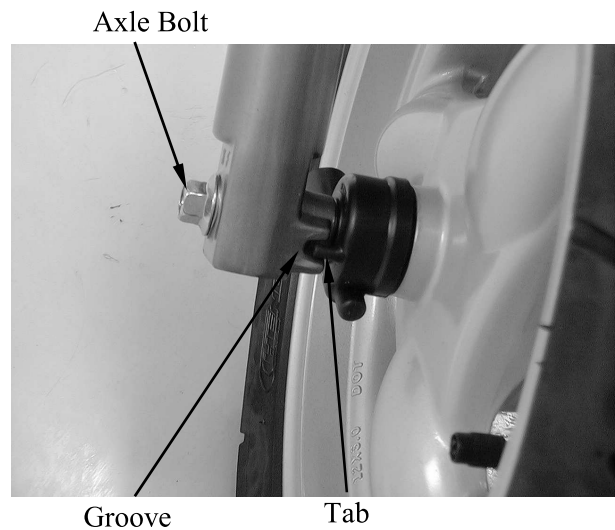

## HYDRAULIC BRAKE

### Brake Fluid Replacement/Air Bleeding

Check the brake fluid level on level ground.

- When operating the brake lever, the brake reservoir cap must be tightened securely to avoid spill of brake fluid.
- When servicing the brake system, use shop towels to cover plastic parts and coated surfaces to avoid damage caused by spill of brake fluid.

### Brake Fluid Bleeding

In order to avoid spill of brake fluid, connect a transparent hose to the bleed valve.

Brake fluid spilled on brake pads or brake disk will reduce the braking effect. Clean the brake pads and brake disk with a high quality brake degreaser.

Fully apply the brake lever and then loosen the brake caliper bleed valve to drain the brake fluid until there is no air bubbles in the brake fluid. Then, tighten the bleed valve. Repeat these steps until the brake system is free of air.

### Brake Fluid Refilling

Add DOT-4 brake fluid to the brake reservoir.

- When bleeding, be careful not to allow air in the brake reservoir flowing into the brake system.
- When using a brake bleeder, follow the manufacturer's instructions.
- Never use dirty or unspecified brake fluid or mix different brake fluids because it will damage the brake

Make sure to bleed air from the brake system.

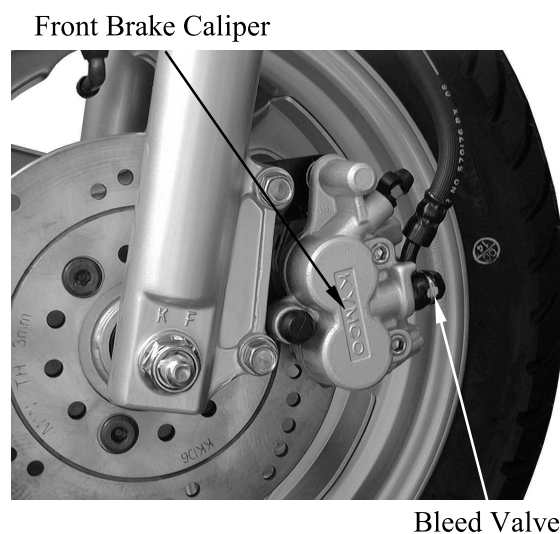
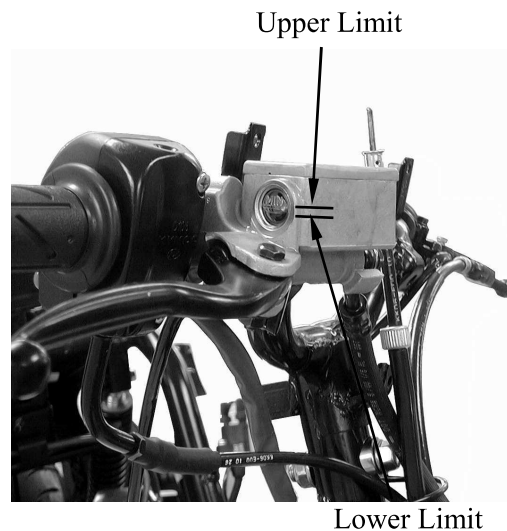

# 14. STEERING HANDLEBAR/FRONT WHEEL/FRONT BRAKE/FRONT SHOCK ABSORBER/FRONT FORK

## Brake Pad/Disk Replacement

□ The brake pads must be replaced as a set to ensure the balance of the brake disk.

Remove the two bolts attaching the brake caliper.  
Remove the brake caliper.  
Remove the brake pads.



Front Brake Caliper

Install the brake pads in the reverse order of removal.

**Torque:** 1.5□2.0kgf-m

Installation the caliper in the reverse order of removal.

**Torque:** 2.9□3.5kgf-m

□ Keep grease or oil off the brake pads to avoid brake failure.

Front Brake Caliper



Brake Pads

## Brake Disk

Measure the brake disk thickness.

**Service Limit:** 3.0mm

Measure the brake disk runout.

**Service Limit:** 0.3mm



# 14. STEERING HANDLEBAR/FRONT WHEEL/FRONT BRAKE/FRONT SHOCK ABSORBER/FRONT FORK

## BRAKE MASTER CYLINDER

### Removal

First drain the brake fluid from the hydraulic brake system.



- When servicing the brake system, use shop towels to cover rubber and plastic parts and coated surfaces to avoid being contaminated by brake fluid.
- When removing the brake fluid pipe bolt, be sure to plug the pipe to avoid brake fluid leakage.

Brake Master Cylinder      Bolts



### Disassembly

Remove the piston rubber cover and snap ring from the brake master cylinder.

Snap Ring

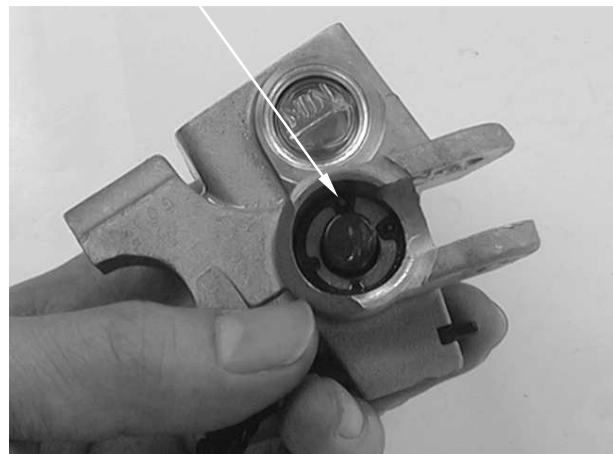

Remove the washer, main piston and spring from the brake master cylinder.  
Clean the inside of the master cylinder and brake reservoir with brake fluid.

Master Cylinder      Spring      Main Piston

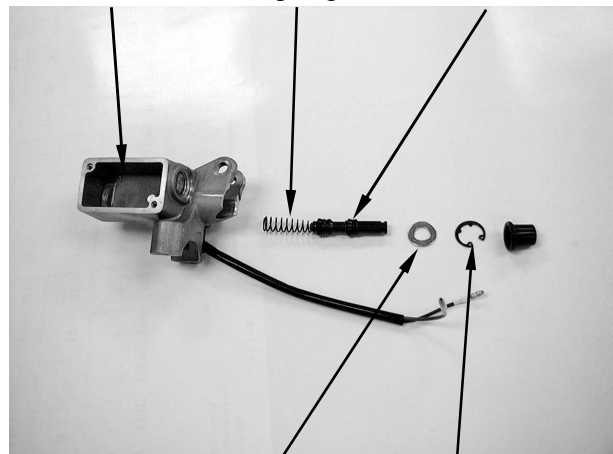

Washer      Snap Ring

# 14. STEERING HANDLEBAR/FRONT WHEEL/FRONT BRAKE/FRONT SHOCK ABSORBER/FRONT FORK

## Inspection

Measure the brake master cylinder I.D.

**Service Limit:** 12.75mm

Inspect the master cylinder for scratch or crack.

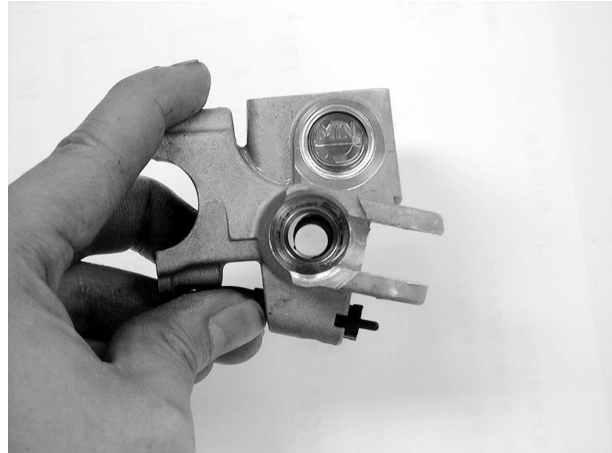

Measure the brake master cylinder piston O.D.

**Service Limit:** 12.64mm

Before assembly, inspect the 1st and 2nd rubber cups for wear.

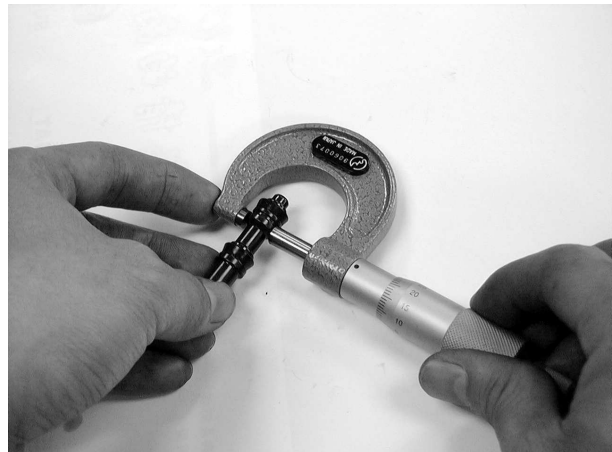

## Assembly

Before assembly, apply brake fluid to all removed parts.

Install the spring together with the 1st rubber cup.

- During assembly, the main piston and spring must be installed as a unit without exchange.
- When assembling the piston, soak the cups in brake fluid for a while.
- Install the cups with the cup lips facing the correct direction.

Install the main piston, spring and snap ring.

Install the rubber cover.

Install the brake lever.

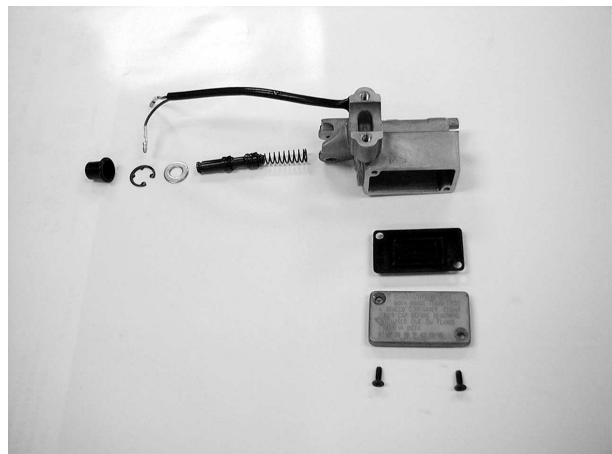

# 14. STEERING HANDLEBAR/FRONT WHEEL/FRONT BRAKE/FRONT SHOCK ABSORBER/FRONT FORK

Place the brake master cylinder on the handlebar and install the holder with “up” mark facing up. Be sure to align the punch mark with the holder joint. First tighten the upper bolt and then tighten the lower bolt.

**Torque:** 1.0□1.4kgf-m

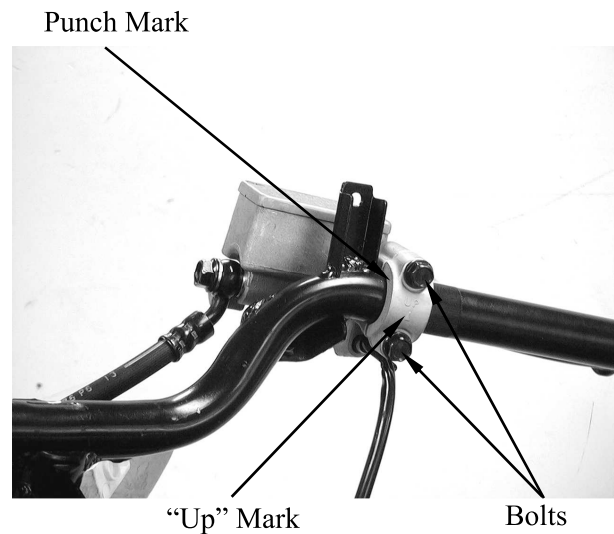

Install the brake fluid pipe with the attaching bolt and two sealing washers.

Fill the brake reservoir with recommended brake fluid to the upper limit and bleed air according to the method stated in 14-8.



## BRAKE CALIPER (FRONT)

### Removal

Remove the brake caliper. (⇒14-9)

Place a clean container under the brake caliper and disconnect the brake fluid pipe from the caliper.

□ Do not spill brake fluid on any coated surfaces.



# 14. STEERING HANDLEBAR/FRONT WHEEL/FRONT BRAKE/FRONT SHOCK ABSORBER/FRONT FORK

## Disassembly

Remove the brake caliper seat from the brake caliper.

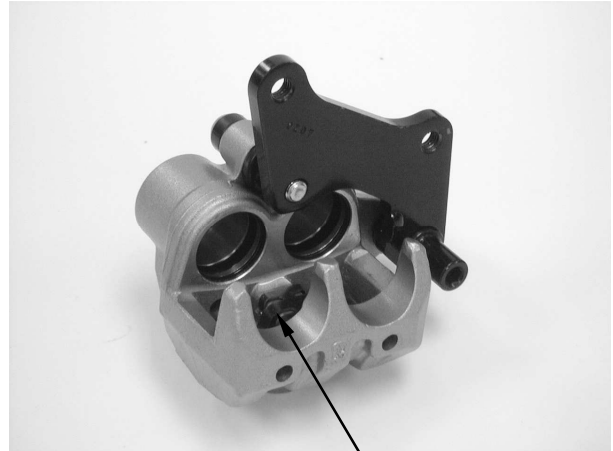

Brake Caliper Seat

Remove the piston from the brake caliper. If necessary, use compressed air to squeeze out the piston through the brake fluid inlet opening and place a shop towel under the caliper to avoid contamination caused by the removed piston. Check the piston cylinder for scratch or wear and replace if necessary.

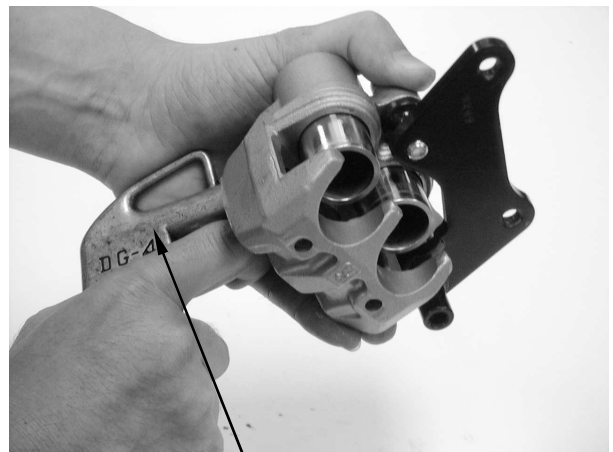

Compressed Air

Push the piston oil seal outward to remove it. Clean the oil seal groove with brake fluid.

□ Be careful not to damage the piston surface.

Piston Oil Seal

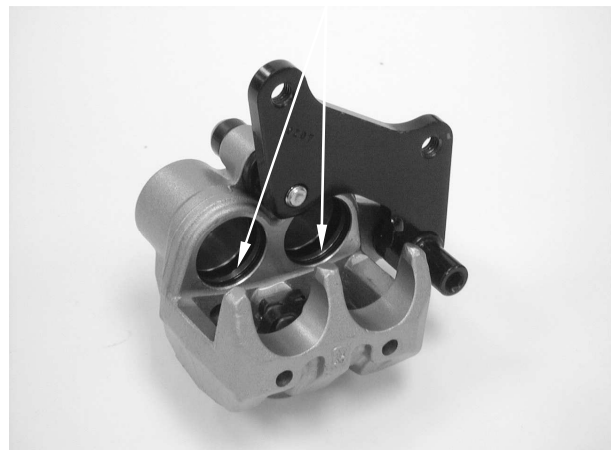



# 14. STEERING HANDLEBAR/FRONT WHEEL/FRONT BRAKE/FRONT SHOCK ABSORBER/FRONT FORK

Check the piston for scratch or wear.  
Measure the piston O.D. with a micrometer.  
**Service Limit:** 25.45mm



Check the caliper cylinder for scratch or wear and measure the cylinder bore.  
**Service Limit:** 25.30mm



## Assembly

Clean all removed parts.  
Apply silicon grease to the piston and oil seal. Lubricate the brake caliper cylinder inside wall with brake fluid.  
Install the brake caliper piston with grooved side facing out.

- Install the piston with its outer end 3 to 5mm protruding beyond the brake caliper.

Wipe off excessive brake fluid with a clean shop towel. Apply silicon grease to the brake caliper seat pin and caliper inside.  
Install the brake caliper seat.



# 14. STEERING HANDLEBAR/FRONT WHEEL/FRONT BRAKE/FRONT SHOCK ABSORBER/FRONT FORK

## Installation

Install the brake caliper and tighten the two bolts.

**Torque:** 2.9□3.5kgf-m



Bolts

Connect the brake fluid pipe to the brake caliper and tighten the fluid pipe bolt.

**Torque:** 3.0□4.0kgf-m

Fill the brake reservoir with recommended brake fluid and bleed air from the brake system. (⇒14-8)



Bolt

# 14. STEERING HANDLEBAR/FRONT WHEEL/FRONT BRAKE/FRONT SHOCK ABSORBER/FRONT FORK

## FRONT SHOCK ABSORBER

### REMOVAL

Remove the front wheel. (⇒14-5)  
Remove the front body cover. (⇒13-9)

Remove the front shock absorber upper mount bolts.  
Loosen the lower mount bolts to remove the front shock absorbers.

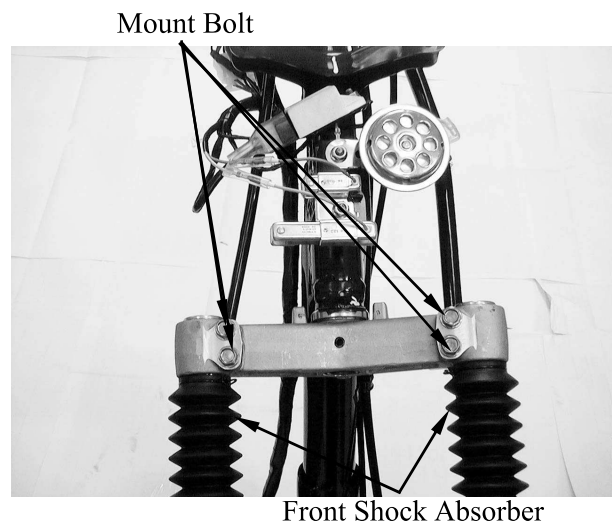

### LEFT FRONT SHOCK ABSORBER DISASSEMBLY

Remove the dust boot.  
Remove the circlip.

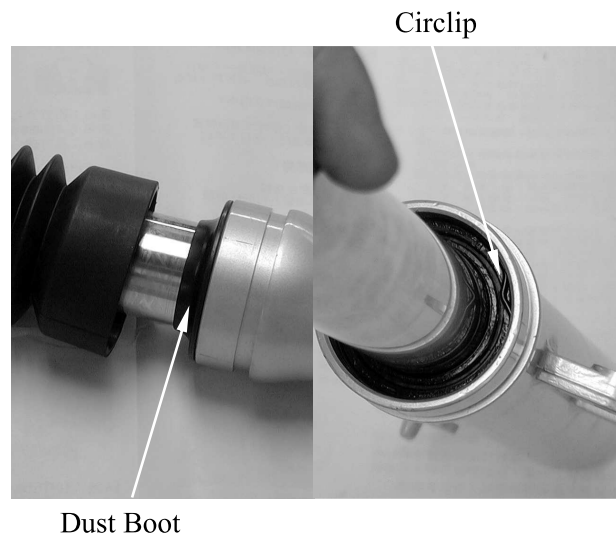

Use a vise to hold the front shock absorber and remove the shock absorber tube, hex bolt and copper washer from the front shock absorber.

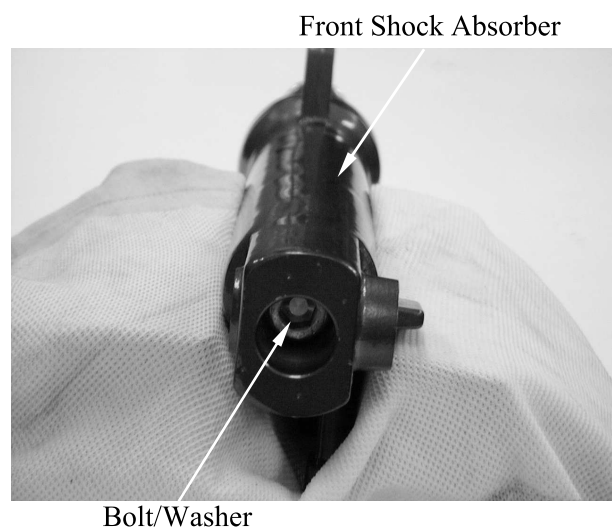

# 14. STEERING HANDLEBAR/FRONT WHEEL/FRONT BRAKE/FRONT SHOCK ABSORBER/FRONT FORK

Use a vise to hold the front shock absorber tube and remove the damper from the shock absorber tube.

When holding the shock absorber tube, place a shop towel under it and do not apply too much force.



Measure the front shock absorber spring free length.

**Standard Limit:** 214.7

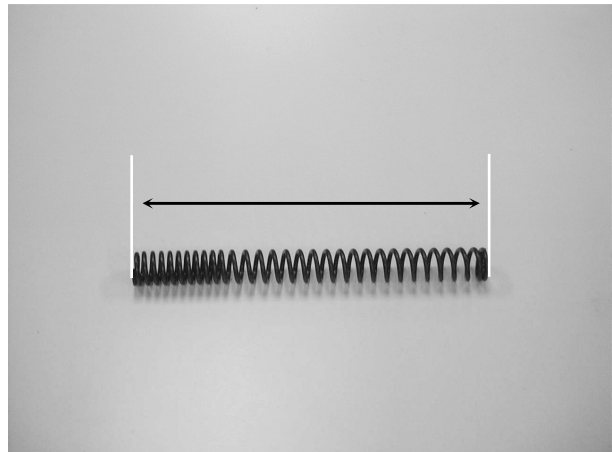

## FRONT SHOCK ABSORBER ASSEMBLY

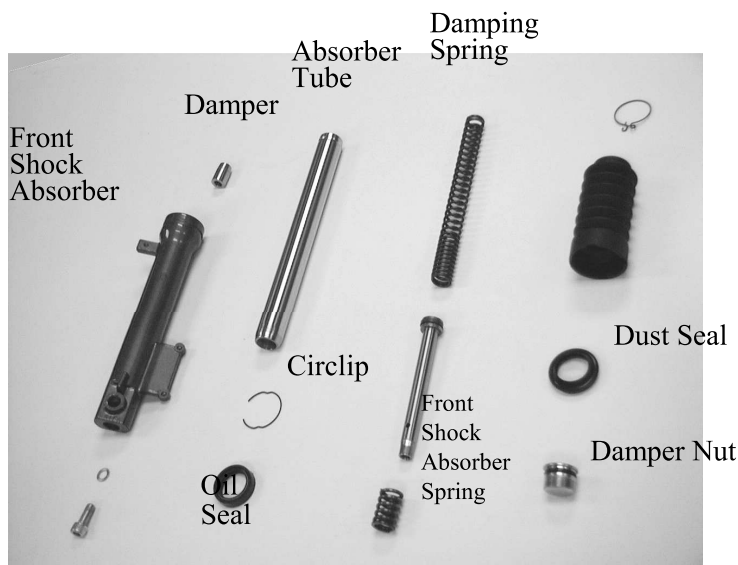

# 14. STEERING HANDLEBAR/FRONT WHEEL/FRONT BRAKE/FRONT SHOCK ABSORBER/FRONT FORK

Install the damping spring to the damper and then install them into the front shock absorber tube.  
Install the front shock absorber spring and tighten the damper nut.

□ Install the front shock absorber spring with the loosely wound coils facing up.



Damper Nut

Use a vise to hold the front shock absorber.  
Tighten the hex bolt.  
(Apply locking agent to the washer and socket hex bolt and install them together.)

**Torque:** 1.5□3.0kgf-m

**Specified Oil:** ss#8

**Oil Capacity:** 53cc

Front Shock Absorber



Bolt/Washer

Install the circlip.  
Install the dust boot.

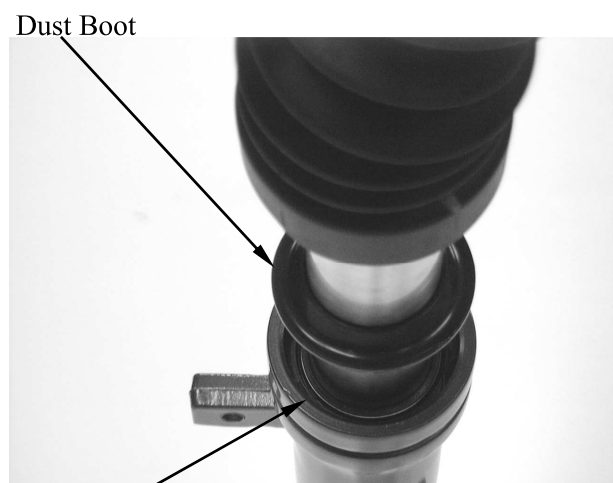

Circlips

# 14. STEERING HANDLEBAR/FRONT WHEEL/FRONT BRAKE/FRONT SHOCK ABSORBER/FRONT FORK

## INSTALLATION

Install the front shock absorbers onto the steering stem.  
Install and tighten the front shock absorber upper mount bolts.  
Tighten the lower mount bolts.  
**Torque:** 3.0□3.6kgf-m

Install the front body cover. (⇒13-9)  
Install the front wheel. (⇒14-5)

Mount Bolt

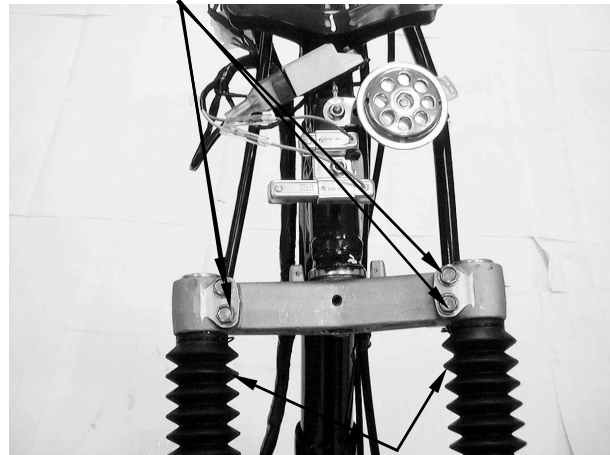

Front Shock Absorber

## FRONT FORK

### REMOVAL

Remove the steering handlebar. (⇒14-3)  
Disconnect the speedometer cable and front brake fluid tube and remove the front brake caliper. (⇒14-8)  
Remove the front wheel. (⇒14-5)

Lock Nut



Top Cone Race

Remove steering stem lock nut with lock the lock nut socket wrench.  
Remove the top cone race and remove the front fork.

### SPECIAL TOLLS

Long socket wrench      F007

Lock Nut Socket Wrench

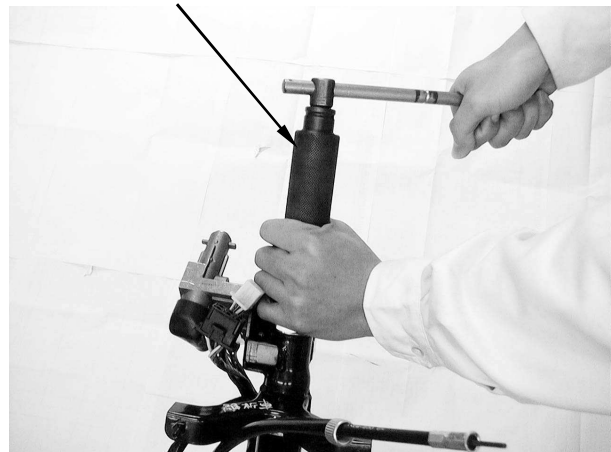

Top Cone Race

Be careful not to lose the steel balls (26 on top race and 19 on bottom race).

Inspect the ball races, cone races and steel balls for wear or damage. Replace if necessary.

# 14. STEERING HANDLEBAR/FRONT WHEEL/FRONT BRAKE/FRONT SHOCK ABSORBER/FRONT FORK

## BOTTOM CONE RACE REPLACEMENT

Remove the bottom cone race using a chisel.  
Drive a new bottom cone race into place with a proper driver.

□ Be careful not to damage the steering stem and front fork.



Bottom Cone Race

## BALL RACE REPLACEMENT

Drive out the ball races.

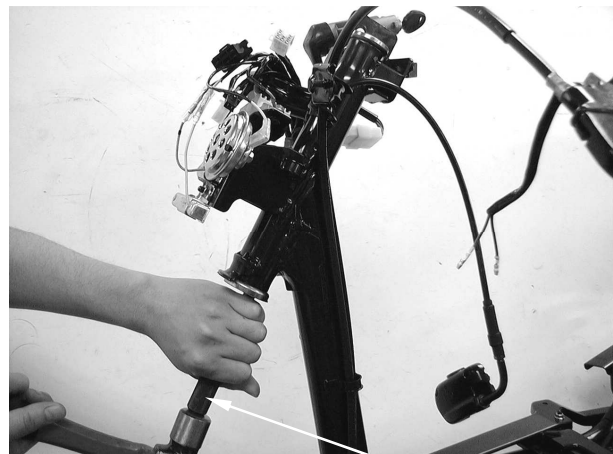

Ball Race Remover

Drive in new ball races.

## SPECIAL TOOLS

Race cone install                      F005

□ Be sure to drive the ball races into place completely.

Driver Handle A

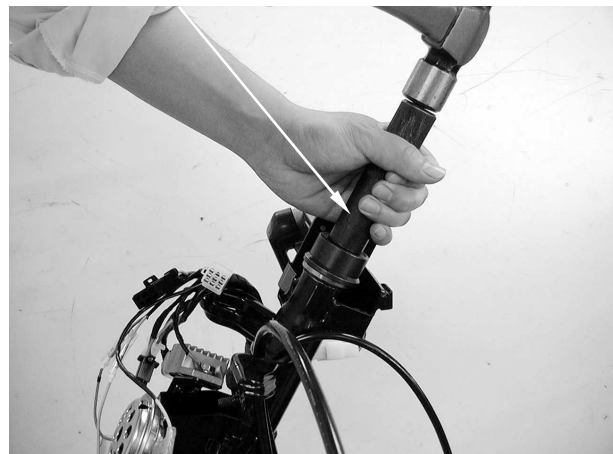

# 14. STEERING HANDLEBAR/FRONT WHEEL/FRONT BRAKE/FRONT SHOCK ABSORBER/FRONT FORK

## INSTALLATION

Apply grease to top and bottom ball races and install 26 steel balls on the top ball race and 19 steel balls on the bottom ball race. Apply grease to the ball races again and then install the front fork.



Apply grease to the top cone race and install it.

Tighten the top cone race and then turn the steering stem right and left several times to make steel balls contact each other closely.

**Torque:** 0.5□1.3kgf-m

□ Check that the steering stem rotates freely without vertical play.



Top Cone Race

Install the steering stem lock nut and tighten it while holding the top cone race.

**Torque:** 6.0□8.0kgf-m

### SPECIAL TOOLS

Lock nut socket wrench F007

Install the handlebar. (⇒14-3)  
Install the speedometer cable.



Top Con Race Wrench



---

**REAR WHEEL/REAR BRAKE/REAR SHOCK ABSORBER**

---

SERVICE INFORMATION ..... 15-2  
TROUBLESHOOTING ..... 15-2  
REAR WHEEL..... 15-3  
REAR BRAKE ..... 15-4  
REAR SHOCK ABSORBER..... 15-6

# 15. REAR WHEEL/REAR BRAKE/REAR SHOCK ABSORBER

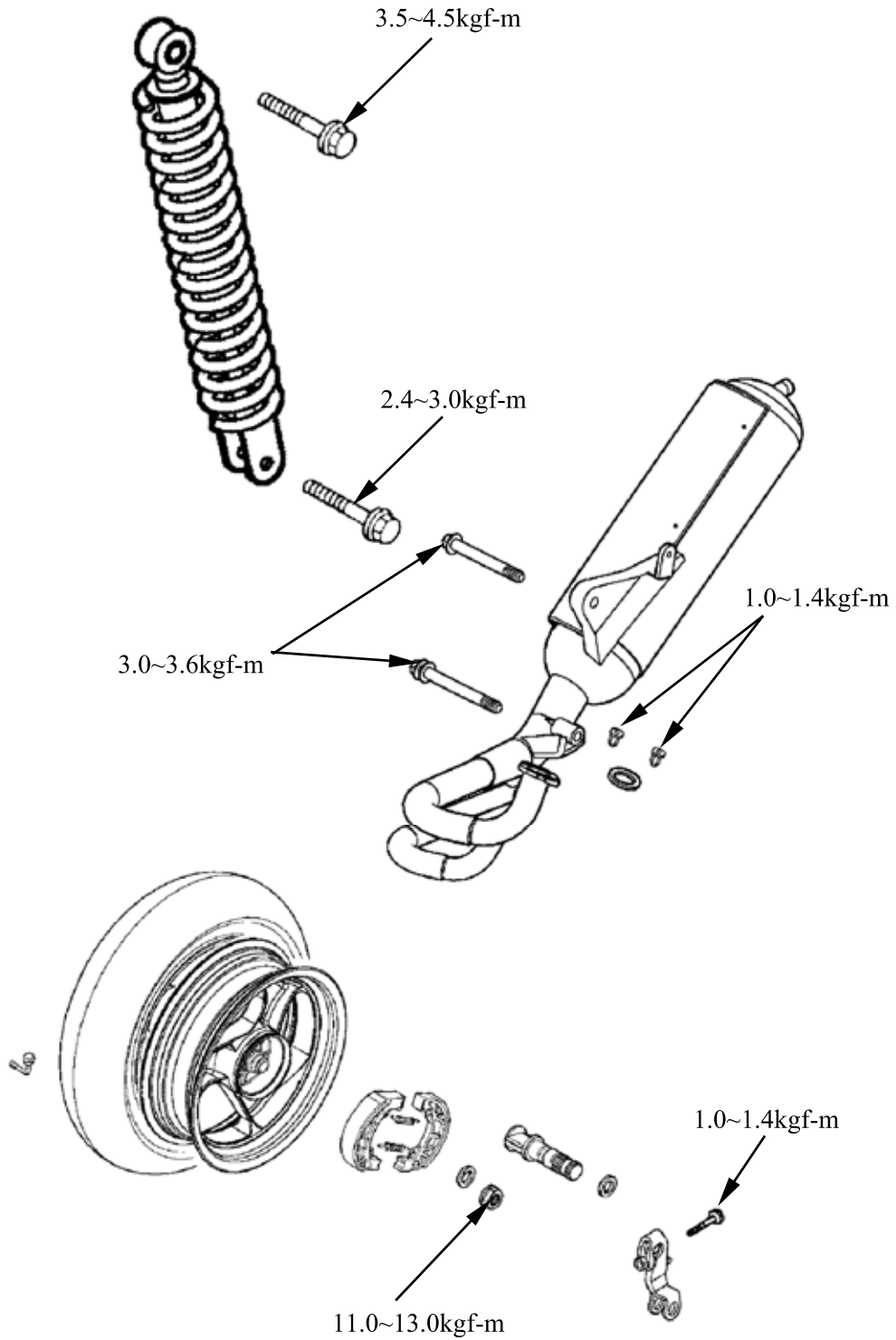

# 15. REAR WHEEL/REAR BRAKE/REAR SHOCK ABSORBER

## SERVICE INFORMATION

### SPECIFICATIONS

Item	Standard (mm)	Service Limit (mm)
Rear wheel rim runout		2.0
Rear brake drum I.D.	110	111
Rear brake lining thickness	6.4	2.0
Rear shock absorber spring free length	209	

### TORQUE VALUES

Rear axle nut	11.0~13.0kgf-m
Rear shock absorber upper mount bolt	3.5~4.5kg-m
Rear shock absorber lower mount bolt	2.4~3.0kg-m

### TROUBLESHOOTING

#### Rear wheel wobbling

- Bent rim
- Faulty tire
- Axle not tightened properly

#### Soft rear shock absorber

- Weak shock absorber spring

#### Poor brake performance

- Brake not adjusted properly
- Contaminated brake linings
- Worn brake linings
- Worn brake shoes at cam contacting area
- Worn brake cam
- Improper engagement between brake arm and wear indicator plate

# 15. REAR WHEEL/REAR BRAKE/REAR SHOCK ABSORBER

## REAR WHEEL

### REMOVAL

Remove the exhaust muffler. (⇒13-10)

Remove the rear axle nut to remove the rear wheel.

Rear Axle Nut



### INSPECTION

Measure the rear wheel rim runout.

#### Service Limits:

Radial : 2.0mm replace if over

Axial : 2.0mm replace if over

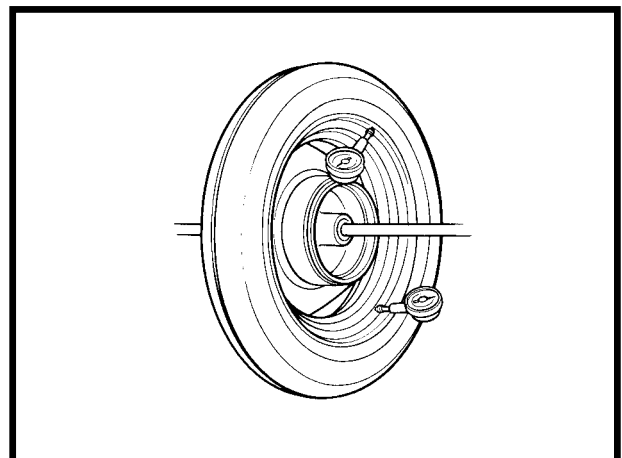

### INSTALLATION

Install the rear wheel and apply SAE30# engine oil to the axle threads. Then, tighten the rear axle nut.

#### Torque values:

Rear axle nut: 11.0~13.0kg-m

Rear Axle Nut



# 15. REAR WHEEL/REAR BRAKE/REAR SHOCK ABSORBER

## REAR BRAKE

Remove the rear wheel. (⇒15-3)

Inspect the rear brake drum.  
Measure the rear brake drum I.D.

**Service Limit:** 95.5mm replace if over

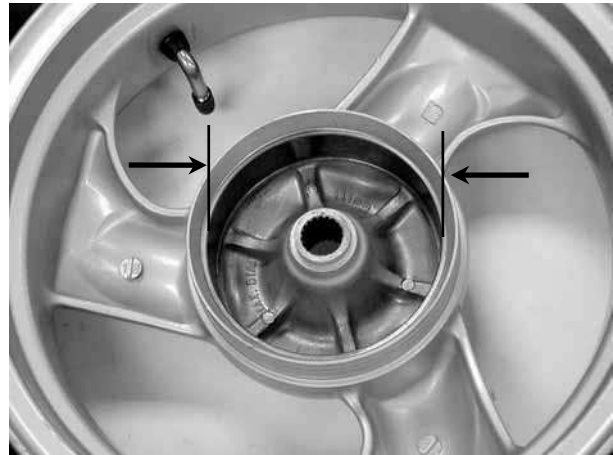

## BRAKE LINING INSPECTION

Measure the brake lining thickness.

**Service Limit:** 2.0mm replace if below

\* Keep oil or grease off the brake linings.

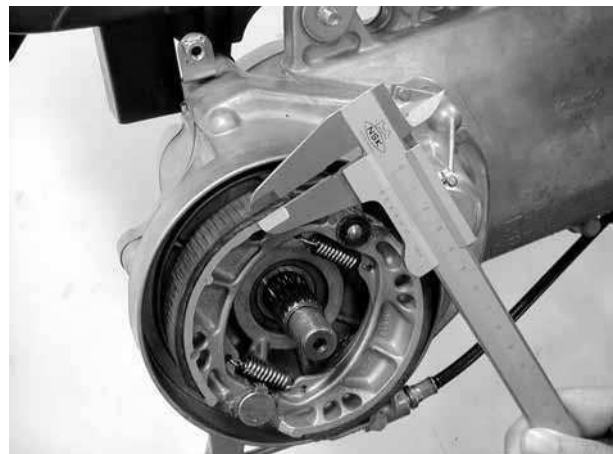

## REAR BRAKE DISASSEMBLY

Remove the rear brake adjusting nut and disconnect the rear brake cable.  
Remove the rear brake shoes.

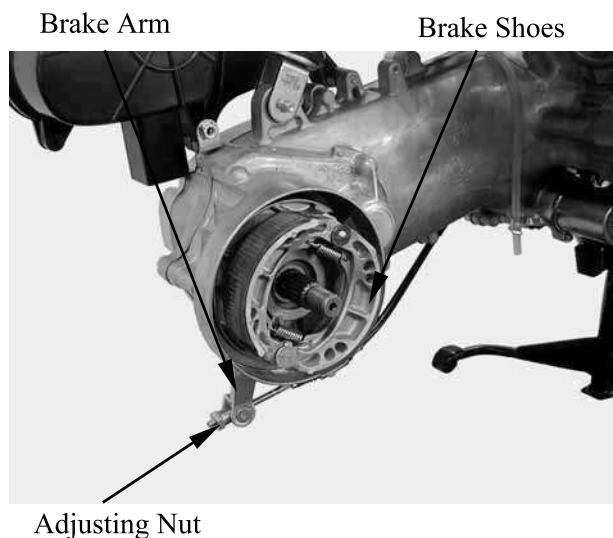

# 15. REAR WHEEL/REAR BRAKE/REAR SHOCK ABSORBER

Remove the brake cam bolt to remove the brake arm, wear indicator plate and felt seal.  
Remove the brake arm.

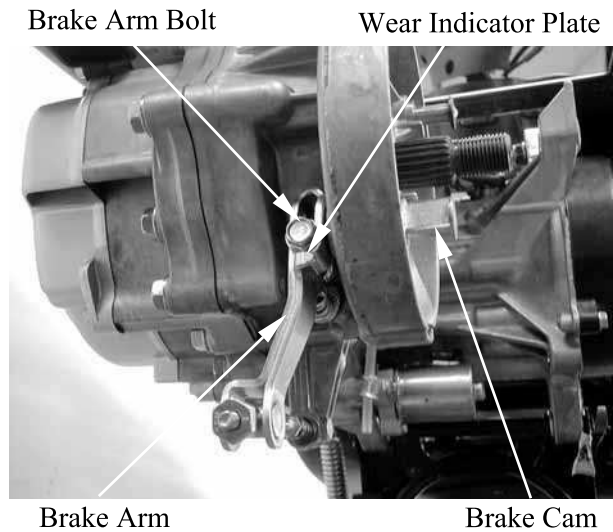

## REAR BRAKE ASSEMBLY

Apply grease to the anchor pin and brake shoe moving parts.  
Apply grease to the brake cam and install it.

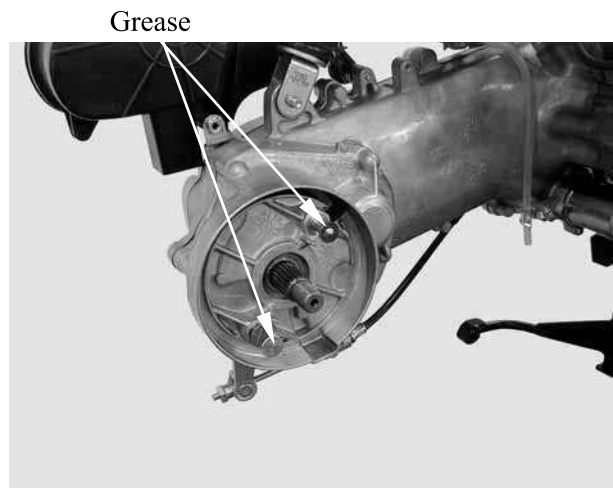

Apply engine oil to the felt seal and install it to the brake cam.  
Install the wear indicator plate.

- \* Align the wide tooth of the wear indicator plate with the wide groove on the brake cam.

Install the brake arm onto the brake cam.

- \* Align the punch mark on the brake arm with the scribed line on the brake cam.

Install and tighten the brake arm bolt.  
Install the brake arm return spring.  
Install the brake shoes.

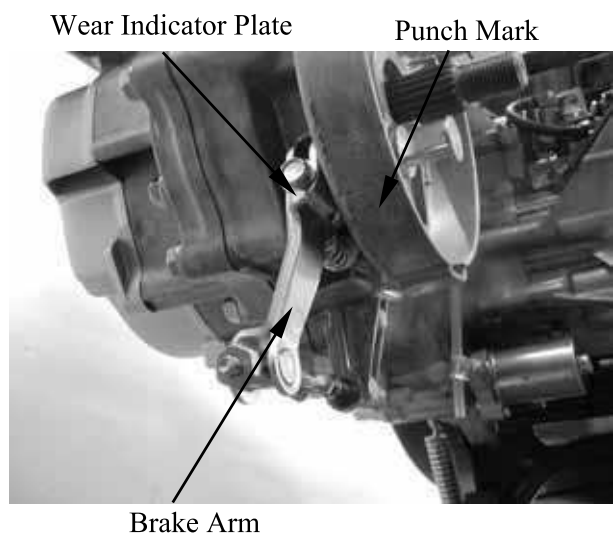

# 15. REAR WHEEL/REAR BRAKE/REAR SHOCK ABSORBER

Install the brake arm pin.  
Connect the brake cable and install the adjusting nut.

Install the rear wheel. (⇒15-3)  
Adjust the rear brake lever free play. (⇒3-2)

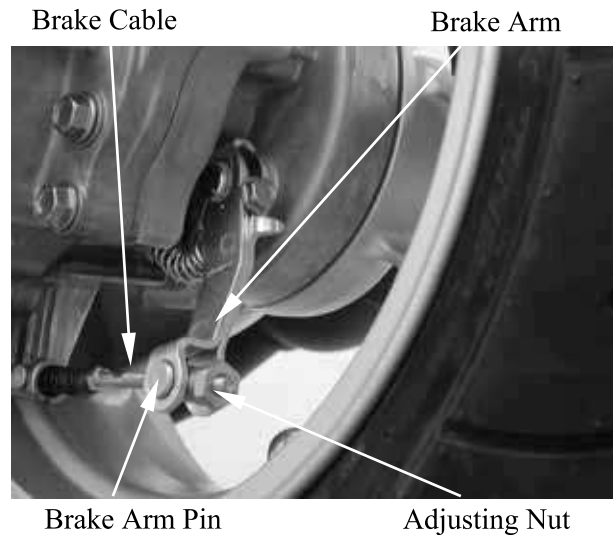

## REAR SHOCK ABSORBER

### REMOVAL

Remove the rear body cover. (⇒13-6)  
Remove the air cleaner case. (⇒5-2 or ⇒5-7)

Remove the rear shock absorber upper and lower mount bolts to remove the rear shock absorber.

### INSTALLATION

Install the rear shock absorber.  
Install the rear shock absorber upper mount bolt and then install the lower mount bolt.

#### Torque:

**Upper Mount Bolt:** 3.5~4.5kgf-m

**Lower Mount Bolt:** 2.4~3.0kgf-m

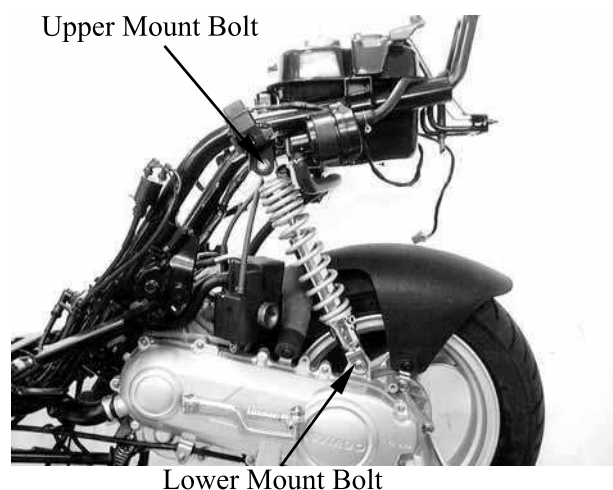

---

**16. ELECTRICAL EQUIPMENT**

---

---

**ELECTRICAL EQUIPMENT**

---

SERVICE INFORMATION .....	16- 1
TROUBLESHOOTING .....	16- 1
CHARGING SYSTEM .....	16- 3
BATTERY .....	16- 5
IGNITION SYSTEM .....	16-11
ELECTRIC STARTER .....	16-17



# 16. ELECTRICAL EQUIPMENT

## SERVICE INFORMATION

### GENERAL INSTRUCTIONS

- It is not necessary to check the battery electrolyte or fill with distilled water.
- Remove the battery from the motorcycle for charging. Do not remove the electrolyte cap..
- Do not quick charge the battery. Quick charging should only be done in an emergency..
- Charge the battery according to the charging current and time specified on the battery.
- When charging, check the voltage (open voltage) with an electric tester.
- When replacing the battery, do not use a traditional battery.

### SPECIFICATIONS

		2-Stroke	4-Stroke
Battery	Capacity	12V3AH	12V4AH
	Voltage	13.0□13.2V	13.0□13.2V
	Charging current	Standard Quick	0.4A/5H~10H 4A/0.5H
Spark plug	(NGK)	BR8HSA	C7HSA
Spark plug gap		0.6□0.7mm	0.6□0.7mm
Ignition coil resistance	Primary coil	0.153□0.187Ω	0.5Ω
	Secondary coil (with plug cap)	6.99k□10.21KΩ	8.12KΩ
	Secondary coil (without plug cap)	3.24k□3.96KΩ	3KΩ
Pulser coil resistance (20□)		80□160Ω	118.1□118.2Ω
Ignition timing		13.5°±2°BTDC/3000rpm	28°±2°BTDC/4000rpm

## TROUBLESHOOTING

### CHARGING SYSTEM

#### No power

- Dead battery
- Disconnected battery cable
- Fuse burned out
- Faulty ignition switch

#### Low power

- Weak battery
- Loose battery connection
- Charging system failure
- Faulty regulator/rectifier

#### Intermittent power

- Loose battery cable connection
- Loose charging system connection
- Loose connection or short circuit in ignition system
- Loose connection or short circuit in lighting system

#### Charging system failure

- Loose, broken or shorted wire or connector
- Faulty regulator/rectifier
- Faulty A.C. generator

# 16. ELECTRICAL EQUIPMENT

---

## IGNITION SYSTEM

### No spark at plug

- Faulty spark plug
- Poorly connected, broken or shorted wire
  - Between A.C. generator and CDI unit
  - Between CDI unit and ignition coil
  - Between CDI unit and ignition switch
  - Between ignition coil and spark plug
- Faulty ignition switch
- Faulty ignition coil
- Faulty CDI unit
- Faulty A.C. generator

### Engine starts but turns poorly

- Ignition primary circuit
  - Faulty ignition coil
  - Poorly connected wire or connector
- Ignition secondary circuit
  - Faulty ignition coil
  - Faulty spark plug
  - Poorly insulated plug cap
- Improper ignition timing
  - Battery voltage too low (6V max.)
  - Faulty CDI unit

## STARTING SYSTEM

### Starter motor won't turn

- Fuse burned out
- Weak battery
- Faulty ignition switch
- Faulty starter switch
- Faulty front or rear stop switch
- Faulty starter relay
- Poorly connected, broken or shorted wire
- Faulty starter motor

### Lack of power

- Weak battery
- Loose wire or connection
- Foreign matter stuck in starter motor or pinion

### Starter motor rotates but engine does not start

- Faulty starter pinion
- Starter motor rotates reversely
- Faulty starter clutch
- Weak battery

# 16. ELECTRICAL EQUIPMENT

## CHARGING SYSTEM (2-STROKE)

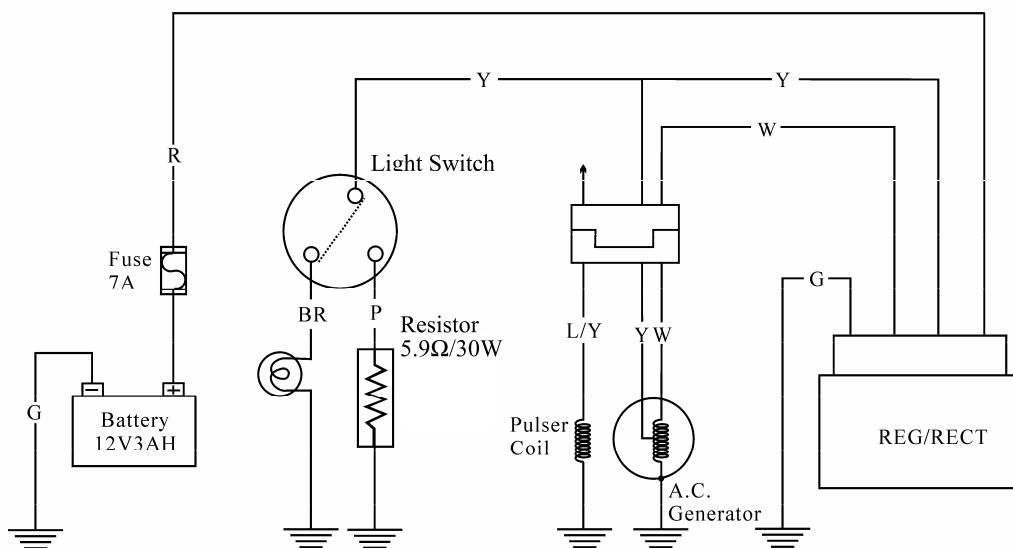
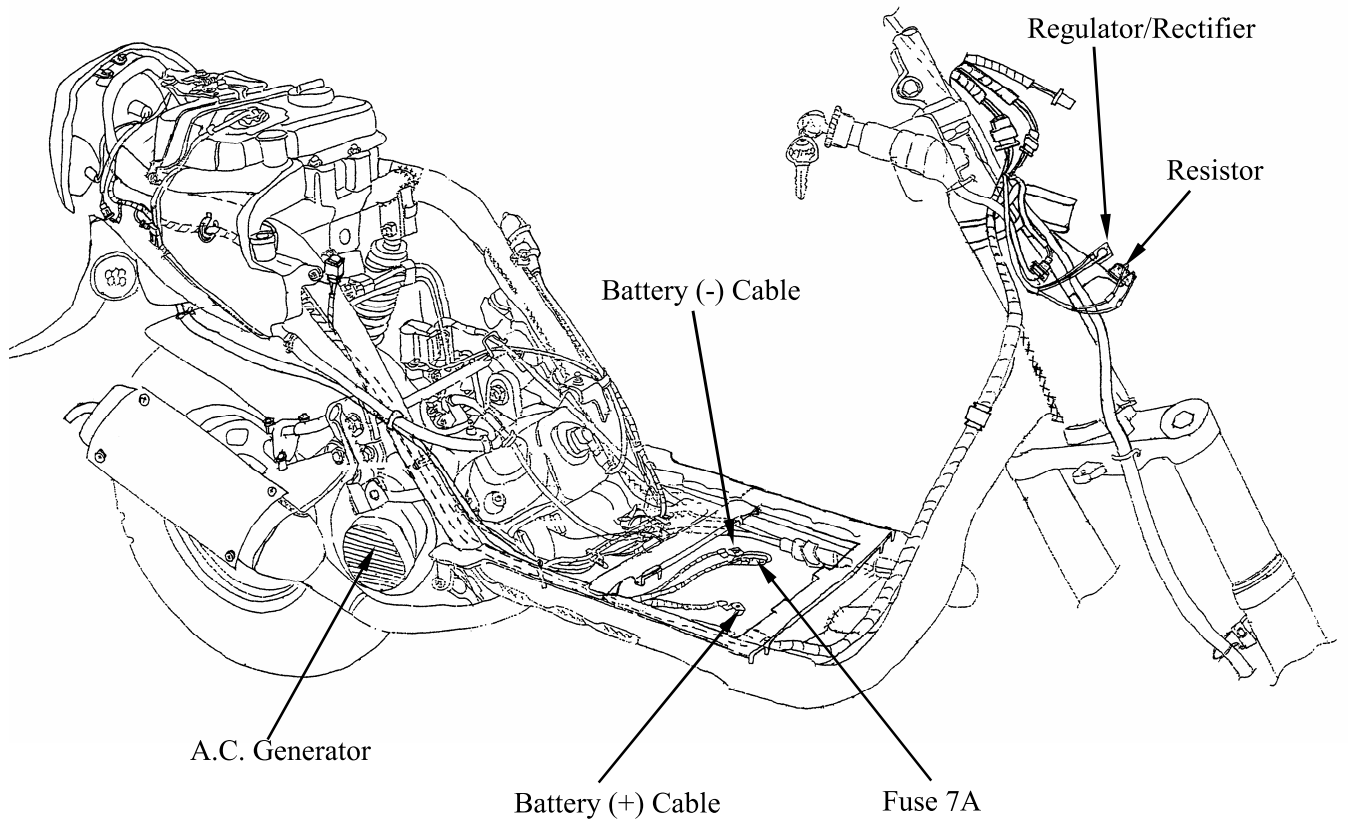

# 16. ELECTRICAL EQUIPMENT

## CHARGING SYSTEM (4-STROKE)

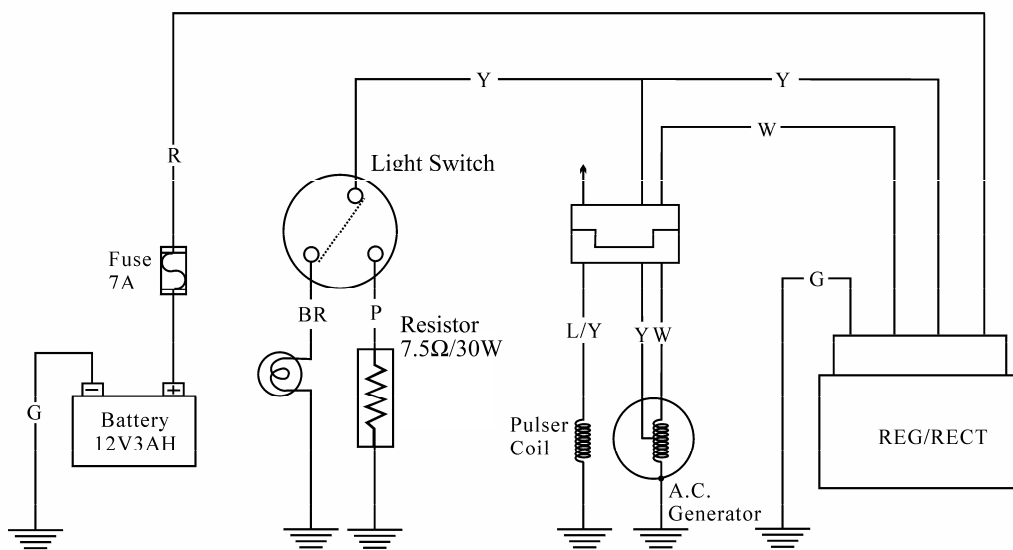
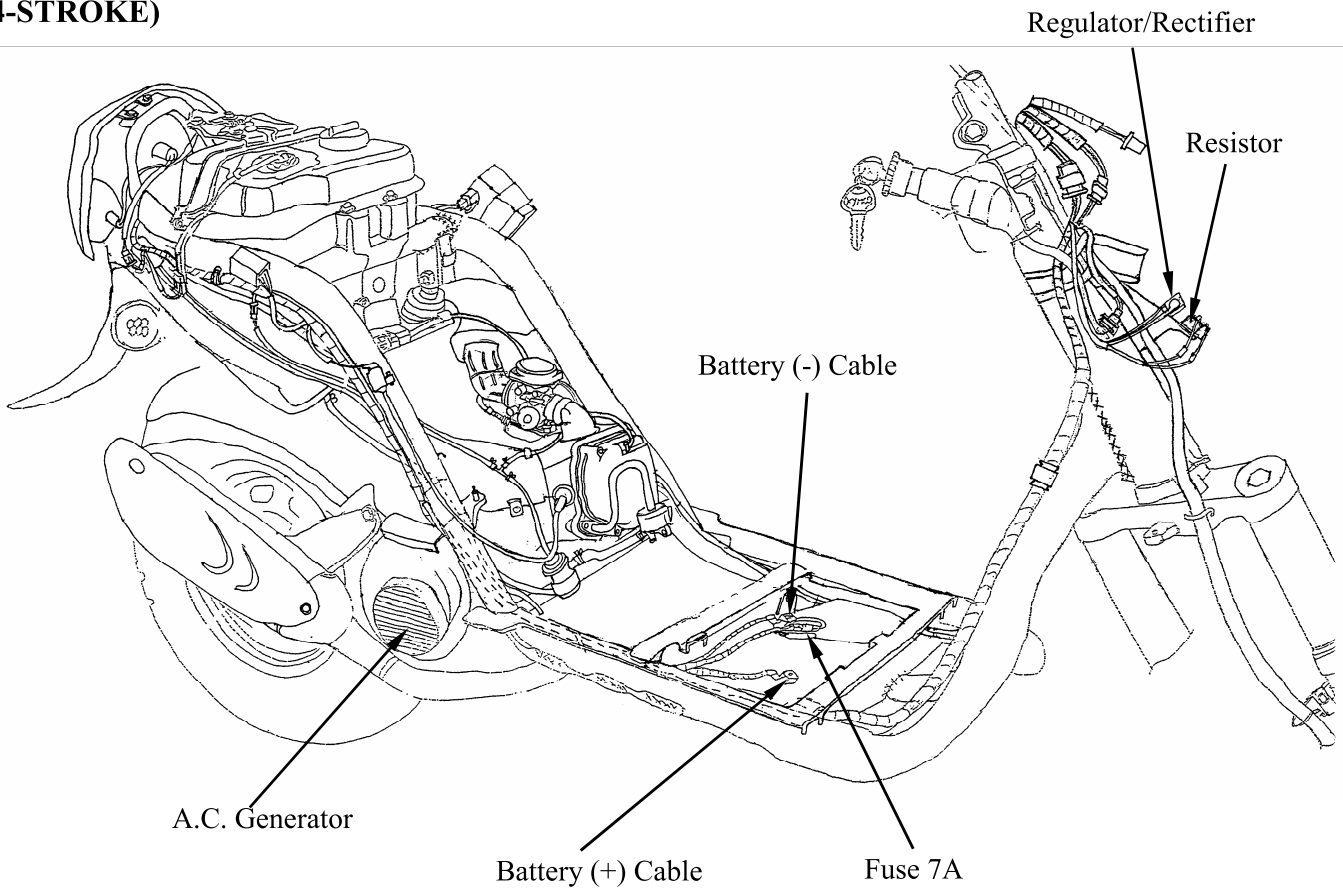

# 16. ELECTRICAL EQUIPMENT

## BATTERY

### BATTERY REMOVAL

1. Make sure the ignition switch is OFF.
2. Remove the screw (1).
3. Push the two retainer clips (2) and remove the battery cover (3)

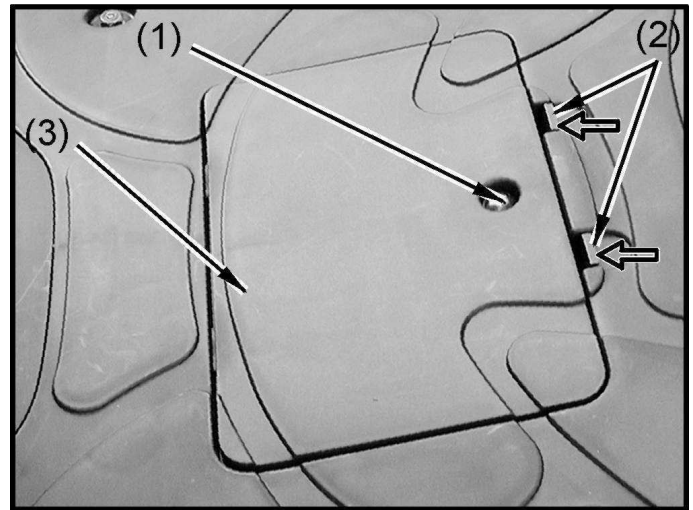

4. Disconnect the negative (-) terminal lead (1) from the battery first, then disconnect the positive (+) terminal lead (2).
5. Remove the battery.

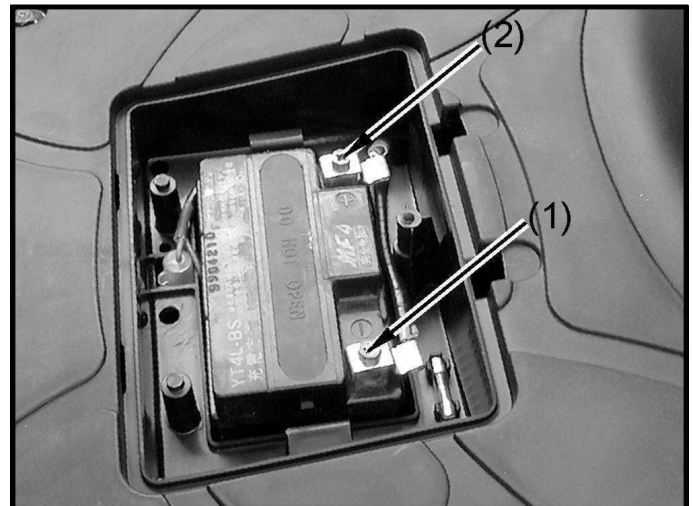

- This model adopts the battery which needs no refilling of distilled water.
- When cleaning the terminals, remove the screws attaching the battery cover on the footboard and then open the battery cover.
- When battery terminals are corroded, take out the battery for cleaning.
- After cleaning, apply a thin coat of grease or vaseline to battery terminals and then install the battery.

- Never open the closed-type battery electrolyte cap.
- If the scooter will not be used for a long time, the battery will discharge electricity by itself. Remove the battery and put it in a cool place after it is fully charged to prevent electricity leakage.
- If the scooter will not be used for a long time, remove the negative (-) terminal.
- Do not smoke or allow flames or sparks near the battery while removing and installing it.
- Turn off the ignition switch before removal or installation. The negative (-) terminal shall be removed first and the positive (+) terminal shall be installed first.
- Tighten the loose terminal nuts securely.

# 16. ELECTRICAL EQUIPMENT

## BATTERY INSPECTION

Remove the battery cover and disconnect the battery cables.

Measure the voltage (20°C/68°F) between the battery terminals.

Fully charged : 13.0V□13.2V

Undercharged: 12.3V max.

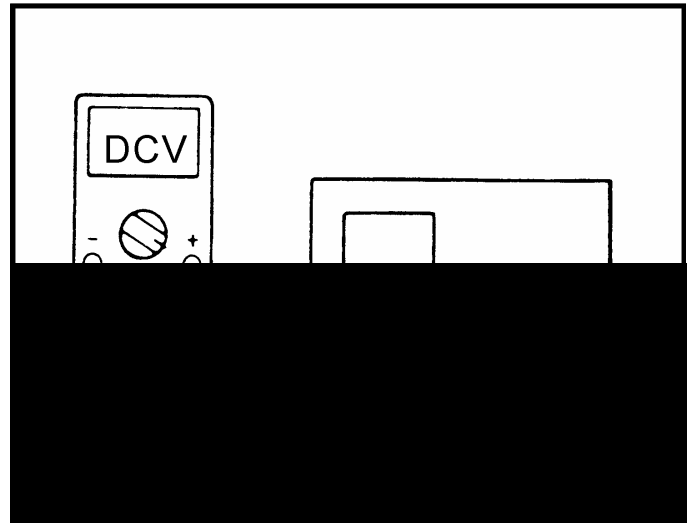

## CHARGING METHOD

Connect the charger positive (+) cable to the battery positive (+) cable.

Connect the charger negative (-) cable to the battery negative (-) cable.



- Keep flames and sparks away from a charging battery.
- Turn power ON/OFF at the charger, not at the battery terminals to prevent sparks near the battery.
- Charge the battery according to the current specified on the battery surface.

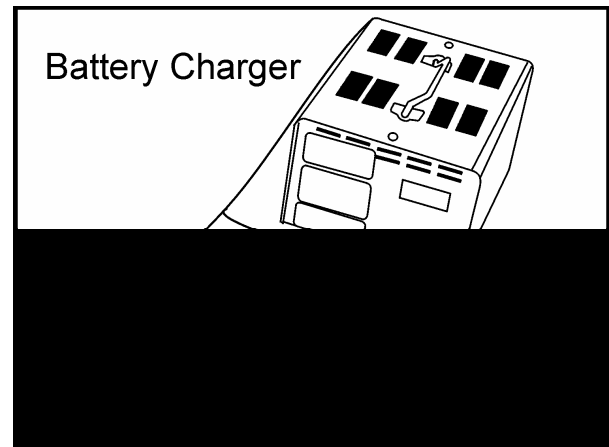

Black

Red

Charging current: Standard : 0.4A

Quick : 4A

Charging time : Standard : 5 ~10hours

Quick : 0.5 hour

After charging: Open circuit voltage: 12.8V min.



- Quick charging should only be done in an emergency.
- During quick charging, the battery temperature should not exceed 45□.
- Measure the voltage 30 minutes after the battery is charged.

# 16. ELECTRICAL EQUIPMENT

## CURRENT LEAKAGE TEST

Turn the ignition switch “OFF”.

Remove the battery cover.

Disconnect the negative (-) cable from the battery.

Connect the ammeter (+) probe to the negative (-) cable and the ammeter (-) probe to the battery (-) terminal.

With the ignition switch “OFF”, check for current leakage.

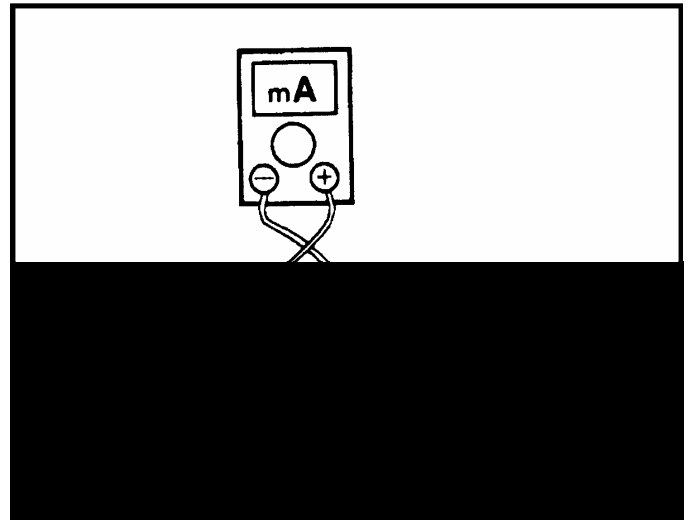

- • When measuring current using a tester, set it to high range, and then bring the range down to an appropriate level. Current flow higher than the range selected may blow out the fuse in the tester.
- While measuring current, do not turn the ignition switch “ON”. A sudden surge of current may blow out the fuse in the tester.

Specified current leakage: 1mA maximum

If current leakage exceeds the specified value, a shorted circuit is likely.

Locate the short by disconnecting connections one by one and measuring the current.

# 16. ELECTRICAL EQUIPMENT

## CHARGING VOLTAGE INSPECTION

- Make sure the battery is in good condition before performing this test.

Start the engine and warm it up to operating temperature; stop the engine.

Connect the multimeter between the positive and negative terminals of the battery.

- To prevent a short, make absolutely certain which are the positive and negative terminals or cable.

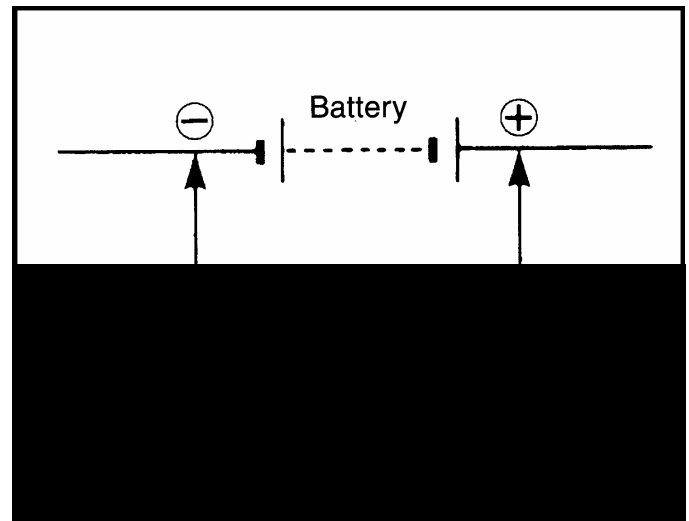

With the headlight on high beam, restart the engine.

Measure the voltage on the multimeter when the engine runs at 8000 rpm

**Charging Limit Voltage:**  $14.5 \pm 0.5V/8000rpm$

If the limit voltage is not within the specified range, check the regulator/rectifier.

## A.C. GENERATOR (CHARGING COIL) INSPECTION

- Inspect with the engine installed.

Remove the met-in box and center cover. (⇒ 13-5)

Disconnect the A.C. generator connector. Measure the resistances between the charging coil terminals (white- ground) and lighting coil terminals (yellow-ground).

**Resistance (2-Stroke):**

Charging coil	white- ground	$0.2 \square 1.2\Omega$
Lighting coil	yellow- ground	$0.3 \square 1.0\Omega$

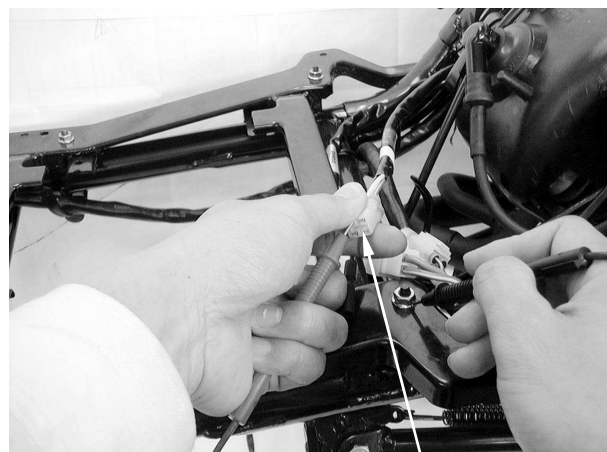

A.C. Generator Connector

Refer to 8 section for A.C. generator removal.



# 16. ELECTRICAL EQUIPMENT

## Resistance (4-Stroke):

Charging coil	white- ground	0.9Ω
Lighting coil	yellow- ground	0.7Ω

Refer to 8 section for A.C. generator removal.



A.C. Generator Connector

## RESISTOR INSPECTION

Remove the frame front cover. (⇒13-4)

Measure the resistance between the resistor B pink wire and ground.

Measure the resistance between the resistor A green/black wire and ground.

### Resistance (2-Stroke):

Resistor A: 9.2□11.2Ω

Resistor B: 5.3□6.5Ω

### Resistance (4-Stroke):

Resistor A: 7.7□8.3Ω

Resistor B: 12.0□12.8Ω



Faulty resistor is the cause of faulty operation of the auto bystarter.

Resistor B

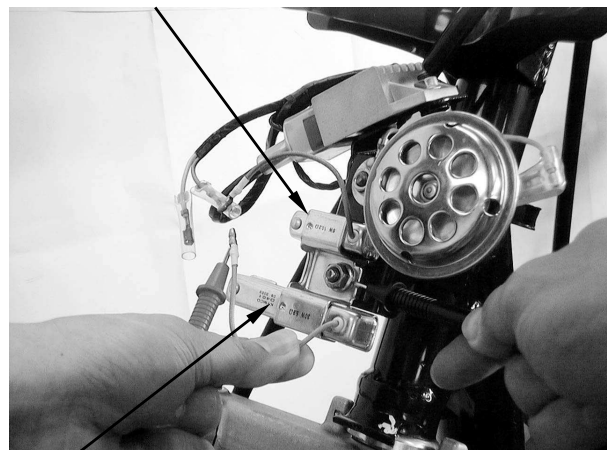

Resistor A

# 16. ELECTRICAL EQUIPMENT

## REGULATOR/RECTIFIER INSPECTION

Remove the front cover. (⇒13-4)

Disconnect the regulator/rectifier wire coupler and remove the nut to remove the regulator/rectifier.

Measure the resistances between the terminals.

Replace the regulator/rectifier if the readings are not within the specifications in the table below.

□ • Due to the semiconductor in circuit, it is necessary to use a specified tester for accurate testing. Use of an improper tester in an improper range may give false readings.

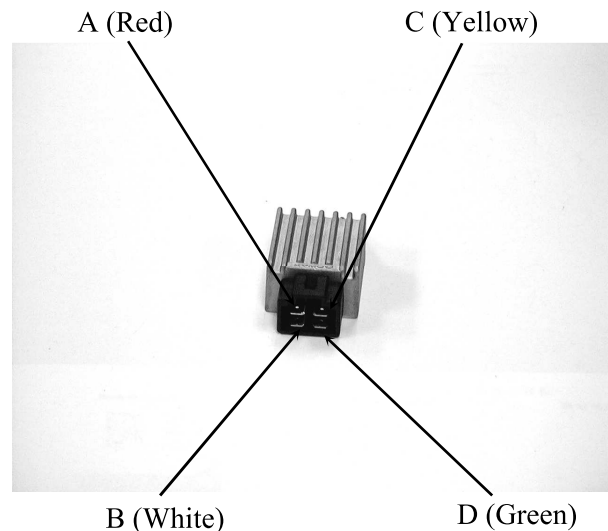
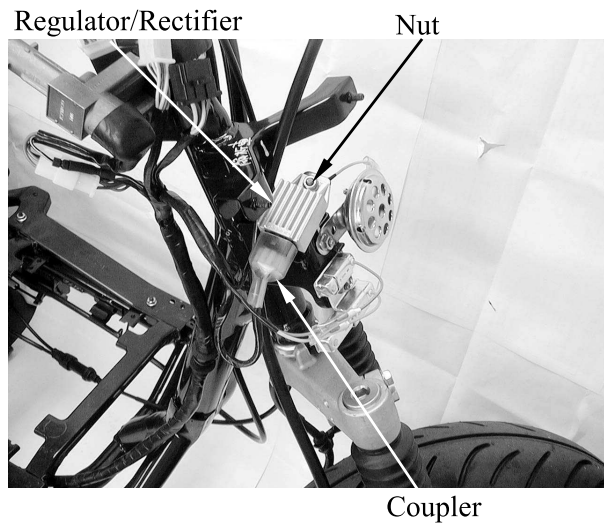

### 2-Stroke

Probe⊕ Probe(-)	A (R)	B (W)	C (Y)	D (G)
A (R)		∞	∞	∞
B (W)	3-10KΩ		∞	∞
C (Y)	∞	∞		33-35KΩ
D (G)	∞	∞	33-35KΩ	

### 4-Stroke

Probe⊕ Probe(-)	A (R)	B (W)	C (Y)	D (G)
A (R)		3-4MΩ	∞	∞
B (W)	6-8MΩ		∞	∞
C (Y)	∞	∞		14-15MΩ
D (G)	∞	∞	14-15MΩ	

# 16. ELECTRICAL EQUIPMENT

## IGNITION SYSTEM (2-STROKE)

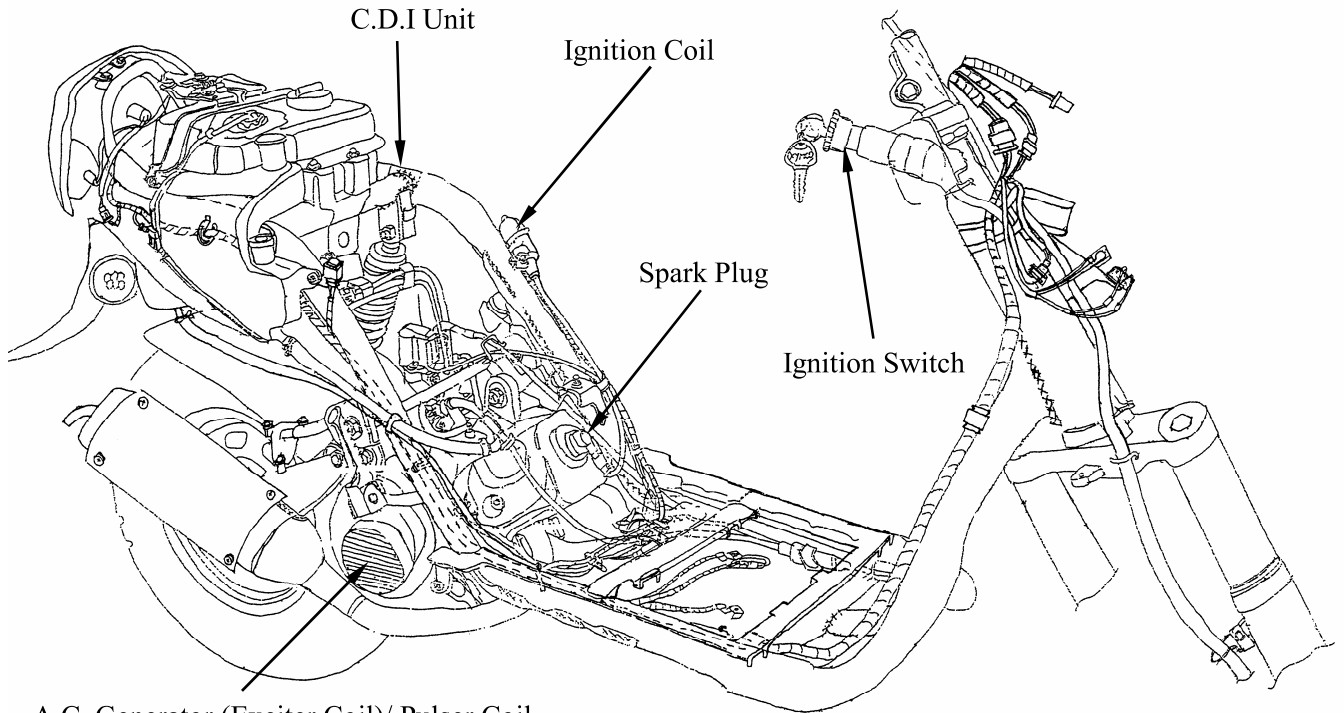

A.C. Generator (Exciter Coil)/ Pulser Coil

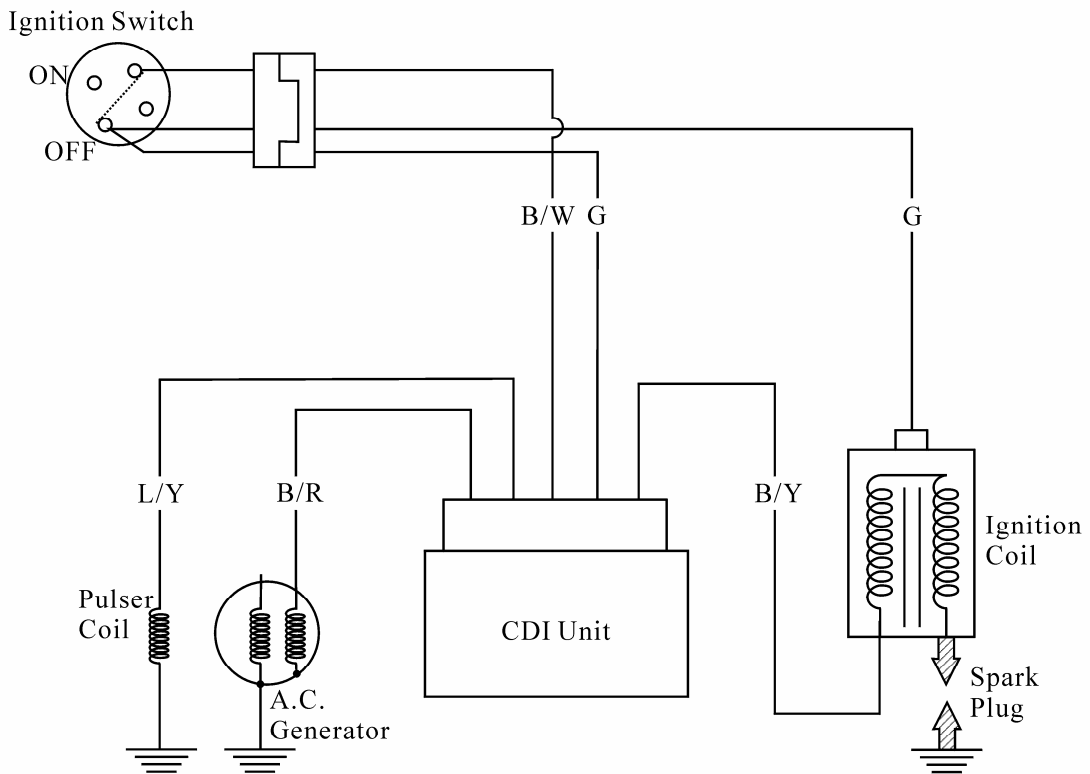

# 16. ELECTRICAL EQUIPMENT

## IGNITION SYSTEM (4-STROKE)

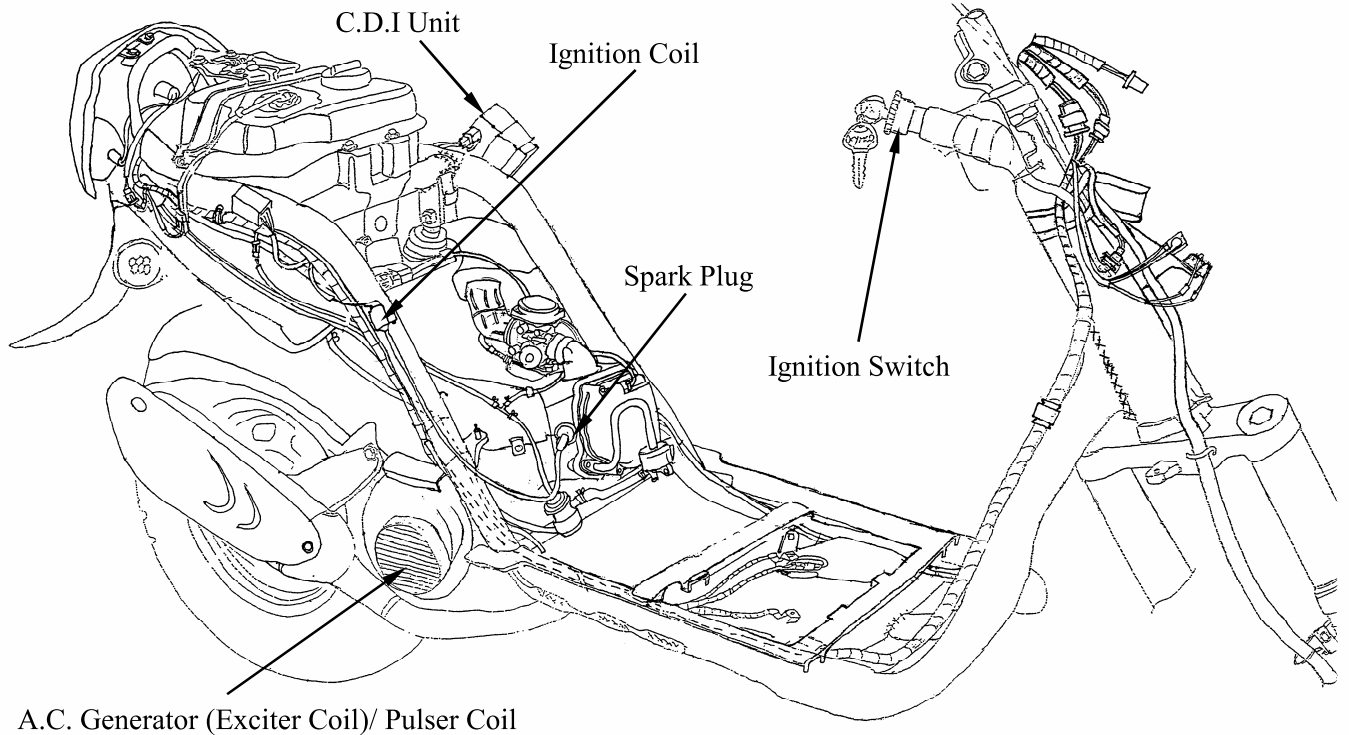

A.C. Generator (Exciter Coil)/ Pulser Coil

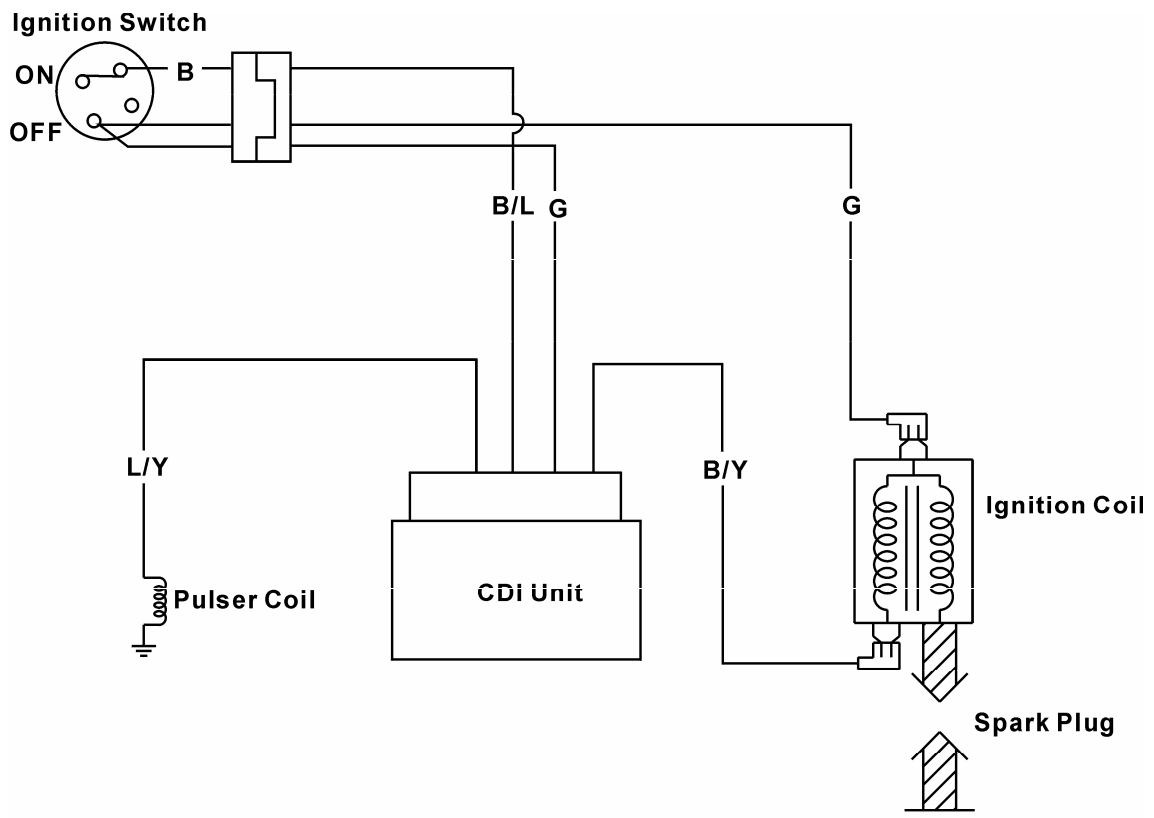

# 16. ELECTRICAL EQUIPMENT

## IGNITION COIL INSPECTION

### Continuity Test

□ This test is to inspect the continuity of ignition coil.

Remove the met-in box and center cover.  
(⇒13-5)

Measure the resistance between the ignition coil primary coil terminals.

**Resistance (20□):**

2-Stroke: 0.153□0.187Ω

4-Stroke: 0.5Ω

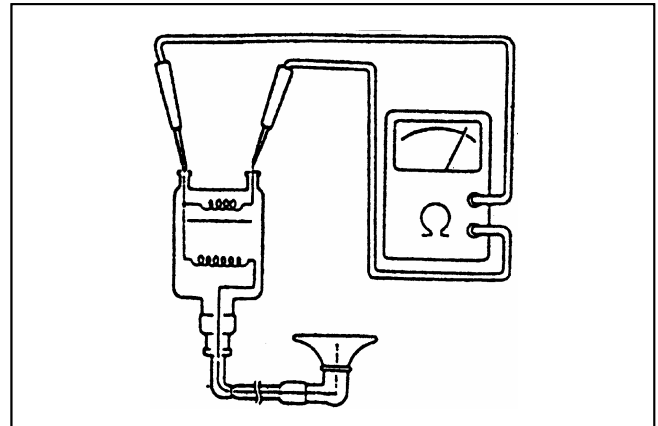

Measure the secondary coil resistance between the spark plug cap and the primary coil terminal as Figure A shown.

**Resistance (20□) (with plug cap):**

2-Stroke: 6.99K□10.21KΩ

4-Stroke: 8.12KΩ

Measure the secondary coil resistance between the ignition coil terminal and the primary coil terminal as Figure B shown.

**Resistance (20□) (without plug cap):**

2-Stroke: 3.24K□3.96KΩ

4-Stroke: 3KΩ

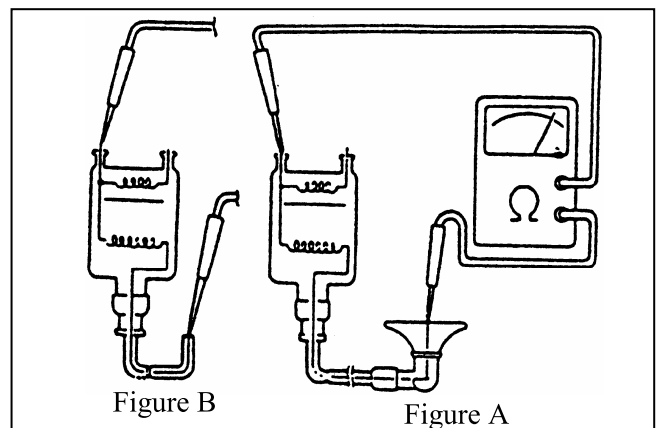

### Performance Test

Remove the ignition coil.



Ignition Coil

# 16. ELECTRICAL EQUIPMENT

Inspect the ignition coil with an ignition coil tester.

Follow the ignition coil tester manufacturer's instructions.

1. Turn the changeover switch to 12V and connect the ignition coil to the tester.
2. Turn the power switch ON and check the spark from the watch window.

Good : Normal and continuous spark

Faulty : Weak or intermittent spark

The test is performed at both conditions that the ignition coil is cold and hot.

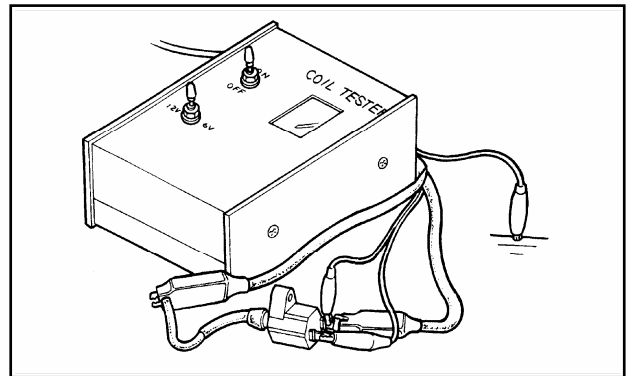

## A.C. GENERATOR

### Exciter Coil/Pulser Coil Inspection

This test is performed with the stator installed in the engine.

Remove the met-in box and center cover. (⇒13-5)

Disconnect the A.C. generator wire connector.  
Measure the pulser coil resistance between the blue/yellow wire and ground.

**Resistance (20□):**

2-Stroke: 80□160Ω

**Resistance (20□):**

4-Stroke: 118.1□118.2Ω

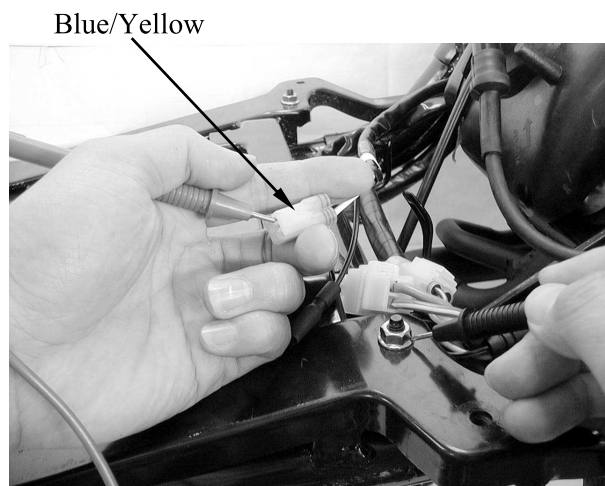

# 16. ELECTRICAL EQUIPMENT

## CDI UNIT INSPECTION

Remove the met-in box. (⇒13-5)

Disconnect the CDI coupler and remove the CDI unit.



CDI Unit

## CDI CIRCUIT INSPECTION

Measure the resistance between the terminals.

Replace the CDI unit if the readings are not within the specifications in the table below.

- Due to the semiconductor in circuit, it is necessary to use a specified tester for accurate testing. Use of an improper tester in an improper range may give false readings.
- Use a Sanwa Electric Tester or Kowa Electric Tester (TH-5H).
- In this table, “Needle swings then returns” indicates that there is a charging current applied to a condenser. The needle will then remain at “∞” unless the condenser is discharged.

Use the x KΩ range for the Sanwa Tester.

Use the x 100Ω range for the Kowa Tester.

**(2-Stroke)**

Unit:

KΩ

Probe⊕ (-)Probe	Black/ Yellow	Black/ Red	Black/ White	Blue/ Yellow	Green
Black/ Yellow		∞	∞	∞	∞
Black/ Red	∞		1-10	∞	∞
Black/ White	∞	∞		∞	∞
Blue/ Yellow	∞	3-40	80-120		10-30
Green	∞	2-10	10-30	∞	

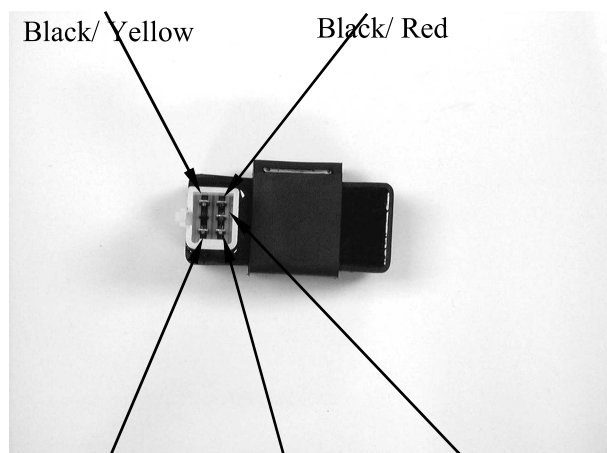

Blue/ Yellow

Green

Black/ White

# 16. ELECTRICAL EQUIPMENT

**(4-Stroke)**  
Ω

Unit:

Probe⊕ (-)Probe	Black/ Blue	Black/ Yellow	Blue/ Yellow	Green
Black/ Blue		∞	∞	∞
Black/ Yellow	9.2M-9.25 M		310K-320 K	310K-320 K
Blue/ Yellow	8.81M-8.8 5M	310K-320 K		1K
Green	8.86M-8.8 8M	310K-320 K	1K	

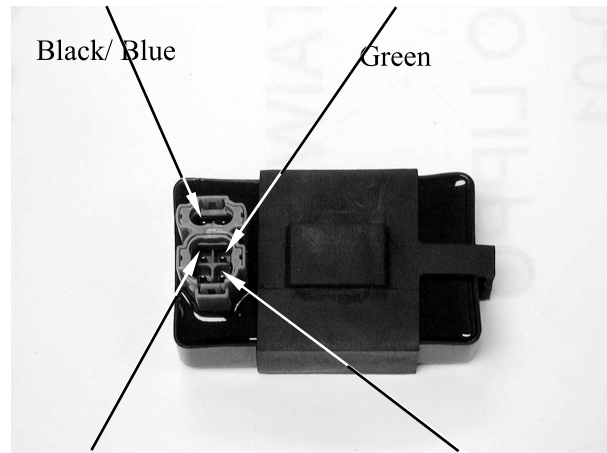

Black/ Yellow

Blue/ Yellow



# 16. ELECTRICAL EQUIPMENT

## ELECTRIC STARTER

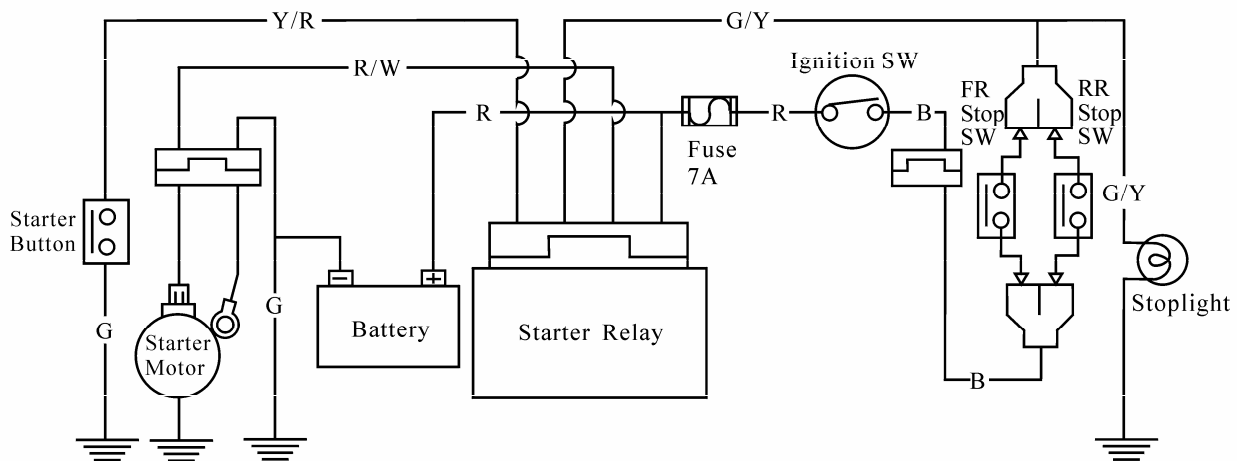
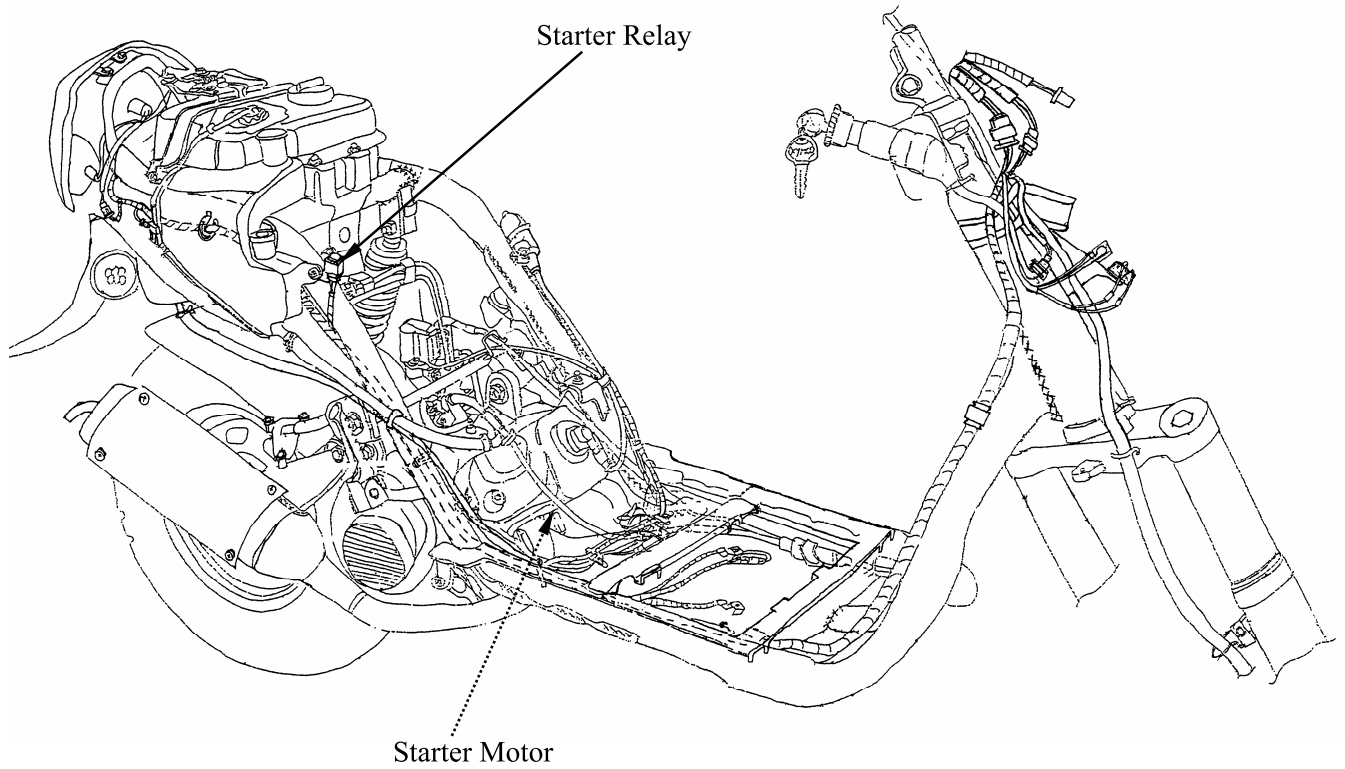

# 16. ELECTRICAL EQUIPMENT

## STARTER RELAY INSPECTION

Remove the met-in box. (⇒13-5)

Disconnect the starter relay coupler and then remove the starter relay.



Connect the starter relay green/yellow terminal to the 12V battery positive (+) terminal and the relay yellow/red terminal to the battery negative (-) terminal. Check for continuity between the starter relay red and red/white terminals. The relay is normal if there is continuity.

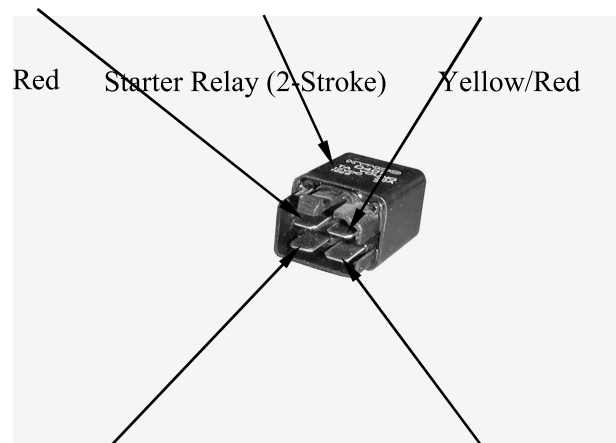

Red/White

Green/Yellow

Starter Relay (4-Stroke)

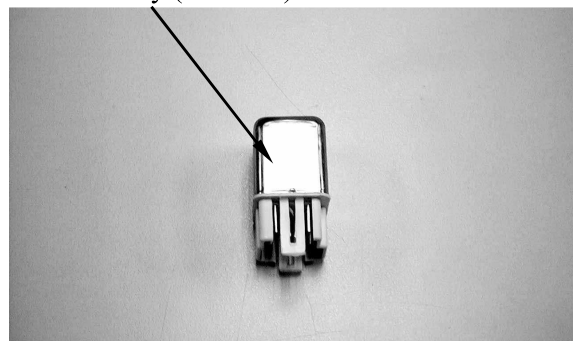

# 16. ELECTRICAL EQUIPMENT

## STARTER MOTOR REMOVAL

Disconnect the starter motor cable.  
Remove the two bolts attaching the starter motor and remove the starter motor.

The installation sequence is the reverse of removal.

Connect the starter motor cable connector  
Check the O-ring for wear or damage and replace it if necessary.

Apply grease to the O-ring and install the starter motor.

Tighten the two mounting bolts.

**Torque:** 0.8□1.2kgf-m

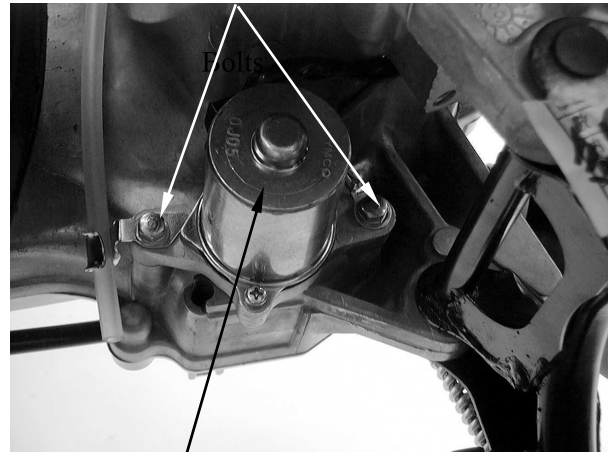

Starter Motor

□ The starter motor cable connector must be installed properly.

## STARTER MOTOR INSPECTION

Connect a battery across the starter motor and check for its operation.

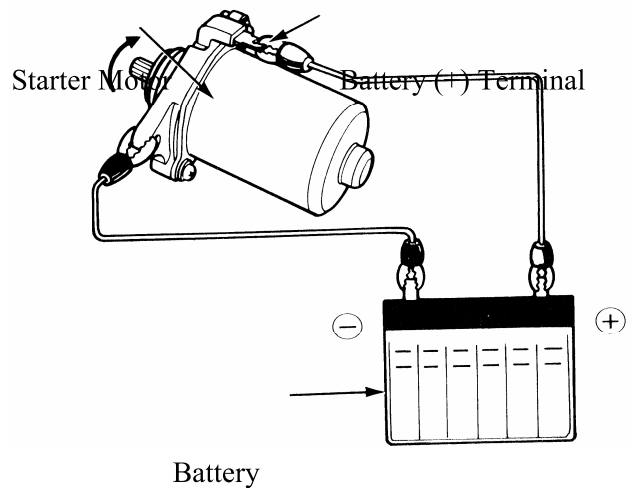

## 16. ELECTRICAL EQUIPMENT

### STARTER PINION

#### REMOVAL

Remove the left crankcase cover.  
Remove the drive pulley.  
(Refer to chapter 9)

Remove the starter pinion cover (2-stroke).  
Remove the starter pinion.

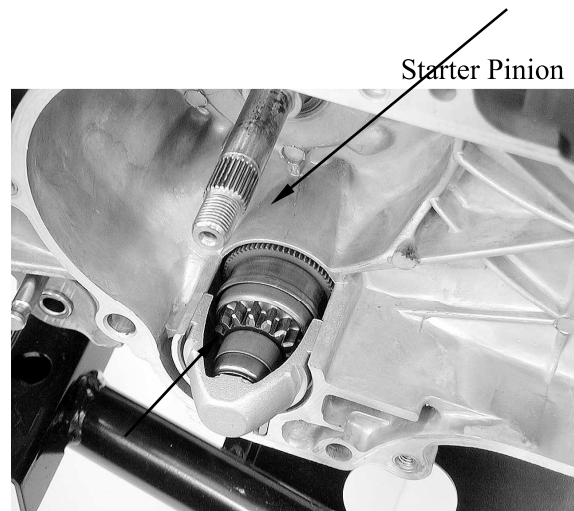

Starter Pinion Cover (2-Stroke)

#### INSPECTION

Inspect the starter pinion seat for wear.  
Inspect the starter pinion for smooth operation.  
Inspect the starter pinion shaft forcing parts for wear and damage.

#### INSTALLATION

Apply a small amount of grease to the starter pinion teeth.  
Install the starter pinion in the reverse order of removal.

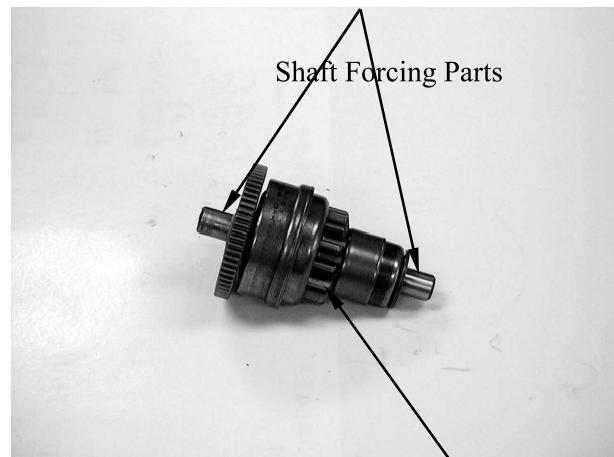

Starter Pinion

## **16. ELECTRICAL EQUIPMENT**

---

**17. INSTRUMENT/SWITCHES/LIGHTS**

---

---

**INSTRUMENT/SWITCHES/LIGHTS**

---

SERVICE INFORMATION .....	17-1
TROUBLESHOOTING .....	17-1
FUEL UNIT.....	17-2
OIL METER .....	17-3
SWITCHES .....	17-4
BULB REPLACEMENT .....	17-7
INSTRUMENT/HEADLIGHT .....	17-8

# 17. INSTRUMENT/SWITCHES/LIGHTS

---

## SERVICE INFORMATION

### GENERAL INSTRUCTIONS

- Wires should be connected to other wires of the same color. Connector must be connected to other couplers of the same color.
- All plastic plugs have locking tabs that must be released before disconnecting, and must be aligned when reconnecting.
- After installation of each switch, a continuity check must be performed.

## TROUBLESHOOTING

### Lights do not come on when ignition switch is "ON"

- Burned bulb
- Faulty switch
- Broken or shorted wire
- Fuse burned out
- Weak battery
- Poorly connected wire
- Faulty winker

### Light dims

- Faulty ignition coil
- Wire or switch resistance too high
- Faulty regulator/rectifier

### Headlight does not change when dimmer switch is turn to Hi or Lo

- Faulty or burned bulb
- Faulty dimmer switch

### Motor oil indicator light does not come on (when motor oil is insufficient)

- Fuse burned out
- Dead battery
- Faulty ignition switch
- Faulty instrument
- Faulty oil meter

### Motor oil indicator light winks

- Loose wire connection
- Broken wire
- Faulty oil meter

### Fuel gauge pointer does not register correctly

- Disconnected wire or connector
- Broken wire
- Faulty float
- Faulty fuel unit
- Faulty instrument

### Fuel gauge pointer fluctuates or swings

- Loose wire connection
- Faulty fuel unit
- Faulty instrument

# 17. INSTRUMENT/SWITCHES/LIGHTS

## FUEL UNIT

**No Smoking!**

### REMOVAL

Remove the met-in box. (⇒13-5)

Disconnect the fuel unit wire connectors.  
Remove the three bolts attaching from the fuel unit retainer .

Do not damage the fuel unit wire.

Remove the fuel unit.

Be careful not to bend or damage the fuel unit float arm.

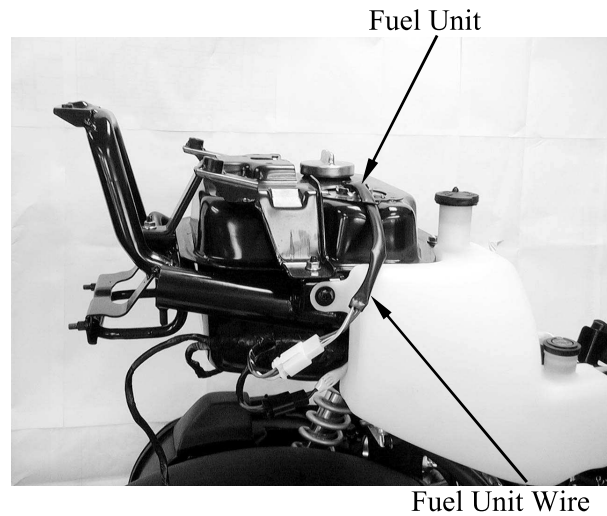

### INSPECTION

Remove the fuel unit.  
Measure the resistance between the fuel unit wire terminals with the float at upper and lower positions.

Wire Terminals	Upper	Lower
G□Y/W	36Ω	686Ω
G□L/W	566Ω	53Ω
Y/W□L/W	600Ω	600Ω

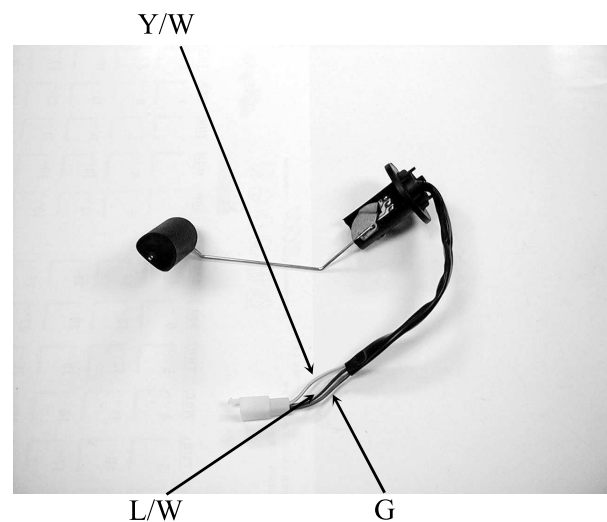

### FUEL GAUGE INSPECTION

Connect the fuel unit wire connectors and turn the ignition switch “ON”.

Before performing the following test, operate the turn signals to determine that the battery circuit is normal.

Check the fuel gauge needle for correct indication by moving the fuel unit float up and down.

Float Position	Needle Position
Upper	“F” (Full)
Lower	“E” (Empty)

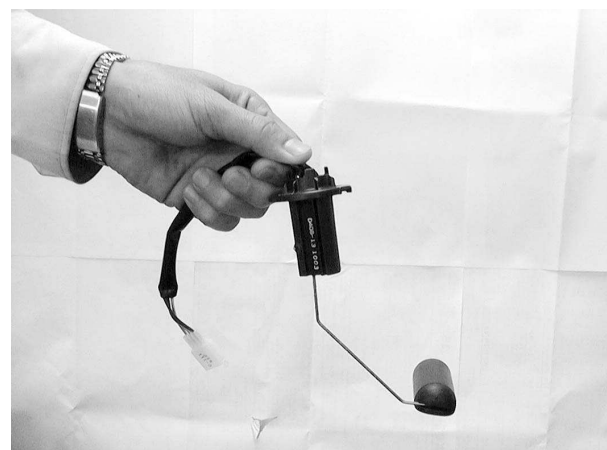



# 17. INSTRUMENT/SWITCHES/LIGHTS

## INSTALLATION

The installation sequence is the reverse of removal.

- Align the groove on the fuel unit with the flange on the fuel tank.

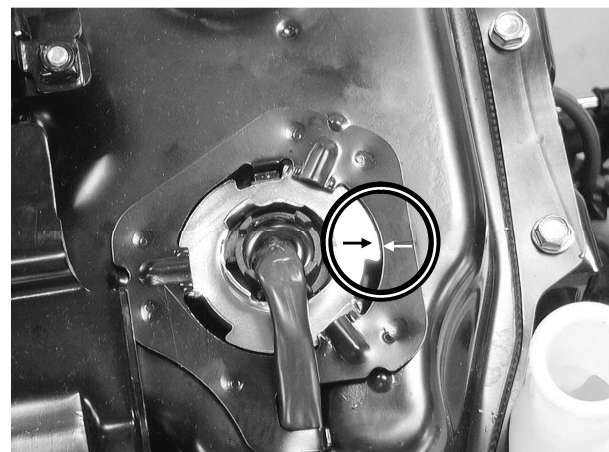
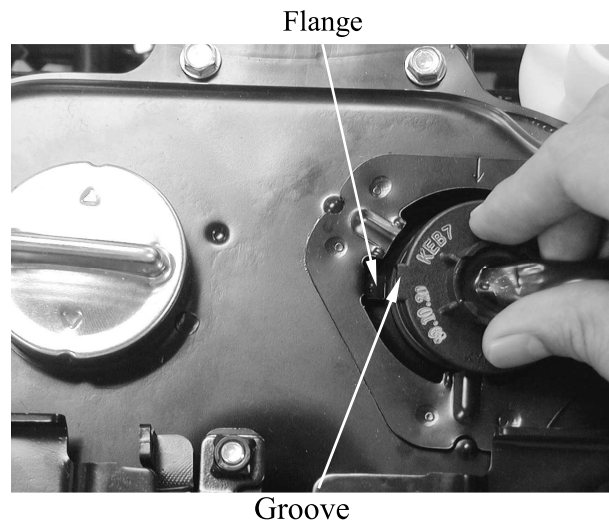

## OIL METER (2-STROKE)

### INSPECTION

Remove the rear body cover. (⇒13-6)

Disconnect the oil meter wire connectors and remove the oil meter. Keep the oil meter float at the lower position. Measure the resistances between the wire terminals as ① and ② shown in the left figure.

Wire Terminals	Resistance
Green/Red(+)-Black(-)	46Ω
Green(-)-Black(+)	∞

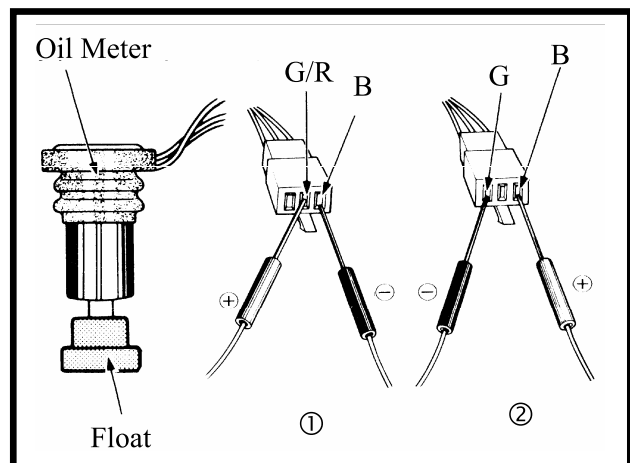

- Before removing the oil meter, be sure to drain the motor oil and do not allow sparks or flames near the working area.

# 17. INSTRUMENT/SWITCHES/LIGHTS

## Oil Meter Operation Inspection

Connect the oil meter wire connectors and turn the ignition switch ON.  
Measure the resistance between the wire terminals with the float at upper position.

Green/Red(+) <input type="checkbox"/> Black(-)	About 340Ω
--	------------

Before performing the following test, operate the turn signals to determine that the battery circuit is normal.

Move the oil meter float up and down to see if the oil indicator light will go out and come on.

If the oil indicator light does not light, check for burned bulb, loose wire or connector. After correction, check again according to the method mentioned above.

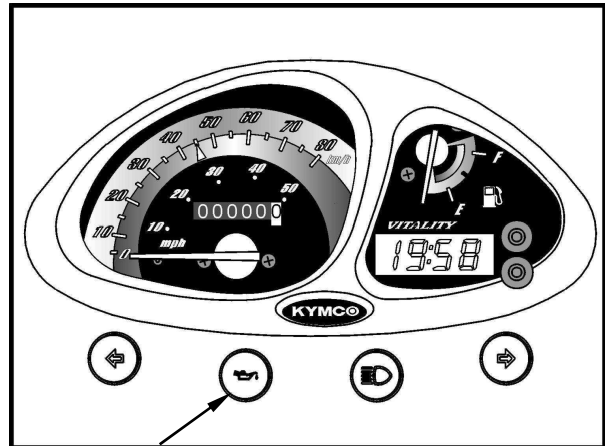

Oil Indicator Light

## SWITCHES

### IGNITION SWITCH INSPECTION

Remove the front cover. (⇒13-4)

Disconnect the ignition switch wire couplers and check for continuity between the wire terminals.

Color	Red	Black/White	Green	Black
Symbol	BAT <sub>1</sub>	IG	E	BAT <sub>2</sub>
LOCK		○ — ○	○	
OFF		○ — ○	○	
ON	○ —			— ○

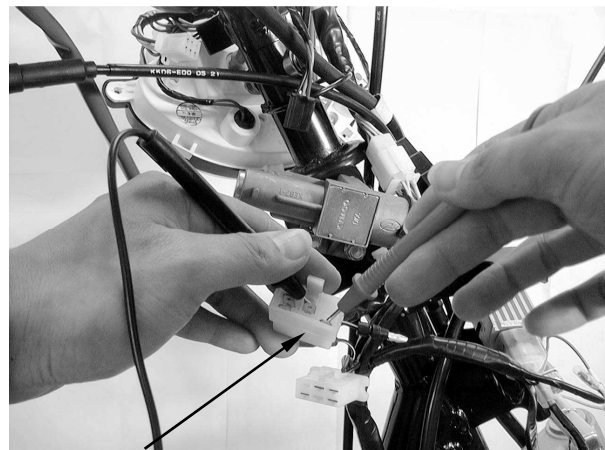

Ignition Switch Connector

### STOP SWITCH INSPECTION

Remove the handlebar front cover. (⇒13-2)

Disconnect the front and rear stop switch wire couplers.  
Check for continuity between the wire terminals when the front/rear brake lever is applied.

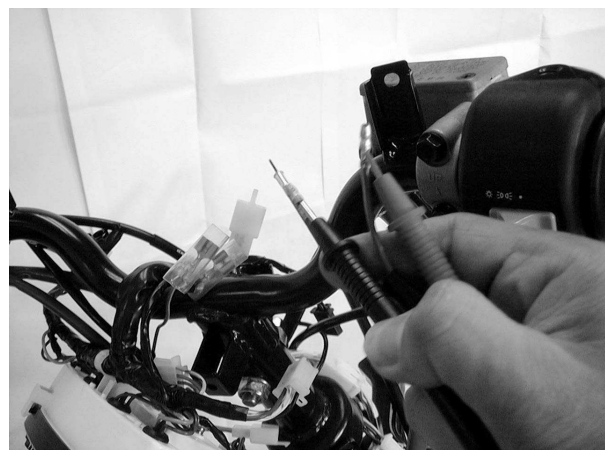

# 17. INSTRUMENT/SWITCHES/LIGHTS

## HEADLIGHT SWITCH INSPECTION

Remove the handlebar front cover. (⇒13-2)

Disconnect the headlight switch wire coupler and check for continuity between wire terminals.

Color	Yellow	Pink	Brown	Blue/White	Brown/white
Symbol	CI	RE	TL	HL	PO
OFF	○ — ○				
N	○ —	— ○			
P	○ —		— ○	— ○	— ○
N	○ —		— ○	— ○	
H	○ —		— ○	— ○	

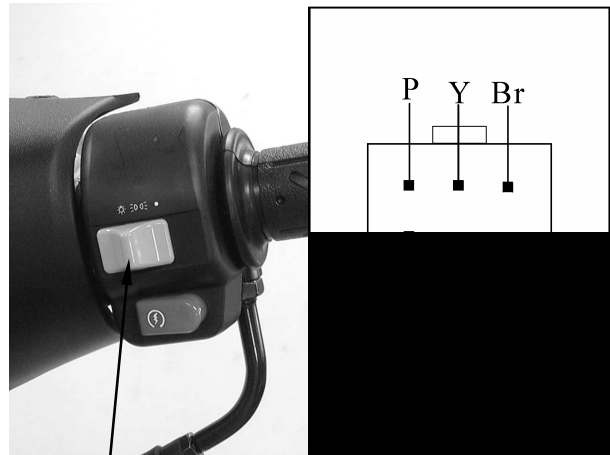

Headlight Switch

## DIMMER/PASSING SWITCH INSPECTION

Check for continuity between wire terminals.

Color	Blue/White	Blue	White	Black
Symbol	HL	HI	LO	BAT
HI	○ —	— ○		
LO	○ —		— ○	
PASSING	○ —	— ○	— ○	— ○

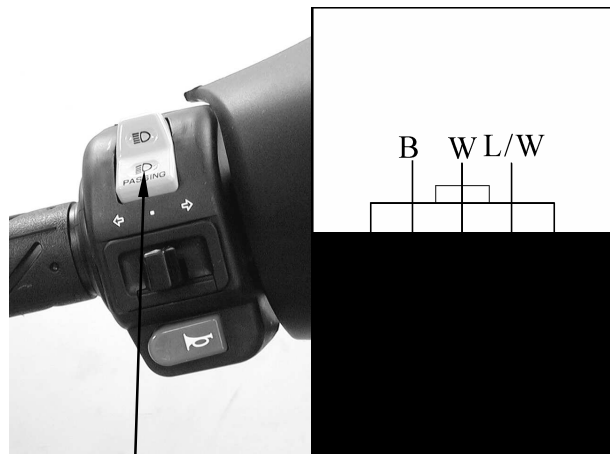

Dimmer Switch

## TURN SIGNAL SWITCH INSPECTION

Check for continuity between the wire terminals.

Color	Light Blue	Orange	Gray
Symbol	R	L	WR
R	○ —	—	— ○
L		○ —	— ○

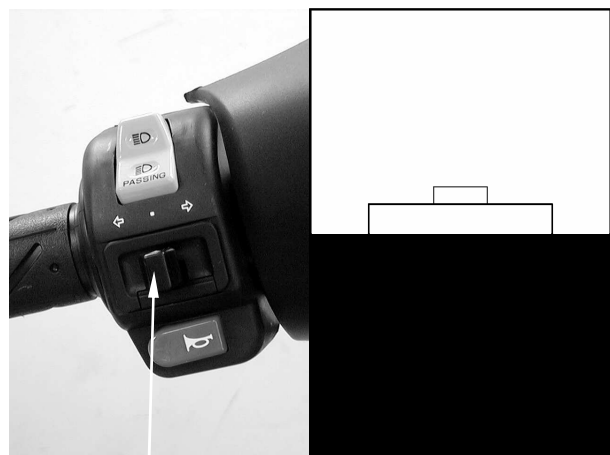

Turn Signal Switch

# 17. INSTRUMENT/SWITCHES/LIGHTS

## STARTER SWITCH INSPECTION

Check for continuity between wire terminals.  
Push the starter button when measuring.

Color	Yellow/Red	Green
Symbol	ST	E
FREE		
PUSH	○ ———	——— ○

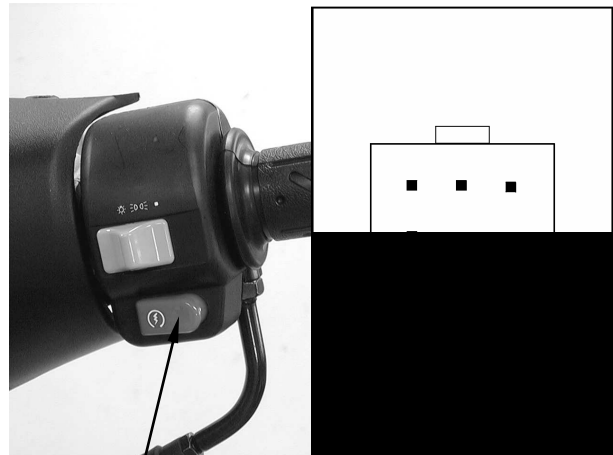

Starter Switch

## HORN SWITCH INSPECTION

Check for continuity between wire terminals.  
Push the horn button when measuring.

Color	Light Green	Brown / Blue
Symbol	HO	BAT
FREE		
PUSH	○ ———	——— ○

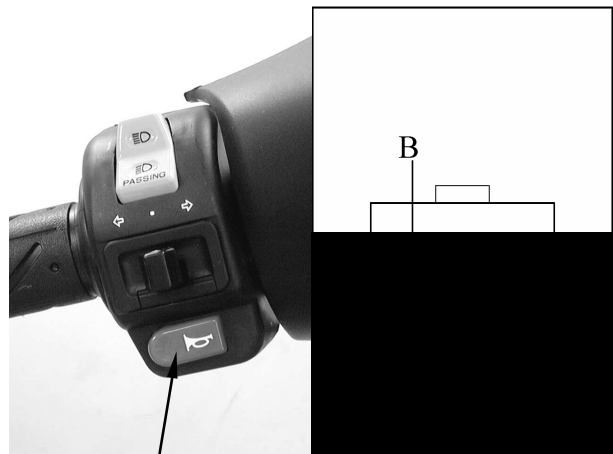

Horn Switch

## HORN INSPECTION

Remove the frame front cover. (⇒13-4)

Disconnect the horn wire couplers. The horn is normal if it sounds when a 12V battery is connected across the horn wire terminals.

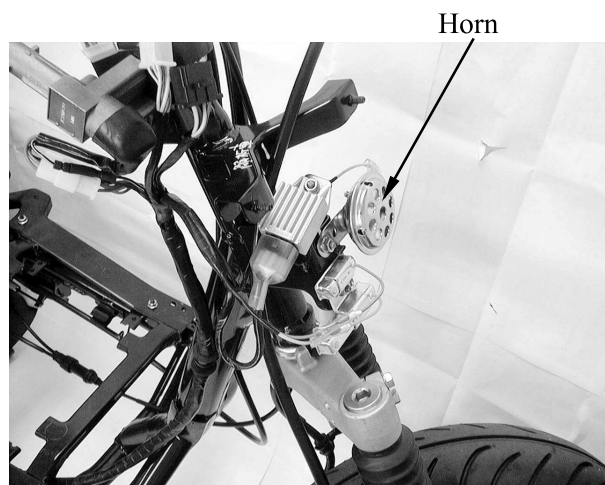

# 17. INSTRUMENT/SWITCHES/LIGHTS

## BULB REPLACEMENT FRONT TURN SIGNAL LIGHT REPLACEMENT

Remove two screws from the turn signal light lens.  
Slightly press down on the bulb and turn it counterclockwise.

Install a new bulb in the reverse order of removal.

- Replace with new bulbs of the same specifications.

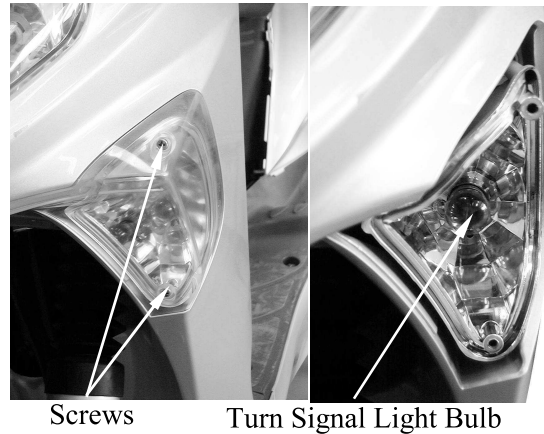

## TAILLIGHT/STOPLIGHT REPLACEMENT

Taillight lens Removal:  
Remove two screws from the taillight lens.  
Slightly press down on the bulb and turn it counterclockwise.

Install a new bulb in the reverse order of removal.

- Replace with new bulbs of the same specifications.

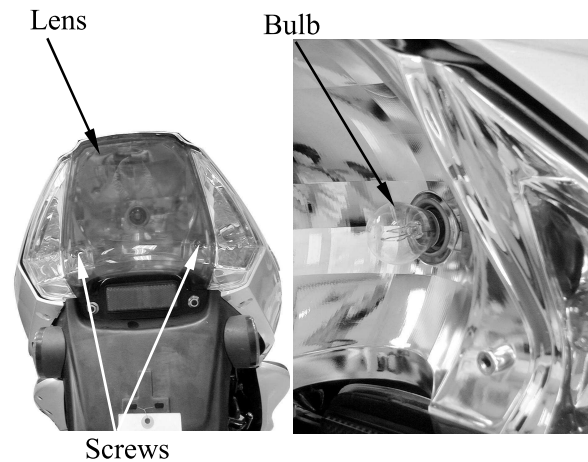

## REAR TURN SIGNAL LIGHT BULB REPLACEMENT

Remove two screws from the taillight lens.  
(⇒ 17-7)

Remove screw from the rear turn signal light lens.  
Slightly press down on the bulb and turn it counterclockwise.

Install a new bulb in the reverse order of removal.

- Replace with new bulbs of the same specifications.

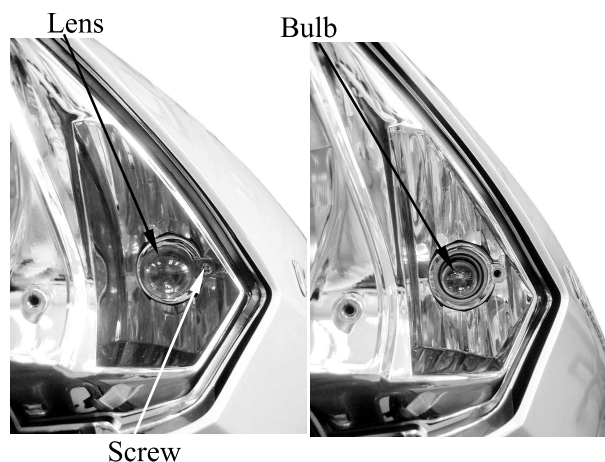

# 17. INSTRUMENT/SWITCHES/LIGHTS

## INSTRUMENT/HEADLIGHT

### Instrument Bulbs Replacement

Remove the handlebar rear cover. (⇒13-3)

Remove the front body cover. (⇒13-9)

Remove the bulbs and replace with new ones.

Bulb Sockets

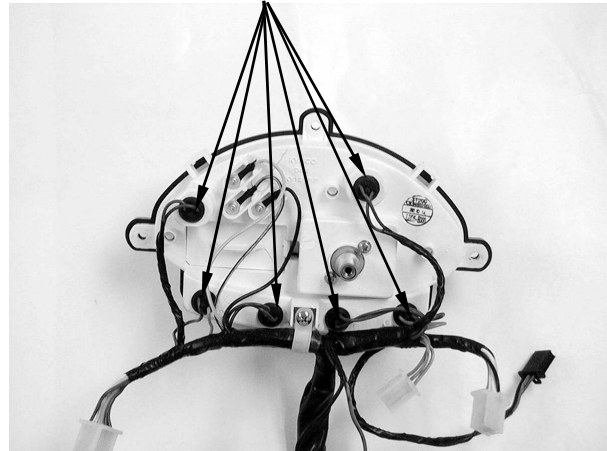

### INSTRUMENT REMOVAL

Remove the handlebar rear cover. (⇒13-3)

Disconnect the speedometer cable.

Disconnect the all instrument connectors.

Remove the instrument.

Installation is in the reverse order of removal.

Instrument

Instrument Connectors

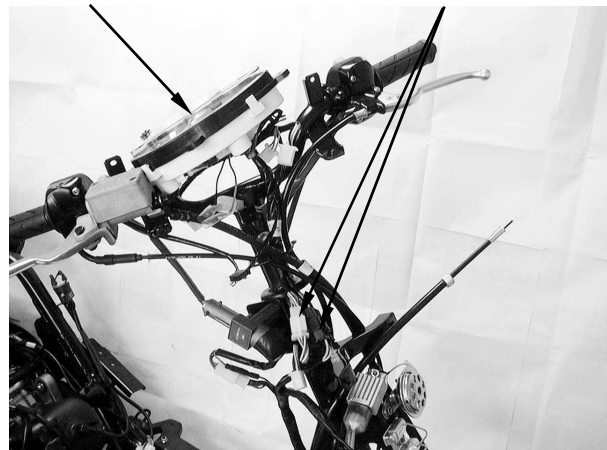

### POSITION LIGHT BULB REPLACEMENT

Remove the front body cover. (⇒13-9)

Turn the bulb socket counterclockwise, then pull it toward you.

Pull the bulb out of the socket and replace it with a new one.

Make sure the seal rubber is installed in the correct position and is in good condition.

Installation is in the reverse order of removal.

Socket

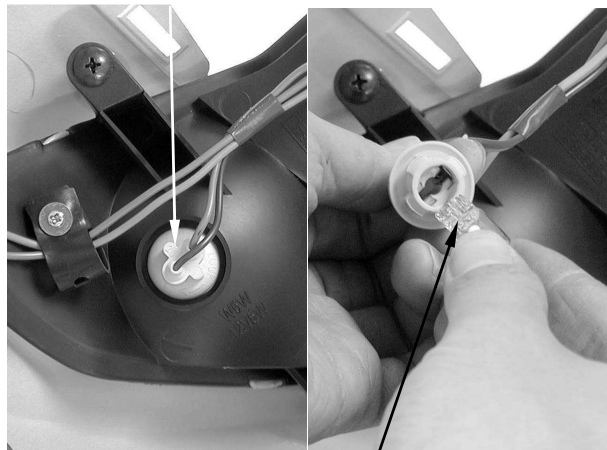

Bulb

# 17. INSTRUMENT/SWITCHES/LIGHTS

## HEADLIGHT BULB REPLACEMENT

Remove the front body cover. (⇒13-6)

Pull off the socket without turning.  
Remove the dust cover.

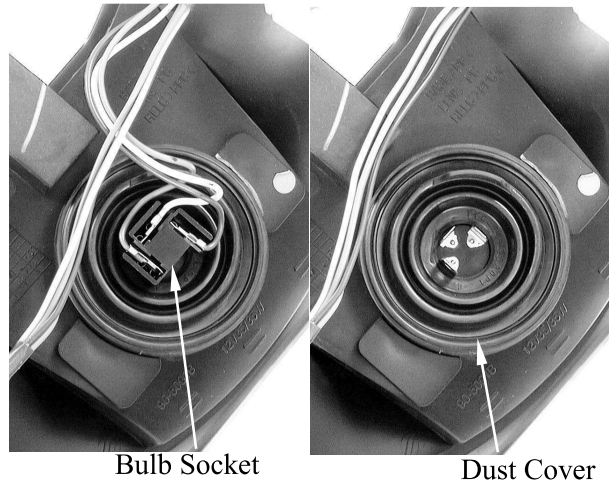

Remove the bulb while pressing down on the pin.  
Pull out the bulb without turning.

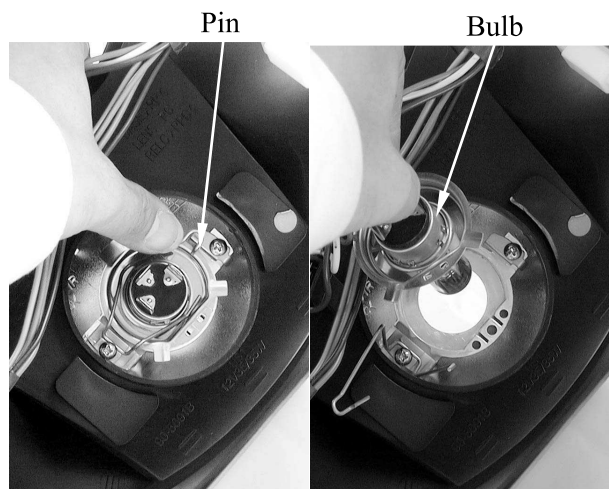

Install a new bulb in the reverse order of removal.

- ☐
- When installing the bulb, make sure its biggest flange upward.
  - The model adopts krypton gas bulb. When installing, do not directly touch the bulb glass with fingers.
  - Use bulbs of the same specifications for replacement.



## 18. KCAS (FOR EURO 2)

### KYMCO Clean Air System (For EURO 2)

The KYMCO Clean Air System is a secondary air suction system that helps the exhaust gases to burn more completely. When the spent fuel charge is released into the exhaust system, it is still hot enough to burn. The system allows extra air into the exhaust system so that the spent fuel charge can continue to burn. This continued burning action tends to burn up a great deal of the normally unburned gases, as well as changing a significant portion of the poisonous carbon monoxide into harmless carbon dioxide.

□2-STROKE□

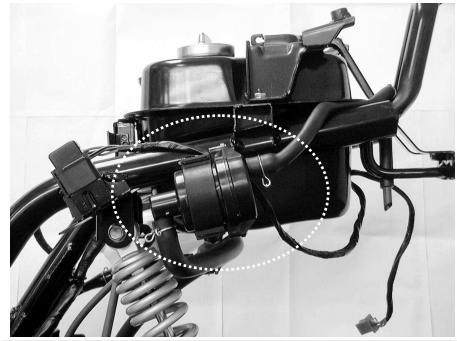

18

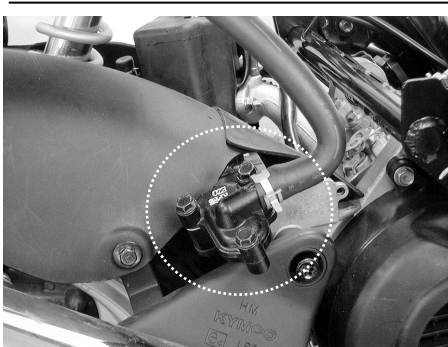
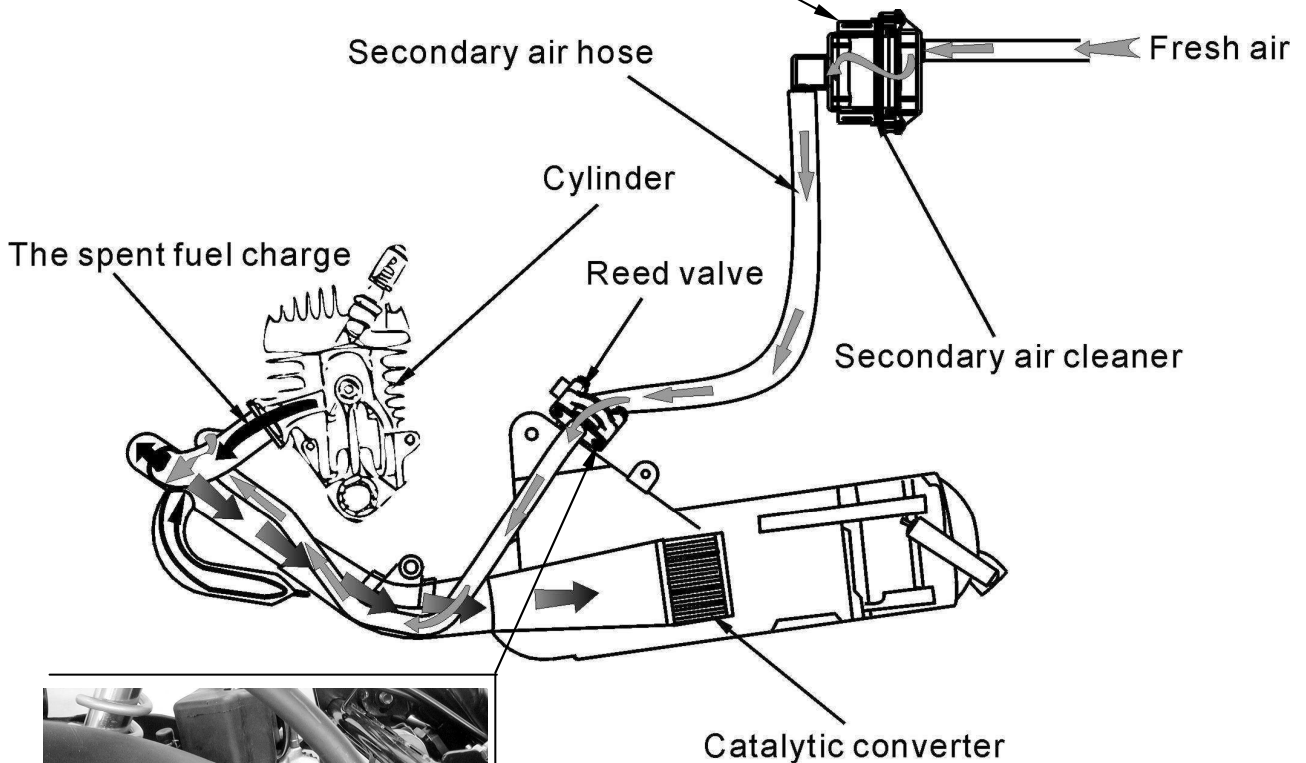



# 18. SPECIFICATIONS

## □4-STROKE□

