

**By KWANG YANG Motor Co., Ltd.
First Edition, Jan 2007
All rights reserved. Any reproduction or
unauthorized use without the written permission of
KWANG YANG Motor Co., Ltd.
is expressly prohibited.
T100SH4025**

PREFACE

This Service Manual describes the technical features and servicing procedures for the KYMCO *DINK 200i/125*.

Section 1 contains the precautions for all operations stated in this manual. Read them carefully before any operation is started.

Section 2 is the removal/installation procedures for the frame covers which are subject to higher removal/installation frequency during maintenance and servicing operations.

Section 3 describes the inspection/adjustment procedures, safety rules and service information for each part, starting from periodic maintenance.

Sections 6 through 14 give instructions for disassembly, assembly and adjustment of engine parts. Section 15 through 16 is the removal/ installation of chassis. Section 17 through 21 states the testing and measuring methods of electrical equipment.

Most sections start with an assembly or system illustration and troubleshooting for the section. The subsequent pages give detailed procedures for the section.

The information and contents included in this manual may be different from the vehicle in case specifications are changed. KYMCO reserves the right to make changes at any time without notice and without incurring any obligation.

KWANG YANG MOTOR CO., LTD.
OVERSEAS SALES DEPARTMENT
OVERSEAS SERVICE SECTION

TABLE OF CONTENTS

ENGINE	GENERAL INFORMATION	1
	EXHAUST MUFFLER/FRAME COVERS	2
	INSPECTION/ADJUSTMENT	3
	LUBRICATION SYSTEM	4
	ENGINE REMOVAL/INSTALLATION	5
	CYLINDER HEAD/VALVES	6
	CYLINDER/PISTON	7
	DRIVE AND DRIVEN PULLEYS/KICK STARTER	8
	FINAL REDUCTION	9
	A.C. GENERATOR/STARTER CLUTCH	10
	CRANKCASE/CRANKSHAFT	11
	COOLING SYSTEM	12
	DINK 125: FUEL SYSTEM/CARBURETOR/FUEL PUMP FUEL TANK	13
	DINK 200i: FUEL SYSTEM (Auto Control Fuel Injection System)	14
CHASSIS	HANDLEBAR/FRONT WHEEL/FRONT BRAKE/FRONT SHOCK ABSORBER/STEERING STEM	15
	REAR BRAKE/REAR FORK/REAR WHEEL/REAR SHOCK ABSORBER	16
ELECTRICAL EQUIPMENT	BATTERY/CHARGING SYSTEM	17
	IGNITION SYSTEM	18
	STARTING SYSTEM	19
	LIGHTS/METERS/SWITCHES	20
	WIRING DIAGRAMS	21

1. GENERAL INFORMATION



GENERAL INFORMATION

SERIAL NUMBER-----	1 - 1
SPECIFICATION (DINK 200i) -----	1 - 2
SPECIFICATION (DINK 125) -----	1 - 3
SERVICE PRECAUTIONS -----	1 - 4
TORQUE VALUES -----	1 - 8
SPECIAL TOOLS -----	1-11
LUBRICATION POINTS -----	1-13
CABLE & HARNESS ROUTING-----	1-15
TROUBLESHOOTING (DINK 200i) -----	1-31
TROUBLESHOOTING (DINK 125) -----	1-42

1. GENERAL INFORMATION

SERIAL NUMBER



(1) Location of Frame Serial Number

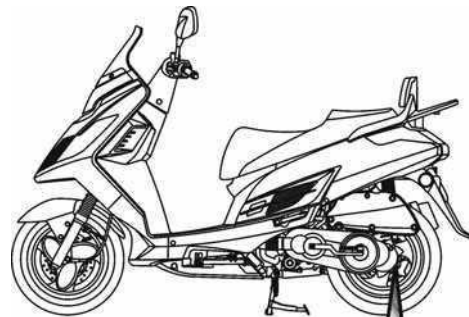
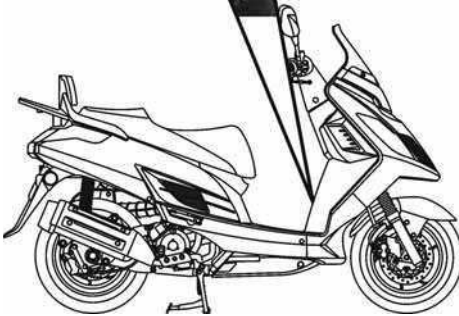

Location of Engine Serial Number

1. GENERAL INFORMATION

DINK 200i/125

SPECIFICATIONS (DINK 200i)

Overall length		2030 mm (81.2 in)	
Overall width		780 mm (31.2 in)	
Overall height		1255 mm (50.2 in)	
Wheel base		1390 mm (55.6 in)	
Engine type		Water cooled 4-stroke, OHC engine	
Displacement		174.5 cc (10.48 cu-in)	
Fuel Used		92# nonleaded gasoline	
Dry weight	Front wheel	58 kg (127.6 lb)	
	Rear wheel	82 kg (180.4 lb)	
	Total	140 (308 lb)	
Curb weight	Front wheel	65 kg (143 lb)	
	Rear wheel	89 kg (195.8 lb)	
	Total	154 kg (338.8 lb)	
Tire	Front wheel	120/70-13	
	Rear wheel	140/70-12	
Ground clearance		140 mm (308 in)	
Min. turning radius		2350 mm (94 in)	
ENGINE	Starting system		Starting motor
	Type		Gasoline, 4-stroke
	Cylinder arrangement		Single cylinder
	Combustion chamber type		Semi-sphere
	Valve arrangement		O.H.C.
	Bore x stroke		62×57.8 mm (2.48×2.312 in)
	Compression ratio		11.2:1
	Compression pressure		16 kgf/cm ² (1600 kPa, 227.2 psi)
	Intake	Open	12° (BTDC)
		Close	35° (ABDC)
	Exhaust	Open	28° (BBDC)
		Close	8° (ATDC)
	Valve clearance (cold)	Intake	0.1 mm (0.004 in)
		Exhaust	0.1 mm (0.004 in)
	Idle speed (rpm)		1660±100rpm
	Lubrication System	Lubrication type	Forced pressure & Wet sump
		Oil pump type	Inner/outer rotor type
		Oil filter type	Full-flow filtration
		Oil capacity	1.1 L (0.968 lmp qt, 1.166 US qt)
		Oil exchanging capacity	0.9 L (0.792 lmp qt, 0.954 US qt)
Cooling Type		Liquid cooled	

Fuel System	Air cleaner type		Paper element, wet
	Fuel capacity		11 L (2.31 lmp gal, 2.86 US gal)
	Carburetion	Type	Programmed fuel injection
Throttle bore		φ28 mm (φ1.12 in)	
Electrical Equipment	Ignition System	Type	ECU
		Ignition timing	ECU control
		Spark plug	NGK DPR6EA-9
	Spark plug gap	0.9 mm (0.036 in)	
Battery	Capacity	12V10AH	
Power Drive System	Transmission Gear	Clutch type	Dry multi-disc clutch
		Type	Non-stage transmission
		Operation	Automatic centrifugal Type
	Reduction Gear	Type	Two-stage reduction
Reduction ratio		1st	2.7~0.8
		Final	8.48
Moving Device	Tire pressure	Front	1.75 kgf/cm ² (175 kPa, 24.85 psi)
		Rear	2 kgf/cm ² (200 kPa, 28.4 psi)
	Turning angle	Left	42.5°
		Right	42.5°
Brake system type		Front	Disk brake
		Rear	Disk brake
Damping Device	Suspension type	Front	Telescope
		Rear	Double swing
	Shock absorber type	Front	Telescope
		Rear	Double swing
Frame type		Under bone	

1. GENERAL INFORMATION

DINK200i/125

SPECIFICATIONS (DINK 125)

Overall length		2030 mm (81.2 in)		
Overall width		760 mm (30.4 in)		
Overall height		1255 mm (50.2 in)		
Wheel base		1390 mm (55.6 in)		
Engine type		Water cooled 4-stroke, OHC engine		
Displacement		124.6 cc (7.6 cu-in)		
Fuel Used		92# nonleaded gasoline		
Dry weight	Front wheel	53 kg (116.6 lb)		
	Rear wheel	85 kg (187 lb)		
	Total	138 (303.6 lb)		
Curb weight	Front wheel	60 kg (132 lb)		
	Rear wheel	92 kg (202.4 lb)		
	Total	152 kg (334.4 lb)		
Tire	Front wheel	120/70-13		
	Rear wheel	140/70-12		
Ground clearance		140 mm (308 in)		
Min. turning radius		2350 mm (94 in)		
ENGINE	Starting system		Starting motor/Kick starter	
	Type		Gasoline, 4-stroke	
	Cylinder arrangement		Single cylinder	
	Combustion chamber type		Semi-sphere	
	Valve arrangement		O.H.C.	
	Bore x stroke		52.4×57.8 mm (2.096×2.312 in)	
	Compression ratio		10:1	
	Compression pressure		15 kgf/cm ² (1500 kPa, 213 psi)	
	Intake	Open	12° (BTDC)	
		Close	35° (ABDC)	
	Exhaust	Open	28° (BBDC)	
		Close	0° (ATDC)	
	Valve clearance (cold)	Intake	0.1 mm (0.004 in)	
		Exhaust	0.1 mm (0.004 in)	
	Idle speed (rpm)		1700±150rpm	
	Lubrication System	Lubrication type		Forced pressure & Wet sump
		Oil pump type		Inner/outer rotor type
		Oil filter type		Full-flow filtration
		Oil capacity		1.1 L (0.968 lmp qt, 1.166 US qt)
		Oil exchanging capacity		0.9 L (0.792 lmp qt, 0.954 US qt)
Cooling Type		Liquid cooled		

Fuel System	Air cleaner type		Paper element, wet	
	Fuel capacity		11 L (2.31 lmp gal, 2.86 US gal)	
	Carburetor	Type		LEA5
		Piston dia.		φ21.8 mm (φ0.872 in)
Venturi dia.		φ24 mm (φ0.96 in)		
Throttle type		Butterfly type		
Electrical Equipment	Ignition System	Type		CDI
		Ignition timing		10°±1.5°/1000 rpm
		Spark plug		NGK DPR7EA-9
	Spark plug gap		0.9 mm (0.036 in)	
Battery	Capacity		12V8AH	
Power Drive System	Transmission Gear	Clutch type		Dry multi-disc clutch
		Type		Non-stage transmission
		Operation		Automatic centrifugal Type
	Reduction Gear	Type		Two-stage reduction
Reduction ratio		1st	2.8~1	
	Final		8.82	
Moving Device	Tire pressure	Front	1.75 kgf/cm ² (175 kPa, 24.85 psi)	
		Rear	2 kgf/cm ² (200 kPa, 28.4 psi)	
	Turning angle	Left	42.5°	
		Right	42.5°	
Brake system type		Front	Disk brake	
		Rear	Disk brake	
Damping Device	Suspension type		Front	Telescope
			Rear	Double swing
	Shock absorber type		Front	Telescope
			Rear	Double swing
Frame type			Under bone	

1. GENERAL INFORMATION

SERVICE PRECAUTIONS

- Make sure to install new gaskets, O-rings, circlips, cotter pins, etc. when reassembling.

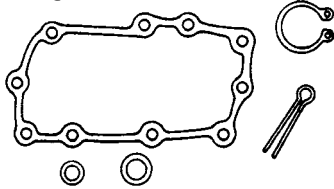

- When tightening bolts or nuts, begin with larger-diameter to smaller ones at several times, and tighten to the specified torque diagonally.

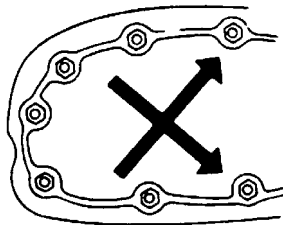

- Use genuine parts and lubricants.

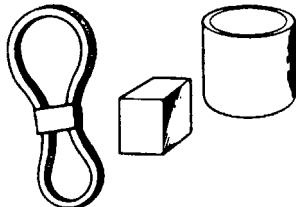

- When servicing the motorcycle, be sure to use special tools for removal and installation.



- After disassembly, clean removed parts. Lubricate sliding surfaces with engine oil before reassembly.



- Apply or add designated greases and lubricants to the specified lubrication points.

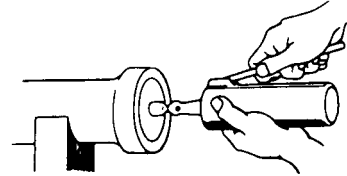

- After reassembly, check all parts for proper tightening and operation.

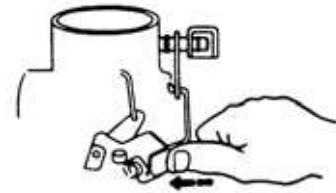

- When two persons work together, pay attention to the mutual working safety.



- Disconnect the battery negative (-) terminal before operation.

- When using a spanner or other tools, make sure not to damage the motorcycle surface.

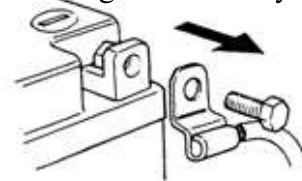

- After operation, check all connecting points, fasteners, and lines for proper connection and installation.

- When connecting the battery, the positive (+) terminal must be connected first.

- After connection, apply grease to the battery terminals.

- Terminal caps shall be installed securely.

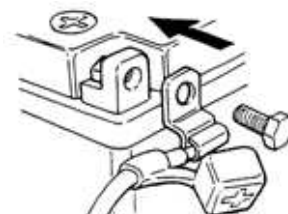

1. GENERAL INFORMATION

- If the fuse is burned out, find the cause and repair it. Replace it with a new one according to the specified capacity.

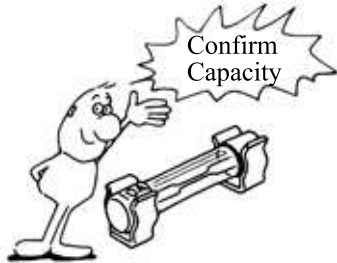

- After operation, terminal caps shall be installed securely.

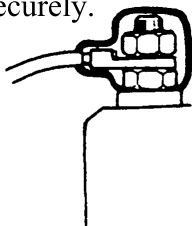

- When taking out the connector, the lock on the connector shall be released before operation.

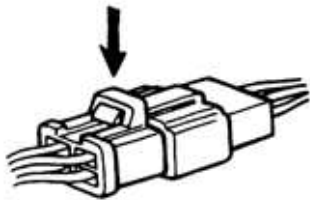

- Hold the connector body when connecting or disconnecting it.
- Do not pull the connector wire.



- Check if any connector terminal is bending, protruding or loose.

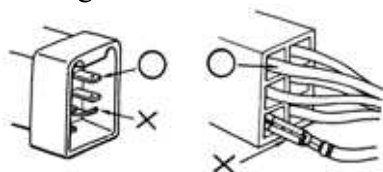

- The connector shall be inserted completely.
- If the double connector has a lock, lock it at the correct position.
- Check if there is any loose wire.

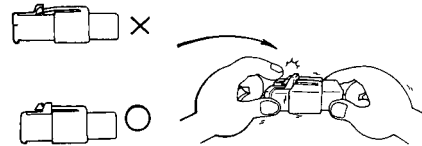

- Before connecting a terminal, check for damaged terminal cover or loose negative terminal.

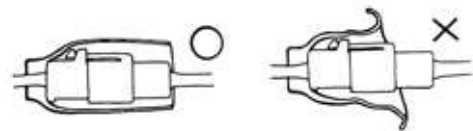

- Check the double connector cover for proper coverage and installation.

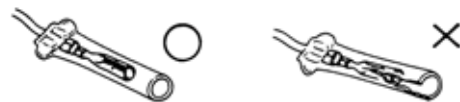

- Insert the terminal completely.
- Check the terminal cover for proper coverage.
- Do not make the terminal cover opening face up.



- Secure wire harnesses to the frame with their respective wire bands at the designated locations. Tighten the bands so that only the insulated surfaces contact the wire harnesses.

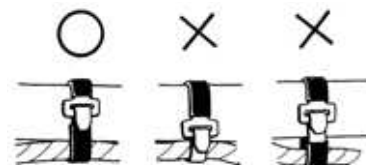

1. GENERAL INFORMATION

- After clamping, check each wire to make sure it is secure.

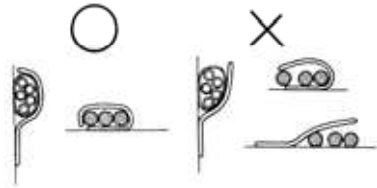

- Do not squeeze wires against the weld or its clamp.



- After clamping, check each harness to make sure that it is not interfering with any moving or sliding parts.

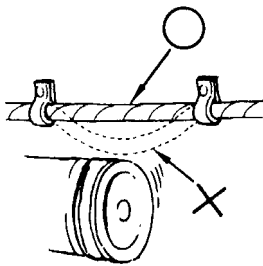

- When fixing the wire harnesses, do not make it contact the parts which will generate high heat.

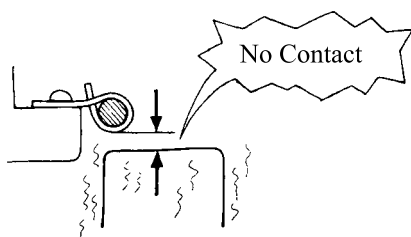

- Route wire harnesses to avoid sharp edges or corners. Avoid the projected ends of bolts and screws.

- Route wire harnesses passing through the side of bolts and screws. Avoid the projected ends of bolts and screws.

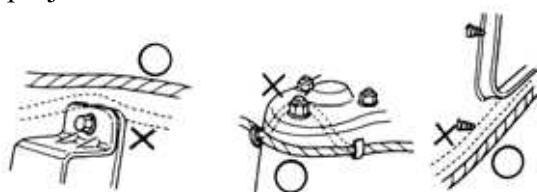

- Route harnesses so they are neither pulled tight nor have excessive slack.

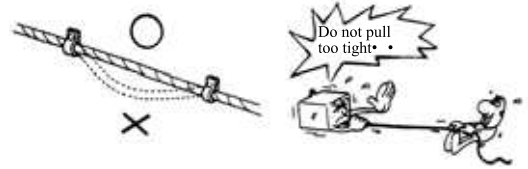

- Protect wires and harnesses with electrical tape or tube if they contact a sharp edge or corner.

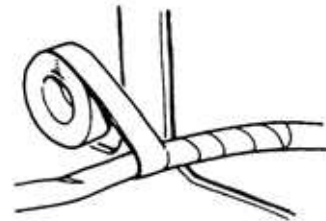

- When rubber protecting cover is used to protect the wire harnesses, it shall be installed securely.

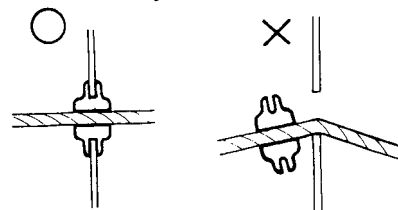

- Do not break the sheath of wire.
- If a wire or harness is with a broken sheath, repair by wrapping it with protective tape or replace it.

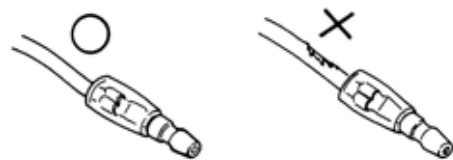

- When installing other parts, do not press or squeeze the wires.



1. GENERAL INFORMATION

- After routing, check that the wire harnesses are not twisted or kinked.

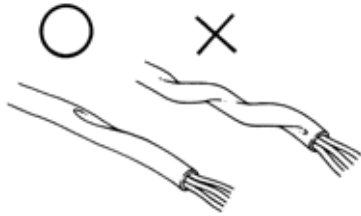

- Wire harnesses routed along with handlebar should not be pulled tight, have excessive slack or interfere with adjacent or surrounding parts in all steering positions.

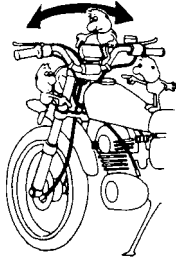

- When a testing device is used, make sure to understand the operating methods thoroughly and operate according to the operating instructions.

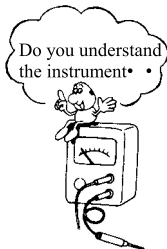

- Be careful not to drop any parts.



- When rust is found on a terminal, remove the rust with sand paper or equivalent before connecting

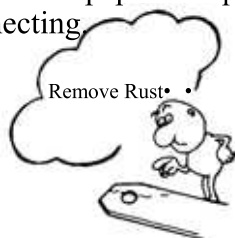

- Symbols:
The following symbols represent the servicing methods and cautions included in this service manual.



Engine Oil

: Apply engine oil to the specified points. (Use designated engine oil for lubrication.)



Grease

: Apply grease for lubrication.



Gear Oil

: Transmission Gear Oil (90#)



: Caution



: Warning

1. GENERAL INFORMATION

TORQUE VALUES

STANDARD TORQUE VALUES

Item	Torque kgf-m (N-m, lbf-ft)	Item	Torque kgf-m (N-m, lbf-ft)
5mm bolt and nut	0.5 (5, 3.6)	4mm screw	0.3 (3, 2.2)
6mm bolt and nut	1 (10, 7.2)	5mm screw	0.4 (4, 2.9)
8mm bolt and nut	2.2 (22, 16)	6mm screw, SH bolt	0.9 (9, 6.5)
10mm bolt and nut	3.5 (35, 25)	6mm flange bolt and nut	1.2 (12, 9)
12mm bolt and nut	5.5 (55, 40)	8mm flange bolt and nut	2.7 (27, 20)
14mm bolt and nut	7 (70, 50)	10mm flange bolt and nut	4 (40, 29)

Torque specifications listed below are for important fasteners.

ENGINE

Item	Q'ty	Thread dia. (mm)	Torque kgf-m (N-m, lbf-ft)	Remarks
MAINTENANCE:				
Spark plug	1	10	1.2 (12, 8.6)	
Tappet ADJ nut	2	5	0.9 (9, 6.5)	Apply oil
Engine oil strainer screen cap	1	30	1.5 (15, 11)	Apply oil
Engine oil filter cap bolt	3	6	1.2 (12, 8.6)	
Engine oil drain plug	1	12	2.5 (25, 18)	
Transmission gear oil drain bolt	1	10	1.3 (13, 9)	
Transmission gear oil fill bolt	1	10	1.3 (13, 9)	
LUBRICATION SYSTEM:				
Oil pump screw	1	3	0.2 (2, 1.5)	
COOLING SYSTEM:				
Fan motor bolt	3	5	0.53 (5, 2.8)	
Fan motor switch	1	16	1.8 (17, 13)	
Water pump impeller	1	8	1.2 (12, 9)	Left hand threads
CYLINDER HEAD:				
Cylinder head cover	4	6	1.2 (12, 8.6)	
Cylinder head nut (DINK 200i)	4	8	2.3 (23, 16.6)	Apply oil
Cylinder head nut (DINK 125)	1	8	2 (20, 14)	Apply oil
Tensioner sealing bolt	2	6	0.6 (6, 4)	
Cam chain tensioner mounting bolt	2	6	1.2 (12, 8.6)	
Cylinder head bolt		6	1 (10, 7.2)	

(Cont'd)

1. GENERAL INFORMATION

DINK200i/125

Item	Q'ty	Thread dia. (mm)	Torque kgf-m (N-m, lbf-ft)	Remarks
CYLINDER: Cylinder bolt	2	6	1 (10, 7.2)	
DRIVE/DRIVEN PULLEY: L crankcase cover	8	6	1.2 (12, 8.6)	
Drive pulley nut (DINK 200i)	1	12	5.8 (58, 42)	
Drive pulley nut (DINK 125)	1	10	5.5 (55, 40)	
Clutch outer nut	1	12	5.5 (55, 40)	
Driven pulley assembly plate nut	1	28	5.5 (55, 40)	
STARTER SYSTEM: Flywheel nut	1	14	5.5 (55, 40)	
TRANSMISSION: Transmission case cover bolt	9	6	1.2 (12, 8.6)	

FRAME

Item	Q'ty	Thread dia. (mm)	Torque kgf-m (N-m, lbf-ft)	Remarks
EXHAUST MUFFLER: Exhaust muffler mounting bolt	3	10	3.3 (33, 24)	
Exhaust pipe mounting nut	2	8	2 (20, 14)	
ENGINE ASSEMBLY: Engine hanger mounting bolt	1	12	5 (50, 36)	
Engine mounting bolt/nut	1	10	5 (50, 36)	
STEERING SYSTEM: Steering stem lock nut	1	27	8 (80, 58)	
Handlebar lock nut	1	10	4.5 (45, 32)	
Steering stem pinch bolt	4	8	3.2 (32, 23)	
WHEEL: Front wheel axle nut	1	12	6 (60, 43)	
Rear wheel axle nut	1	16	12 (120, 86)	

(Cont'd)

1. GENERAL INFORMATION

Item	Q'ty	Thread dia. (mm)	Torque kgf-m (N-m, lbf-ft)	Remarks
SUSPENSION:				
Rear shock absorber upper mount bolt	2	10	4 (40, 29)	
Rear shock absorber lower mount bolt	2	8	2.7 (27, 19)	
Rear fork	2	8	2.7 (27, 19)	
BRAKE:				
Front caliper	2	8	2.7 (27, 19)	
Rear caliper	2	8	3.2 (32, 23)	
Brake hose oil bolt	4	10	3.5 (35, 25)	
Master cylinder holder bolt	4	6	1.2 (12, 9)	
Master cylinder reservoir cover screw	4	4	0.16 (1.6, 1)	
Brake caliper bleeder	2	5	0.6 (6, 4)	
OTHERS:				
Start relay nut	2	6	0.3 (3, 2)	
Rear spoiler	3	8	1.2 (12, 9)	

1. GENERAL INFORMATION





DINK200i/125

SPECIAL TOOLS

Tool Name	Tool No.	Illustration (Note: the special tools may differ slightly from those shown in the figure of this manual.)
Flywheel puller (Refer to the “ STARTER CLUTCH ” section in the chapter 10.)	A120E00003	
Oil seal and bearing installer	A120E00014	
Universal holder (Refer to the “ DRIVE PULLEY, DRIVE BELT AND DRIVEN PULLEY ” section in the chapter 8.)	A120E00017	
Flywheel holder (Refer to the “ STARTER CLUTCH ” section in the chapter 10.)	A120E00021	
Clutch spring compressor (Refer to the “ DRIVE PULLEY, DRIVE BELT AND DRIVEN PULLEY ” section in the chapter 8.)	A120E00034	
Valve adjuster (Refer to the “ VALVE CLEARANCE ” section in the chapter 3.)	A120E00036	

(Cont'd)

1. GENERAL INFORMATION

Tool Name	Tool No.	Illustration (Note: the special tools may differ slightly from those shown in the figure of this manual.)
Bearing puller	A120E00037	
Valve spring compressor (Refer to the “ CYLINDER HEAD ” section in the chapter 6.)	A120E00040	
AFI diagnostic tool pda (Refer to the “ SELF-DIAGNOSTIC PROCEDURES USING DIAGNOSTIC TOOL (PDA) ” section in the chapter 14.)	A120E00069	
Lock nut wrench (Refer to the “ STEERING STEM ” section in the chapter 15.)	A120F00002	

1. GENERAL INFORMATION

LUBRICATION POINTS

ENGINE

Lubrication Points	Lubricant
Valve guide/valve stem movable part Camshaft protruding surface Valve rocker arm friction surface Camshaft drive chain Cylinder lock bolt and nut Piston surroundings and piston ring grooves Piston pin surroundings Cylinder inside wall Connecting rod/piston pin hole Connecting rod big end Crankshaft Crankshaft one-way clutch movable part Oil pump drive chain Starter reduction gear engaging part Countershaft gear engaging part Final gear engaging part Bearing movable part O-ring face Oil seal lip	<ul style="list-style-type: none"> •Genuine KYMCO Engine Oil (SAE 10W-30) •API SG Engine Oil
Transmission gear	SAE 90
Kick starter part Friction spring movable part/shaft movable part Final gear shaft grooved part	High-temperature resistant grease
Starter one-way clutch threads	Thread locking agent
A.C. generator connector Transmission case breather tube	Adhesive

1. GENERAL INFORMATION

FRAME

The following is the lubrication points for the frame.

Use general purpose grease for parts not listed.

Apply clean engine oil or grease to cables and movable parts not specified. This will avoid abnormal noise and rise the durability of the motorcycle.

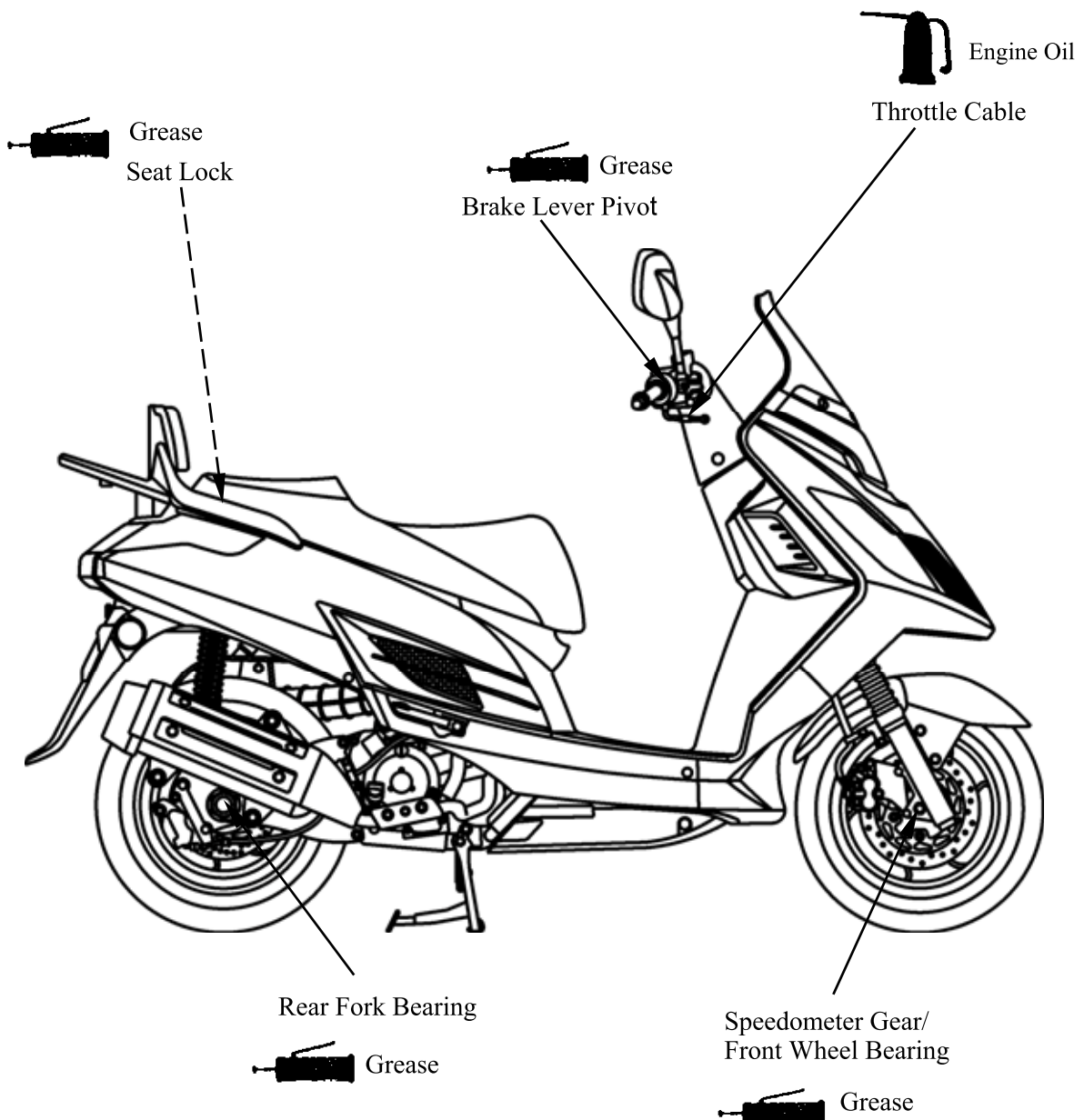

CABLE & HARNESS ROUTING

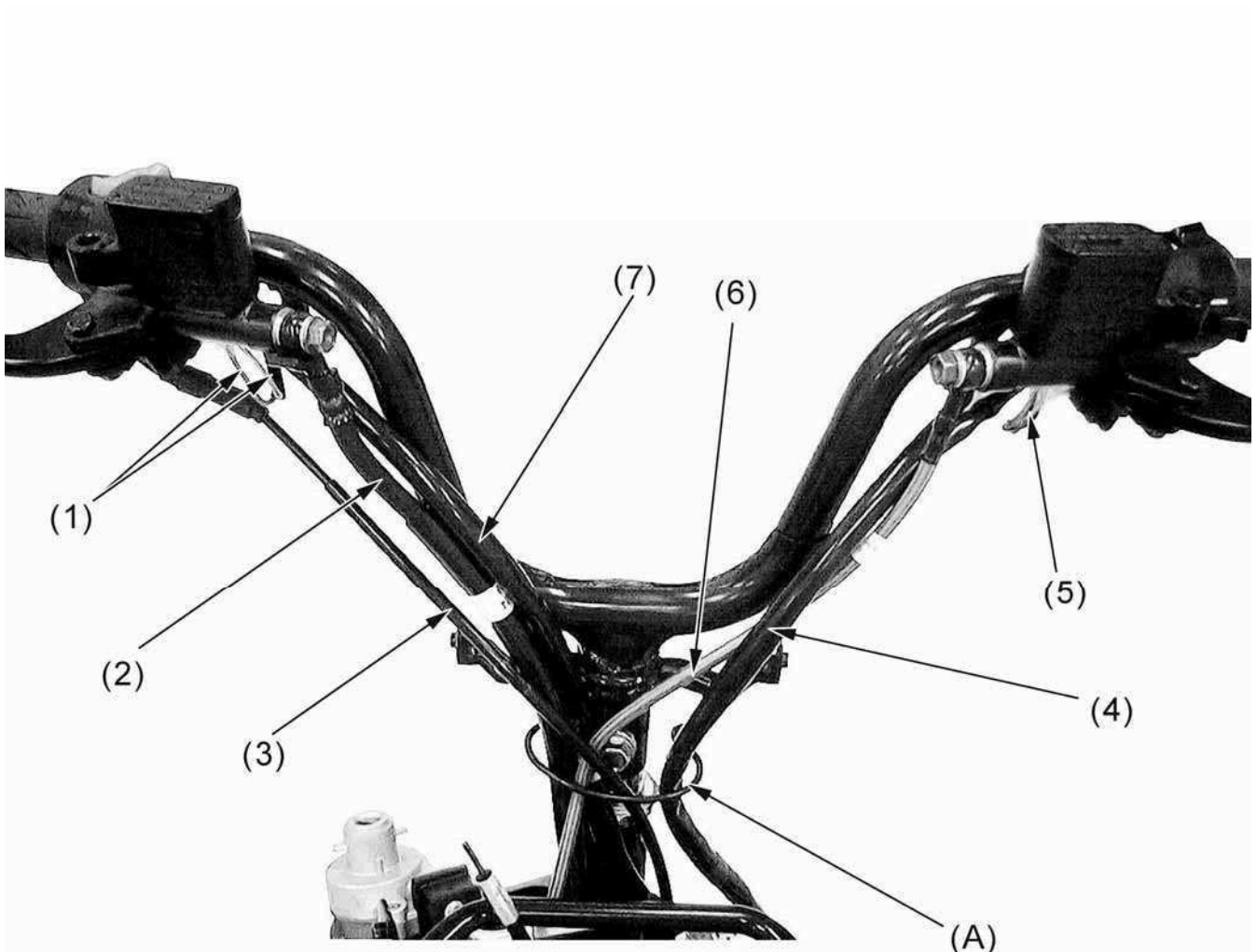

- | | | |
|--------------------------------------|-------------------------------------|----------------------------|
| (1) Brake light switch (Front brake) | (2) Front brake hose | (3) Throttle cable (Note) |
| (4) Left handlebar switch | (5) Brake light switch (Rear brake) | (7) Right handlebar switch |
| (6) Rear brake hose | | |

(A) Pass the front brake hose, rear brake hose, throttle cable, right handlebar switch and left handlebar switch through the guide.

Note: Pass the throttle cable through the lower handlebar cover.

1. GENERAL INFORMATION

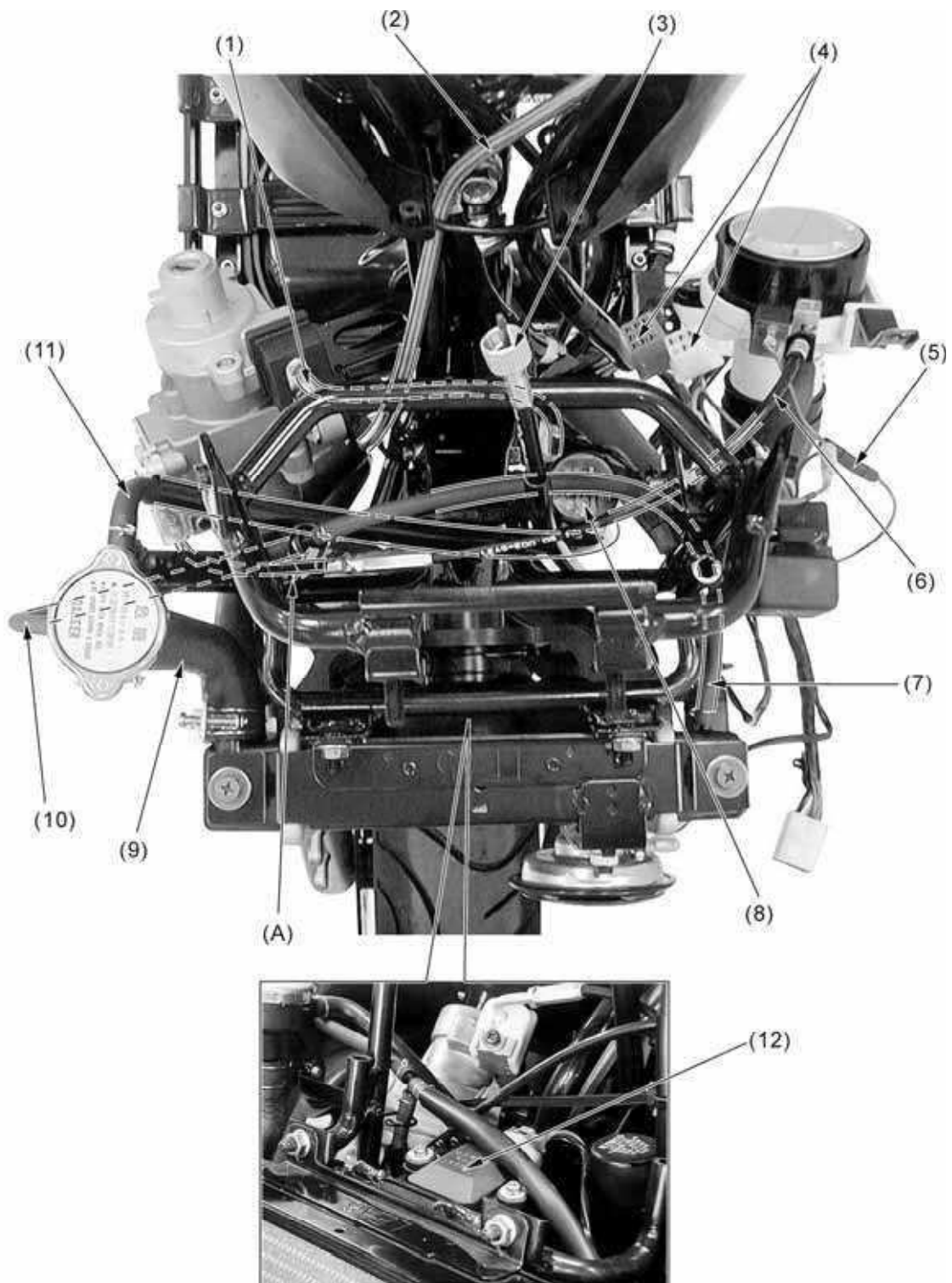

- | | | |
|--------------------------------------|---|-----------------------|
| (1) Seat lock cable | (2) Rear brake hose | (3) Speedometer cable |
| (4) Instrument connectors | (5) Fuel fill cap ground wire connector | |
| (6) Fuel cap lock cable | (7) Radiator bleed hose | (8) Flashing relay |
| (9) Coolant fill hose | (10) Radiator bleed hose | (11) Siphon hose |
| (12) Angle detect sensor (DINK 200i) | | |

(A) Pass the radiator bleed hose through the guide.

1. GENERAL INFORMATION

DINK200i/125

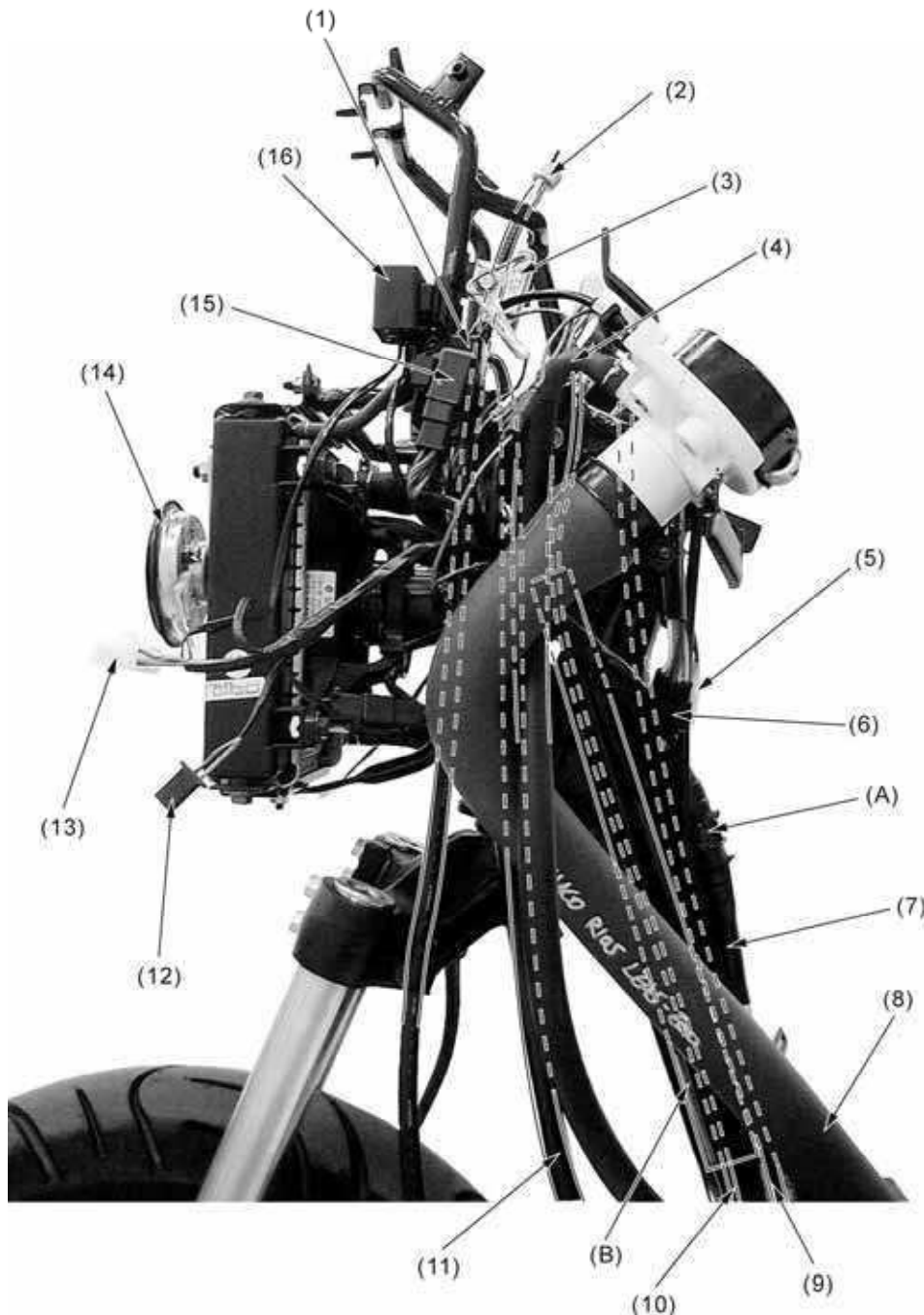

- | | | |
|---------------------------------------|----------------------------|---------------------------|
| (1) Low beam relay | (2) Speedometer cable | (3) Resistor |
| (4) Fuel tank breather hose | (5) Right handlebar switch | (6) Left handlebar switch |
| (7) Harness wire | (8) Fuel fill hose | (9) Throttle cable |
| (10) Seat lock cable | (11) Siphon hose | |
| (12) Left turn signal light connector | (13) Headlight connector | (14) Horn |
| (15) High beam relay | (16) Fan EMI filter | |

(A) Pass the harness wire through the guide.
 (B) Pass the seat lock cable through the guide pipe.

1. GENERAL INFORMATION

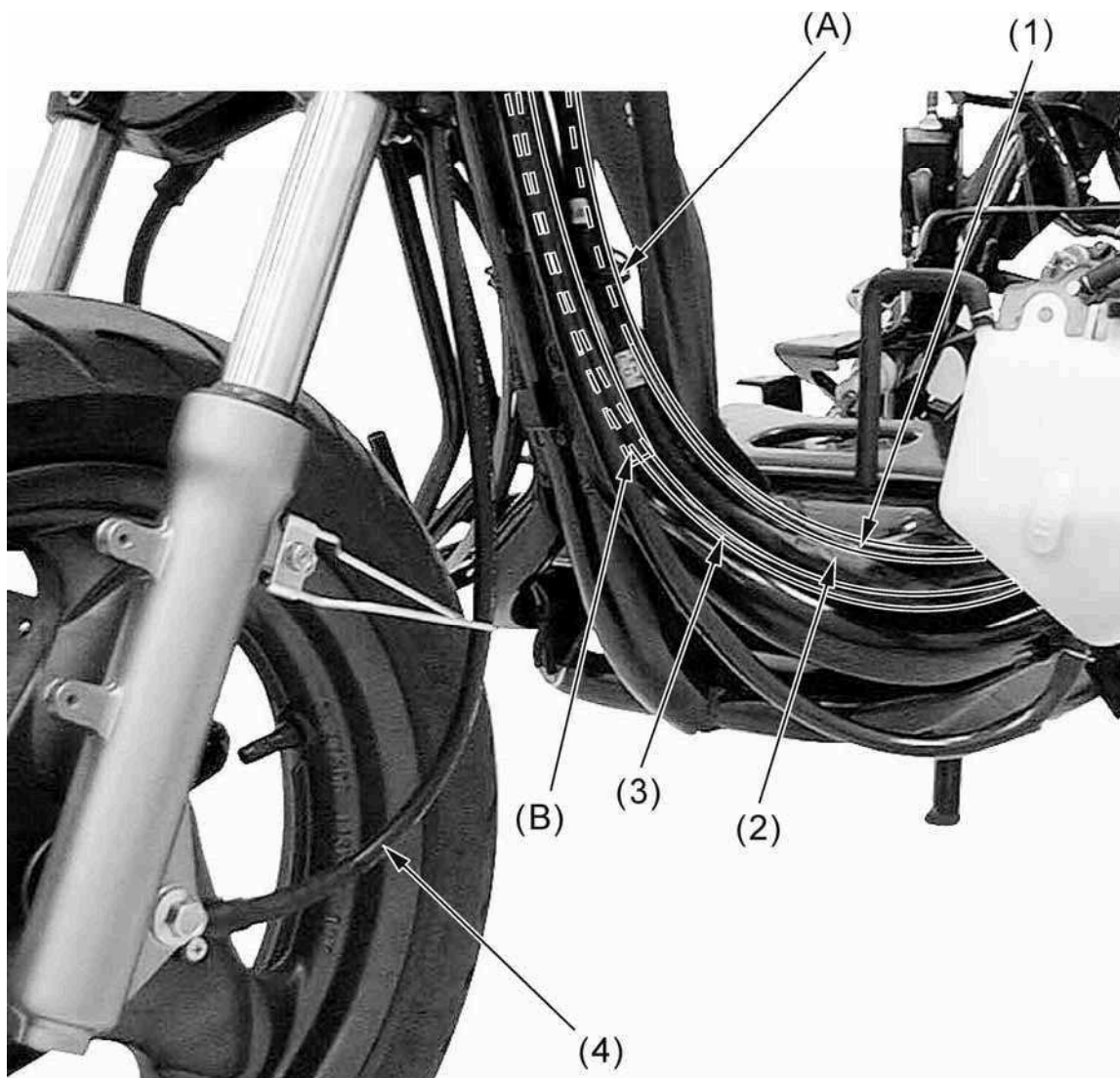

(1) Throttle cable
(4) Speedometer cable

(2) Harness wire

(3) Seat lock cable

(A) Pass the harness wire and throttle cable through the guide.
(B) Pass the seat lock cable through the guide pipe.

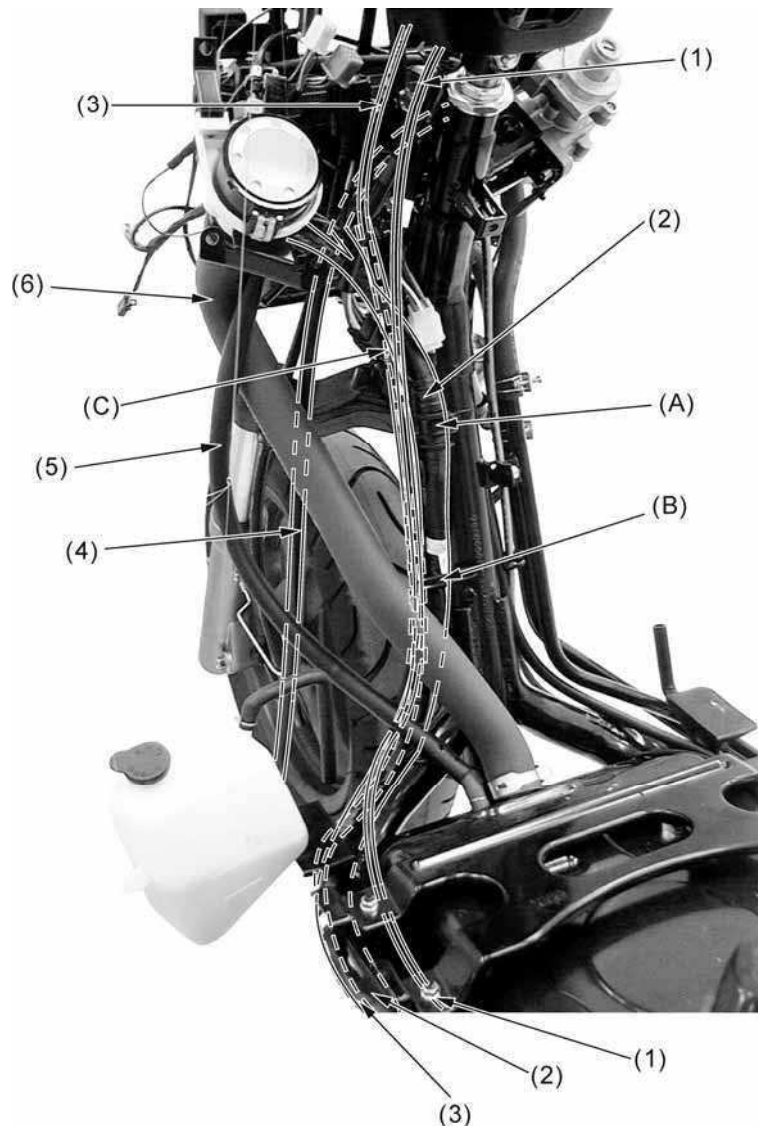

(1) Throttle cable
(4) Siphon hose

(2) Harness wire
(5) Fuel tank breather hose

(3) Seat lock cable
(6) Fuel fill hose

(A) Pass the harness wire through the guide.
(B) Pass the harness wire and throttle cable through the guide.
(C) Pass the seat lock cable through the guide pipe.

1. GENERAL INFORMATION

- Refer to the page 1-30 to understand the fuel system wire routing of DINK 200i.

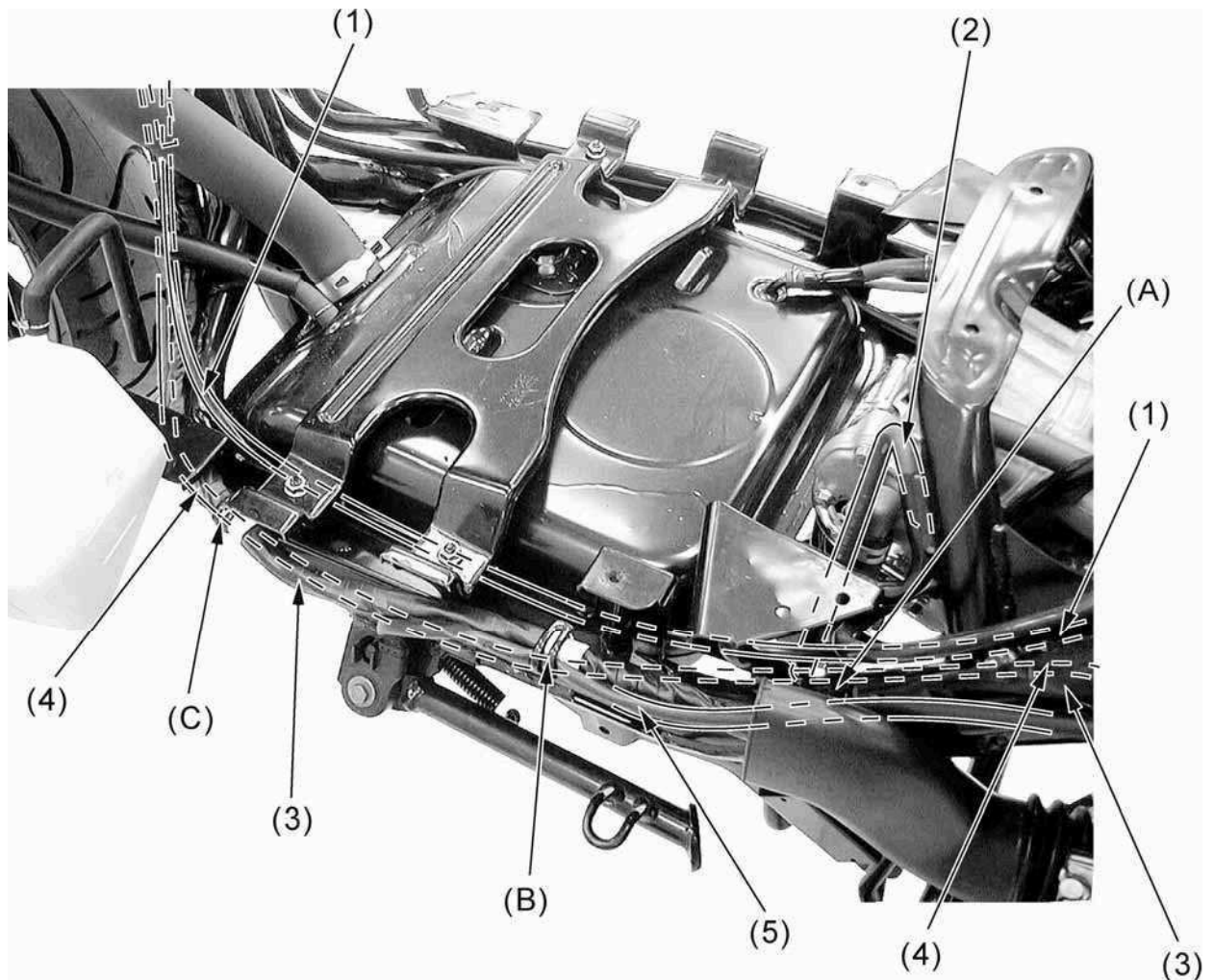

(1) Throttle cable
 (4) Seat lock cable

(2) AICV air inlet hose
 (5) Side stand switch wire

(3) Harness wire

- (A) Pass the seat lock cable through the guide.
 (B) Pass the seat lock cable and harness wire through the guide.
 (C) Pass the seat lock cable and harness wire through the guide.

1. GENERAL INFORMATION

DINK200i/125

Refer to the page 1-30 to understand the fuel system wire routing of DINK 200i.

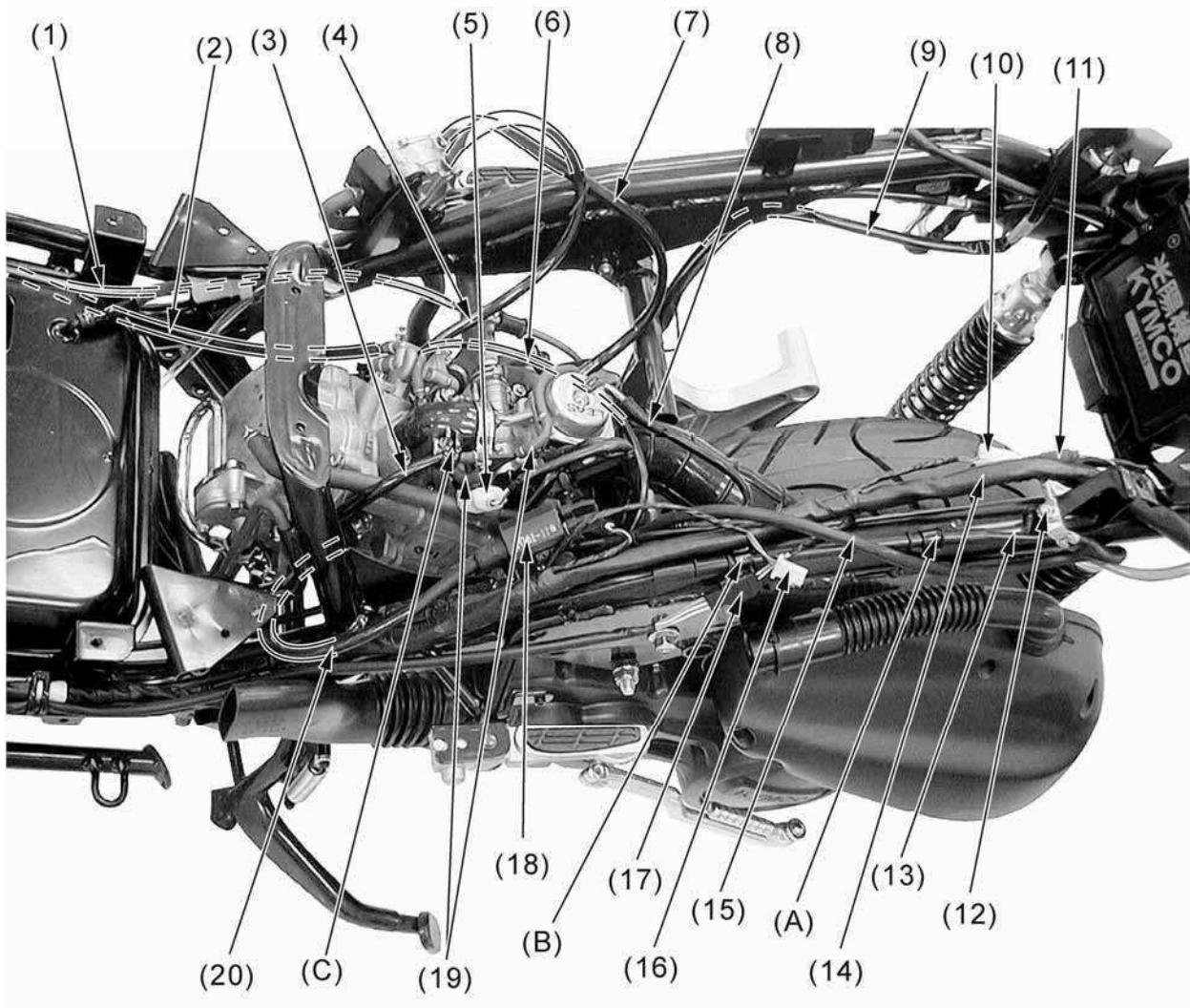

- (1) Rear brake hose
- (2) Bleed hose
- (3) AICV Vacuum hose
- (4) Fuel pump vacuum hose (DINK 125)
- (5) Carburetor heater connector (DINK 125)
- (6) Coolant temperature sensor wire (DINK 125)
- (7) Fuel pump fuel hose (DINK 125)
- (8) Throttle cable
- (9) Starter motor cable
- (10) Heater control connector (DINK 125)
- (11) Auto choke connector (DINK 125)
- (12) Frame ground terminal
- (13) Harness wire
- (14) Seat lock cable
- (15) Ground cable
- (16) Luggage box light connector
- (17) Side stand switch connector
- (18) Ignition coil (DINK 125)
- (19) Carburetor vacuum hose (DINK 125)
- (20) Ignition coil cable

- (A) Pass the seat lock cable through the guide.
- (B) Pass the seat lock cable through the guide.
- (C) Pass the AICV vacuum hose through the guide.

1. GENERAL INFORMATION

Refer to the page 1-30 to understand the fuel system wire routing of DINK 200i.

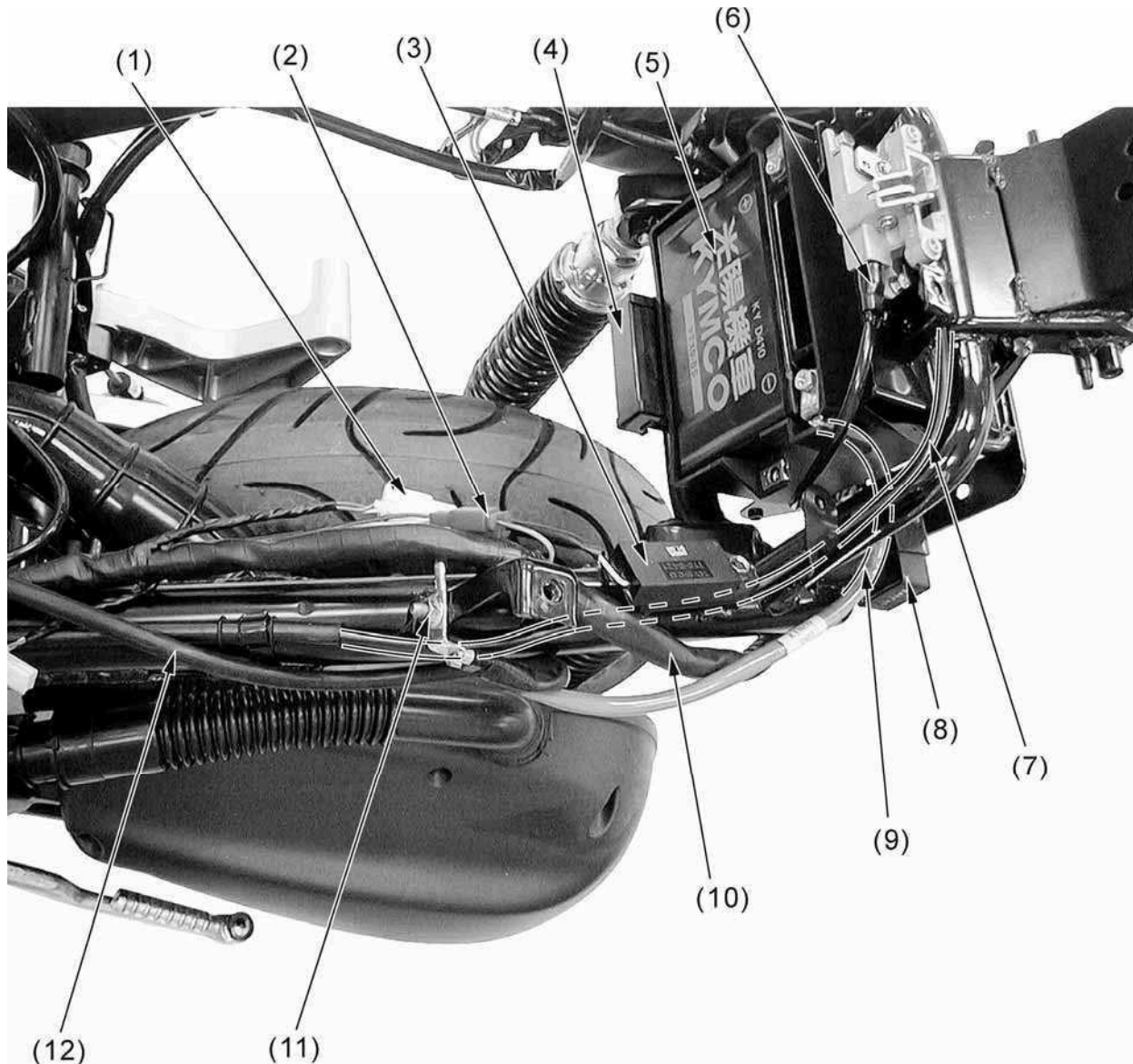

(1) Heater control connector (DINK 125)

(2) Auto choke connector (DINK 125)

(3) Heater connector (DINK 125)

(4) Fuse box

(5) Battery

(6) Luggage box light switch

(7) Seat lock cable

(8) Engine stop control unit (DINK 200i)

(9) Battery negative cable

(10) Harness wire

(11) Frame ground terminal

(12) Ground cable

1. GENERAL INFORMATION

DINK200i/125

- Refer to the page 1-30 to understand the fuel system wire routing of DINK 200i.

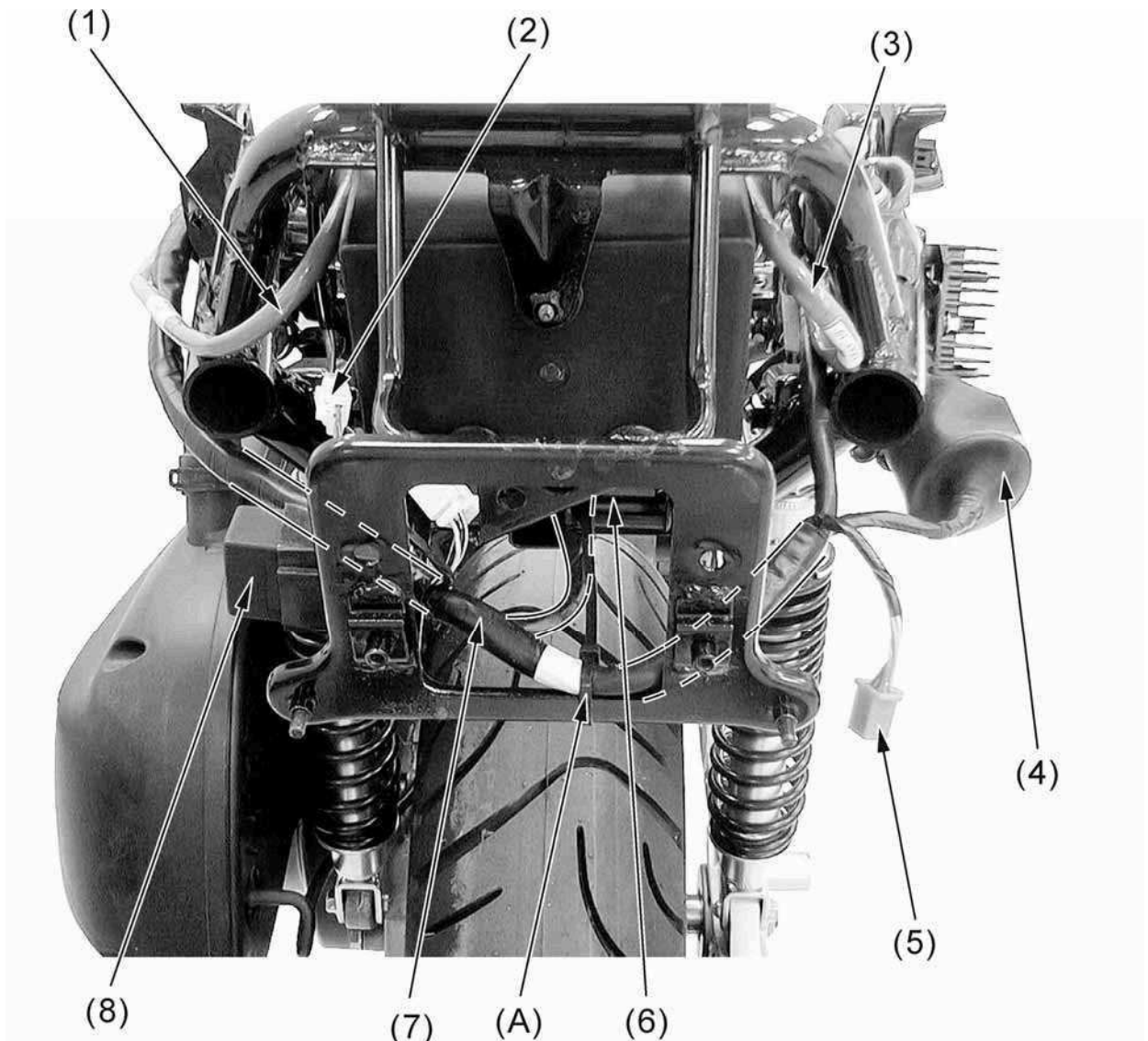

- (1) Battery negative terminal (2) Luggage box light connector (3) Battery positive terminal
 (4) A.C.G/Regulator/Rectifier/Starter relay connectors
 (5) Combination light connector (6) Fuse box
 (7) Harness (8) Engine stop control unit (DINK 200i)

(A) Pass the harness wire through the plastic band.

1. GENERAL INFORMATION

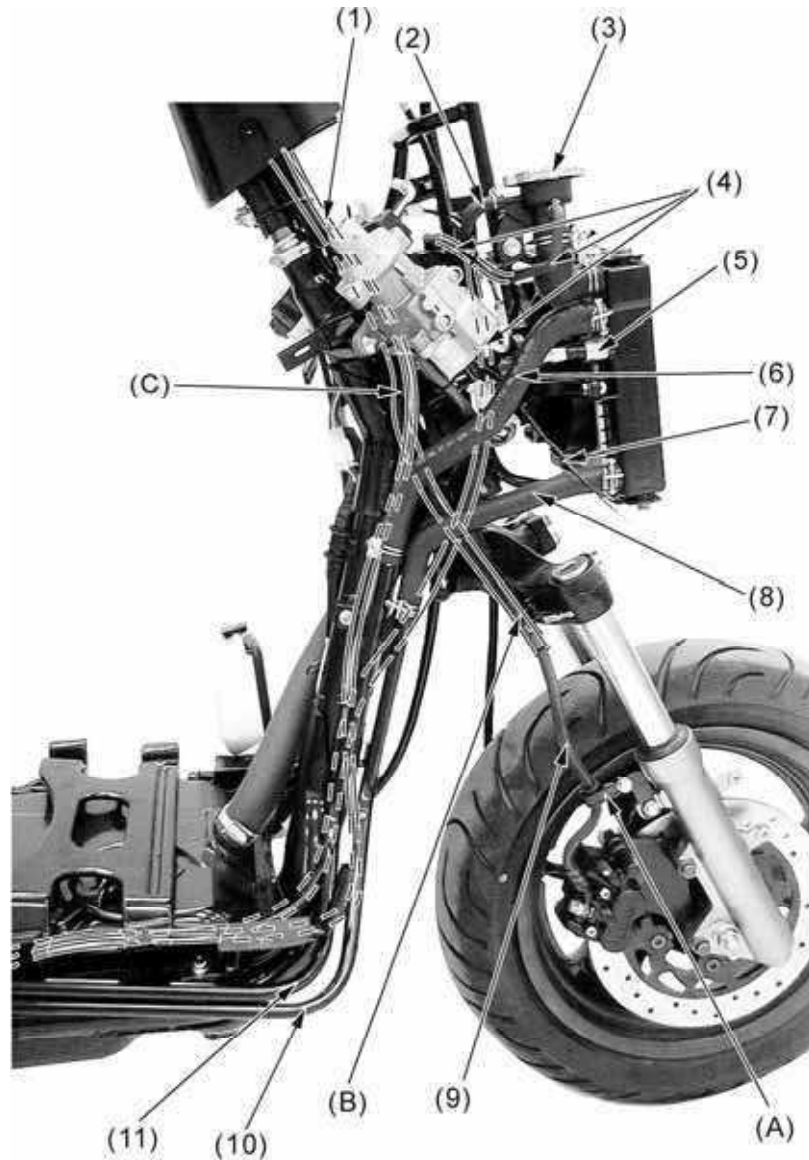

- | | | |
|----------------------------------|--------------------------|-------------------------|
| (1) Rear brake hose | (2) Siphon hose | (3) Radiator cap |
| (4) Bleed hoses | (5) Fan motor switch | (6) Upper radiator hose |
| (7) Right turn signal light wire | (8) Lower radiator hose | (9) Front brake hose |
| (10) Lower radiator pipe | (11) Upper radiator pipe | |

(A) Pass the front brake hose through the guide.

(B) Pass the front brake hose through the guide.

(C) Pass the front brake hose through the guide.

1. GENERAL INFORMATION

- Refer to the page 1-30 to understand the fuel system of DINK 200i.

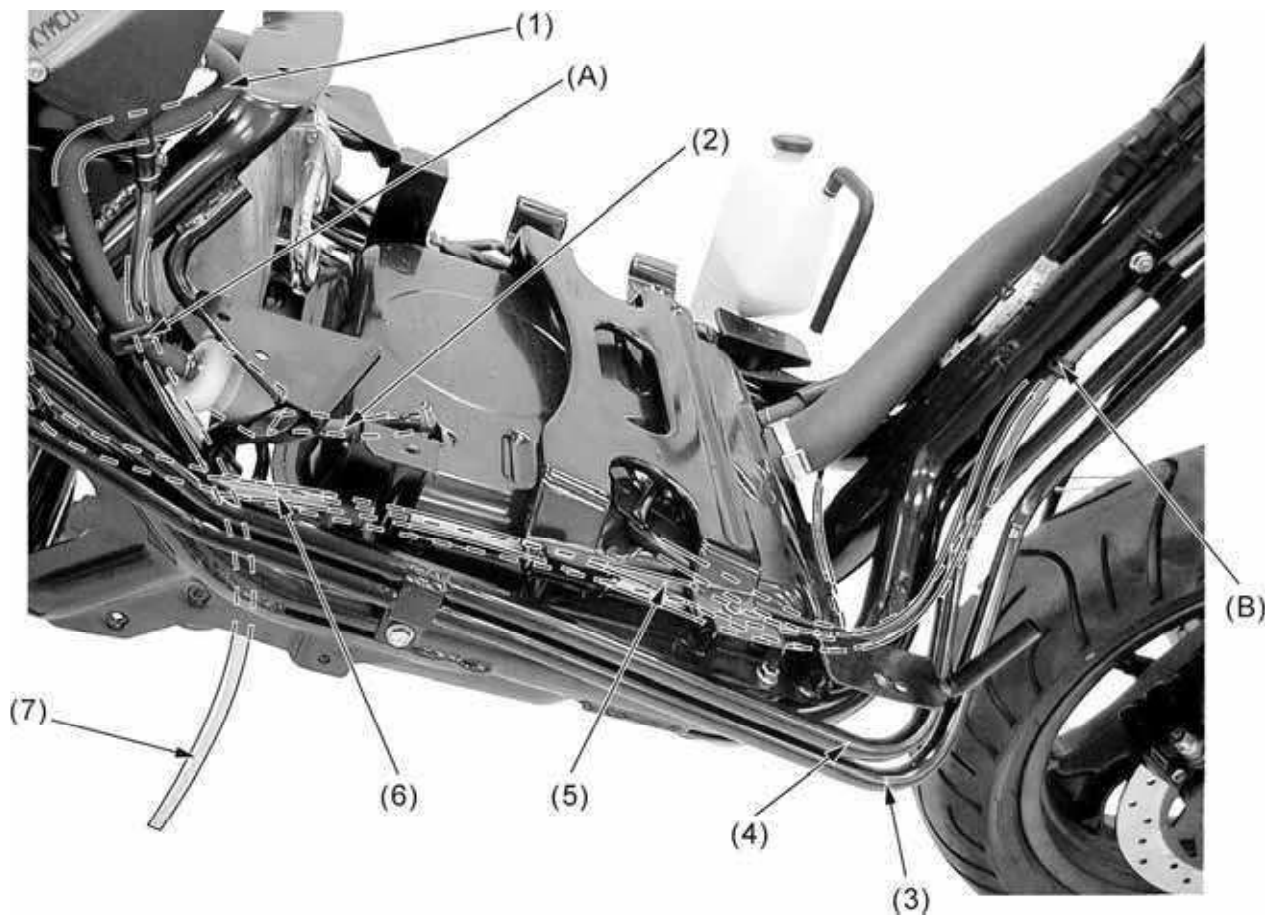

- (1) DINK 125: Fuel hose (between the fuel pump and fuel filter)
- (2) DINK 125: Fuel hose (between the fuel filter and fuel tank)
- (3) Lower radiator pipe
- (4) Upper radiator pipe
- (5) Bleed hose
- (6) Rear brake hose
- (7) Water flow hose

- (A) Pass the fuel hose and water flow hose through the guide.
- (B) Pass the bleed hose and rear brake hose through the guide.

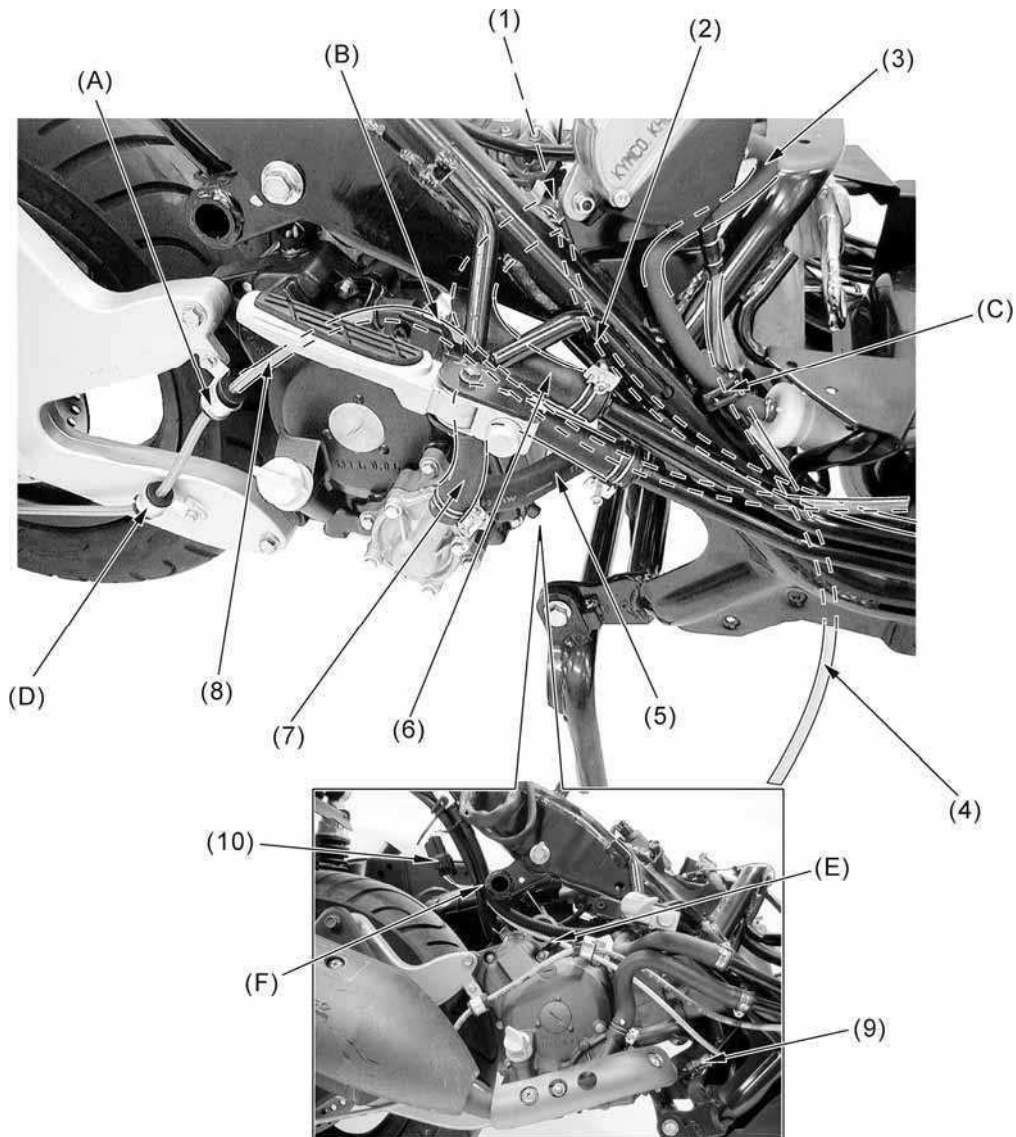

- (1) Thermostat
- (2) Bleed hose (connect the thermostat)
- (3) Fuel hose (DINK 125)
- (4) Water flow hose
- (5) Water hose (between the water pump and cylinder)
- (6) Upper radiator hose (connect the thermostat)
- (7) Lower radiator hose
- (8) Rear brake hose
- (9) O2 sensor (DINK 200i)
- (10) O2 sensor connector (DINK 200i)

Refer to the page 1-30 to understand the fuel system wire routing of DINK 200i.

- (A) Pass the rear brake hose through the guide.
- (B) Pass the rear brake hose through the guide.
- (C) Pass the fuel hose (DINK 125) and water flow hose through the guide.
- (D) Pass the rear brake hose through the guide.
- (E) DINK 200i: Pass the O2 sensor wire through the guide
- (F) DINK 200i: Pass the O2 sensor wire, harness wire, starter motor cable and A.C.G. wire through the guide

1. GENERAL INFORMATION

DINK200i/125

Refer to the page 1-30 to understand the fuel system of DINK 200i.

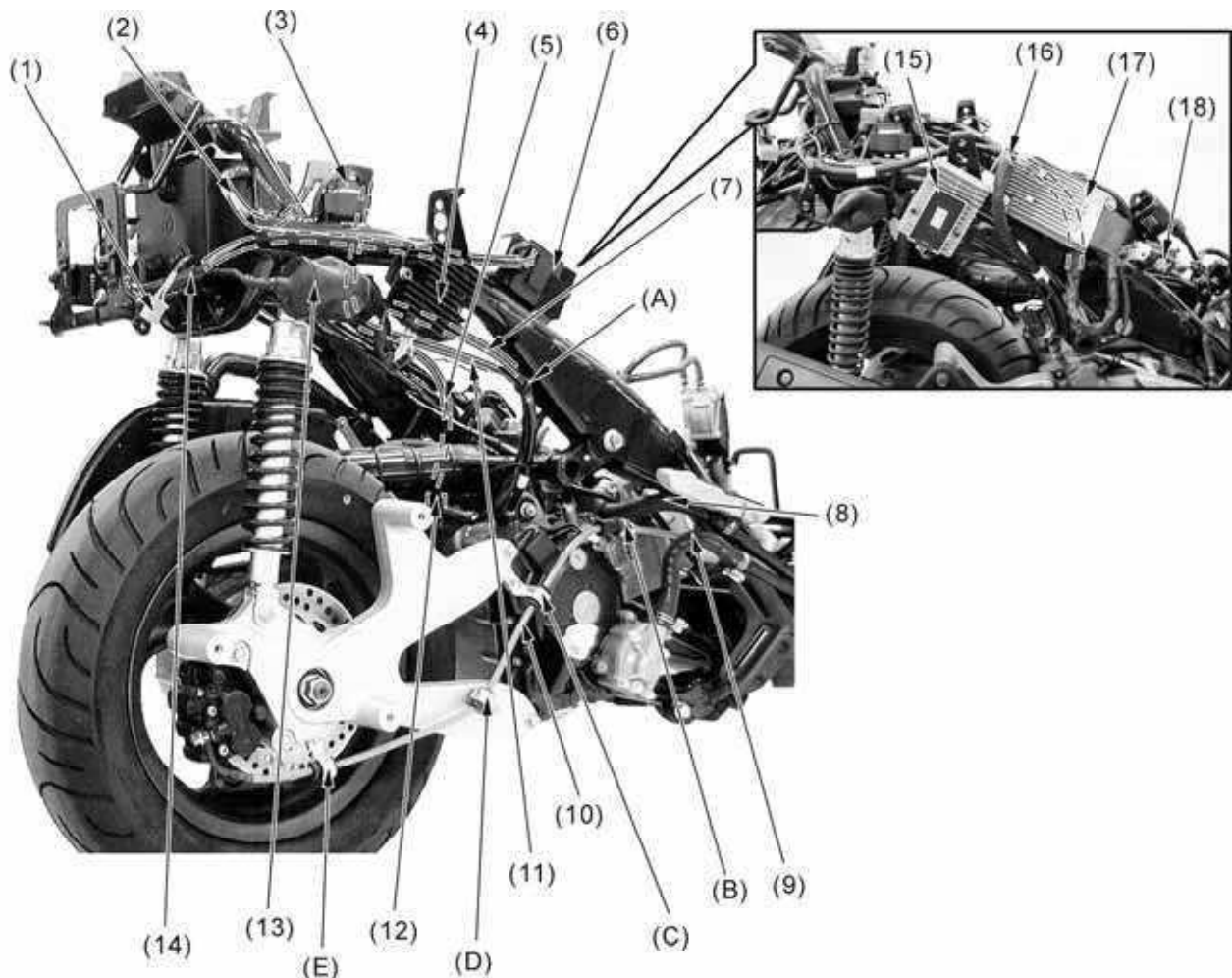

- | | |
|---|---|
| (1) Combination light connector | (2) Battery positive cable |
| (3) Starter relay | (4) Regulator/Rectifier (DINK 125) |
| (5) Ground cable | (6) CDI (DINK 125) |
| (7) A.C.G. wire | (8) Upper radiator hose |
| (9) Lower radiator hose | (10) Rear brake hose |
| (11) Starter motor cable | (12) Engine ground terminal (connect the starter motor) |
| (13) A.C.G/Regulator/Rectifier/Starter relay connectors | (14) Harness wire (DINK 125) |
| (15) Regulator/Rectifier (DINK 200i) | (16) Harness wire (DINK 200i) |
| (17) ECU (DINK 200i) | (18) Fuel pump relay (DINK 200i) |

- (A) Pass the starter motor cable and A.C.G. wire through the guide.
 (B) Pass the rear brake hose through the guide.
 (C) Pass the rear brake hose through the guide.
 (D) Pass the rear brake hose through the guide.
 (E) Pass the rear brake hose through the guide.

1. GENERAL INFORMATION

Refer to the page 1-30 to understand the fuel system of DINK 200i.

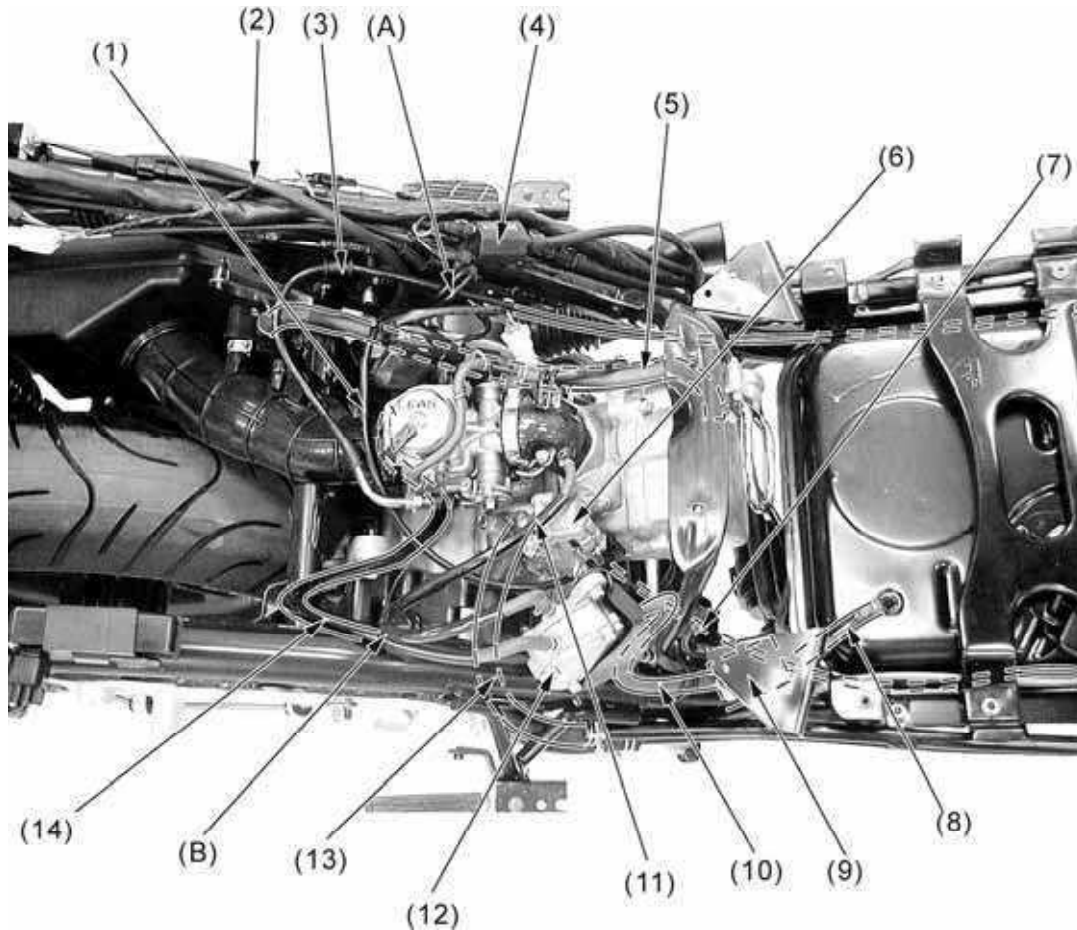

- | | |
|--|---------------------------|
| (1) Coolant temperature sensor wire | (2) Ground cable |
| (3) Throttle cable | (4) Ignition coil |
| (6) Thermostat | (7) Bleed hose |
| (8) DINK 125: Fuel hose (between fuel filter and fuel tank) | (9) DINK 125: Fuel filter |
| (10) DINK 125: Fuel hose (between fuel filter and fuel pump) | |
| (11) DINK 125: Fuel pump vacuum hose | |
| (12) DINK 125: Fuel pump | (13) Upper radiator hose |
| (14) DINK 125: Fuel hose (between fuel pump and carburetor) | |

(A) Pass the auto choke wire (DINK 125), throttle cable and harness wire through the guide.

(B) Pass the fuse hose and vacuum hose (DINK 125) through the plastic band.

1. GENERAL INFORMATION

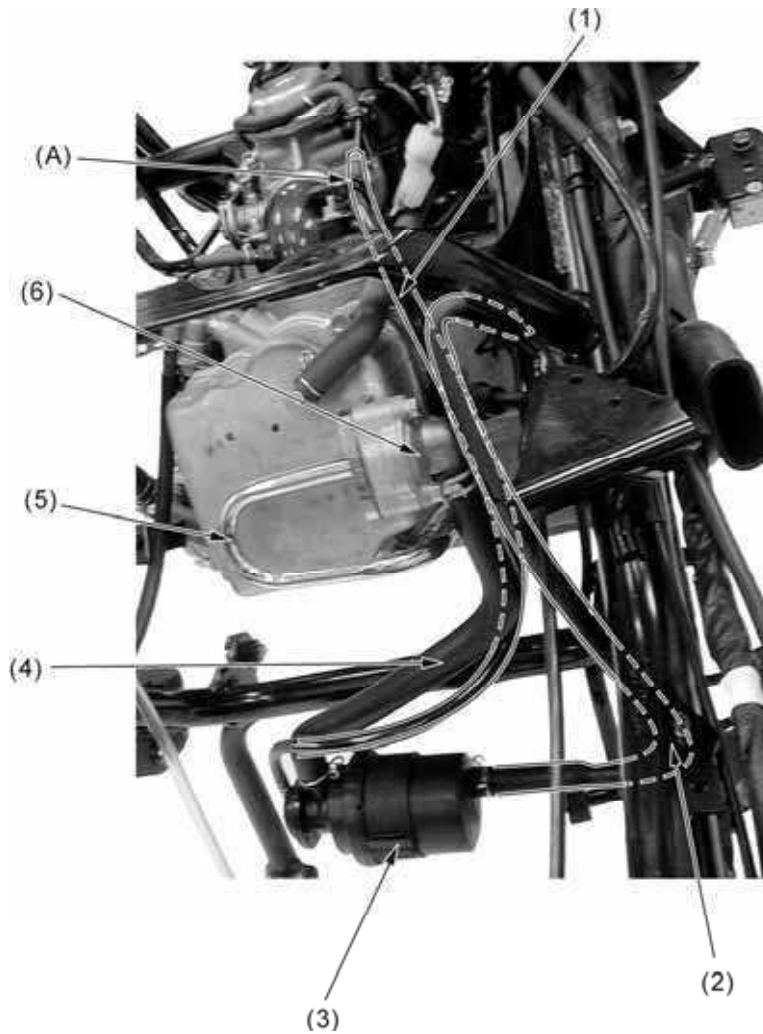

(1) AICV vacuum hose

(2) Air inlet hose

(3) AICV control solenoid valve

(4) Air supply hose

(5) Air inlet pipe

(6) AICV

(A) Pass the AICV vacuum hose through the guide.

1. GENERAL INFORMATION

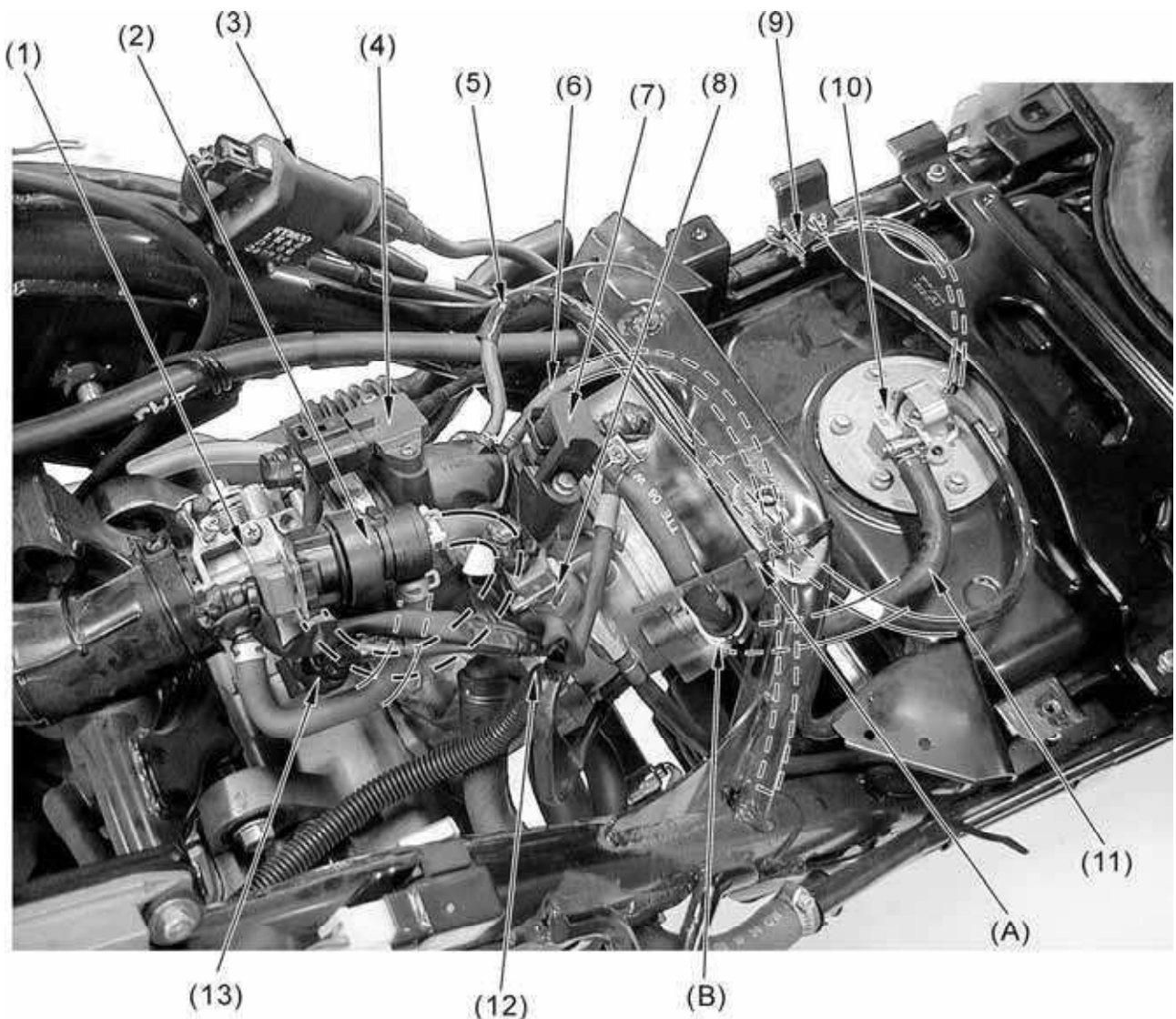

- | | | |
|-------------------------------------|----------------------------------|-------------------------------|
| (1) Throttle body (DINK 200i) | (2) ABV sensor (DINK 200i) | (3) Ignition coil (DINK 200i) |
| (4) T-MAP sensor (DINK 200i) | (5) Fuel vacuum hose (DINK 200i) | |
| (6) AICV vacuum hose | (7) Fuel injector (DINK 200i) | (8) WTS sensor (DINK 200i) |
| (9) Fuel pump connector (DINK 200i) | | (10) Fuel pump (DINK 200i) |
| (11) Fuel hose (DINK 200i) | (12) Harness wire (DINK 200i) | (12) TPS sensor (DINK 200i) |

(A) Pass the AICV vacuum hose and fuel vacuum hose through the plastic band.

(B) Pass the fuel hose through the guide.

TROUBLESHOOTING (DINK 200i)

ENGINE WILL NOT START OR IS HARD TO START

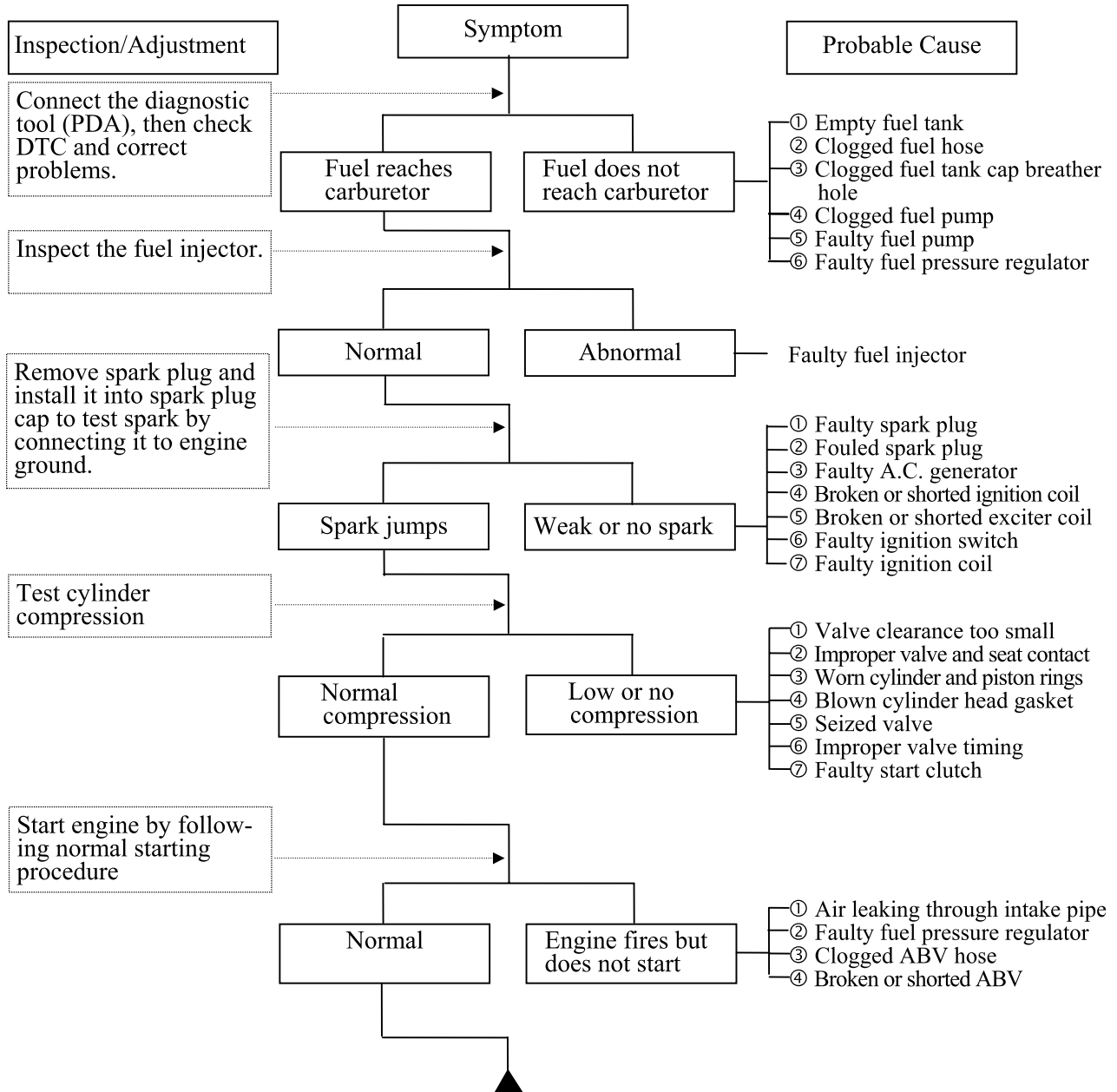

ENGINE LACKS POWER

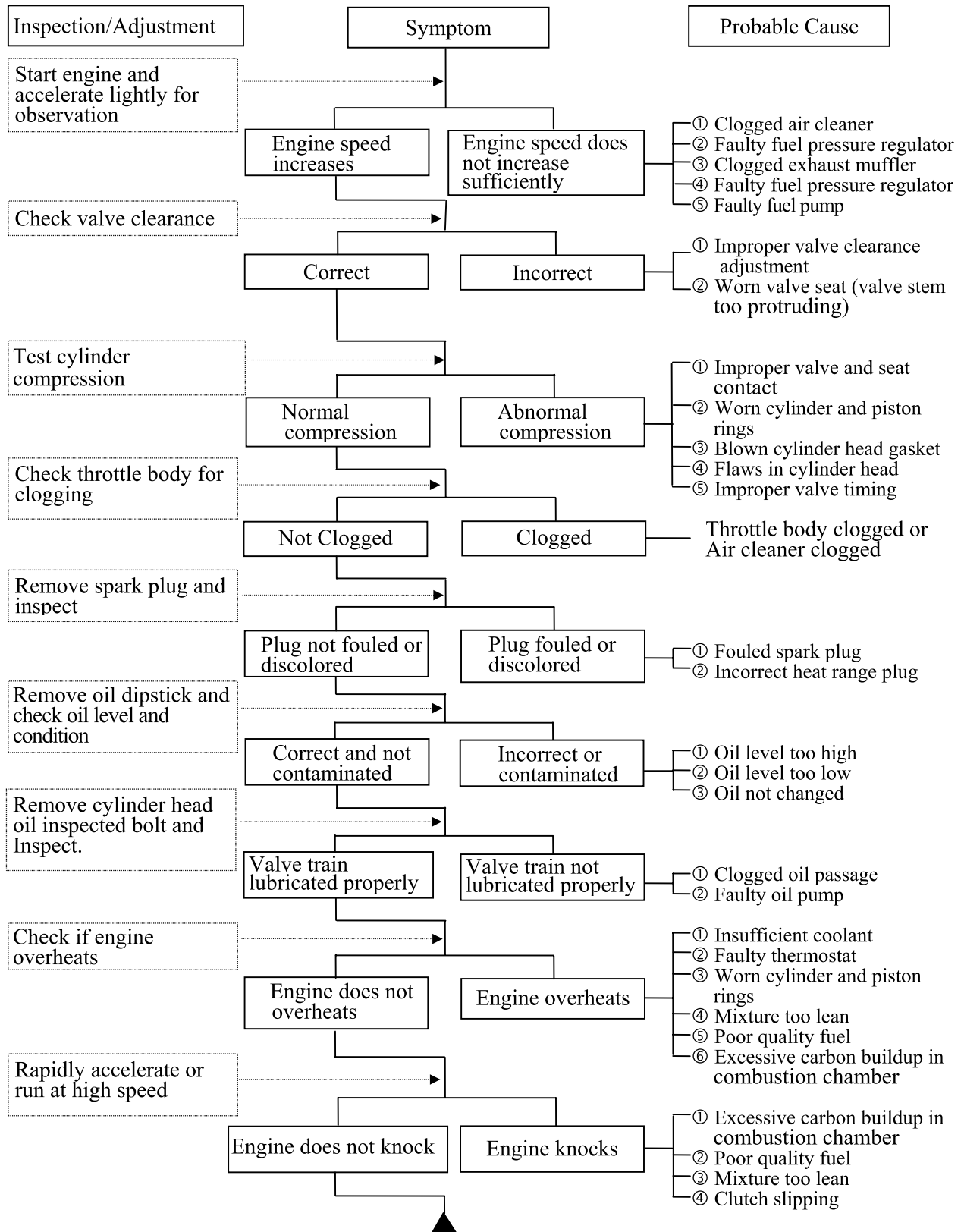

1. GENERAL INFORMATION

POOR PERFORMANCE (ESPECIALLY AT IDLE AND LOW SPEEDS)

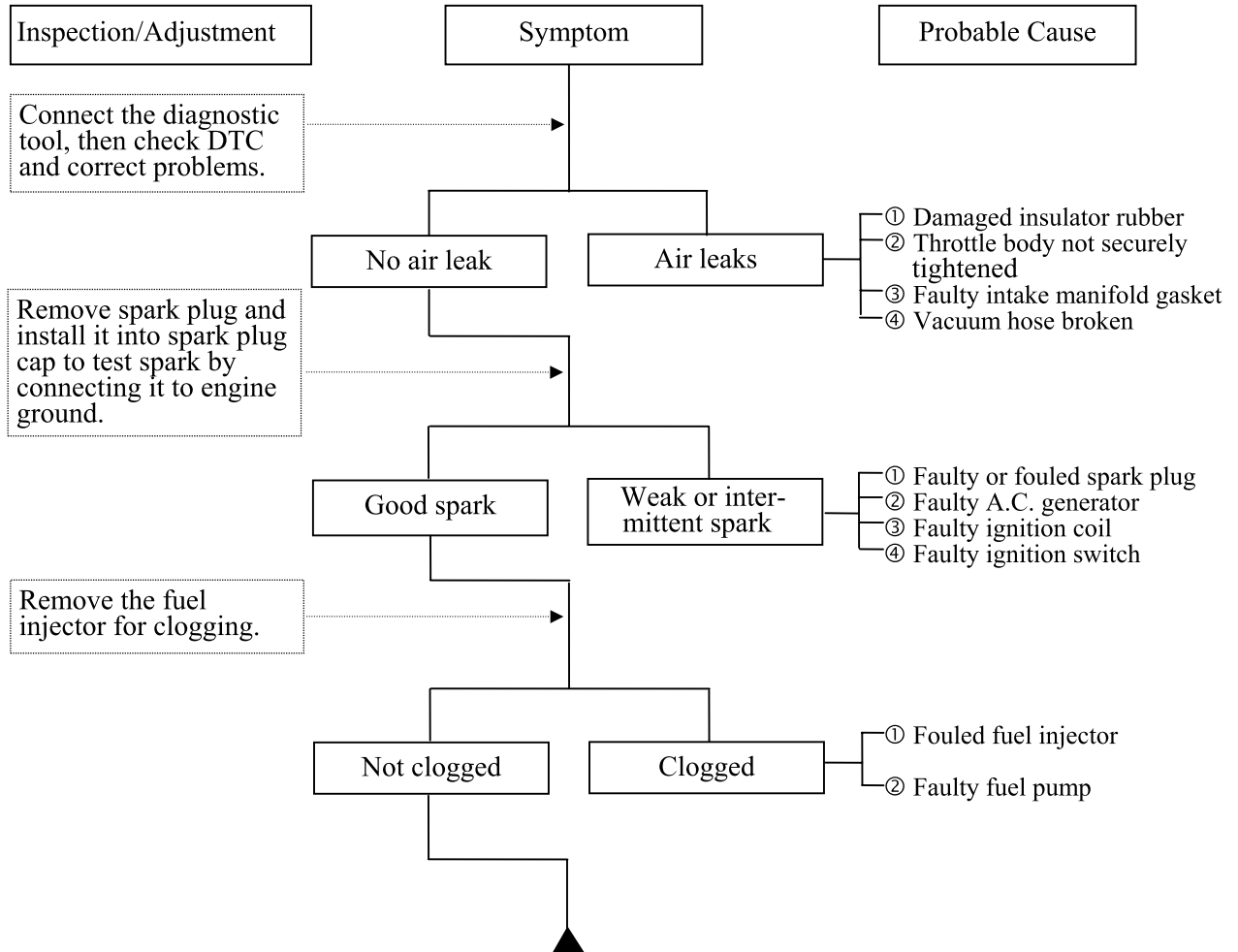

1. GENERAL INFORMATION

POOR PERFORMANCE (AT HIGH SPEED)

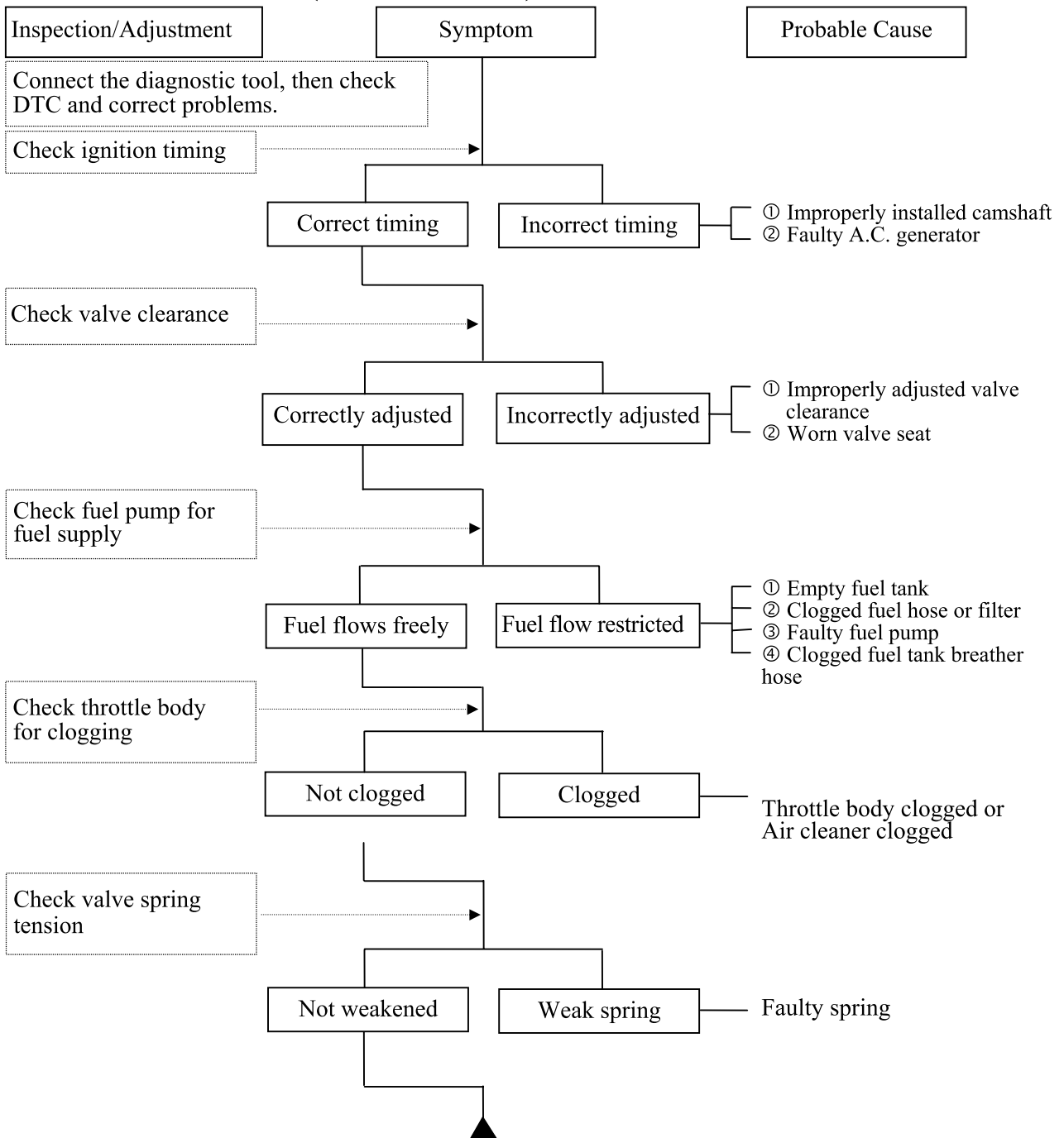

ENGINE NOISE

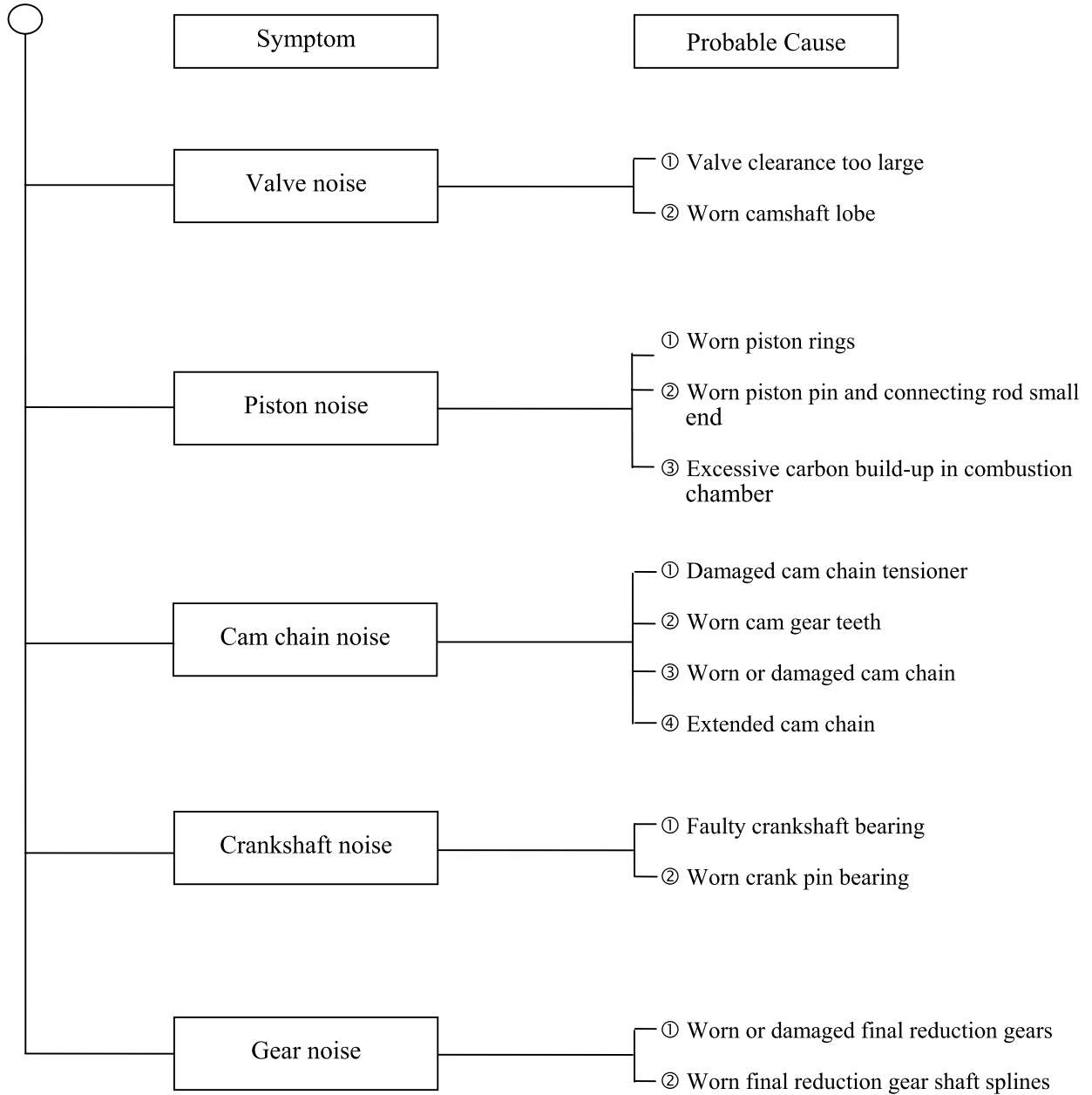

CLUTCH, DRIVE AND DRIVEN PULLEYS

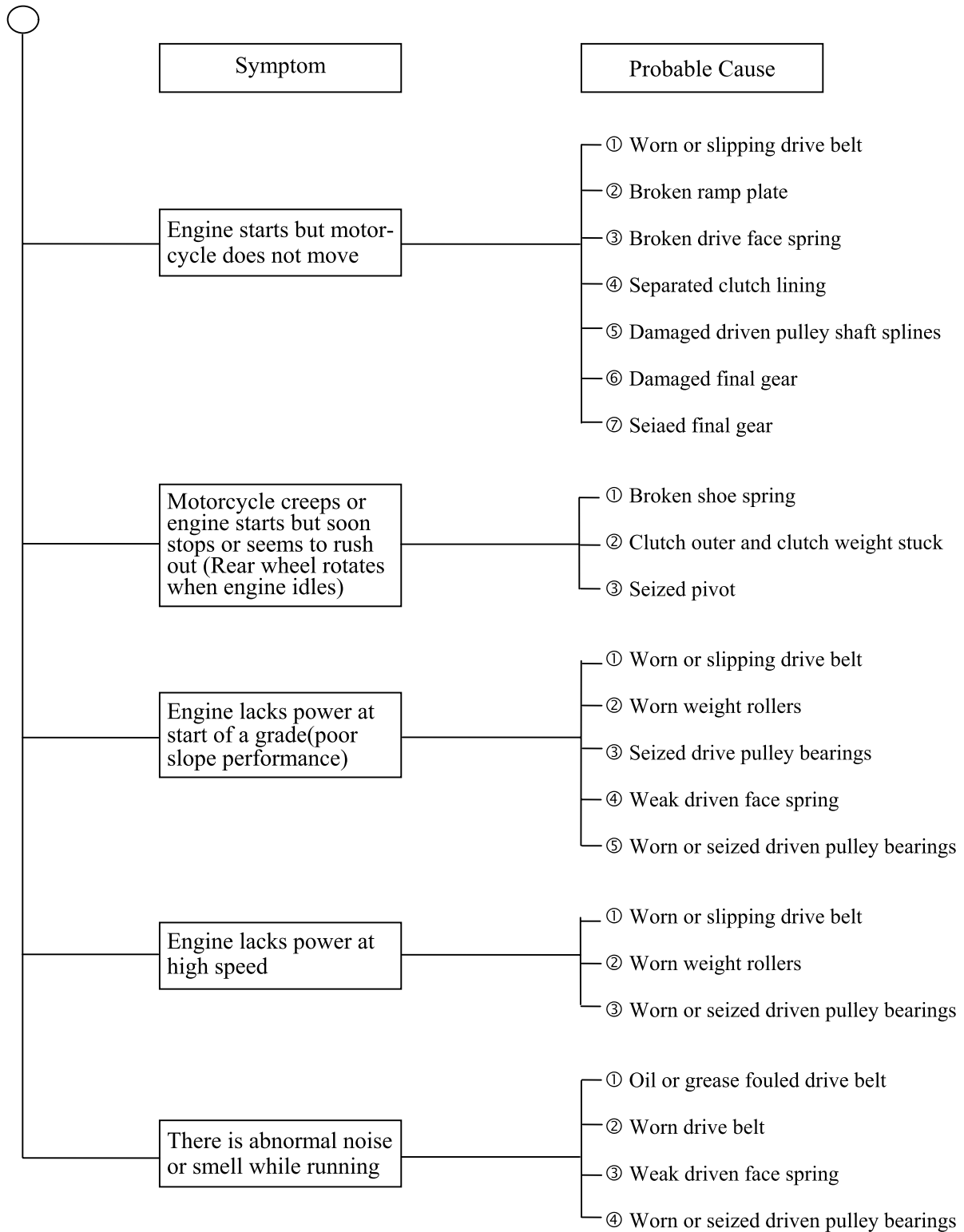

STARTER MOTOR

1. Starter motor won't turn

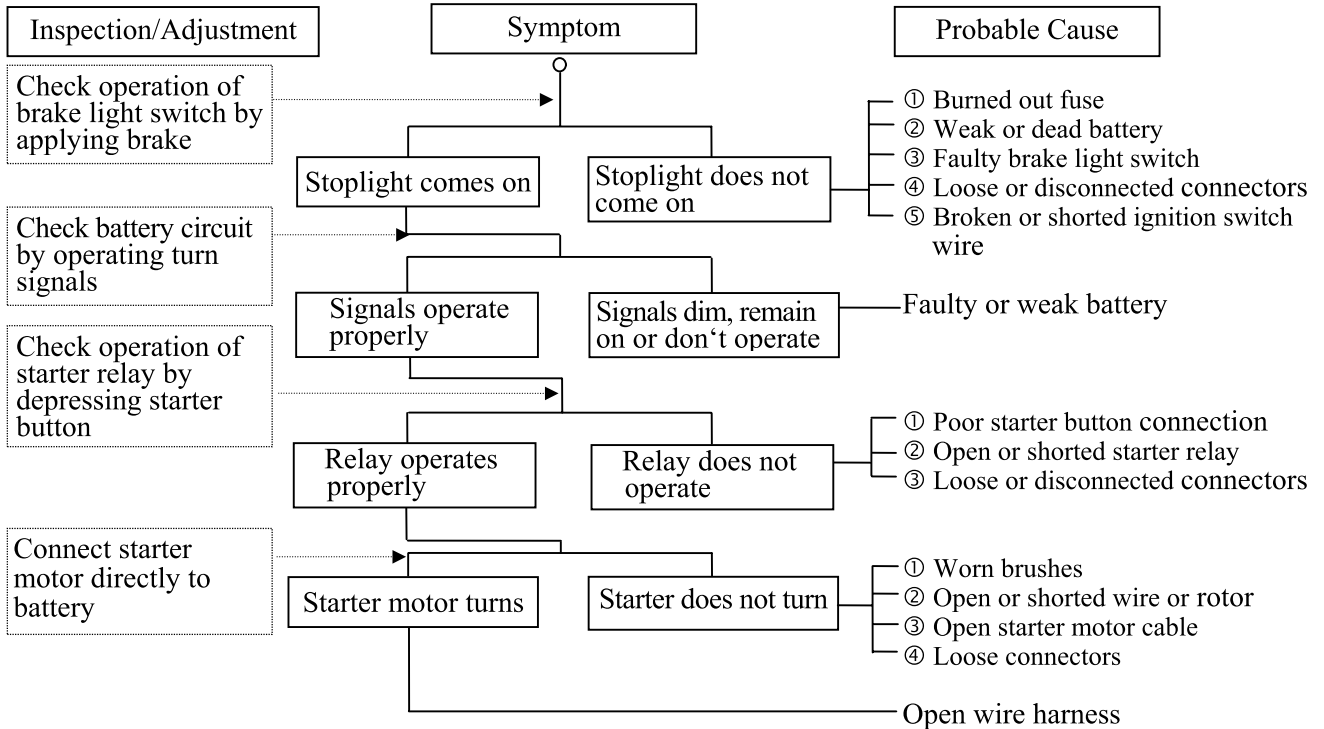

2. Starter motor turns slowly or idles

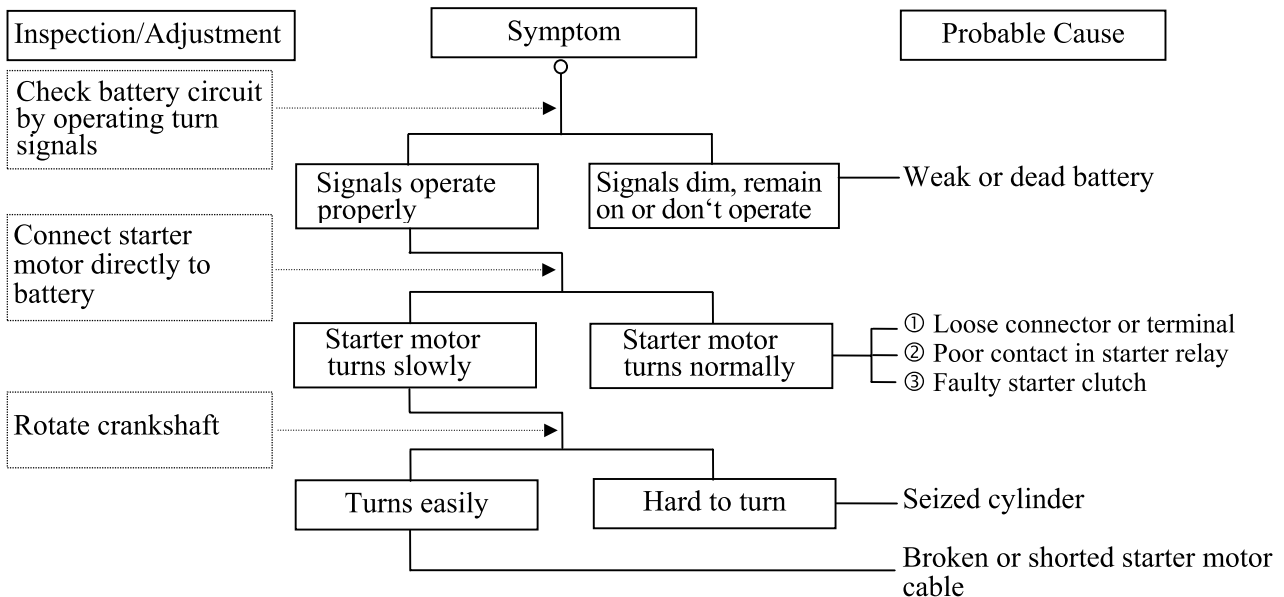

3. Starter motor does not stop turning

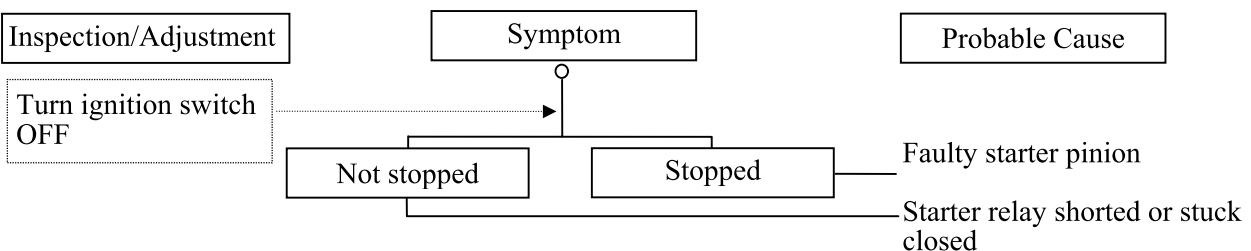

1. GENERAL INFORMATION

NO SPARK AT SPARK PLUG

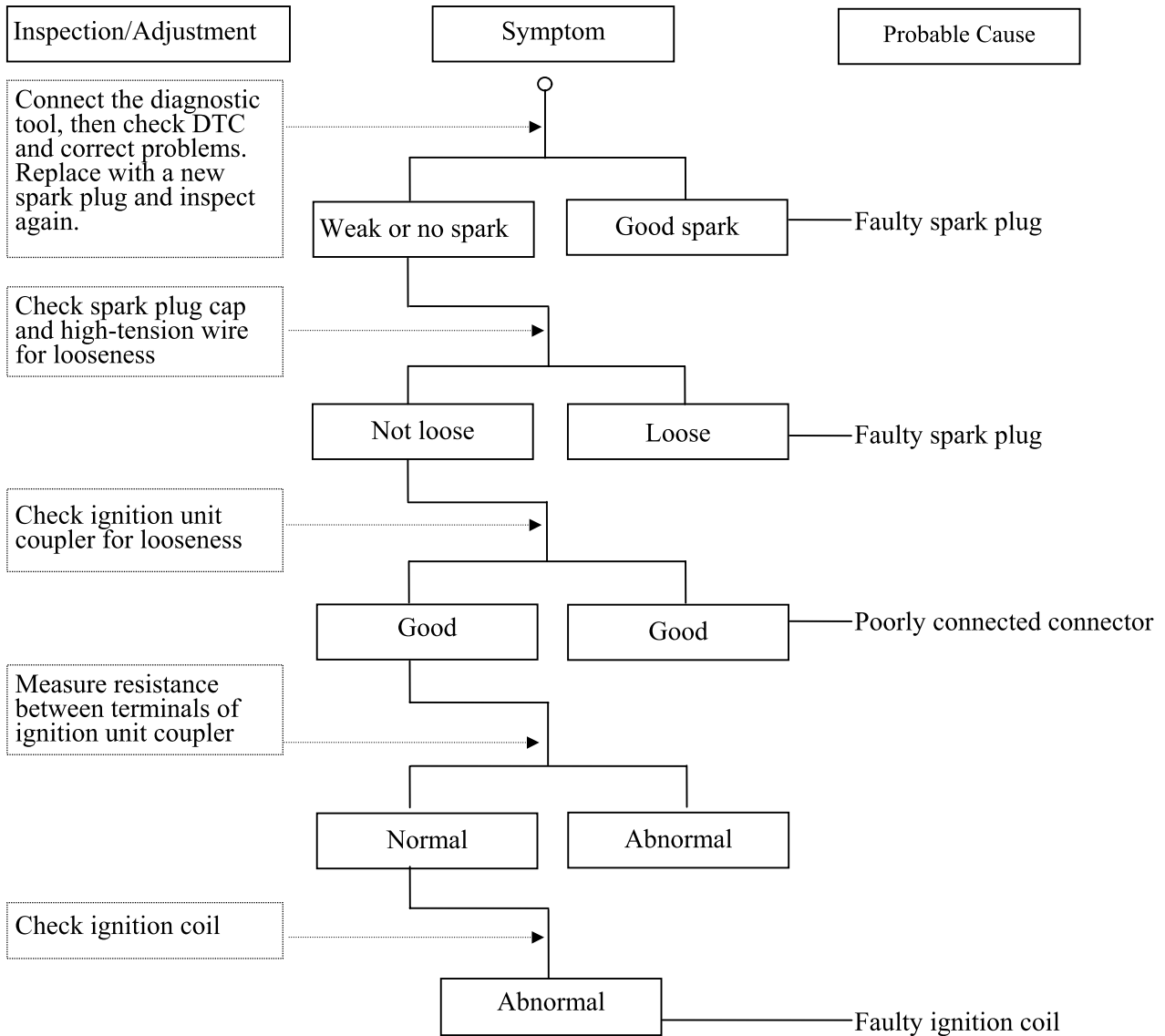

POOR CHARGING (BATTERY OVER DISCHARGING OR OVERCHARGING)

Undercharging

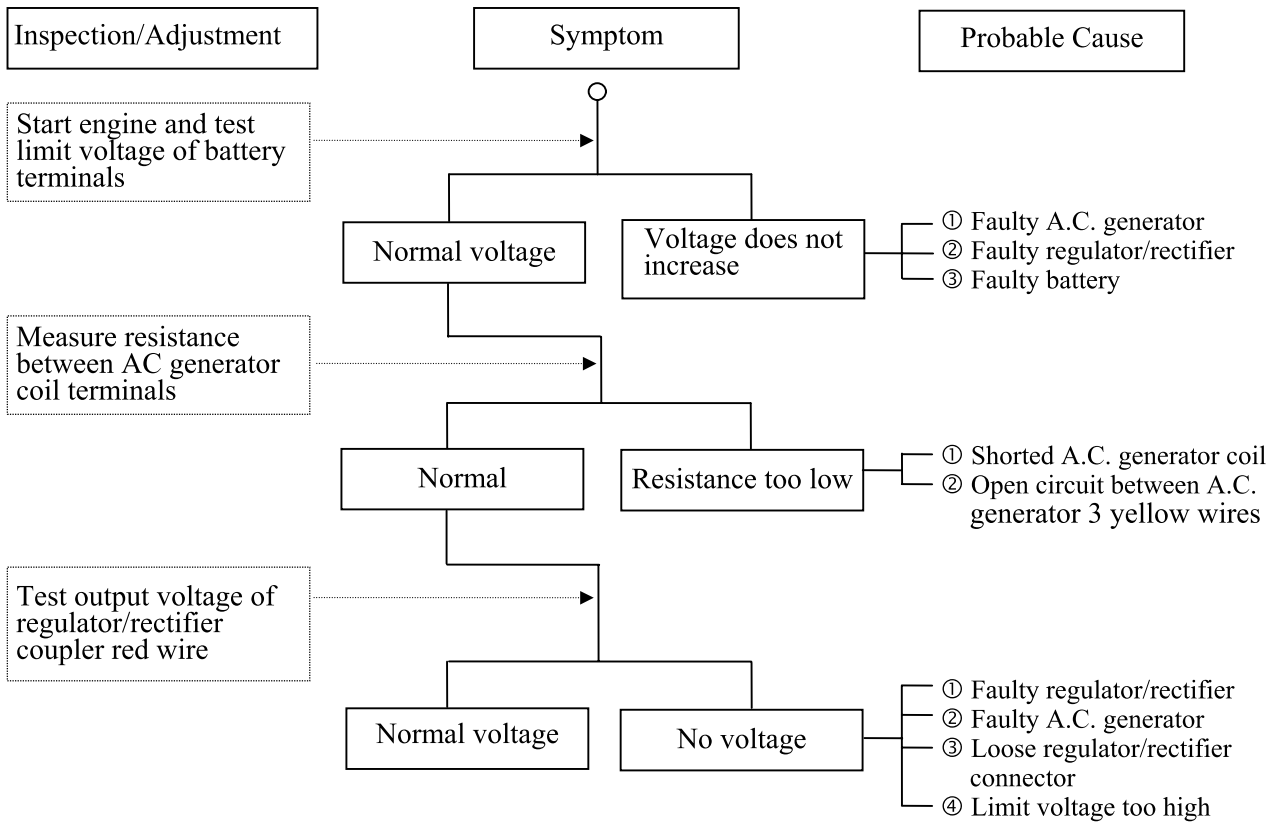

Overcharging

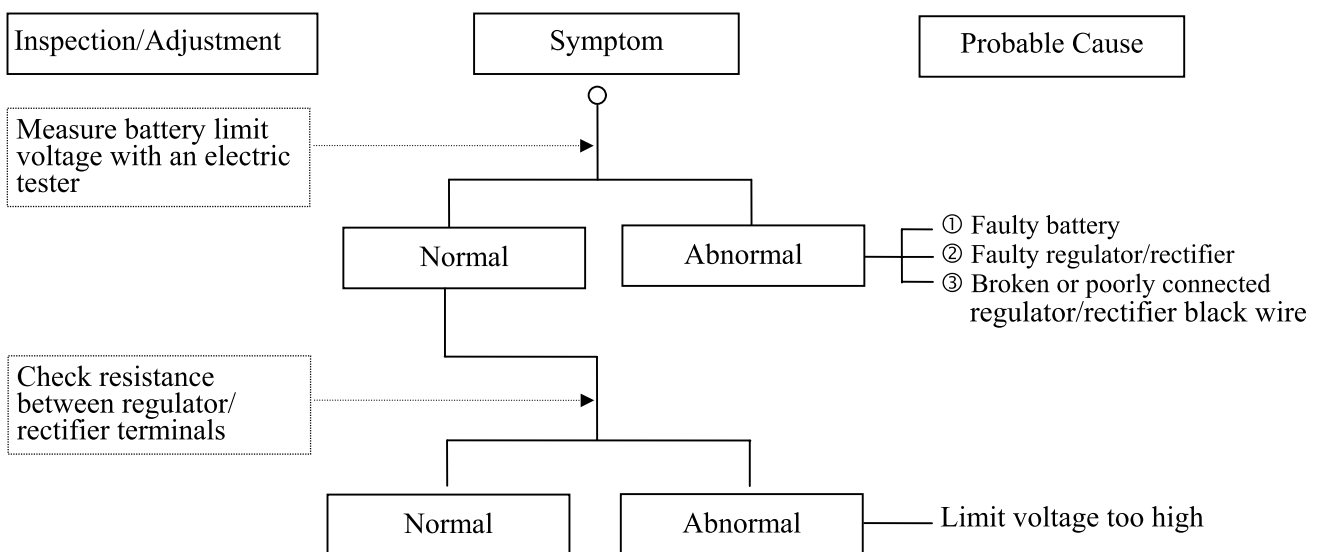

1. GENERAL INFORMATION

FUEL GAUGE

1. Pointer does not register correctly (Ignition switch ON)

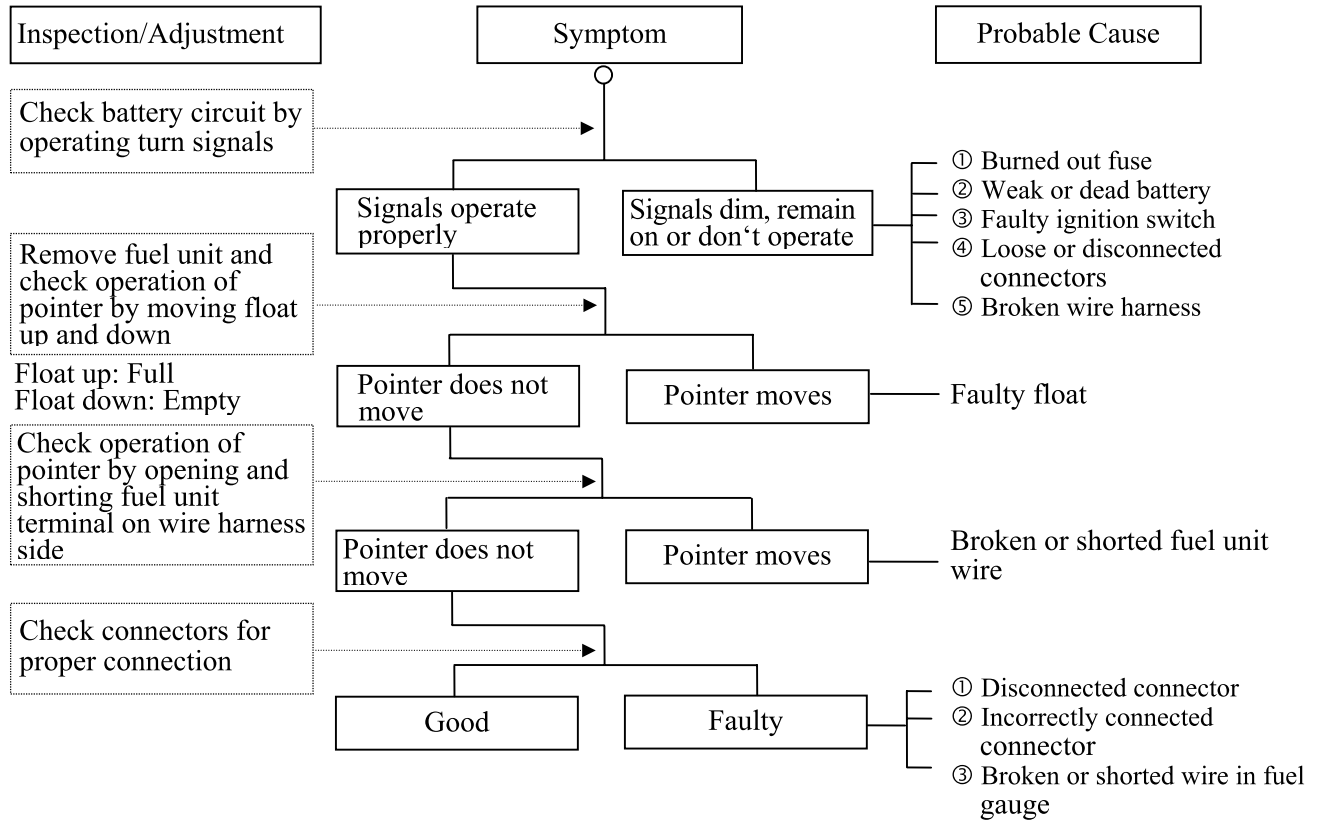

2. Pointer fluctuates or swings (Ignition ON)

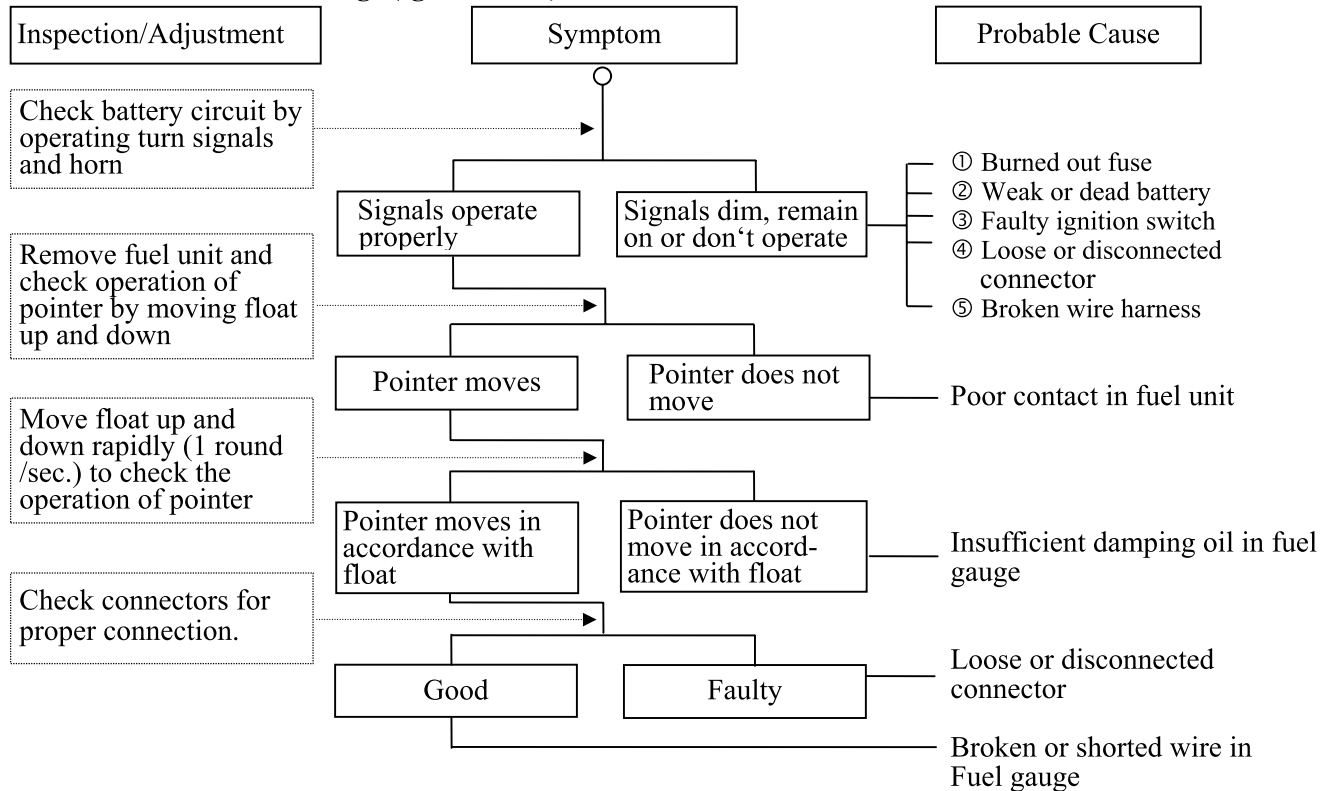

1. GENERAL INFORMATION

DINK200i/125

STEERING HANDLEBAR DOES NOT TRACK STRAIGHT

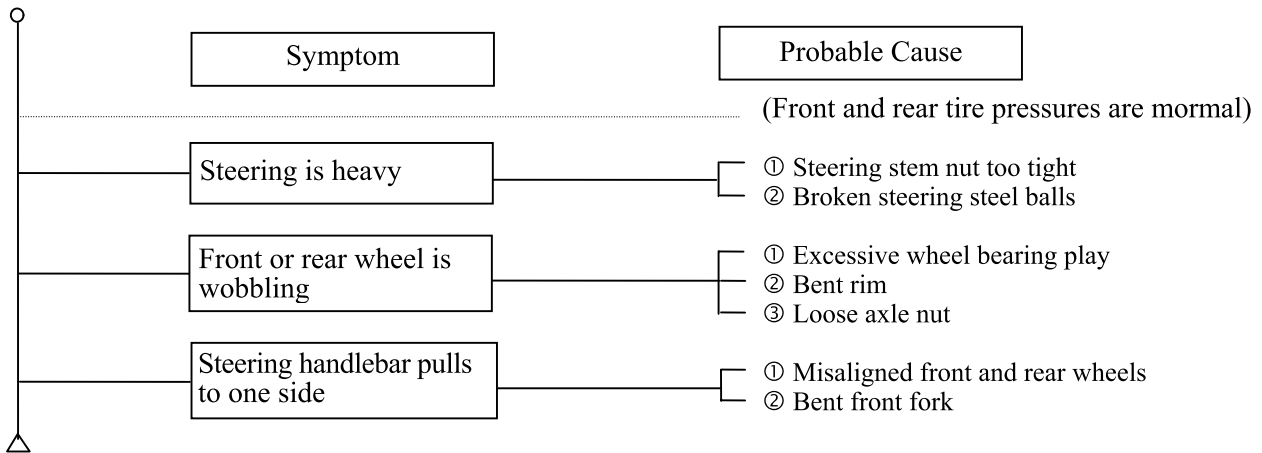

POOR SUSPENSION PERFORMANCE

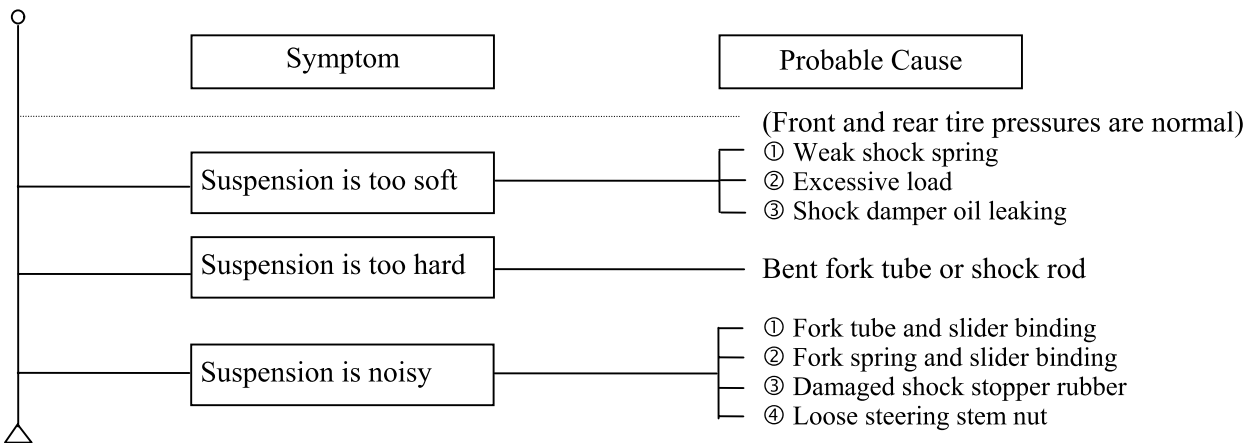

POOR BRAKE PERFORMANCE

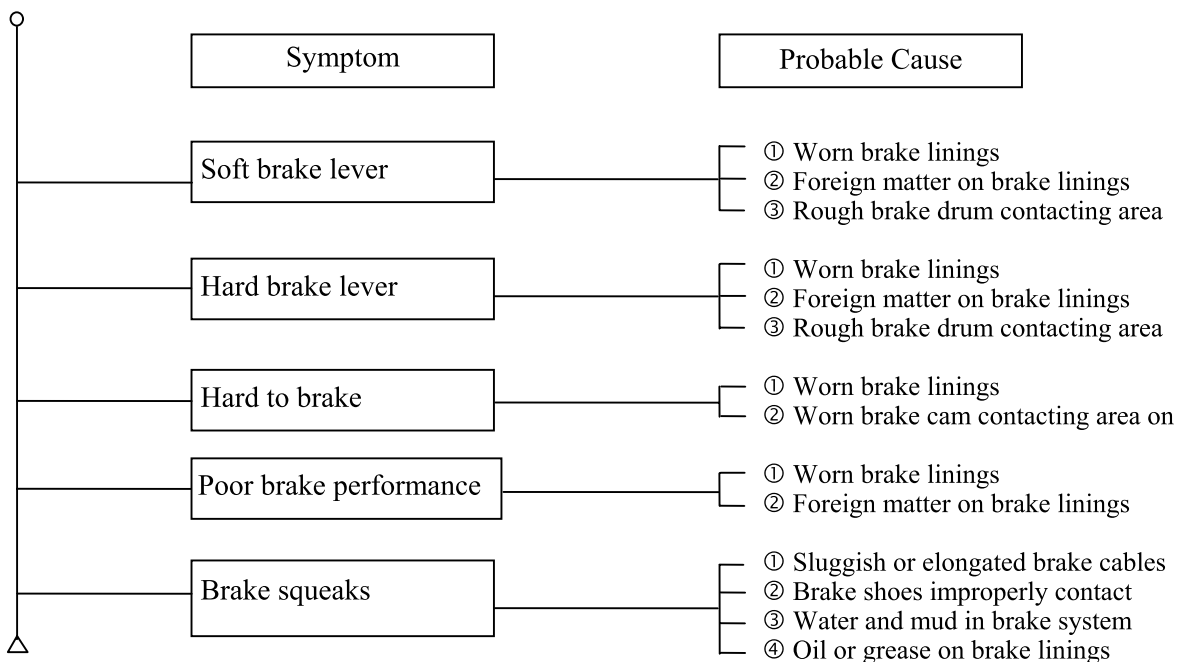

TROUBLESHOOTING (DINK 125)

ENGINE WILL NOT START OR IS HARD TO START

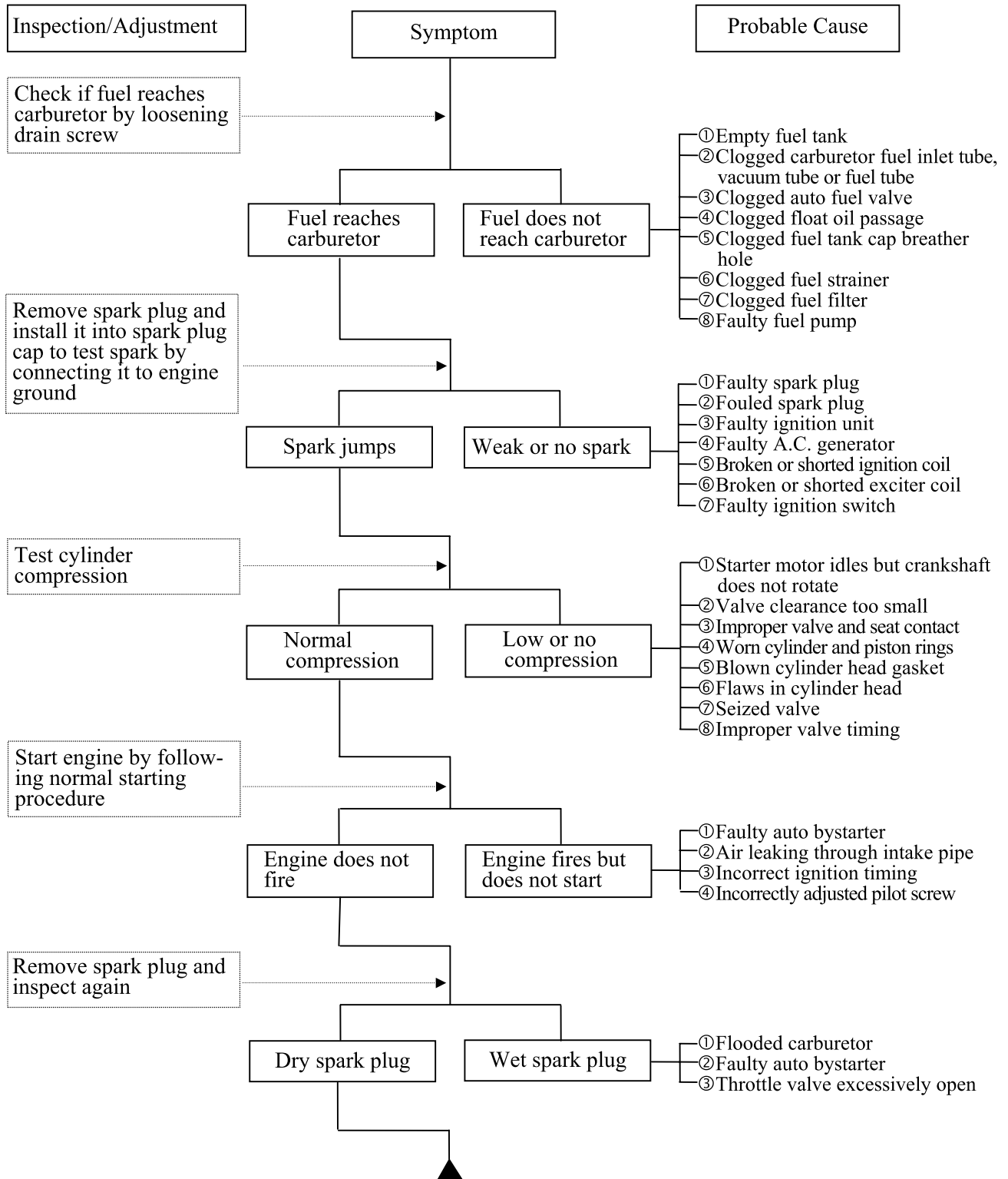

ENGINE LACKS POWER

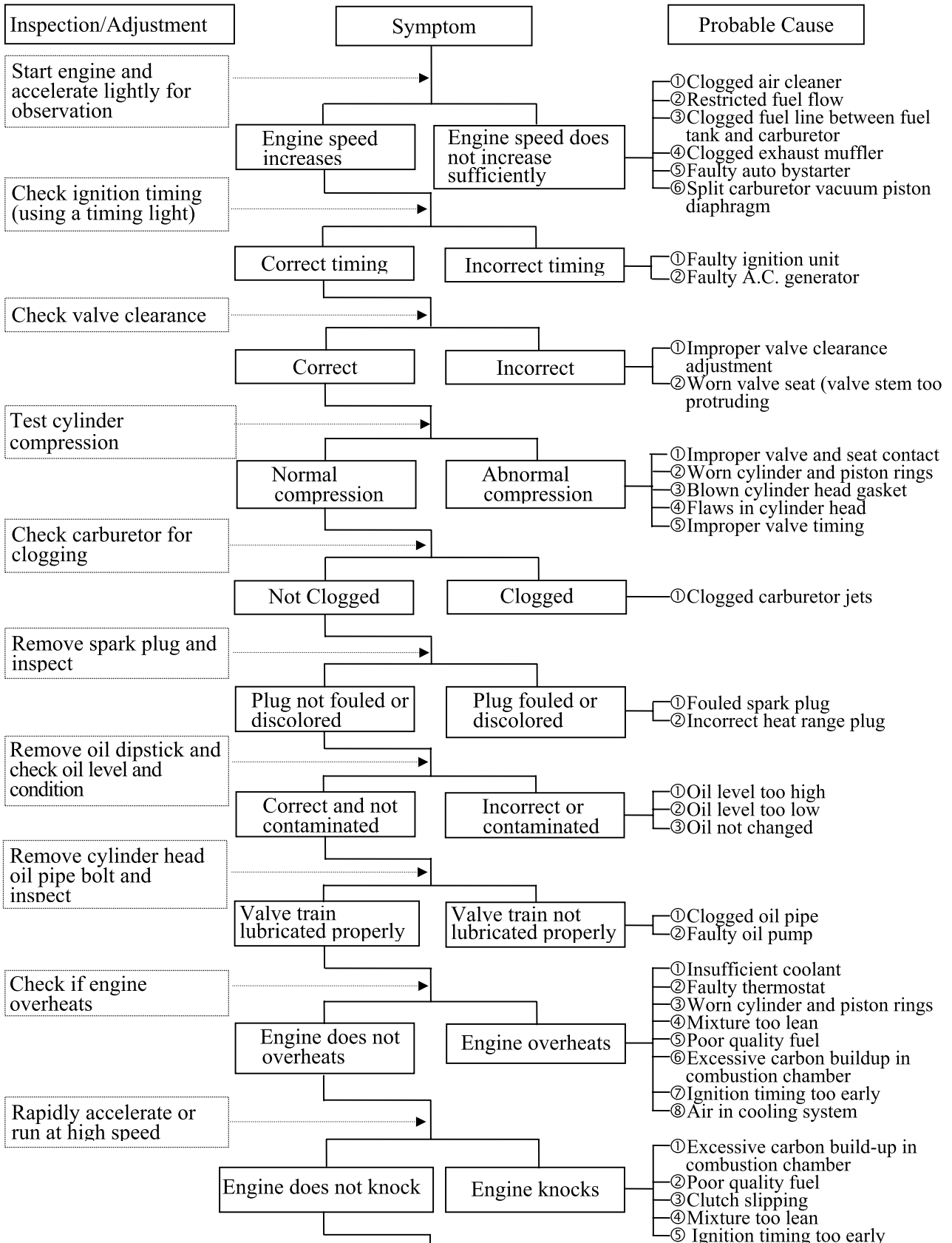

POOR PERFORMANCE (ESPECIALLY AT IDLE AND LOW SPEEDS)

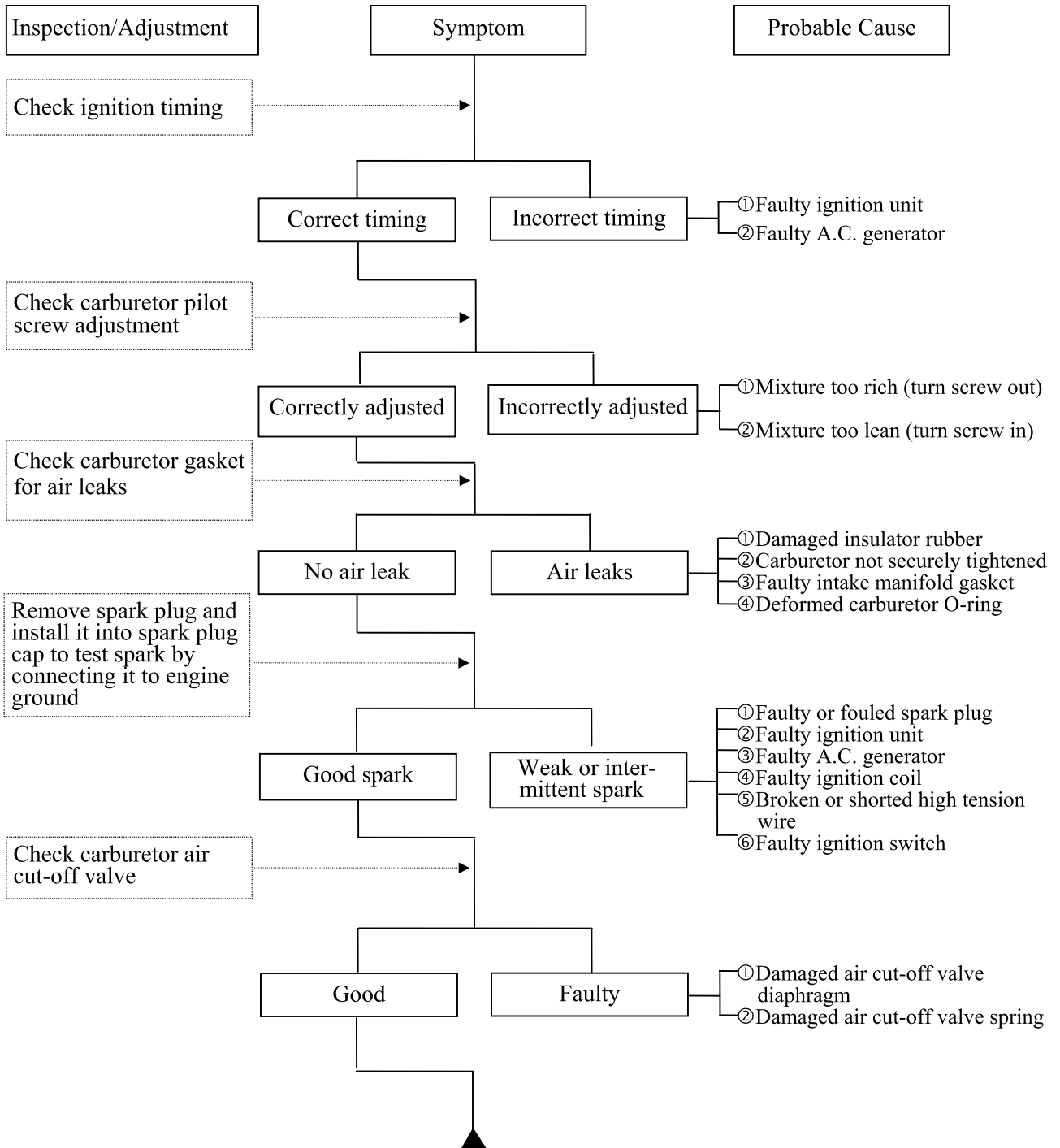

POOR PERFORMANCE (AT HIGH SPEED)

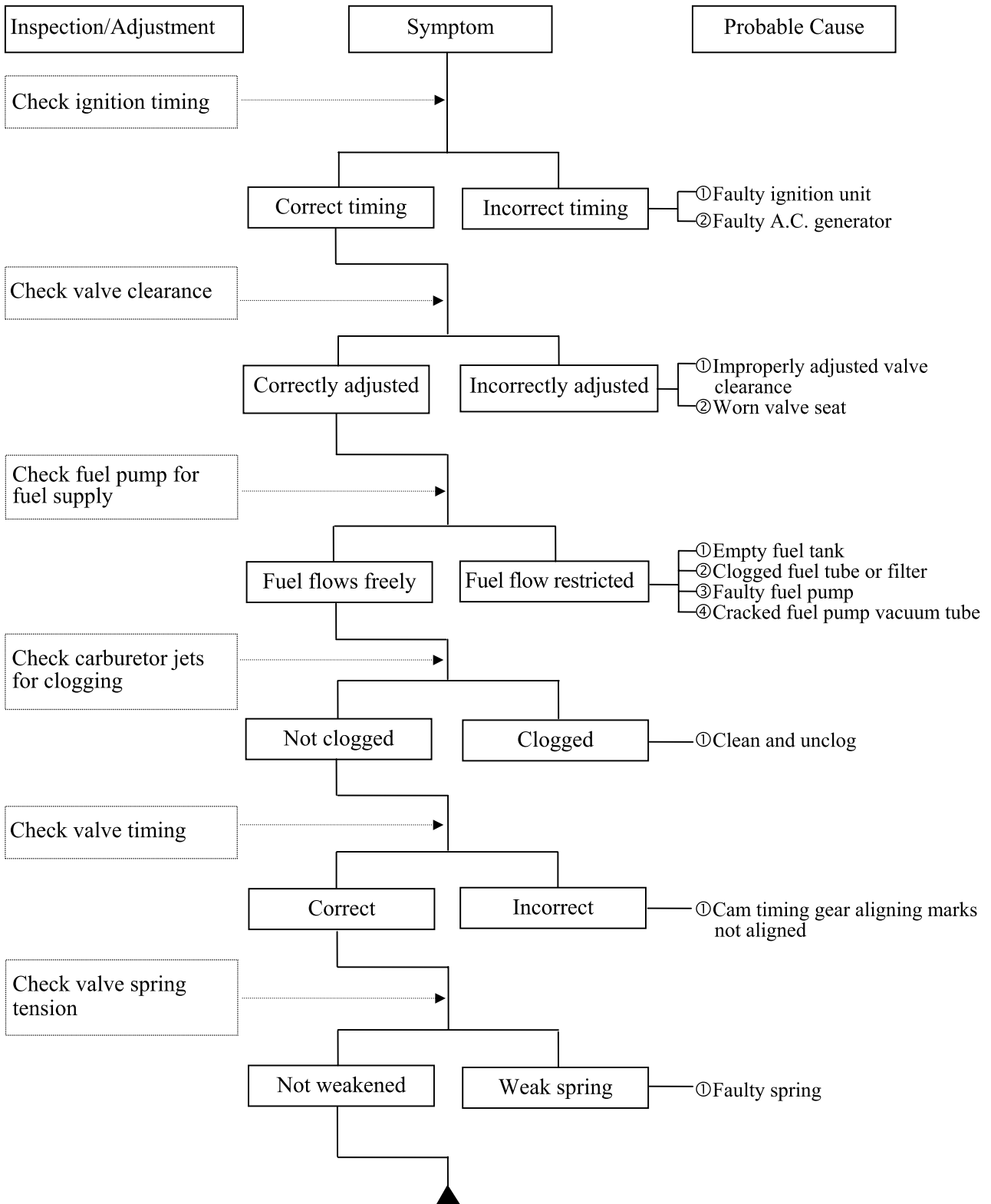

1. GENERAL INFORMATION

ENGINE NOISE

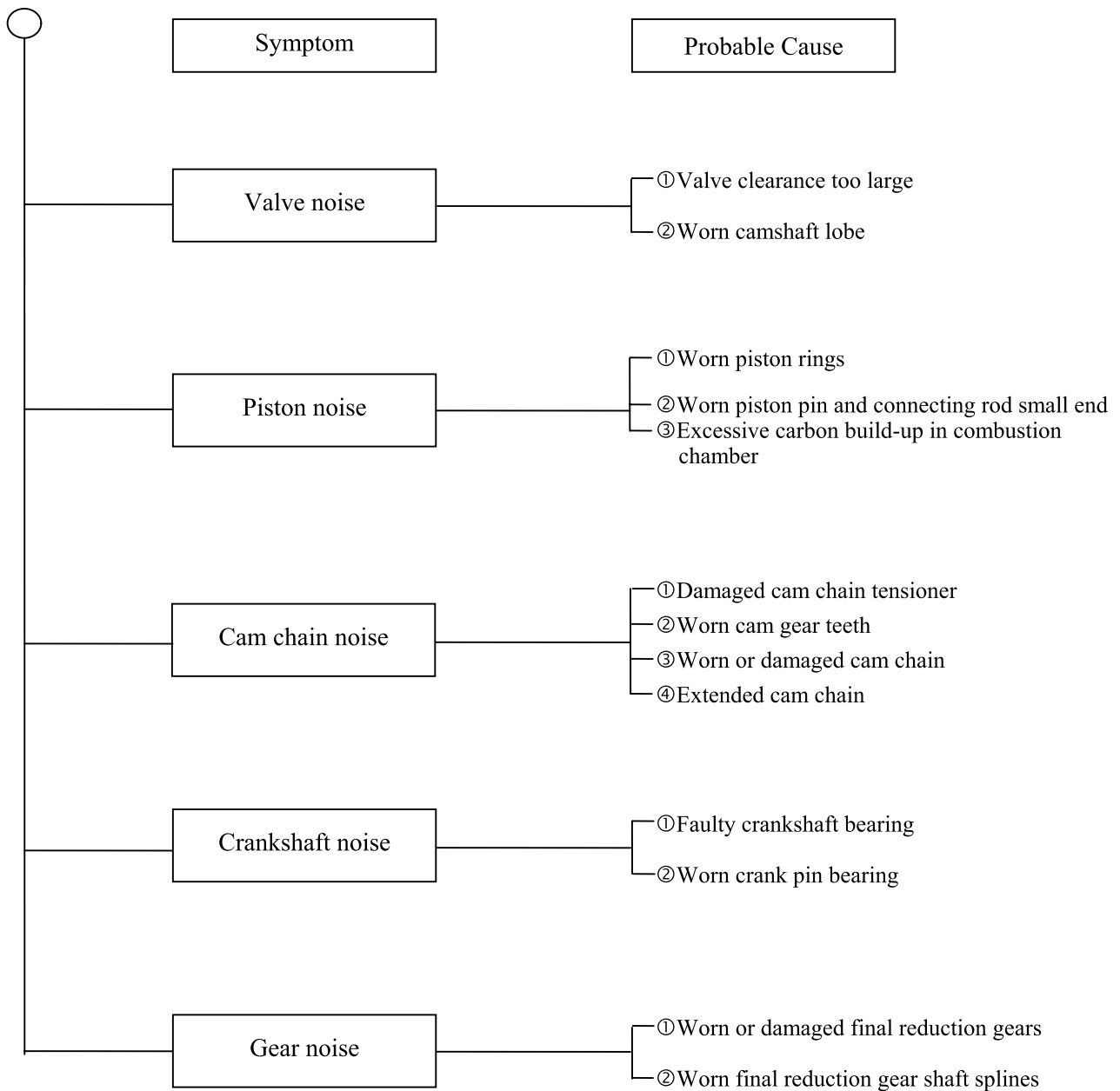

CLUTCH, DRIVE AND DRIVEN PULLEYS

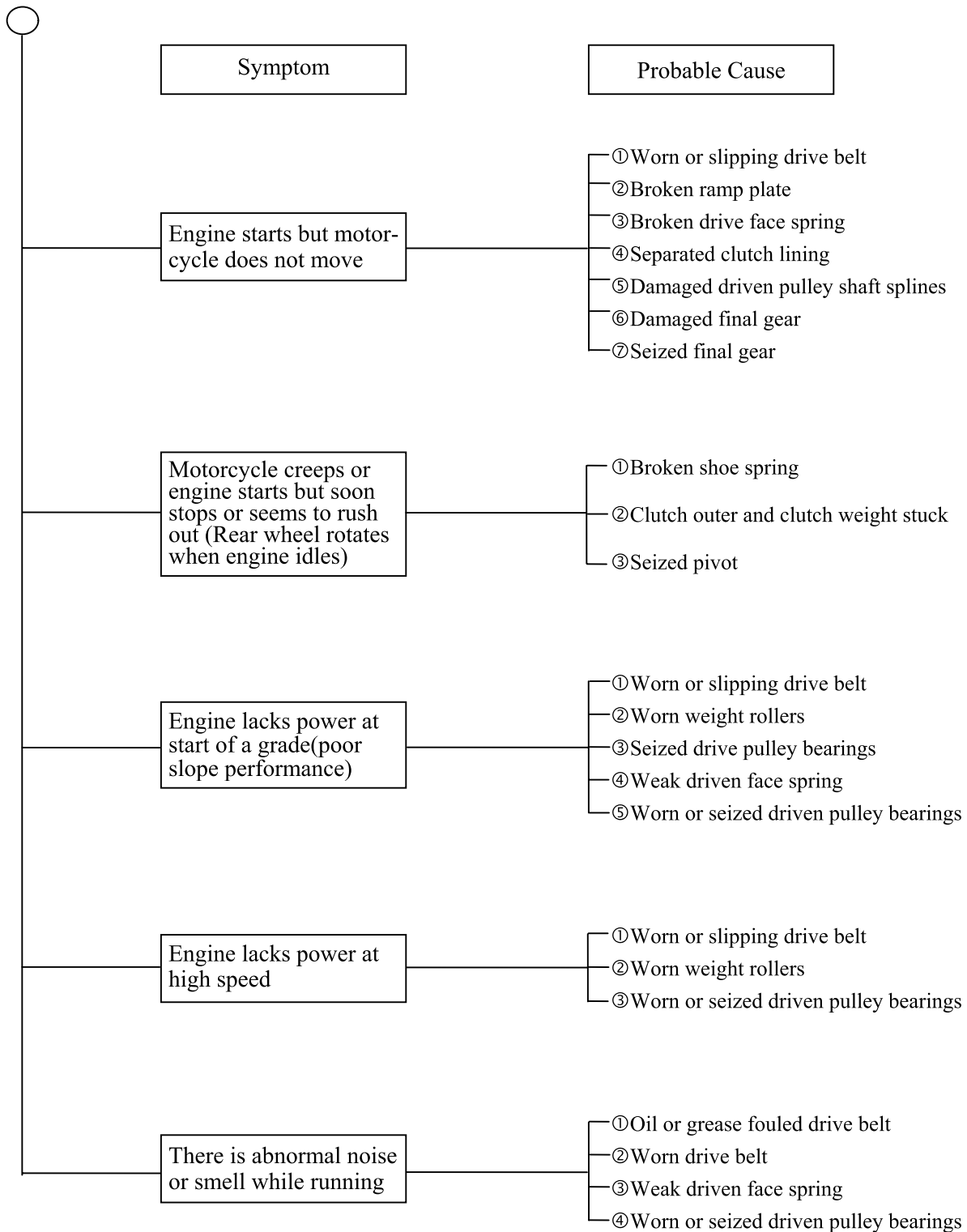

1. GENERAL INFORMATION

STARTER MOTOR

1. Starter motor won't turn

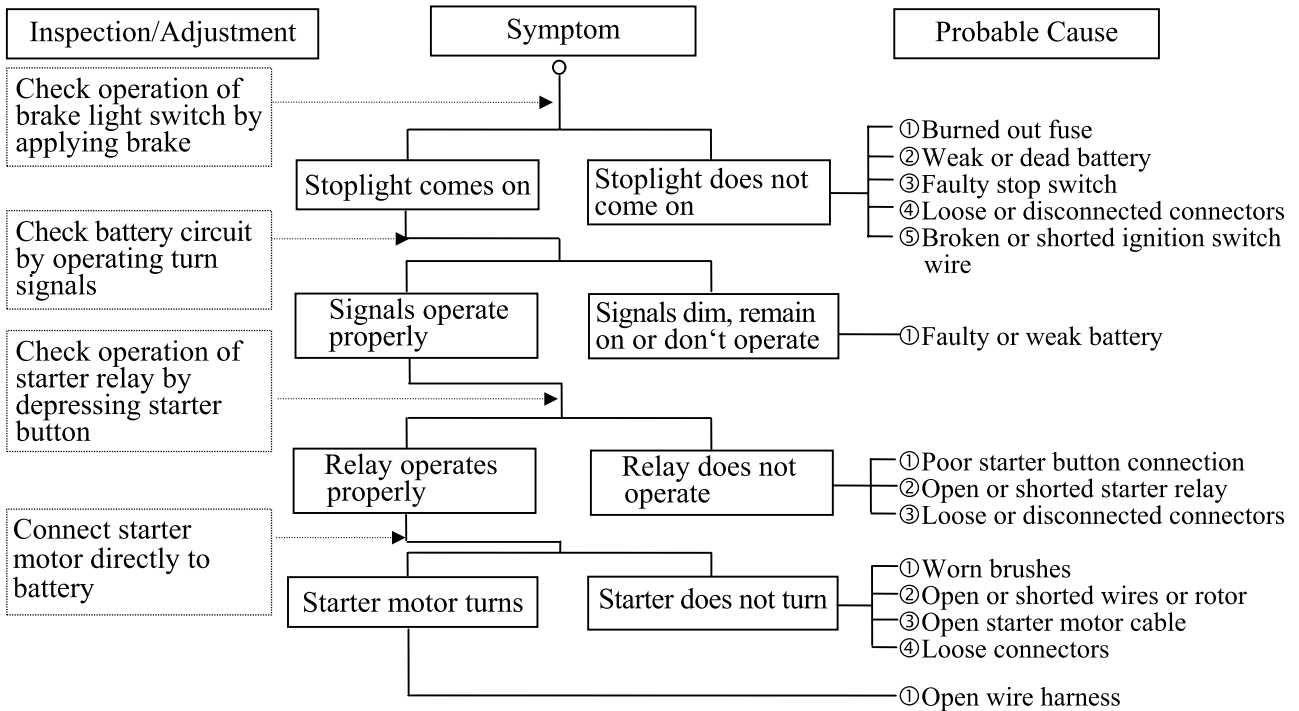

2. Starter motor turns slowly or idles

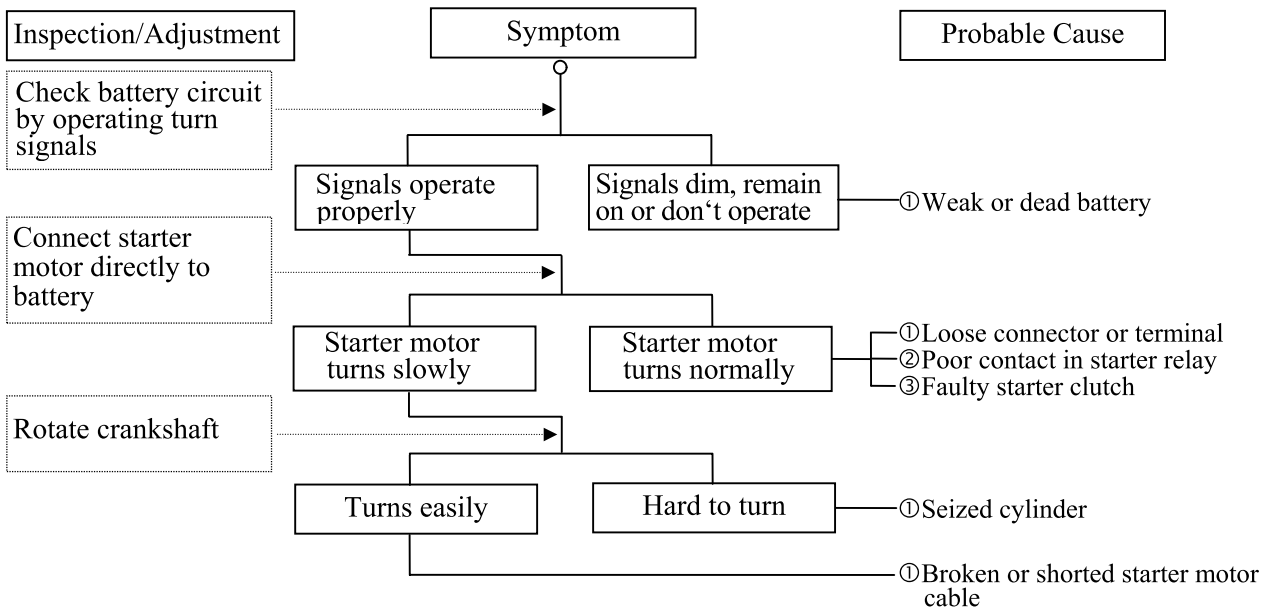

3. Starter motor does not stop turning

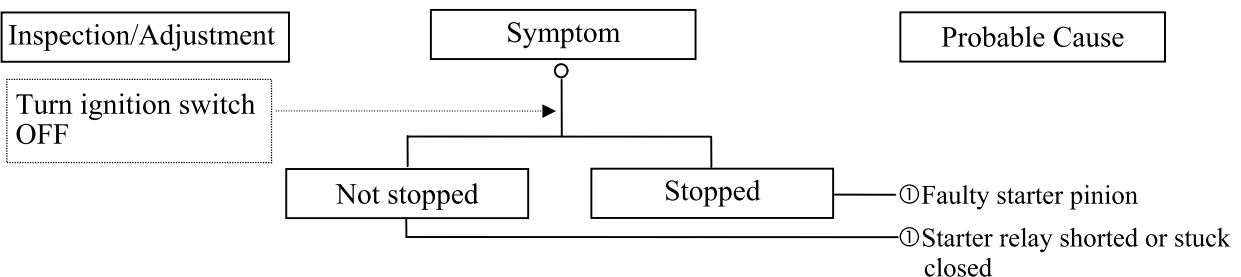

1. GENERAL INFORMATION

NO SPARK AT SPARK PLUG

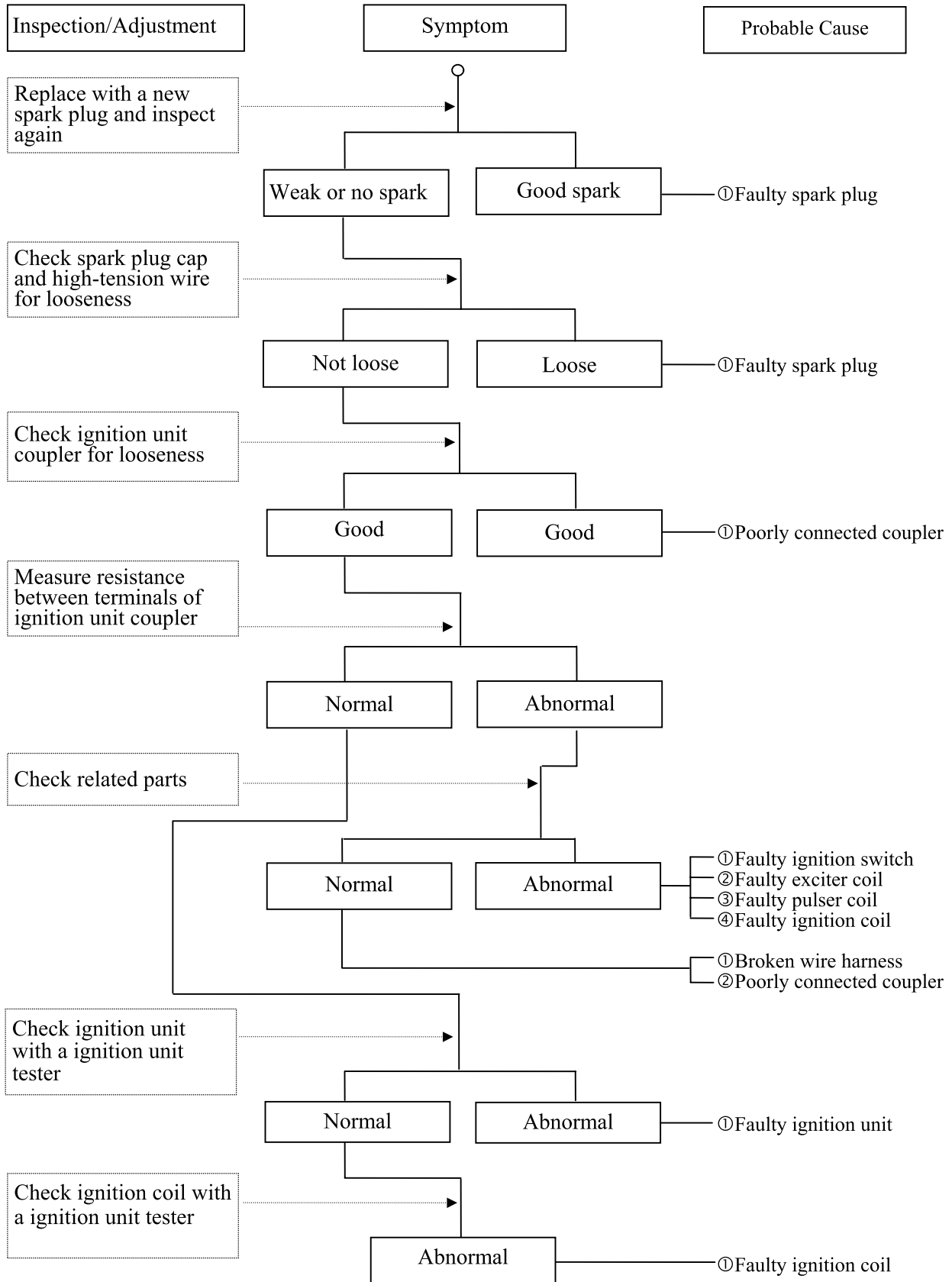

1. GENERAL INFORMATION

POOR CHARGING (BATTERY OVER DISCHARGING OR OVERCHARGING)

Undercharging

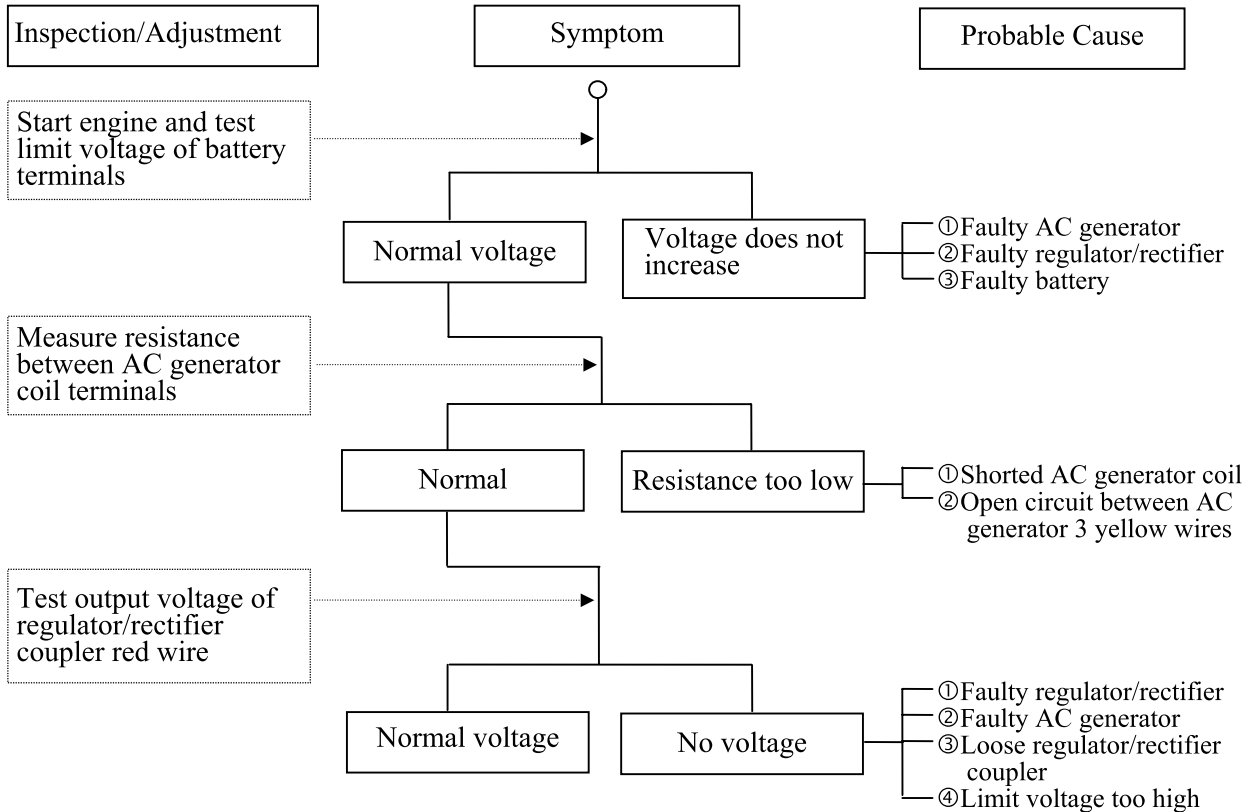

Overcharging

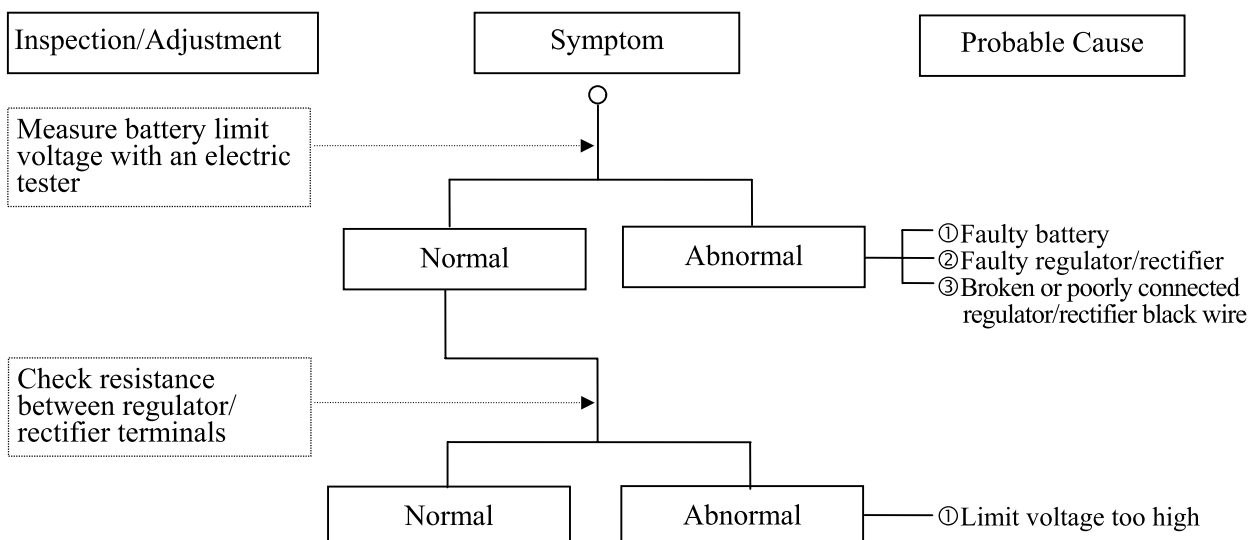

FUEL GAUGE

1. Pointer does not register correctly (Ignition switch ON)

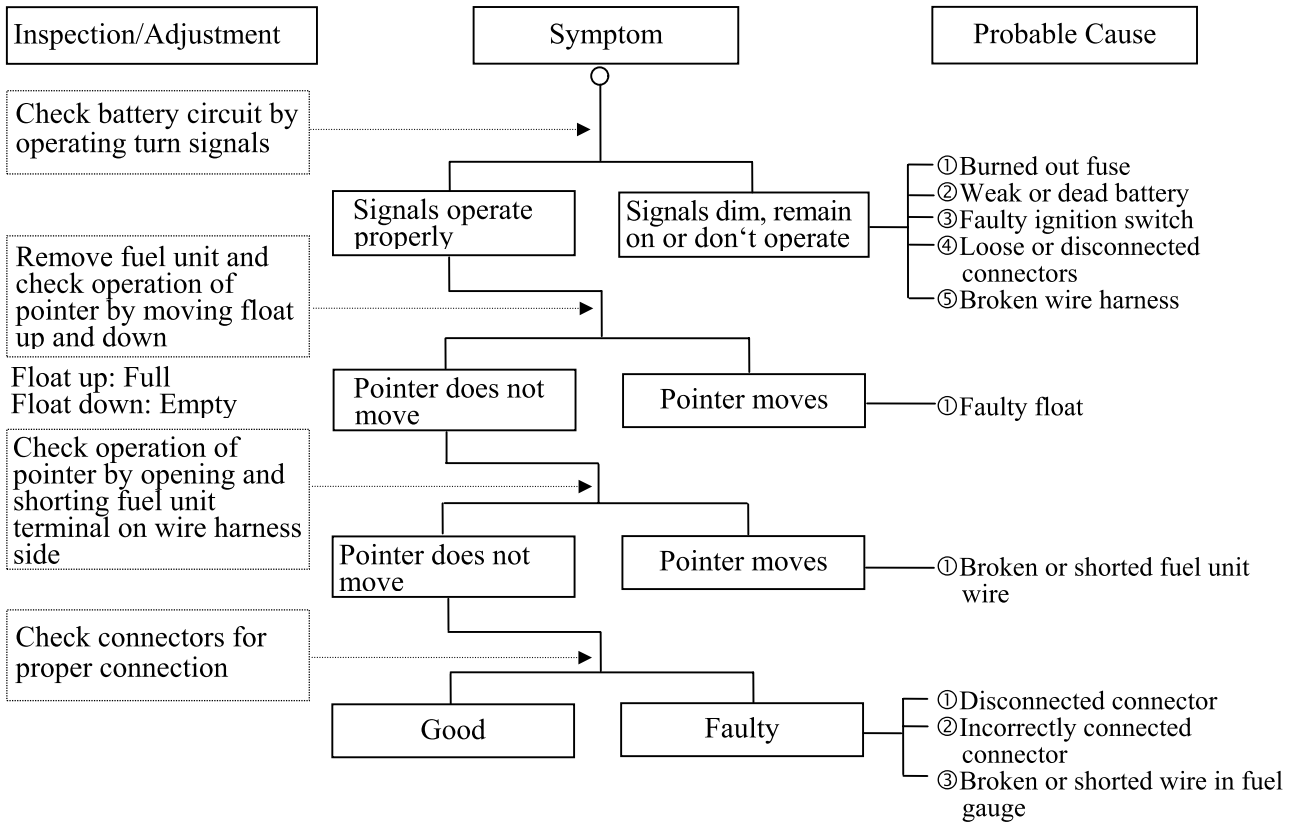

2. Pointer fluctuates or swings (Ignition switch ON)

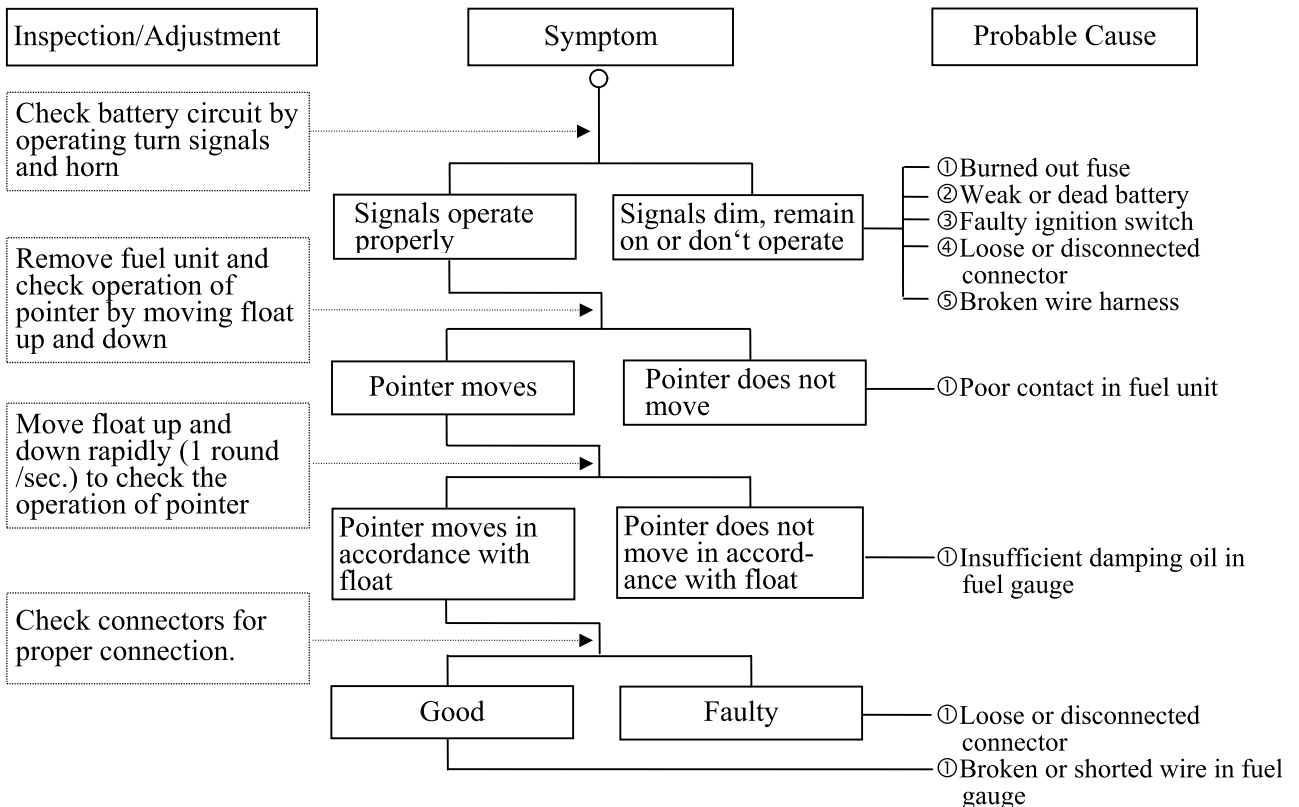

STEERING HANDLEBAR DOES NOT TRACK STRAIGHT

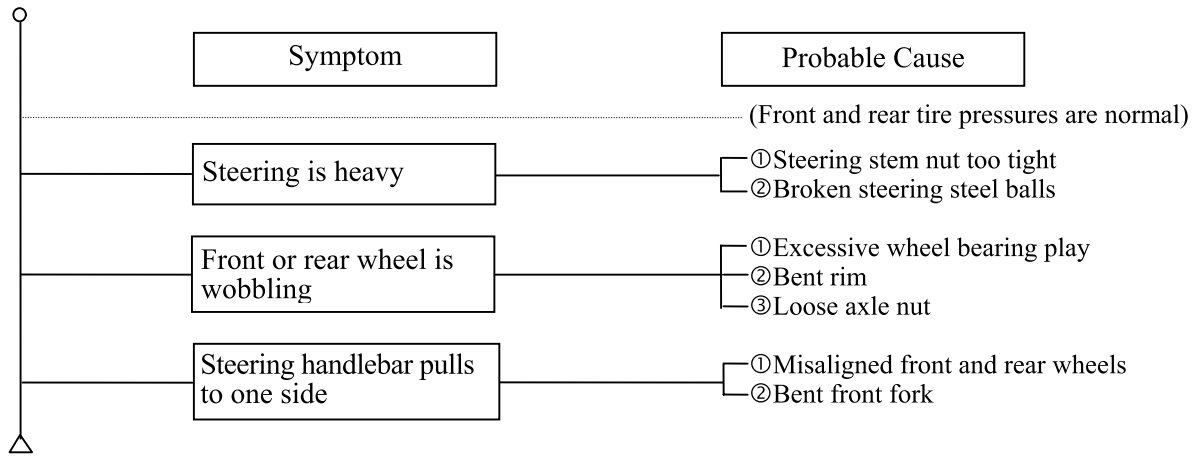

POOR SUSPENSION PERFORMANCE

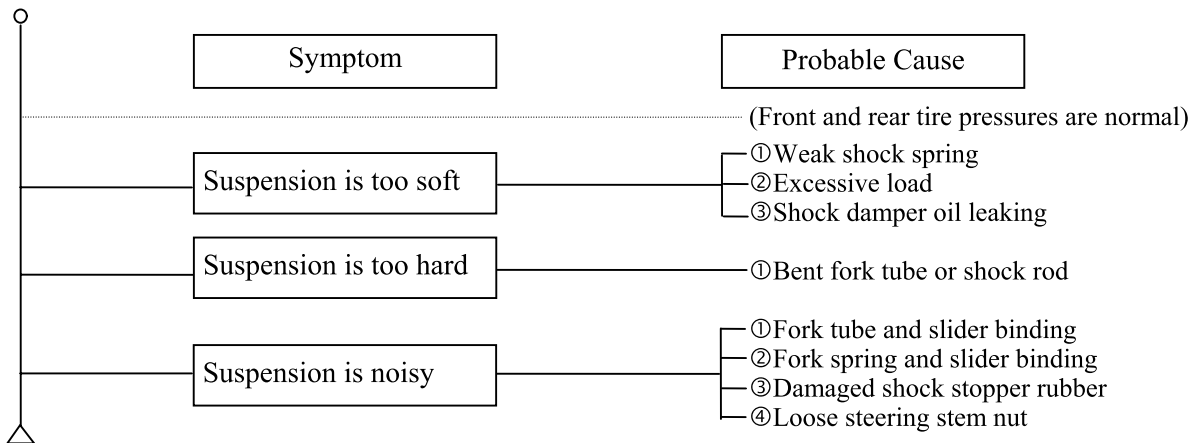

POOR BRAKE PERFORMANCE

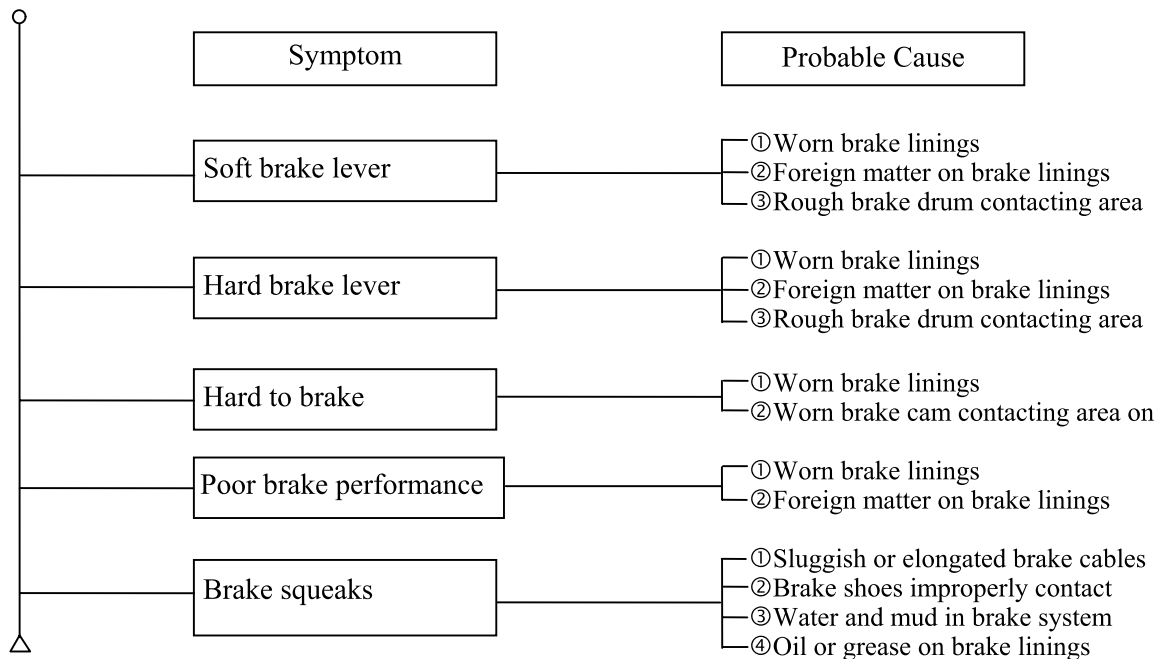

2. EXHAUST MUFFLER/FRAME COVERS

2

EXHAUST MUFFLER/FRAME COVERS

SCHEMATIC DRAWING -----	2- 1
SERVICE INFORMATION-----	2- 2
TROUBLESHOOTING-----	2- 2
FASTENER REMOVAL AND REINSTALLATION-----	2- 3
FRAME COVERS REMOVAL/INSTALLATION-----	2- 4
EXHAUST MUFFLER -----	2-15

2. EXHAUST MUFFLER/FRAME COVERS

DINK 200i/125

SCHEMATIC DRAWING

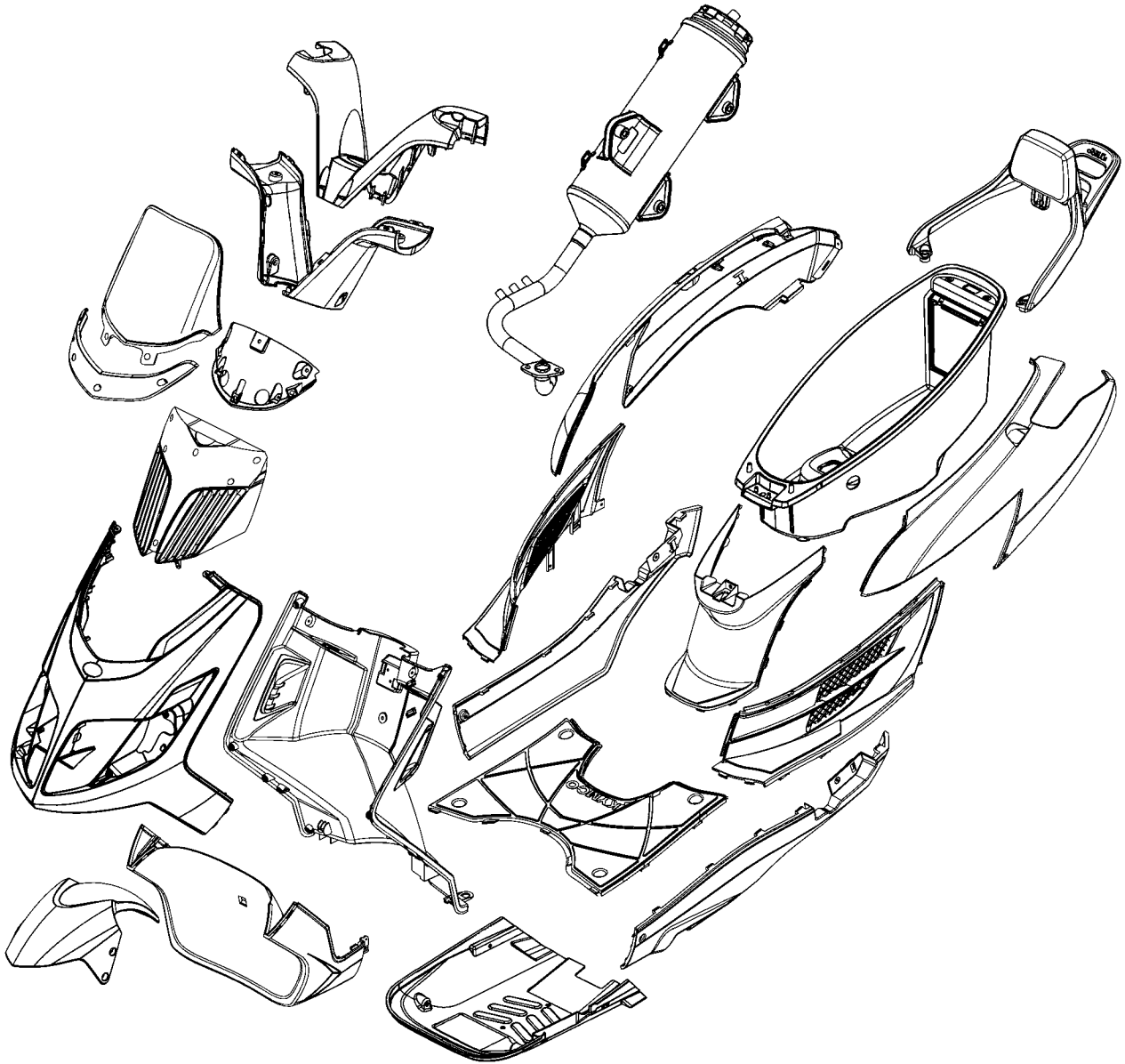

2. EXHAUST MUFFLER/FRAME COVERS

SERVICE INFORMATION

GENERAL INSTRUCTIONS

- When removing frame covers, use care not to pull them by force because the cover joint claws may be damaged.
- Make sure to route cables and harnesses according to the Cable & Harness Routing.

TORQUE VALUES

Exhaust muffler mounting bolt	3.3 kgf-m (33 N-m, 24m lbf-ft)
Exhaust muffler mounting nut	2 kgf-m (20 N-m, 14 lbf-ft)

TROUBLESHOOTING

Noisy exhaust muffler

- Damaged exhaust muffler
- Exhaust muffler joint air leaks

Lack of power

- Caved exhaust muffler
- Clogged exhaust muffler
- Exhaust muffler air leaks

FASTENER REMOVAL AND REINSTALLATION

REMOVAL

Depress the head of fastener center piece ①.
Pull out the fastener.

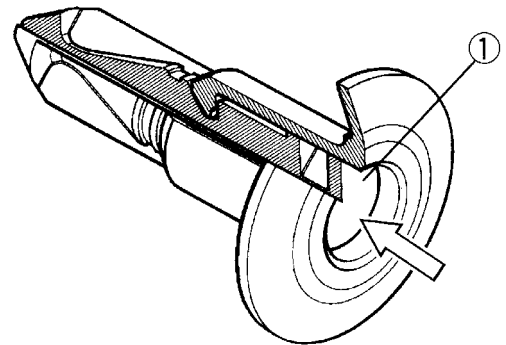

INSTALLATION

Let the center piece stick out toward the head so that the pawls ② close.
Insert the fastener into the installation hole.

- To prevent the pawl ② from damage, insert the fastener all the way into the installation hole

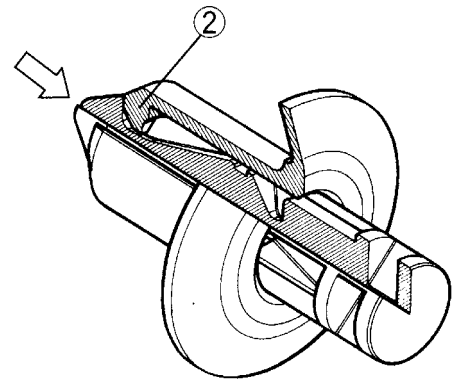

Push in the head of center piece until it becomes flush with the fastener outside face.

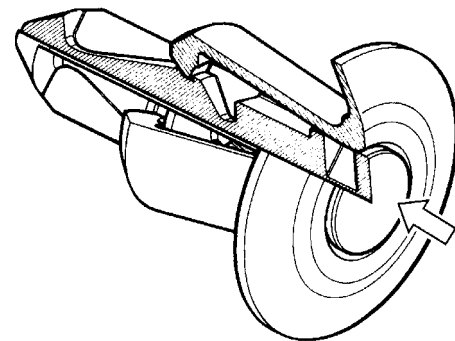

2. EXHAUST MUFFLER/FRAME COVERS

FRAME COVERS REMOVAL/ INSTALLATION

SEAT

Unlock the seat with the ignition key.
Open the seat.

Remove the two nuts and the seat.

Installation is in the reverse order of removal.



LUGGAGE BOX

Unlock the seat with the ignition key.
Open the seat.

Remove the screw and four bolts, then lift
luggage box.

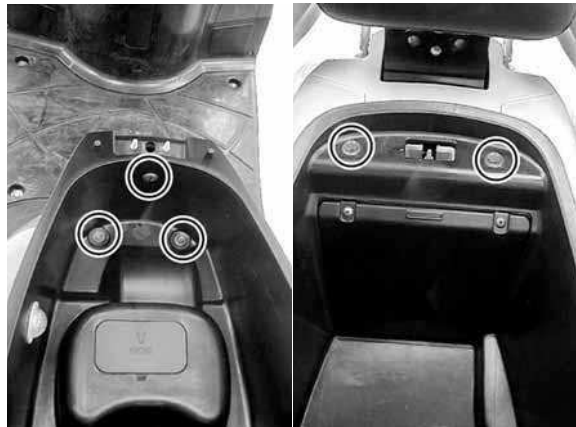

Disconnect the luggage box light connector,
then remove the luggage box.

Installation is in the reverse order of removal.

Luggage Box Light Connector



2. EXHAUST MUFFLER/FRAME COVERS

DINK 200i/125

CENTER COVER

Remove the luggage box (see page 2-4).

Remove the center cover.

- During removal, do not pull the joint claws forcedly to avoid damage.

Installation is in the reverse order of removal.

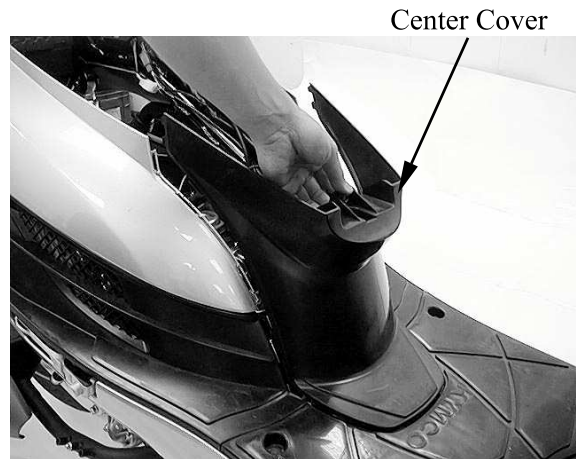

REAR SPOILER/REAR SPOILER STAY

Unlock the seat with the ignition key.
Open the seat.

Remove the three bolts.



Remove the bolt, then remove the rear spoiler.



2. EXHAUST MUFFLER/FRAME COVERS

Remove the two bolts and rear spoiler stay.

Installation is in the reverse order of removal.



UPPER/LOWER HANDLEBAR COVER

Remove the six screws.



Remove the two screws, then remove the upper handlebar cover.

Disconnect the throttle cable (DINK 125: refer to the “**CARBURETOR**” section in the chapter 13. DINK 200i: refer to the “**THROTTLE BODY /TPS**” section in the chapter 14), then pull the throttle cable out from the lower cover.

Remove the lower cover.

Installation is in the reverse order of removal.



2. EXHAUST MUFFLER/FRAME COVERS

DINK 200i/125

WINDSHIELD/WINDSHIELD GARNISH

Remove the three bolts and windshield garnish.



Remove the two screws.



Remove the two screws from the inner cover, then remove the windshield.

Installation is in the reverse order of removal.



2. EXHAUST MUFFLER/FRAME COVERS

FRONT METER VISOR

Remove the windshield (see page 2-7).

Remove the three fasteners and two screws, then remove the front meter visor.

Installation is in the reverse order of removal.



FRONT COVER

Remove the front meter visor (see page 2-8).

Remove the two screws and two nuts.



Remove the ten screws from the inner cover.
Remove the front cover



2. EXHAUST MUFFLER/FRAME COVERS

DINK 200i/125

Disconnect the headlight/position light connect and right/left turn signal light connectors.

Installation is in the reverse order of removal.



FRONT FENDER

Remove the four screws and front fender.

Installation is in the reverse order of removal.



RIGHT/LEFT FOOT SKIRT

Kick the button and make the passenger footpeg out.

Remove the two screws and right or left foot skirt.

- During removal, do not pull the joint claws forcedly to avoid damage.

Installation is in the reverse order of removal.



2. EXHAUST MUFFLER/FRAME COVERS

FRONT LOWER COVER

Remove the front cover (see page 2-8).
Remove the foot skirt (see page 2-9).

Remove the six screws and front lower cover.

Installation is in the reverse order of removal.

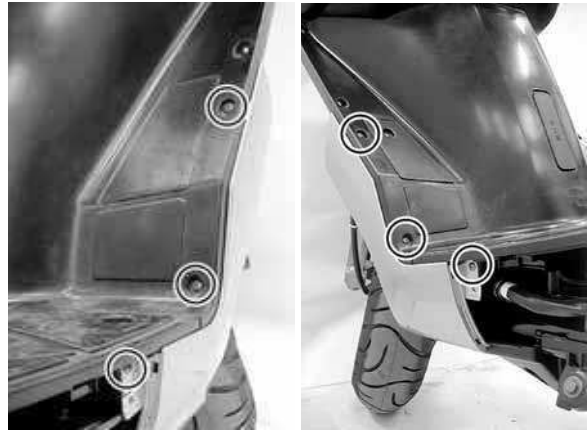

REAR FENDER

Remove the two bolts and two nuts, then
remove the rear fender.

Installation is in the reverse order of removal.



BODY COVER

Remove the center cover (see page 2-5).
Remove the right and left foot skirts (see
page 2-9).
Remove the rear fender (see page 2-10).
Remove the rear spoiler and rear spoiler stay
(see page 2-5).

Remove the two screws, then remove the
body cover.



2. EXHAUST MUFFLER/FRAME COVERS

DINK 200i/125

Disconnect the rear combination light connector.

Installation is in the reverse order of removal.

Rear Combination Light Connector



REAR COMBINATION LIGHT UNDER COVER

Remove body cover (see page 2-10).

Remove the two bolts and rear combination light under cover.

Installation is in the reverse order of removal.

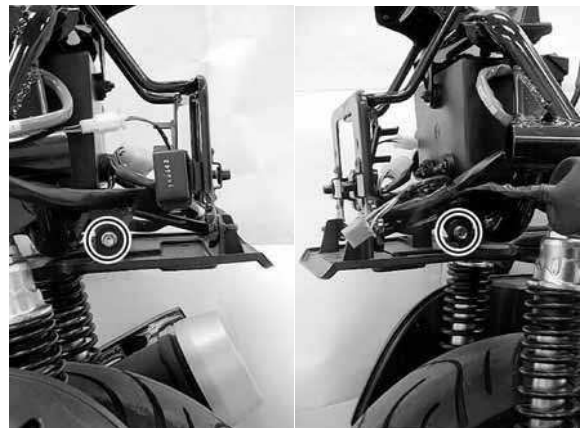

FLOORBOARD

Remove the body cover (see page 2-10).
Remove the front lower cover (see page 2-10).

Remove the two screws.

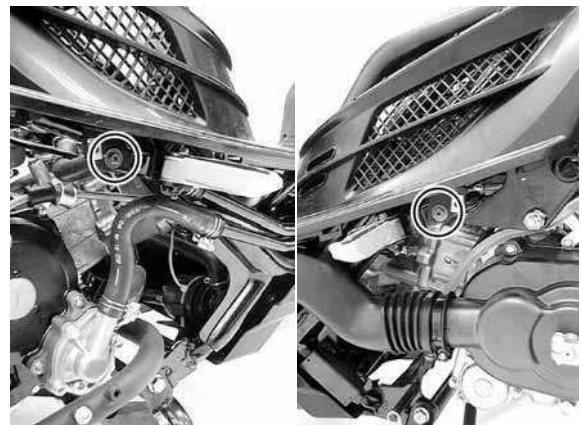

2. EXHAUST MUFFLER/FRAME COVERS

Remove the four bolts, then remove the floorboard.

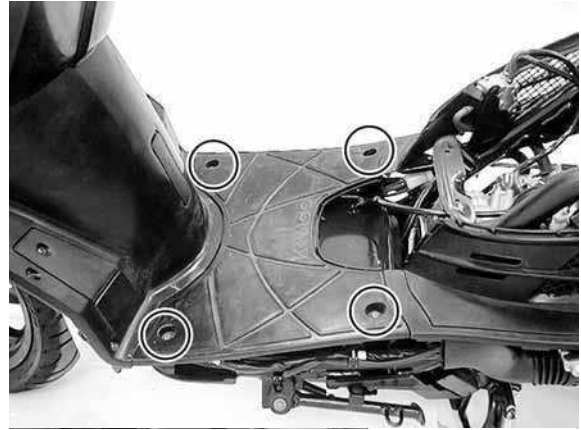

Disconnect the air inlet hose of the air cleaner.

Air Inlet Hose



Installation is in the reverse order of removal.

UNDER COVER

Remove the four bolts and side stand stop rubber.

Remove the under cover.

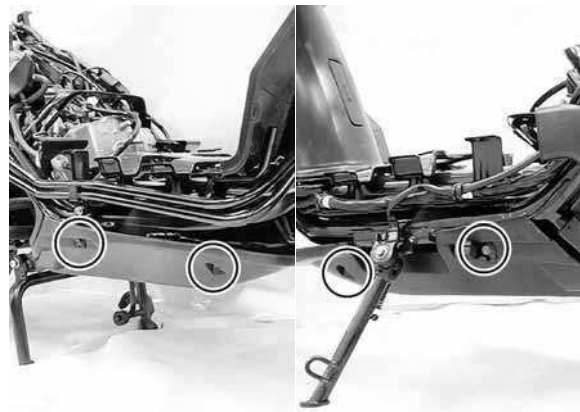

2. EXHAUST MUFFLER/FRAME COVERS

Cut the rubber band off, then remove the solenoid valve.

Installation is in the reverse order of removal.

Air Solenoid Valve



METER PANEL

Disconnect the speedometer cable.
Disconnect the meter connectors.

Remove the two screws.

Speedometer Cable

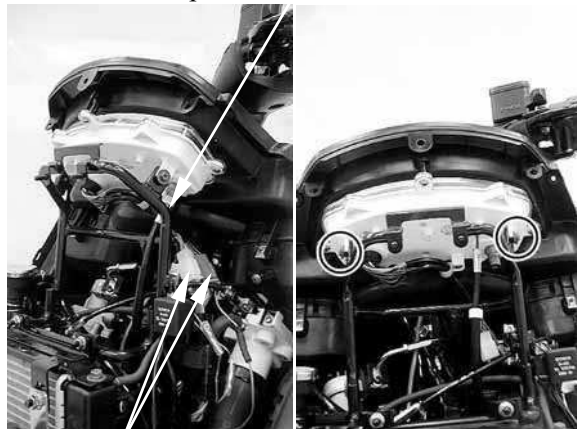

Meter Connectors

Remove the two screws from the inner cover,
then remove the meter panel.

Installation is in the reverse order of removal.



2. EXHAUST MUFFLER/FRAME COVERS

INNER COVER

Remove the front cover (see page 2-8).
Remove the front lower cover (see page 2-10).
Remove the floorboard (see page 2-11).

Turn the fuel fill cap garnish counterclockwise and remove it.
Turn the ignition key garnish counterclockwise and remove it.
Remove the bolt.



Cap Garnish

Key Garnish

Remove three screws and disconnect the fuel fill duct.



Remove the two screws, then remove the inner cover.

Installation is in the reverse order of removal.



2. EXHAUST MUFFLER/FRAME COVERS

DINK 200i/125

EXHAUST MUFFLER

REMOVAL

DINK 200i only:

Disconnect the O2 heater/O2 sensor (2) connector (1).

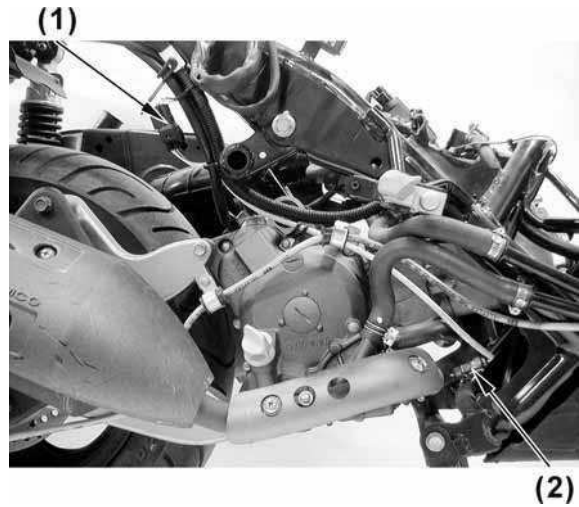

Remove the two exhaust pipe joint nuts



Remove three muffler mount bolts and muffler and gasket.



2. EXHAUST MUFFLER/FRAME COVERS

INSTALLATION

Replace the gasket with new ones.
Install the exhaust muffler and three mounting bolt but do not tighten them.

Install and tighten the two exhaust pipe joint nuts to the specified torque

Torque: 20 N•m (2 kgf•m, 14 lbf•ft)

Tighten the three mounting bolts

Torque: 33 N•m (3.3 kgf•m, 24 lbf•ft)



3. INSPECTION/ADJUSTMENT

3

INSPECTION/ADJUSTMENT

SERVICE INFORMATION-----	3- 1
MAINTENANCE SCHEDULE-----	3- 2
FUEL LINE/FUEL FILTER-----	3- 4
THROTTLE OPERATION-----	3- 4
ENGINE OIL -----	3- 6
TRANSMISSION OIL -----	3-12
AIR CLEANER -----	3-13
SECONDARY AIR SUPPLY SYSTEM -----	3-14
SPARK PLUG-----	3-15
VALVE CLEARANCE -----	3-16
IDLE SPEED -----	3-17
CYLINDER COMPRESSION -----	3-18
DRIVE BELT -----	3-18
CLUTCH SHOE WEAR-----	3-19
HEADLIGHT AIM -----	3-19
COOLANT -----	3-20
BRAKE FLUID -----	3-22
BRAKE PAD WEAR -----	3-22
NUTS/BOLTS/FASTENERS -----	3-23
WHEELS/TIRES -----	3-23
STEERING HANDLEBAR -----	3-24
SUSPENSION-----	3-24
SIDE STAND -----	3-25

SERVICE INFORMATION

GENERAL

 WARNING
--

- Before running the engine, make sure that the working area is well-ventilated. Never run the engine in a closed area. The exhaust contains poisonous carbon monoxide gas which may cause death to people.
- Gasoline is extremely flammable and is explosive under some conditions. The working area must be well-ventilated and do not smoke or allow flames or sparks near the working area or fuel storage area.

SPECIFICATIONS

- Throttle grip free play : 2~6 mm (0.08~0.24 in)
- Spark plug : DINK 125: NGK: DPR7EA9
: DINK 200i: NGK: DPR6EA9
- Spark plug gap : 0.9 mm (0.036 in)
- Valve clearance : IN: 0.1 mm (0.004 in) EX: 0.1 mm (0.004 in)
- Idle speed : DINK 125: 1700 rpm
: DINK 200i: 1660 rpm
- Cylinder compression : DINK 125: 15 kgf/cm² (1500 kPa, 213 psi)
: DINK 200i: 16 kgf/cm² (1600 kPa, 227.2 psi)
- Engine oil capacity:
At disassembly : 1.1 L (0.968 Imp qt, 1.166 US qt)
At change : 0.9 L (0.792 Imp qt, 0.954 US qt)
- Gear oil capacity :
At disassembly : 0.2 L (0.176 Imp qt, 0.212 US qt)
At change : 0.18 L (0.16 Imp qt, 0.19 US qt)
- Coolant capacity :
- Reserve tank capacity: 0.37 liter (0.4 US qt, 0.33 Imp qt)
- Radiator capacity : 1 liter (1.1 US qt, 0.88 Imp qt)
- Ignition timing : DINK 125: 10°±1.5°/1000 rpm
: DINK 200i: ECU control

TIRE

	1 Rider (60 kg)	2 Riders (110 kg)
Front	1.75 kgf/cm ² (175 kPa, 24.85 psi)	1.75 kgf/cm ² (175 kPa, 24.85 psi)
Rear	2 kgf/cm ² (200 kPa, 28.4 psi)	2.25 kgf/cm ² (225 kPa, 31.95 psi)

TIRE SPECIFICATION:

- Front : 120/70-13
Rear: 140/70-12

3. INSPECTION/ADJUSTMENT

TORQUE VALUES

Front axle nut : 6 kgf-m (60 N-m, 43 lbf-ft)

Rear axle nut : 12 kgf-m (120 N-m, 86 lbf-ft)

MAINTENANCE SCHEDULE

Perform the pre-ride inspection at each scheduled maintenance period.

This interval should be judged by odometer reading or months, whichever comes first.

I: INSPECT AND CLEAN, ADJUST, LUBRICATE OR REPLACE IF NECESSARY

C: CLEAN R: REPLACE A: ADJUST L: LUBRICATE

The following maintenance schedule specifies all maintenance required to keep your scooter in peak operating condition. Maintenance work should be performed in accordance with standards and specifications of KYMCO by properly trained and equipped technicians. Your KYMCO dealer meets all of these requirements.

* Should be serviced by your KYMCO dealer, unless the owner has the proper tools and service data and is mechanically qualified.

* * In the interest of safety, we recommend these items be serviced only by your KYMCO dealer. KYMCO recommends that your KYMCO dealer should road test your scooter after each periodic maintenance is carried out.

NOTE:

1 At higher odometer readings, repeat at the frequency interval established here.

2 Service more frequently if the scooter is ridden in unusually wet or dusty areas.

3 Service more frequently when riding in rain or at full throttle.

4 Clean every 2000 km (1200 mi) after replacement and replace every 5000 km (3000 mi).

5 Replace every 1 year, or every 4000km (2400mi), whichever comes first. Replacement requires mechanical skill.

6 Replace every 10000 km (6000 mi), or once a year it at every 5000 km (3000 mi). Replacement requires mechanical skill.

7 Replace every 2 years. Replacement requires mechanical skill.

8 Replace every 6000 km (3700 mi). Replacement requires mechanical skill.

3. INSPECTION/ADJUSTMENT

DINK 200i125

MAINTENANCE SCHEDULE

FREQUENCY		WHICHEVER COMES FIRST	ODOMETER READING [NOTE (1)]							
			X 1000 km	0.3	1	3	5	7	9	11
				X 1000 mi	0.2	0.6	1.8	3	4.2	5.4
ITEM		NOTE	MONTH							
*	AIR CLEANER	NOTE 2			I	R	I	R	I	R
	SPARK PLUGS	NOTE 4					R			
*	THROTTLE OPERATION						I		I	
*	VALVE CLEARANCE			A		A		A		A
*	FUEL LINE						I		I	
	CRANKCASE BREATHER	NOTE 3			C	C	C	C	C	C
	ENGINE OIL			R	R	R	R	R	R	R
*	ENGINE OIL FILTER	NOTE 8					R			R
*	ENGINE OIL STRAINER SCREEN			C		C		C		C
*	ENGINE IDLE SPEED					I		I		I
	RADIATOR COOLANT	NOTE 6					R			
*	COOLING SYSTEM						I		I	
*	SECONDARY AIR SUPPLY SYSTEM						I		I	
*	TRANSMISSION OIL	NOTE 5		R		R		R		R
*	DRIVE BELT							I		
**	CLUTCH SHOE WEAR							I		
	BRAKE FLUID	NOTE 7				I	I	I	R	I
	BRAKE PAD WEAR					I	I	I	I	I
	BRAKE SYSTEM					I	I	I	I	I
*	BRAKE LIGHT SWITCH						I		I	
	SIDE STAND						I		I	
*	SUSPENSION						I		I	
*	HEADLIGHT AIM						I		I	
*	NUTS, BOLTS, FASTENERS			I			I		I	
**	WHEELS/TIRES					I	I	I	I	I
**	STEERING BEARINGS			I			I		I	

3. INSPECTION/ADJUSTMENT

FUEL LINE/FUEL FILTER

DINK 125:

Check the fuel lines (2) and replace any parts which show signs of deterioration, damage or leakage.

Check for dirty or clogged fuel filter (1) and replace with a new one if it is clogged.

* Do not smoke or allow flames or sparks in your working area.

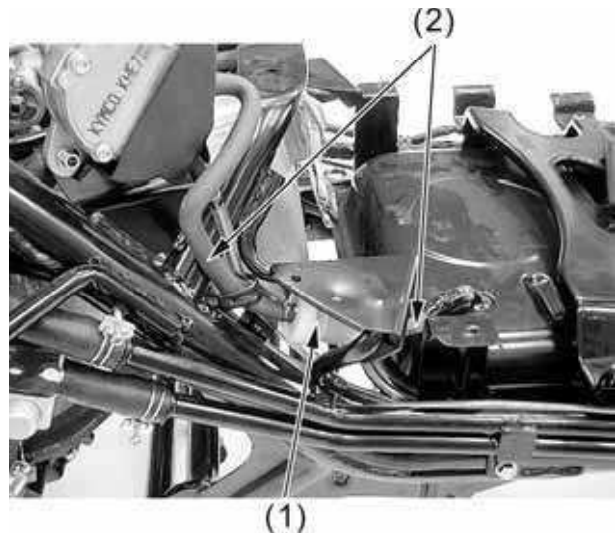

DINK 200i:

Check the fuel lines (1) and replace any parts which show signs of deterioration, damage or leakage.

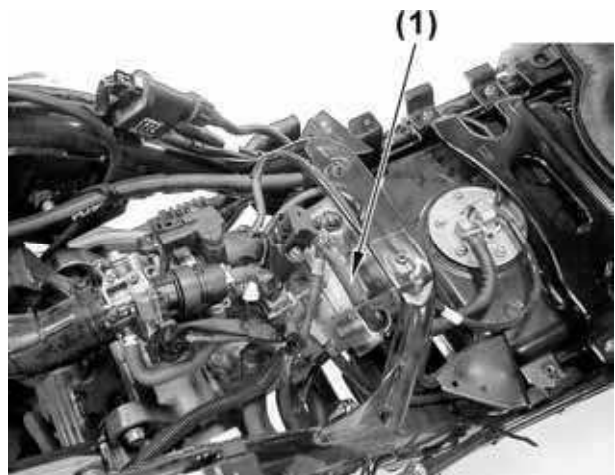

THROTTLE OPERATION

Check the throttle grip for smooth movement. Measure the throttle grip free play.

Free Play: 2~6 mm (0.08~0.24 in)

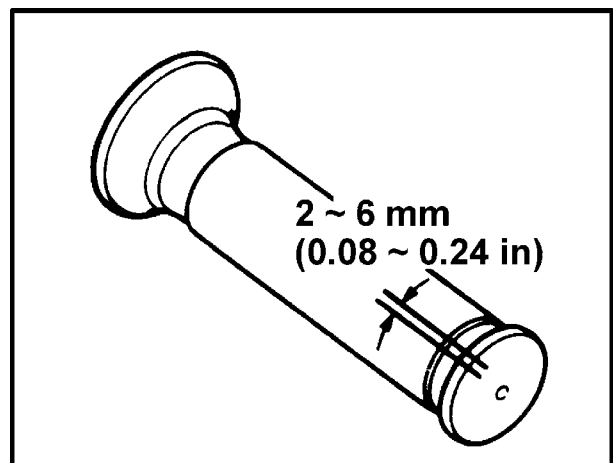

3. INSPECTION/ADJUSTMENT

DINK 200i125

Major adjustment of the throttle grip free play is made with the adjusting nut (2) at the carburetor side. Adjust by loosening the lock nut (1) and turning the adjusting nut.

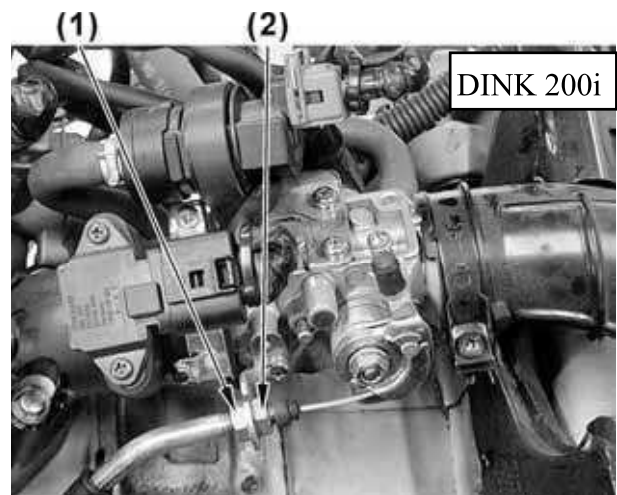
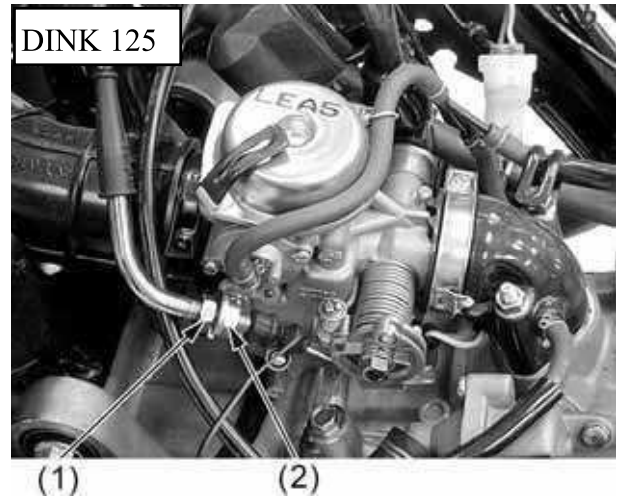

Minor adjustment is made with the adjusting nut at the throttle grip side. Slide the rubber cover (1) out and adjust by loosening the lock nut (3) and turning the adjusting nut (2).

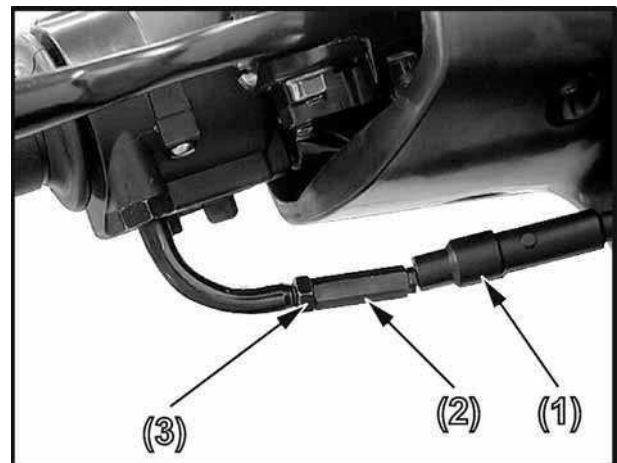

3. INSPECTION/ADJUSTMENT

ENGINE OIL

Engine oil recommendation

Use a premium quality 4-stroke motor oil to ensure longer service life of your scooter. Use only oils which are rated, SG under the API service classification. The recommended viscosity is SAE 10W-30. If a SAE 10W-30 motor oil is not available, select an alternative according to the right chart.

Engine oil capacity:

At disassembly:

1.1 L (0.968 Imp qt, 1.166 US qt)

At change:

0.9 L (0.792 Imp qt, 0.954 US qt)

Engine oil level check

Check the engine oil level each day before riding the scooter.

The level must be maintained between the upper (1) and lower level (2) marks on the oil filler cap/dipstick.

1. Start the engine and let it idle for a few minutes.
2. Stop the engine and put the scooter on its center stand on level ground.
3. After a few minutes, remove the oil filler cap/dipstick, wipe it clean, and reinsert the oil filler cap/dipstick without screwing it in. Remove the oil filler cap/dipstick. The oil level should be between the upper and lower marks on the oil filler cap/dipstick.
4. If required, add the specified oil up to the upper level mark. Do not overfill.
5. Reinstall the oil filler cap/dipstick. Check for oil leaks.

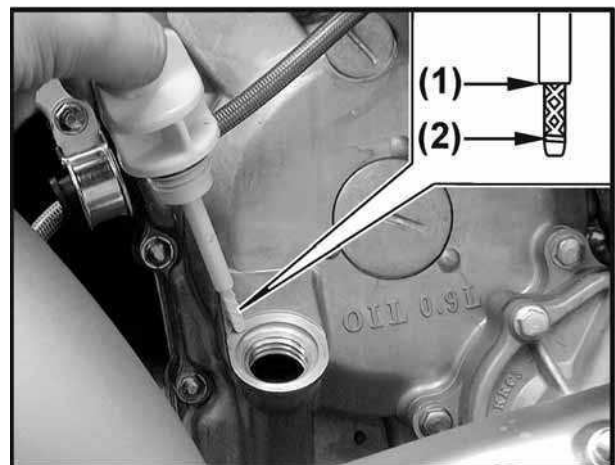
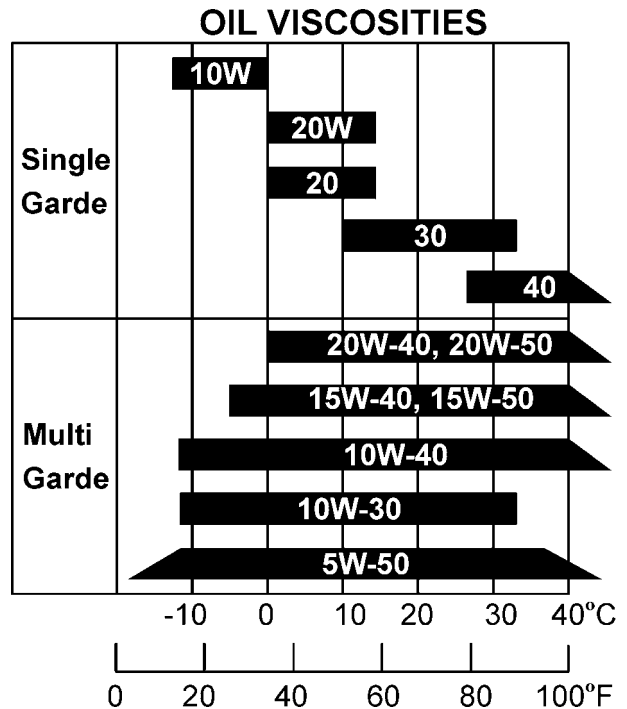

* Let the engine and exhaust system cool before working in those areas.

3. INSPECTION/ADJUSTMENT

Engine oil replacement

Engine oil quality is the chief factor affecting engine service life. Change the engine oil as specified in the maintenance schedule.

When running in very dusty conditions, oil changes should be performed more frequently than specified in the maintenance schedule.

Please dispose of used engine oil in a manner that is compatible with the environment. We suggest you take it in a sealed container to your local recycling center or service station for reclamation. Do not throw it in the trash or pour it on the ground or down a drain.

Used engine oil may cause skin cancer if repeatedly left in contact with the skin for prolonged periods. Although this is unlikely unless you handle used oil on a daily basis, it is still advisable to thoroughly wash your hands with soap and water as soon as possible after handling used oil.

Change the engine oil with the engine at normal operating temperature and the scooter on its center stand to assure complete and rapid draining.

3. INSPECTION/ADJUSTMENT

1. Remove the oil filler cap/dipstick (1) from the right crankcase cover.
2. Place a container under the left crankcase.
3. Remove the oil drain plug (2) to drain the oil.
4. Reinstall the drain plug and tighten the drain plug to specification.

Oil drain plug torque:

25 N-m (2.5 kgf-m, 18lbf-ft)

5. Fill the crankcase with the recommended grade oil and install the oil fill cap.

Oil capacity (after draining):

0.9 liter (0.95 US qt, 0.8 Imp qt)

6. Start the engine and let it idle for 2 – 3 minutes.
7. Stop the engine and check that the oil level is at the upper level mark on the oil filler cap/dipstick with the scooter upright on firm, level ground. Make sure there are no oil leaks.

* Let the engine and exhaust system cool before working in those areas.

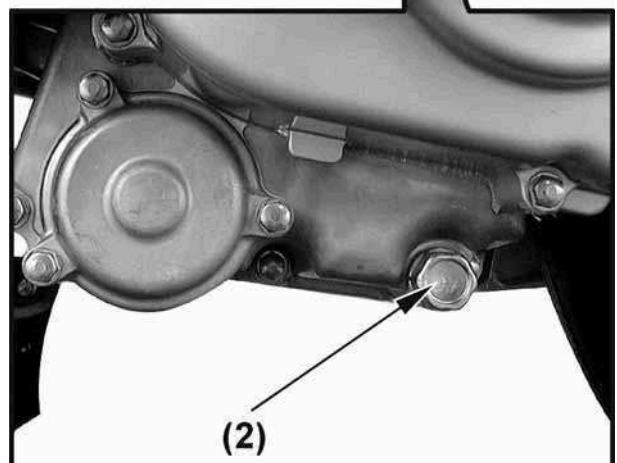
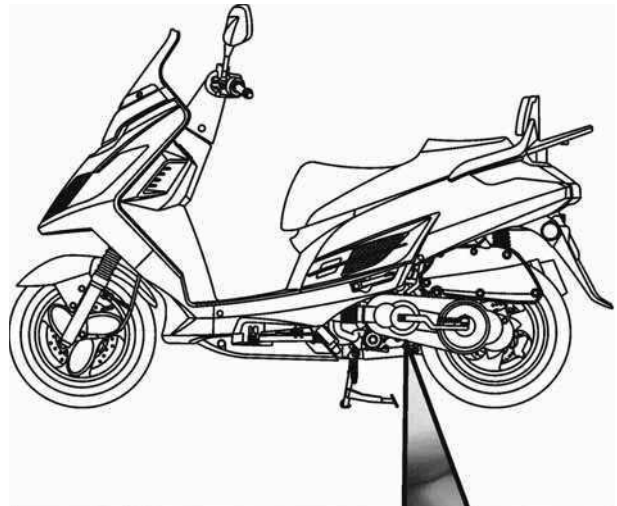
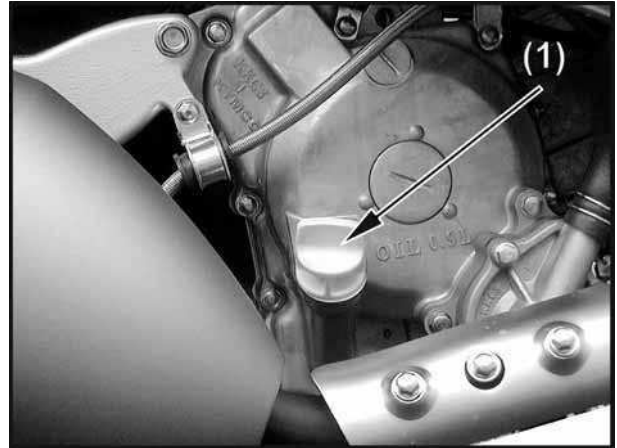

3. INSPECTION/ADJUSTMENT

Oil strainer screen clean

Change the engine oil with the engine at normal operating temperature and the scooter on its center stand to assure complete and rapid draining.

* Let the engine and exhaust system cool before working in those areas.

1. Remove the oil filler cap/dipstick (1) from the right crankcase cover.
2. Place a drain pan under the crankcase and remove the oil strainer screen cap (2). The spring (3) and oil strainer screen (4) will come out when the drain plug is removed.
Let the engine oil drain out.
3. Clean the oil strainer screen.
4. Check that the oil strainer screen, sealing rubber and drain plug O-ring are in good condition.
5. Install the oil strainer screen, spring and oil strainer screen cap.

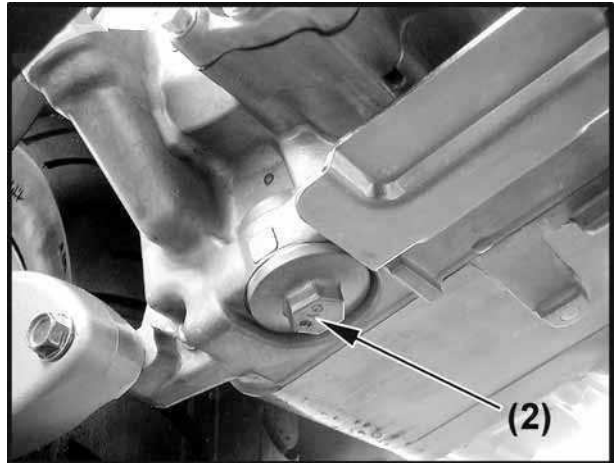
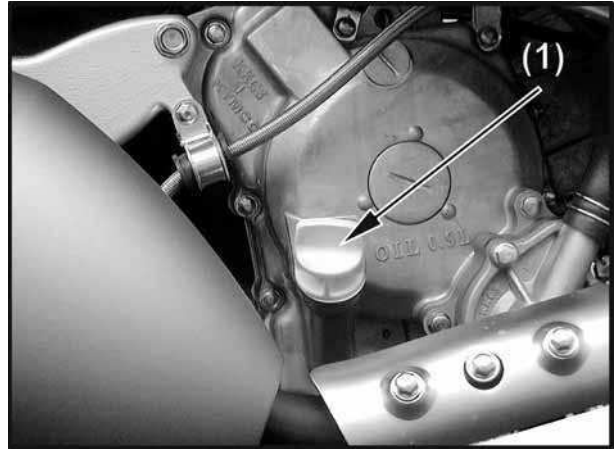

Oil strainer screen cap torque:

15N-m (1.5 kgf-m, 111bf-ft)

5. Fill the crankcase with the recommended grade oil and install the oil filler cap.

Oil capacity (after draining):

0.9 liter (0.95 US qt, 0.8 Imp qt)

6. Start the engine and let it idle for 2–3 minutes.
7. Stop the engine and check that the oil level is at the upper level mark on the oil filler cap/dipstick with the scooter upright on firm, level ground. Make sure there are no oil leaks.

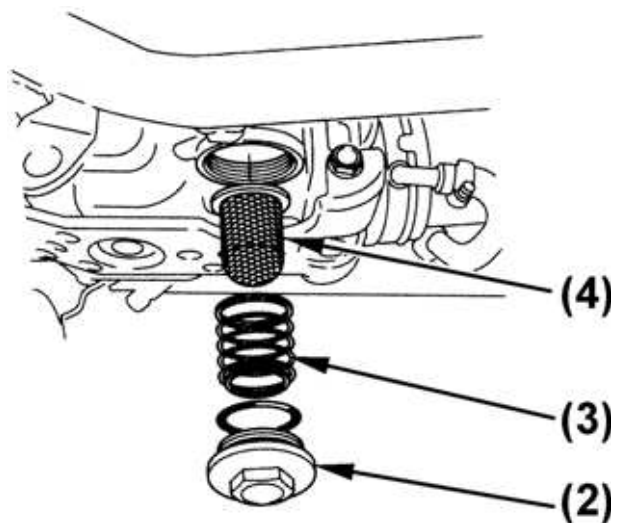

3. INSPECTION/ADJUSTMENT

Oil filter replacement

Change the engine oil with the engine at normal operating temperature and the scooter on its center stand to assure complete and rapid draining.

* Let the engine and exhaust system cool before working in those areas.

1. Remove the oil filler cap/dipstick (1) from the right crankcase cover.

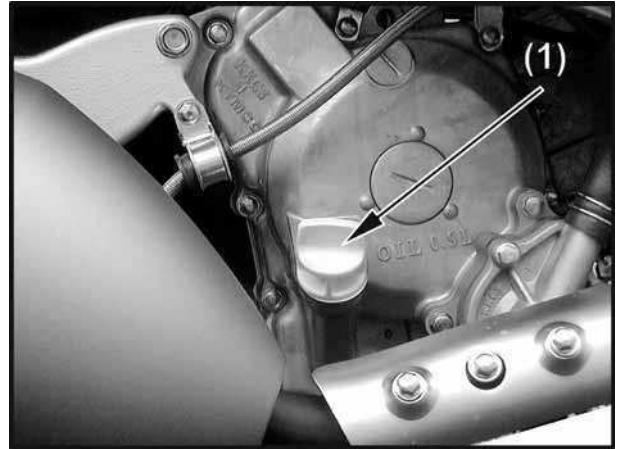

2. Place a drain pan under the crankcase. Remove three bolts and then remove the oil filter cap (2) and O-ring (3). The spring (4) will come out when the filter cap is removed. Let the engine oil drain out.

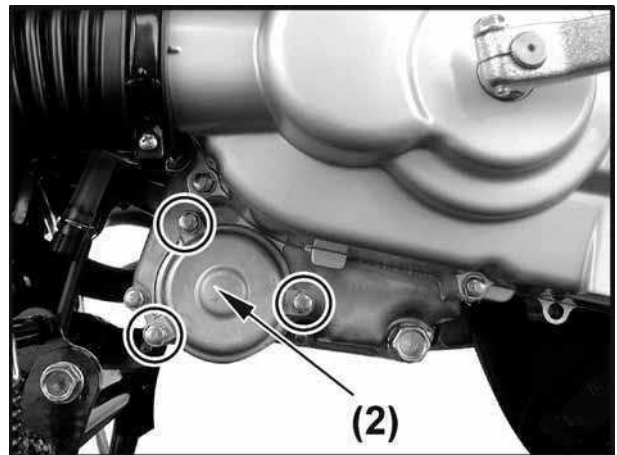

3. Remove and discard the oil filter (5).

* Do not remain the rubber seal on the oil filter in the oil filter housing.

4. Check that the O-ring is in good condition.

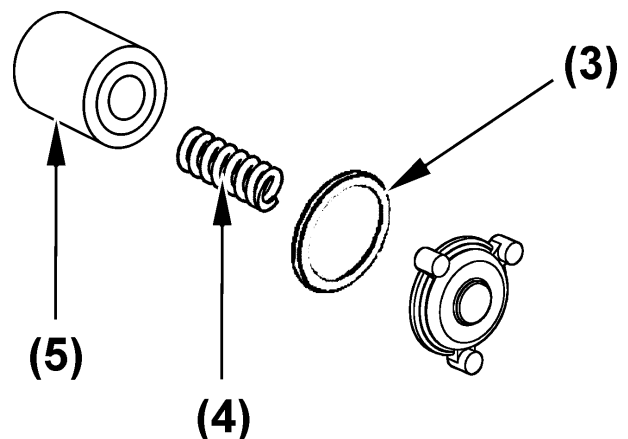

3. INSPECTION/ADJUSTMENT

5. Install the new oil filter.

* Make sure the rubber seal on the oil filter facing the left crankcase.

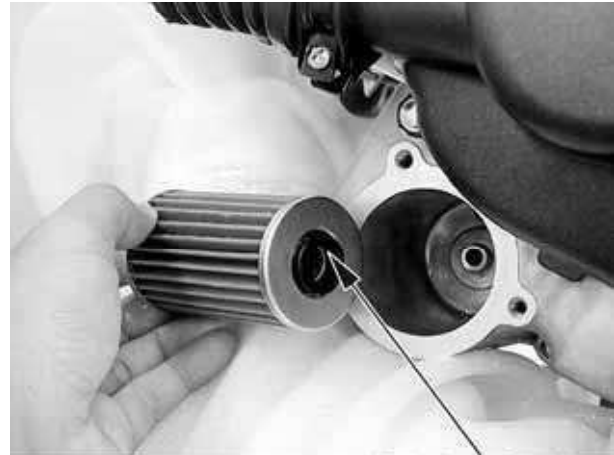

Rubber Seal

6. Install the spring, O-ring and cap.

Cap bolt torque:

12 N-m (1.2 kgf-m, 8.6 lbf-ft)

7. Fill the crankcase with the recommended grade oil and install the oil filler cap.

Oil capacity (after draining):

0.9 liter (0.95 US qt, 0.8 Imp qt)

8. Start the engine and let it idle for 2–3 minutes.

9. Stop the engine and check that the oil level is at the upper level mark on the oil filler cap/dipstick with the scooter upright on firm, level ground. Make sure there are no oil leaks.



O-ring

Spring

3. INSPECTION/ADJUSTMENT

TRANSMISSION OIL

Oil change

1. Place the scooter in its center stand.
2. Place a drain pan under the drain bolt (1).
3. Remove the transmission oil drain bolt.
4. Remove the transmission oil filler bolt (2), slowly turn the rear wheel and drain the oil.

After draining the oil completely, install the oil drain bolt with a new sealing washer and tighten it.



Torque: 13 N-m (1.3 kgf-m, 9.5 lbf-ft)

5. Fill the transmission case with recommended oil.

Recommended transmission oil: SAE 90

Oil capacity (at draining):

0.18 liter (0.2 US qt, 0.16 imp qt)

6. Install the transmission oil filler bolt with a new sealing washer and tighten it.

Torque: 13 N-m (1.3 kgf-m, 9.5 lbf-ft)

3. INSPECTION/ADJUSTMENT

AIR CLEANER

The air cleaner should be serviced at regular intervals. Service more frequently when riding in unusually wet or dusty areas.

Air cleaner element replacement

1. Remove the band (1).
2. Remove a bolt from the crankcase and six screws from the air cleaner cover (2), then remove air cleaner cover.
3. Remove six screws from the air cleaner element (3), then remove and discard this air cleaner element.
4. The new air cleaner element installation is in the reverse order of removal.

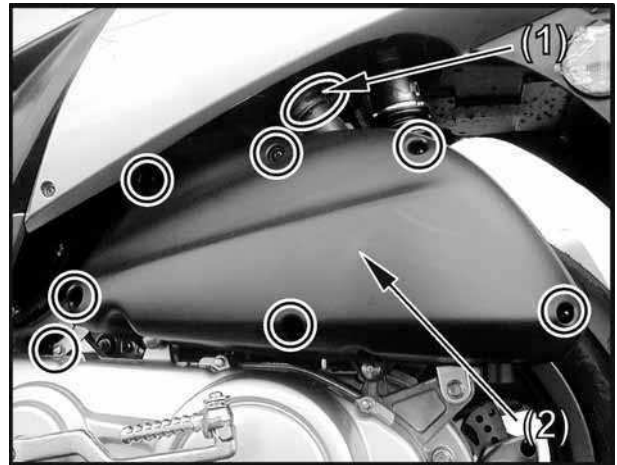

Use the KYMCO genuine air cleaner element or an equivalent air cleaner element specified for your model. Using the wrong KYMCO air cleaner element or a non-KYMCO air cleaner element which is not of equivalent quality may cause premature engine wear or performance problems.

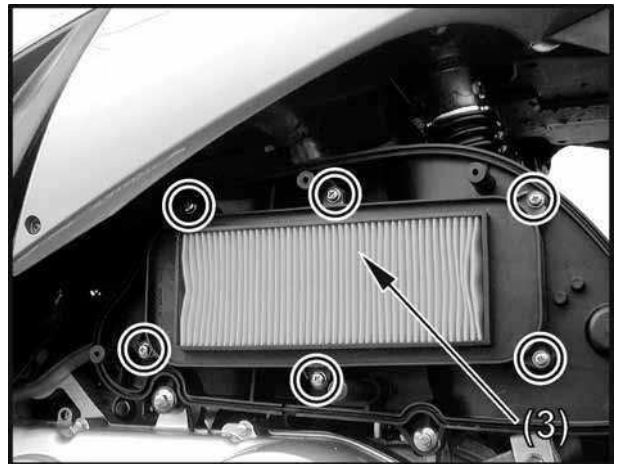

3. INSPECTION/ADJUSTMENT

SECONDARY AIR SUPPLY SYSTEM

This model is equipped with a built-in secondary air supply system. The pulse secondary air supply system is located on the cylinder head.

The secondary air supply system introduces filtered air into exhaust gases in the exhaust port. The secondary air is drawn into the exhaust port whenever there is negative pressure pulse in the exhaust system. This charged secondary air promotes burning of the unburned exhaust gases and changes a considerable amount of hydrocarbons and carbon monoxide into relatively harmless carbon dioxide and water.

Check the AICV (air injection control valve) hoses between the AICV control solenoid valve and cylinder head for deterioration, damage or loose connections. Make sure the hoses are not cracked.

If the hoses show any signs of heat damage, inspect the AICV check valve in the AICV reed valve cover damage.

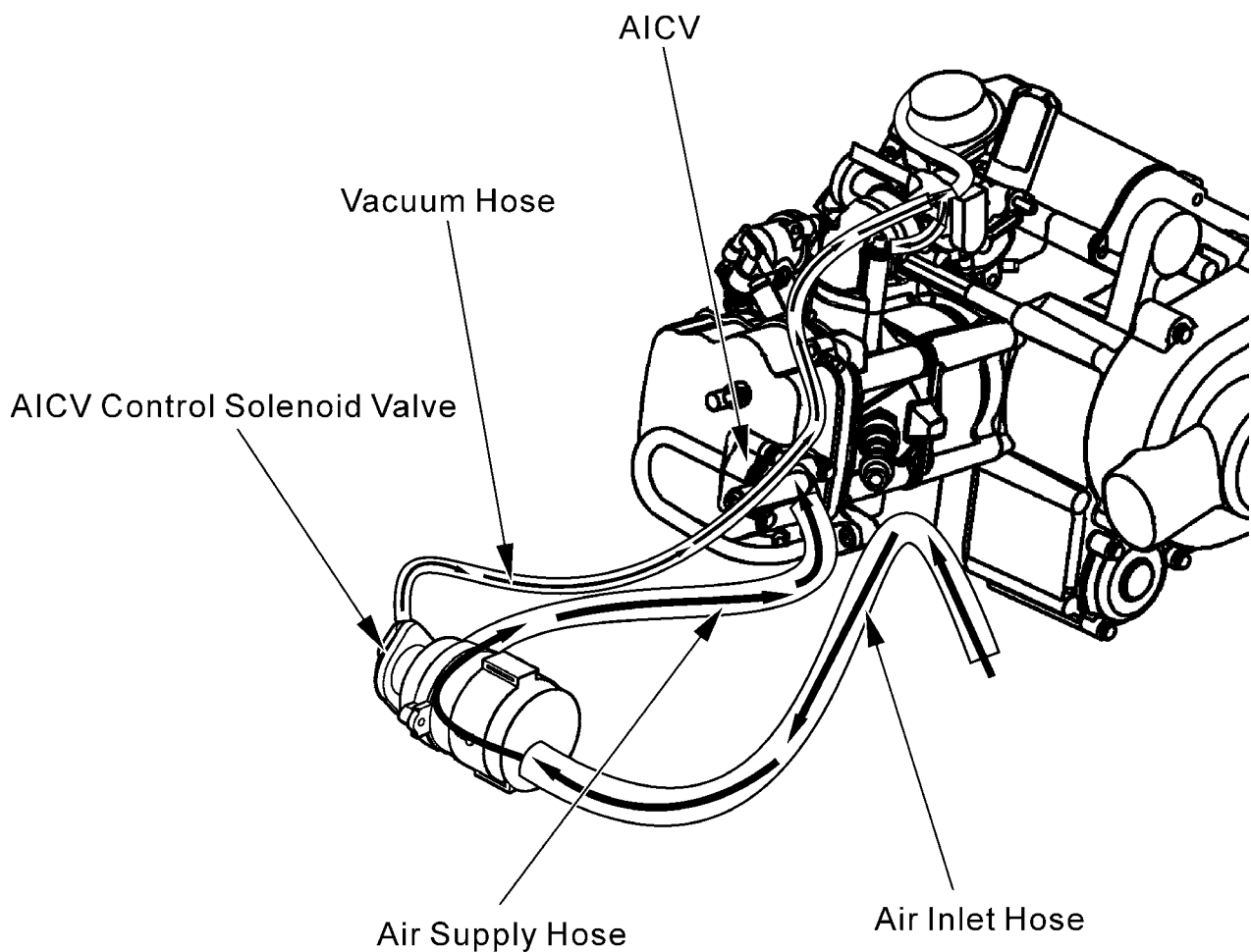

3. INSPECTION/ADJUSTMENT

DINK 200i125

SPARK PLUG

Remove the spark plug cap and spark plug (1).
 Check the spark plug for wear and fouling deposits.
 Clean any fouling deposits with a spark plug cleaner or a wire brush.



(1)

Specified Spark Plug:

DINK 125: NGK: DP7EA9

DINK 200i: NGK: DPR6EA9

Measure the spark plug gap.

Spark Plug Gap: 0.9 mm (0.036 in)

* When installing, first screw in the spark plug by hand and then tighten it with a spark plug wrench.

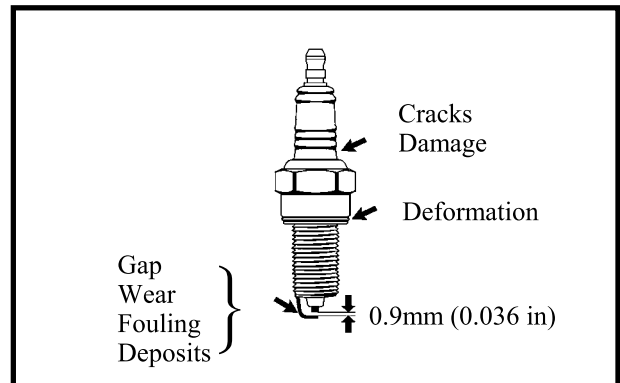

Torque: 0.9 kgf-m (9 N-m, 6.5 lbf-ft)

3. INSPECTION/ADJUSTMENT

VALVE CLEARANCE

- * • Inspect and adjust valve clearance while the engine is cold (below 35°C).

Remove the two nuts (1) and four bolts (2), then remove cylinder head cover.

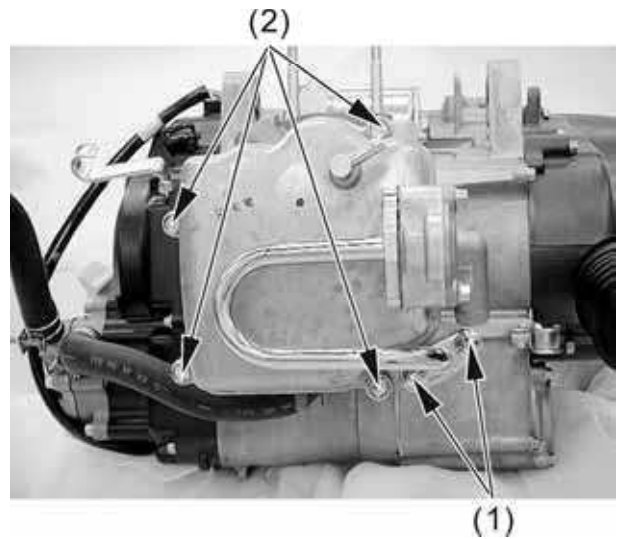

Remove the timing hole cap and O-ring (4). Remove the crankshaft hole cap and O-ring (3).

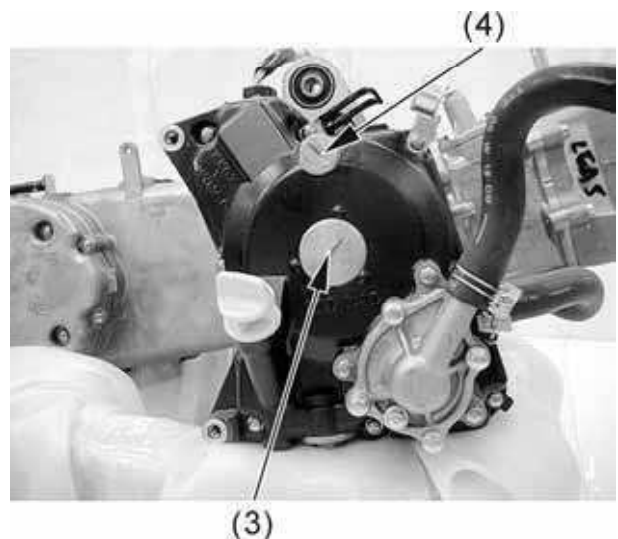

Turn the A.C. generator flywheel clockwise to the top dead center (TDC) on the compression stroke so that the "T" mark (6) on the flywheel aligns with the index mark (5) on the left crankcase cover.

The punch mark (7) on the camshaft should face upward as shown.

If the punch mark on the camshaft are facing downward, turn the crankshaft clockwise one full turn (360°) and the punch mark are facing upward.

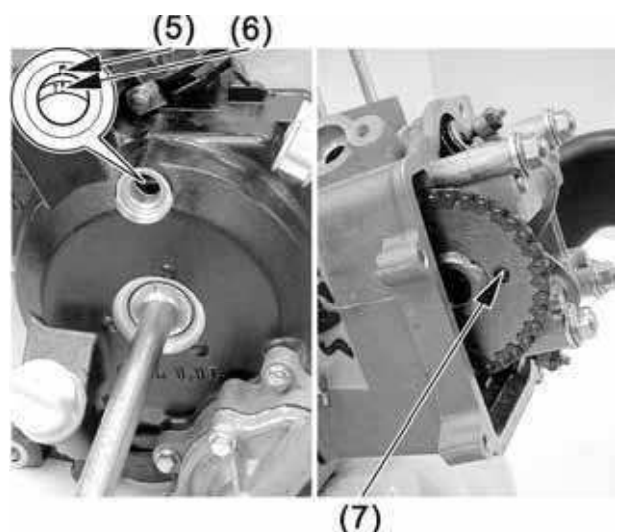

3. INSPECTION/ADJUSTMENT

Adjust by loosening the valve adjusting screw lock-nut (8) and turning the adjusting screw (9) until there is a slight drag on the thickness gauge (10).

Valve Clearance: IN: 0.1 mm (0.004 in)
EX: 0.1 mm (0.004 in)

Apply oil to the valve adjusting screw lock-nut threads and seating surface.

Hold the adjusting screw and tighten the lock nut to the specified torque.

Torque: 0.9 kgf-m (9 N-m, 6.5 lbf-ft)

Special tool:

Valve adjuster A120E00036

After tightening the lock-nut, recheck the valve clearance.

Install the removed parts in the reverse order of removal.

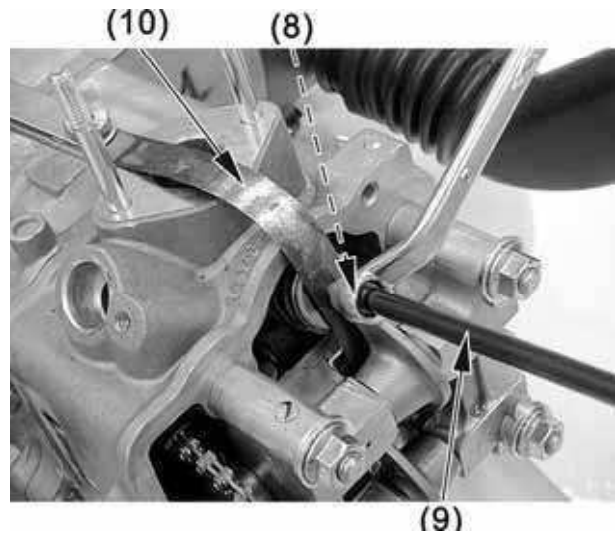

IDLE SPEED

- *
 - The engine must be warm for accurate idle speed inspection and adjustment.
 - It is not necessary to adjust idle speed for DINK 200i. The throttle body is factory pre-set, do not loosen or tighten the painted bolts and screws of throttle body. Loosening or tightening them can cause throttle and idle and valve synchronization failure.

Warm up the engine before this operation. Start the engine and connect a tachometer. Turn the throttle stop screw (1) to obtain the specified idle speed.

Idle Speed:

- DINK 125: 1700 rpm
- DINK 200i: 1660 rpm

DINK 125 only:

When the engine misses or run erratic, adjust the pilot screw (2).

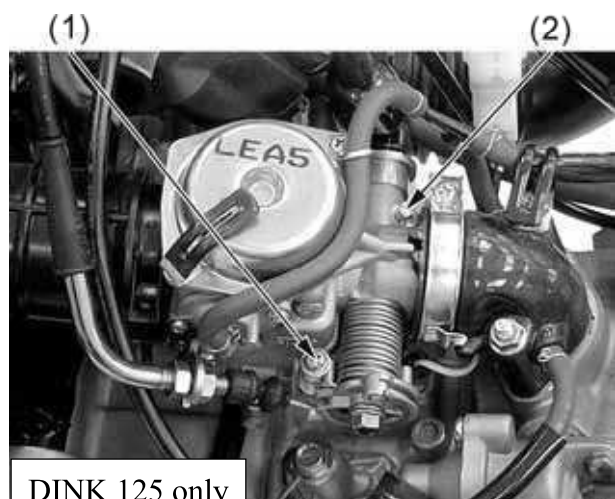

DINK 125 only

3. INSPECTION/ADJUSTMENT

CYLINDER COMPRESSION

Warm up the engine before compression test.
Remove the center cover and spark plug cap.
Remove the spark plug .
Insert a compression gauge.
Open the throttle valve fully and push the starter button to test the compression.

Compression:

DINK 125:15 kgf/cm² (1500 kPa, 213 psi)

DINK 200i:16 kgf/cm² (1600 kPa, 227.2 psi)

If the compression is low, check for the following:

- Leaky valves
- Valve clearance too small
- Leaking cylinder head gasket
- Worn pistons
- Worn piston/cylinder

If the compression is high, it indicates that carbon deposits have accumulated on the combustion chamber and the piston head.



DRIVE BELT

Remove the left crankcase cover.
Inspect the drive belt (1) for cracks or excessive wear.
Replace the drive belt with a new one if necessary and in accordance with the Maintenance Schedule.

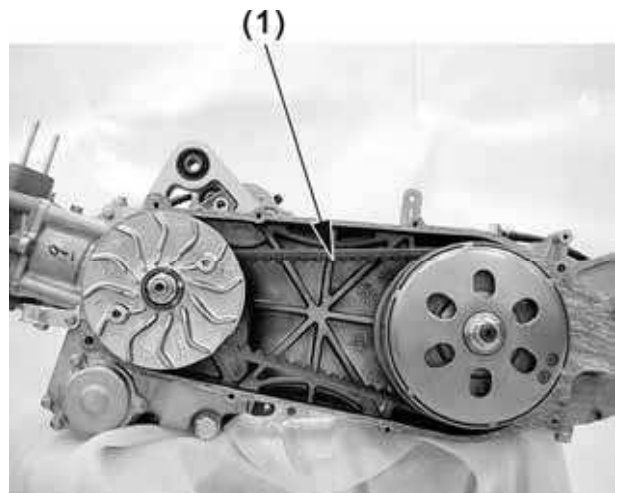

3. INSPECTION/ADJUSTMENT

CLUTCH SHOE WEAR

Start the engine and check the clutch operation by increasing the engine speed gradually.

If the scooter tends to creep, or the engine stalls, check the clutch shoes for wear and replace if necessary (refer to the “**DRIVE PULLEY, DRIVE BELT AND DRIVEN PULLEY**” section in the chapter 8).

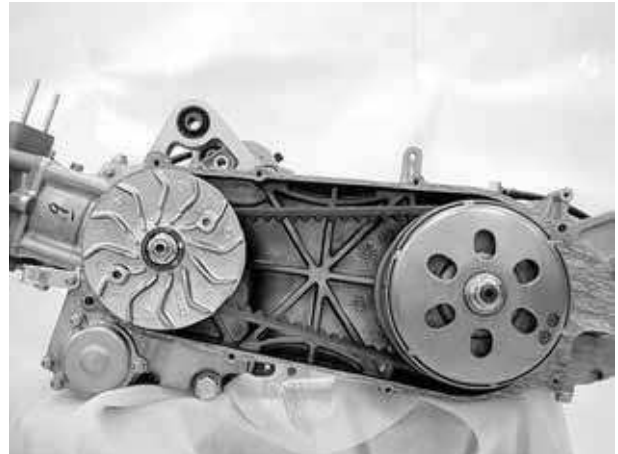

HEADLIGHT AIM

Remove the rubber plug (1) to expose the screw (2).

Headlight aim can be made by turning the screw in or out as necessary.

Obey local laws and regulations.

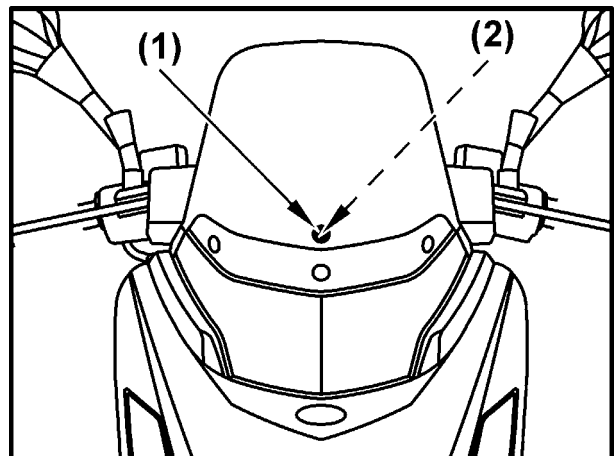

3. INSPECTION/ADJUSTMENT

COOLANT

Inspection

The reserve tank is under footboard left. Check the coolant level through the inspection window (1) at the front lower cover while the engine is at the normal operating temperature with the scooter in an upright position. If the coolant level is below the LOWER level mark (3), remove screw (4) and reserve tank lid (5) and reserve tank cap (6) and add coolant mixture until it reaches the upper level mark (2).

Always add coolant to the reserve tank. Do not attempt to add coolant by removing the radiator cap.

If the reserve tank is empty, or if coolant loss is excessive, check for leaks and see your KYMCO dealer for repair.

Coolant recommendation

The owner must properly maintain the coolant to prevent freezing, overheating, and corrosion, use only high quality ethylene glycol antifreeze containing corrosion protection inhibitors specifically recommended for use in aluminum engines. (See antifreeze container label.)

Use only low-mineral drinking water or distilled water as a part of the antifreeze solution. Water that is high in mineral content or salt may be harmful to the aluminum engine.

Using coolant with silicate inhibitors may cause premature wear of water pump seals or blockage of radiator passages.

Using tap water may cause engine damage. The factory provides a 50:50 solution of antifreeze and distilled water in this scooter. This coolant solution is recommended for most operating temperatures and provides good corrosion protection.

A higher concentration of antifreeze decreases the cooling system performance and is recommended only when additional protection against freezing is needed. A concentration of less than 40:60 (40% antifreeze) will not provide proper corrosion protection. During freezing temperatures,

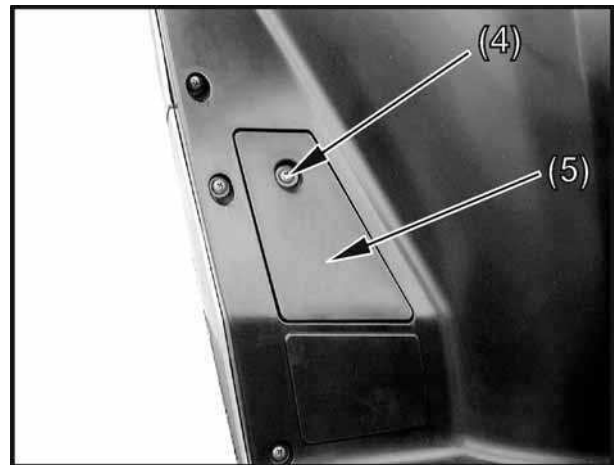
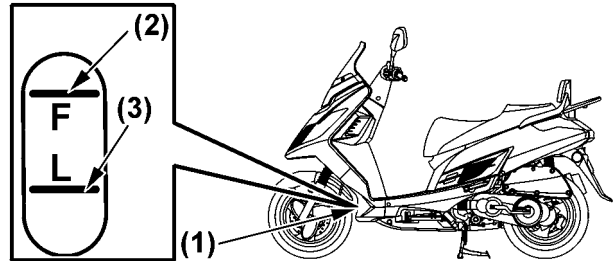

3. INSPECTION/ADJUSTMENT

check the cooling system frequently and add higher concentrations of antifreeze (up to a maximum of 60% antifreeze) if required.

3. INSPECTION/ADJUSTMENT

BRAKE FLUID

Brake fluid level:

With the scooter in an upright position, check the front and rear fluid level. It should be above the lower level mark. If the level is at or below the lower level mark "L", check the brake pads for wear.

Worn pads should be replaced. If the pads are not worn, have your brake system inspected for leaks.

The recommended brake fluid is **DOT 4** brake fluid from a sealed container, or an equivalent.

Other checks:

Make sure there are no fluid leaks. Check for deterioration or cracks in the hoses and fittings.

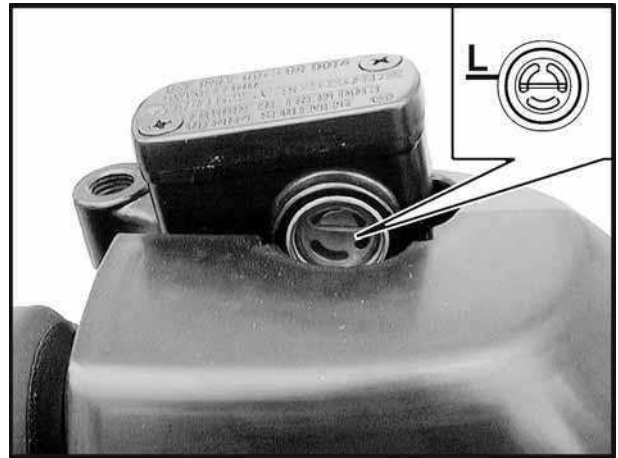

BRAKE PAD WEAR

Brake pad wear depends upon the severity of usage, the type of riding, and road conditions. (Generally, the pads will wear faster on wet and dirty roads.) Inspect the pads at each regular maintenance interval.

Front brake

Check the cutout in each pad.

If either pad is worn to the cutout, replace both pads as a set. See your KYMCO dealer for this service.

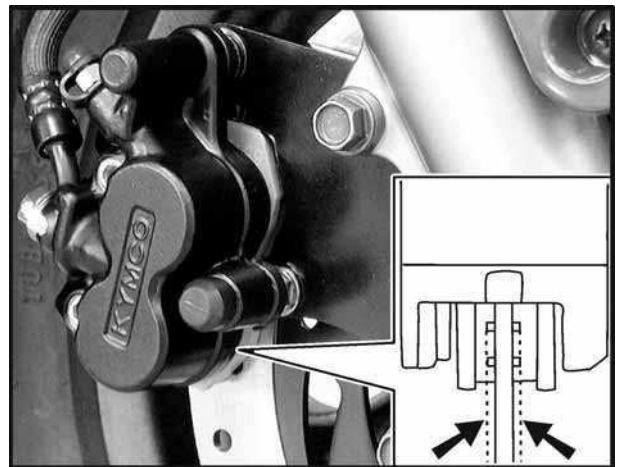

Rear brake

Check the cutout in each pad.

If either pad is worn to the cutout, replace both pads as a set. See your KYMCO dealer for this service.

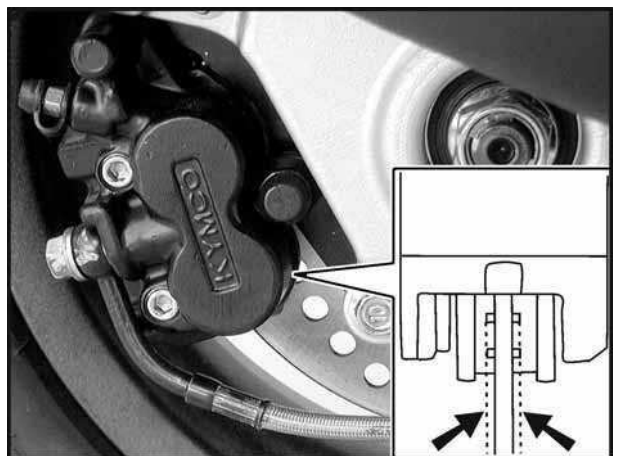

3. INSPECTION/ADJUSTMENT

NUTS/BOLTS/FASTENERS

Check all important chassis nuts and bolts for looseness.

Tighten them to their specified torque values if any looseness is found.

WHEELS/TIRES

Tire pressure

Insufficient air pressure in the tires not only hastens tire wear but also seriously affects the stability of the scooter. Under inflated tires make smooth cornering difficult and overinflated tires decrease the amount of tire in contact with the ground which can lead to skids and loss of control. Be sure that the tire pressure is within the specified limits at all times. Tire pressure should only be adjusted when the tires are cold.

Cold inflation tire pressure

	1 Rider (60 kg)	2 Riders (110 kg)
Front	1.75 kg/cm ² (175 kPa, 24.85 psi)	1.75 kg/cm ² (175 kPa, 24.85 psi)
Rear	2 kg/cm ² (200 kPa, 28.4 psi)	2.25 kg/cm ² (225 kPa, 31.95 psi)

3. INSPECTION/ADJUSTMENT

STEERING HANDLEBAR

Raise the front wheel off the ground and check that the steering handlebar rotates freely.

If the handlebar moves unevenly, binds, or has vertical movement, adjust the steering head bearing.

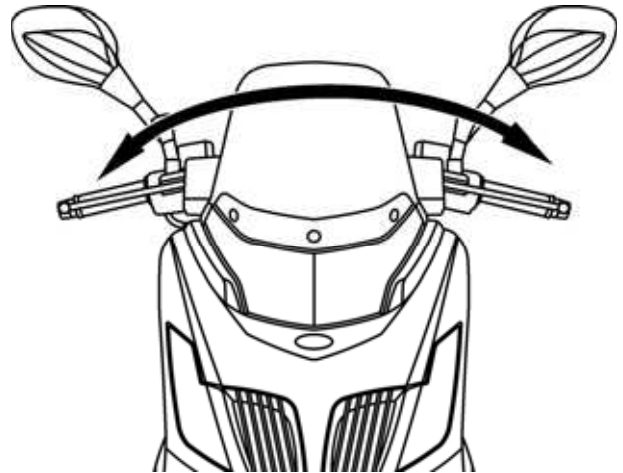

SUSPENSION

Check the action of the front/rear shock absorbers by compressing them several times. Check the entire shock absorber assembly for oil leaks, looseness or damage.

Jack the rear wheel off the ground and move the rear wheel sideways with force to see if the engine hanger bushings are worn. Replace the engine hanger bushings if there is any looseness.

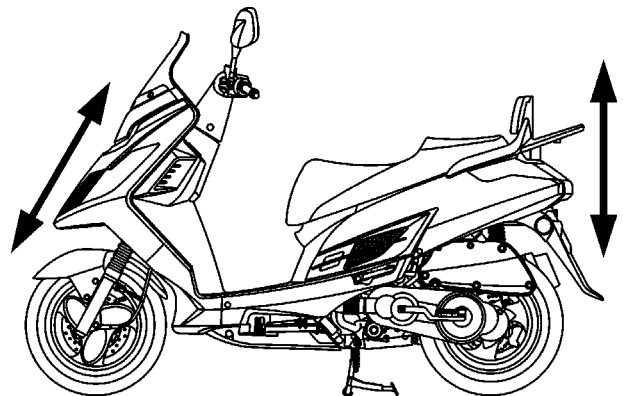

Rear suspension adjustment

Each shock absorber (1) has adjustment positions for different load or riding conditions.

Use a pin spanner (2) to adjust the rear shocks.

Be certain to adjust both shock absorbers to the same position.

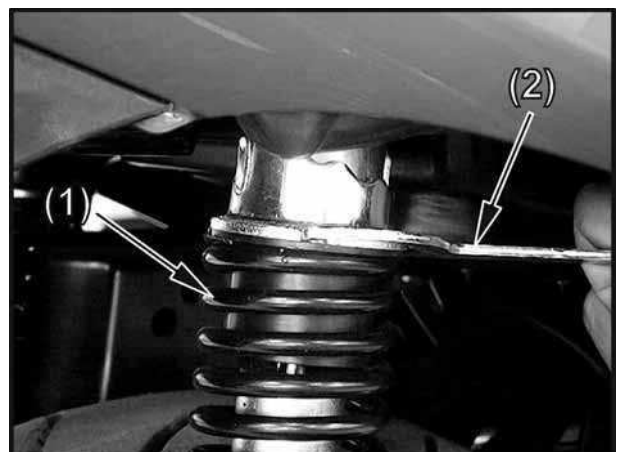

3. INSPECTION/ADJUSTMENT

SIDE STAND

Perform the following maintenance in accordance with the maintenance schedule.

Functional check:

Check the spring for damage or loss of tension and the side stand assembly for freedom of movement.

Check the side stand ignition cut-off system:

1. Place the scooter on its center stand.
2. Put the side stand up and start the engine.
3. Lower the side stand. The engine should stop as you put the side stand down.

If the side stand system does not operate as described, see your KYMCO dealer for service.

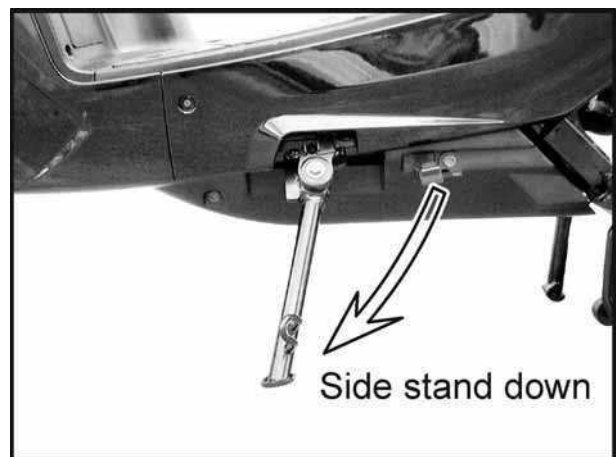
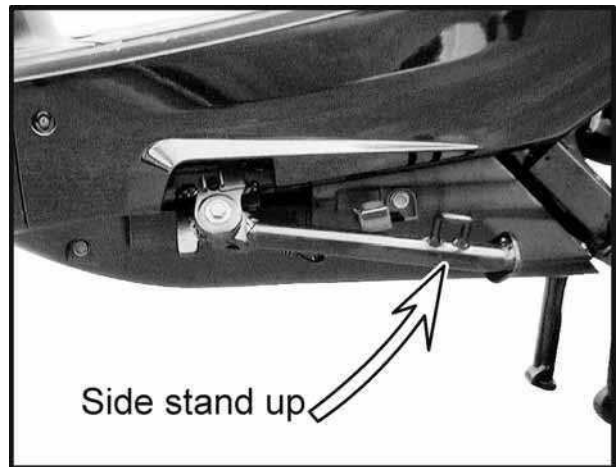

4. LUBRICATION SYSTEM

LUBRICATION SYSTEM

LUBRICATION SYSTEM DIAGRAM -----	4-1
SERVICE INFORMATION-----	4-2
TROUBLESHOOTING-----	4-2
OIL PUMP -----	4-3

LUBRICATION SYSTEM DIAGRAM

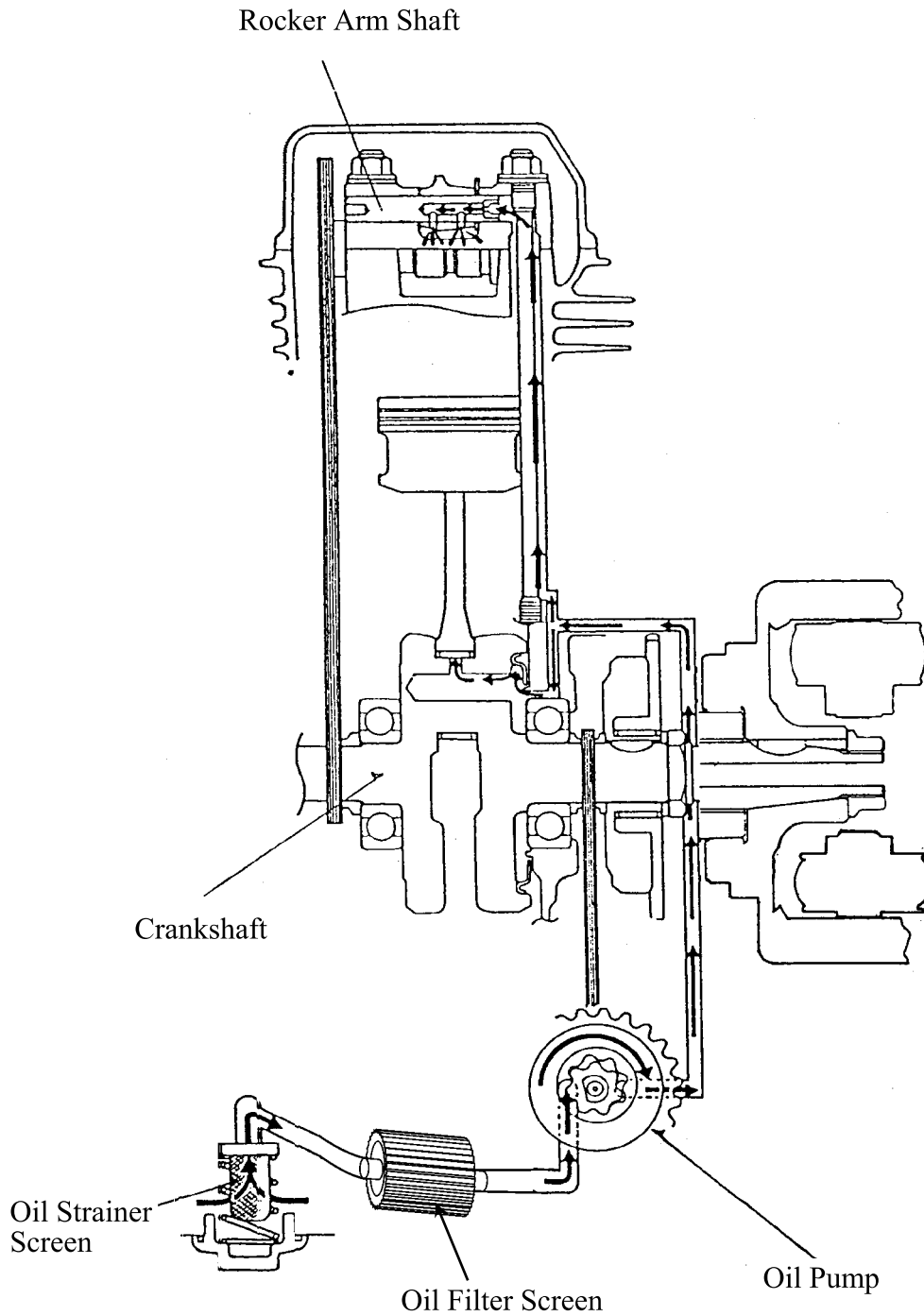

4. LUBRICATION SYSTEM

SERVICE INFORMATION

GENERAL INSTRUCTIONS

- The maintenance of lubrication system can be performed with the engine installed in the frame.
- Drain the coolant before starting any operations.
- Use care when removing and installing the oil pump not to allow dust and foreign matters to enter the engine and oil line.
- Do not attempt to disassemble the oil pump. The oil pump must be replaced as a set when it reaches its service limit.
- After the oil pump is installed, check each part for oil leaks.

SPECIFICATIONS

Unit: mm (in)

	Standard	Service Limit
Inner rotor-to-outer rotor clearance	0.15 (0.006)	0.2 (0.008)
Outer rotor-to-pump body clearance	0.15~0.2 (0.006~0.008)	0.25 (0.01)
Rotor end-to-pump body clearance	0.04~0.09 (0.0016~0.0036)	0.12 (0.0048)

ENGINE OIL

Engine Oil Capacity	At disassembly:	1.1 liter (0.97 lmp qt, 1.17 US qt)
	At change:	0.9 liter (0.79 lmp qt, 0.95 US qt)
Recommended Oil	SAE10W30# API: SG	

TROUBLESHOOTING

Oil level too low

- Natural oil consumption
- Oil leaks
- Worn piston rings
- Worn valve guide
- Worn valve guide seal

Poor lubrication pressure

- Oil level too low
- Clogged oil filter or oil passage
- Faulty oil pump

Oil contamination

- Oil not changed often enough
- Faulty cylinder head gasket
- Loose cylinder head bolts

4. LUBRICATION SYSTEM

OIL PUMP

REMOVAL

Remove the flywheel and driven gear (refer to the “**STARTER CLUTCH**” section in the chapter 10).

Remove the bolt and then oil separator cover.

* When removing and installing the oil pump, use care not to allow dust or dirt to enter the engine.

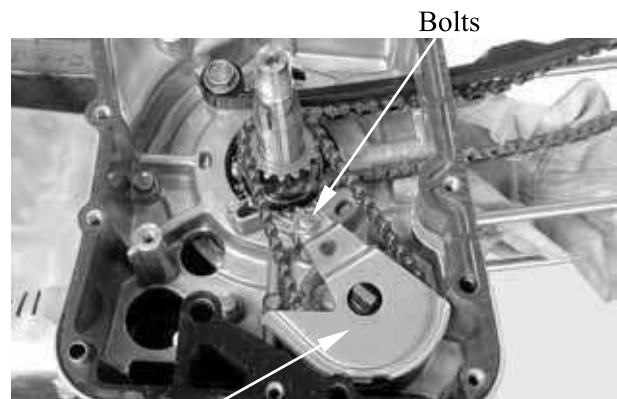

Oil Separator Cover

Pry the snap ring off and remove the oil pump driven gear, then remove the oil pump drive chain.



Snap Ring

Oil Pump Driven Gear

Remove the two oil separator bolts to remove the oil pump.

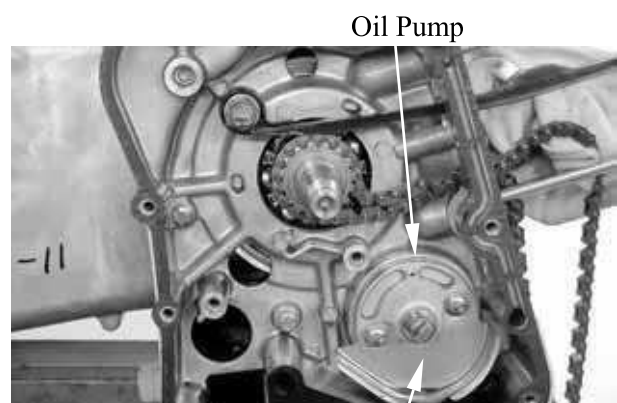

Oil Pump

Oil Separator

4. LUBRICATION SYSTEM

INSTALLATION

Install the oil pump and oil separator and tighten the two bolts.

- * Make sure the pump shaft rotates freely and arrow on the oil pump is upside.

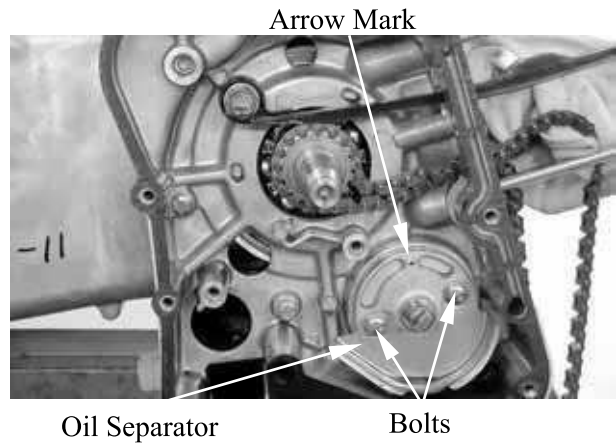

Install the pump drive chain and driven gear, then set the snap ring securely on the pump shaft.

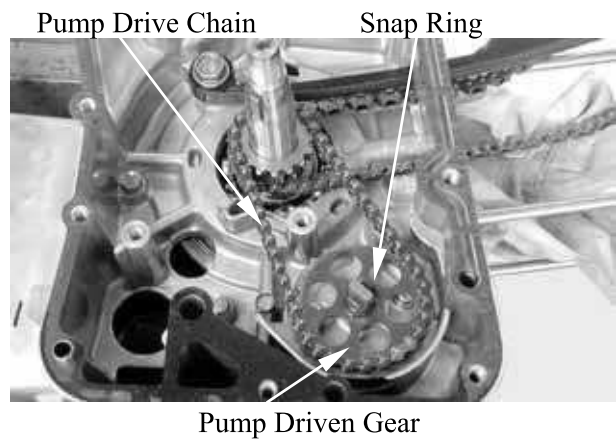

Install the oil separator cover properly.

- * Fit the tab of the separator cover into the slit in the separator.

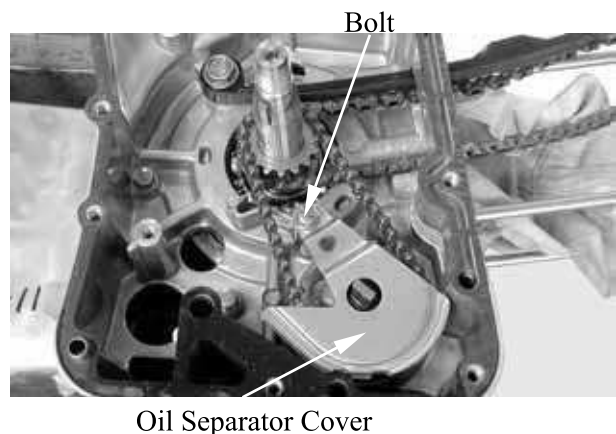

4. LUBRICATION SYSTEM

DINK 200i/125

DISASSEMBLY

Remove the screw and disassemble the oil pump as shown.

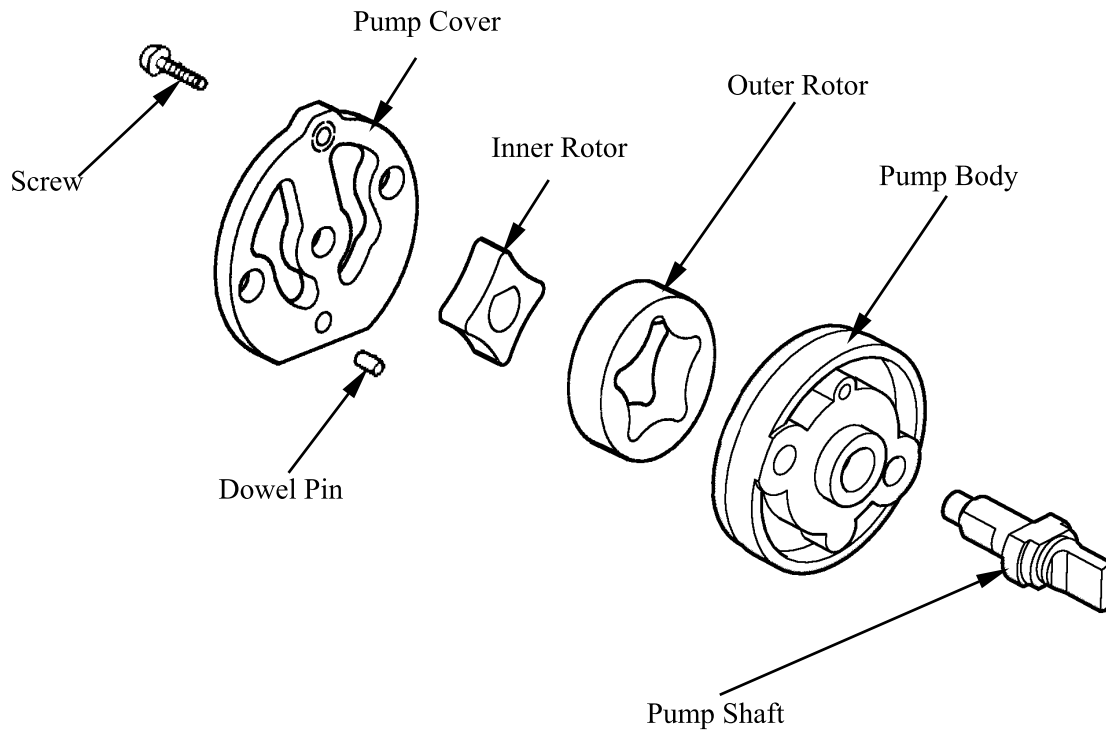

INSPECTION

Measure the pump body-to-outer rotor clearance.

Service Limit: 0.25 mm (0.01 in)

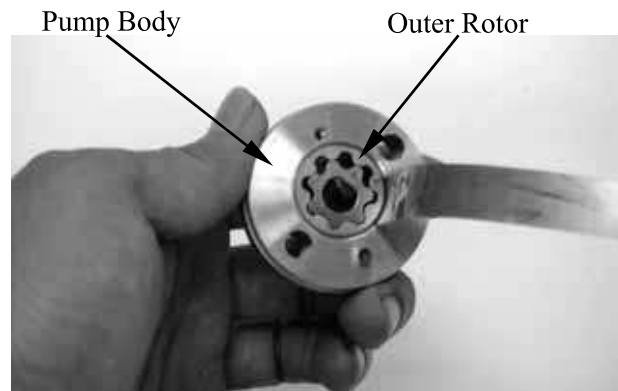

4. LUBRICATION SYSTEM

Measure the inner rotor-to-outer rotor clearance.

Service Limit: 0.2 mm (0.008 in)

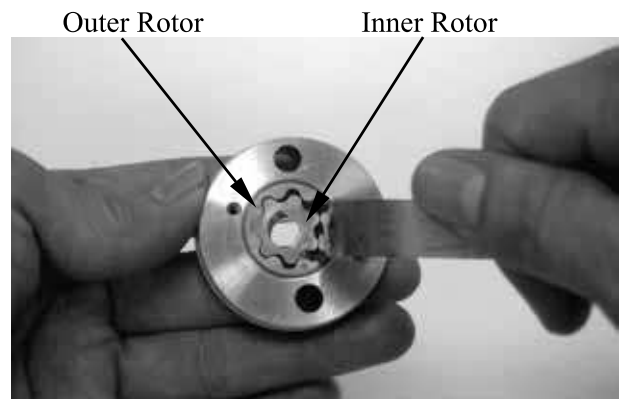

Measure the rotor end-to-pump body clearance.

Service Limit: 0.12 mm (0.0048 in)

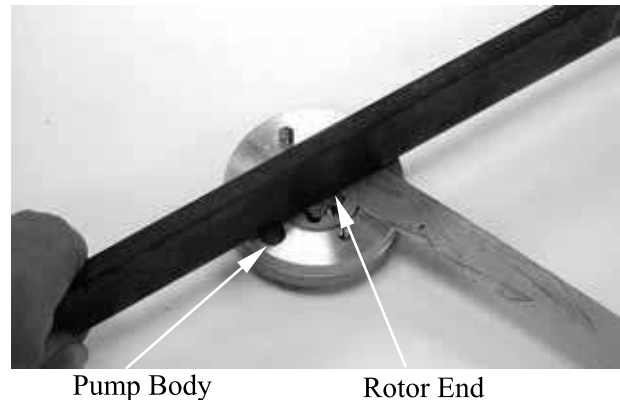

ASSEMBLY

Install the outer rotor, inner rotor and pump shaft into the pump body.

* Insert the pump shaft by aligning the flat on the shaft with the flat in the inner rotor. Install the dowel pin.

There is one punch mark on the surface of the inner rotor and outer rotor.

The mark is upside.

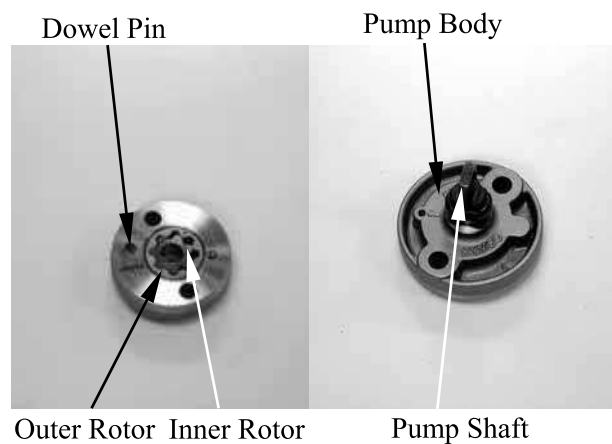

ENGINE REMOVAL/INSTALLATION

SERVICE INFORMATION-----	5-1
ENGINE REMOVAL/INSTALLATION-----	5-2
ENGINE HANGER -----	5-9

5. ENGINE REMOVAL/INSTALLATION

SERVICE INFORMATION

GENERAL INSTRUCTIONS

- A floor jack or other adjustable support is required to support and maneuver the engine. Be careful not to damage the scooter body, cables and wires during engine removal.
- Use shop towels to protect the scooter body during engine removal.
- Drain the coolant before removing the engine.
- After the engine is installed, fill the cooling system with coolant and be sure to bleed air from the water jacket. Start the engine to check for coolant leaks.
- Before removing the engine, the rear brake caliper must be removed first. Be careful not to bend or twist the brake fluid tube.

SPECIFICATIONS

Engine oil capacity: at disassembly: 1.1 L (0.968 Imp qt, 1.166 US qt)
: at change: 0.9 L (0.792 Imp qt, 0.954 US qt)

Coolant capacity:

Radiator capacity : 1 liter (1.1 US qt, 0.88 Imp qt)

Reserve tank capacity : 0.37 liter (0.4 US qt, 0.33 Imp qt)

TORQUE VALUES

Engine mounting bolt/nut : 5 kgf-m (50 N-m, 36 lbf-ft)

Engine hanger mounting bolt : 5 kgf-m (50 N-m, 36 lbf-ft)

5. ENGINE REMOVAL/INSTALLATION

DINK200i/DINK 125

ENGINE REMOVAL/INSTALLATION

REMOVAL

- **DINK 125 only:**
Remove the air cleaner (refer to the “**AIR CLEANER**” section in the chapter 13).

Remove the carburetor (refer to the “**CARBURETOR**” section in the chapter 13).

- **DINK 200i only:**
Remove the air cleaner (refer to the “**AIR CLEANER**” section in the chapter 14)

Remove the two bolts from the intake manifold.

Disconnect the O2 heater/O2 sensor connector (refer to the “**EXHAUST MUFFLER**” section in the chapter 2).

- **DINK 200i only:**
Remove a bolt from fuel hose guide (1). Disconnect the fuel hose (2) from fuel injector.
Disconnect the fuel vacuum hose (3) and AICV vacuum hose (4) from the intake manifold.
Disconnect the WTS connector (5) from WTS.
Disconnect the coolant temperature sensor connector (6) from coolant temperature sensor.
Remove the throttle body and intake manifold together from the cylinder head.

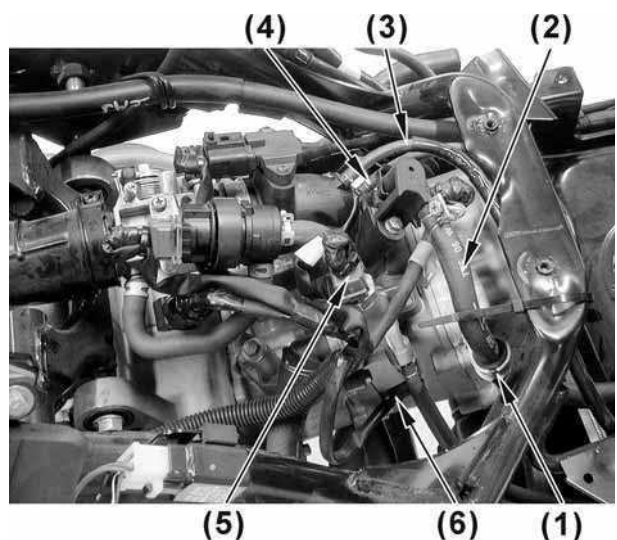
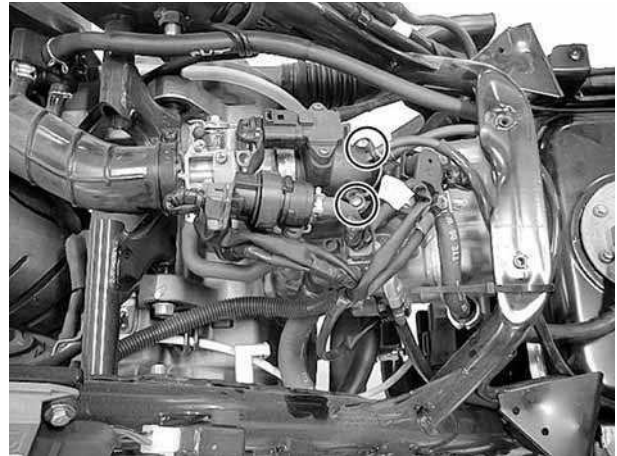

5. ENGINE REMOVAL/INSTALLATION

Loosen the rear axle nut.
Support the scooter securely on its main stand.

Remove the three bolts (1) from rear brake hose clamps.
Remove the two bolts (2), then remove the rear brake caliper.

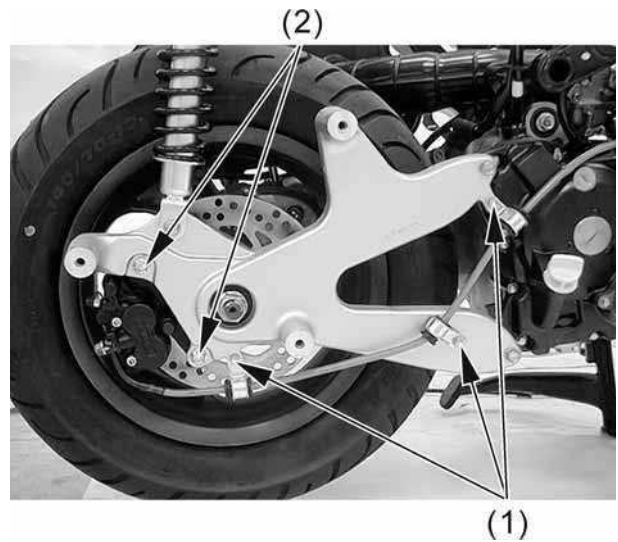

Disconnect the alternator connector (3).
Disconnect the ignition pulse generator connector (4).

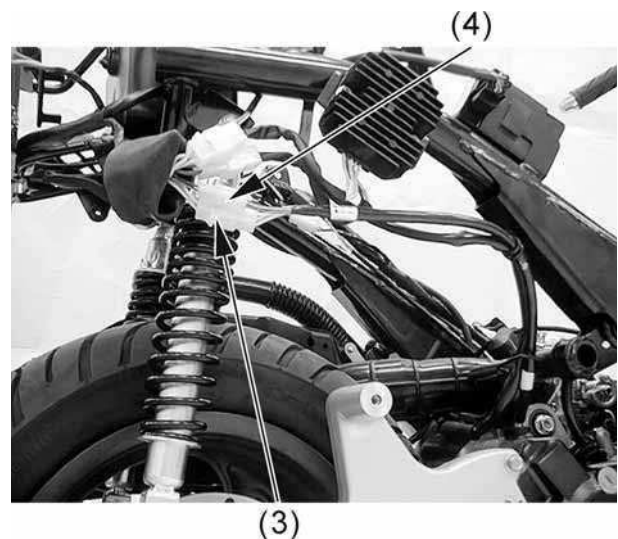

Release the rubber cap and remove the terminal screw (5) to disconnect the start motor cable from the start motor.

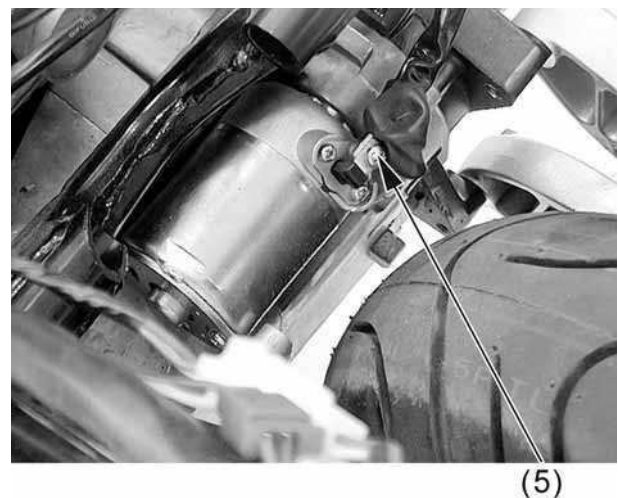

5. ENGINE REMOVAL/INSTALLATION

DINK200i/DINK 125

Remove the bolt (6) and engine ground cable.

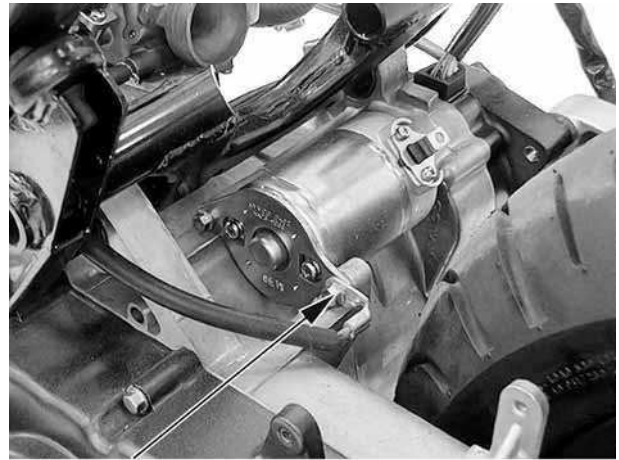

(6)

DINK 125 only:

Remove the two nuts (7), then remove the intake manifold from cylinder head.

Remove the bolt (8), then remove the thermostat from cylinder head.

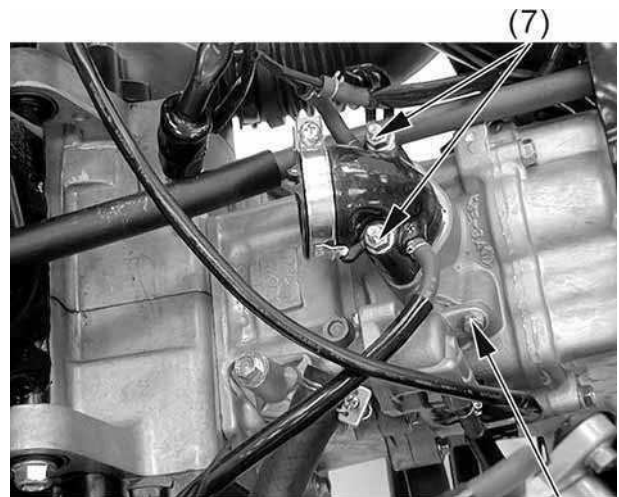

(7)

(8)

Remove the spark plug cap (9).

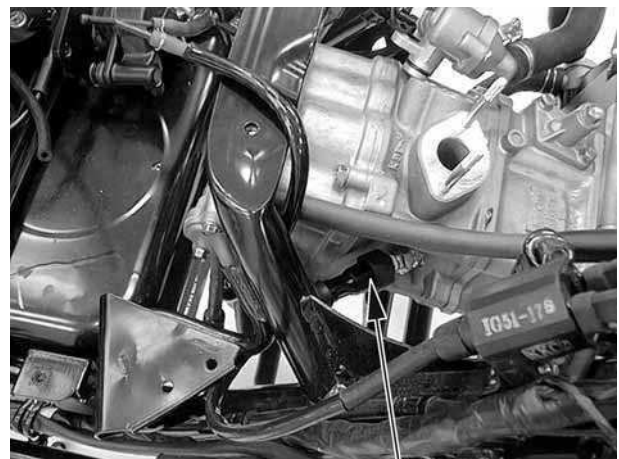

(9)

5. ENGINE REMOVAL/INSTALLATION

Disconnect the air supply hose (10) from cylinder head cover.

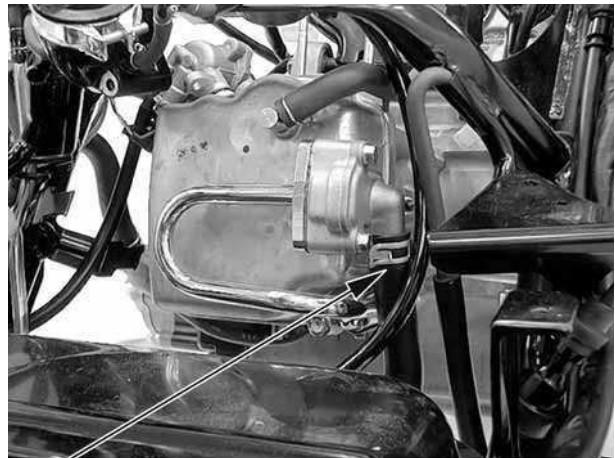

(10)

Disconnect the lower radiator hose (11) from lower radiator pipe.

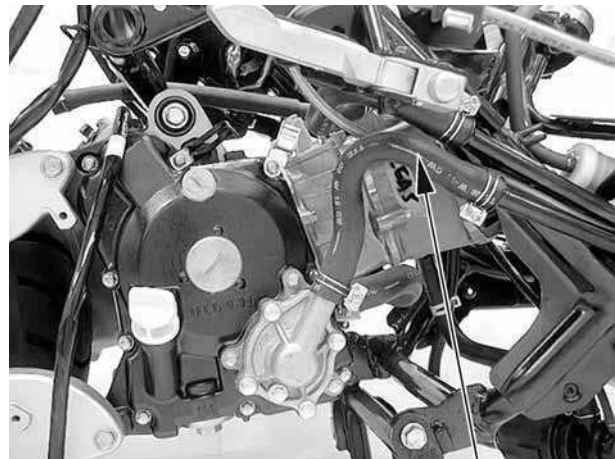

(11)

Remove the right and left rear shock absorber lower mount bolts (12).

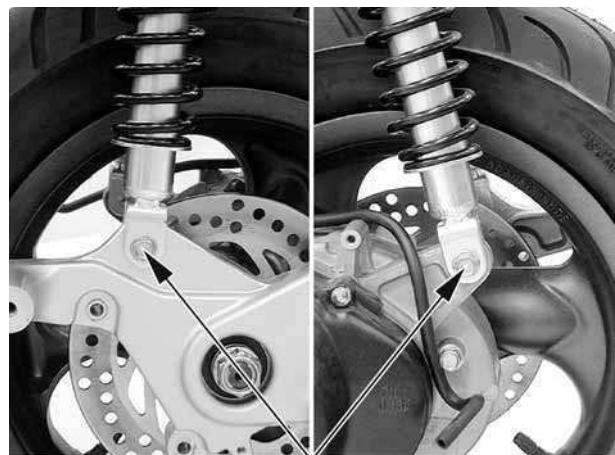

(12)

5. ENGINE REMOVAL/INSTALLATION

Remove the engine mount nut (13).
Pull out the engine mount bolt.

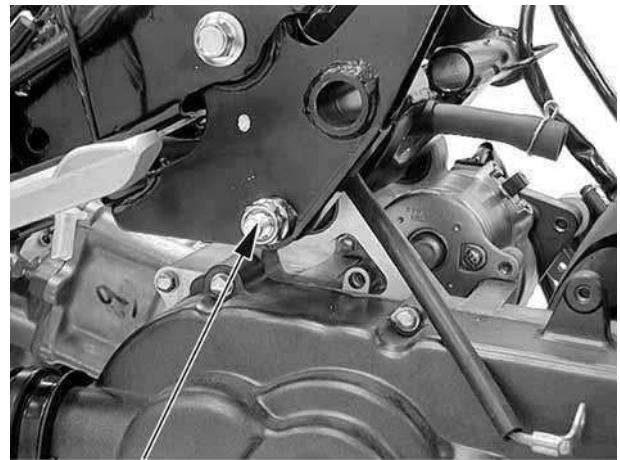

(13)

Remove the engine from the frame.



• At removing the engine, be careful not to catch your hand or finger between the engine hanger and crankcase.



5. ENGINE REMOVAL/INSTALLATION

INSTALLATION

Installation is in the reverse order of removal.

Tighten the engine mounting bolt/nut to the specified torque.

Torque: 5 kgf-m (50 N-m, 36 lbf-ft)

Tighten the right and left rear shock absorber lower mount bolts to the specified torque.

Torque: 2.7 kgf-m (27 N-m, 19 lbf-ft)

Install the rear brake caliper and tighten the mount bolts to the specified torque.

Torque: 3.2 kgf-m (32 N-m, 23 lbf-ft)

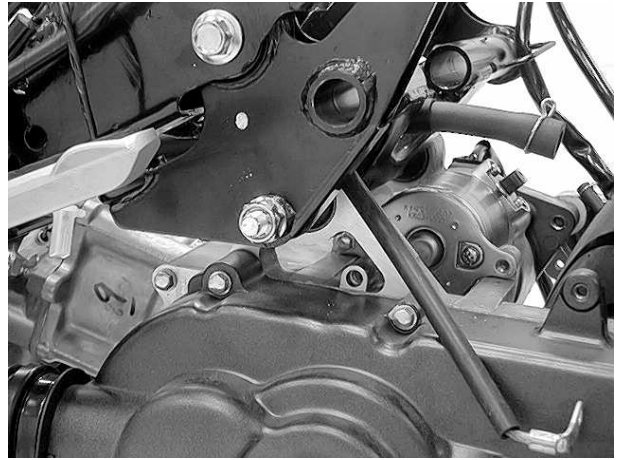

• Do not lose the O-rings (1) and (2) on the thermostat and intake manifold.

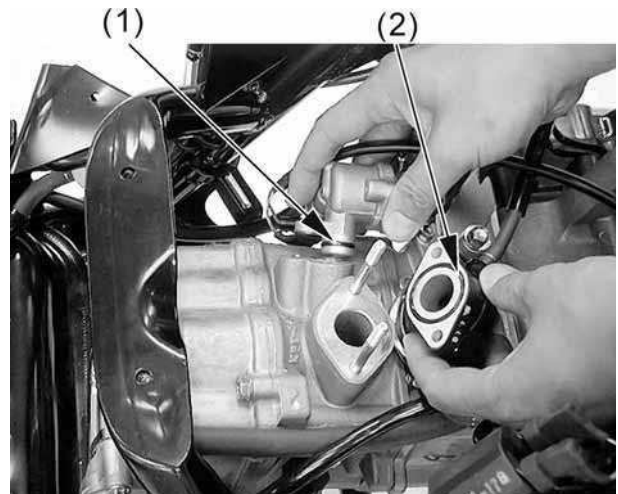

After installation, inspect and adjust the following:

- Throttle grip free play
- Fill the cooling system with coolant and start the engine to bleed air from the system.

5. ENGINE REMOVAL/INSTALLATION

INSPECTION

Inspect the engine mount bolt:
Band/Damage → Replace

- Do not attempt to straighten a bent engine mount bolt.



5. ENGINE REMOVAL/INSTALLATION

ENGINE HANGER

REMOVAL

Remove the engine mount nut (1).
Pull the engine mount bolt (2) out.

- Be careful to put the engine down.

Remove the left engine hanger mount bolt (3).
Remove the right engine hanger mount bolt and collar (4).
Remove the engine from frame.

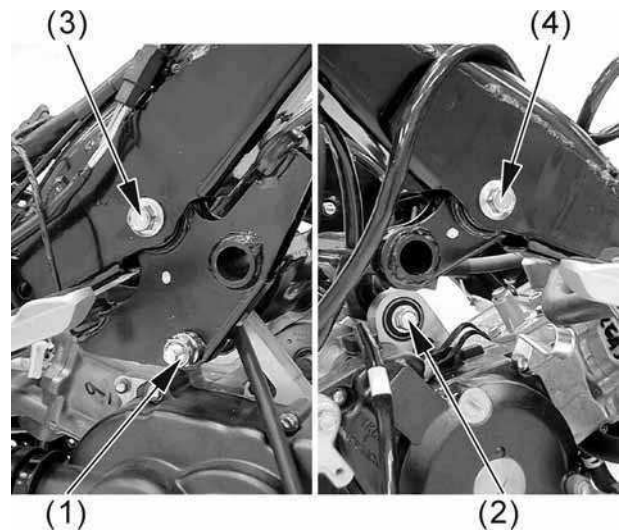

INSTALLATION

Installation is in the reverse order of removal.

Tighten the engine hanger mount bolts to the specified torque.

Torque: 5 kgf-m (50 N-m, 36 lbf-ft)

Tighten the engine mount bolt/nut to the specified torque.

Torque: 5 kgf-m (50 N-m, 36 lbf-ft)

INSPECTION

Inspect the engine hanger bushings (1) and stopper rubber (2) for wear or damage.

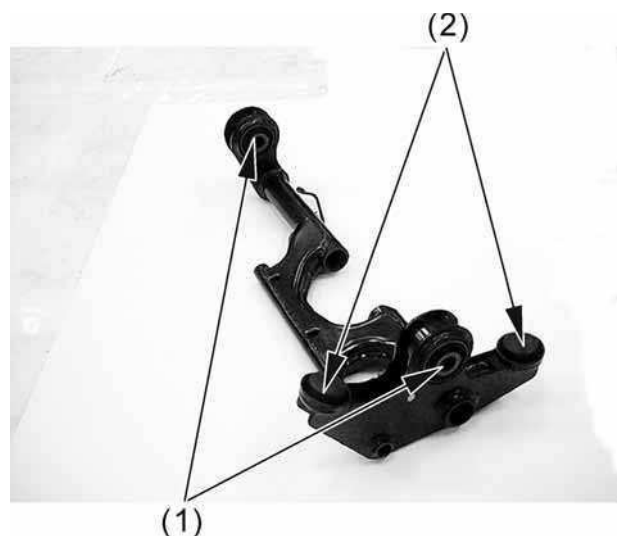

6. CYLINDER HEAD/VALVES



CYLINDER HEAD/VALVES

6

SCHEMATIC DRAWING -----	6- 1
SERVICE INFORMATION-----	6- 2
TROUBLESHOOTING-----	6- 3
CYLINDER HEAD COVER-----	6- 4
CAMSHAFT HOLDER-----	6- 5
CAMSHAFT -----	6- 8
CYLINDER HEAD-----	6-12

6. CYLINDER HEAD/VALVES

DINK 200i/125

SCHEMATIC DRAWING

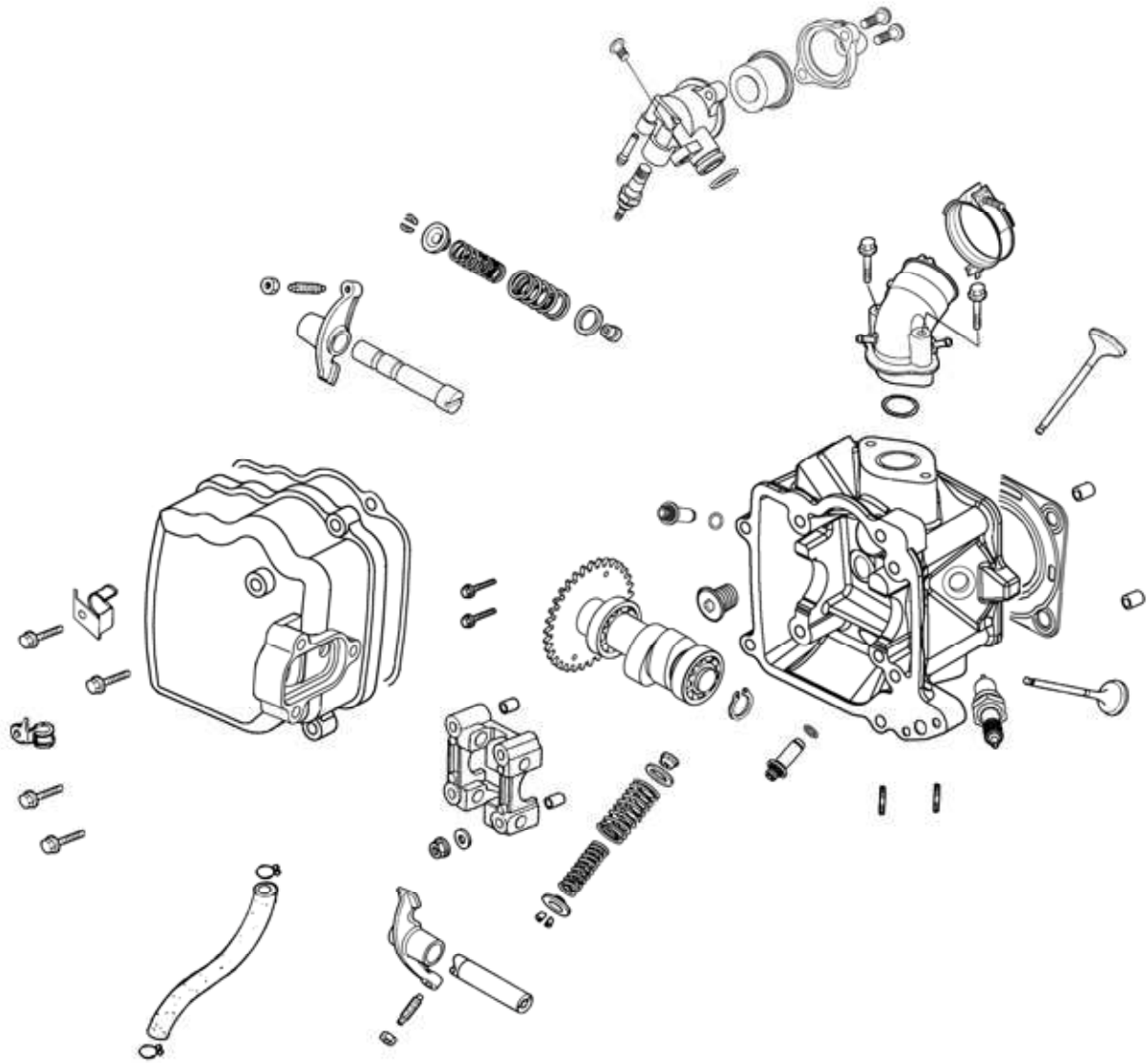

6. CYLINDER HEAD/VALVES

DINK 200i/125

SERVICE INFORMATION

GENERAL INSTRUCTIONS

- The cylinder head can be serviced with the engine installed in the frame. Coolant in the radiator and water jacket must be drained first.
- When assembling, apply molybdenum disulfide grease or engine oil to the valve guide movable parts and valve arm sliding surfaces for initial lubrication.
- The valve rocker arms are lubricated by engine oil through the cylinder head engine oil passages. Clean and unclog the oil passages before assembling the cylinder head.
- After disassembly, clean the removed parts and dry them with compressed air before inspection.
- After removal, mark and arrange the removed parts in order. When assembling, install them in the reverse order of removal.

SPECIFICATIONS

Unit: mm (in)

Item		Standard	Service Limit
Valve clearance (cold)	IN	0.1 (0.004)	—
	EX	0.1 (0.004)	—
Cylinder head compression pressure	DINK 200i	16 kg/cm ² (1600 kpa, 227.2 psi)	—
	DINK 125	15 kg/cm ² (1500 kpa, 213 psi)	—
Cylinder head warpage		—	0.05 (0.002)
Camshaft cam height	DINK 200i	IN	31.2365 (1.24946)
		EX	30.9262 (1.237048)
	DINK 125	IN	30.8763 (1.235052)
		EX	30.4081 (1.216324)
Valve rocker arm I.D.	IN	10 ~ 10.018 (0.4 ~ 0.40072)	10.1 (0.404)
	EX	10 ~ 10.018 (0.4 ~ 0.40072)	10.1 (0.404)
Valve rocker arm shaft O.D.	IN	9.972 ~ 9.987 (0.39888 ~ 0.39948)	9.9 (0.396)
	EX	9.972 ~ 9.987 (0.39888 ~ 0.39948)	9.9 (0.396)
Valve stem O.D.	IN	4.99 ~ 4.975 (0.1996 ~ 0.199)	4.925 (0.197)
	EX	4.97 ~ 4.955 (0.1988 ~ 0.1982)	4.915 (0.1966)
Valve guide I.D.	IN	5 ~ 5.012 (0.2 ~ 0.20048)	5.03 (0.2012)
	EX	5 ~ 5.012 (0.2 ~ 0.20048)	5.03 (0.2012)
Valve stem-to-guide clearance	IN	0.01 ~ 0.037 (0.0004 ~ 0.00148)	0.08 (0.0032)
	EX	0.03 ~ 0.057 (0.0012 ~ 0.00228)	0.1 (0.004)

TORQUE VALUES

Cylinder head cover bolt	1.2 kgf-m (12 N-m, 8.6 lbf-ft)
Tensioner mounting bolt	0.9 kgf-m (9 N-m, 6.5 lbf-ft)
Tensioner sealing bolt	0.9 kgf-m (9 N-m, 6.5 lbf-ft)
Cylinder head cap nut (DINK 200i)	2.3 kgf-m (23 N-m, 16.6 lbf-ft)
	Apply engine oil to threads
Cylinder head cap nut (DINK 125)	2 kgf-m (20 N-m, 14.4 lbf-ft)
	Apply engine oil to threads
Cylinder head bolt	1 kgf-m (10 N-m, 7.2 lbf-ft)

SPECIAL TOOLS

Valve spring compressor A120E00040

TROUBLESHOOTING

- The poor cylinder head operation can be diagnosed by a compression test or by tracing engine top-end noises.

Poor performance at idle speed

- Compression too low

Compression too low

- Incorrect valve clearance adjustment
- Burned or bent valves
- Incorrect valve timing
- Broken valve spring
- Poor valve and seat contact
- Leaking cylinder head gasket
- Warped or cracked cylinder head
- Poorly installed spark plug

Compression too high

- Excessive carbon build-up in combustion chamber

White smoke from exhaust muffler

- Worn valve stem or valve guide
- Damaged valve stem oil seal

Abnormal noise

- Incorrect valve clearance adjustment
- Sticking valve or broken valve spring
- Damaged or worn camshaft
- Worn cam chain tensioner
- Worn camshaft and rocker arm

6. CYLINDER HEAD/VALVES

CYLINDER HEAD COVER

REMOVAL

Remove the two nuts (1) and four bolts (2), then remove the cylinder head cover.

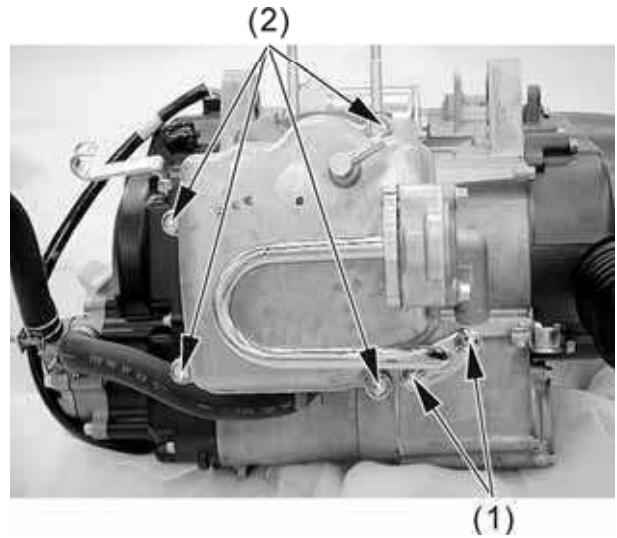

INSTALLATION

Install a new cylinder head cover O-ring and install the cylinder head cover.

* Be sure to install the O-ring into the groove properly.

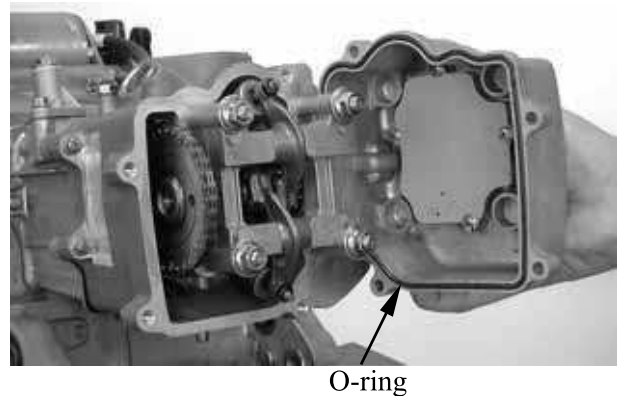

Install and tighten the cylinder head cover bolts and nuts to the specified torque in a crisscross pattern.

Torque: 1.2 kgf-m (12 N-m, 8.6 lbf-ft)

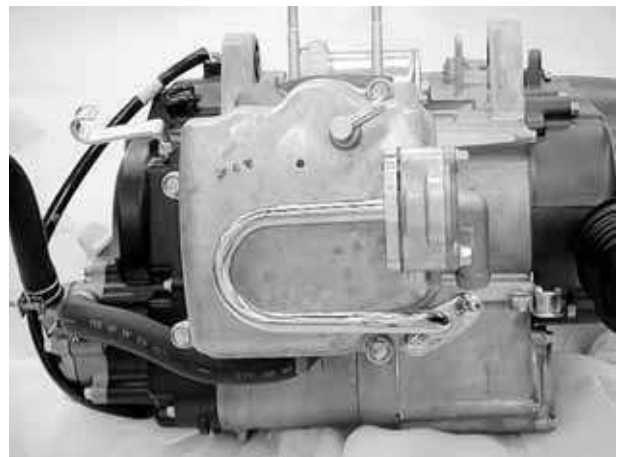

CAMSHAFT HOLDER

REMOVAL

Remove the four cap nuts/washers from camshaft holder.

- * • Diagonally loosen the cylinder head cap nuts in 2 or 3 times.

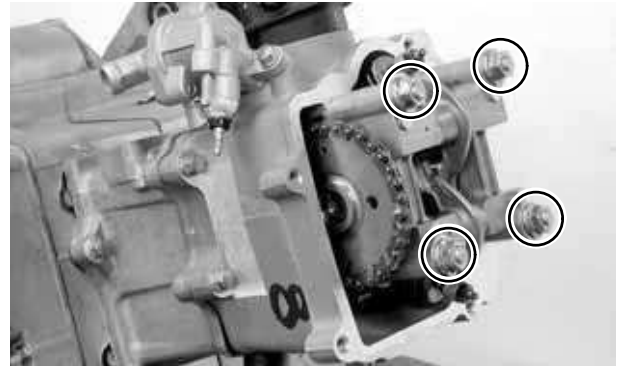

Remove the camshaft holder and two dowel pins.

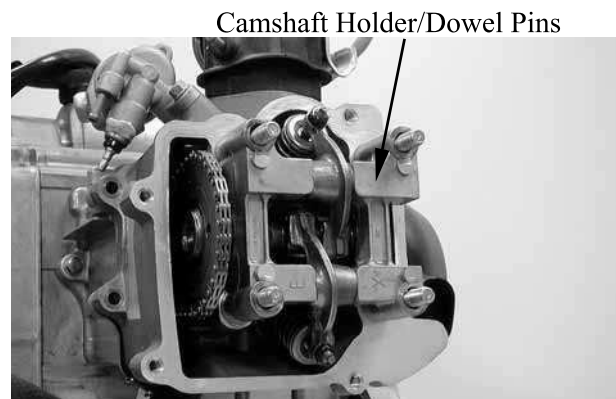

INSTALLATION

Install the camshaft holder, washers and nuts. Tighten the four cylinder head nuts to the specified torque.

Torque:

DINK 200i: 2.3 kgf-m (23 N-m, 16.6 lbf-ft)

DINK 125: 2 kgf-m (20 N-m, 14.4 lbf-ft)

- * • Install the camshaft holder with the “EX” mark face exhaust valve side.
• Apply engine oil to the threads of the cylinder head cap nuts.
• Diagonally tighten the cylinder head cap nuts in 2~3 times.

Adjust:

- valve clearance (refer to the “VALVE CLEARANCE” section in the chapter 3).

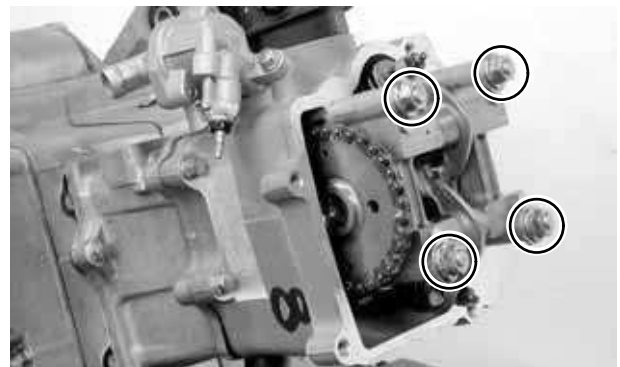

6. CYLINDER HEAD/VALVES

DINK 200i/125

DISASSEMBLY

Take out the valve rocker arm shafts using a 6mm bolt.
Remove the valve rocker arms.

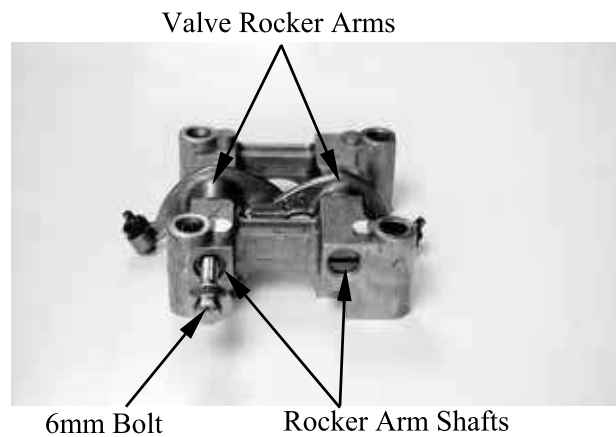

INSPECTION

Inspect the camshaft holder, valve rocker arms and rocker arm shafts for wear or damage.

* If the valve rocker arm contact surface is worn, check each cam lobe for wear or damage.

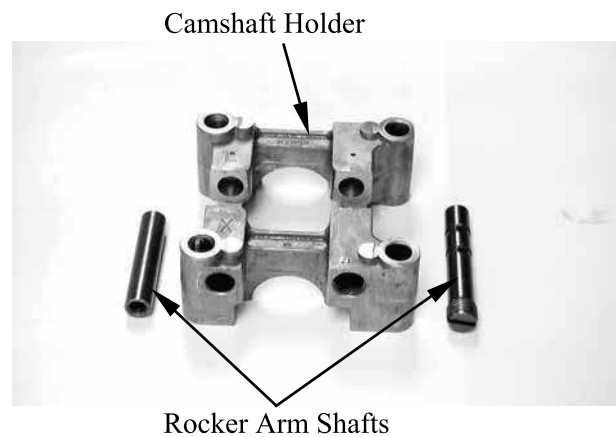

Inspect the rocker arm bore, cam lobe contact surface and adjuster surface for wear/pitting/scratches/blue discoloration.

If any defects are found, replace the rocker arm shaft with a new one, then inspect lubrication system.

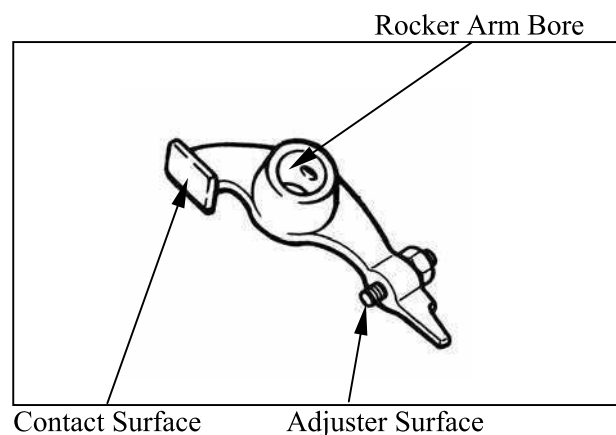

6. CYLINDER HEAD/VALVES

Measure the I.D. of each valve rocker arm.

Service Limits:

IN: 10.1 mm (0.404 in)

EX: 10.1 mm (0.404 in)

Measure each rocker arm shaft O.D.

Service Limits:

IN: 9.9 mm (0.396 in)

EX: 9.9 mm (0.396 in)

Measure arm to shaft clearance.

Replace as a set if out of specification.

Service limits: 0.1 mm (0.004 in)

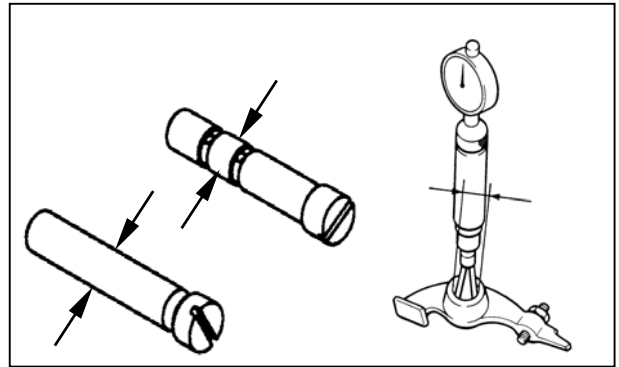

ASSEMBLY

Apply engine oil to the rocker arms and rocker arm shafts.

Install the rocker arms and shafts into the camshaft holder.

- *
- Install the exhaust valve rocker arm shaft on the “EX” side of the camshaft holder and the exhaust rocker arm shaft is shorter.
 - Clean the intake valve rocker arm shaft off any grease before installation.
 - Align the cutout on the exhaust valve rocker arm shaft with the bolt of the camshaft holder.

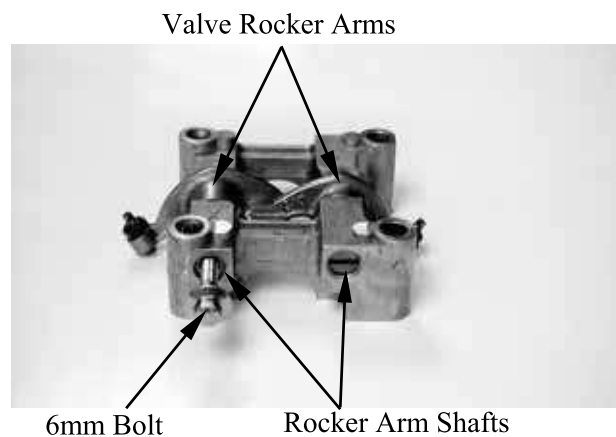

6. CYLINDER HEAD/VALVES

CAMSHAFT

REMOVAL

Turn the A.C. generator flywheel so that the “T” mark on the flywheel aligns with the index mark on the crankcase.
Hold the round hole on the camshaft gear facing up and the location is the top dead center on the compression stroke.

Remove the tensioner sealing bolt and spring.
Remove the two bolts from cam chain tensioner and then remove the tensioner and gasket.

Remove the camshaft holder (refer to the “**CAMSHAFT HOLDER**” section in this chapter).

Remove the camshaft from the cam chain.

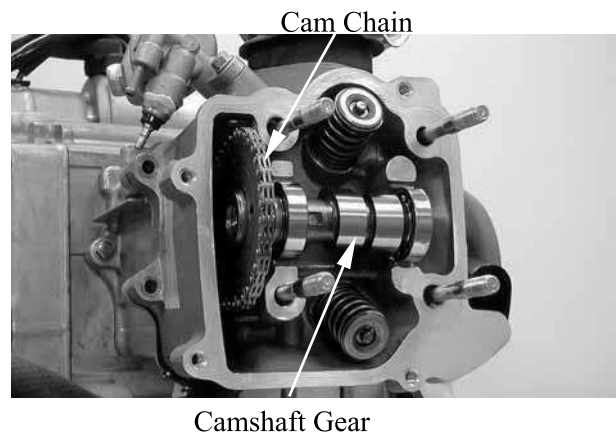
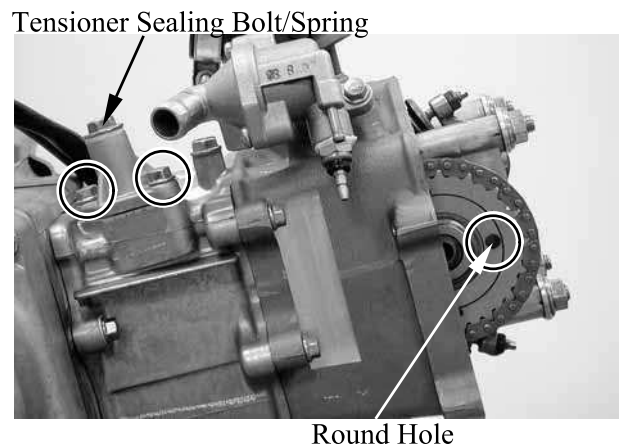

6. CYLINDER HEAD/VALVES

DINK 200i/125

INSPECTION

Camshaft

Inspect camshaft lobes for pitting/scratches/blue discoloration.

Measure the cam lobe height.

Service Limits:

DINK 200i: IN : 31.1 mm (1.244 in)

EX: 30.75 mm (1.23 in)

DINK 125: IN : 30.75 mm (1.23 in)

EX: 30.26 mm (1.2104 in)

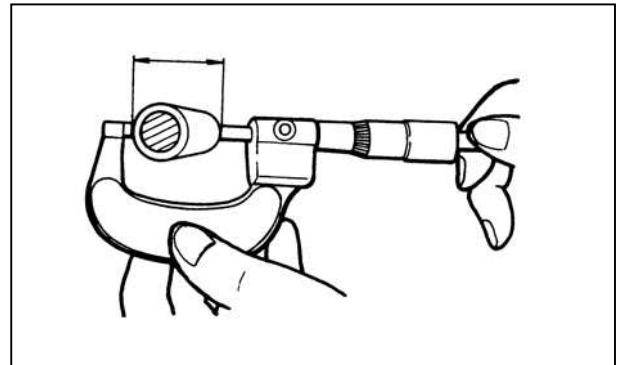

If any defects are found, replace the camshaft with a new one, then inspect lubrication system.

Check each camshaft bearing for play or damage. Replace the camshaft assembly with a new one if the bearings are noisy or have excessive play.

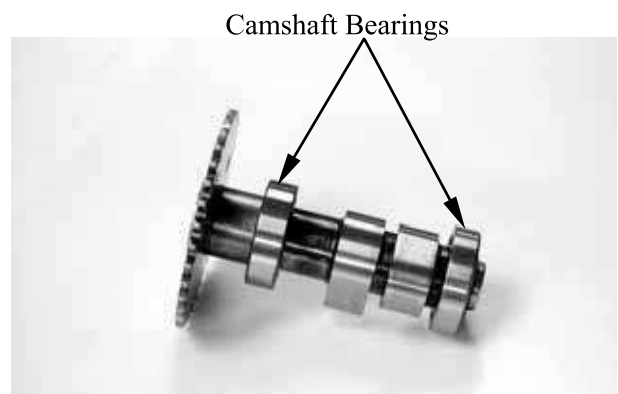

Cam chain tensioner

Check the one-way cam operation (tensioner)

Unsmooth operation → Replace.



6. CYLINDER HEAD/VALVES

INSTALLATION

Turn the A.C. generator flywheel so that the “T” mark on the flywheel aligns with the index mark on the crankcase.
Keep the round hole on the camshaft gear facing up and align the punch marks on the camshaft gear with the cylinder head surface (Position the intake and exhaust cam lobes down.) and install the cam chain over the camshaft gear.

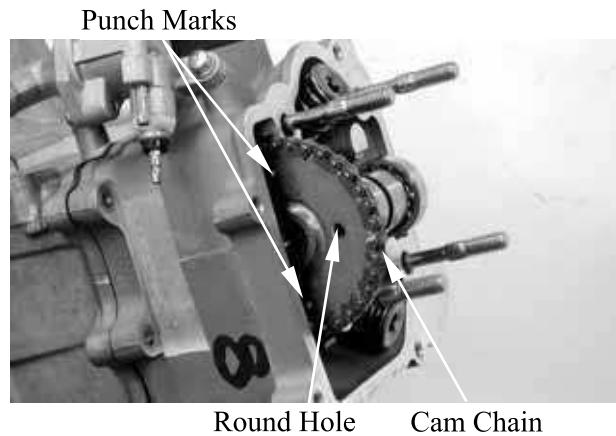

Install the dowel pins.

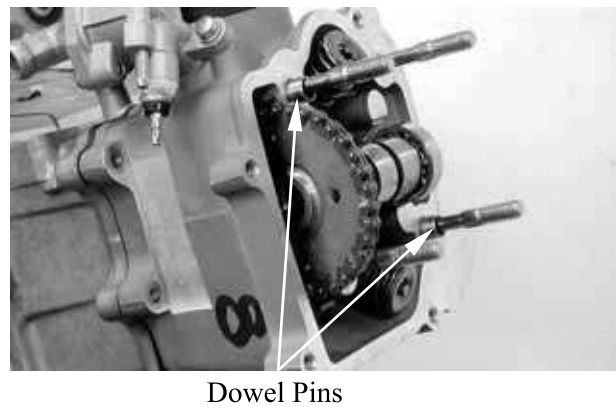

Install the camshaft holder (refer to the “CAMSHAFT HOLDER” section in this chapter).

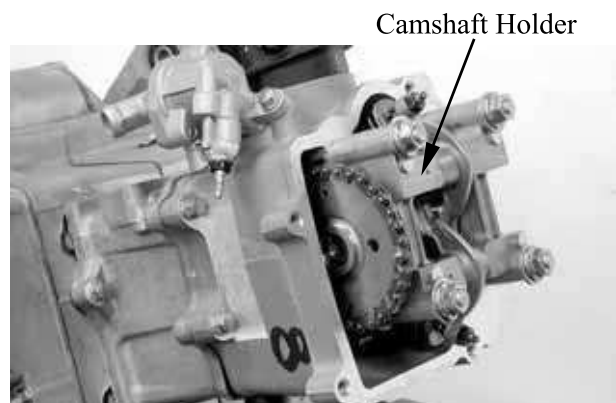

6. CYLINDER HEAD/VALVES

DINK 200i/125

Release the timing chain tensioner one-way cam and push the tensioner rod all the way in.



Install a new cam chain tensioner gasket.

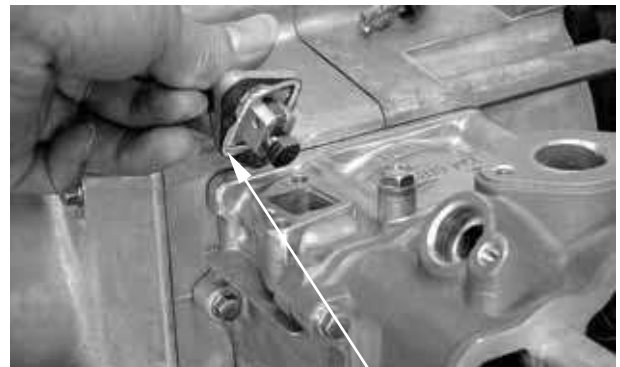

Gasket

Install the cam chain tensioner and tighten the two bolts to the specified torque.

Torque: 0.9 kgf-m (9 N-m, 6.5 lbf-ft)

Install the tensioner spring and tighten the sealing bolt.

Torque: 0.9 kgf-m (9 N-m, 6.5 lbf-ft)

Adjust:

- valve clearance (refer to the “VALVE CLEARANCE” section in the chapter 3).

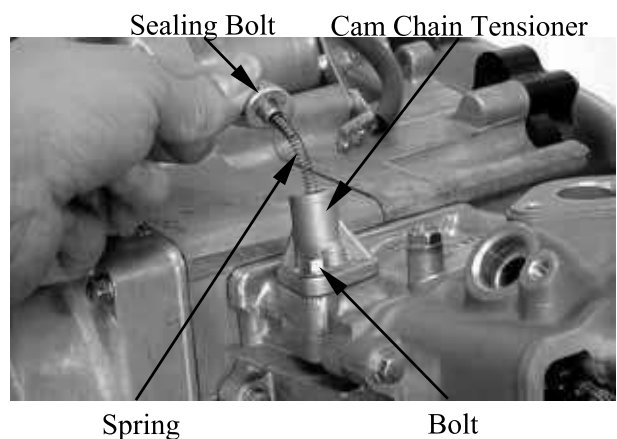

6. CYLINDER HEAD/VALVES

CYLINDER HEAD

REMOVAL

First drain the coolant from the radiator and water jacket (refer to the “**COOLING SYSTEM**” section in the chapter 3).

Remove the camshaft (refer to the “**CAMSHAFT REMOVAL**” section in this chapter).

Remove the two cylinder head bolts from the cylinder head.

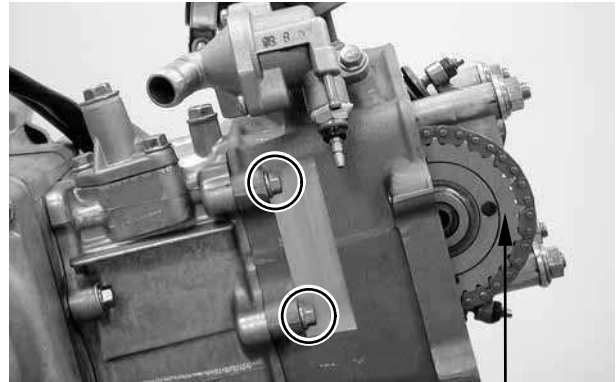

Camshaft

Remove the two nuts and intake manifold. Remove the bolt and then remove the thermostat.

Remove the cylinder head.



Intake Manifold

Thermostat

Remove the dowel pins and cylinder head gasket.

Remove the cam chain guide.

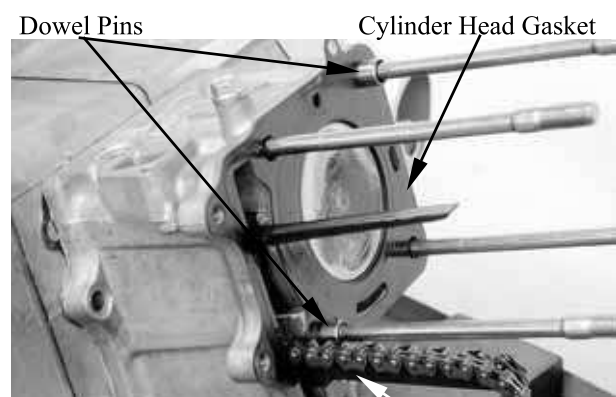

Dowel Pins

Cylinder Head Gasket

Cam Chain Tensioner Slipper

6. CYLINDER HEAD/VALVES

DINK 200i/125

INSTALLATION

Install the cam chain tensioner slipper.
Install two dowel pins.
Install the new gasket.

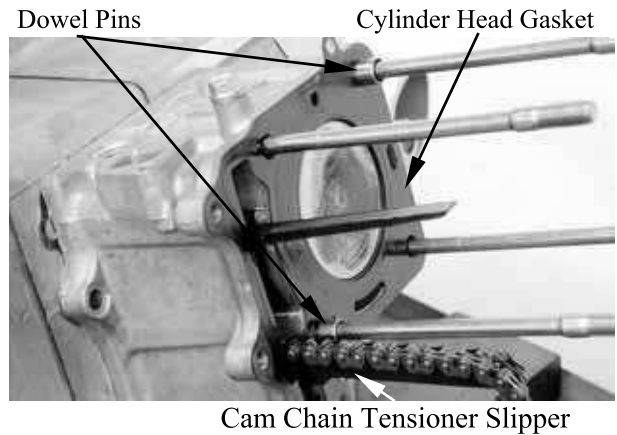

Install the cylinder head.
Install the intake manifold and tighten the two mounting nuts securely.
Install the thermostat and tighten the mounting bolt securely.

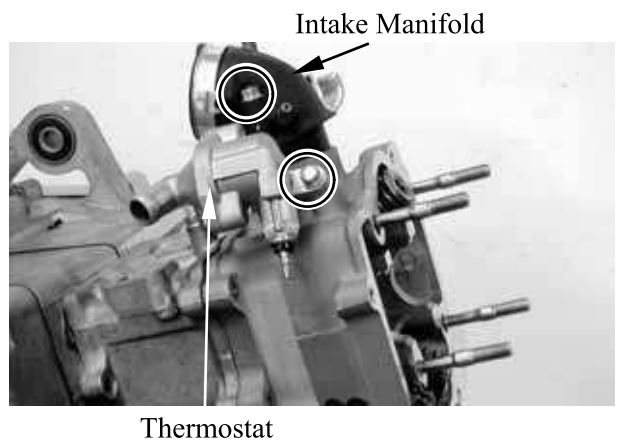

Install the camshaft (refer to the “CAMSHAFT” section in this chapter).

Install the camshaft holder (refer to the “CAMSHAFT HOLDER” section in this chapter).

Install and tighten the two cylinder head bolts to the specified torque.

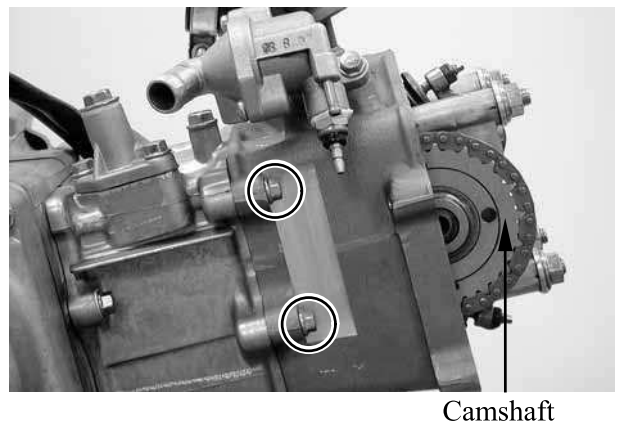

Torque: 1 kgf-m (10 N-m, 7.2 lbf-ft)

* Always first tighten the cylinder head cap nuts and then tighten the bolts between the cylinder and cylinder head to avoid cracks.

6. CYLINDER HEAD/VALVES

DISASSEMBLY

Remove the valve spring cotters, retainers, springs, spring seats, oil seals and valves using a valve spring compressor.

*

- Be sure to compress the valve springs with a valve spring compressor.
- Mark all disassembled parts to ensure correct reassembly.

Special tool:

Valve Spring Compressor A120E00040

Valve Spring Compressor

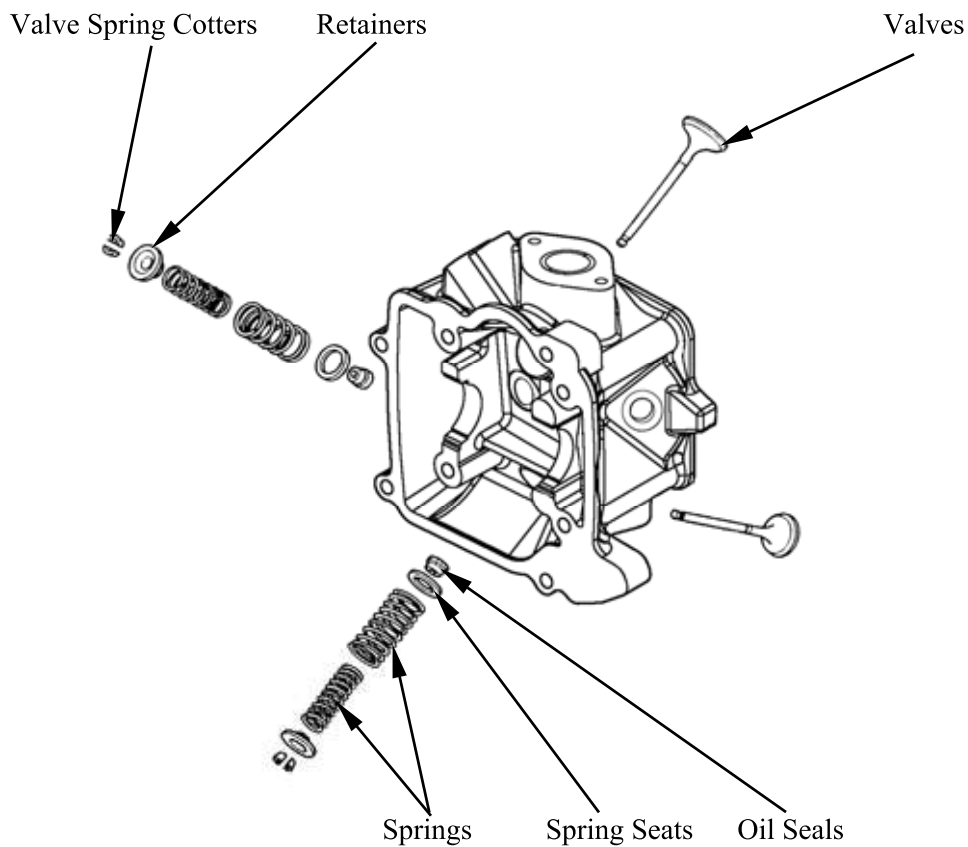
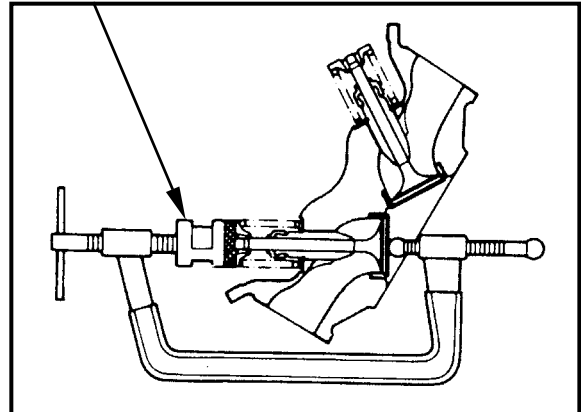

6. CYLINDER HEAD/VALVES

DINK 200i/125

INSPECTION

Remove carbon deposits from the exhaust port and combustion chamber.

* Be careful not to damage the cylinder head mating surface.

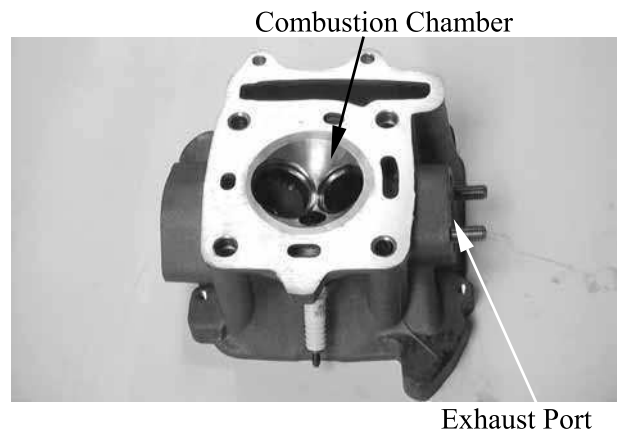

Valve /Valve guide

Inspect each valve for bending, burning, scratches or abnormal stem wear.
If any defects are found, replace the valve with a new one.

Check valve movement in the guide.

Measure each valve stem O.D.

Measure each valve guide I.D.

Subtract each valve stem O.D. from the corresponding guide I.D. to obtain the stem-to-guide clearance.

Service limits:

IN: 0.08 mm (0.0032 in)

EX: 0.1 mm (0.004 in)

* If the stem-to-guide clearance exceeds the service limits, replace the cylinder head is necessary.

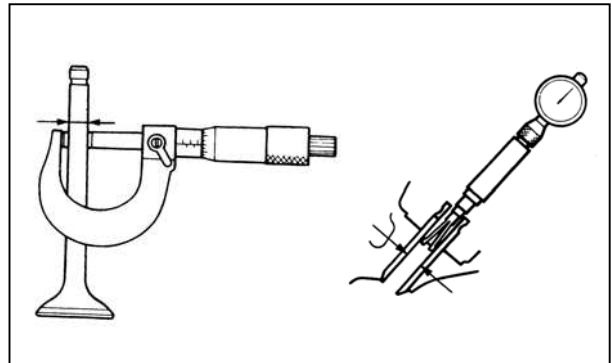

Valve spring

Measure the free length of the inner and outer valve springs.

Service Limit:

Inner: 29.3 mm (1.172 in)

Outer: 32 mm (1.28 in)

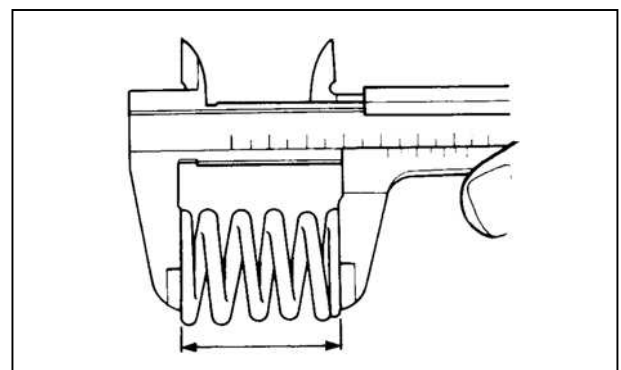

6. CYLINDER HEAD/VALVES

DINK 200i/125

Cylinder head

Check the spark plug hole and valve areas for cracks.

Check the cylinder head for warpage with a straight edge and feeler gauge.

Service Limit: 0.05 mm (0.002 in)

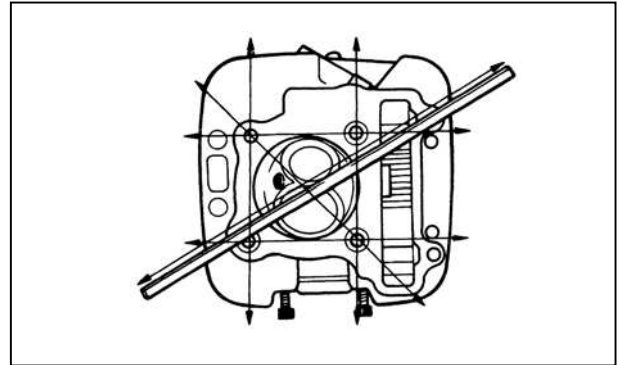

ASSEMBLY

Install the valve spring seats and oil seal.

* Be sure to install new oil seal.

Lubricate each valve with engine oil and insert the valves into the valve guides. Install the valve springs and retainers. Compress the valve springs using the valve spring compressor, then install the valve cotters.

Valve Spring Compressor

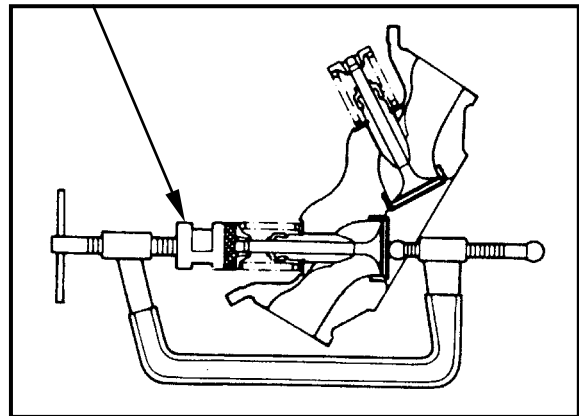

* • When assembling, a valve spring compressor must be used.
• Install the cotters with the pointed ends facing down from the upper side of the cylinder head.

Special tool:

Valve Spring Compressor A120E00040

Tap the valve stems gently with a plastic hammer for 2~3 times to firmly seat the cotters.

* Be careful not to damage the valves.

Plastic Hammer

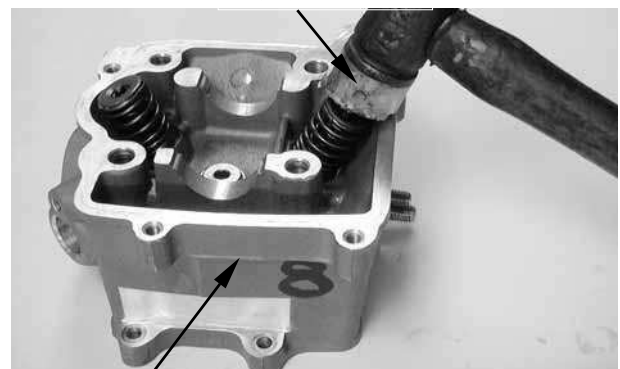

Cylinder Head

7. CYLINDER/PISTON

CYLINDER/PISTON

SCHEMATIC DRAWING	7-1
SERVICE INFORMATION.....	7-2
TROUBLESHOOTING.....	7-3
CYLINDER AND PISTON	7-4



7. CYLINDER/PISTON

DINK 200i/125

SCHEMATIC DRAWING

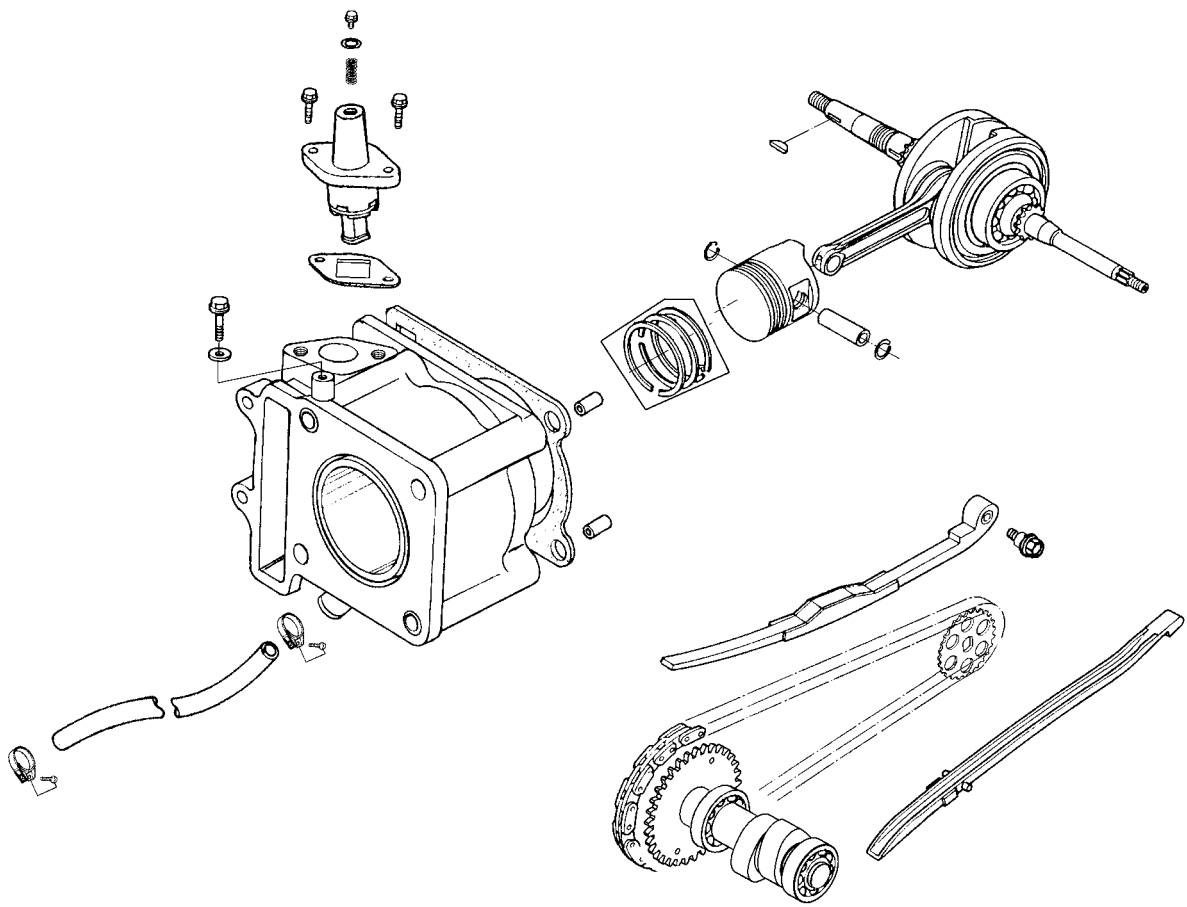

7. CYLINDER/PISTON

DINK 200i/125

SERVICE INFORMATION

GENERAL INSTRUCTIONS

- The cylinder and piston can be serviced with the engine installed in the frame.
- When installing the cylinder, use a new cylinder gasket and make sure that the dowel pins are correctly installed.
- After disassembly, clean the removed parts and dry them with compressed air before inspection.

SPECIFICATIONS

Unit: mm (in)

Item			Standard	Service Limit
Cylinder	I.D.	DINK 200i	62~62.015 (2.48~2.4806)	62.1 (2.484)
		DINK 125	52.4~52.41 (2.096~2.0964)	52.5 (2.1)
	Warpage		—	0.05 (0.002)
	Cylindricity		—	0.05 (0.002)
	True roundness		—	0.05 (0.002)
Piston, piston ring	Ring-to-groove clearance	Top	0.015~0.05 (0.006~0.002)	0.09 (0.0036)
		Second	0.015~0.05 (0.006~0.002)	0.09 (0.0036)
	Ring end gap	Top	0.15~0.3 (0.006~0.012)	0.5 (0.02)
		Second	0.15~0.3 (0.006~0.012)	0.5 (0.02)
		Oil side rail	0.2~0.9 (0.008~0.036)	—
	Piston O.D.	DINK 200i	61.995~61.975 (2.4878~2.479)	61.9 (2.476)
		DINK 125	52.37~52.39 (2.0948~2.0956)	52.3 (2.092)
	Piston O.D. measuring position	DINK 200i	5 mm (0.2 in) from bottom of skirt	—
		DINK 125	9 mm (0.36 in) from bottom of skirt	—
	Piston-to-cylinder clearance			0.01~0.04 (0.0004~0.0016)
Piston pin hole I.D.			15.002~15.008 (0.60008~0.60032)	15.04 (0.6016)
Piston pin O.D			14.994~15 (0.59976~0.6)	14.96 (0.5984)
Piston-to-piston pin clearance			0.002~0.014 (0.00008~0.00056)	0.02 (0.0008)
Connecting rod small end I.D. bore			15.016~15.034 (0.60064~0.60136)	15.06 (0.6024)

7. CYLINDER/PISTON

TROUBLESHOOTING

- When hard starting or poor performance at low speed occurs, check the crankcase breather for white smoke. If white smoke is found, it means that the piston rings are worn, stuck or broken.

Compression too low or uneven compression

- Worn or damaged cylinder and piston rings
- Worn, stuck or broken piston rings

Compression too high

- Excessive carbon build-up in combustion chamber or on piston head

Excessive smoke from exhaust muffler

- Worn or damaged piston rings
- Worn or damaged cylinder and piston

Abnormal noisy piston

- Worn cylinder, piston and piston rings
- Worn piston pin hole and piston pin
- Incorrectly installed piston

7. CYLINDER/PISTON

CYLINDER AND PISTON

REMOVAL

Remove the cylinder head (refer to “**CYLINDER HEAD**” section in the chapter 6).

Remove the water hose (1) from the cylinder. Remove the two cylinder bolts/washers (2). Remove the cylinder.

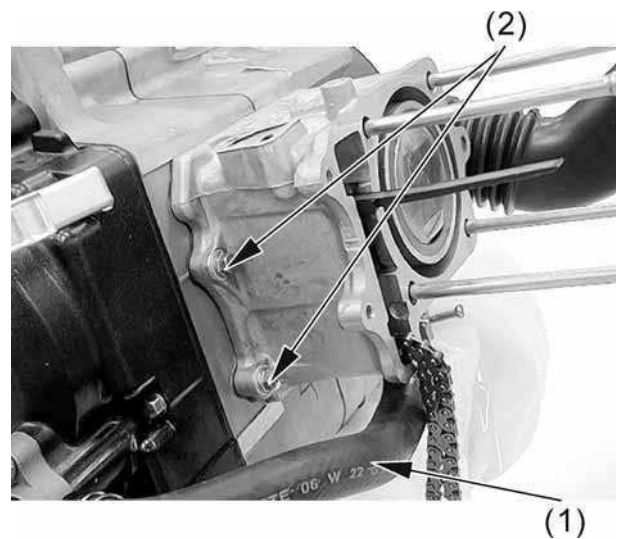

Remove the cylinder gasket (4) and dowel pins (3). Clean any gasket material from the cylinder surface.

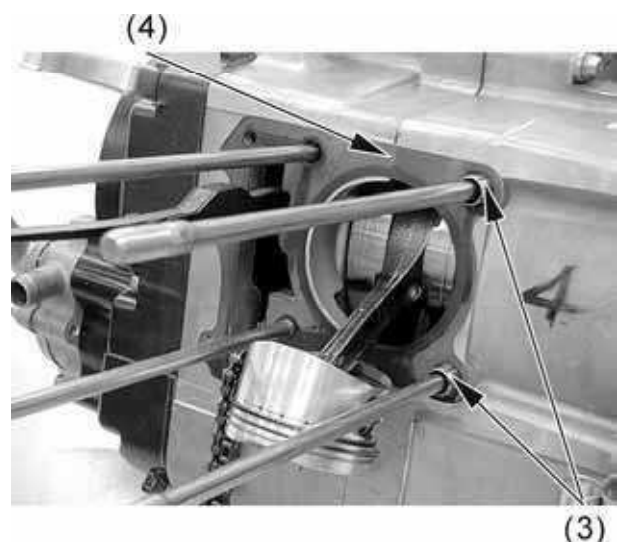

Remove the piston pin clip (6).

* Place a clean shop towel in the crankcase to keep the piston pin clip from falling into the crankcase.

Press the piston pin (5) out of the piston and remove the piston (7).

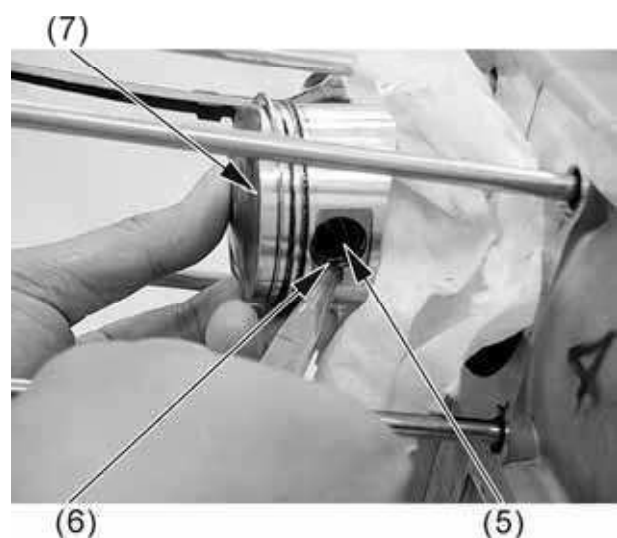

7. CYLINDER/PISTON

Spread each piston ring and remove it by lifting up at a point opposite the gap

* Do not damage the piston ring by spreading the ends too far.

Clean carbon deposits from the piston ring grooves.

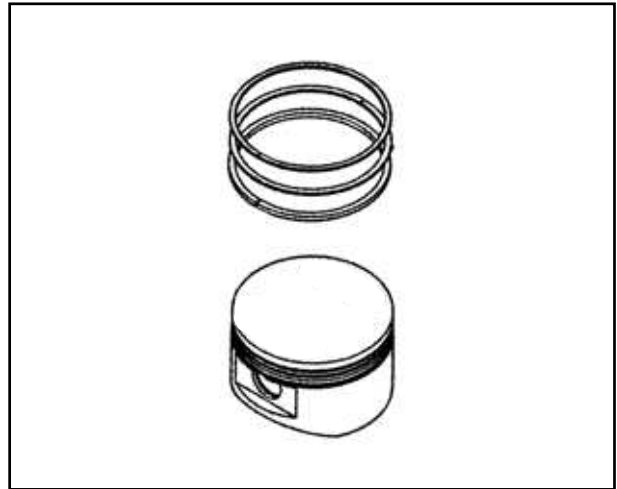

INSPECTION

Piston ring

Inspect the piston rings for movement by rotating the rings. The rings should be able to move in their grooves without catching.

Push the ring until the outer surface of the piston ring is nearly flush with the piston and measure the ring-to-groove clearance.

Service Limits:

Top: 0.09 mm (0.0036 in)

2nd: 0.09 mm (0.0036 in)

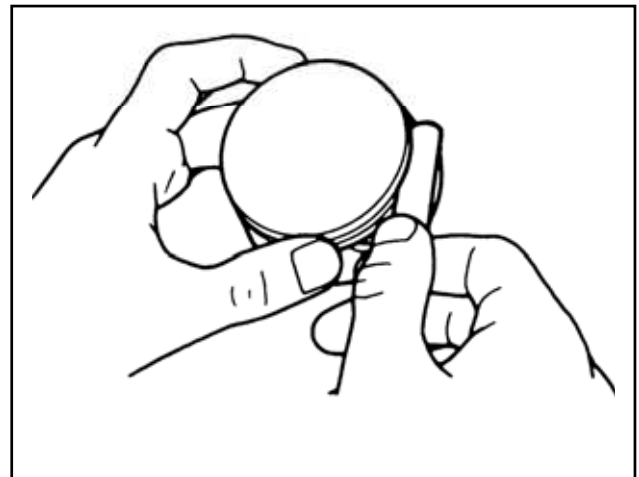

Insert each piston ring into the bottom of the cylinder squarely.

* Use the piston head to push each piston ring into the cylinder.

Measure the piston ring end gap.

Service Limit:

Top: 0.5 mm (0.02 in)

2nd: 0.5 mm (0.02 in)

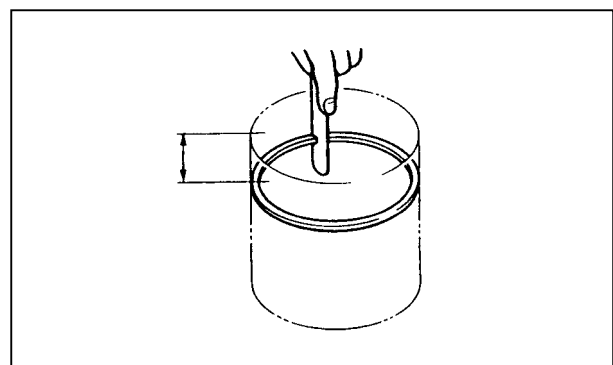

7. CYLINDER/PISTON

DINK 200i/125

Piston/Piston pin

Measure the piston O.D. at the point (A) from the bottom and 90° to the piston pin hole.

Service Limit:

DINK 200i:

61.9 mm (2.476 in) at (A): 5 mm (0.2 in)

DINK 125:

52.3 mm (2.092 in) at (A): 9 mm (0.36 in)

Calculate the cylinder-to-piston clearance.

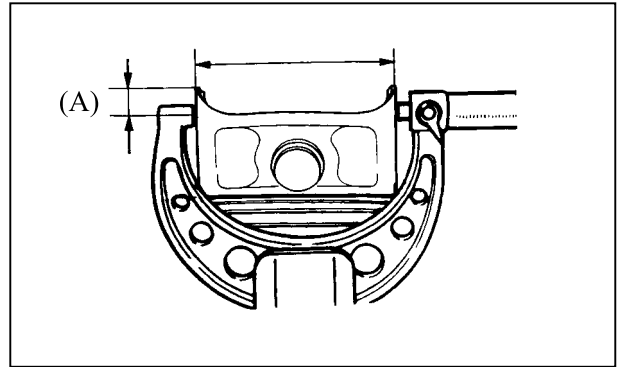

Measure the piston pin hole. Take the maximum reading to determine the I.D..

Service Limit: 15.04 mm (0.6016 in)

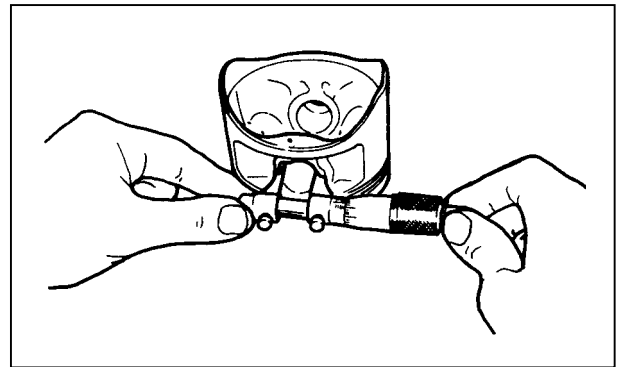

Measure the piston pin O.D. at piston and connecting rod sliding areas.

Service Limit: 14.96 mm (0.5984 in)

Measure the piston-to-piston pin clearance.

Service Limit: 0.02 mm (0.0008 in)

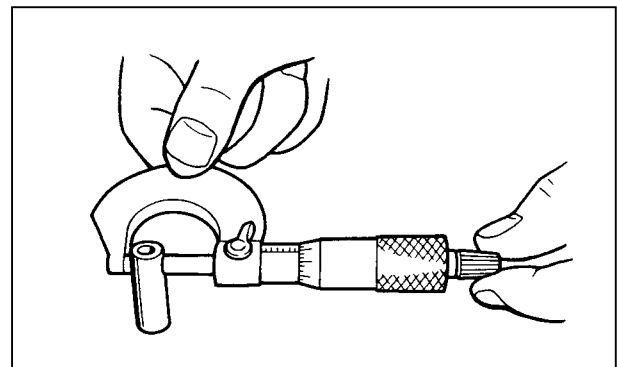

7. CYLINDER/PISTON

Cylinder

Check the cylinder for warpage with a straight edge and feeler gauge in the directions shown.

Service Limit: 0.05 mm (0.002 in)

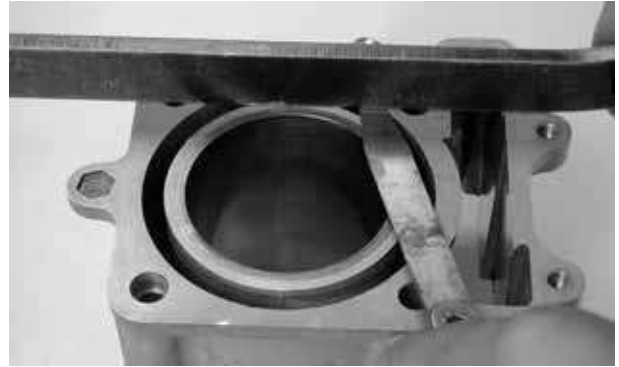

Check the cylinder wall for wear or damage. Measure and record the cylinder I.D. at three levels in an X and Y axis. Take the maximum reading to determine the cylinder wear.

Service Limit:

DINK 200i: 62.1 mm (2.484 in)

DINK 125: 52.5 mm (2.1 in)

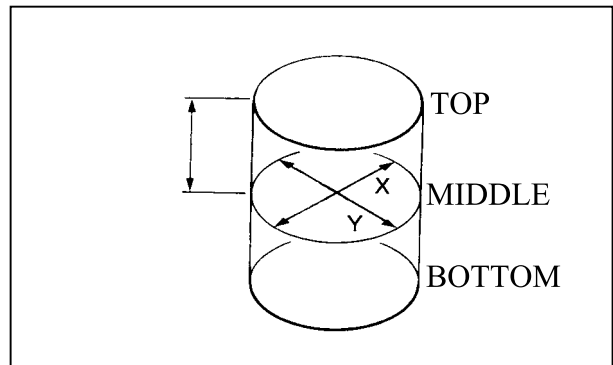

Calculate the piston-to-cylinder clearance. Take a maximum reading to determine the clearance.

Service Limit: 0.1 mm (0.004 in)

Calculate the taper and out-of-round at three levels in an X and Y axis. Take the maximum reading to determine them.

Service Limit:

Taper: 0.1 mm (0.004 in)

Out-of-round: 0.1 mm (0.004 in)

Measure the connecting rod small end I.D.

Service Limit: 15.06 mm (0.6024 in)

Calculate the connecting rod-to-piston pin clearance.

Service Limit: 0.02 mm (0.0008 in)

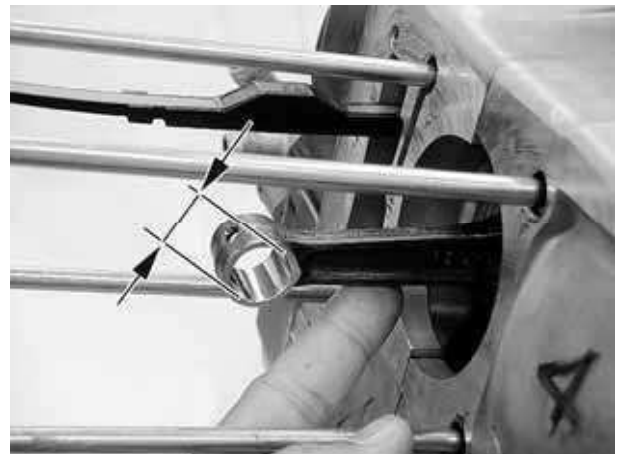

7. CYLINDER/PISTON

Inspect the exhaust side and intake side chain guides.

Wear/Damage → Replace.

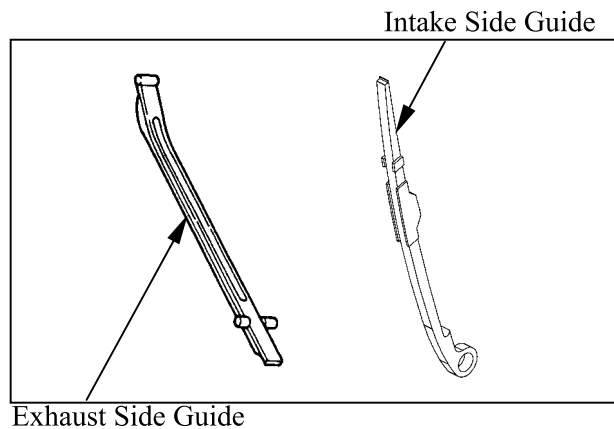

INSTALLATION

Piston ring

Carefully install the piston rings into the piston ring grooves with the markings facing up.

* Be careful not to damage the piston and rings.

- ♦ Do not confuse the top and second rings.
- ♦ To install the oil ring, install the oil ring, then install the side rails.

Stagger the piston ring end gaps 120° degrees apart from each other.

Stagger the side rail end gaps as shown.

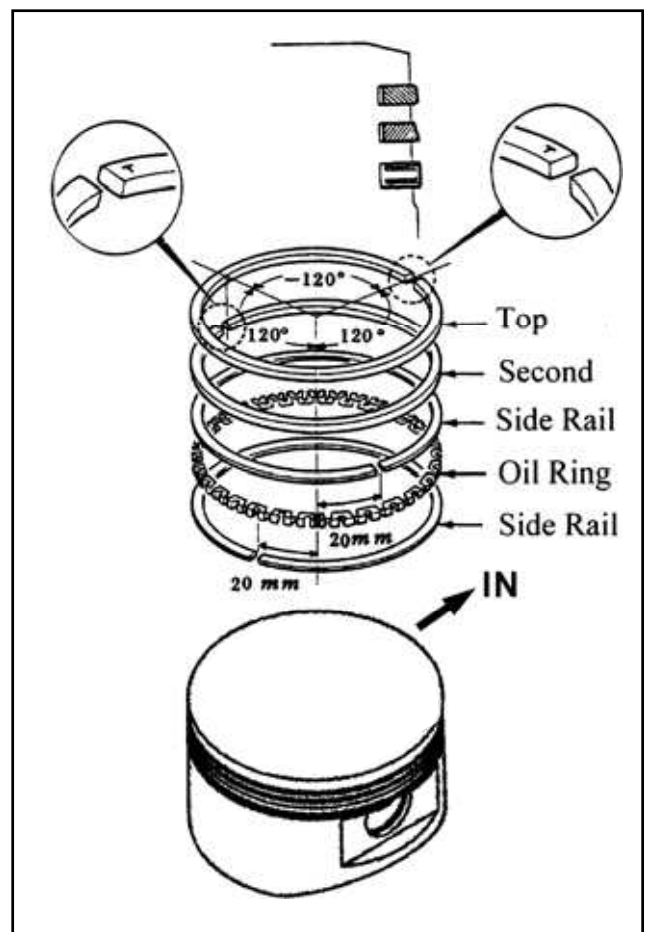

7. CYLINDER/PISTON

Cylinder/Piston

Clean any gasket material from the cylinder mating surfaces of the crankcase and oil passage.

Apply engine oil to the piston pin.
Apply engine oil to the connecting rod small end and piston pin hole.

Install the piston with the “IN” mark face intake side and piston pin.



Place a clean shop towel over the crankcase prevent the clip from falling into the crankcase.

Install the new pin clip.

- * ♦Make sure that the piston pin clips are seated securely.
- ♦Do not align the piston pin clip end gap with the piston cut-out



Install the dowel pins and gasket.

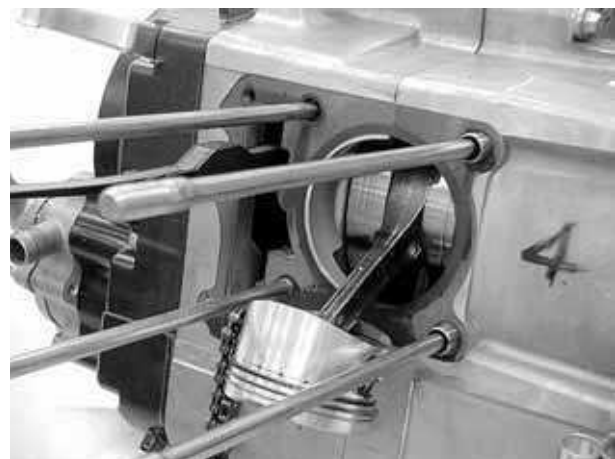

7. CYLINDER/PISTON

Apply engine oil to the cylinder wall, piston and piston ring outer surfaces.

Pass the cam chain through the cylinder and install the cylinder over the piston.

* Be careful not to damage the piston rings and cylinder walls.

Install the two cylinder bolts/washers (1) and after the cylinder head and camshaft holder has installed (refer to the “**CYLINDER HEAD**” section in the chapter 6), then tighten the two cylinder bolts to specified torque.

Torque: 1 kgf-m (10 N-m, 7 lbf-ft)

Connect the water hose.

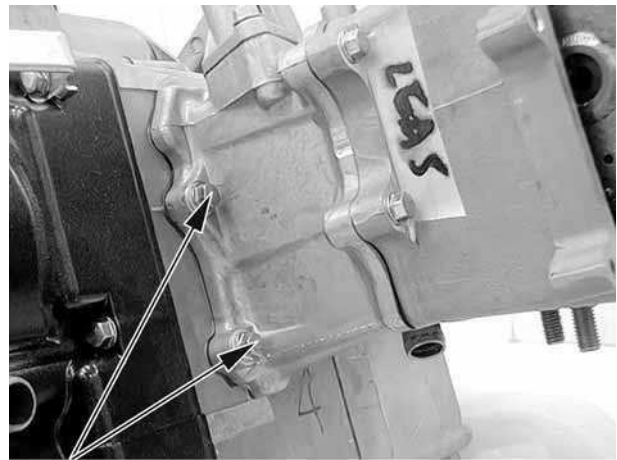

(1)



**DRIVE AND DRIVEN PULLEYS/
KICK STARTER**

SCHEMATIC DRAWING -----	8- 1
SERVICE INFORMATION-----	8- 2
TROUBLESHOOTING-----	8- 3
LEFT CRANKCASE COVER -----	8- 4
DRIVE PULLEY, DRIVE BELT AND DRIVEN PULLEY -----	8- 8



8. DRIVE AND DRIVEN PULLEYS/ KICK STARTER

SCHEMATIC DRAWING

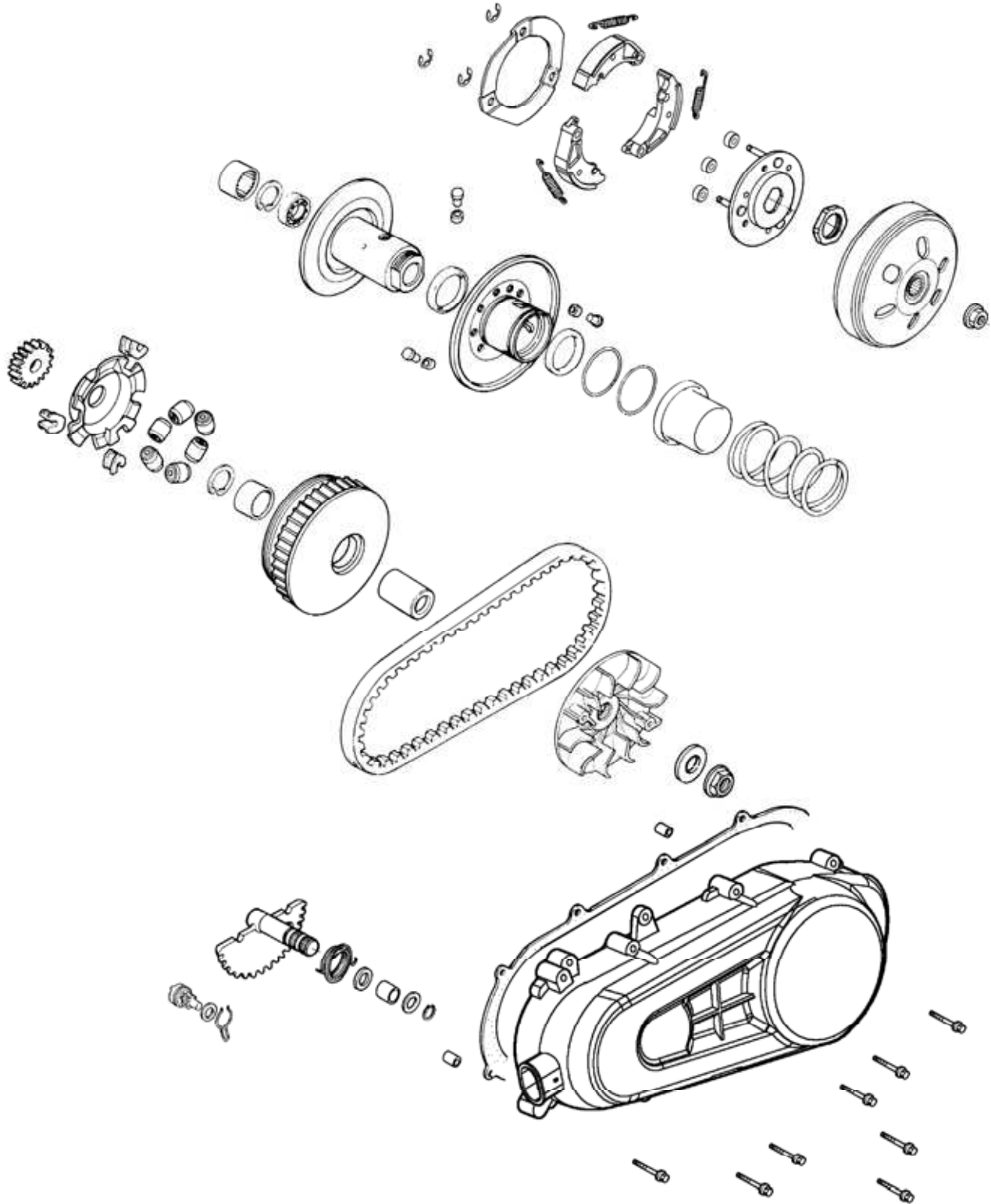

8. DRIVE AND DRIVEN PULLEYS/ KICK STARTER

SERVICE INFORMATION

GENERAL INSTRUCTIONS

- The drive pulley, clutch and driven pulley can be serviced with the engine installed.
- Avoid getting grease and oil on the drive belt and pulley faces. Remove any oil or grease from them to minimize the slipping of drive belt and drive pulley.

SPECIFICATIONS

Unit: mm (in)

Item	Standard	Service Limit
Movable drive face bushing I.D.	27~27.021 (1.08~1.08084)	27.06 (1.0824)
Drive face collar O.D.	26.97~26.99 (1.0788~1.0796)	26.9 (1.076)
Drive belt width	DINK 200i	19 (0.76)
	DINK 125	18.8 (0.752)
Clutch lining thickness	3.963~4.037 (0.15852~0.16148)	2 (0.08)
Clutch outer I.D.	130~130.2 (5.2~5.208)	130.5 (5.22)
Driven face spring free length	DINK 200i	135 (5.4)
	DINK 125	87.2 (3.488)
Driven face O.D.	33.965~33.985 (1.3586~1.3594)	33.94 (1.3576)
Movable driven face I.D.	34~34.025 (1.36~1.361)	34.06 (1.3624)
Weight roller O.D.	20.65~20.8 (0.826~0.532)	19.8 (0.792)

TORQUE VALUES

Left crankcase cover	1.2 kgf-m (12 N-m, 8.6 lbf-ft)
Drive pulley nut (DINK 200i)	5.8 kgf-m (58 N-m, 42 lbf-ft)
Drive pulley nut (DINK 125)	5.5 kgf-m (55 N-m, 40 lbf-ft)
Clutch outer nut	5.5 kgf-m (55 N-m, 40 lbf-ft)
Driven pulley assembly plate nut	5.5 kgf-m (55 N-m, 40 lbf-ft)

SPECIAL TOOLS

Bearing installer	A120E00014
Universal holder	A120E00017
Clutch spring compressor	A120E00034

8. DRIVE AND DRIVEN PULLEYS/ KICK STARTER



DINK 200i/125

TROUBLESHOOTING

Engine starts but motorcycle won't move

- Worn drive belt
- Broken ramp plate
- Worn or damaged clutch lining
- Broken driven face spring

Engine stalls or motorcycle creeps

- Broken clutch weight spring

Lack of power

- Worn drive belt
- Weak driven face spring
- Worn weight roller
- Faulty driven face

8. DRIVE AND DRIVEN PULLEYS/ KICK STARTER

LEFT CRANKCASE COVER

REMOVAL

Remove the eight left crankcase cover bolts and then remove the left crankcase cover. Remove the gasket and dowel pins.

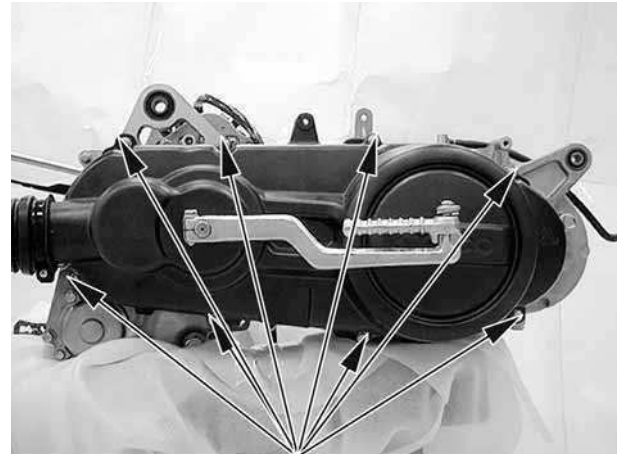

Bolts

INSTALLATION

Install the dowel pins and new gasket.

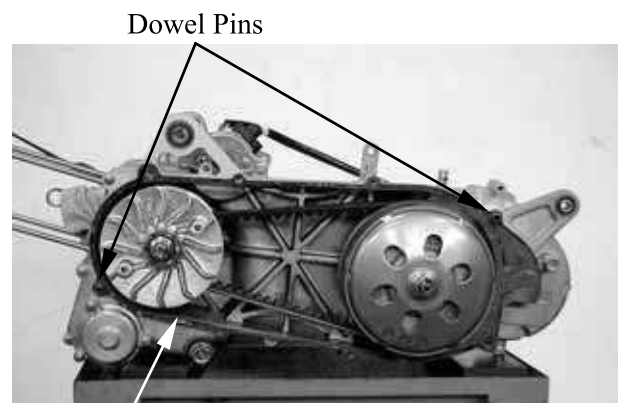

Gasket

Install the left crankcase cover.

* Do not pull out the kick starter spindle. Press in the kick starter spindle when installing the left crankcase cover.

Install and tighten the eight bolts diagonally to specified torque.

Torque: 1.2 kgf-m (12 N-m, 8.6 lbf-ft)

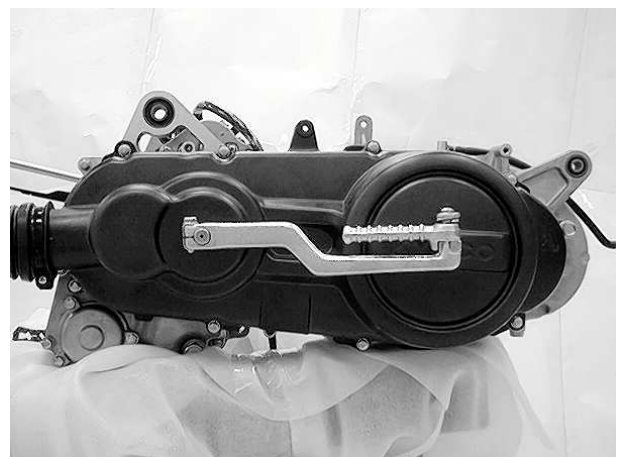

8. DRIVE AND DRIVEN PULLEYS/ KICK STARTER

DISASSEMBLY (DINK 125 only)

Remove the bolt from the kick lever, then remove the kick lever.

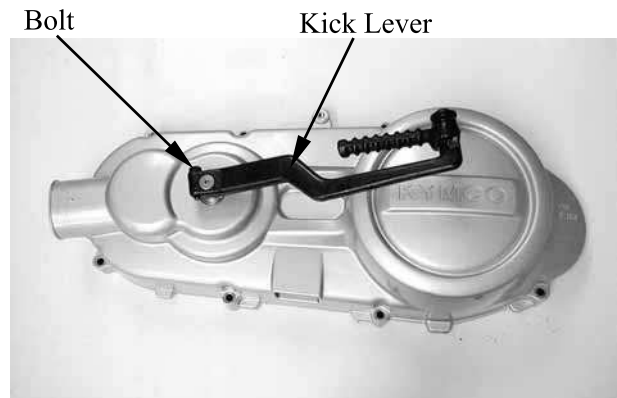

Remove the snap ring and washer from the kick starter spindle.

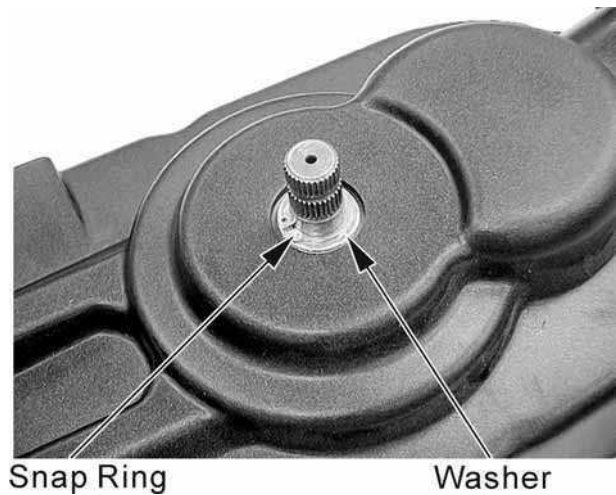

Gently turn the kick starter spindle to remove the starter driven gear together with the friction spring.
Remove the washer.

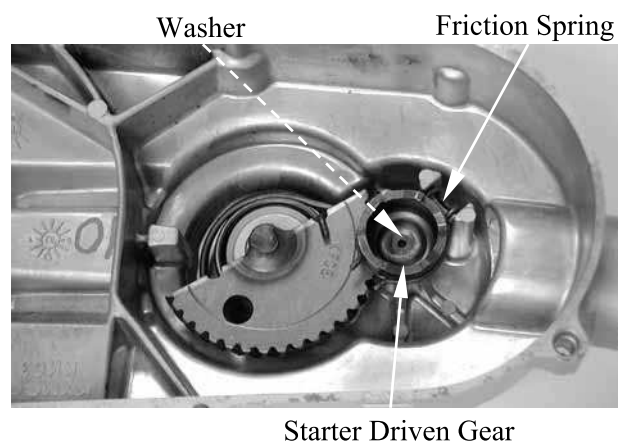

8. DRIVE AND DRIVEN PULLEYS/ KICK STARTER

Remove the kick starter spindle and return spring from the left crankcase cover. Remove the plastic bushing and kick starter spindle bushing.

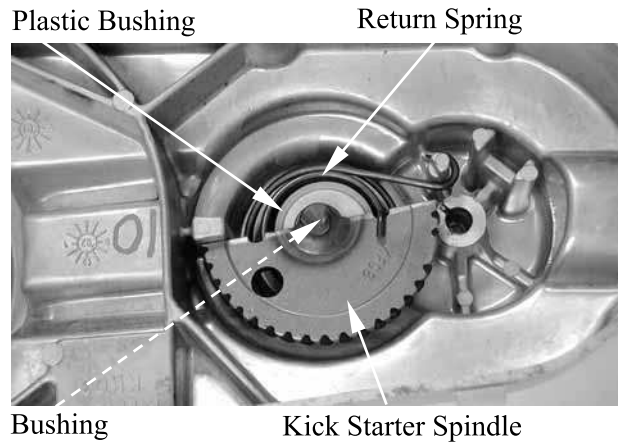

INSPECTION (DINK 125 only)

Inspect the kick starter spindle and gear for wear or damage.
Inspect the return spring for weakness or damage.
Inspect the kick starter spindle bushings for wear or damage.

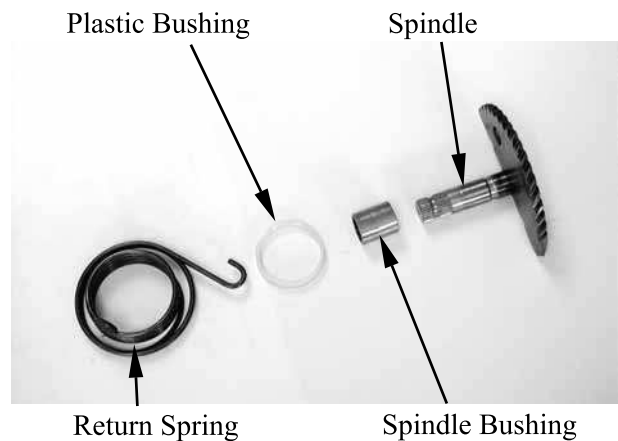

Inspect the starter driven gear for wear or damage.
Inspect the friction spring for wear or damage.

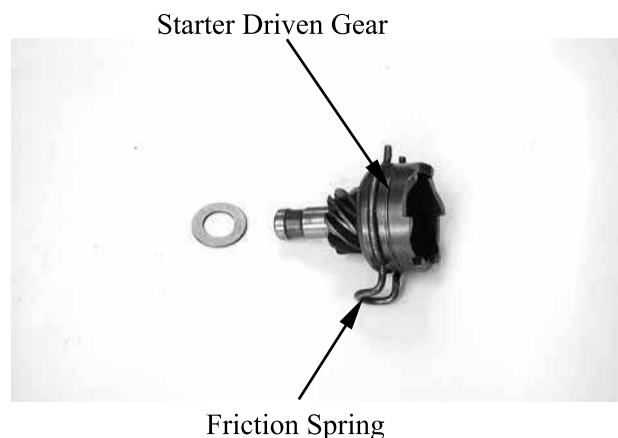

8. DRIVE AND DRIVEN PULLEYS/ KICK STARTER

Inspect the kick starter spindle and starter driven gear forcing parts for wear or damage.

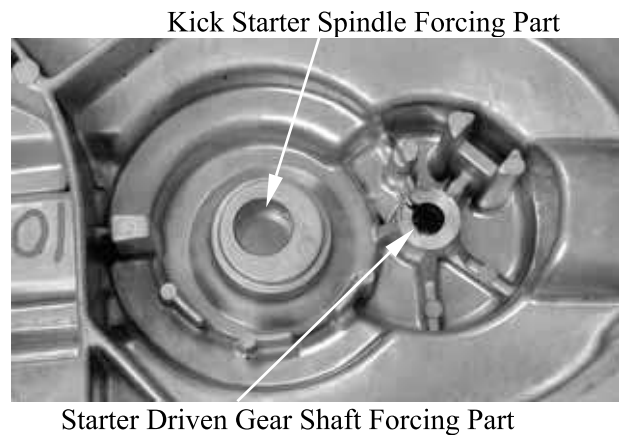

ASSEMBLY (DINK 125 only)

Apply grease to the spindle gear shaft.
Install the kick starter spindle bushings into the left crankcase cover.
Install return spring and spindle gear into the left crankcase cover.

* When installing the return spring, use a screw driver to press the inward and outward return spring hooks into their original positions respectively.

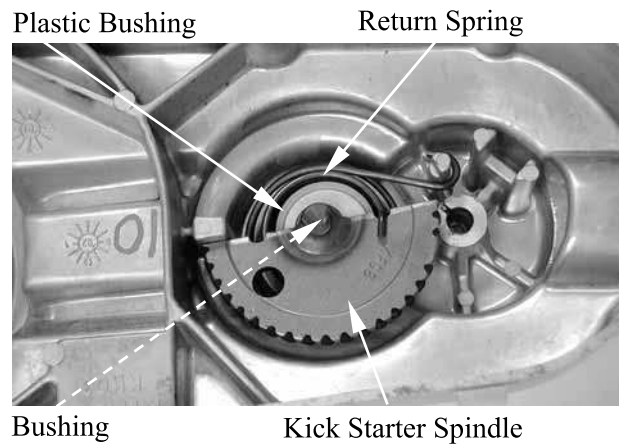

Apply grease to the driven gear shaft.
Install the washer onto the left crankcase cover.
Install the starter driven gear and friction spring as the figure shown.

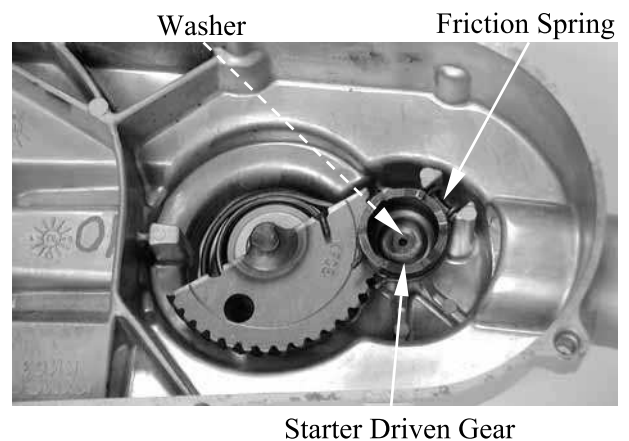

8. DRIVE AND DRIVEN PULLEYS/ KICK STARTER

DRIVE PULLEY, DRIVE BELT AND DRIVEN PULLEY

REMOVAL

Remove the left crankcase cover (refer to the “LEFT CRANKCASE COVER” section in this chapter).

Use the special tool to hold the drive pulley, then remove the nut and ratchet.

Special tool:

Universal holder A120E00017

Remove the drive pulley face.

Nut/Ratchet

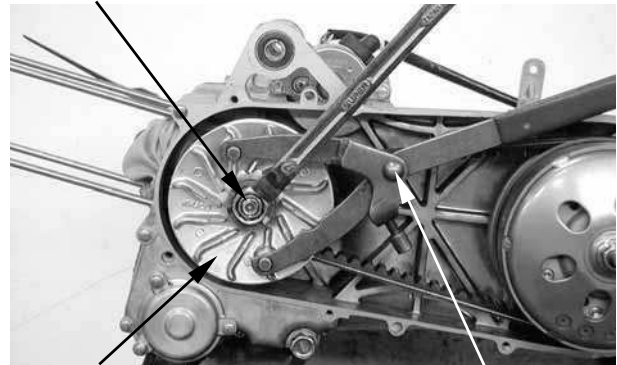

Drive Pulley Face

Universal Holder

Hold the clutch outer with the universal holder and remove the clutch outer nut.

Special tool:

Universal Holder A120E00017

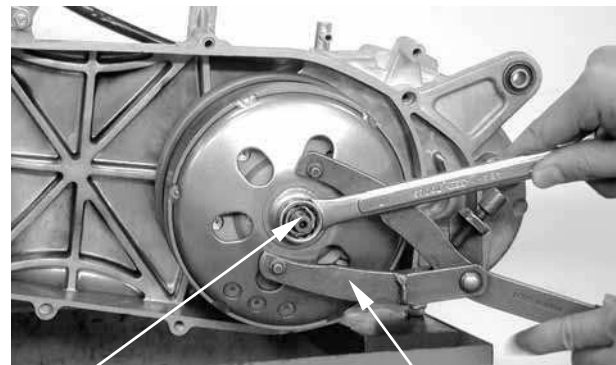

Nut

Universal Holder

Remove the clutch outer, driven pulley assembly and drive belt together.

Clutch Outer/Driven Pulley Assembly

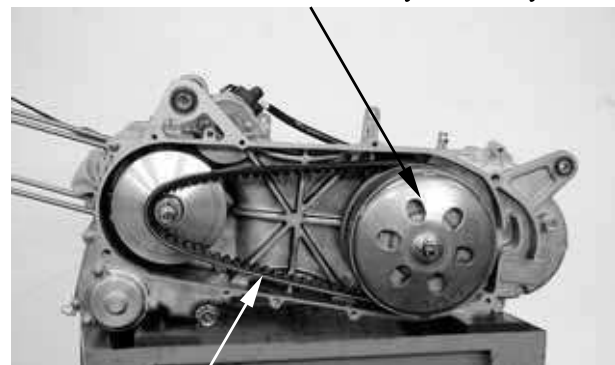

Drive Belt

8. DRIVE AND DRIVEN PULLEYS/ KICK STARTER

Remove the movable drive face assembly.

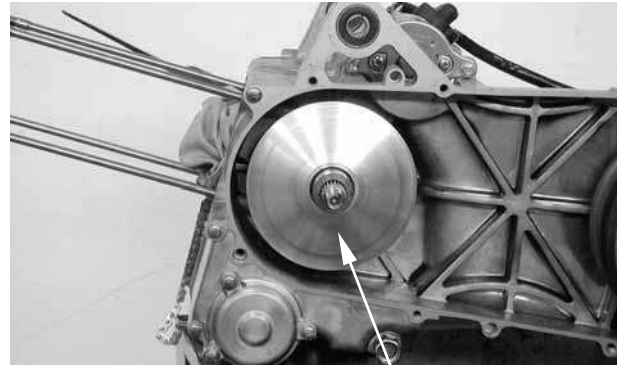

Movable Drive Face Assembly

Drive belt inspection

Check the drive belt for cracks, separation or abnormal or excessive wear.
Measure the drive belt width.

Service Limit:

DINK 200i: 17.5 mm (0.7 in)

DINK 125: 17.3 mm (0.692 in)

* Use specified genuine parts for replacement.

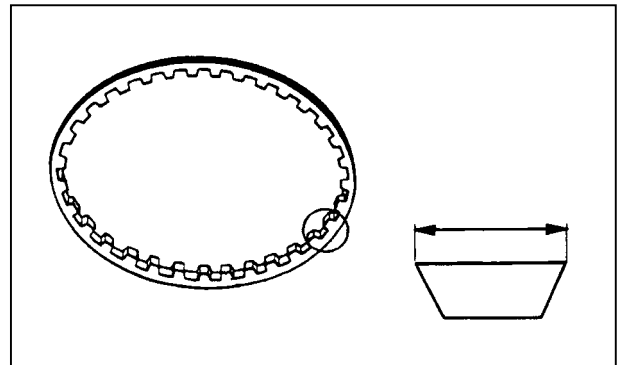

Clutch out inspection

Inspect the clutch out for wear or damage.
Measure the clutch out I.D.

Service Limit: 130.5 mm (5.22 in)

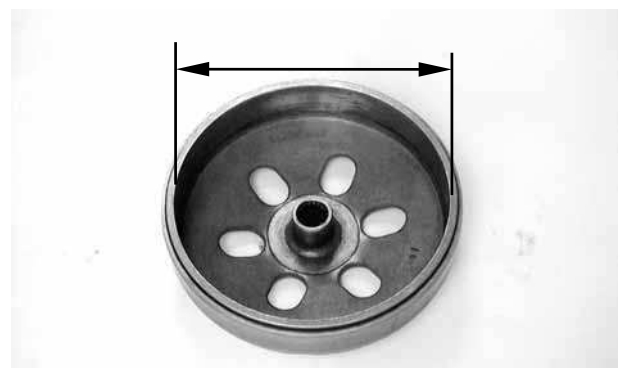

8. DRIVE AND DRIVEN PULLEYS/ KICK STARTER

INSTALLATION

Apply lubricant to the drive face boss inner surface, then install the movable drive face assembly.

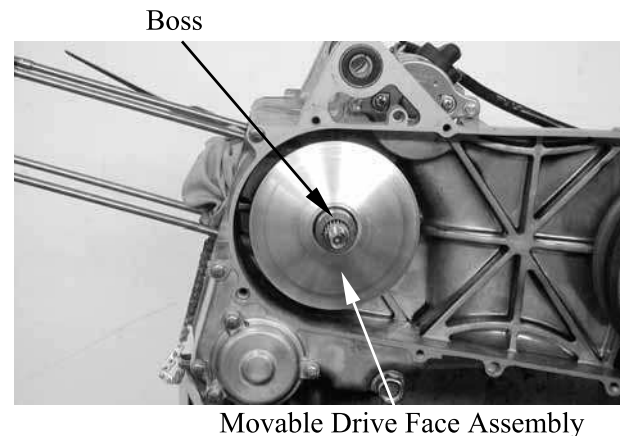

Install the clutch outer onto the driven pulley assembly.
Compress the driven pulley assembly by hand, then install the drive belt into the driven pulley assembly.

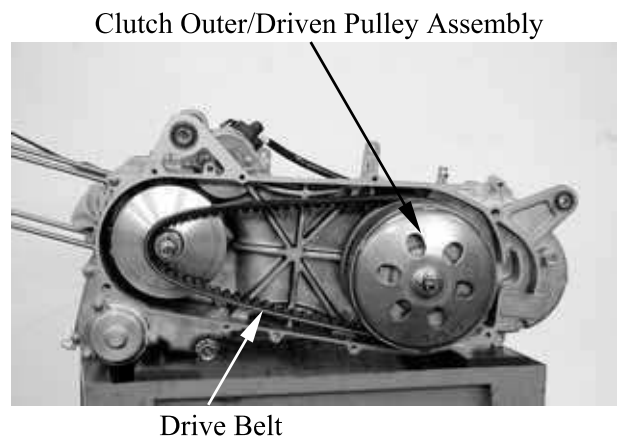

- * The drive belt should be installed so that the arrows on the drive belt periphery point in the normal turning direction if the drive belt has arrow mark.
- * The drive belt contact surface of the driven face should be thoroughly cleaned.

Install the driven pulley assembly/clutch outer and drive belt together.

Use the special tool to hold clutch outer, then tighten the nut to the specified torque.

Torque: 5.5 kgf-m (55 N-m, 40 lbf-ft)

Special tool:

Universal holder A120E00017

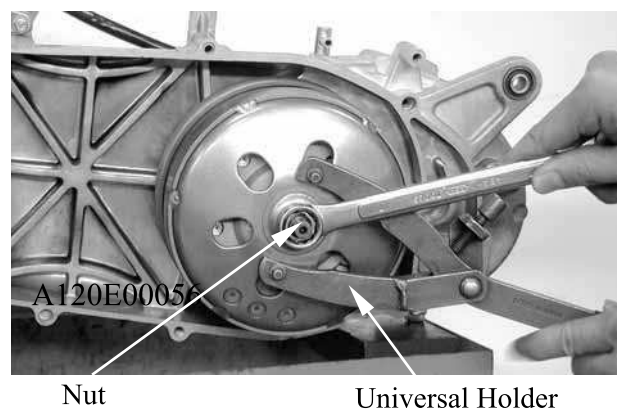

8. DRIVE AND DRIVEN PULLEYS/ KICK STARTER

Install the drive pulley face and ratchet.
Use the special tool to hold drive pulley face,
then tighten the nut to the specified torque.

Torque:

DINK 200i: 5.8 kgf-m (58 N-m, 42 lbf-ft)

DINK 125: 5.5 kgf-m (55 N-m, 40 lbf-ft)

Special tool:

Universal holder A120E00017

Nut/Ratchet

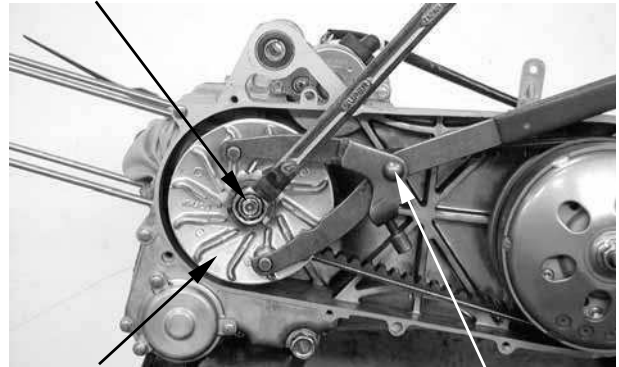

Drive Pulley Face

Universal Holder

8. DRIVE AND DRIVEN PULLEYS/ KICK STARTER

DRIVE PULLEY DISASSEMBLY

Remove the drive face boss.

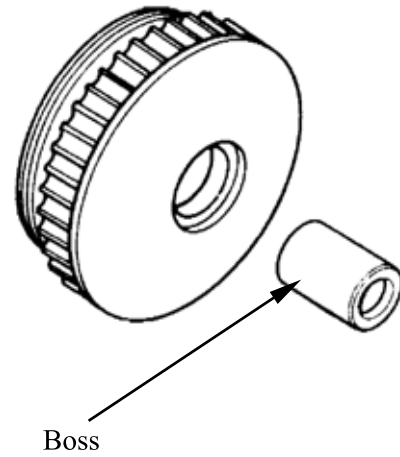

Remove the ramp plate and four slide pieces.

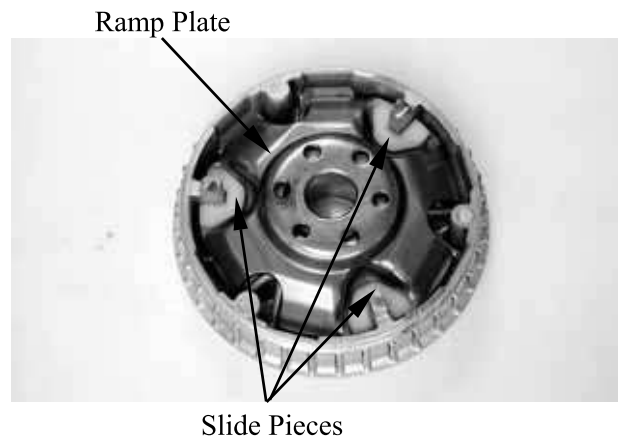

Remove the six weight rollers.



8. DRIVE AND DRIVEN PULLEYS/ KICK STARTER

DRIVE PULLEY INSPECTION

Weight rollers

Check each roller for wear or damage.
Measure outside diameter.

Service limit: 19.8 mm (0.792 in)

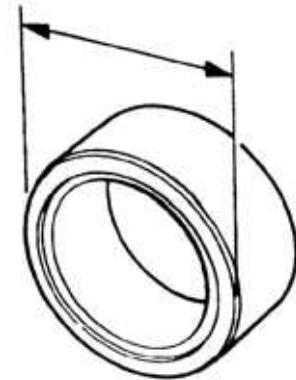

Movable drive face/Slide pieces/Drive pulley face

Check the slide pieces and movable drive face splines for wear, cracks or damage.

Check the ramp plate for cracks or damage.

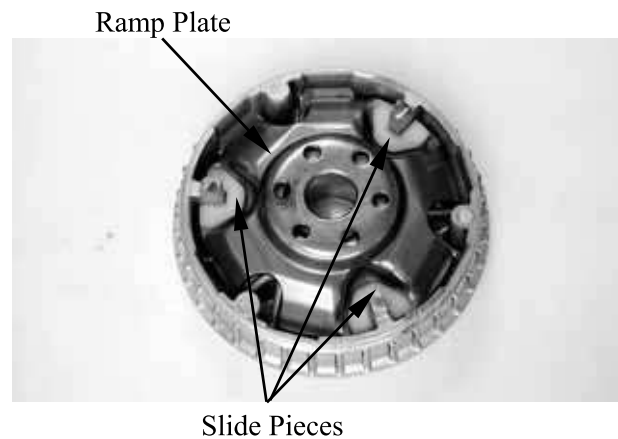

Check the movable drive face and drive pulley face cracks or damage.

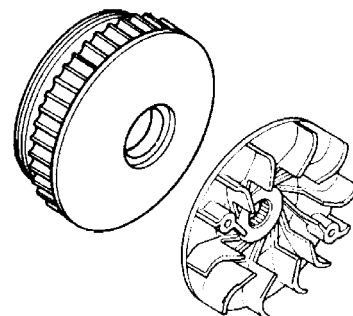

8. DRIVE AND DRIVEN PULLEYS/ KICK STARTER

DRIVE PULLEY ASSEMBLY

Clean the movable drive face, drive pulley face, weight rollers, slide pieces, ramp plate and drive face boss.

* Remove any excess grease.

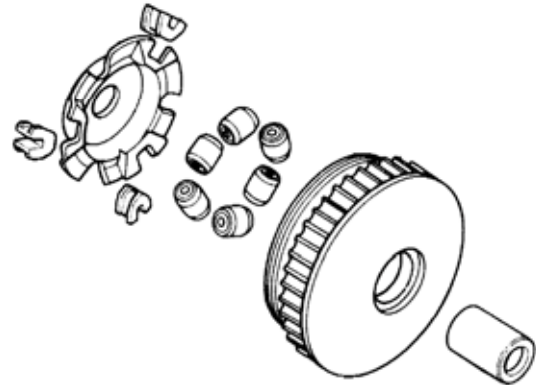

Install the weight rollers.

* The direction of all weight rollers is the same. The thin side is towards to clockwise.

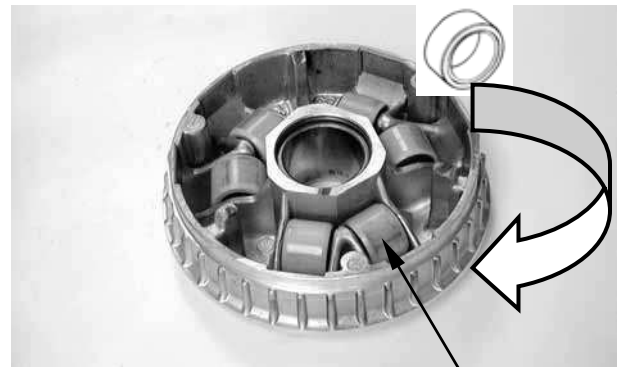

Weight Roller

Install the slide pieces and ramp plate.

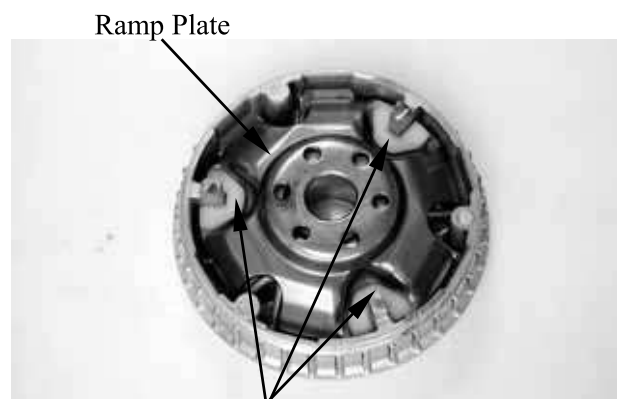

Slide Pieces

8. DRIVE AND DRIVEN PULLEYS/ KICK STARTER

Install the drive face boss.

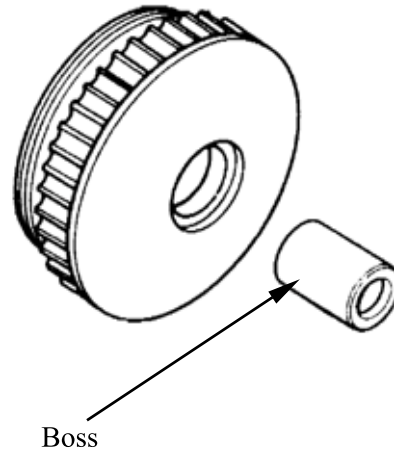

8. DRIVE AND DRIVEN PULLEYS/ KICK STARTER

DRIVEN PULLEY DISASSEMBLY

Hold the clutch/driven pulley assembly with the clutch spring compressor.

* Be sure to use a clutch spring compressor to avoid spring damage.

Special tool:

Clutch Spring Compressor A120E00034

Set the tool in a vise and remove the clutch drive plate nut.

Lock Nut Wrench

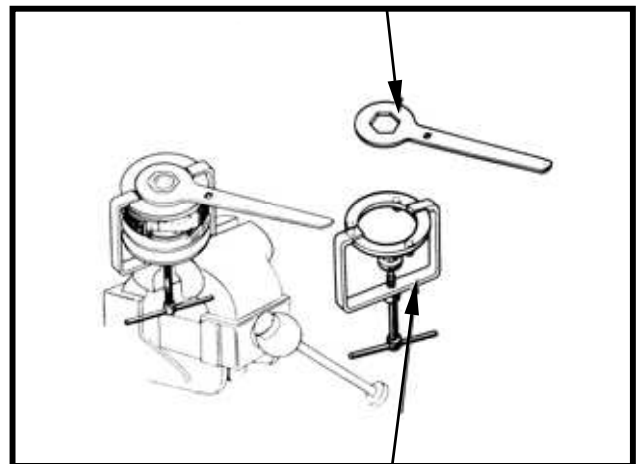

Clutch spring compressor

Remove the clutch.



8. DRIVE AND DRIVEN PULLEYS/ KICK STARTER

Remove the spring.

Remove the spring collar on the movable driven face.

Remove the three guide pins/rollers, then remove the movable driven face.

Remove the needle bearing from driven face.

Remove the snap ring, then remove the bearing from driven face.

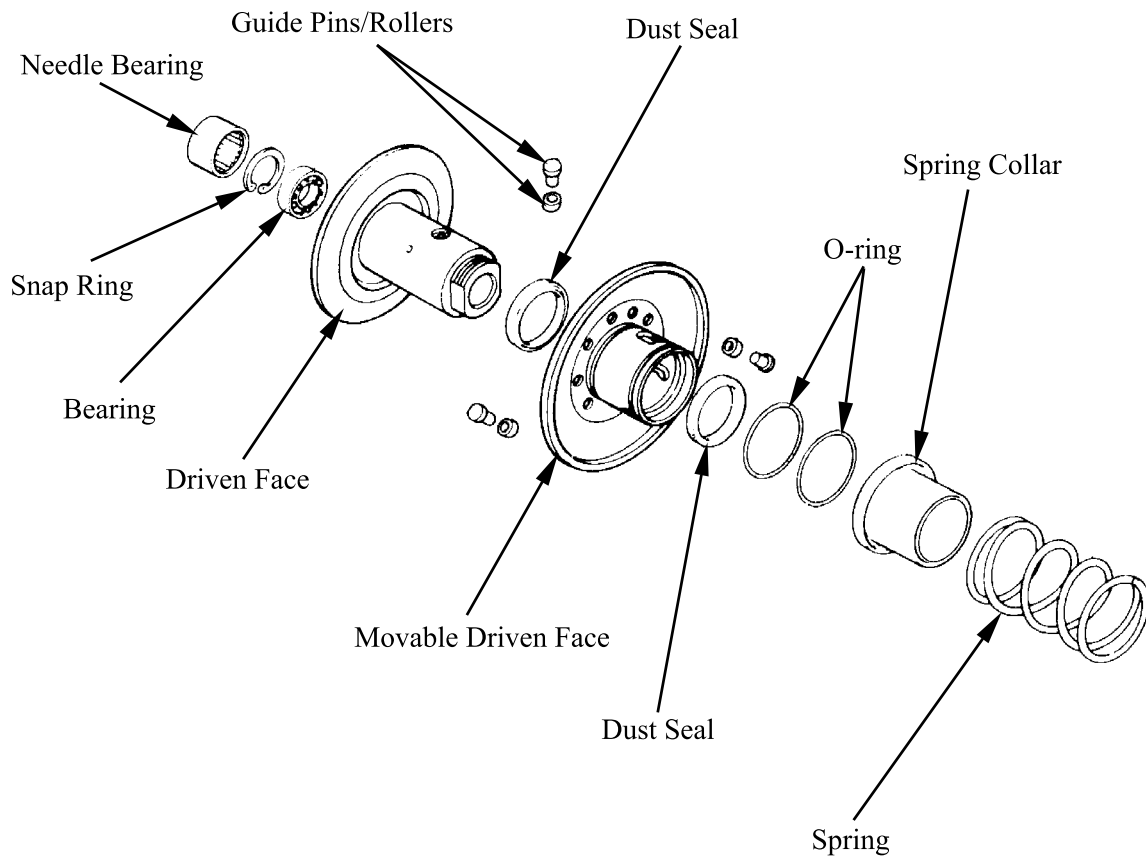

8. DRIVE AND DRIVEN PULLEYS/ KICK STARTER

DRIVEN PULLEY INSPECTION

Check the driven pulley for smooth operation.

If any scratches or damage is found then replace as a set.

Check the torque cam grooves for wear or damage.

Check guide pins and rollers for wear or damage.

If any scratches or damage is found then replace as a set.

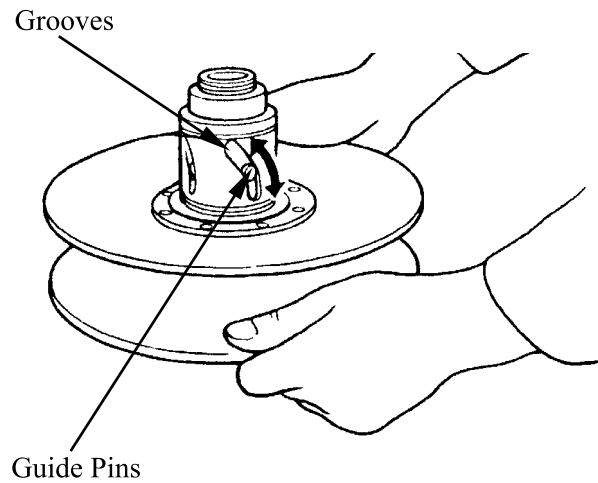

Check the spring for damage.
Measure the spring free length.

Service limit:

DINK 200i: 130 mm (5.2 in)

DINK 125: 82 mm (3.28 in)

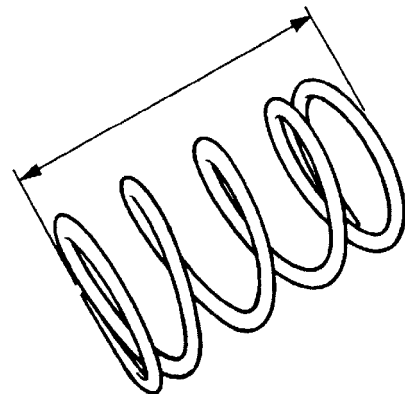

Check the clutch shoe for heat damage.

Measure the clutch shoe thickness.

Service limit (A): 2 mm (0.08 in)



8. DRIVE AND DRIVEN PULLEYS/ KICK STARTER

DRIVEN PULLEY ASSEMBLY

Clean any oil from the drive belt sliding surfaces on the driven face.

Filling 12 g of grease to driven face inner side.

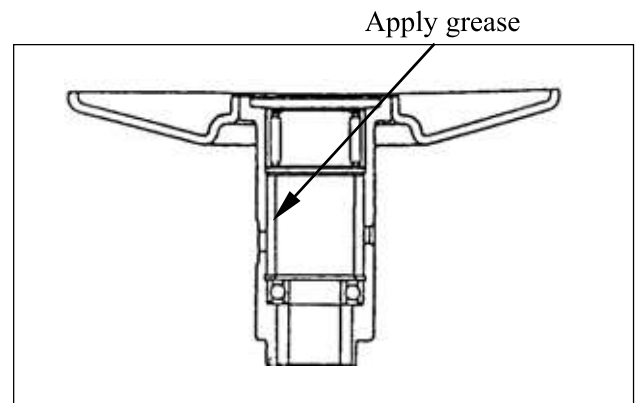

Apply grease to lips of the new dust seals and install into the movable driven face.

Coat new O-rings with grease and install them into the movable driven face grooves.

Install the movable driven face onto the driven face.

Install the guide rollers and guide roller pins.

Filling 5 g of grease to each guide groove.

Install the guide pins/rollers.

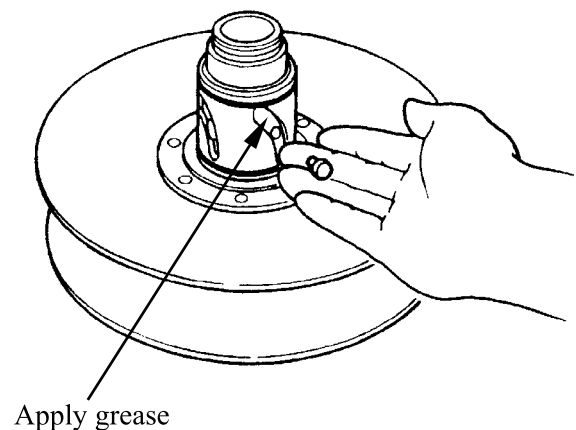

Install spring collar.

Use the special tool to install spring and clutch, then install and tighten the nut to the specified torque.

Torque: 5.5 kgf-m (55 N-m, 40 lbf-ft)

Special tool:

Clutch Spring Compressor A120E00034

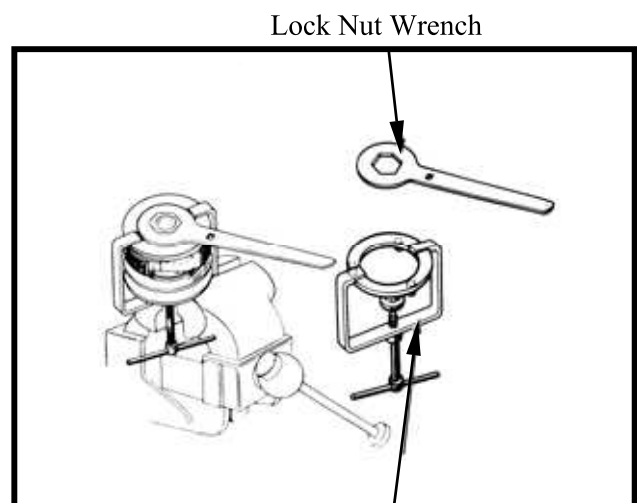

9. FINAL REDUCTION



FINAL REDUCTION

SCHEMATIC DRAWING -----	9-1
SERVICE INFORMATION-----	9-2
TROUBLESHOOTING-----	9-2
FINAL REDUCTION -----	9-3
BEARING REPLACEMENT -----	9-7



9. FINAL REDUCTION

SCHEMATIC DRAWING

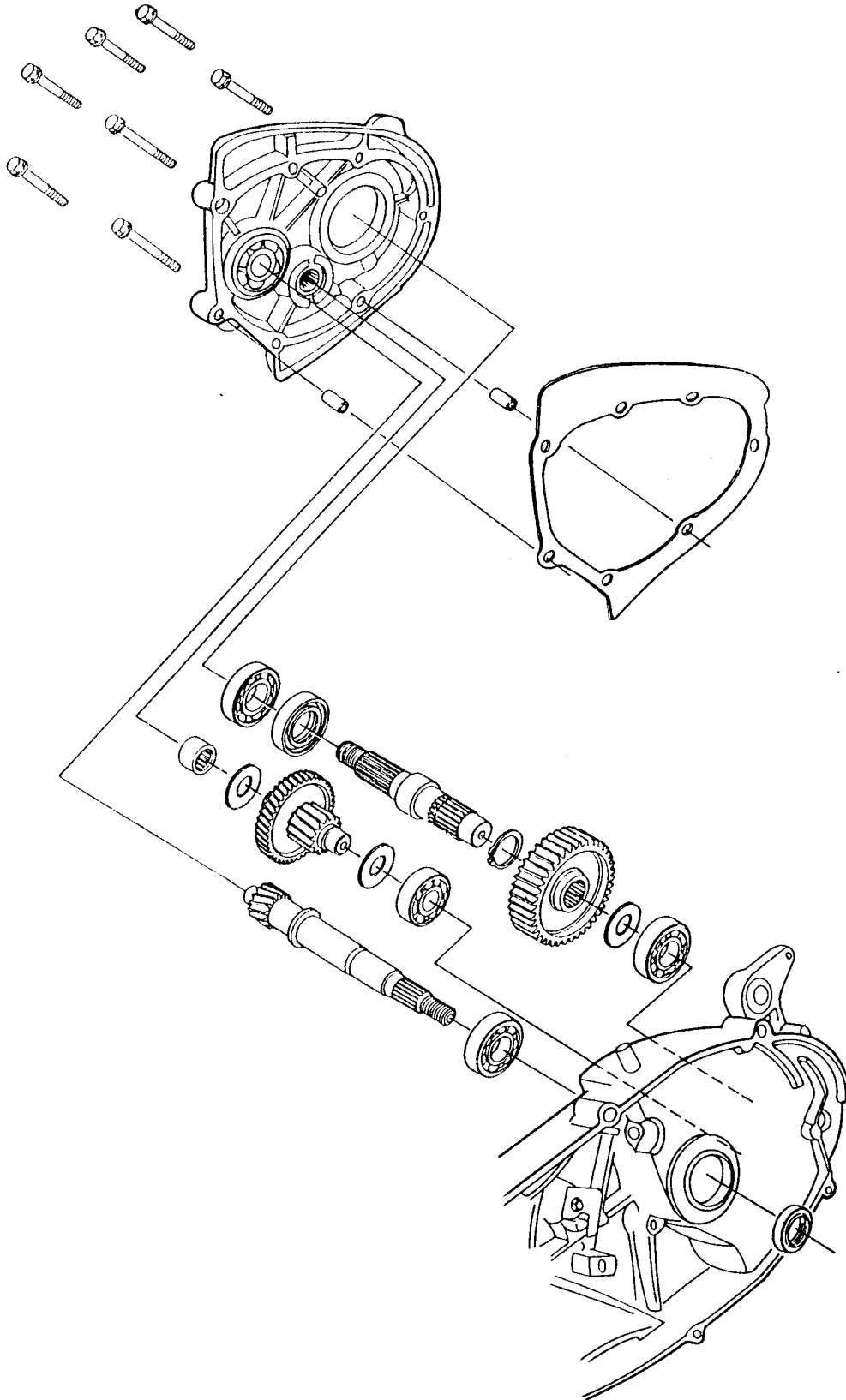

9. FINAL REDUCTION

SERVICE INFORMATION

GENERAL INSTRUCTIONS

- The servicing operations of this section can be made with the engine installed.
- When replacing the drive shaft, use a special tool to hold the bearing inner race for this operation.

SPECIFICATIONS

Specified Oil: SAE 90#

Oil Capacity:

At disassembly : 0.2 liter (0.17 Imp qt, 0.21 US qt)

At change : 0.18 liter (0.16 Imp qt, 0.19 US qt)

TORQUE VALUES

Transmission case cover bolt 1.2 kgf-m (12 N-m, 8.6 lbf-ft)

SPECIAL TOOLS

Oil seal and bearing installer A120E00014

Bearing puller A120E00037

TROUBLESHOOTING

Engine starts but motorcycle won't move

- Damaged transmission
- Seized or burnt transmission

Abnormal noise

- Worn, seized or chipped gears
- Worn bearing

Oil leaks

- Oil level too high
- Worn or damaged oil seal

9. FINAL REDUCTION

FINAL REDUCTION

REMOVAL

Drain the transmission gear oil into a clean container (refer to the “**TRANSMISSION OIL**” section in the chapter 3).

Remove the driven pulley (refer to the “**DRIVE PULLEY, DRIVE BELT AND DRIVEN PULLEY**” section in the chapter 8).

Remove the nine bolts from the transmission case cover, then remove the transmission case cover.

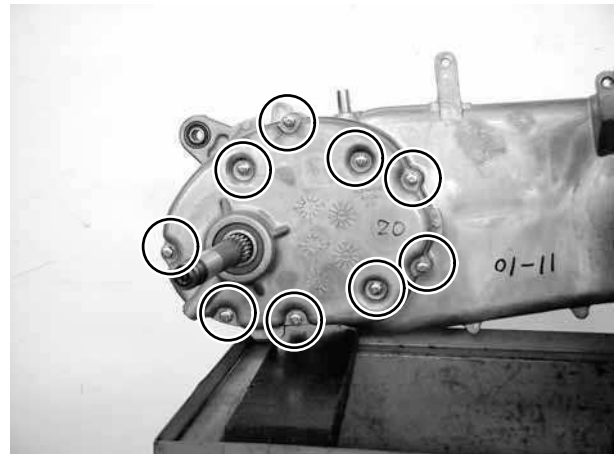

Remove the dowel pins and gasket. Remove the outer washer, countershaft and inner washer.

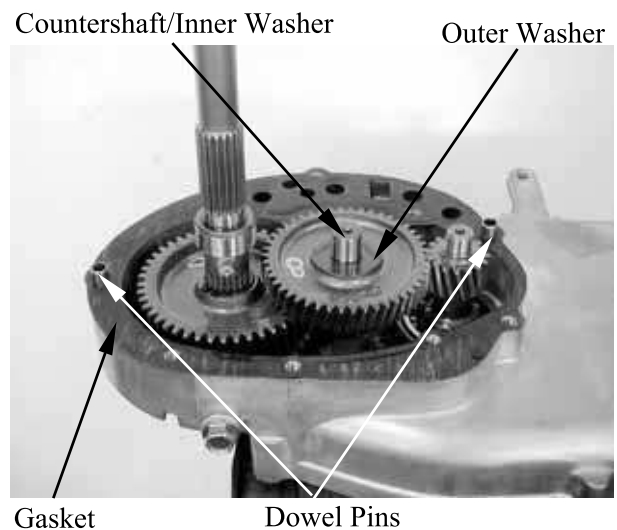

9. FINAL REDUCTION

Remove the final gear shaft and final gear.

Press the driveshaft out from the drive belt compartment.

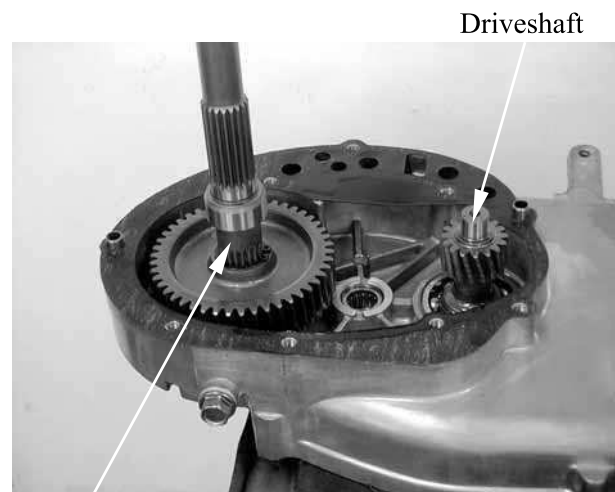

Final Gear Shaft/Final Gear

INSPECTION

Inspect the countershaft and gear for wear or damage.

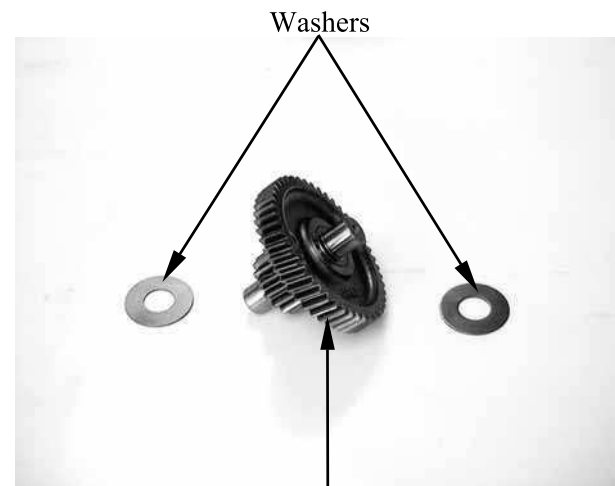

Countershaft

Inspect the final gear and final gear shaft for wear, damage or seizure.



9. FINAL REDUCTION

Check the driveshaft for wear or damage.

Check the left crankcase bearings for excessive play and inspect the oil seal for wear or damage.

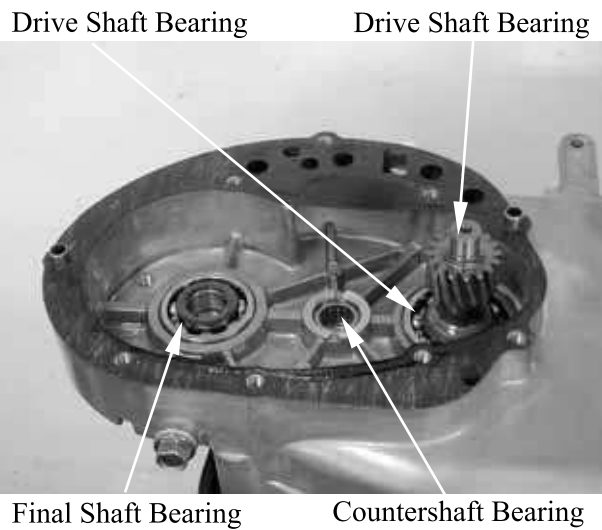

Check the transmission case cover bearings for excessive play and inspect the final shaft bearing oil seal for wear or damage.

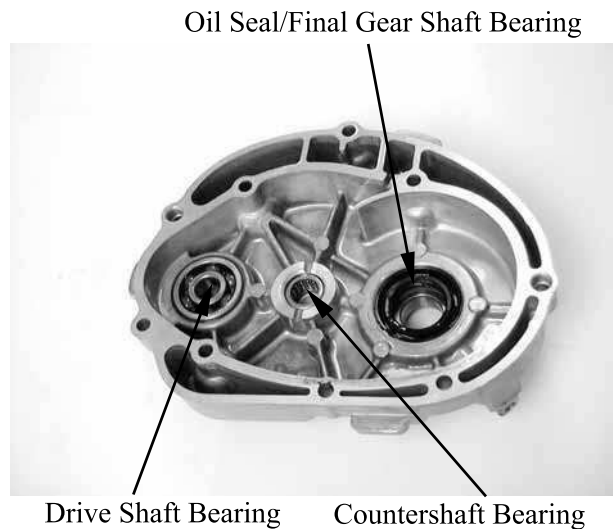

INSTALLATION

Install the driveshaft.

Install the final gear and final gear shaft.

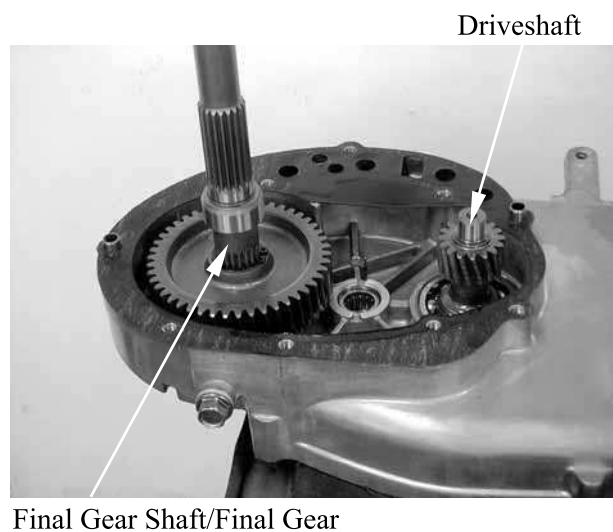

9. FINAL REDUCTION

Install the inner washer, countershaft and outer washer.

Install new gasket.

Install the two dowel pins.

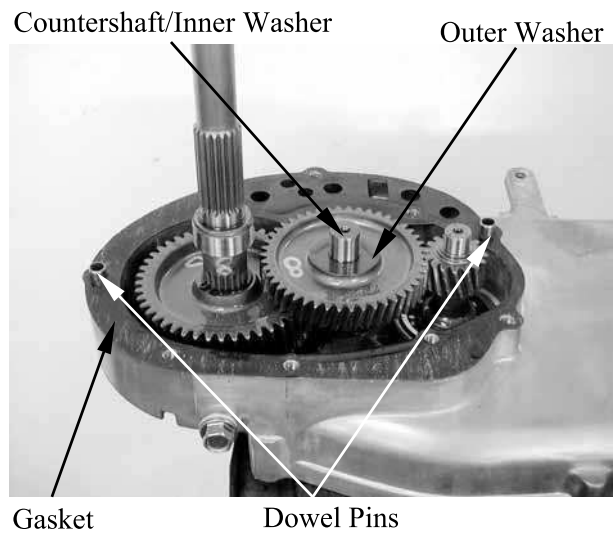

Install the transmission case cover.

Install and tighten the nine bolts to the specified torque in a crisscross pattern in 2 or 3 steps.

Torque: 1.2 kgf-m (12 N-m, 8.6 lbf-ft)

Fill the transmission case with the specified oil (refer to the “**TRANSMISSION OIL**” section in the chapter 3).

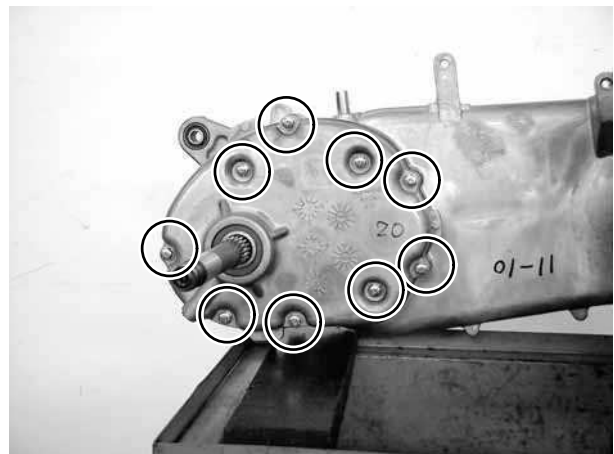

9. FINAL REDUCTION

BEARING REPLACEMENT

TRANSMISSION CASE COVER

Remove the transmission case cover (refer to the “FINAL REDUCTION” section in this chapter).

Remove the transmission case cover bearings by using the special tool.

Special tool:

Bearing puller A120E00037

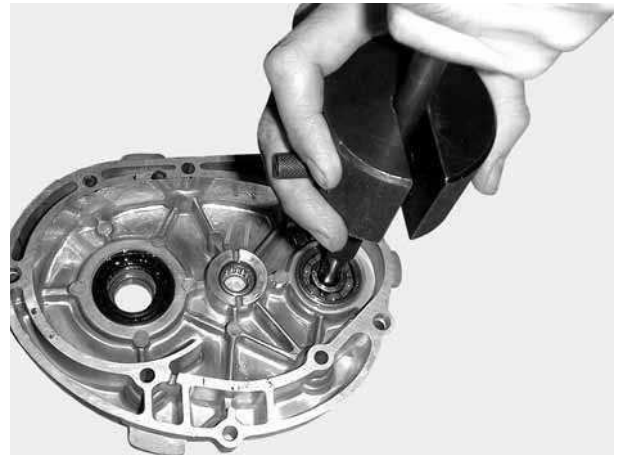

Install the new bearings or new oil seal into the transmission case cover by using the special tool.

Special tool:

Oil seal and bearing installer

A120E00014



TRANSMISSION CASE

Remove the all transmission gears (refer to the “FINAL REDUCTION REMOVAL/ INSPECTION/INSTALLATION” section in this chapter).

Remove the transmission case bearings by using the special tool.

Special tool:

Bearing puller A120E00037



9. FINAL REDUCTION

Install the new bearings or new oil seal into the transmission case by using the special tool.

Special tool:

Oil seal and bearing installer

A120E00014



DRIVESHAFT BEARING

Remove the driveshaft (refer to the “**FINAL REDUCTION**” section in this chapter).

Remove the bearing by using a commercially available puller.

Install a new bearing by using a proper pipe.

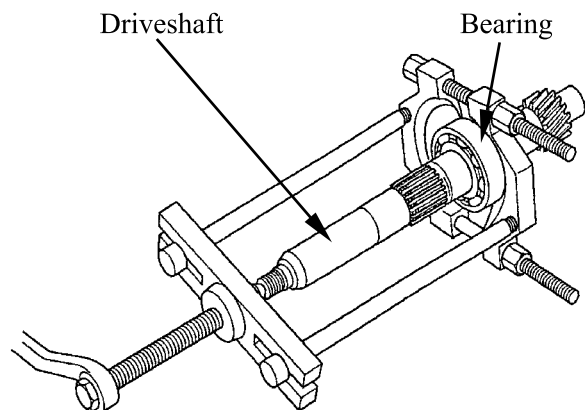

A.C. GENERATOR/STARTER CLUTCH

SCHEMATIC DRAWING -----	10-1
SERVICE INFORMATION-----	10-2
TROUBLESHOOTING-----	10-2
ALTERNATOR STATOR-----	10-3
STARTER CLUTCH-----	10-6

10. A.C. GENERATOR/STARTER CLUTCH

DINK 200i125

SCHEMATIC DRAWING

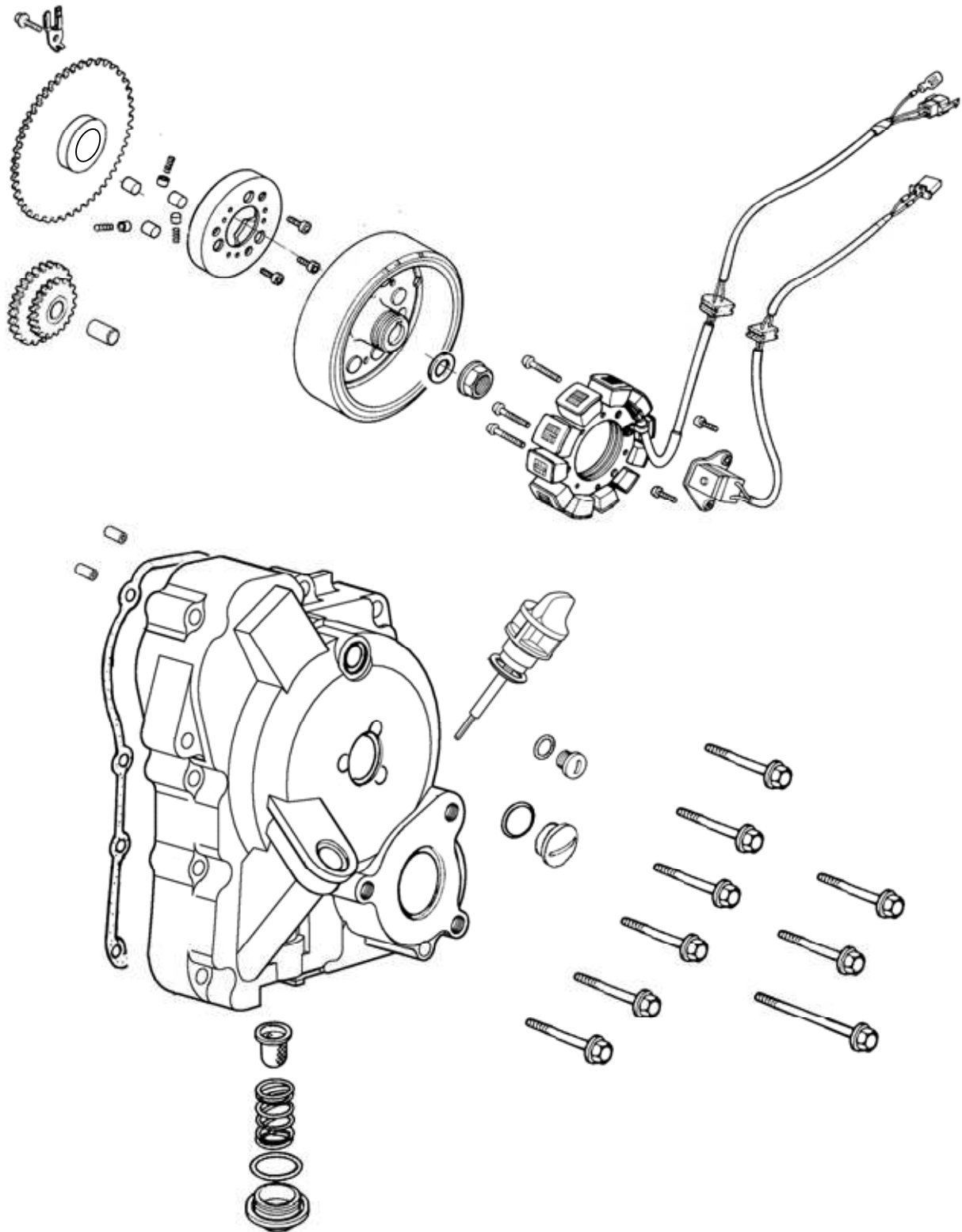

SERVICE INFORMATION

GENERAL INSTRUCTIONS

- All servicing operations and inspections in this section can be made with the engine installed.
- Drain the coolant before removing the right crankcase cover.
- Be careful not to drain the coolant when the engine temperature is high. (Perform this operation when the engine is cold.)
- Drain the coolant into a clean container.
- Drain the engine oil into a clean container before removing the right crankcase cover.
- When the right crankcase cover is installed, fill with the recommended engine oil and coolant. Then, bleed air from the water jacket.
- Refer to chapter 17 for A.C. generator inspection.

SPECIFICATIONS

Engine oil: SAE 10W/30#
API-SG

Oil capacity at change: 0.9 liter (0.79 imp qt, 0.95 US qt)

Coolant: distilled water + coolant concentrate

Coolant capacity: 1370±20cc

SPECIAL TOOLS

Flywheel puller A120E00003
Flywheel holder A120E00021

SPECIFICATIONS

Unit: mm (in)

Item	Standard	Service Limit
Starter driven gear I.D.	20.025 ~ 20.045 (0.801 ~ 0.8018)	20.15 (0.806)
Starter driven gear O.D.	42.175 ~ 42.2 (1.687 ~ 1.688)	41 (1.64)

TORQUE VALUES

Flywheel nut : 5.5 kgf-m (55 N-m, 40 lbf-ft)

TROUBLESHOOTING

Refer to page chapter 17 for A.C. generator troubleshooting.

Starter motor rotates but engine does not start

- Faulty starter clutch
- Starter motor rotates reversely
- Weak battery

ALTERNATOR STATOR

REMOVAL

Drain the engine oil (refer to the “ENGINE OIL” section in the chapter 3).

Disconnect the alternator stator connectors (refer to the chapter 17).

Remove the nine bolts from the right crankcase cover and then remove the cover.

Remove the two dowel pins and gasket.

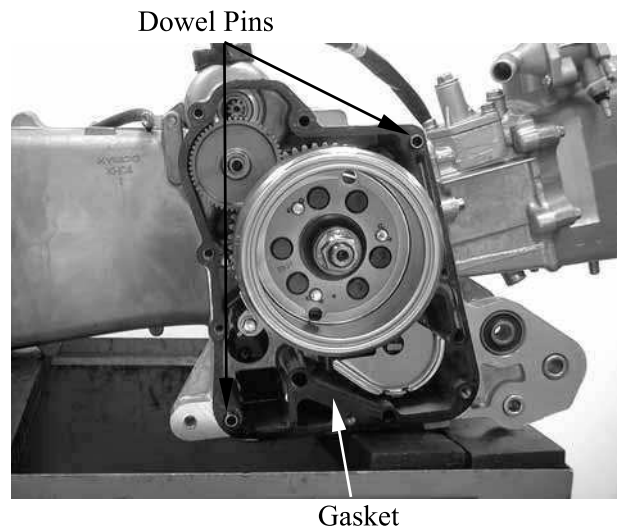
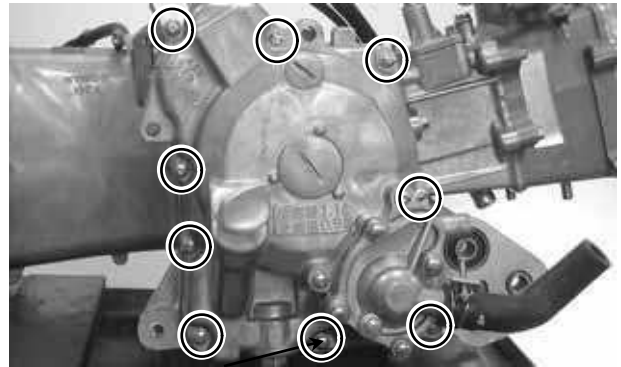

Remove the two pulse coil mount screws. Remove the three stator mount bolts, grommet and the stator from the right crankcase cover.

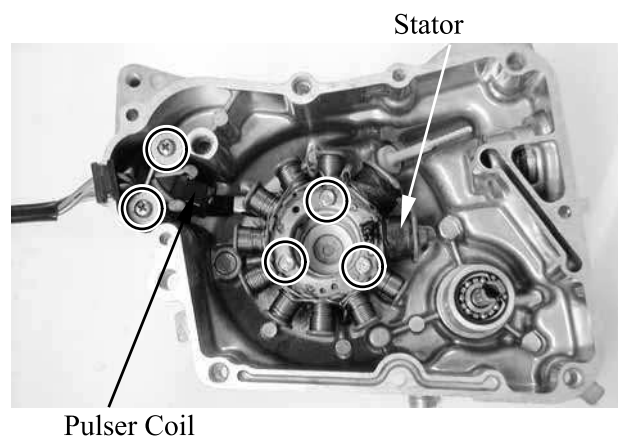

10. A.C. GENERATOR/STARTER CLUTCH

DINK 200i/125

INSPECTION

Check the stator and pulse coil for damage.

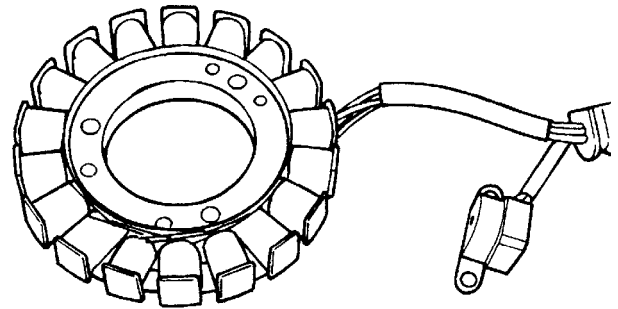

INSTALLATION

Install the stator and tighten the stator mount bolts to the specified torque.

Torque: 1 kgf-m (10 N-m, 7.2 lbf-ft)

Apply sealant to the grommet seating surface and install it to the cover groove properly.

Install the pulse coil and tighten mount screws securely.

Clean the mating surfaces of the right crankcase and cover.

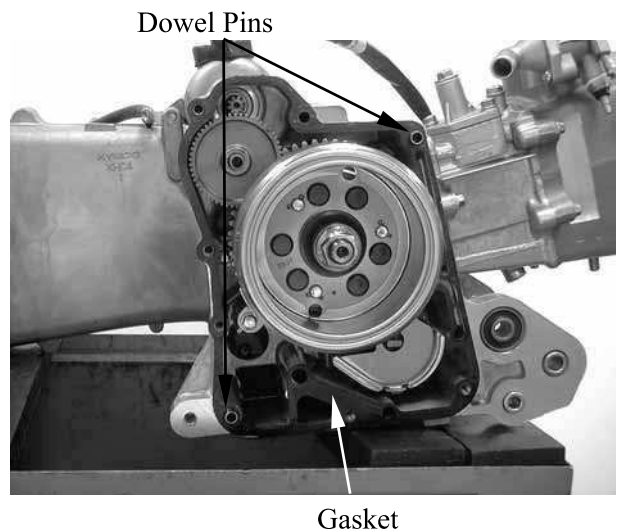
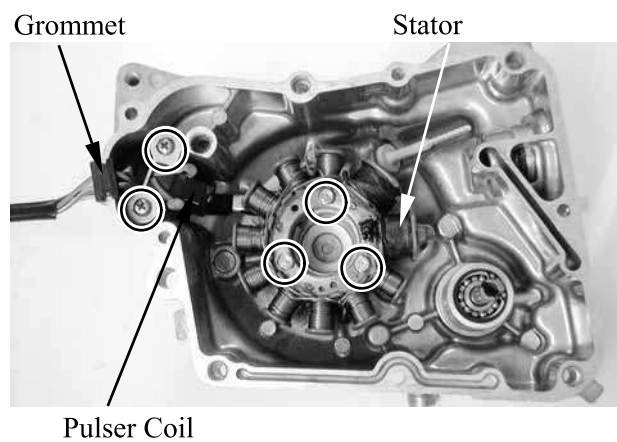

10. A.C. GENERATOR/STARTER CLUTCH

DINK 200i125

Install the dowel pins and gasket.

Install the right crankcase cover and tighten the bolts in a crisscross pattern in 2 or 3 steps.

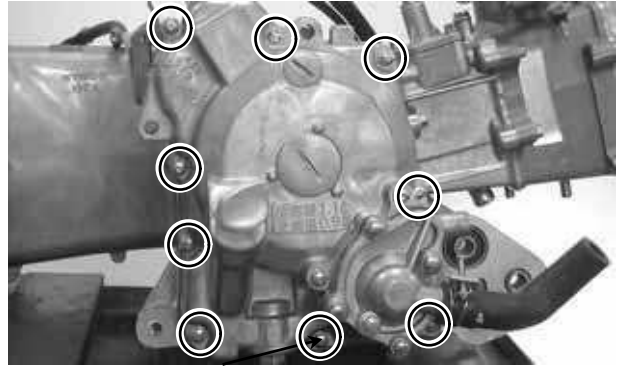

STARTER CLUTCH

REMOVAL

Remove the right crankcase cover (refer to the “ALTERNATOR STATOR” section in this chapter).

Hold the flywheel with a special tool and remove the flywheel nut.

Special tool:

Flywheel holder A120E00021

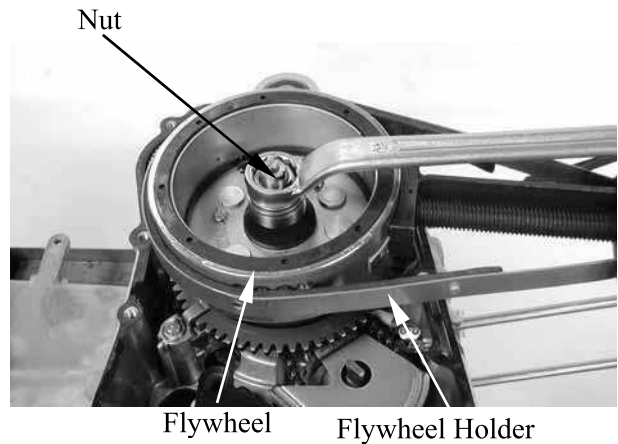

Remove the flywheel/driven gear by using the special tool.

Special tool:

Flywheel puller A120E00003



Remove the reduction gear shaft and reduction gear.

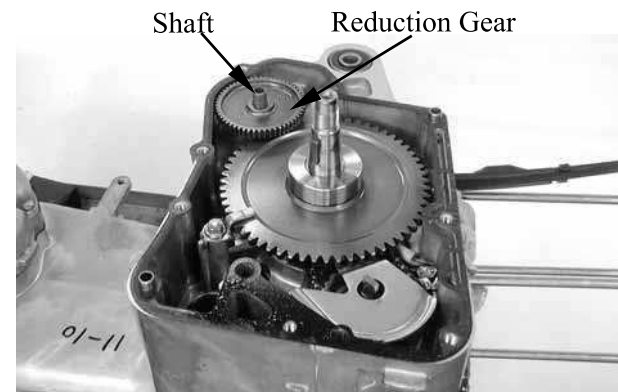

10. A.C. GENERATOR/STARTER CLUTCH

DINK 200i125

Remove the starter driven gear.



INSPECTION

Install the driven gear into the flywheel.

Check the operation of the sprag clutch by turning the driven gear. You should be able to turn the driven gear clockwise smoothly, but the gear should not turn counterclockwise.

Remove the starter driven gear by turning the driven gear.

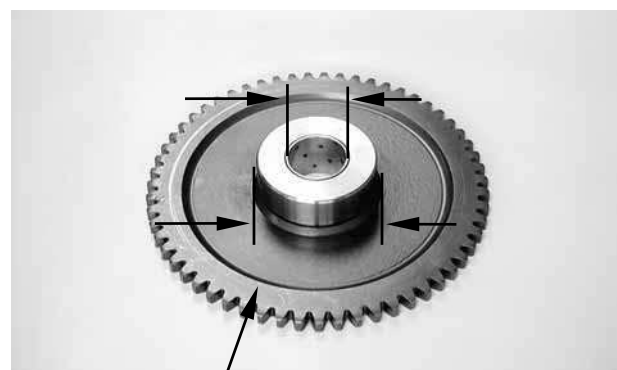

Check the starter driven gear teeth for wear or damage.

Measure the starter driven gear boss O.D..

Service limit: 41 mm (1.64 in)

Measure the starter driven gear bushing I.D..

Service limit: 20.15 mm (0.806 in)

Check the starter reduction gear teeth and shaft for wear or damage.

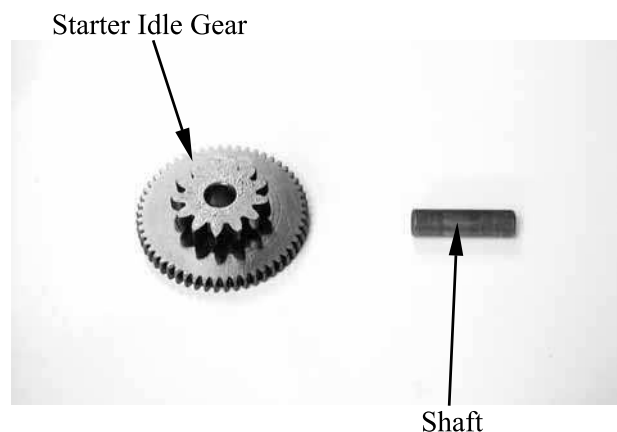

10. A.C. GENERATOR/STARTER CLUTCH

DINK 200i/125

INSTALLATION

Install the starter driven gear onto the crankshaft.



Apply oil to the starter reduction gear shaft. Install the starter reduction gear and shaft to the right crankcase.

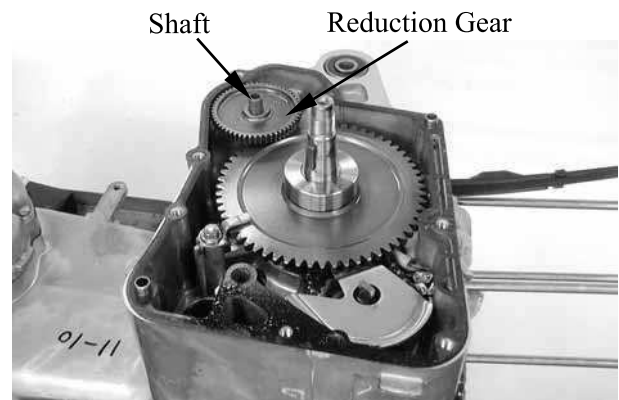

Install the flywheel onto the crankshaft by aligning the key on the crankshaft with the groove in the flywheel.

* Before installation, check and make sure that the inside of the flywheel is not contaminated.

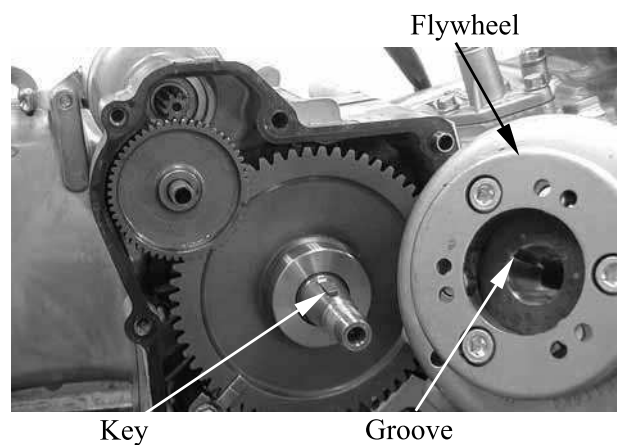

10. A.C. GENERATOR/STARTER CLUTCH

DINK 200i125

Hold the flywheel with the special tool and tighten the flywheel nut.

Torque: 5.5 kgf-m (55 N-m, 40 lbf-ft)

Special tool:

Flywheel holder A120E00021

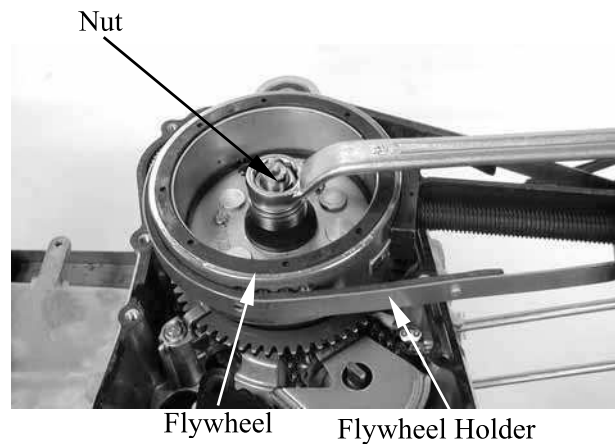

11. CRANKCASE/CRANKSHAFT

CRANKCASE/CRANKSHAFT

SCHEMATIC DRAWING -----	11-1
SERVICE INFORMATION-----	11-2
TROUBLESHOOTING-----	11-2
CRANKCASE SEPARATION -----	11-3
CRANKSHAFT INSPECTION-----	11-4
CRANKCASE ASSEMBLY -----	11-5

11. CRANKCASE/CRANKSHAFT

SCHEMATIC DRAWING

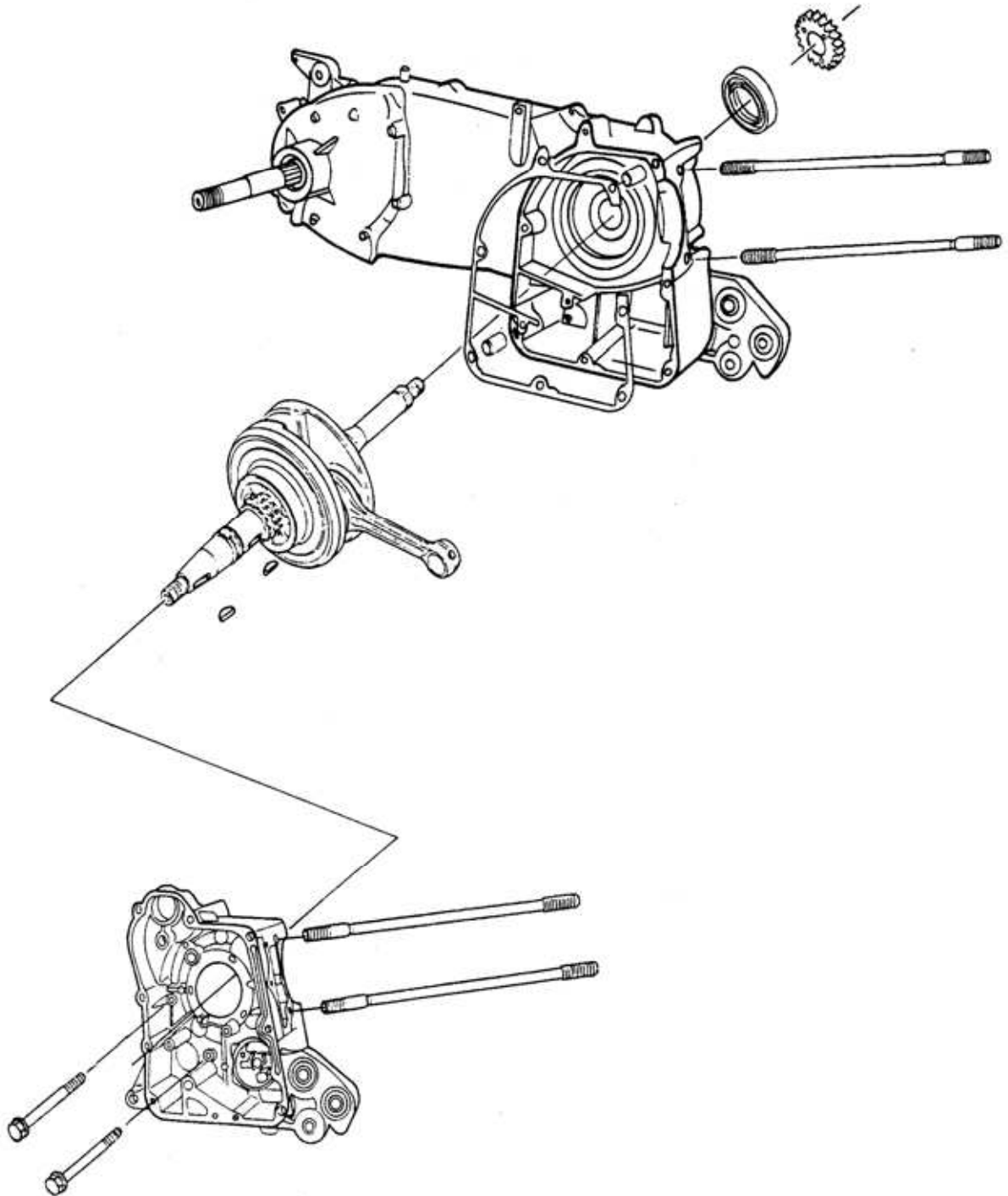

SERVICE INFORMATION

GENERAL INSTRUCTIONS

- This section covers crankcase separation to service the crankshaft. The engine must be removed for this operation.
- When separating the crankcase, never use a driver to pry the crankcase mating surfaces apart forcibly to prevent damaging the mating surfaces.
- When installing the crankcase, do not use an iron hammer to tap it.
- The following parts must be removed before separating the crankcase.
 - Cylinder head (chapter 6)
 - Cylinder/piston (chapter 7)
 - Drive and driven pulley (chapter 8)
 - A.C. generator/starter clutch (chapter 10)
 - Rear wheel/rear shock absorber (chapter 16)
 - Starter motor (chapter 19)
 - Oil pump (chapter 4)

SPECIFICATIONS

Unit: mm (in)

	Item	Standard	Service Limit
Crankshaft	Connecting rod big end side clearance	0.15~0.35 (0.006~0.014)	0.6 (0.024)
	Connecting rod big end radial clearance	0~0.008 (0~0.00032)	0.05 (0.002)
	Runout	—	0.1 (0.004)

TORQUE VALUES

- | | |
|----------------------------------|-------------------------------|
| Crankcase bolt | 1 kgf-m (10N-m, 7.2 lbf-ft) |
| Cam chain tensioner slipper bolt | 1.2 kgf-m (12N-m, 8.6 lbf-ft) |

TROUBLESHOOTING

Excessive engine noise

- Excessive bearing play
- Excessive crankpin bearing play
- Worn piston pin and piston pin hole

CRANKCASE SEPARATION

Remove the cam chain tensioner slipper bolt.
 Remove the cam chain tensioner slipper and cam chain.
 Remove the two right crankcase attaching bolts.

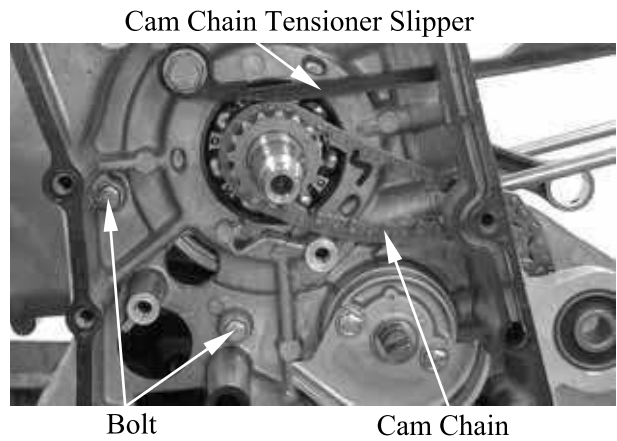

Remove the five left crankcase bolts.

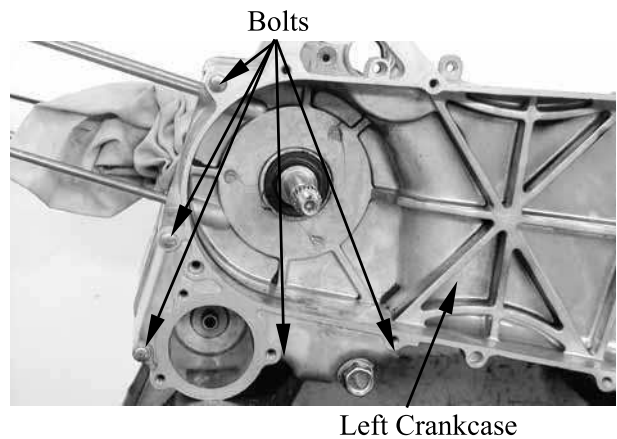

Place the crankcase with the left crankcase down and remove the right crankcase from the left crankcase.

* Never use a driver to pry the crankcase mating surfaces apart.

Remove the gasket and dowel pins.

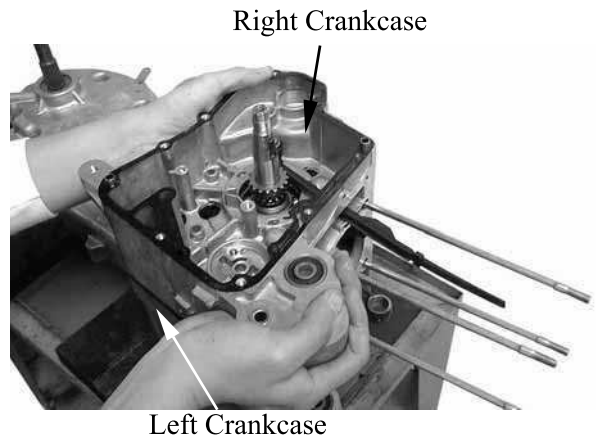

Remove the crankshaft from the left crankcase.

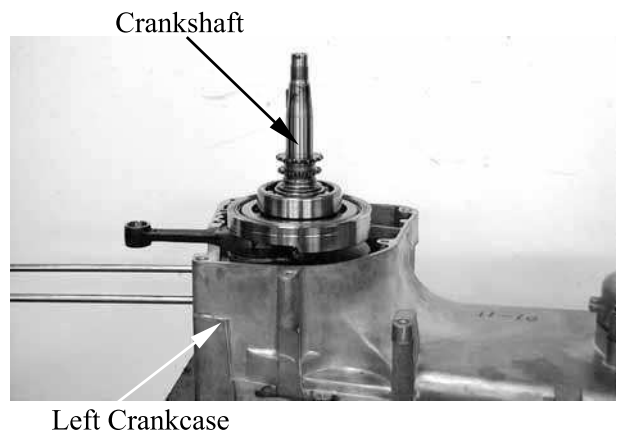

11. CRANKCASE/CRANKSHAFT

Remove the oil seal from the left crankcase.

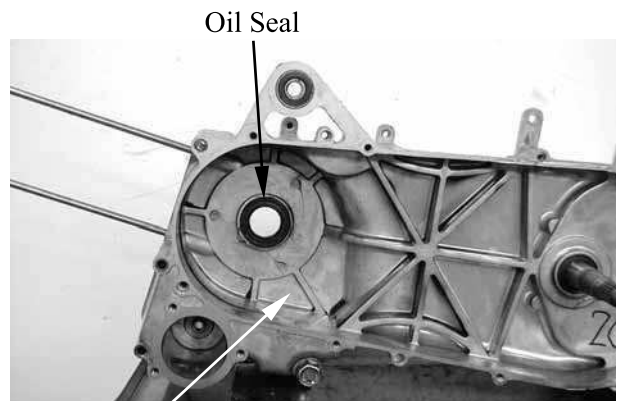

Left Crankcase

CRANKSHAFT INSPECTION

Measure the connecting rod big end side clearance.

Service Limit: 0.6 mm (0.024 in)



Measure the connecting rod small end I.D.

Service Limit: 15.06 mm (0.6024 in)



11. CRANKCASE/CRANKSHAFT

DINK 200i/125

Measure the crankshaft runout.

Service Limit: 0.1 mm (0.004 in)

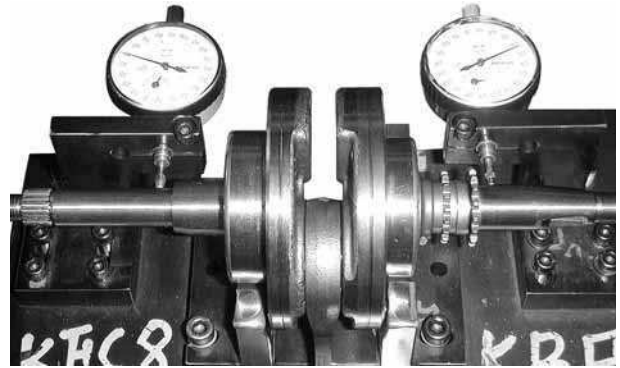

Measure the crankshaft bearing play.

Service Limits:

Axial : 0.2 mm (0.008 in)

Radial: 0.05 mm (0.002 in)

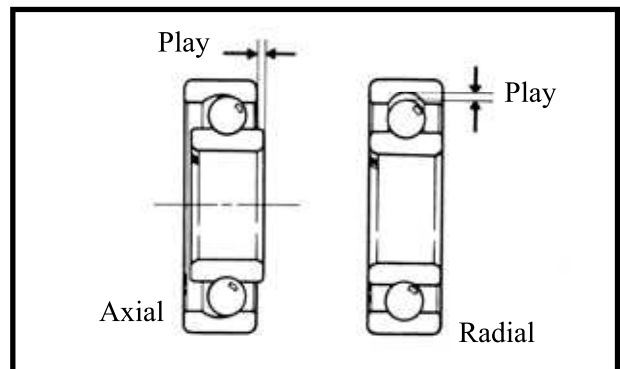

CRANKCASE ASSEMBLY

Clean off all gasket material from the crankcase mating surfaces.

* Avoid damaging the crankcase mating surfaces.



Install a new oil seal into the left crankcase.



Left Crankcase

11. CRANKCASE/CRANKSHAFT

DINK 200i/125

Place the left crankcase down and install the crankshaft into the left crankcase.

- *
 - Avoid damaging the oil seal.
 - Apply grease to the lip of the oil seal.



Install the two dowel pins and a new gasket.

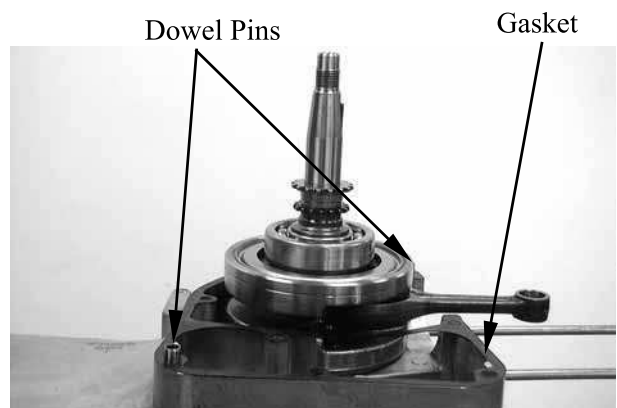

Place the right crankcase over the crankshaft and onto the left crankcase.

- *
 Install the right crankcase squarely and do not tap it with an iron or plastic hammer.

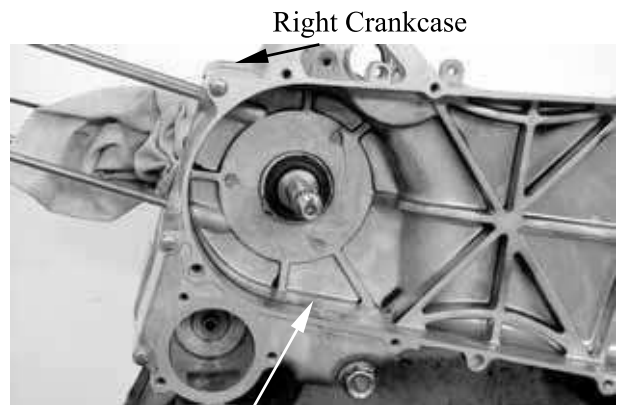

Install and tighten the right and left crankcase attaching bolts.

Torque: 1 kgf-m (10 N-m, 7.2 lbf-ft)

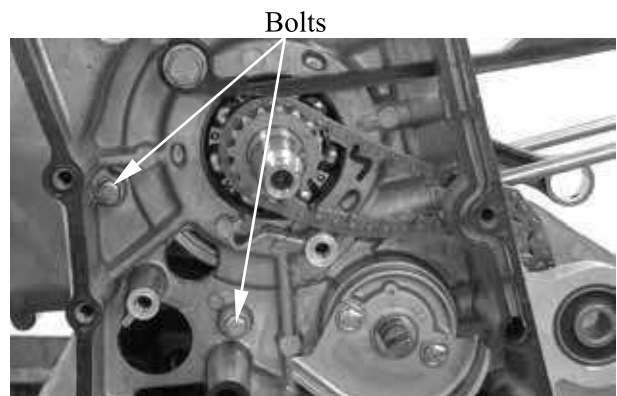

11. CRANKCASE/CRANKSHAFT

DINK 200i/125

Install the cam chain.
Install the cam chain tensioner slipper.
Install and tighten the cam chain tensioner slipper bolt.

Torque: 1.2 kgf-m (12 N-m, 8.6 lbf-ft)

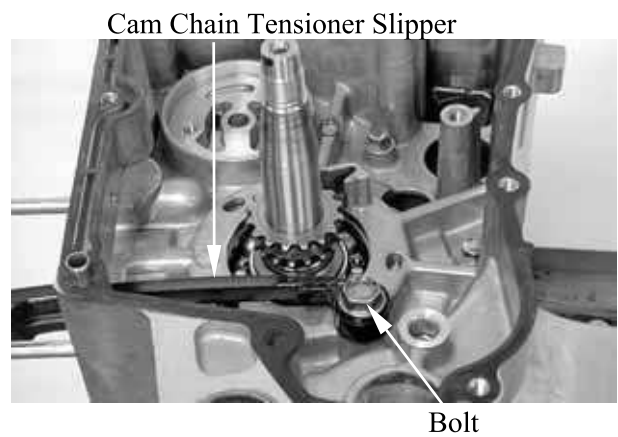

12. COOLING SYSTEM

COOLING SYSTEM

SCHEMATIC DRAWING -----	12- 1
SERVICE INFORMATION-----	12- 2
TROUBLESHOOTING-----	12- 2
COOLING SYSTEM TESTING-----	12- 4
COOLANT REPLACEMENT -----	12- 5
RADIATOR -----	12- 8
FAN MOTOR -----	12-10
FAN MOTOR SWITCH -----	12-11
WATER PUMP -----	12-12
WATER TEMPERATURE SENSOR -----	12-18
THERMOSTAT-----	12-20

12. COOLING SYSTEM

DINK 200i/125

SCHEMATIC DRAWING

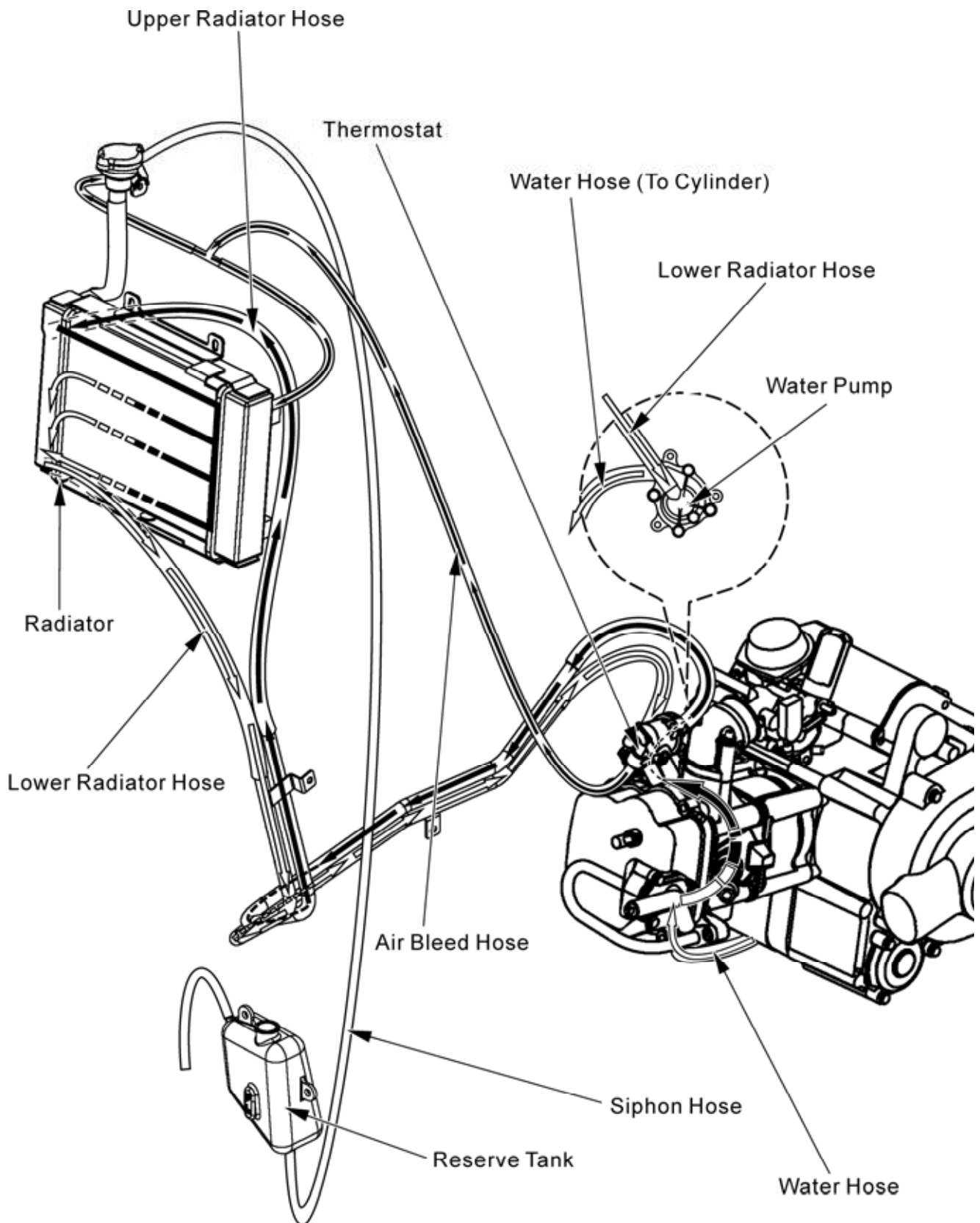

12. COOLING SYSTEM

SERVICE INFORMATION

GENERAL INSTRUCTIONS

- The water pump must be serviced after removing the engine. Other cooling system service can be done with the engine installed in the frame.
- The engine must be cool before servicing the cooling system.
When the coolant temperature is over 100• ; never remove the radiator cap to release the pressure because the boiling coolant may cause danger.
- Avoid spilling coolant on painted surfaces because the coolant will corrode the painted surfaces. Wash off any spilled coolant with fresh water as soon as possible.
- After servicing the system, check for leaks with a cooling system tester.

SPECIAL TOOL

Mechanical seal driver

TORQUE VALUES

Water pump impeller	1.2 kgf-m (12 N-m, 9 lbf-ft)	Left hand threads
Water pump cover bolt	1 kgf-m (10 N-m, 7 lbf-ft)	

TROUBLESHOOTING

Engine temperature too high

- Faulty temperature gauge or thermosensor
- Faulty radiator cap
- Faulty thermostat
- Insufficient coolant
- Passages blocked in hoses or water jacket
- Clogged radiator fins
- Passages blocked in radiator
- Faulty water pump

Coolant leaks

- Faulty pump mechanical (water) seal
- Deteriorated O-rings
- Damaged or deteriorated water hoses

Temperature gauge pointer does not register the correct coolant temperature

- Faulty temperature gauge or thermosensor
- Faulty thermostat

12. COOLING SYSTEM

DINK 200i/125

SPECIFICATIONS

Radiator cap relief pressure		90 kPa (0.9 kgf/cm ² , 12.8 psi)
Thermostat temperature	Begins to open	80 - 82°C (176 - 180°F)
	Full-open	90°C (198°F)
	Valve lift	3.5 mm (0.14 in) minimum
Coolant capacity	Radiator and engine	1 liter (1.1 US qt, 0.88 Imp qt)
	Reserve tank	0.37 liter (0.4 US qt, 0.33 Imp qt)
Standard coolant concentration		1:1 mixture with soft water

COOLANT GRAVITY

Coolant concentration \ Temp. •	Temp. •											
	0	5	10	15	20	25	30	35	40	45	50	
5%	1.009	1.009	1.008	1.008	1.007	1.006	1.005	1.003	1.001	0.009	0.997	
10%	1.018	1.107	1.017	1.016	1.015	1.014	0.013	1.011	1.009	1.007	1.005	
15%	1.028	1.027	1.026	1.025	1.024	1.022	1.020	1.018	1.016	1.014	1.012	
20%	1.036	1.035	1.034	1.033	1.031	1.029	1.027	1.025	1.023	1.021	1.019	
25%	1.045	1.044	1.043	1.042	1.040	1.038	1.036	1.034	1.031	1.028	1.025	
30%	1.053	1.051	1.051	1.049	1.047	1.045	1.043	1.041	1.038	1.035	1.032	
35%	1.063	1.062	1.060	1.058	1.056	1.054	1.052	1.049	1.046	1.043	1.040	
40%	1.072	1.070	1.068	1.066	1.064	1.062	1.059	1.056	1.053	1.050	1.047	
45%	1.080	1.078	1.076	1.074	1.072	1.069	1.056	1.063	1.062	1.057	1.054	
50%	1.086	1.084	1.082	1.080	1.077	1.074	1.071	1.068	1.065	1.062	1.059	
55%	1.095	1.093	1.091	1.088	1.085	1.082	1.079	1.076	1.073	1.070	1.067	
60%	1.100	1.098	1.095	1.092	1.089	1.086	1.083	1.080	1.077	1.074	1.071	

COOLANT MIXTURE (WITH ANTI-RUST AND ANTI-FREEZING EFFECTS)

Freezing Point	Mixing Rate	KYMCO SIGMA Coolant Concentrate	Distilled Water
-9• •	20%		
-15• •	30%	425cc	975cc
-25• •	40%		
-37• •	50%		
-44.5• •	55%		

Cautions for Using Coolant:

- Use coolant of specified mixing rate. (The mixing rate of 425cc KYMCO SIGMA coolant concentrate + 975cc distilled water is 30%.)
- Do not mix coolant concentrate of different brands.
- Do not drink the coolant which is poisonous.
- The freezing point of coolant mixture shall be 5• lower than the freezing point of the riding area.

12. COOLING SYSTEM

COOLING SYSTEM TESTING

RADIATOR CAP INSPECTION

- Removing the radiator cap while the engine is hot can cause the coolant to spray out, seriously scalding you.

Always let the engine and radiator cool down before removing the radiator cap.

Remove the radiator cap (1).

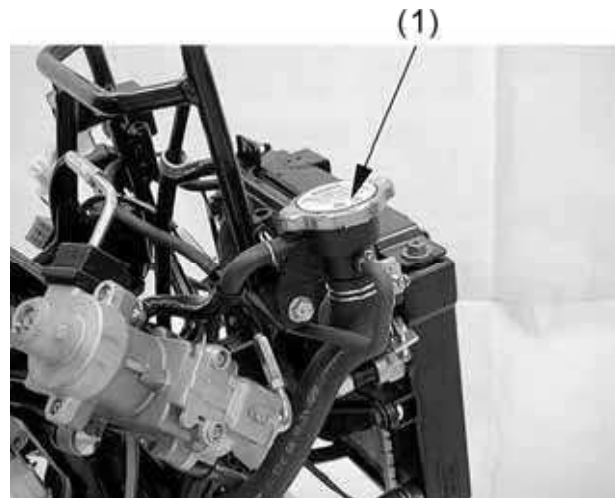

Pressure test the radiator cap. Replace the radiator cap if it does not hold pressure, or if relief pressure is too high or too low. It must hold the specified pressure for at least six seconds.

- Before installing the cap in the tester, wet the sealing surface.

Radiator Cap Relief Pressure:

90 kPa (0.9 kg/cm², 12.8 psi)

Pressurize the radiator, engine and hoses, and check for leaks.

- Excessive pressure can damage the cooling system components. Do not exceed 105 kPa (1.05 kg/cm², 14.9 psi).

Repair or replace components if the system will not hold the specified pressure for at least six seconds.

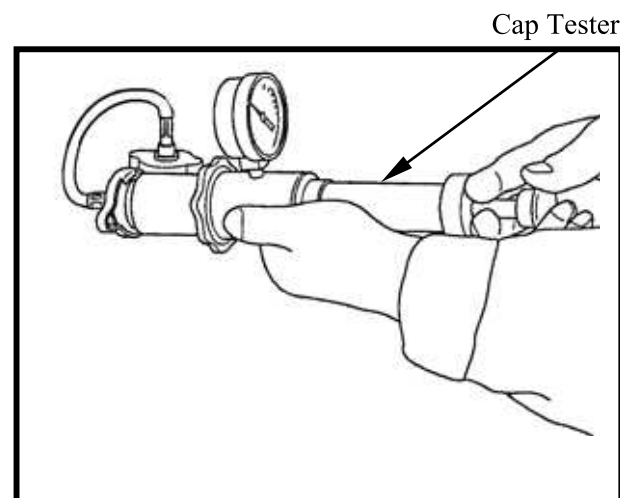
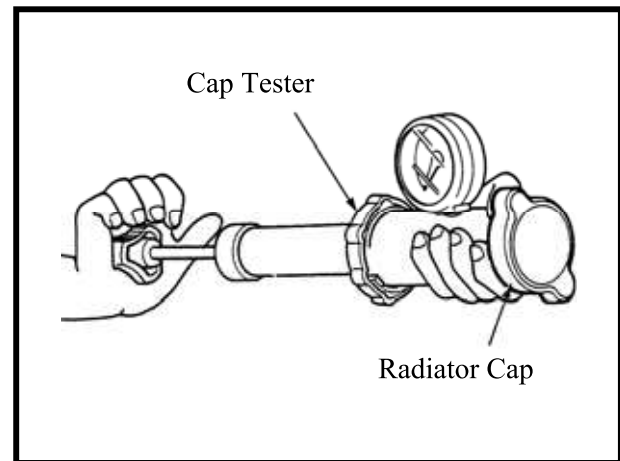

COOLANT REPLACEMENT

PREPARATION

- The effectiveness of coolant decreases with the accumulation of rust or if there is a change in the mixing proportion during usage. Therefore, for best performance change the coolant regularly as specified in the maintenance schedule.
- Mix only distilled, low mineral water with the antifreeze.

Recommended mixture:

1:1 (Distilled water and antifreeze)

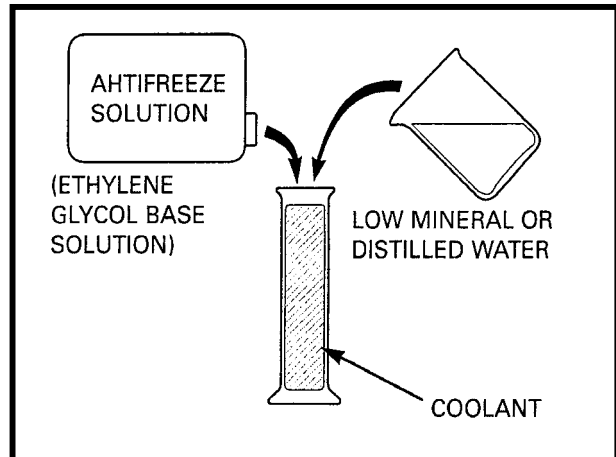

REPLACEMENT/AIR BLEEDING

Remove the front cover (refer to the “**FRAME COVERS REMOVAL/INSTALLATION**” section in the chapter 2).

- When filling the system or reserve tank with coolant (checking the coolant level), place the scooter in a vertical position on a flat, level surface.

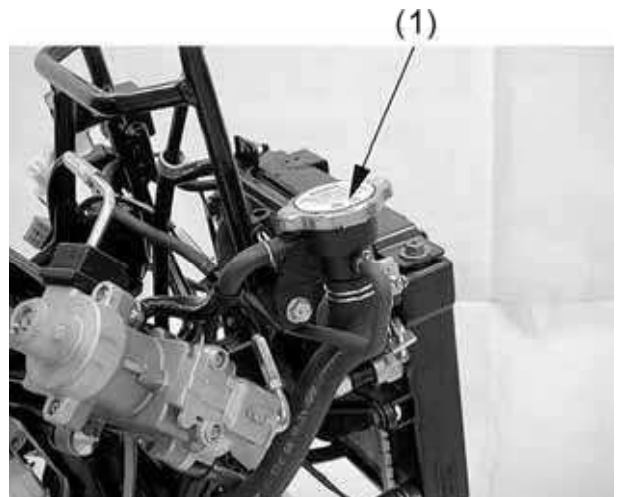

Remove the radiator cap (1).

Remove the drain bolt (2) and drain the coolant from the system.

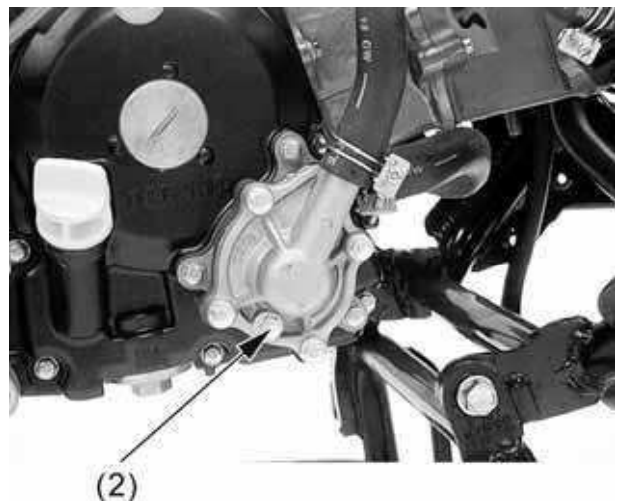

12. COOLING SYSTEM

Remove the screw (3) and reserve tank lid (4).

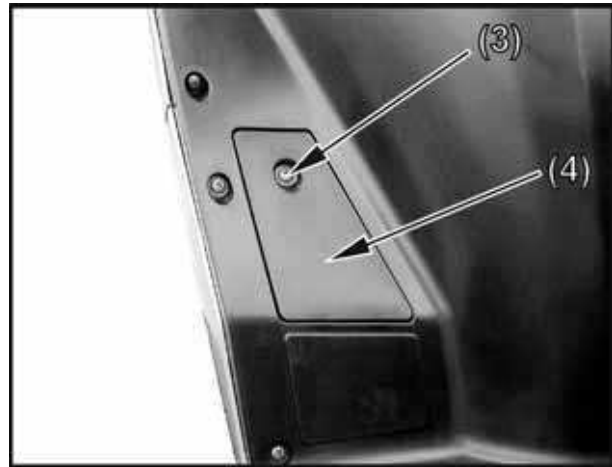

Remove the reserve tank cap (5) and drain the coolant from the reserve tank.

Reinstall and tighten the drain bolt securely.



Place the scooter on its center stand on a flat, level surface.
Fill the reserve tank to the upper level line (6).

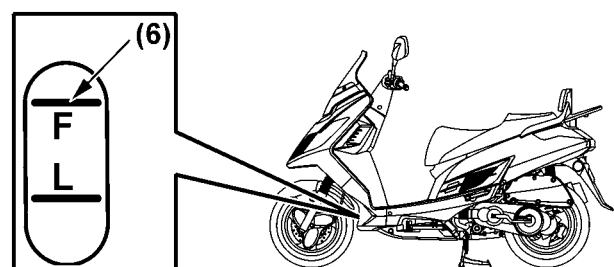

12. COOLING SYSTEM

Fill the system with the recommended coolant through the filler opening up to the filler neck (1).

Bleed air from the system as follow:

1. Start the engine and let it idle for 2–3 minutes.
2. Snap the throttle three to four times to bleed air from the system.
3. Stop the engine and add coolant to the proper level if necessary. Reinstall the radiator cap.
4. Check the level of coolant in the reserve tank and fill to the upper level if it is low.

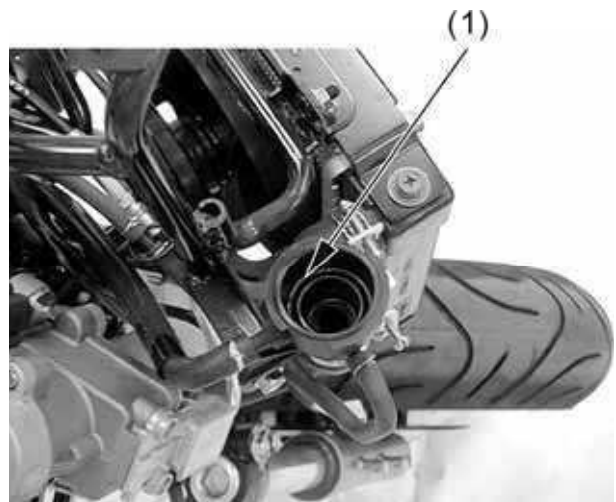

12. COOLING SYSTEM

RADIATOR

REMOVAL

Drain the coolant (see page 12-5).

Disconnect the siphon hose (1) and air bleed hose (2).

Remove the bolt (3).

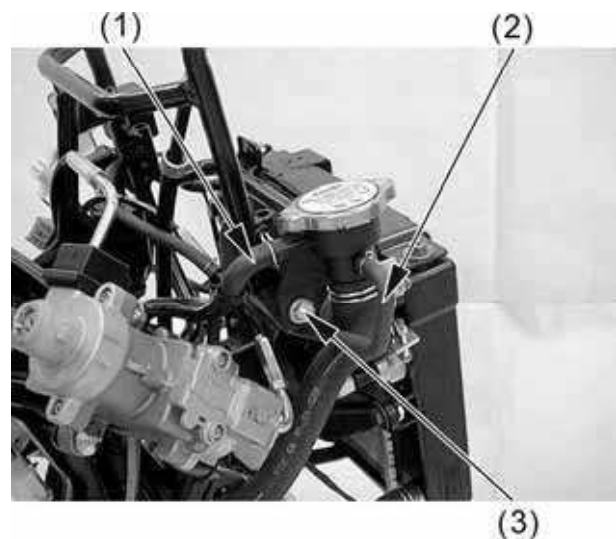

Loosen the hose bands, then disconnect the upper radiator hose (4) and lower radiator hose (5) from the radiator.

Disconnect the fan motor switch connectors (6).

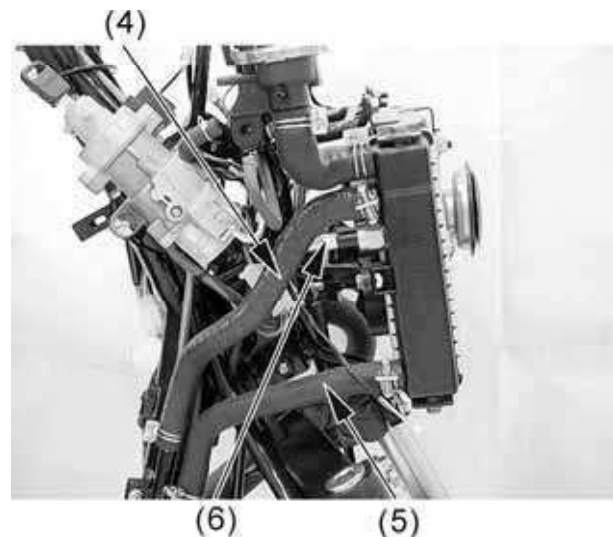

Disconnect the air bleed hose (7).
Disconnect the fan motor connector (8).
Remove the nut and horn (9)

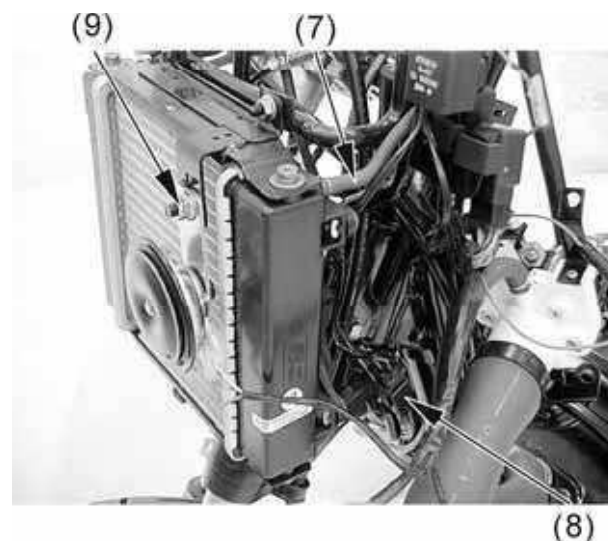

12. COOLING SYSTEM

Remove the three nuts (10) and then remove the radiator from frame.

INSTALLATION

Installation is in the reverse order of removal.

Refill the coolant (refer to the **“COOLANT REPLACEMENT”** section in this chapter).

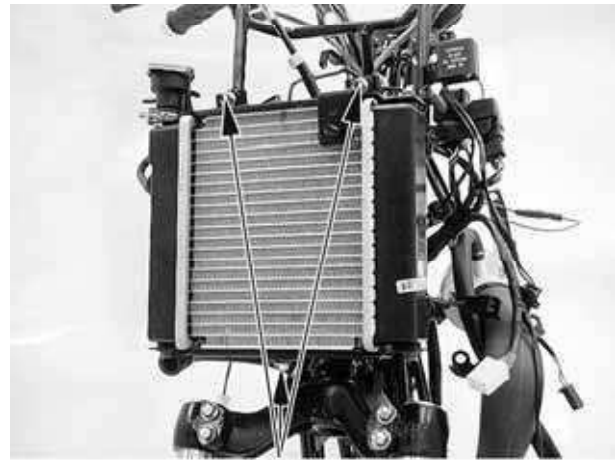

(10)

12. COOLING SYSTEM

FAN MOTOR

REMOVAL

Remove the radiator (refer to the “**RADIATOR**” section in this chapter)

Remove the three mounting bolts (1) and then remove the fan motor (2)

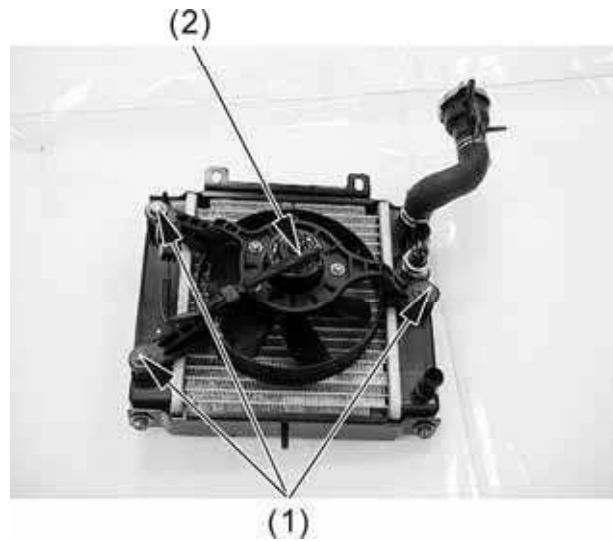

INSPECTION

Check the fan motor to operate using an available battery.

INSTALLATION

Installation is in the reverse order of removal.

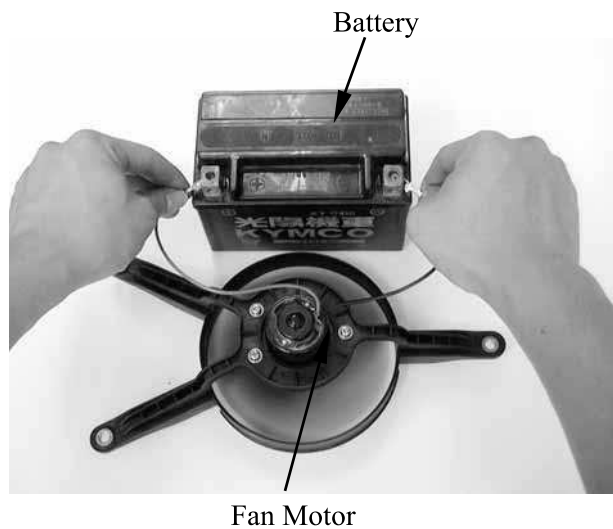

12. COOLING SYSTEM

FAN MOTOR SWITCH

REMOVAL

Disconnect the fan motor switch connectors (refer to the “RADIATOR” section in this chapter).

Remove the fan motor switch (1).

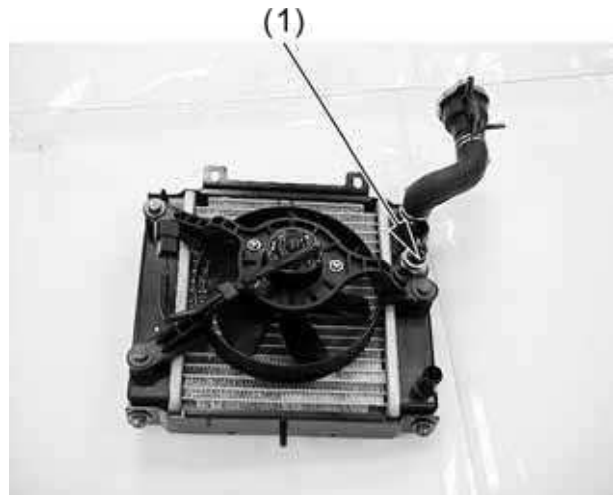

INSPECTION

Place the fan motor switch in oil contained in a pan as shown and raise the oil temperature gradually to check for the temperature at which the switch starts to operate.

If the switch operating temperature is not within the specified range, replace the switch with a new one.

OFF→ON	Over 88–92°C
ON→OFF	Lower 88–92°C

- - Handle the cooling fan motor switch carefully as it is vulnerable to impact.
 - Do not allow the cooling fan motor switch ① and the thermometer ② to come in contact with the bottom of the pan.

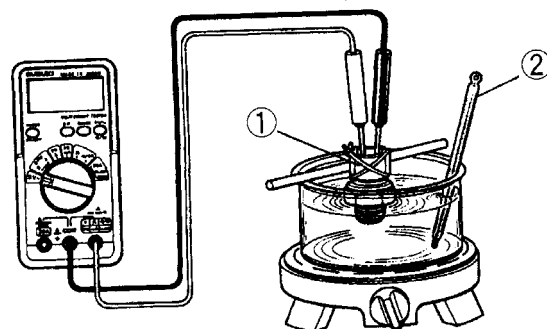

INSTALLATION

Fit the new O-ring.

Tighten the cooling fan motor switch to specified torque.

Torque: 1.8 kgf-m (18 N-m, 13 lbf-ft)

- - Replace the O-ring a new one.
 - Do not coat grease to the O-ring.

12. COOLING SYSTEM

WATER PUMP

MECHANICAL SEAL (WATER SEAL) INSPECTION

Inspect the telltale hole for signs of mechanical seal coolant leakage. If the mechanical seal is leaking, remove the right crankcase cover and replace the mechanical seal.

Right Crankcase Cover

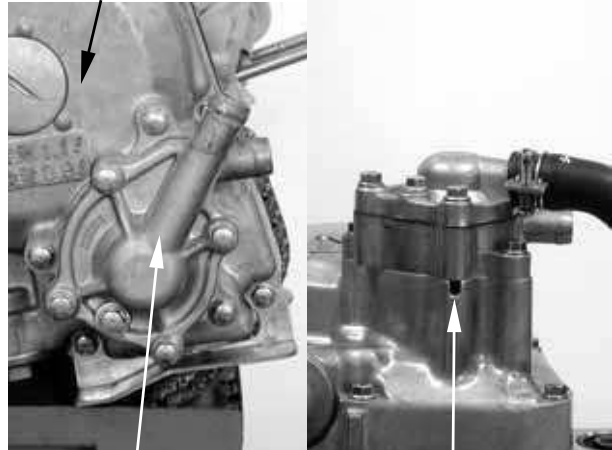

Water Pump

Telltale Hole

WATER PUMP/IMPELLER REMOVAL

Drain the coolant (see page 12-5).

Remove the coolant inlet hose and outlet hose.

Inlet Hose



Outlet Hose

12. COOLING SYSTEM

DINK 200i/125

Remove the four bolts and the water pump cover, gasket and 2 dowel pins.

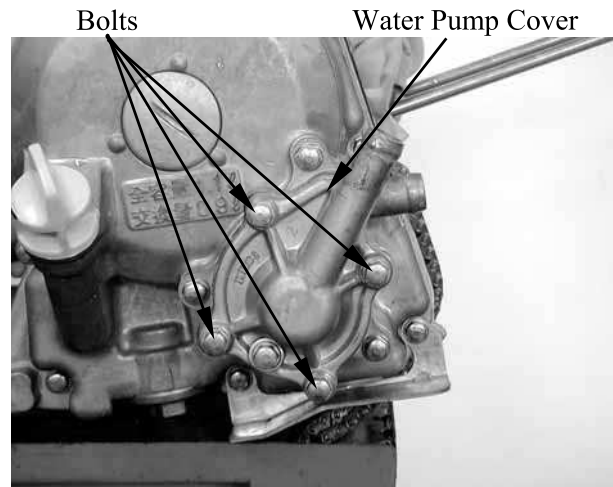

Remove the water pump impeller.

- The impeller has left hand threads.

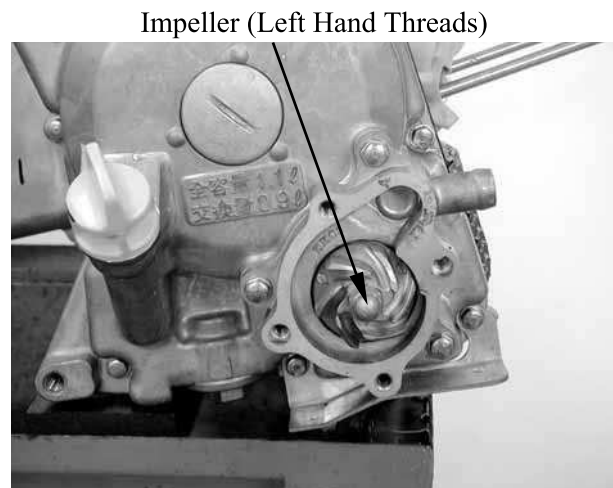

Inspect the mechanical (water) seal and seal washer for wear or damage.

- The mechanical seal and seal washer must be replaced as a set.

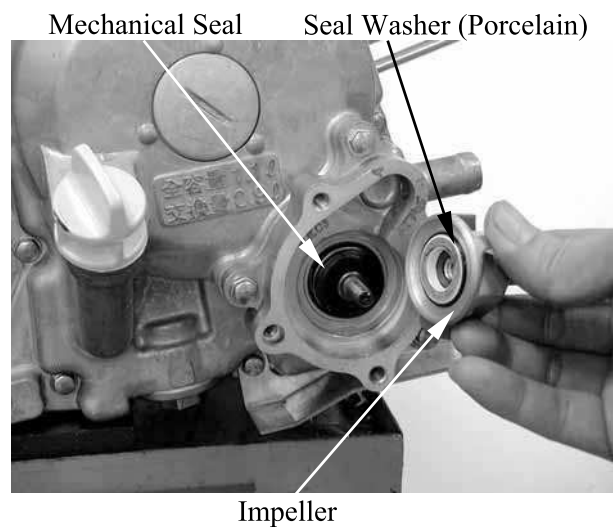

12. COOLING SYSTEM

WATER PUMP SHAFT REMOVAL

Disconnect the water hose from the right crankcase cover.
Remove the 3 bolts attaching the water pump assembly.
Remove the water pump assembly, gasket and dowel pins.

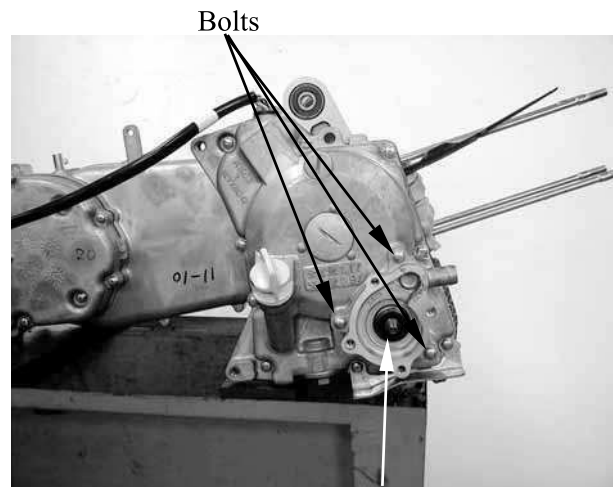

Water Pump Assembly

Remove the water pump bearing snap ring from the water pump assembly.
Remove the water pump shaft and shaft inner bearing.

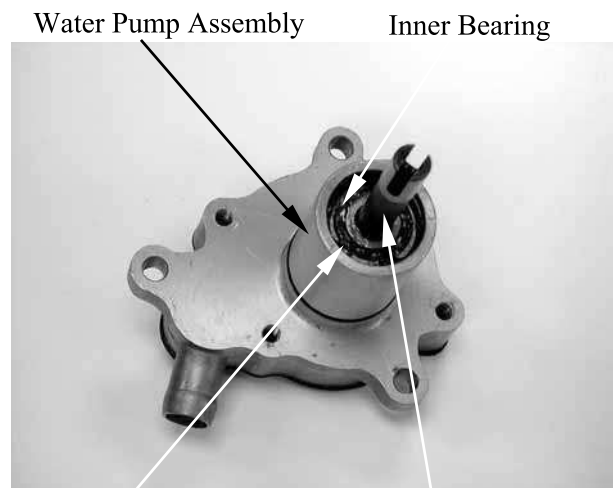

Water Pump Assembly

Inner Bearing

Snap Ring

Water Pump Shaft

Remove the water pump shaft outer bearing.

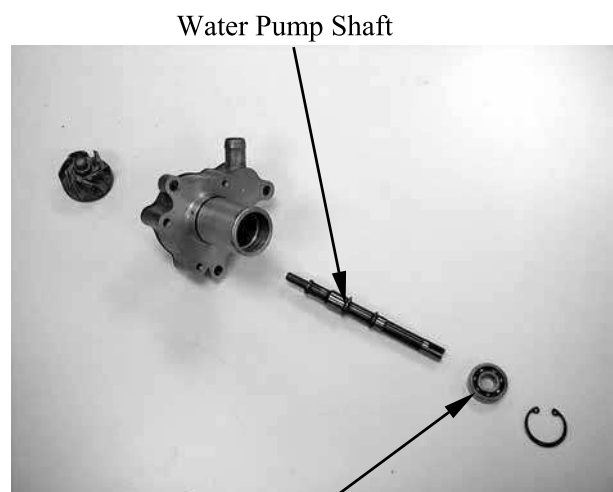

Water Pump Shaft

Inner Bearing

12. COOLING SYSTEM

MECHANICAL SEAL REPLACEMENT

Drive the mechanical seal out of the water pump assembly from the inside.

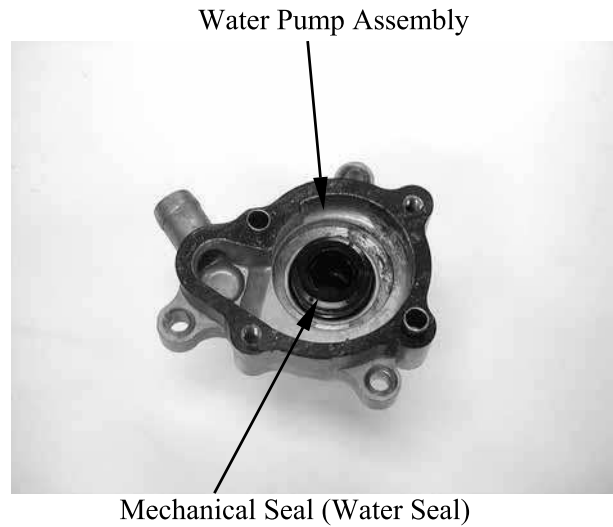

Drive in a new mechanical seal using a mechanical seal driver.

- Apply sealant to the right crankcase cover fitting surface of a new mechanical seal and then drive in the mechanical seal.

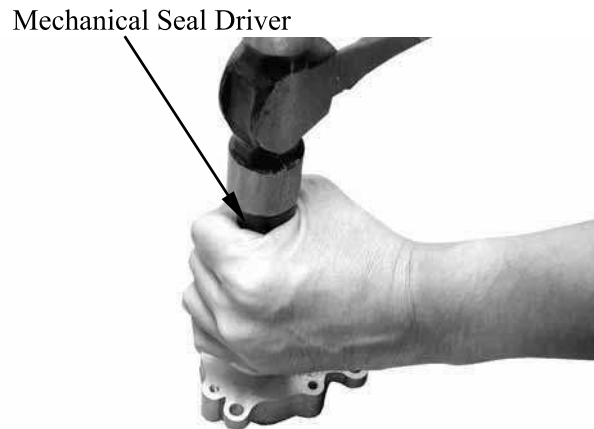

WATER PUMP SHAFT INSTALLATION

Drive a new water pump shaft outer bearing into the water pump assembly from the inside.

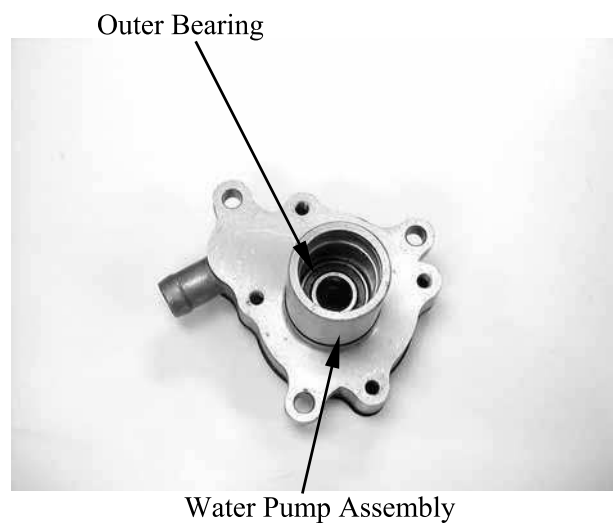

12. COOLING SYSTEM

Install the water pump shaft and shaft inner bearing into the water pump assembly. Install the snap ring to secure the inner bearing properly.

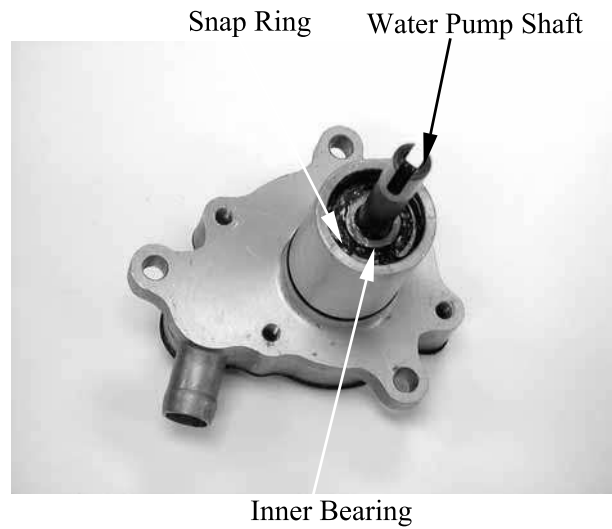

Install the dowel pins and a new gasket and then install the water pump assembly to the right crankcase cover. Tighten the 3 bolts to secure the water pump assembly.

- When installing the water pump assembly, aligning the groove on the water pump shaft with the tab on the oil pump shaft.

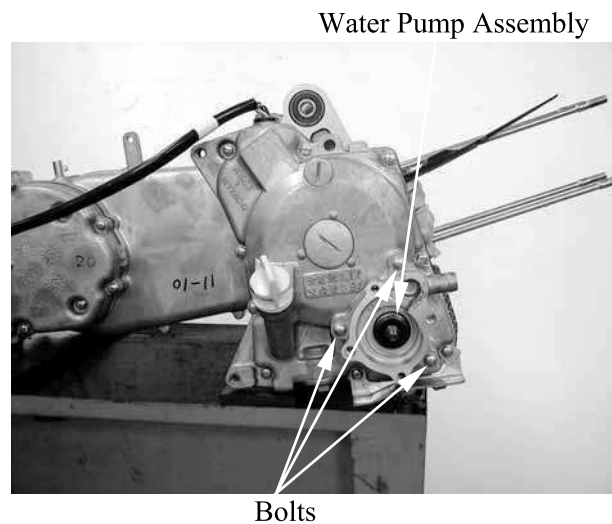

WATER PUMP/IMPELLER INSTALLATION

When the mechanical seal is replaced, a new seal washer must be installed to the impeller.

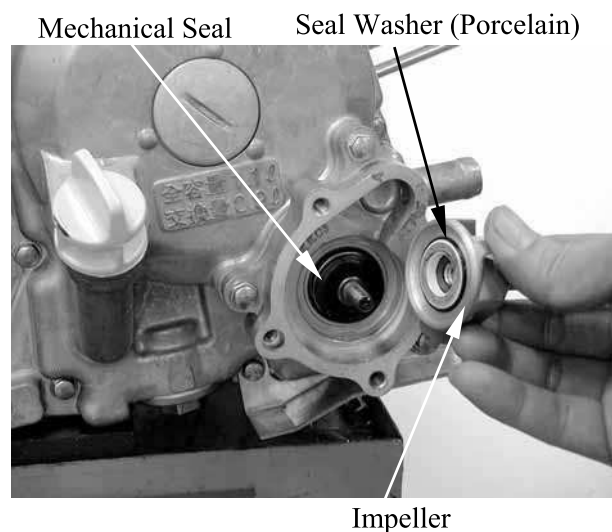

12. COOLING SYSTEM

Install the impeller onto the water pump shaft.

Torque: 1.2 kgf-m (12 N-m, 9 lbf-ft)

- The impeller has left hand threads.

Impeller (Left Hand Threads)

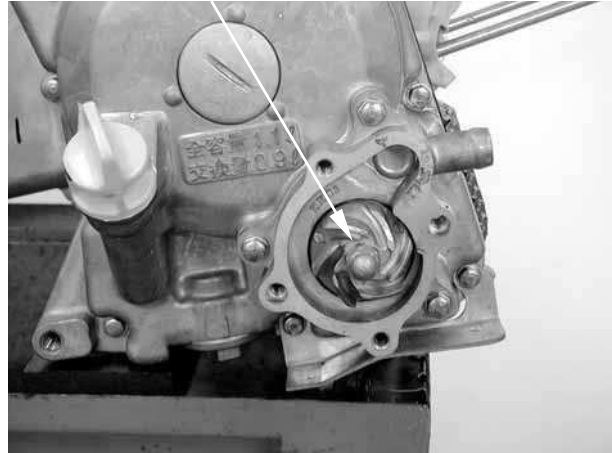

Install the two dowel pins and a new gasket.

Dowel Pins

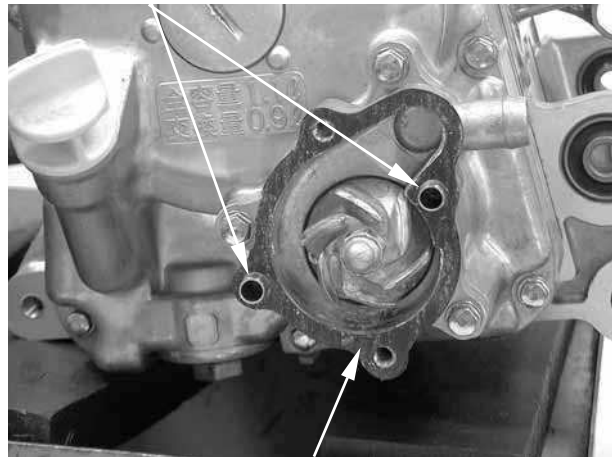

Gasket

Install the water pump cover and tighten the 4 bolts.

Torque: 1 kgf-m (10 N-m, 7 lbf-ft)

Water Pump Cover

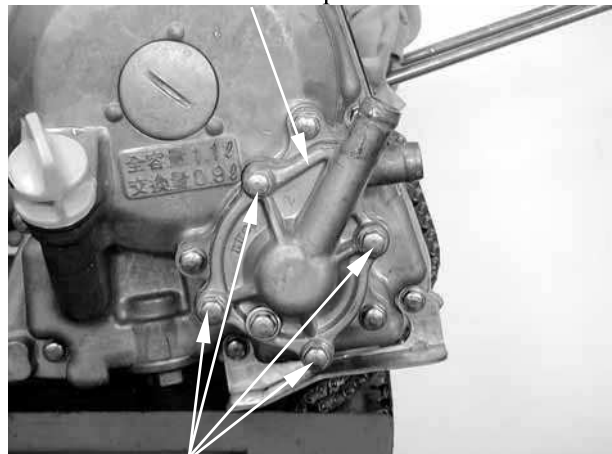

Bolt

12. COOLING SYSTEM

WATER TEMPERATURE SENSOR

REMOVAL

Remove the luggage box (refer to the “**FRAME COVERS REMOVAL/INSTALLATION**” section in the chapter 2).

Drain the coolant (refer to the “**COOLANT REPLACEMENT**” section in this chapter).

Disconnect the water temperature sensor connectors (1).

Remove the water temperature sensor (2) from thermostat.

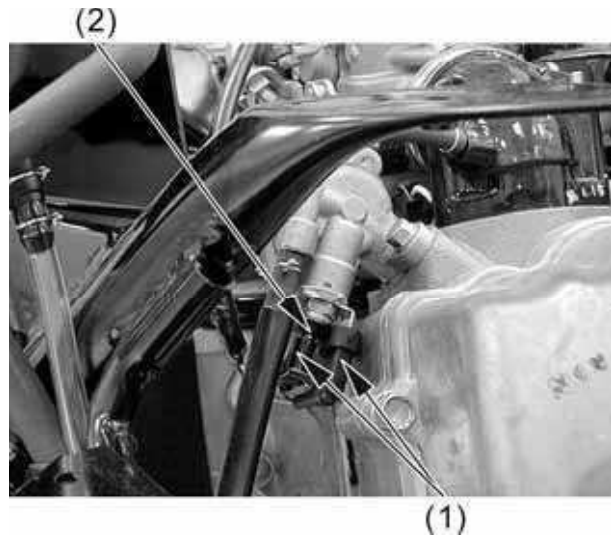

INSPECTION

Connect the water temperature sensor to the ohmmeter and dip it in oil contained in a pan which is placed on an electric heater.

Gradually raise oil temperature while reading the thermometer in the pan and the ohmmeter connected. If the resistance measured is out of specification, replace the temperature gauge with a new one.

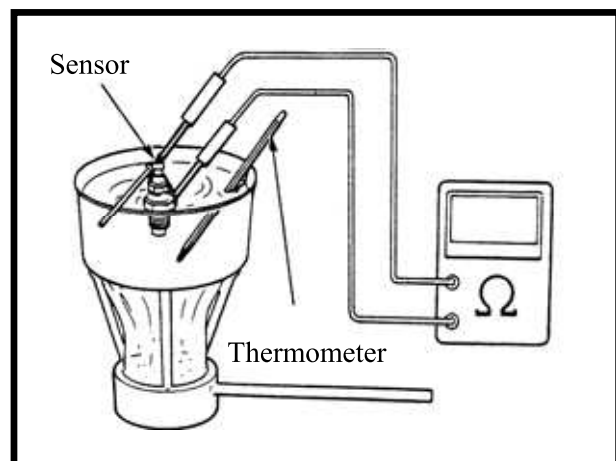

Temperature	Standard resistance
50°C	123.9 • 478.9 Ω
100°C	26 • 29.3 Ω

- Handle the water temperature sensor carefully as it is vulnerable to impact.
- Do not allow the water temperature sensor and the thermometer to come in contact with the bottom of the pan.

12. COOLING SYSTEM

INSTALLATION

With thread lock applied to the threaded part, tighten the water temperature sensor.

Torque: 0.8 kgf-m (8 N-m, 5.8 lbf-ft)

Connect the sensor connectors.

After the water temperature sensor has been installed, fill coolant and perform air bleeding (refer to the “**COOLANT REPLACEMENT**” section in this chapter).

12. COOLING SYSTEM

THERMOSTAT

THERMOSTAT REMOVAL

REMOVAL

Drain the coolant (refer to the “**COOLANT REPLACEMENT**” section in this chapter).

Remove the luggage box (refer to the “**FRAME COVERS REMOVAL/INSTALLATION**” section in the chapter 2).

Disconnect the water temperature sensor connectors (1).



(1)

Disconnect the water hose (2) from the thermostat housing.
 Disconnect the air bleed hose (3) from the thermostat housing.
 Remove the mounting bolt (4) and the thermostat housing from the cylinder head.

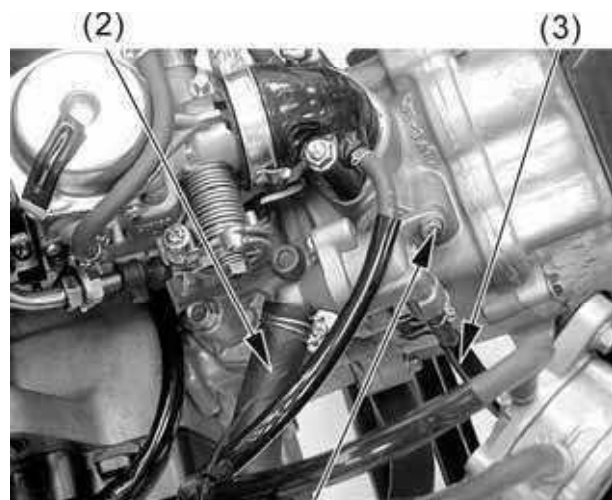

(4)

INSTALLATION

The installation sequence is the reverse of removal.

- Replace the O-ring with a new one and apply grease to it.

After the water thermostat has been installed, fill coolant and perform air bleeding (refer to the “**COOLANT REPLACEMENT**” section in this chapter).

12. COOLING SYSTEM

DISASSEMBLY

Remove the two bolts and separate the thermostat housing halves.

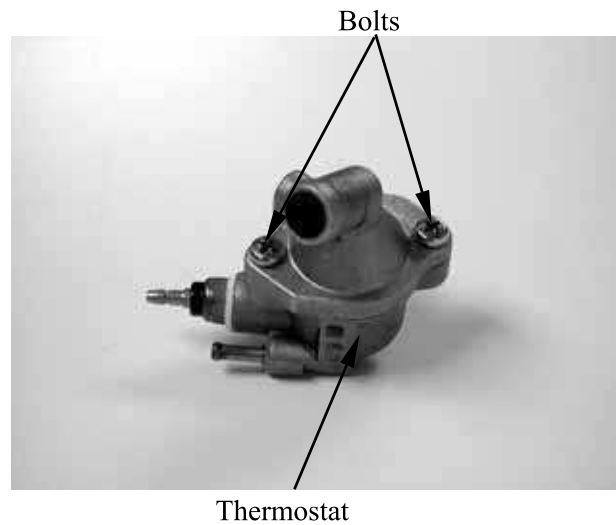

Remove the thermostat from the thermostat housing.



12. COOLING SYSTEM

INSPECTION

Suspend the thermostat in a pan of water over a burner and gradually raise the water temperature to check its operation.

Technical Data

Begins to open	80 - 82°C (176 - 180°F)
Full-open	90°C (198°F)
Valve lift	3.5 mm (0.14 in) minimum

- Do not let the thermostat touch the pan as it will give a false reading.
- Replace the thermostat if the valve stays open at room temperature.
- Test the thermostat after it is opened for about 5 minutes and holds the temperature at 70• :

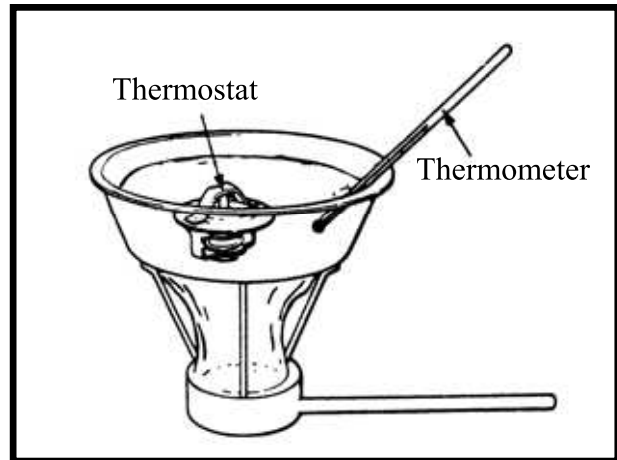

ASSEMBLY

Thermostat assembly is in the reverse order of disassembly.

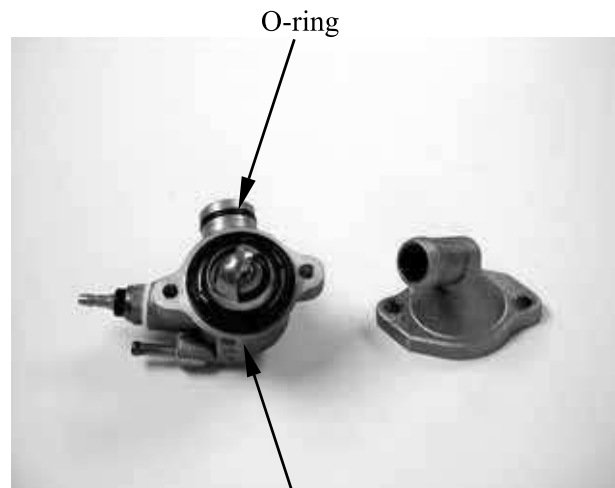

Thermostat Housing

**DINK 125:FUEL SYSTEM/CARBURETOR/
FUEL PUMP/FUEL TANK**

FUEL SYSTEM-----	13- 1
SCHEMATIC DRAWING -----	13- 2
SERVICE INFORMATION-----	13- 3
FUEL PUMP CONSTRUCTION-----	13- 4
TROUBLESHOOTING-----	13- 5
CARBURETOR-----	13- 6
AUTO CHOKE -----	13-17
CARBURETOR HEATER -----	13-20
FUEL PUMP -----	13-21
FUEL STRAINER-----	13-24
FUEL TANK -----	13-25
AIR CLEANER -----	13-27

FUEL SYSTEM

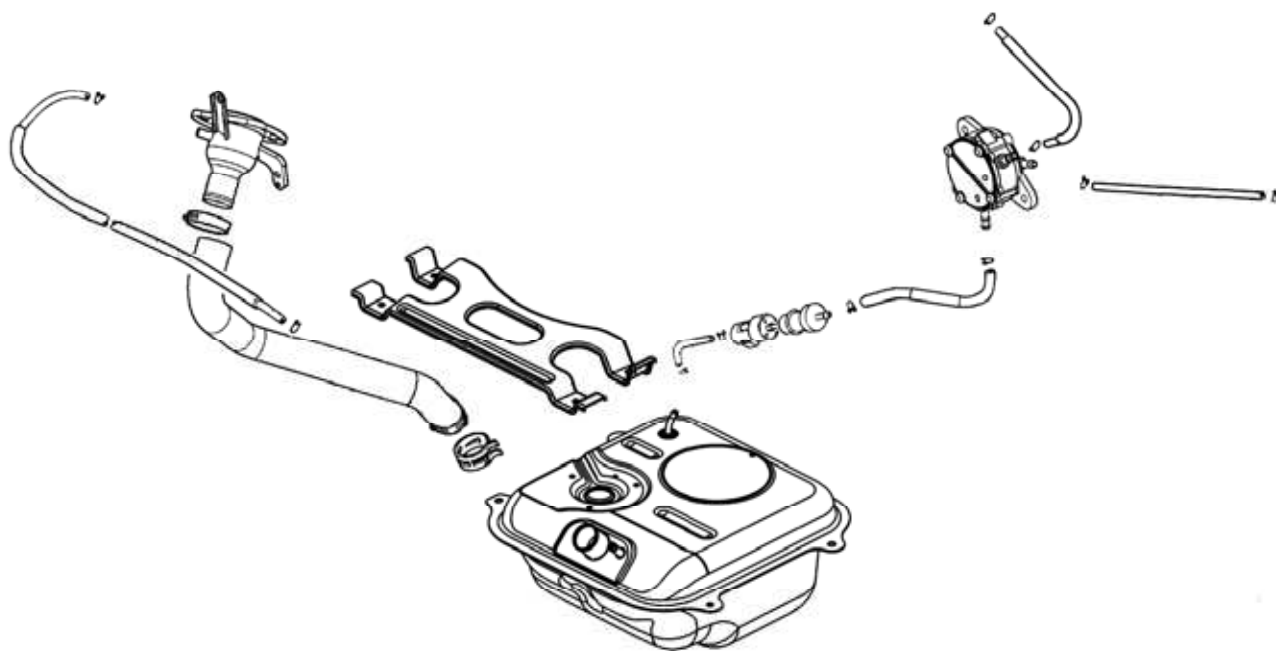

SCHEMATIC DRAWING

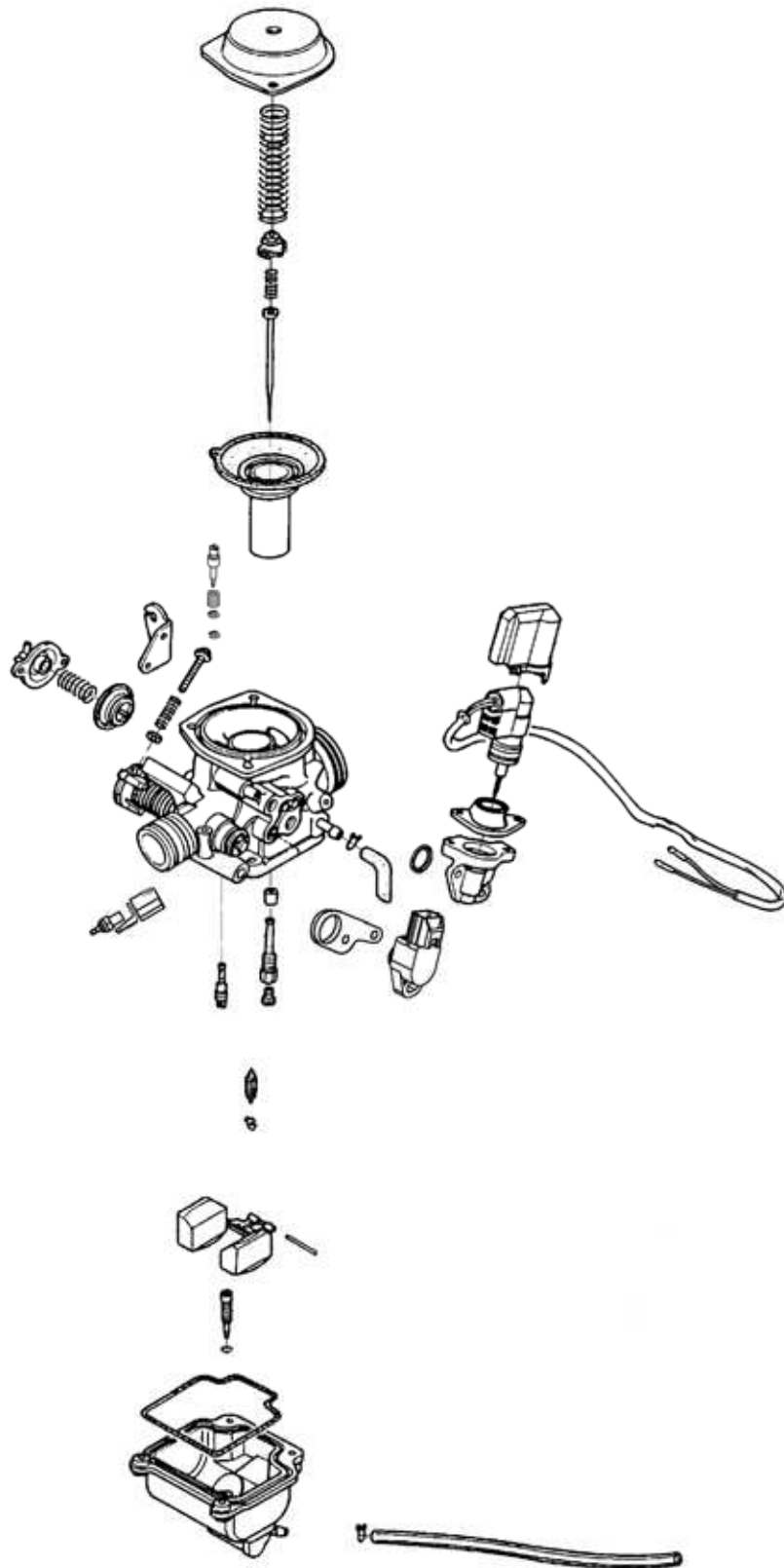

SERVICE INFORMATION GENERAL INSTRUCTIONS



Gasoline is very dangerous. When working with gasoline, keep sparks and flames away from the working area.

Gasoline is extremely flammable and is explosive under certain conditions. Be sure to work in a well-ventilated area.

- Do not bend or twist control cables. Damaged control cables will not operate smoothly.
- When disassembling fuel system parts, note the locations of O-rings. Replace them with new ones during reassembly.
- Before float chamber disassembly, loosen the drain screw to drain the residual gasoline into a clean container.
- After the carburetor is removed, plug the intake manifold side with a clean shop towel to prevent foreign matters from entering.
- When cleaning the carburetor air and fuel jets, the O-rings and diaphragm must be removed first to avoid damage. Then, clean with compressed air.
- When the machine is not used for over one month, drain the residual gasoline from the float chamber to avoid erratic idling and clogged slow jet due to deteriorated fuel.

SPECIFICATIONS

Item	Standard
Type	LEA5
Bore size	$\phi 24$ mm ($\phi 0.96$ in)
Float level	19 mm (0.76 in)
Main jet No.	KY 96
Slow jet No.	KY 35
Idle speed	1700 \pm 100 rpm
Throttle grip free play	2~6 mm (0.08~0.24 in)
Pilot screw opening	2 3/8 \pm 3/4

FUEL PUMP CONSTRUCTION

The fuel pump adopted for this model is a vacuum-type fuel pump which utilizes the positive and negative pulsating pressures produced by the engine crankcase to control the oil pump diaphragms and deliver fuel from the fuel tank to the carburetor through the suction valve and outlet valve.

FUEL PUMP CONSTRUCTION

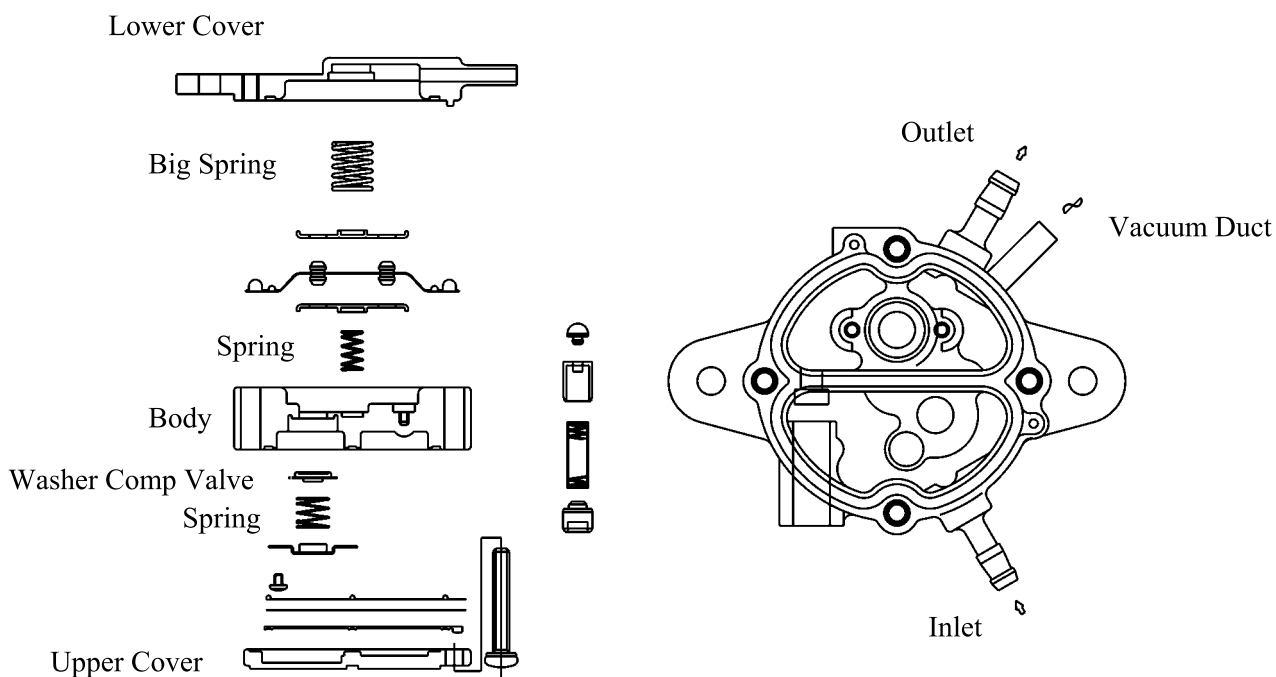

TROUBLESHOOTING

Engine does not start

- No fuel in tank
- Restricted fuel line
- Too much fuel getting to cylinder
- Clogged air cleaner
- Contaminated fuel
- Faulty fuel pump

Engine idles roughly, stalls or runs poorly

- Incorrect idle speed
- Rich mixture
- Lean mixture
- Clogged air cleaner
- Intake air leak
- Contaminated fuel
- Faulty air-cut off valve
- Damaged vacuum tube and connectors
- Damaged carburetor insulator

Throttle does not open fully, so engine stalls

- Damaged vacuum piston diaphragm
- Clogged diaphragm hole

Lean mixture

- Clogged fuel jets
- Clogged fuel tank cap breather hole
- Clogged fuel filter
- Bent, kinked or restricted fuel line
- Faulty float valve
- Float level too low
- Faulty fuel pump or insufficient output

Rich mixture

- Auto bystarter valve opens excessively
- Faulty float valve
- Float level too high
- Clogged air jets
- Auto bystarter valve set plate installed in the wrong groove
- Clogged air cleaner

Engine is hard to start

- No fuel in tank
- Restricted fuel line
- Clogged fuel strainer
- Faulty fuel pump
- Broken or clogged vacuum tube
- Faulty or clogged charcoal canister

Lean mixture

- Clogged charcoal canister
- Bent, kinked or restricted fuel line
- Clogged fuel strainer
- Float level too low

CARBURETOR

REMOVAL/INSTALLATION

Remove the luggage box and center cover (refer to the “**FRAME COVERS REMOVAL**” section in the chapter 2).

Disconnect the auto choke connector (1).

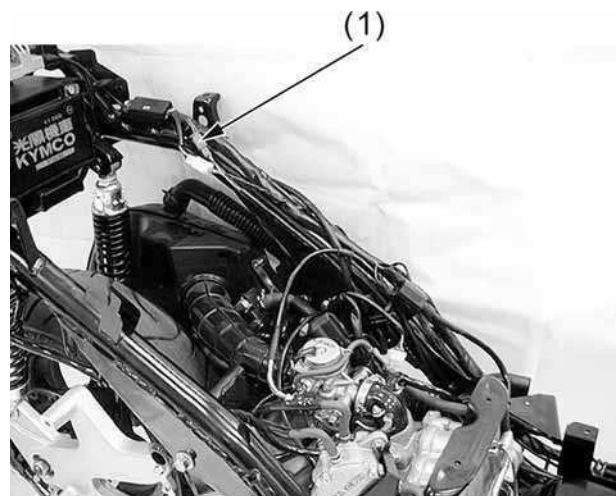

Disconnect the vacuum hose (2).
Disconnect the TPS connector (3).
Disconnect the carburetor heater connector (4).

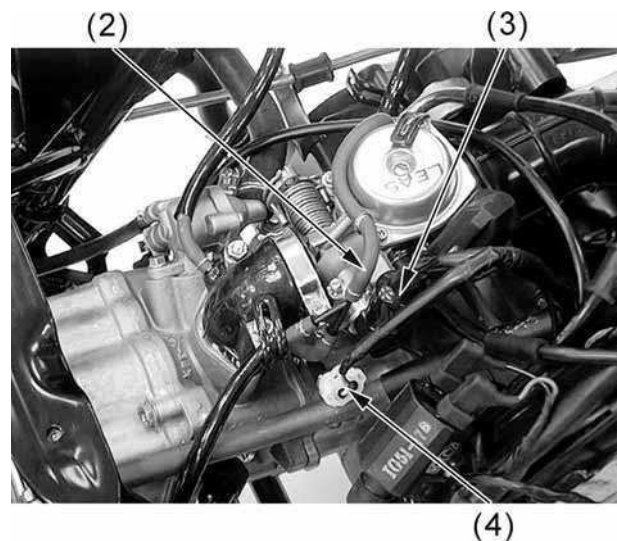

Loosen the lock nut (5) and remove the adjust nut (6), then disconnect the throttle cable (7).

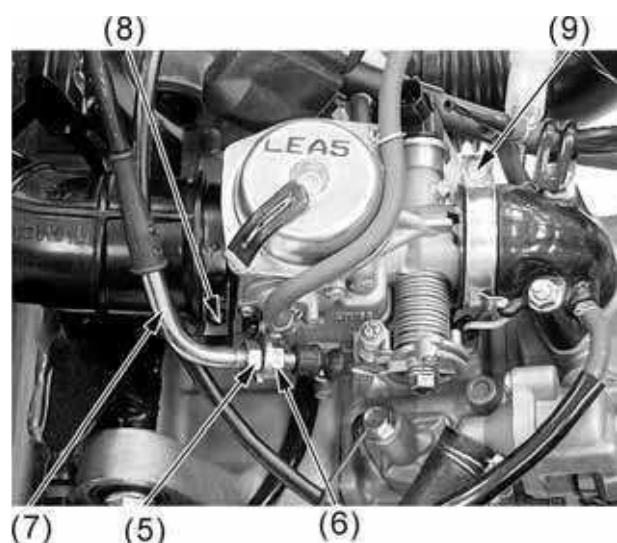

Loosen the air cleaner clamp screw (8).
Loosen the carburetor clamp screw (9).

13. DINK 125: FUEL SYSTEM/CARBURETOR/ FUEL PUMP/ FUEL TANK



DINK 2000i/125

Remove the carburetor.

Disconnect the fuel hose from the carburetor.

Installation is in the reverse order of removal.

* Adjust the throttle grip free play (refer to the **“THROTTLE OPERATION”** section in the chapter 3) after the carburetor has reinstalled.

(10)



DISASSEMBLY

Loosen the drain screw to drain the gasoline from the float chamber.

- * • Keep sparks and flames away from the work area.
- Drain gasoline into a clean container.
- Do not loosen or tighten the painted bolts and screws of the carburetor. Loosening or tightening them can cause throttle and piston valve synchronization failure.



Bend the guide straight, then remove the auto choke wire.



Guide

Remove the two screws and top cap.



Top Cap

13. DINK 125: FUEL SYSTEM/CARBURETOR/ FUEL PUMP/ FUEL TANK



DINK 2000i/125

Remove the spring and piston valve.

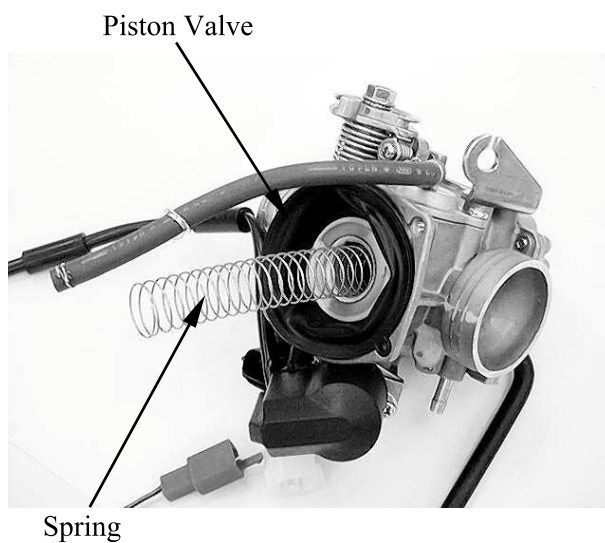

Remove the spring retainer, jet needle.

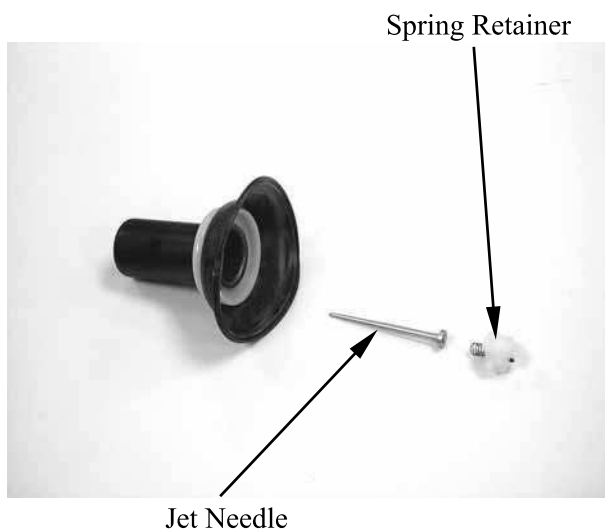

Remove the four screws and float chamber.

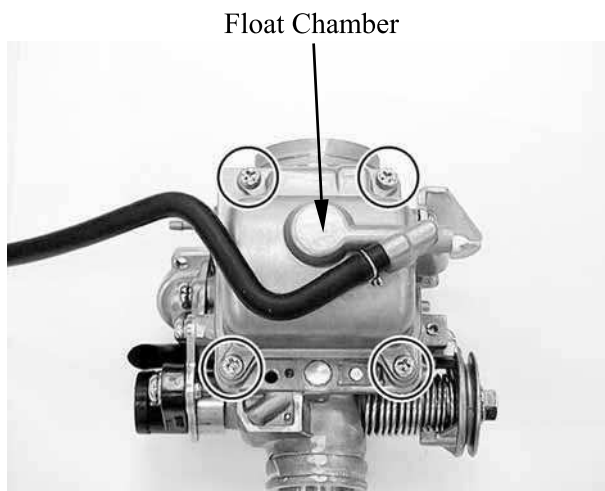

13. DINK 125:FUEL SYSTEM/CARBURETOR/ FUEL PUMP/ FUEL TANK

Pull float pin out, then remove the float and float valve.

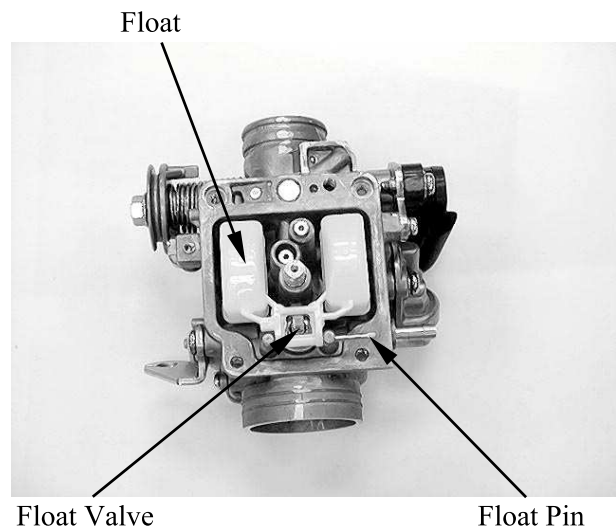

Remove the slow jet.
Remove main jet.

Remove the needle jet holder and needle jet.

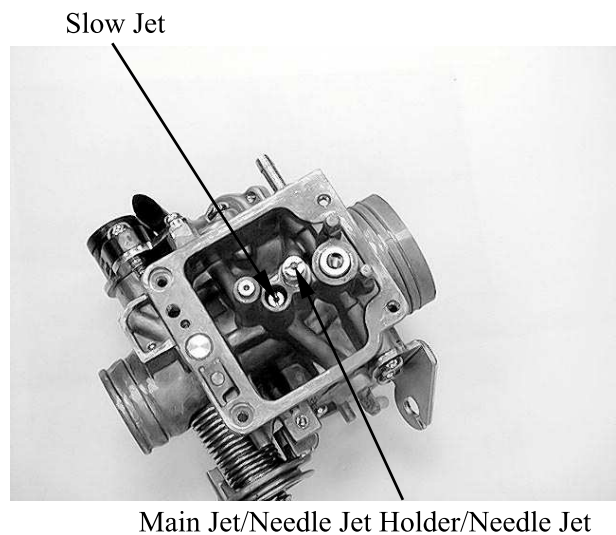

Remove the pilot screw, spring, washer and O-ring.

* Before pilot screw removal, slowly turn the pilot screw clockwise and count the number of turns until the screw is lightly seated. Make a note of how many turns were made so the screw can be reset correctly.

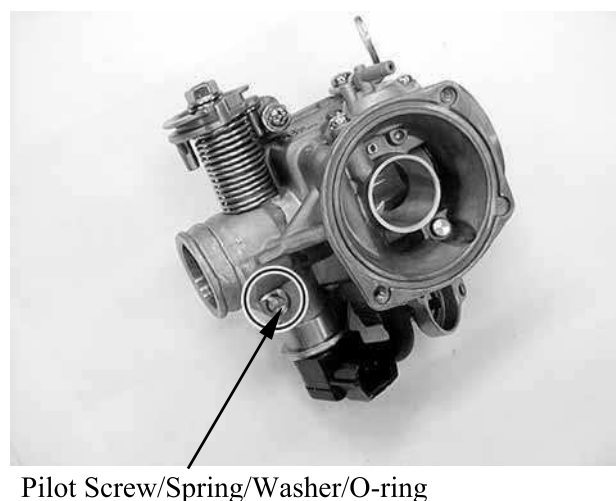

13. DINK 125: FUEL SYSTEM/CARBURETOR/ FUEL PUMP/ FUEL TANK

Remove the two screws and casting enrichment valve cover and then take out the spring.

Remove the casting enrichment valve.

Casting Enrichment Valve Cover

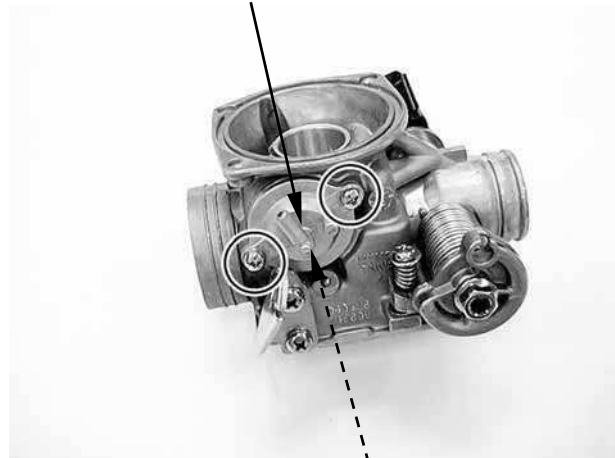

Spring/Casting Enrichment Valve

Remove the two screws and auto choke seat.



Auto Choke Seat

Then remove the O-ring.

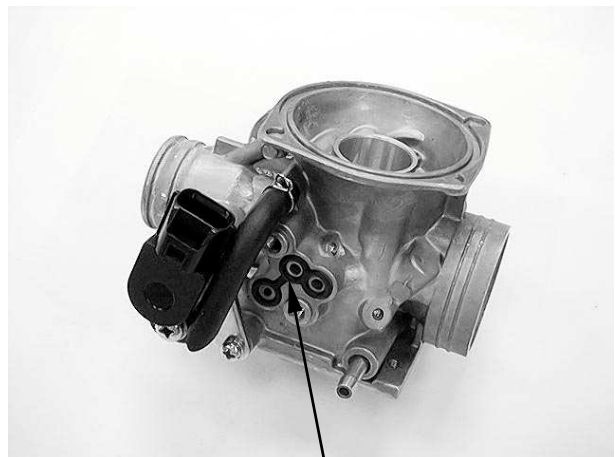

O-ring

INSPECTION

Carburetor body/jets cleaning

Check carburetor body and each jet for wear or damage.

Clean all jets with a spray-type carburetor cleaner and dry them using compressed air.

Clean all circuits of the carburetor thoroughly-not just the perceived problem area.

Clean the circuits in the carburetor body with a spray-type cleaner and allow each circuit to soak, if necessary, to loosen dirt and varnish. Blow the body dry using compressed air.

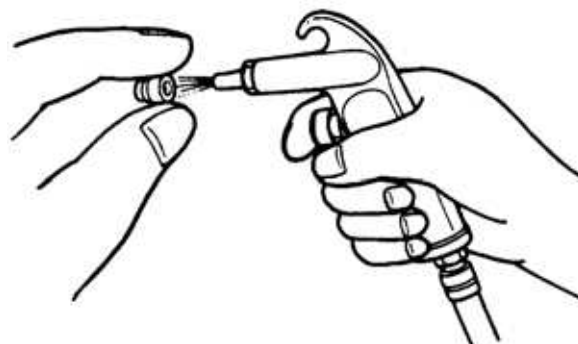
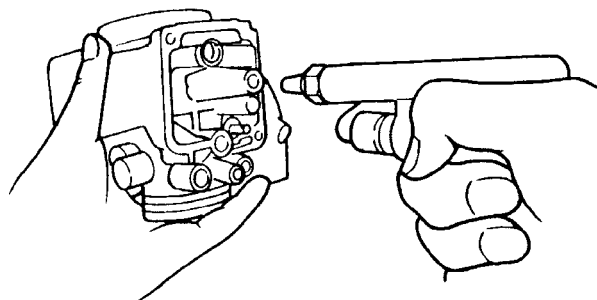

- *
- Some carburetor cleaning chemicals , especially dip type soaking solutions, are very corrosive and must be handled carefully. Always follow the chemical manufacturer's instructions on proper use, handling and storage.
 - Do not use a wire to clean the jets or passageways. A wire can damage the jets and passageways. If the components cannot be cleaned with a spray cleaner it may be necessary to use a dip-type cleaning solution and allow them to soak. Always follow the chemical manufacturer's instructions for proper use and cleaning of the carburetor components.

After cleaning, reassemble the carburetor with new seals.

13. DINK 125: FUEL SYSTEM/CARBURETOR/ FUEL PUMP/ FUEL TANK

Check the float and float tang for deformation or damage.

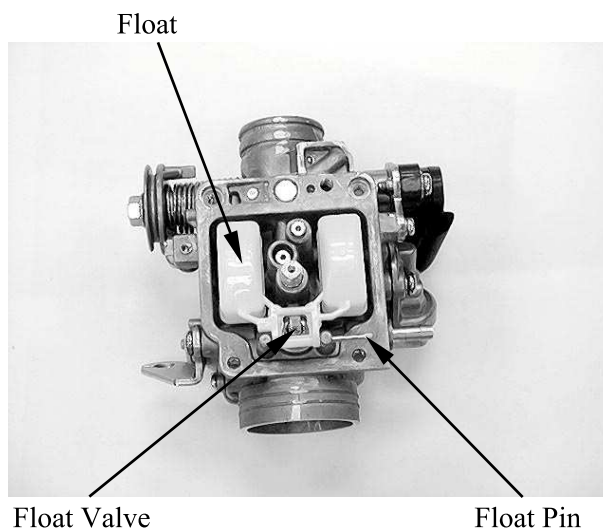

Check the float valve and valve seat for foreign substance, clogging or damage.

Check the tip of the float valve, where it contacts the valve seat, for stepped wear or contamination.

Check the operation of the float valve.

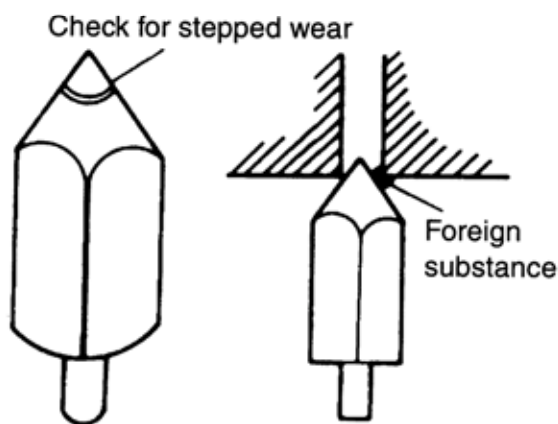

Check the piston valve for scratches, wear and damage.

Check the rubber diaphragm for tears.

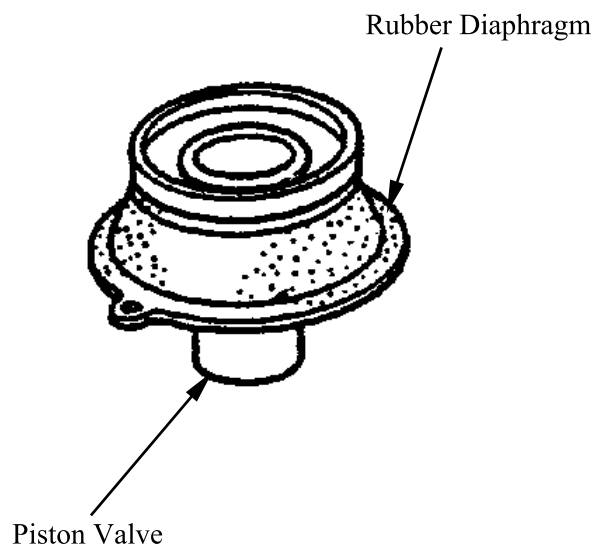

13. DINK 125:FUEL SYSTEM/CARBURETOR/ FUEL PUMP/ FUEL TANK

Check top cap and spring for cracks and damage.

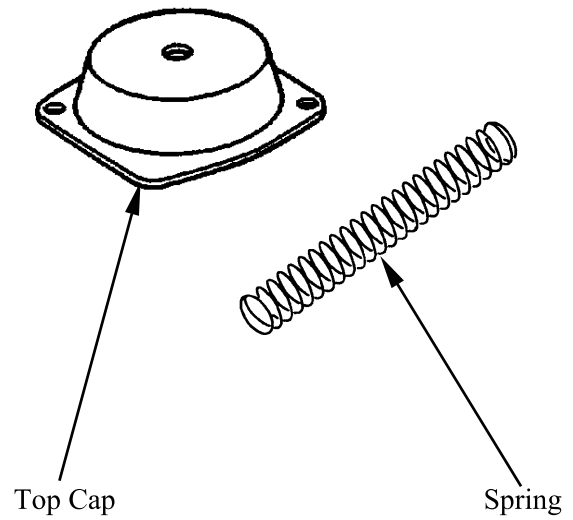

Check the diaphragm (1) of the coasting enrichment valve for tears.

Check the spring (2) and cover (3) of the coasting enrichment for damage.

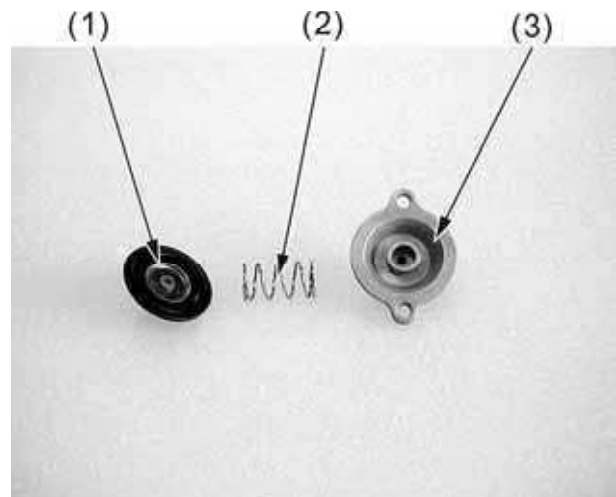

Check jet needle, needle jet, slow jet, needle jet holder, main jet and pilot screw for bends, wear and damage.

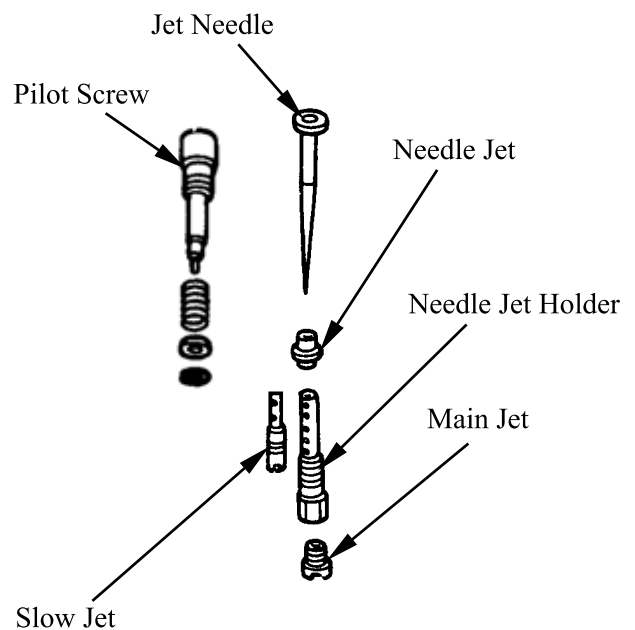

Insert the piston valve into the carburetor body, and check for free movement. If stick is found, replace the part with a new one.



Check throttle valve for free movement.
If stick is found, replace the part with a new carburetor.

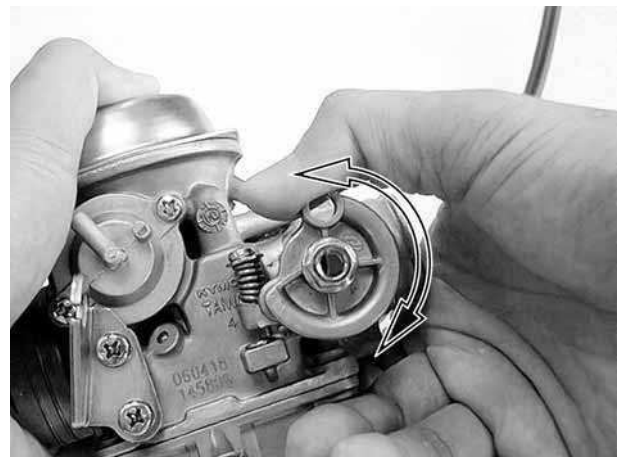

Check the float level after checking the float valve, valve seat and float.

Set the carburetor so that the float valve end just contacts the float arm lip. Make sure the float valve tip is securely in contact with the valve seat.
Measure the float level with the float level gauge.

Float level (A): 19 mm (0.76 in)

Bend the tongue as necessary to bring the float height (A) to the specified level.

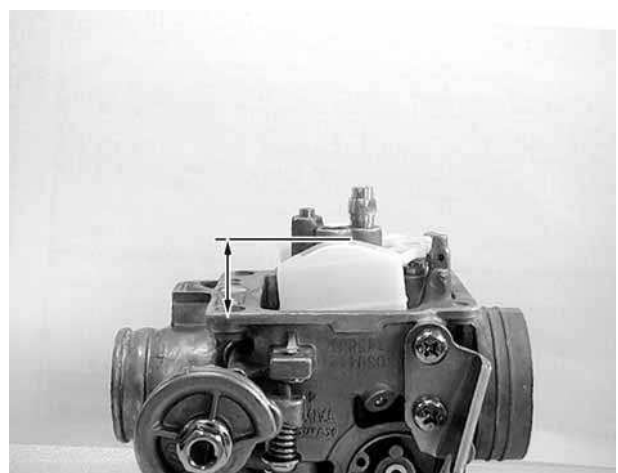

ASSEMBLY

Carburetor reassembly can be performed in the reverse order of disassembly. When reassembling, carefully observe the following instructions.

- *
 - Assemble the parts taking consideration of their function.
 - Before assembling, wash all of the parts in a clean petroleum based solvent.
 - Replace O-rings and seals with new ones.
 - After cleaning, reinstall the pilot screw to the original setting by turn the screw in until it lightly seats, and then backing it out the same number of turns counted during disassembly.

- (1) Spring
- (2) Retainer
- (3) Jet needle
- (4) Piston valve
- (5) Auto choke
- (6) Auto choke seat/O-ring
- (7) Needle jet
- (8) Needle jet holder
- (9) Float valve
- (10) Float pin
- (11) Float chamber
- (12) Float chamber O-ring
- (13) Float
- (14) Main jet
- (15) Heater
- (16) Slow jet
- (17) Casting enrichment valve
- (18) Cover
- (19) Spring
- (20) Pilot screw

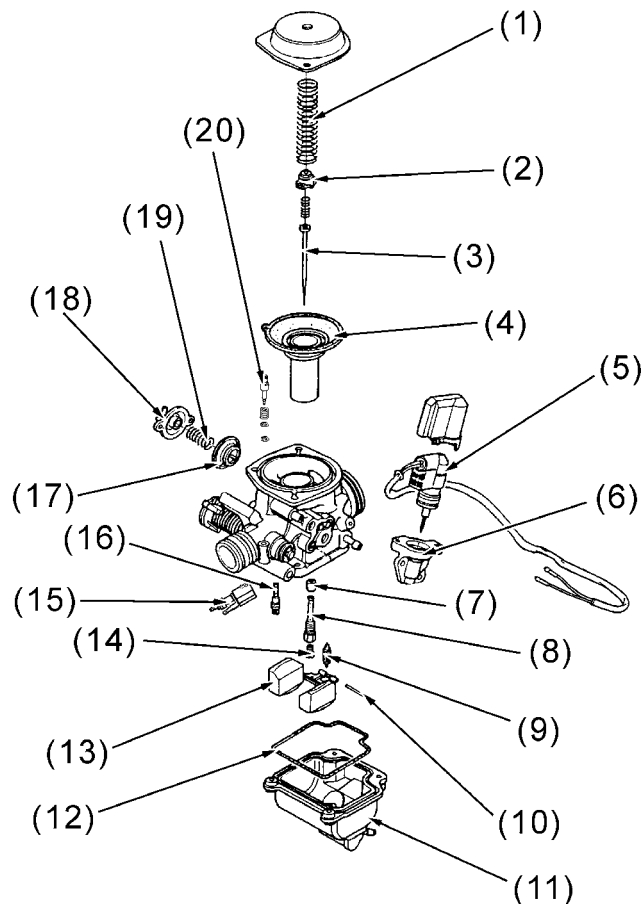

AUTO CHOKE

REMOVAL

Remove the cap.



Remove the two screws, then remove the auto choke and set plate.



Auto Choke/Set Plate

INSPECTION

Check the auto choke valve and needle for nicks, wear or damage.
If any faulty part is found, replace the auto choke with a new one.



Choke Needle

Choke Valve

Measure the resistance between the auto choke wire terminals.

Resistance:

10 Ω below (10 minutes minimum after stopping the engine)

If the reading is not within the limit, replace the auto auto choke with a new one.



Connect a hose to the fuel enriching circuit of the carburetor. Connect the auto choke yellow wire to the positive (+) terminal of a battery and green/black wire to the negative (-) terminal. Wait 5 minutes and blow the hose with mouth. If the passage is blocked, the auto choke is normal.

Disconnect the auto choke from the battery. Wait 30 minutes and blow the hose with mouth. If air can be blown into the hose, the auto choke is normal.

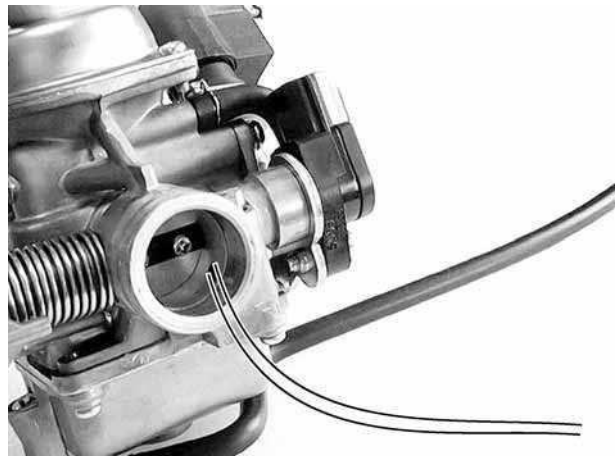

INSTALLATION

Install the auto choke and set plate.
Install and tighten the two screws.



Auto Choke/Set Plate

13. DINK 125: FUEL SYSTEM/CARBURETOR/ FUEL PUMP/ FUEL TANK

Install the cap.



CARBURETOR HEATER

INSPECTION/REPLACEMENT

Check the heater with battery.

If the heater is getting hot, means the heater without problem, otherwise the heater has to be changed.

Remove the carburetor (refer to the “**CARBURETOR**” section in this chapter).

Remove the screw.

Disconnect the connectors from the heater.

It is in reverse order of removal to install the new heater.

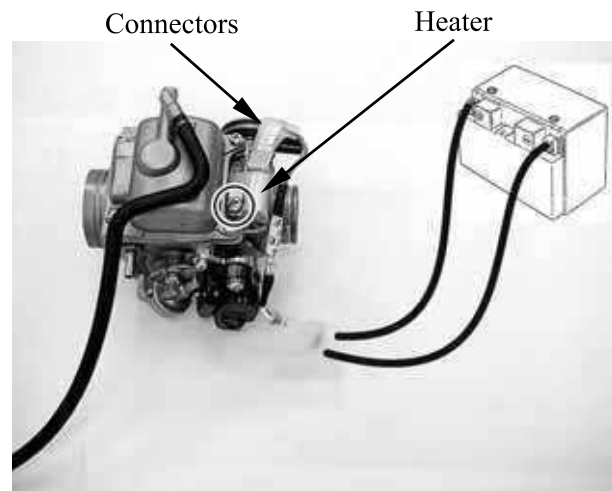

FUEL PUMP

REMOVAL/INSTALLATION

* When removing the fuel pump, do not allow flames or sparks near the working area and drain the residual gasoline into a container.

Remove the body cover (refer to the “**FRAME COVERS REMOVAL/INSTALLATION**” section in the chapter 2).

Disconnect the fuel pump inlet hose (2), outlet hose (1) and vacuum hose (3). Remove the two nuts and the fuel pump.

Installation is in the reverse order of removal.

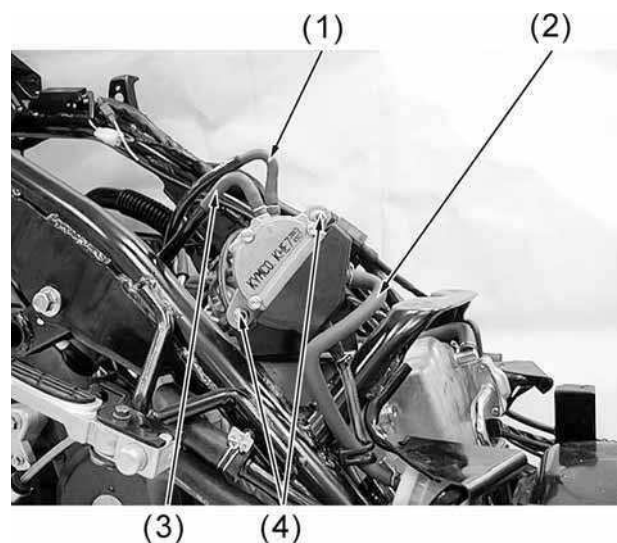

TESTING

Measure the fuel pump output. Start the engine and disconnect the fuel outlet tube and place a clean container under the tube to check the fuel output.

Output: 80cc/1800rpm/25 seconds .

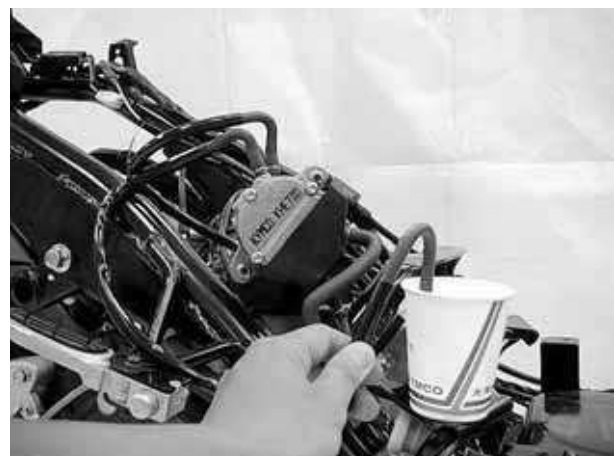

DISASSEMBLY

Remove the four fuel pump body screws.

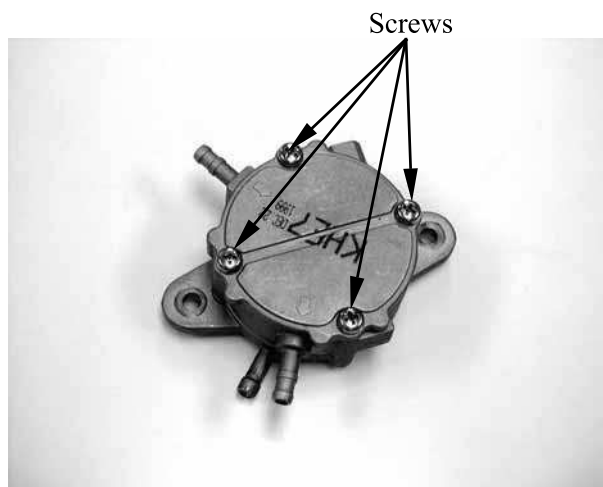

Disassemble the fuel pump.



INSPECTION

Inspect the fuel pump diaphragms A and B for damage.

Inspect each gasket for damage.

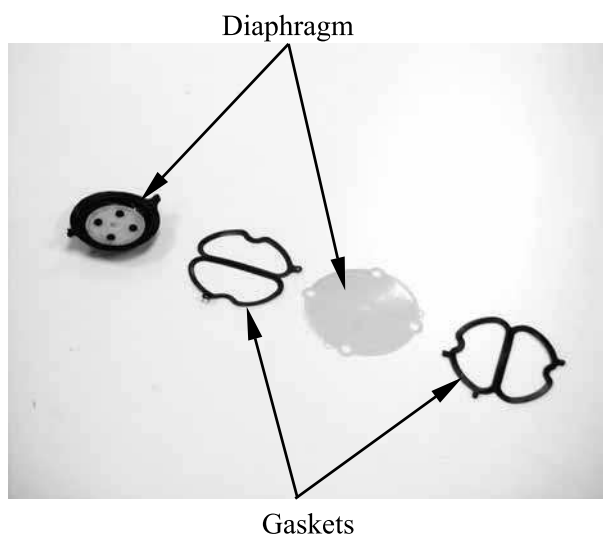

13. DINK 125: FUEL SYSTEM/CARBURETOR/ FUEL PUMP/ FUEL TANK



DINK 2000i/125

Inspect the suction valve, outlet valve and relief valve in the fuel pump body for damage, cracks or foreign matters.

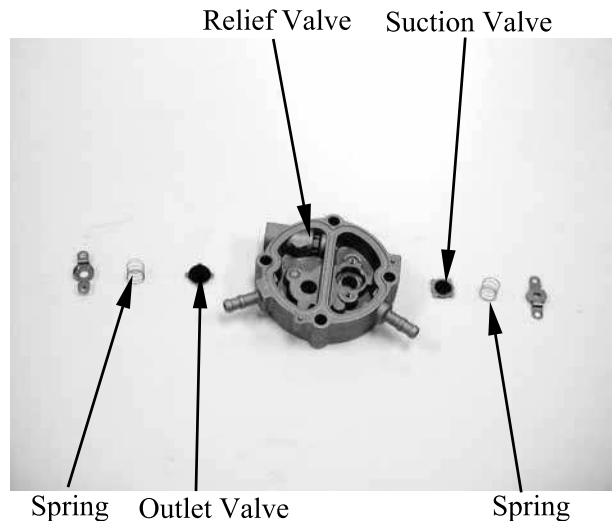

ASSEMBLY

Assemble the fuel pump in the reverse order of disassembly.

- * • During assembly, be sure to install the gaskets and diaphragms properly to avoid damage.
• Do not allow any foreign matter to enter the fuel pump during assembly.

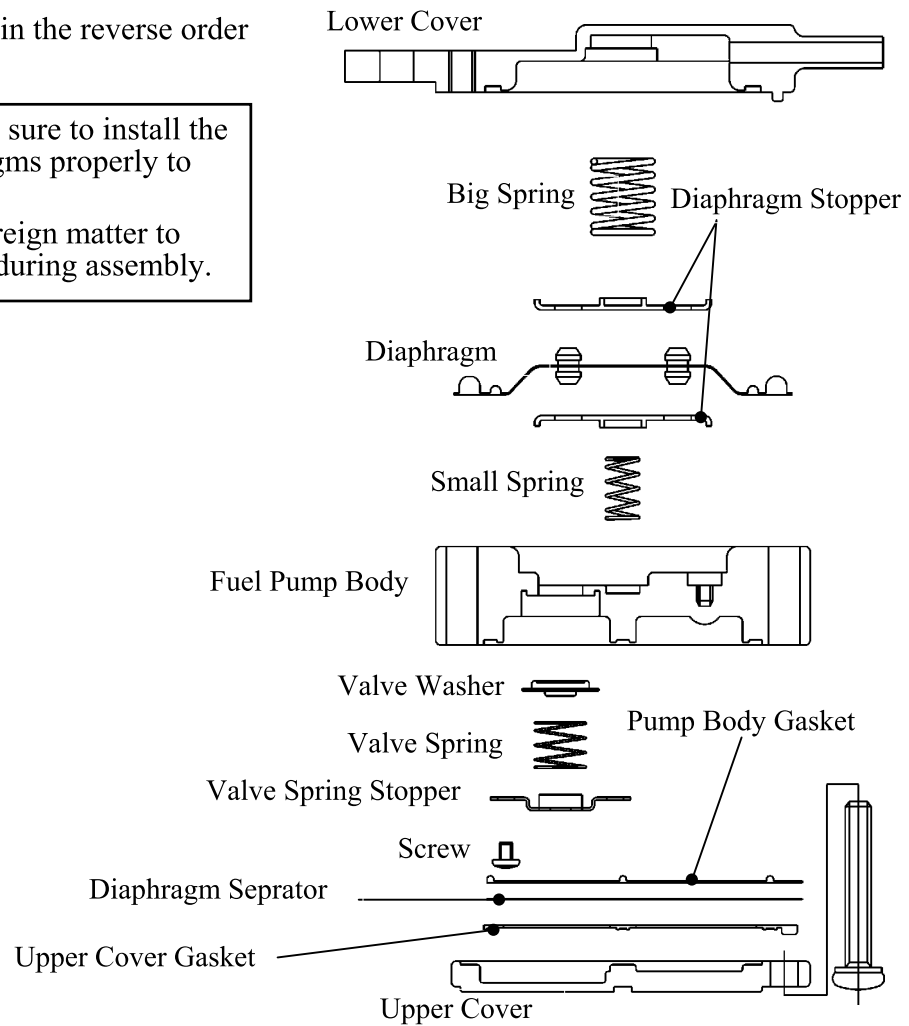

FUEL STRAINER

REMOVAL/INSTALLATION

* When removing the fuel strainer, do not allow flames or sparks near the working area and drain the residual gasoline into a container.

Remove the center cover (refer to the “**FRAME COVERS REMOVAL/INSTALLATION**” section in the chapter 2).

Disconnect the fuel hoses (1) and remove the fuel strainer (2).

Install the fuel strainer with its arrow mark toward the fuel pump.

INSPECTION

Inspect if the fuel strainer is clogged and clean it with compressed air.

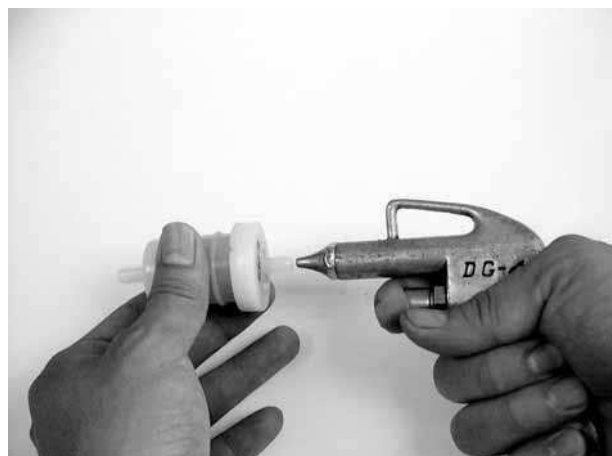
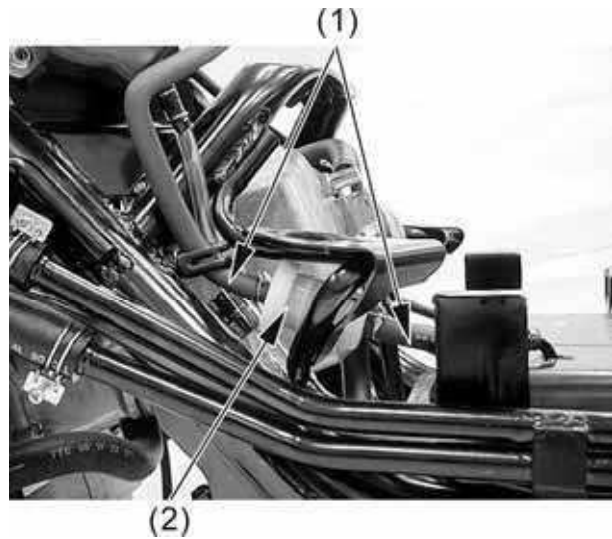

FUEL TANK

REMOVAL/INSTALLATION

* When removing the fuel tank, do not allow flames or sparks near the working area and drain the residual gasoline into a container.

Remove the inner cover (refer to the “**FRAME COVERS REMOVAL/INSTALLATION**” section in the chapter 2).

Disconnect the fill cap ground wire connector (1).

Disconnect the fill cap lock cable (2).

Disconnect the fuel hose (3).

Disconnect the fuel unit connector (4).

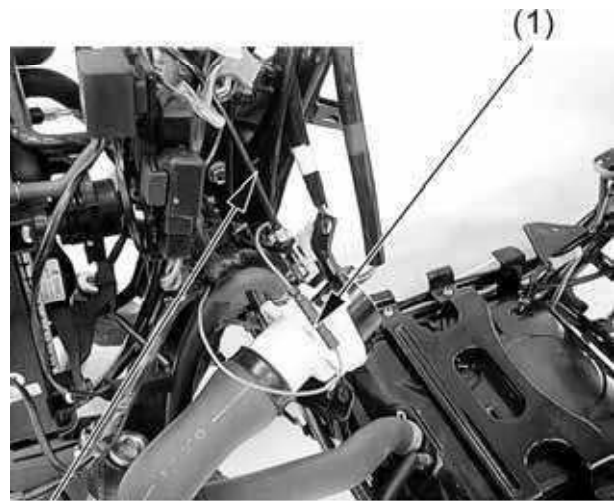

(2)

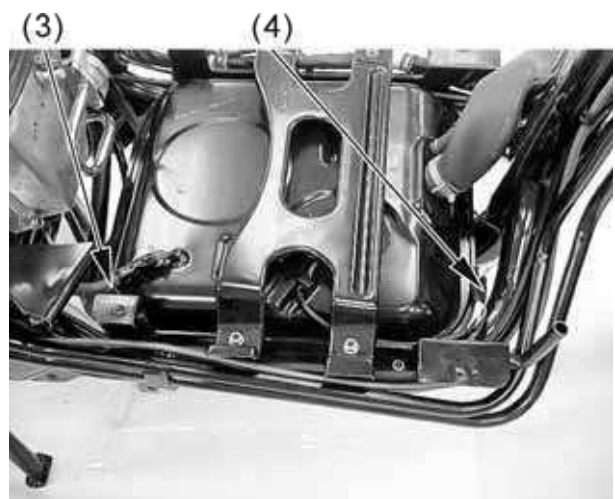

(3)

(4)

Remove the four nuts (5) and remove the bridge plate (6).

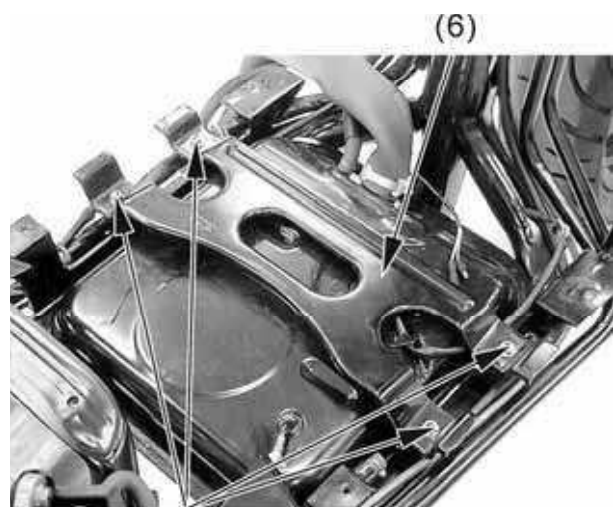

(6)

(5)

13. DINK 125:FUEL SYSTEM/CARBURETOR/ FUEL PUMP/ FUEL TANK

Remove the two nuts (7) from right fuel tank plate and remove a bolt (8) from radiator pipe.

Remove the right fuel tank plate (9).

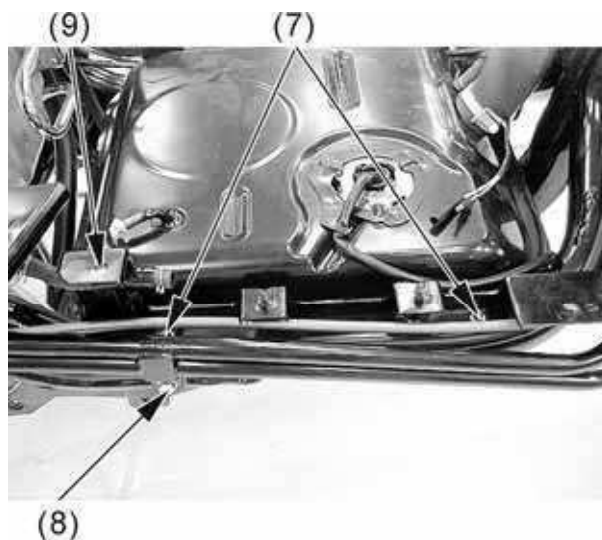

Remove the two nuts (10) and then remove the left fuel tank plate (11).

Remove the fuel tank.

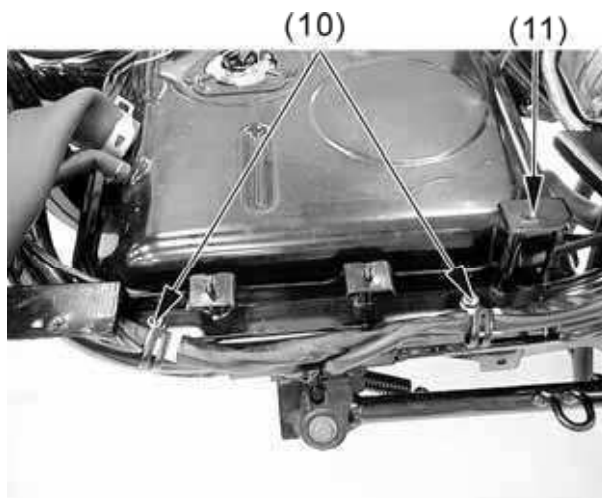

Installation is in the reverse order of removal.

AIR CLEANER

REMOVAL/INSTALLATION

Remove the body cover (refer to the “**FRAME COVERS REMOVAL/INSTALLATION**” section in the chapter 2).

Loosen the air cleaner clamp screw (1).
Disconnect the crankcase breather hose (2) from the air cleaner.

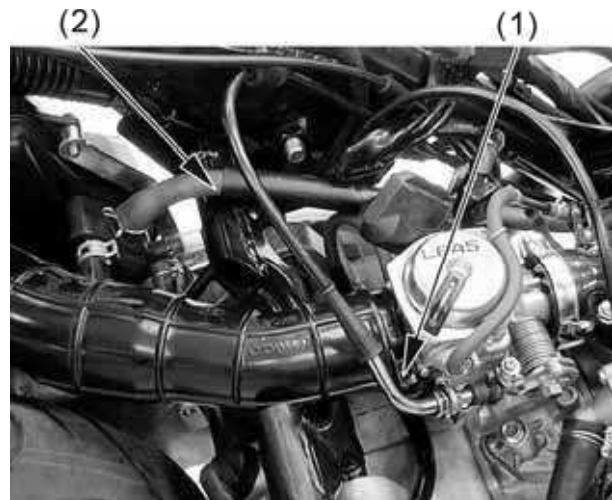

Disconnect the transmission gear case breather hose (3) from air cleaner.

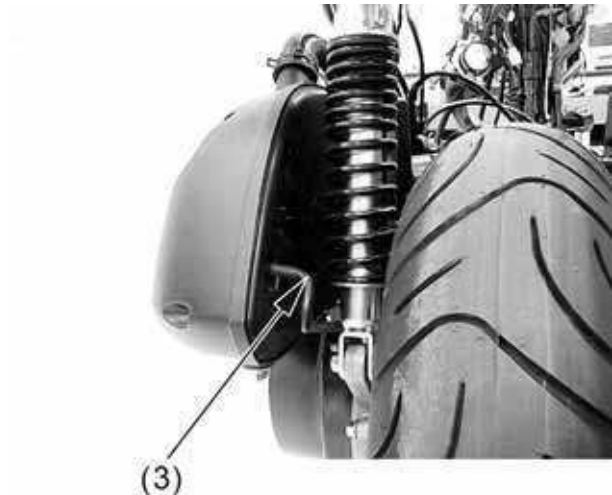

Remove the three mounting bolts (4) and then remove the air cleaner.

Installation is in the reverse order of removal.

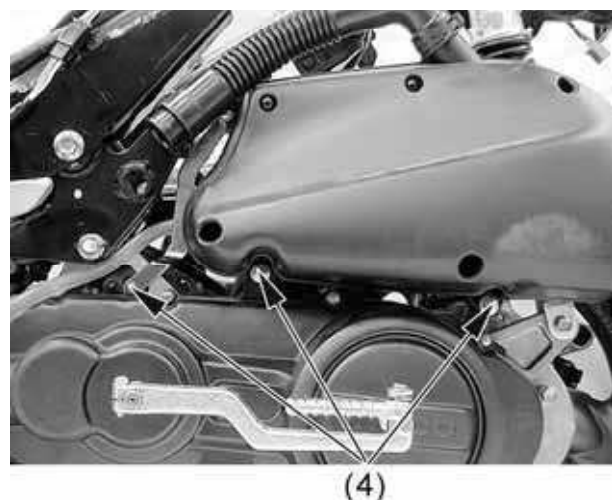

14. DINK 200 i: FUEL SYSTEM (Auto Control Fuel Injection System)

DINK 200 i: FUEL SYSTEM (Auto Control Fuel Injection System)

SYSTEM DIAGRAM	14-1
SYSTEM LOCATION.....	14-2
SERVICE INFORMATION	14-6
TROUBLESHOOTING.....	14-5
CHECK ENGINE LAMP (CELP)	14-7
SELF-DIAGNOSIS PROCEDURES WITHOUT	
DIGNOSTIC TOOL	14-8
CELP FAILURE CODES CHART	14-11
SELF-DIAGNOSIS PROCEDURES USING	
DIAGNOSTIC TOOL (PDA).....	14-17
RICIVE SIGNAL MENU (USING DIAGNOSTIC TOOL)	14-20
MAINTENANCE MENU (USING DIAGNOSTIC TOOL)	14-24
THROTTLE POSITION SENSOR INITIAL PROCEDURE.....	14-26
RESET THE AIR BY PASS VALVE.....	14-27
ADAPT AIR FLOW PER CYCLE (APC).....	14-28
APC ADAPTION PROCEDURE	14-29
SPARK PLUG ANTI-FLOOD.....	14-30
ENGINE CONTROL UNIT (ECU).....	14-31
TEMPERATURE/MANIFOLD ABSOLUTE	
PRESSURE SENSOR (T-MAP)	14-33
THROTTLE BODY/THROTTLE POSITION SENSOR	
(TPS)/IDLE AIR BY PASS VALVE (ABV)	14-35
WATER TEMPERATURE SENSOR (WTS)	14-41
FUEL INJECTOR.....	14-42
FUEL TANK.....	14-45
FUEL PUMP.....	14-46
FUEL PUMP RELAY	14-50
O2/O2 HT SENSOR.....	14-51
ANGLE DETECT SENSOR	14-53
AIR CLEANER.....	14-54

14. DINK 200i: FUEL SYSTEM (Auto Control Fuel Injection System)

SYSTEM DIAGRAM

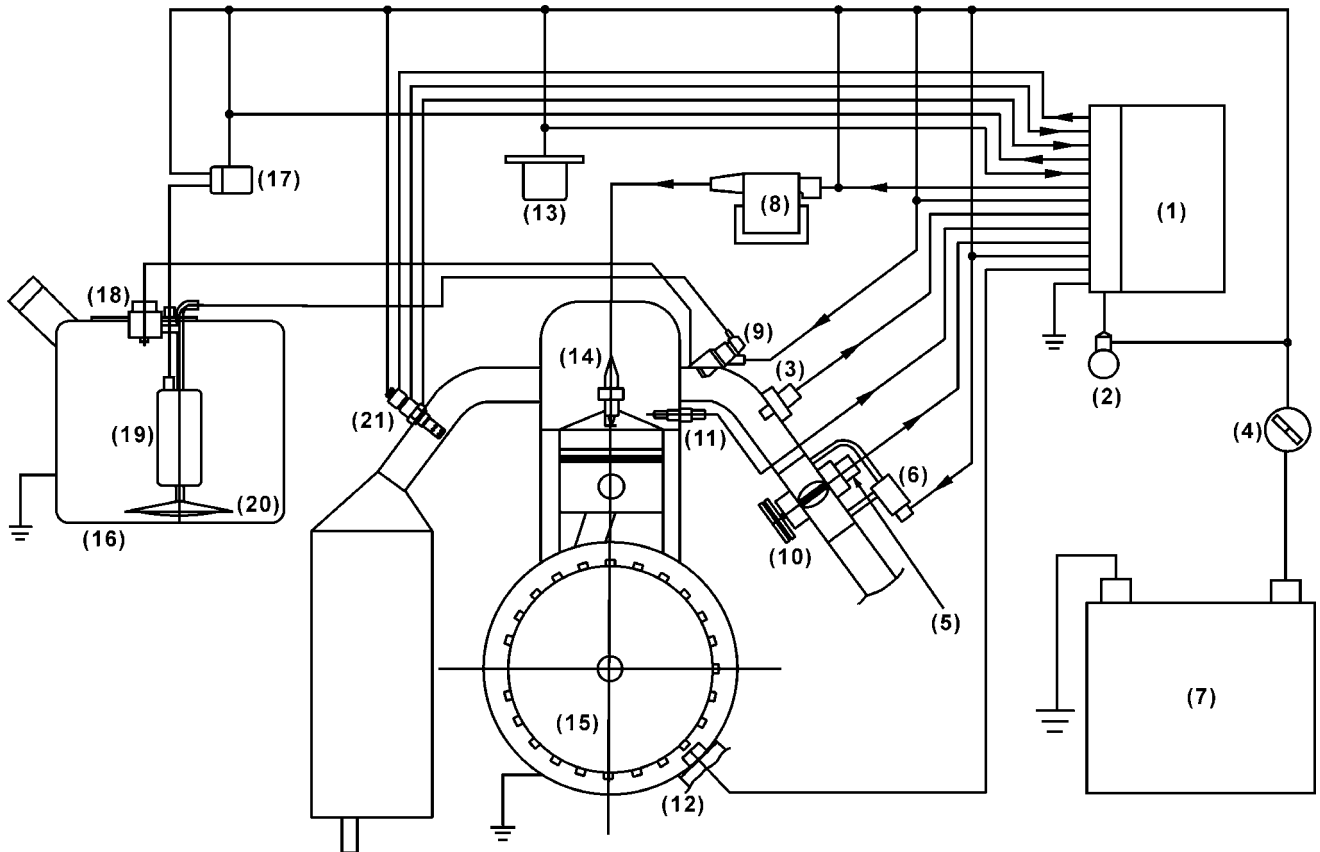

- | | |
|---|--|
| (1) Engine Control Unit (ECU) | (11) Engine temperature Sensor (WTS) |
| (2) Check Engine Lamp (CELP) | (12) Crankshaft position Sensor (Pulser) |
| (3) Temperature/Manifold Absolute Pressure Sensor (T-MAP) | (13) Angle Detect Sensor |
| (4) Ignition Switch | (14) Spark Plug |
| (5) Throttle Position Sensor (TPS) | (15) Flywheel |
| (6) Idle Air By Pass Valve (ABV) | (16) Fuel Tank |
| (7) Battery | (17) Fuel Pump Relay |
| (8) Ignition Coil | (18) Fuel Pressure Regulator |
| (9) Fuel Injector | (19) Fuel Pump |
| (10) Throttle Body | (20) Fuel Strainer |
| | (21) O2 Heater/O2 Sensor |

14. DINK 200 i: FUEL SYSTEM (Auto Control Fuel Injection System)

SYSTEM LOCATION

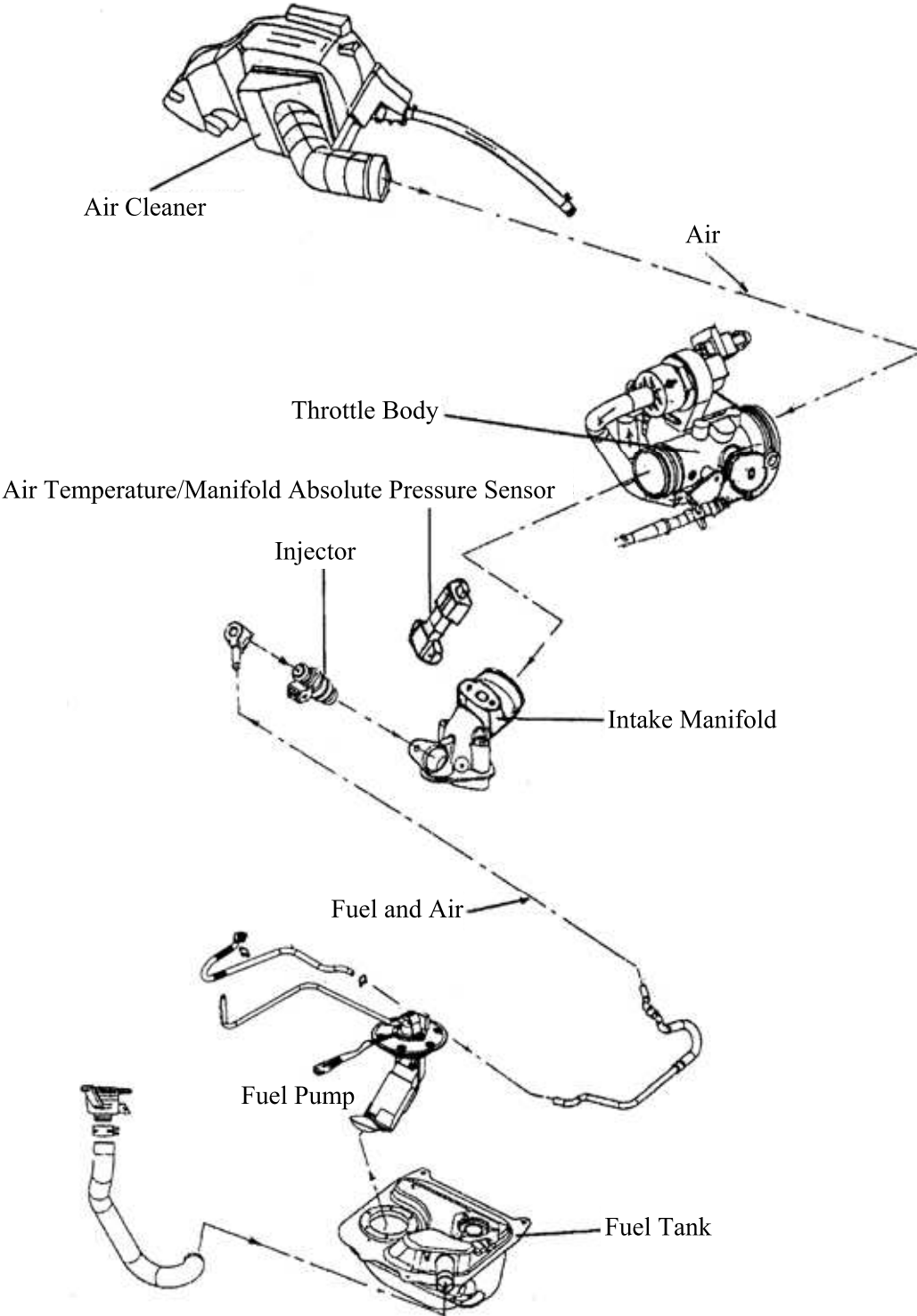

14. DINK 200i: FUEL SYSTEM (Auto Control Fuel Injection System)

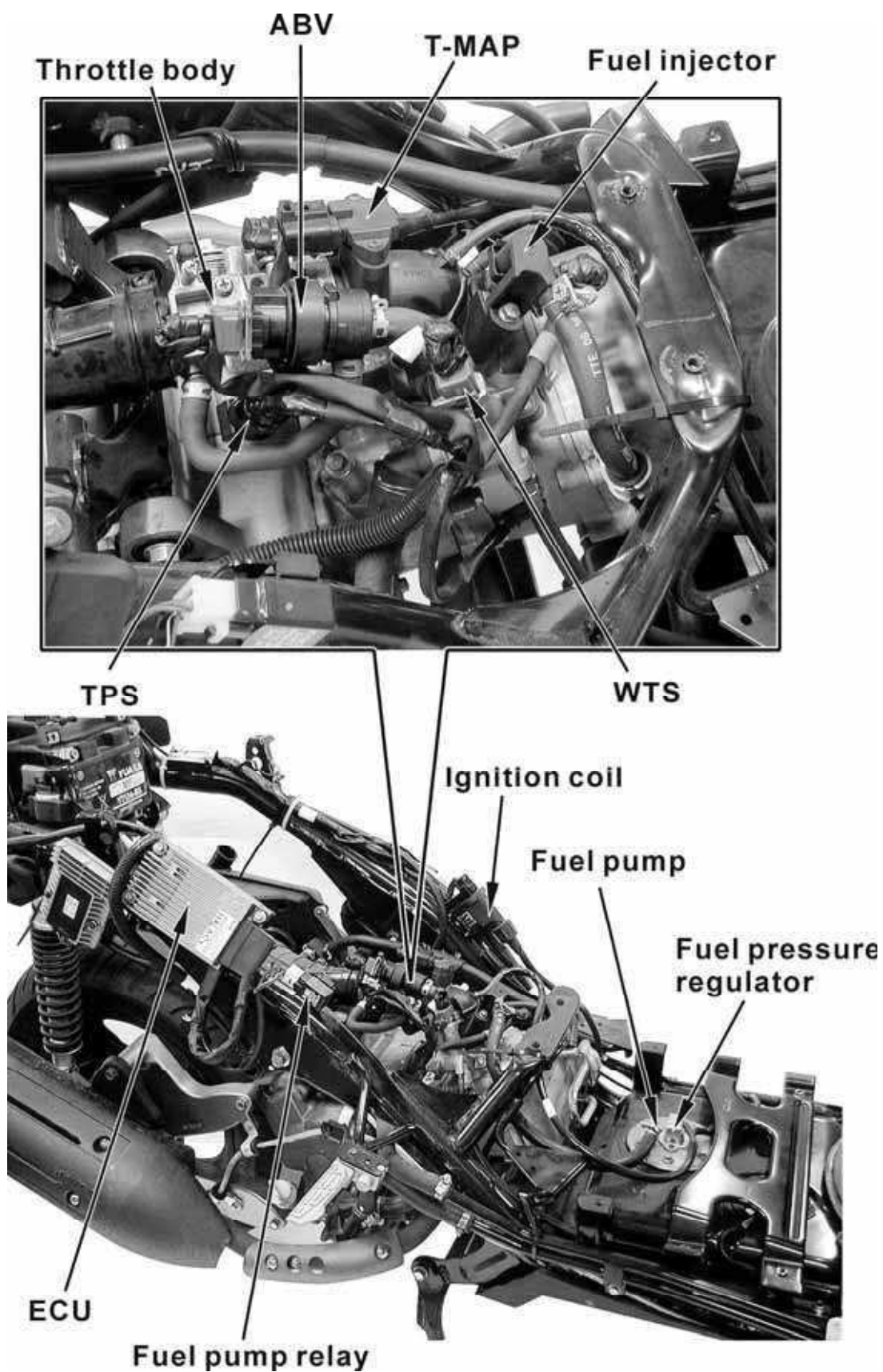

14. DINK 200 i: FUEL SYSTEM (Auto Control Fuel Injection System)

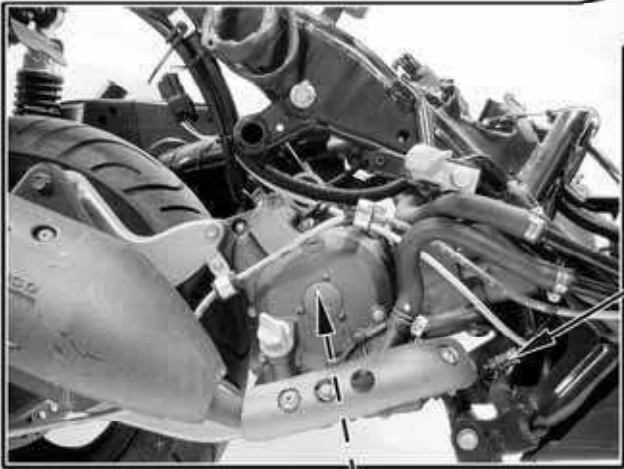
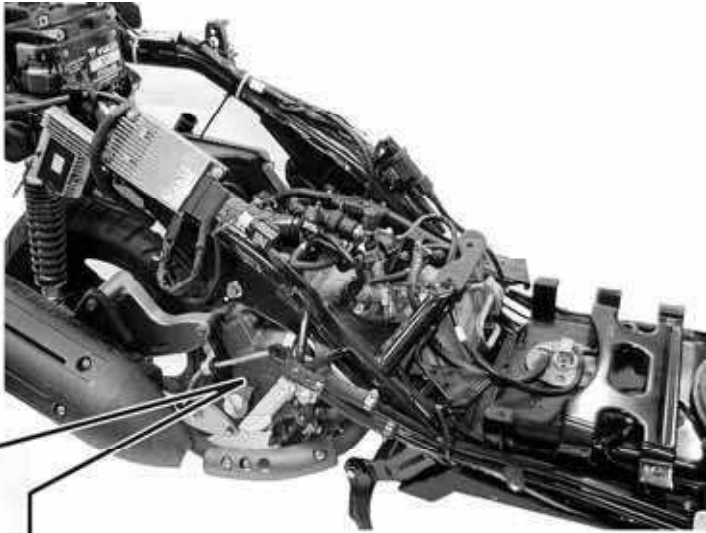

O2 HT/O2 sensor

Pulser/Flywheel



Angle detect sensor



14. DINK 200i: FUEL SYSTEM (Auto Control Fuel Injection System)

SERVICE INFORMATION

GENERAL INSTRUCTIONS

* Gasoline is very dangerous. When working with gasoline, keep sparks and flames away from the working area.
Gasoline is extremely flammable and is explosive under certain conditions. Be sure to work in a well-ventilated area.

- Disconnect the cables of the battery when the engine is running, which could lead to ECU damage.
- Connect the harness positive (+) cable to the battery negative (-) terminal or connect the harness negative (-) to the battery positive (+) terminal, which could lead to ECU damage.
- Always keep fuel over 750 cc in fuel tank.

SPECIFICATIONS

Item		Standard	
Charging voltage of battery		13.5~14.5V	
Voltage from the ECU to sensor		5±0.1V	
Fuel injector resistance (20°C/68°F)		13.78~15.23Ω	
Idle air by pass valve resistance (20°C/68°F)		21.5±15%Ω	
Inductive ignition coil resistance (20°C/68°F)		0.57~0.66Ω	
Water temperature sensor resistance		703.8±40.9Ω (60°C) 260.7±15.1Ω (90°C) 111.1±7.8Ω (120°C)	
Throttle position sensor voltage/resistance (20°C/68°F)		Idle (0%)=0.68±0.05V W.O.T. (100%)=4.1±0.1V	5K±30%Ω
T-MAP (Manifold absolute pressure/temperature) sensor	Resistance	14260~16022Ω (-20°C) 2353~2544Ω (20°C) 568.9~597.4Ω (60°C)	
	Voltage	3.83~3.96V (100Kpa) 2.99~3.09V (80Kpa) 2.13~2.23V (60Kpa)	
Fuel pump resistance (20°C/68°F)		1±0.2Ω	
O2 sensor	O2 sensor heater resistance		6.7~9.5Ω (Warm engine)
	Voltage	Air/Fuel<14.7 (Rich)	>0.7V
		Air/Fuel>14.7 (Lean)	<0.18V

(cont'd)

14. DINK 200 i: FUEL SYSTEM (Auto Control Fuel Injection System)

Item	Standard
Crank position sensor (Pulser) resistance (20°C/68°F)	100~130Ω
Fuel injection resistance (20°C/68°F)	11.3±10%Ω
Angle detect sensor voltage (diagnostics)	Normal: 3.5~4.7V ±60° angle position: 0.3~1.4V
Idle speed	1660±100 rpm

TROUBLESHOOTING

Engine won't start

- Battery voltage too low
- Fuel level too low
- Pinched or clogged fuel hose
- Faulty fuel pump operating system
- Clogged fuel filter (fuel pump)
- Clogged fuel injector
- Faulty spark plug or wrong type
- Cut by ECU due to angle detect sensor or incorrect function

Backfiring or misfiring during acceleration

- Ignition system malfunction

Poor performance (drive ability) and poor fuel economy

- Pinched or clogged fuel hose
- Faulty fuel injector



Engine stall, hard to start, rough idling

- Intake air leak
- Fuel contaminated/deteriorated
- Pinched or clogged fuel hose
- Idle speed misadjusted

14. DINK 200i: FUEL SYSTEM (Auto Control Fuel Injection System)

CHECK ENGINE LAMP (CELP)

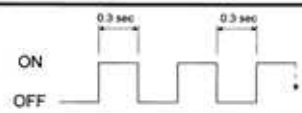
- To test check engine lamp operation, the lamp shall light for a period of 2 seconds upon “key-on”. This lamp test shall indicate to the operator that the lamp is functional and capable of signaling faults should they occur.
- The operator shall be warned of various fault conditions that exist within the vehicle using the CELP. The warning coverage and the priorities have been detailed in the matrix below. A fault that activates the CELP with a lower value priority number takes precedence over one with a higher value priority number, i.e. 1 is the highest priority.
- Faults with a level 1 priority shall cause the CELP to flash.
 Faults with a level 2 priority shall cause the CELP to light continuously.
 Faults with a level 3 priority shall not illuminate the CELP.

PRIORITY	LAMP ACTION
1	
2	
3	

- The throttle should be open and hold fully, then turn the ignition switch ON with no engine speed, after the “lamp test” illumination 2 seconds the lamp shall turn off for 3 seconds. The lamp will then illuminate for 3 seconds and during this three seconds interval the throttle must be released. The lamp then continues to illuminate until the first code is flashed.

14. DINK 200 i: FUEL SYSTEM (Auto Control Fuel Injection System)

SELF-DIAGNOSTIC PROCEDURES WITHOUT DIAGNOSTIC TOOL

SELF-DIAGNOSTIC PROCEDURES

* Make sure the throttle position sensor connector has connected and it is good.

Place the scooter on its main stand.

Turn the ignition switch ON the CELP will light for two second then off. It show the lamp work normal. If the ECU detect any faulty then lamp will keep light.

Start the engine and let it idle.

If the CELP does not light or blink, the system has no memory of problem data.

If the CELP light or blink, stop the engine and read the failure codes, perform the

* Following:
Faults with a level one priority shall cause the CELP to flash at the given rare shown in Figure 1.
 Faults with a level two priority shall cause the CELP to light continuously.
 Faults with a level three priority shall not illuminate the CELP.

(1) Turn ignition switch to OFF, then open and hold the throttle fully.

(2) Turn ignition switch to ON while the CELP comes on, after 2 seconds the CELP will be off.

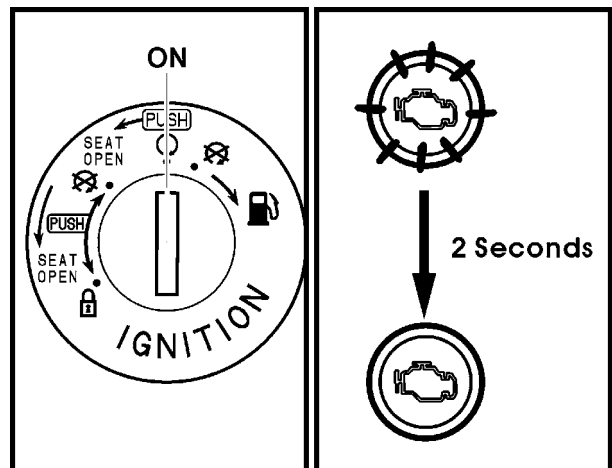
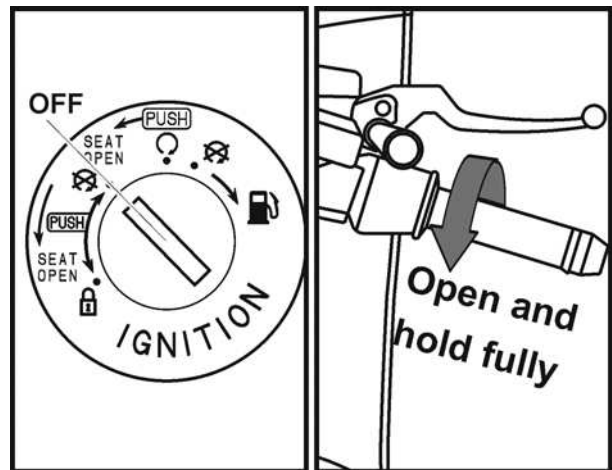
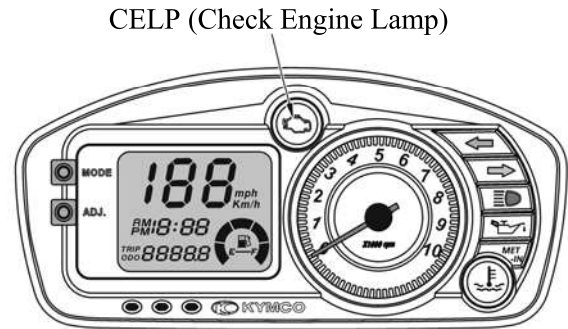

14. DINK 200i: FUEL SYSTEM (Auto Control Fuel Injection System)

- (3) Close the throttle fully when the CELP comes on again.
- (4) When the CELP begins to blink that the CELP denotes the failure codes (the number of blinks from 1 to 24 but there are not number 20 and 23).
- (5) When more than one failure occurs, the CELP shows the blinks in the order of lowest number to highest number. For example, if the indicator blinks once, after CELP off 4 seconds and comes on 4 seconds, then blink 2 times, two failures have occurred. Follow codes 1 and 2.
- (6) All the failure codes will be showed repeatedly.

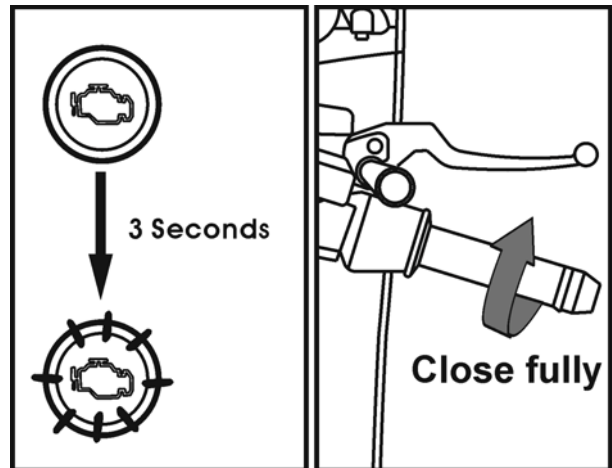

Example 1 (procedures):

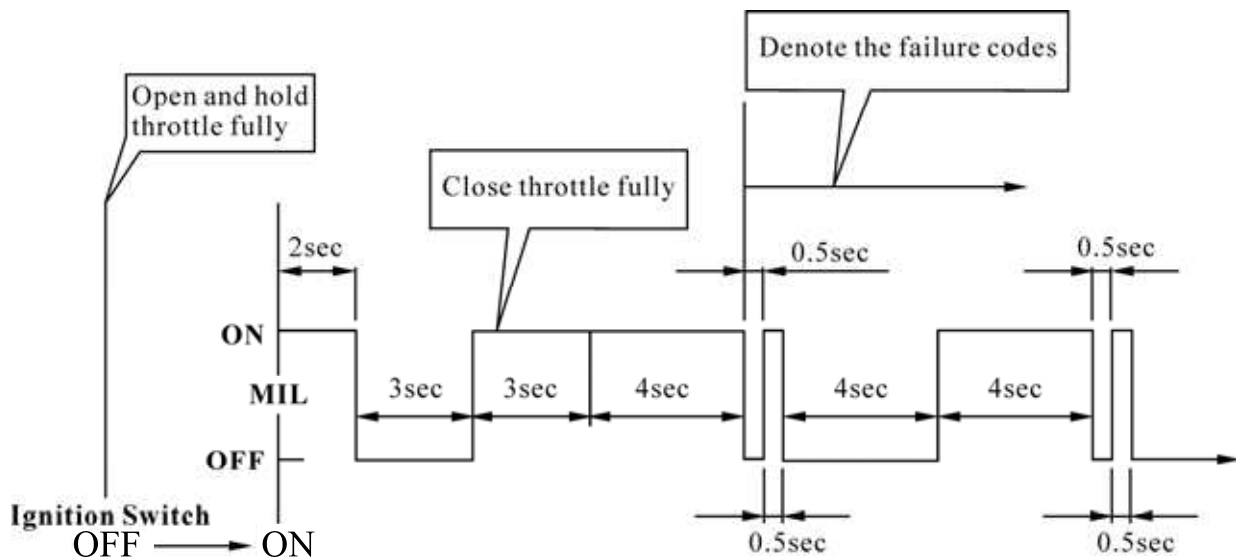

Example 2 (failure codes 1 and 2):

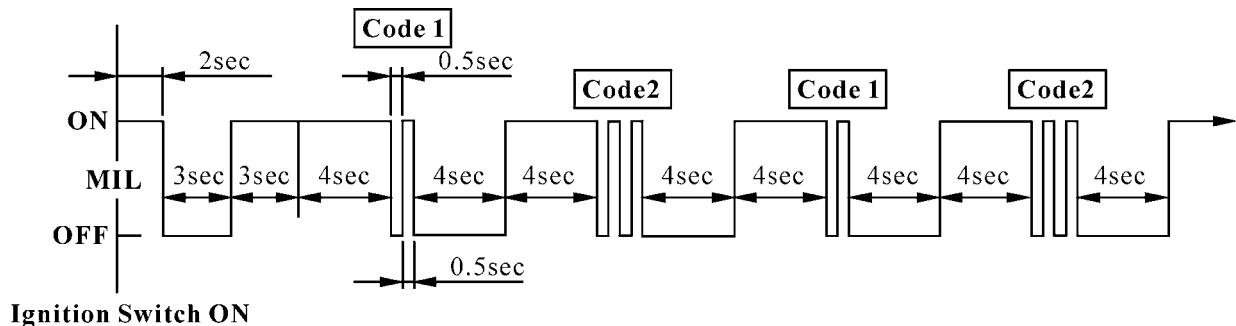

14. DINK 200 i: FUEL SYSTEM (Auto Control Fuel Injection System)

SELF-DIAGNOSIS RESET (CLEAR FAILURE CODES) PROCEDURE

(1) Turn ignition switch to OFF, open and hold the throttle fully.

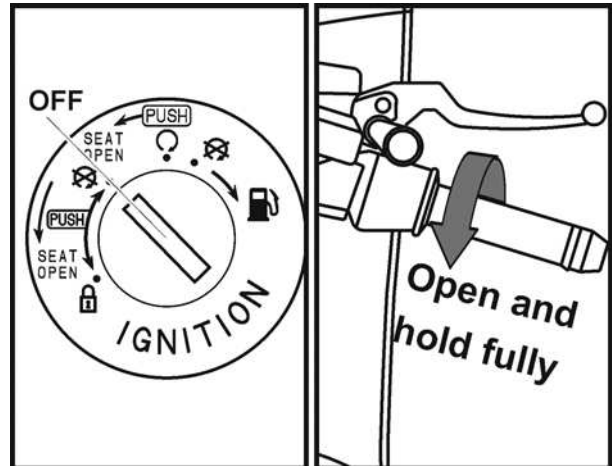

(2) Turn ignition switch to ON while the CELP comes on, after 2 seconds the CELP will be off.

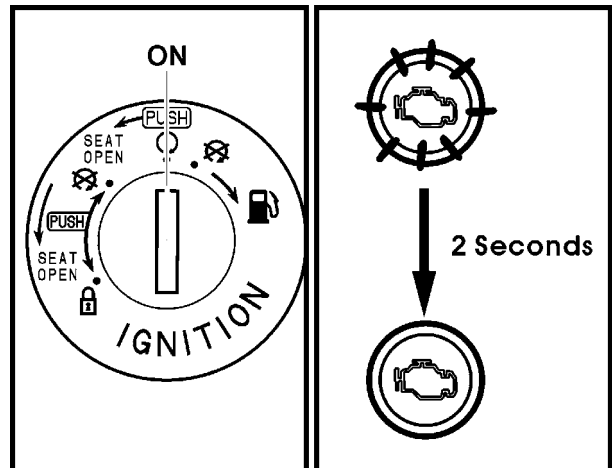

- (3) Close the throttle fully when the CELP comes on again.
- (4) When the CELP begins to blink that the CELP denotes the failure codes.
- (5) The self-diagnosis memory data will be erased when all the failure codes has showed 5 cycles.

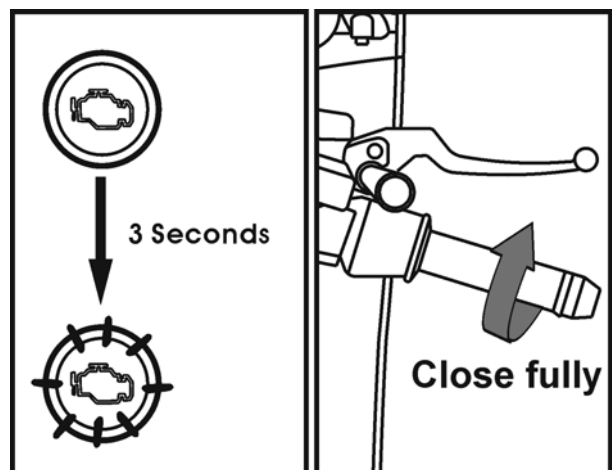

14. DINK 200i: FUEL SYSTEM (Auto Control Fuel Injection System)

CELP FAILURE CODES CHART

Blinks	Failure Codes	Fault description	Priority	Fault management
1	P0217	Engine overheating	1	<ol style="list-style-type: none"> 1. Park the car and Be immediately carry on maintaining a check immediately. 2. The confirmation has the engine temperature sensor know the machine or the electric circuit abnormality it the breakdown yard occurrence, if have already asked confirm the engine temperature sensor to know a machine whether abnormality? Connect line and deal with contact to there is just like often? 3. The check lubricates cooling system whether abnormality? The engine light fire or provide the oil system whether abnormality? The phenomenon that the engine appears to burn to pay?
2	P0335	Encoder fault	2	<ol style="list-style-type: none"> 1. Does the position sensor of checking the crank know the machine outputs whether the feet is anti- or not to connect? 2. The position sensor of checking the crank know whether the machine deals with contact combine or not appropriate? Does connecting line break road? 3. The position sensor of checking the crank know a machine and code the cleft of the Chi whether within the scope of 0.6~1.2 mm? 4. When checking the crank turned to move whether be partial to put? 5. Change a new article to confirm whether does the sensor know a machine abnormality?
3	P1120	TPI adaption fault	2	<ol style="list-style-type: none"> 1. Connect to maintain to examine a patient the machine Reset to reset the TPI position, confirm TPS position to return to initial value scope? 2. Does confirming the TPS deal with contact, connect line and haven't moved and short circuit? 3. Check Dai soon the air side valve to open a degree whether in the specification(new car 30~40;Old car <180) 4. Adjust Dai soon CO% go to enactment the specification scope(0.75~2.8%;Float to move the value min 0.4% above)? 5. If still appear an abnormality, depend on to change whether the new article process confirmation reduce expenses a valve body TPS abnormality or not?

(Cont'd)

14. DINK 200 i: FUEL SYSTEM (Auto Control Fuel Injection System)

Blinks	Failure Codes	Fault description	Priority	Fault management
4	P1121	TPI range fault	2	<ol style="list-style-type: none"> 1.Does confirming the TPS deal with contact, connect line and haven't moved and short circuit? 2.If still appear an abnormality, depend on to change whether the new article process confirmation reduce expenses a valve body TPS abnormality or not?
5	P1122	TPI velocity fault	2	<ol style="list-style-type: none"> 1.Does confirming the TPS deal with contact, connect line and haven't moved and short circuit? 2.If still appear an abnormality, depend on to change whether the new article process confirmation reduce expenses a valve body TPS abnormality or not?
6	P0560	Battery voltage range fault	1	<ol style="list-style-type: none"> 1.Confirming the electric cell electric voltage leads low or lead high? 2.Confirm three mutually does the generator(ACG) refresh whether system break the road or abnormality or not? 3.Does confirming the ECU PIN15 go to whether the electric cell anode circuit break road or not? 4.Confirm electric cell whether abnormality, if the electric cell is already can't the Xu electricity change new electric cell?
7	P0110	Air temperature sensor fault	2	<ol style="list-style-type: none"> 1.Does confirming the sensor know whether the machine electric resistance is normal or not? 2.Does confirming the sensor know the machine deals with contact, connects line and hasn't moved and break road? 3. If still appear an abnormality, depend on to change new article process to confirm whether does the sensor know a machine abnormality?

(Cont'd)

14. DINK 200i: FUEL SYSTEM (Auto Control Fuel Injection System)

Blinks	Failure Codes	Fault description	Priority	Fault management
8	P0410	Idle air bypass valve fault	2	<ol style="list-style-type: none"> 1. Confirm Dai soon the air side whether valve electric resistance break the road or short circuit or not? 2. Does confirming the sensor know the machine deals with contact, connects line and hasn't moved and break road? 3. If still appear an abnormality, depend on to change new article process to confirm whether the Dai is an air soon is beside valve abnormality?
9	P0505	Idle speed adaption fault	2	<ol style="list-style-type: none"> 1. Check Dai soon the air side valve to open a degree whether in the specification (new car 30~40; Does the old car < 180) also confirm to reduce expenses whether the valve body accumulates carbon to jam or not? (enter current of air quantity shortage) 2. Confirm Dai soon accelerator to open a degree whether abnormality? (block or the air screw adjust inappropriate) 3. Confirm and haven't leaked air phenomenon into the windpipe?
10	P0251	Fuel injector fault	2	<ol style="list-style-type: none"> 1. Confirming the fuel spray the mouth electric resistance whether in the specification? 2. Does confirming the fuel spray a mouth and deal with contact, connect line and haven't moved and break road? (the ECU pin 3) 3. Does confirming the fuel spray whether the mouth power supply supply is normal or not? 4. If still appear an abnormality, depend on to change new article process to confirm whether does the fuel spray a mouth abnormality?

(Cont'd)

14. DINK 200 i: FUEL SYSTEM (Auto Control Fuel Injection System)

Blinks	Failure Codes	Fault description	Priority	Fault management
11	P0350	Ignition fault	2	<ol style="list-style-type: none"> 1.The confirmation light the front line turn electric resistance whether in the specification? 2.Does the confirmation light the front line turn and deal with contact, connect line and haven't moved and break road?(the ECU pin 12) 3.Does the confirmation light the front line turn whether power supply supply is normal or not? 4.If still appear an abnormality, depend on to change whether the new article process confirmation light the front line turn an abnormality or not?
12	P0230	Fuel-pump relay fault	2	<ol style="list-style-type: none"> 1.Confirm the fuel pump and deal with contact, connect line and haven't moved and break road after the electrical appliance?(the ECU pin 5) 2.If still appear an abnormality, change a new fuel pump to confirm after the electrical appliance whether fuel pump after electrical appliance abnormality?
13	P0219	Engine max over-speed fault	2	<ol style="list-style-type: none"> 1.Turn soon exceed engine safe enactment, reduce the engine operation speed then cancellation breakdown yard. 2.Does checking the CVT leather belt split? Cause the engine lead high turn soon.
14	P1560	Transducer power supply fault	2	<ol style="list-style-type: none"> 1.Confirm the ECU pin 18 whether output 5 V DC? 2.Confirm whether power supply electric voltage is the 5 V DC or not that each sensor knows the machine connects line to carry? (the ECU pin 18 and pin 16 it press bad) 3.If the ECU output for the 5 V DC, but still show'the sensor know the machine power supply supply abnormality' then depend on to change new article process to carry on ECU to change.

(Cont'd)

14. DINK 200i: FUEL SYSTEM (Auto Control Fuel Injection System)

Blinks	Failure Codes	Fault description	Priority	Fault management
15	P0700	CVT threshold exceeded fault	2	<ol style="list-style-type: none"> 1. When the engine start turns soon over the 3250 rpms, in order to avoid hurtling suddenly and violently, the ECU will reduce engine to turn to even turn off soon. 2. Ask user to avoid launching the engine moment nasty open accelerator. 3. Does checking the accelerator line(Cable) block? 4. Is the Dai whether the screw position enactment is normal or not soon?(0.68 ± 0.05) 5. Does the CVT leather belt split?
16	P0115	Engine temperature sensor fault	2	<ol style="list-style-type: none"> 1. Confirming the sensor know the machine electric resistance whether in the specification? 2. Does confirming the sensor know the machine deals with contact, connects line and hasn't moved and break road?(the ECU pin 9).
17	P1561	Temperature gauge fault	2	Does not have the information.
18	P0650	Check engine lamp fault	3	<ol style="list-style-type: none"> 1. Does checking the engine examination light light bulb destroy by fire? 2. Checking the engine examination light light bulb specification is a 1.7 Ws, 12 VDCs? 3. Does checking the engine examination light circuit break road?(the ECU pin 4)
19	P1410	CO potentiometer fault	2	Does not have the information

(Cont'd)

14. DINK 200 i: FUEL SYSTEM (Auto Control Fuel Injection System)

Blinks	Failure Codes	Fault description	Priority	Fault management
21	P0105	Manifold pressure fault	2	<ol style="list-style-type: none"> 1. Confirm whether the output voltage of the sensor is within specification? 2. Check whether the output pin position of the sensor is correct or open circuit occurs? (the ECU pin 8) 3. Replace with a new sensor according to the part-exchanging process to confirm whether the error code still exists?
22	P1110	Angle detect sensor fault	2	<ol style="list-style-type: none"> 1. Confirming the sensor know the machine outputs electric voltage whether in the specification? 2. Does confirming the sensor know the machine deals with contact, connects line and hasn't moved and break road? (the ECU pin 11) 3. If still appear an abnormality, change to turn to pour sensor to know lately the machine confirms whether does the sensor know a machine abnormality?
23	P0136	O2 sensor circuit malfunction	1	<ol style="list-style-type: none"> 1. Check the connector or pin. 2. Replace with a new part.
24	P0141	O2 heater/O2 sensor circuit malfunction	2	Does not have the information.
25	P0171	Close loop fault	1	Close loop correction value out of the range, check the engine CO%.

14. DINK 200i: FUEL SYSTEM (Auto Control Fuel Injection System)

SELF-DIAGNOSTIC PROCEDURES USING DIAGNOSTIC TOOL (PDA)

You have to use a PDA and download diagnostics program (KYDTool-5.0.E or latest version of diagnostics program) into the SD card at KYMCO web site.

* We recommended the diagnostics program be installed in the SD card. Because the diagnostics program will lose when the PDA no power if the diagnostics program be installed in PDA.

The diagnostic cable can be purchased from KYMCO.

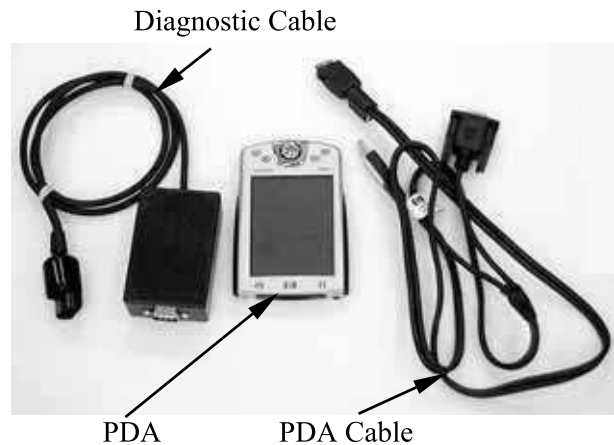

SELF-DIAGNOSTIC PROCEDURES (LOAD DTC)

1. Connect PDA, PDA cable and diagnostic cable.
2. Put the side stand up and engine stop switch is at "RUN".
3. Turn the ignition switch to "ON".
4. Connect the diagnostic cable and diagnostic tool connector (1) in the battery compartment.

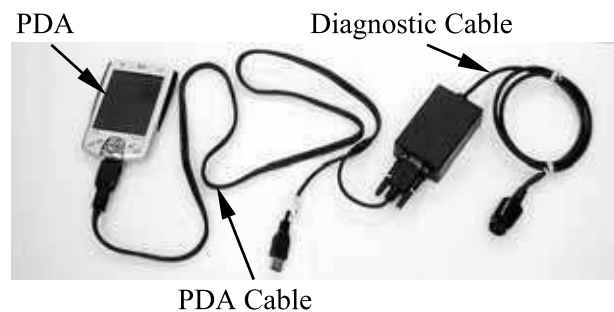

14. DINK 200 i: FUEL SYSTEM (Auto Control Fuel Injection System)

5. Perform the diagnostics program, wait a moment then select “OK”.
6. Select “SET”.
7. Select “Language”, then to select language (English).

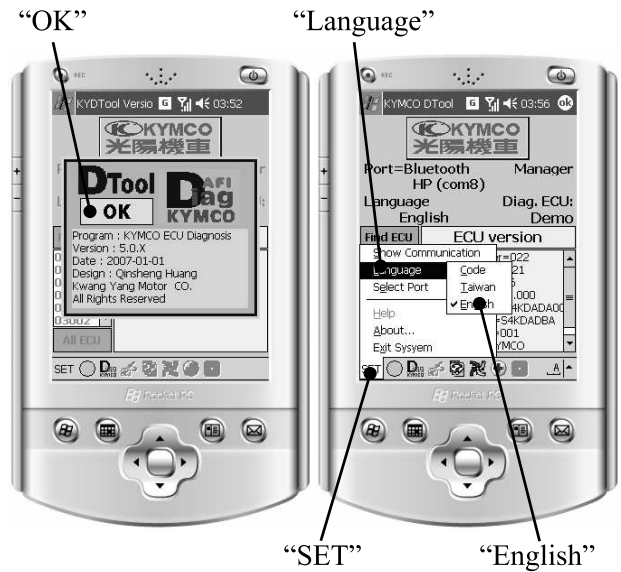

7. Select the “Find ECU”, then the ECU will be find automatically.
8. Select the “DTC mark” to enter DTC inspect menu.



9. Select “Load DTC” to appear Active failure codes in DTC List. Read “All DTC”, “Active”, “Occurred” or “history” by select option block.
10. Select a DTC item in the “DTC LIST” to appear the repair suggestion.

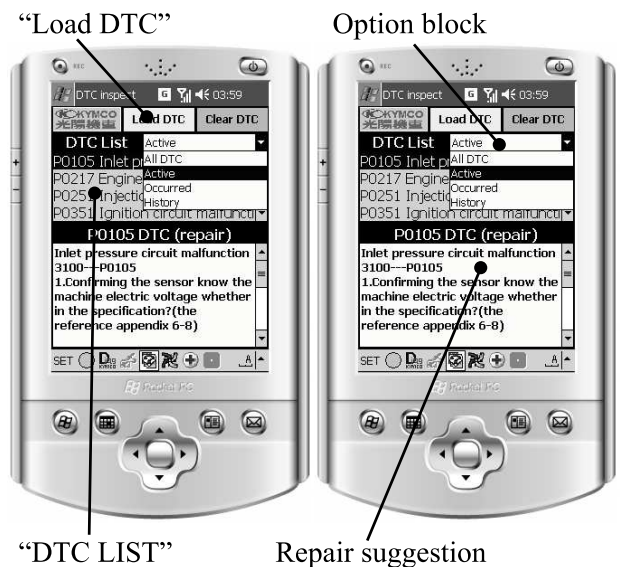

14. DINK 200i: FUEL SYSTEM (Auto Control Fuel Injection System)

* Select the “Ding” mark, then select ok to leave SELF-DIAGNOSTIC program.



“Ding” mark

CLEAR DTC

1. Select “Load DTC”, select “All DTC”, “Active”, “Occurred” or “history” by select option block then to select option.
2. Select “Clear DTC” to clear.

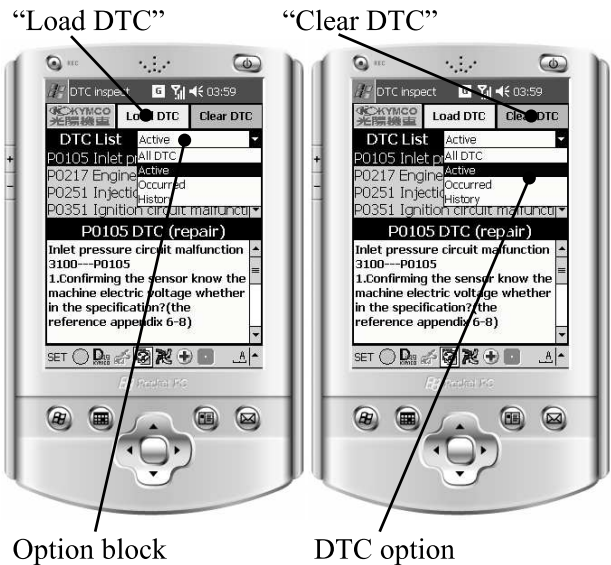

Option block

DTC option

* Select the “Ding” mark, then select ok to leave SELF-DIAGNOSTIC program.



“Ding” mark

14. DINK 200 i: FUEL SYSTEM (Auto Control Fuel Injection System)

RECIVE SIGNAL MENU (USING DIAGNOSTIC TOOL)

* There are 7 page in this section to displays the scooter's condition. They are not trouble indicators for AFI system and some data no definite range but you can compare normal with abnormal condition from current data.

READ SIGNAL DATA PROCEDURES

1. Follow step 1 to 7 under “**SELF-DIAGNOSTIC PROCEDURES USING DIAGNOSTIC TOOL (PDA)**”

2. Select “windmill mark” to enter Recive Signal menu.

3. Select “RUN” to read signal data.

Select “PageUp” to enter next page.

Select “PageDn” to enter last page.

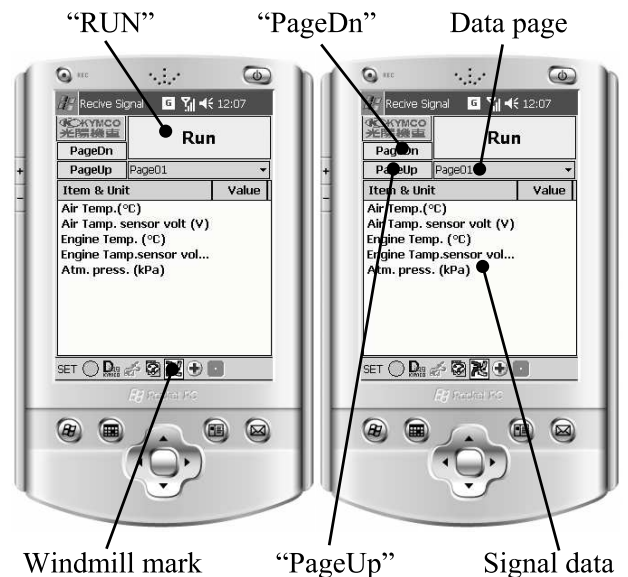

14. DINK 200i: FUEL SYSTEM (Auto Control Fuel Injection System)

SIGNAL DATA CONTENTS

Page01:

- Air Temp. (°C)
- Air Temp. sensor volt (V)
- Engine Temp. (°C)
- Engine Temp. sensor volt (V)
- Atm. Press. (kPa)



Page 02

- Engine speed (rpm)
- Throttle Position (%)
 - Standard:**
 - Close fully: 0%
 - Open fully: 100%

- TPS sensor volt for primary (V)
 - Standard:**
 - Close fully: 0.68±0.05V
 - Open fully: 4.1±0.1V

- TPIIdleMean (V)
 - Standard:** 0.68±0.05V

- TPIWotMean (V)
 - Standard:** 4.1±0.05V



14. DINK 200 i: FUEL SYSTEM (Auto Control Fuel Injection System)

Page 03

Engine speed (rpm)
 Battery Volt (V)
 Transducer power supply volt (V)
Standard: 5±0.1V

Idle speed setpoint (rpm)
Standard: 1660±100 rpm



Page 04

ABVOnTimeOfs (ms)
Standard: 0

AirflowAdap OfS (g/s)
Standard: 0

Manual TPI initialisation
 Cut Out switch volt (V)
Standard: 3.5~4.7V



Page 05

Engine speed (rpm)
 MAPSample (kpa)
 Injection duration (ms)
 Ign. Advance (°)
 Ign. Dwell duration (ms)



14. DINK 200i: FUEL SYSTEM (Auto Control Fuel Injection System)

Page 06

Engine speed (rpm)
 Secondary TPI initial adaptation
 ISCA adapMean (°)
 ABV AngDurMech (°)

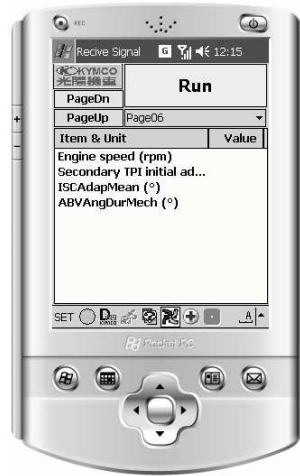

Page 07

Accumulated eng. run time
 Fuel pump state
 Primary TPI AdapInit (V)
 O2 sensor voltage (mV)
 O2 sensor heater activation (Yes/No)

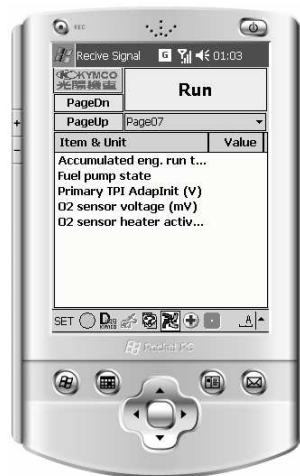

14. DINK 200 i: FUEL SYSTEM (Auto Control Fuel Injection System)

MAINTENANCE MENU (USING DIAGNOSTIC TOOL)

1. Follow step 1 to 7 under “**SELF-DIAGNOSTIC PROCEDURES USING DIAGNOSTIC TOOL (PDA)**”
2. Select “⊕ mark” to enter Maintenance menu.

Reset TPI

Select “Reset TPI” to reset throttle position sensor.

* To reset the TPI when the throttle body is replaced (see the “**THROTTLE POSITION SENSOR INITIAL PROCEDURE**” section in this chapter).

“Reset TPI”



Air bypass valve offset

Select “Load”.

Select “Reset” to reset the “ABVOnTimeOfs (ms)” value.

* To reset the ABV when the throttle body, air by pass valve, cylinder head or cylinder is replaced (see the “**RESET THE AIR BY PASS VALVE (ABV)**” section in this chapter).

“Load”



“Reset”

To adapt the ABV plus or minus 0.1 unit at a time, select the options.

To adapt the ABV plus or minus 1 unit at a time, select the options.

14. DINK 200i: FUEL SYSTEM (Auto Control Fuel Injection System)

APC Valve learning Reset

Select "LOAD".

Select "Reset" to reset the "AirflowAdapOfs (g/s)" value.

- To reset the APC when the cylinder/piston is replaced.

To adapt the APC plus or minus 0.01 unit at a time, select the options.

To adapt the APC plus or minus 0.1 unit at a time, select the options.



14. DINK 200 i: FUEL SYSTEM (Auto Control Fuel Injection System)

THROTTLE POSITION SENSOR INITIAL PROCEDURE

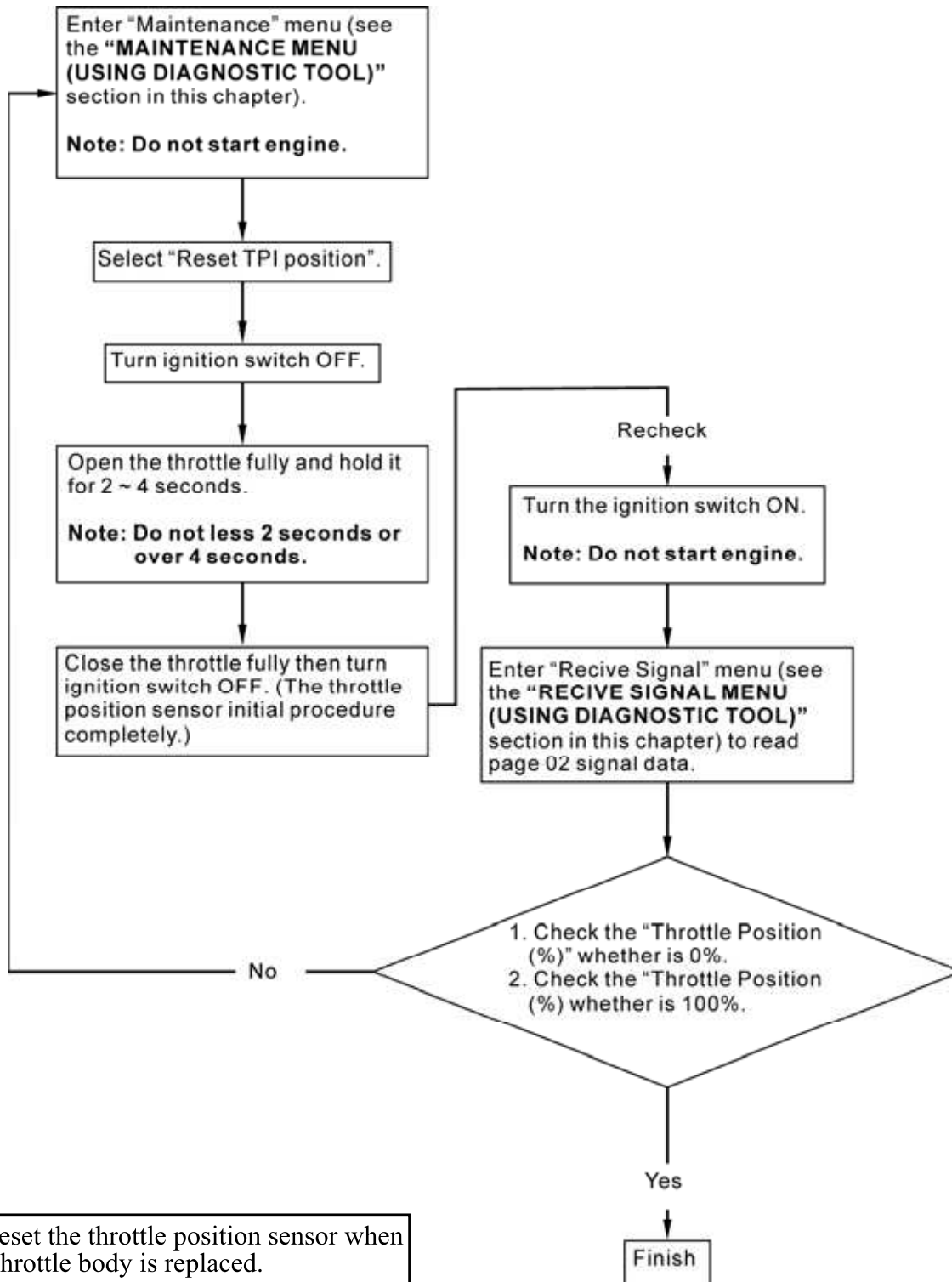

14. DINK 200i: FUEL SYSTEM (Auto Control Fuel Injection System)

RESET THE AIR BY PASS VALVE (ABV)

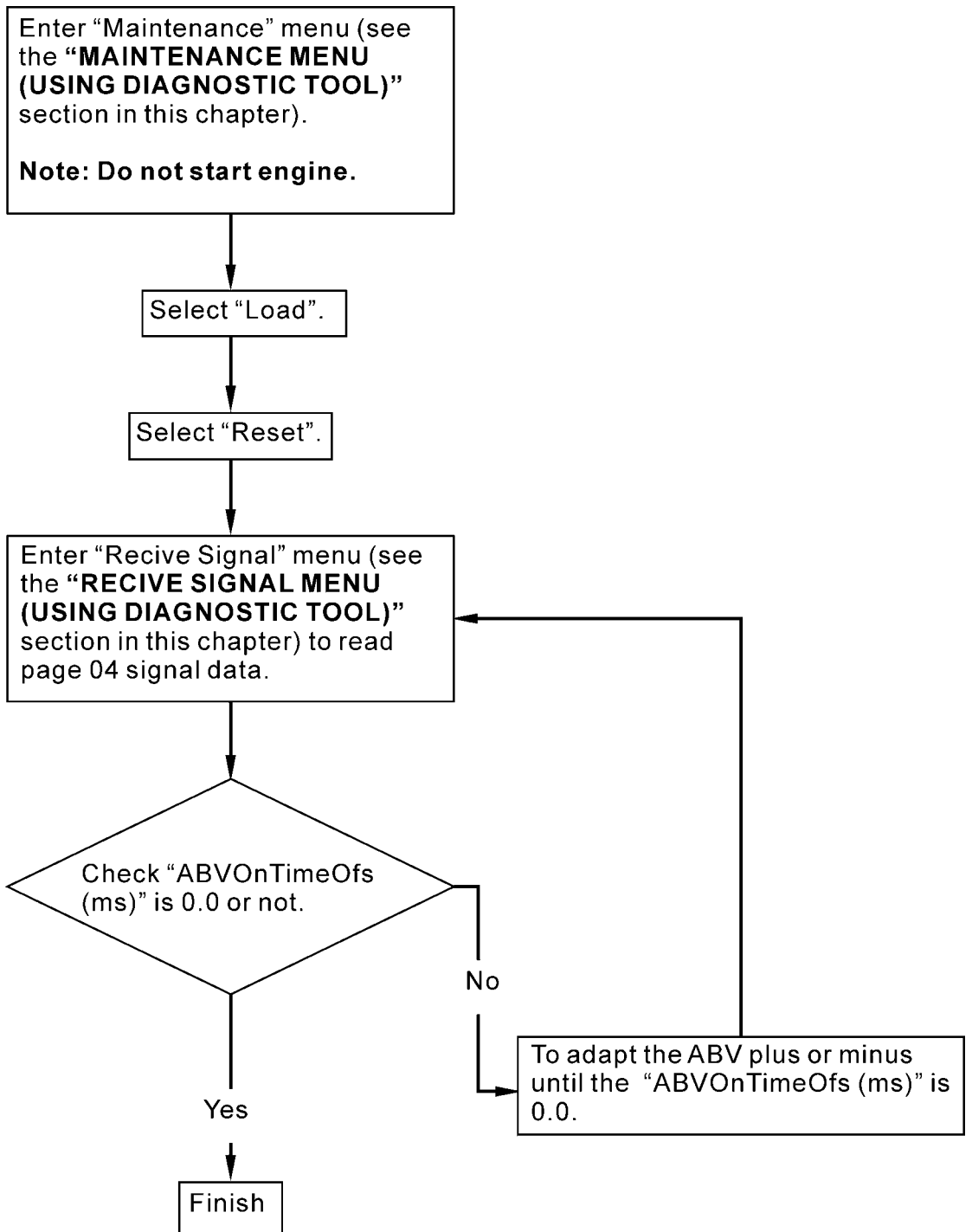

* To reset the ABV when the throttle body, air by pass valve, cylinder head or cylinder is replaced.

14. DINK 200 i: FUEL SYSTEM (Auto Control Fuel Injection System)

ADAPT AIR FLOW PER CYCLE (APC)

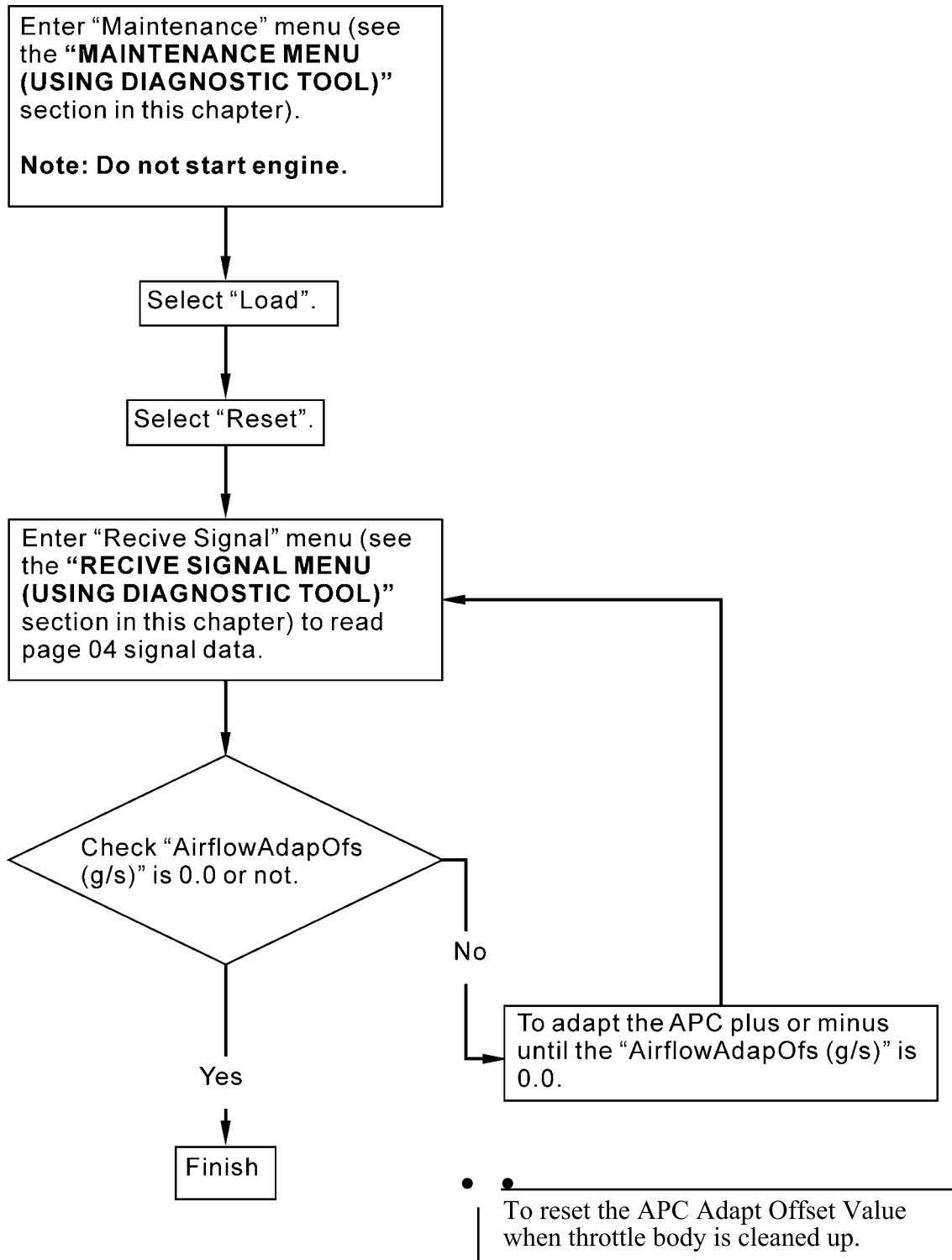

14. DINK 200i: FUEL SYSTEM (Auto Control Fuel Injection System)

APC ADAPTION PROCEDURE

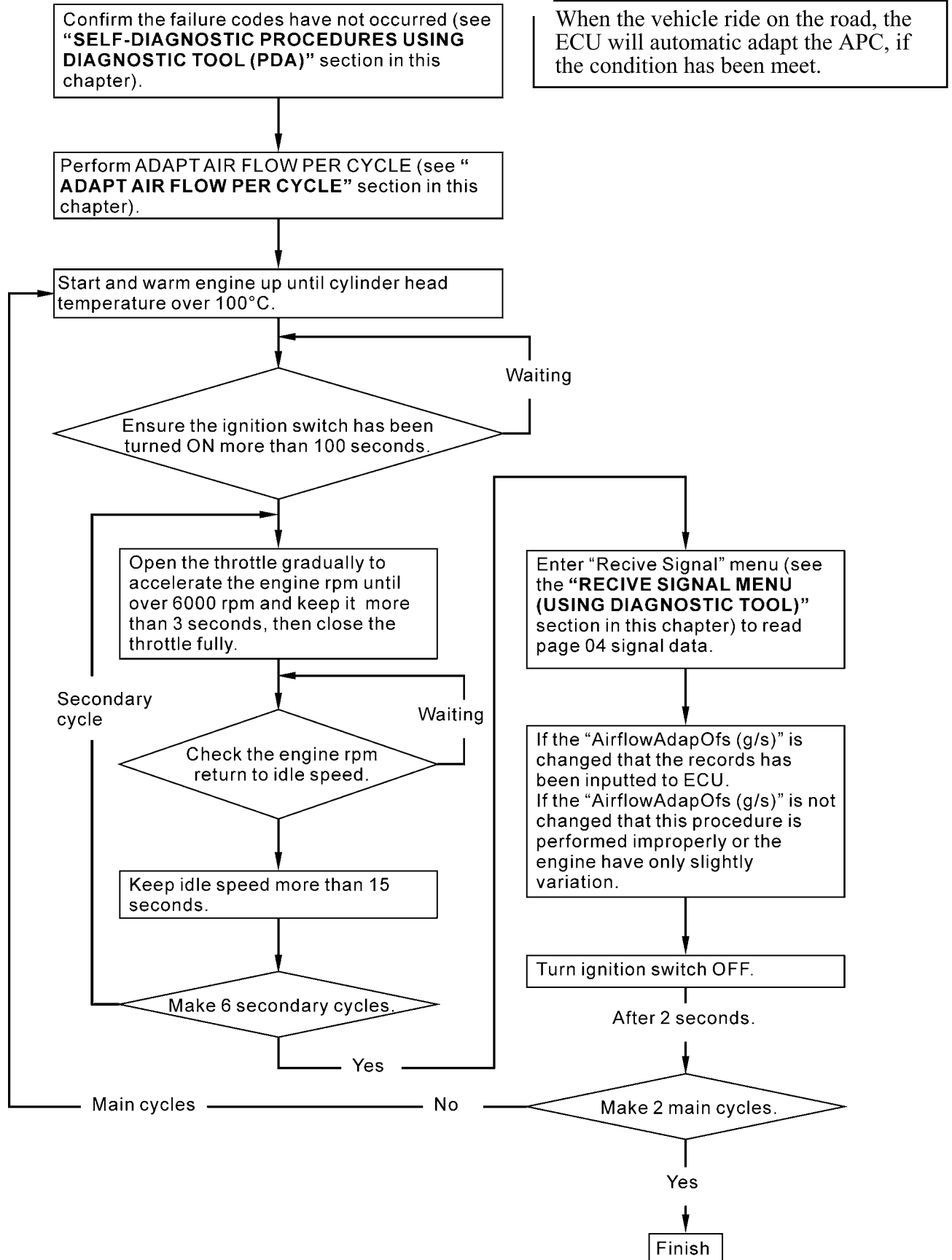

14. DINK 200 i: FUEL SYSTEM (Auto Control Fuel Injection System)

SPARK PLUG ANTI-FLOOD

When no failure code occurs and pressing starter switch repeatedly still can not start the engine, maybe the spark plug is flood by fuel, perform the spark plug anti-flood to purge the fuel in the engine.

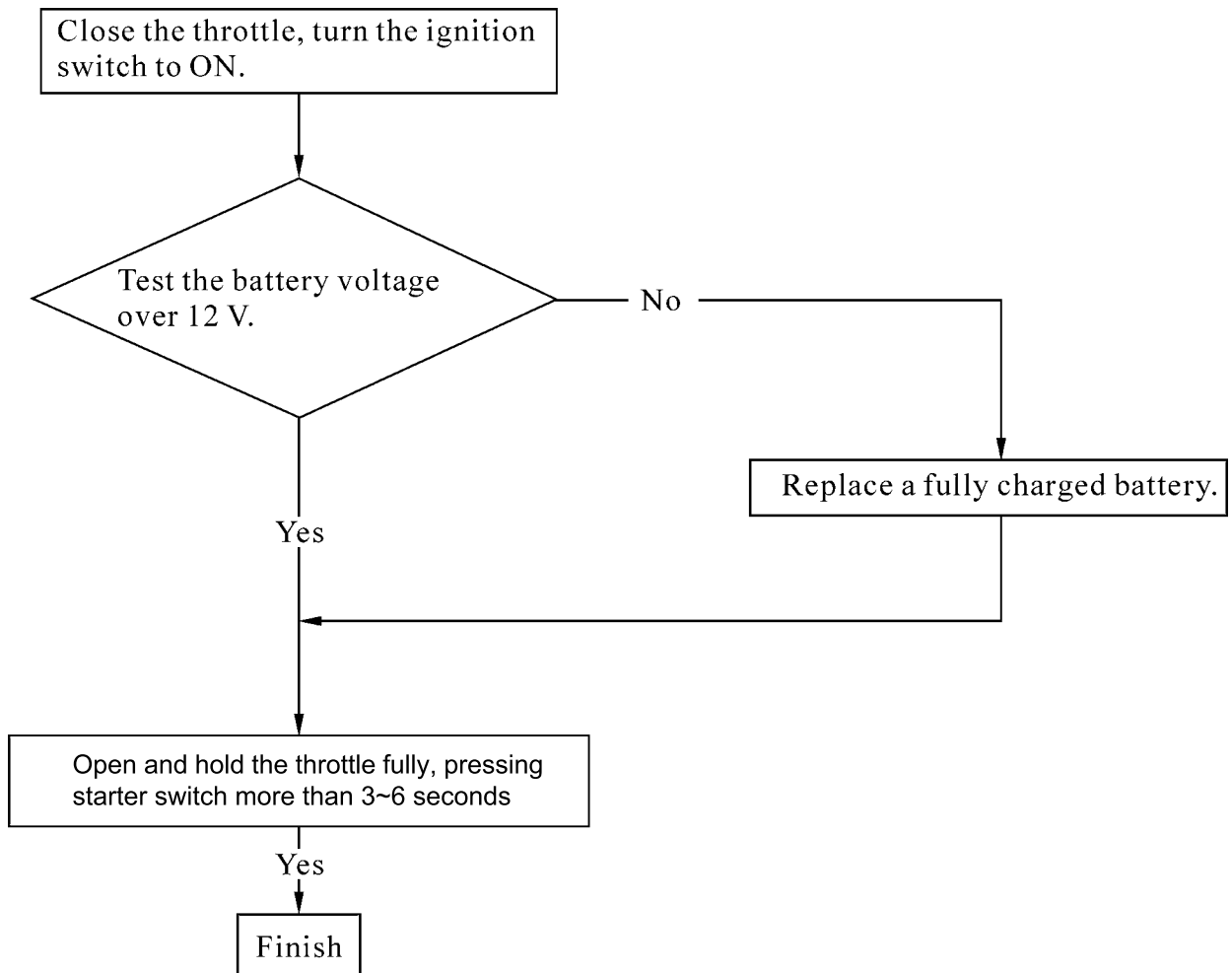

14. DINK 200i: FUEL SYSTEM (Auto Control Fuel Injection System)

ENGINE CONTROL UNIT (ECU)

REMOVAL/INSTALLATION

- *
 - Do not disconnect or connect the ECU connector during the ignition switch "ON"; it may cause the ECU damage.
 - Connect the battery terminals topsy-turvy may cause ECU damage.

Remove three bolts and disconnect ECU connector, then remove ECU.

- *
 - Keep out of water.
 - Remove the battery when the ignition switch is ON may cause the ECU damage.

Installation is in the reverse order of the removal.

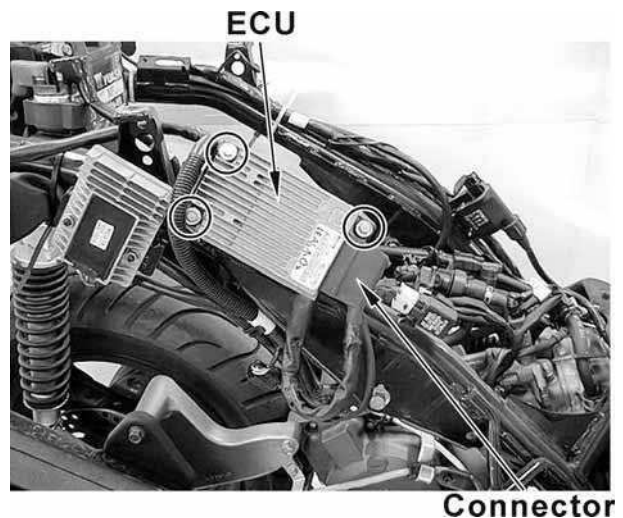

INSPECTION

- *
 - ECU pin location and function in next page.

(Using a commercially available multimeter)

Input voltage

Turn ignition switch to OFF, and Disconnect the ECU connector.

Turn ignition switch to ON.

Connect the multimeter (+) probe to the red wire and the multimeter (-) probe to the green wire.

There should be battery voltage at all times.



14. DINK 200 i: FUEL SYSTEM (Auto Control Fuel Injection System)

Check for continuity

Disconnect and remove the ECU from the frame.

Check for continuity between wire terminal 1 and 16 of the ECU side connector

There should be continuity at all times.

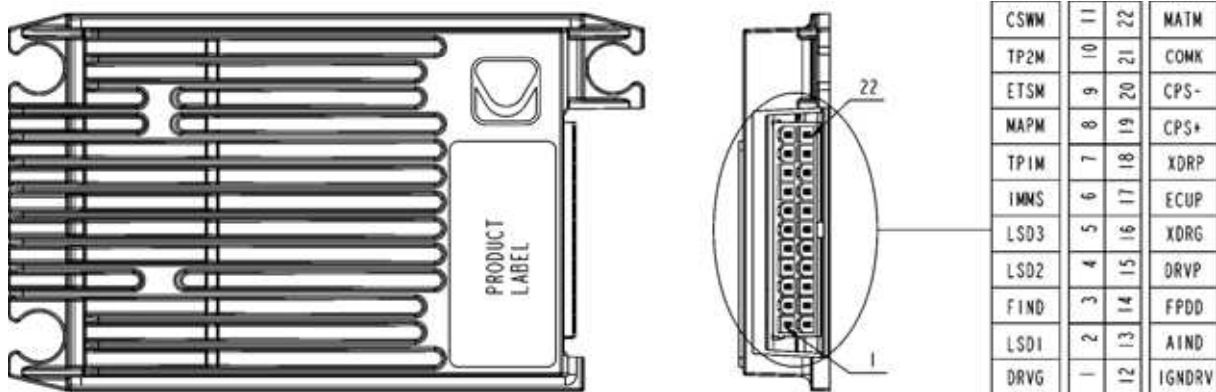

ECU PIN FUNCTION

PIN NO.	NAME	FUNCTION	PIN NO.	NAME	FUNCTION
1	DRVG	DRIVER GROUND	12	IGNDRV	IGNITION COIL DRIVER
2	LSD1	CANNISTER VAPOUR PURGE DRIVER	13	AIND	IDEL AIR VALVE DRIVER
3	FIND	FUEL INJECTOR	14	FPDD	O2 HEATER
4	LSD2	CHECK ENGINE LIGHT DRIVER	15	DRVP	DRIVER POWER (BATTERY)
5	LSD3	PUMP RELAY DRIVE	16	XDRG	TRANSDUCER GROUND
6	IMMS	—	17	ECUP	ECU POWER (KEY SWITCH)
7	TP1M	THROTTLE POSITION SENSOR MONITOR	18	XDRP	TRANSDUCER POWER (5V)
8	MAPM	MANIFOLD/ BAROMETRIC AIR PRESSURE MONITOR	19	CPS+	CRANKSHAFT POSITION SENSOR+
9	ETSM	ENGINE TEMPERATURE SENSOR MONITOR	20	CPS-	CRANKSHFT POSITION SENSOR-
10	TP2M	O2 SIG.	21	COMK	ISO 9141 SERIAL COMMUNICATIONS
11	CSWM	CUT-OUT SWITCH MONITOR	22	MATM	MANIFOLD AIR TEMPERATURE SENSOR MONITOR

14. DINK 200i: FUEL SYSTEM (Auto Control Fuel Injection System)

TEMPERATURE/MANIFOLD ABSOLUTE PRESSURE SENSOR (T-MAP)

REMOVAL

Disconnect T-MAP sensor connector and remove two screws, then remove T-MAP sensor.

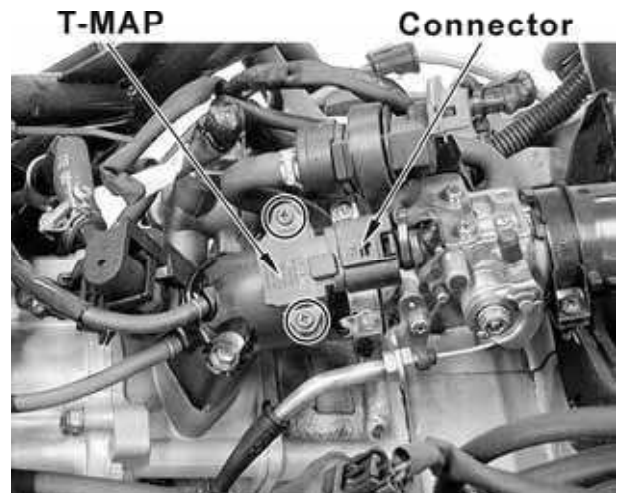

INSTALLATION

Installation is in the reverse order of the removal.

* _____

- Coat O-ring with clean engine oil.
- Replace a new O-ring if it has damaged.

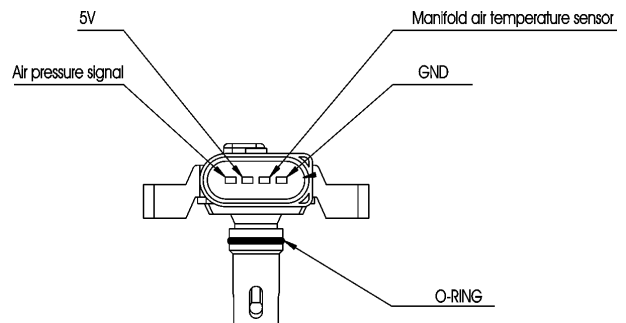

INSPECTION

(Using a commercially available multimeter)

Input voltage

Turn ignition switch to ON with the engine stop switch in the run position and put the side stand up.

Disconnect the T-MAP sensor connector.

Connect the multimeter (+) probe to the violet/red wire and the multimeter (-) probe to the violet/green wire to measure the voltage from the ECU input to T-MAP sensor.

Standard (20°C/68°F): 5±0.25 V

* _____

Be sure that the battery is in good condition before performing this measurement.



14. DINK 200 i: FUEL SYSTEM (Auto Control Fuel Injection System)

Resistance

Measure the resistance between the air pressure signal (V/R) and manifold temperature sensor (Br/B) terminals.

Standard:

- 14260 ~ 16022 Ω (-20°C)
- 2353 ~ 2544 Ω (20°C)
- 568.9 ~ 597.4 Ω (60°C)

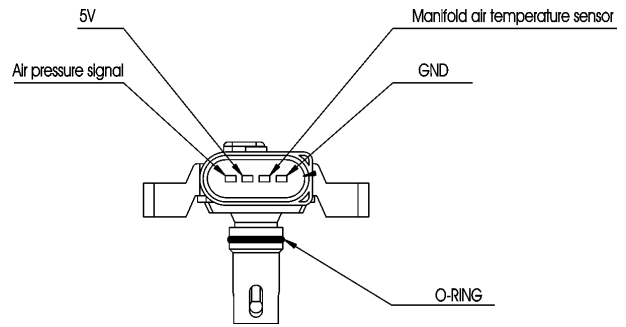

(Using diagnostic tool)

Enter RECEIVE SIGNAL MENU (refer to the “RECEIVE SIGNAL MENU (USING DIAGNOSTIC TOOL)” section in this chapter).

Read page 01

- Air Temp. (°C)
- Air Temp. sensor volt (V)
- Atm. Press. (kPa)

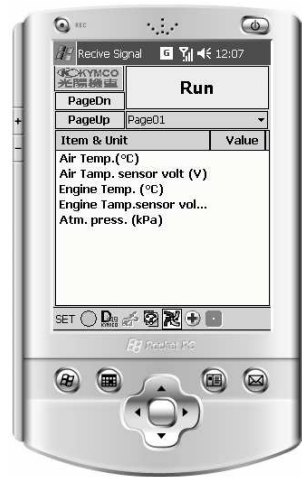

Read page 05

MAPSample (kPa)

* Be sure that the battery is in good condition before performing this measurement.



14. DINK 200i: FUEL SYSTEM (Auto Control Fuel Injection System)

THROTTLE BODY/THROTTLE POSITION SENSOR (TPS)/IDLE AIR BY PASS VALVE (ABV)

- Turn ignition switch off and set up center stand when do the replacement.
- Check and confirm the battery voltage above 12V by a voltmeter after replacement.
- Check and confirm the other connectors are assembled correctly after replacement.
- Do not damage the throttle body, this may cause incorrect throttle and idle valve synchronization.
- The throttle body is factory pre-set, do not disassemble it in a way other than shown in this manual.
- Do not loosen or tighten the painted bolts and screws of the throttle body. Loosening or tightening them can cause throttle and idle valve synchronization failure.

REMOVAL/INSTALLATION

Turn ignition switch OFF.

Loosen the lock nut (1) and remove the adjust nut (2), then disconnect the throttle cable (3).

Loosen intake manifold band screw (4) and air ventilation hose band screw (5).

Disconnect throttle position sensor connector (6) and idle air by pass valve connector (7), then remove throttle (8).

Installation is in the reverse order of the removal.

- To reset the ABV and APC when the throttle body, air by pass valve, cylinder head or cylinder is replaced (refer to the “**RESET THE AIR BY PASS VALVE (ABV)**” section in this chapter).

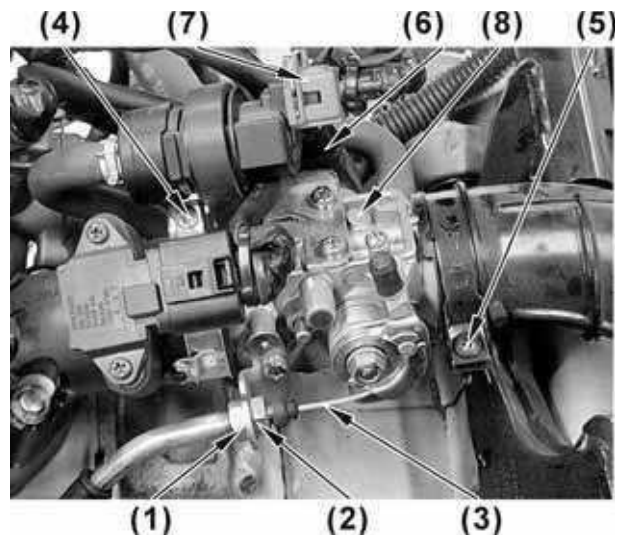

14. DINK 200 i: FUEL SYSTEM (Auto Control Fuel Injection System)

TPS INSPECTION

(Using a commercially available multimeter)

Input voltage

Turn ignition switch to ON with the engine stop switch in the run position and put the side stand up.

Disconnect throttle position sensor connector.

Connect the multimeter (+) probe to the violet/red wire and the multimeter (-) probe to the violet/green wire to measure the voltage from the ECU input to throttle position sensor.

Standard (20°C/68°F): 5 ± 0.25 V

*

Be sure that the battery is in good condition before performing this measurement.

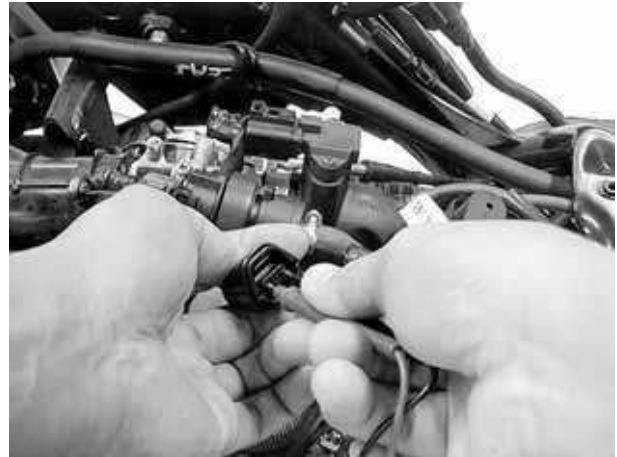

Resistance

Measure the resistance between the throttle position sensor violet/red and violet/green wire terminals.

Standard: $5K\pm 30\%$ Ω (20°C/68°F)



14. DINK 200i: FUEL SYSTEM (Auto Control Fuel Injection System)

(Using diagnostic tool)

Enter RECEIVE SIGNAL MENU (refer to the “RECEIVE SIGNAL MENU (USING DIAGNOSTIC TOOL)” section in this chapter).

Read page 02

Throttle position (%)

Standard:

0% (close throttle fully)
100% (open throttle fully)

TPS sensor volt for primary (V)

Standard:

$0.68 \pm 0.05V$ (0%)
 $4.1 \pm 0.1V$ (100%)



*

Premature carbon build-up in throttle body or faulty throttle position sensor may cause out of “Throttle position” or “Sensor output” specification.

14. DINK 200 i: FUEL SYSTEM (Auto Control Fuel Injection System)

ABV INSPECTION

(Using a commercially available multimeter)

Input voltage

Put the side stand up and the engine stop switch is “RUN”.

Disconnect the air by pass valve connector.
Connect the multimeter (+) probe to the red wire terminal and the multimeter (-) probe to the green/black wire terminal.

Turn the ignition weitch to “ON” and measure the voltage between the terminals.
There should be battery voltage for a few seconds.

If there is battery voltage, replace the ABV.
If there is no battery voltage, inspect the following:

- Fuse (20A)
- ECU



Resistance

Measure the resistance between the idle air bypass sensor terminals.

Standard: $21.5 \pm 15\% \Omega$ (20°C/68°F)



14. DINK 200i: FUEL SYSTEM (Auto Control Fuel Injection System)

Check that the air should flow (A) to (B), only when the 12-V battery is connected to the idle air bypass valve terminals.

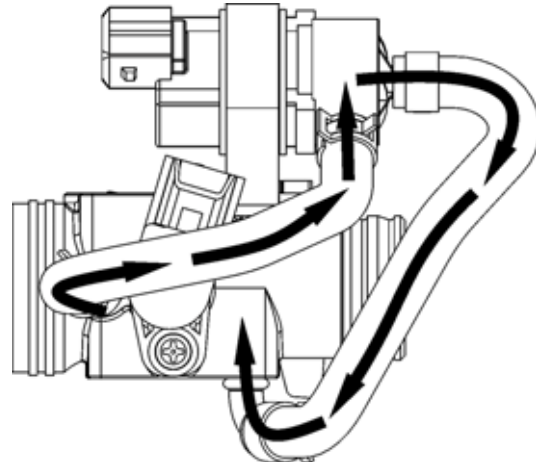

(Using diagnostic tool)

Enter RECEIVE SIGNAL MENU (refer to the **“RECEIVE SIGNAL MENU (USING DIAGNOSTIC TOOL)”** section in this chapter).

Read page 04.

Check the value of “ABVOnTimeOfs (ms)” is 0, if not perform the ABV reset (refer to the **“RESET THE AIR BY PASS VALVE (ABV)”** section in this chapter).



Read page 06

Start the engine to read ABV adaption (“ISCAdapMean (°)”) and ABV open duration (“ABVAngDurMech (°)”) under any engine speed rpm.



14. DINK 200 i: FUEL SYSTEM (Auto Control Fuel Injection System)

THROTTLE BODY INSPECTION

Check throttle valve for free movement.
If stick is found, replace the part with a new throttle body.

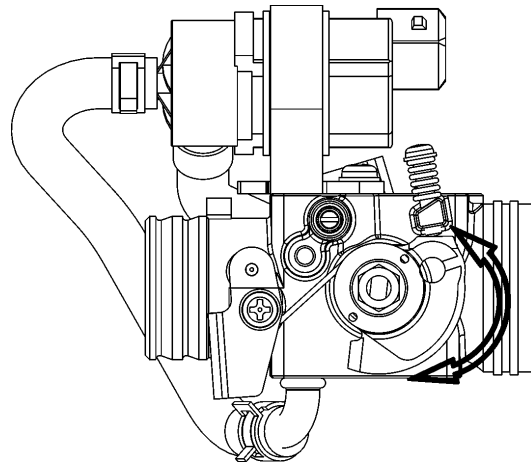

14. DINK 200i: FUEL SYSTEM (Auto Control Fuel Injection System)

WATER TEMPERATURE SENSOR (WTS)

REMOVAL

Disconnect the WTS connector, then remove WTS.

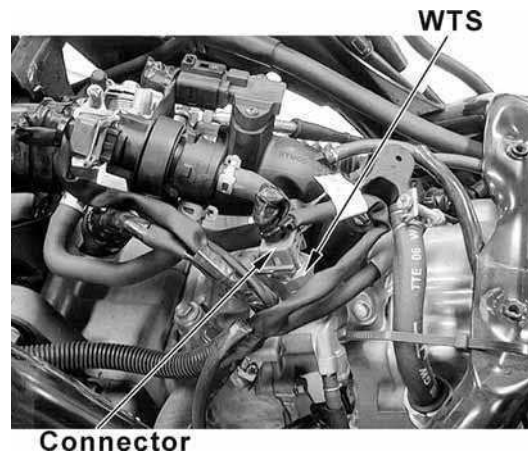

INSTALLATION

Replace a new washer.
Install and tighten the WTS to the specified torque.

Torque: 2 kgf-m (20 N-m, 14 lbf-ft)

Connect the WTS connector.

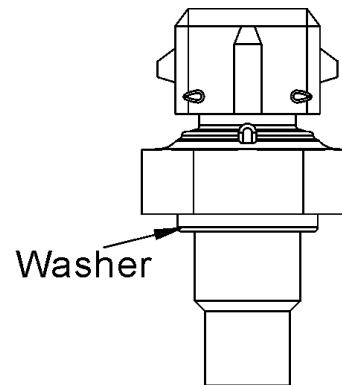

INSPECTION

(Using a commercially available multimeter)

Measure the throttle position sensor resistance.

Standard:

- 703.8±40.9 Ω (60°C)
- 206.7±15.1 Ω (90°C)
- 111.1±7.8 Ω (120°C)

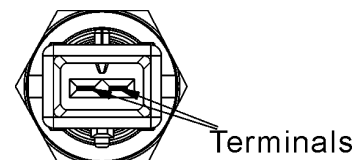

14. DINK 200 i: FUEL SYSTEM (Auto Control Fuel Injection System)

(Using diagnostic tool)

Enter RECEIVE SIGNAL MENU and then read data in page 01 (refer to the “RECEIVE SIGNAL MENU (USING DIAGNOSTIC TOOL)” section in this chapter).

Read the data:

Engine Temp. (°C)

Engine Temp. sensor volt

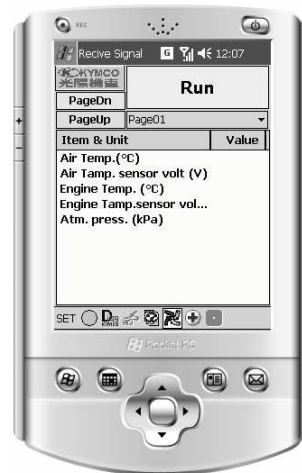

FUEL INJECTOR

REMOVAL

Disconnect the connector from fuel injector.
Remove the bolt, then remove injector and tension seal.

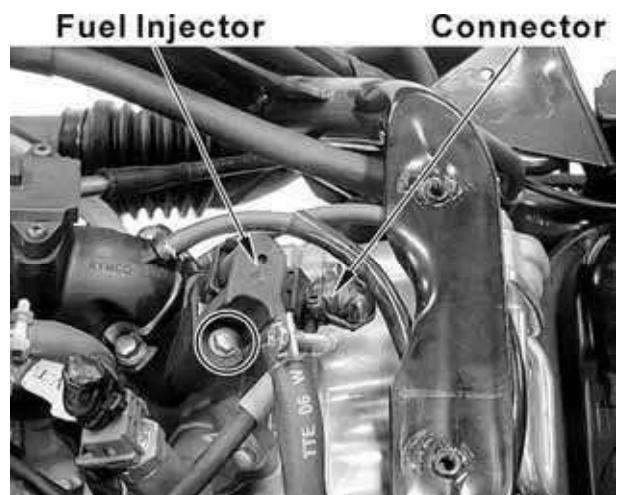

Remove the spring clip and then remove the fuse hose joint.



14. DINK 200i: FUEL SYSTEM (Auto Control Fuel Injection System)

INSTALLATION

*

- Coat O-rings with clean engine oil.
- Replace the new O-rings if it has damaged.

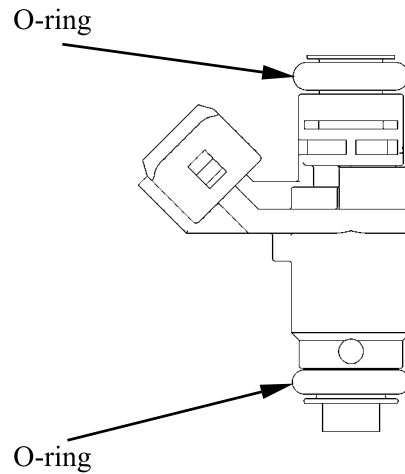

Install fuel hose joint onto the fuel injection.
Install the spring clip into the groove on the fuel injection.

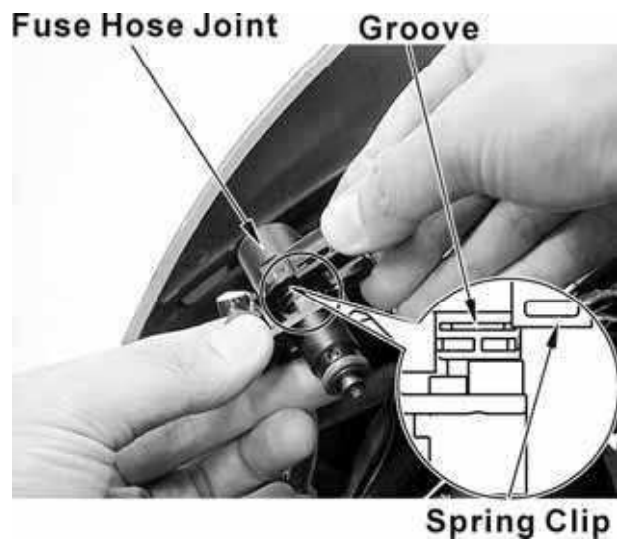

Place the tension seal onto the intake manifold.



14. DINK 200 i: FUEL SYSTEM (Auto Control Fuel Injection System)

Install the fuel injection assembly into the intake manifold.
 Install and tighten the bolt securely.
 Connect the connector.

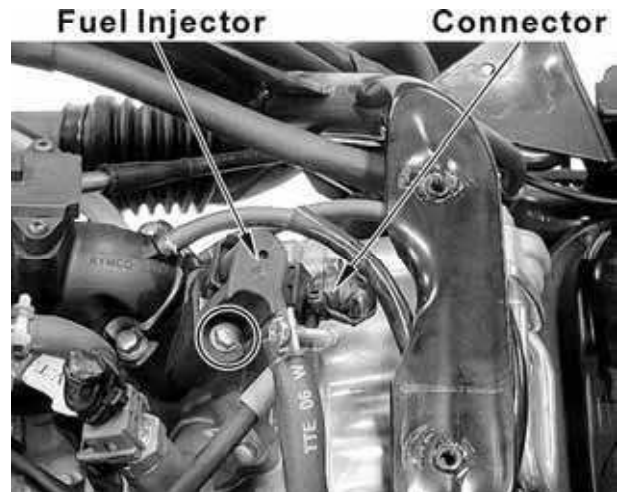

INSPECTION

(Using a commercially available multimeter)

Measure the fuel injection resistance.

Standard: $11.3 \pm 10\% \Omega$ (20°C/68°F)

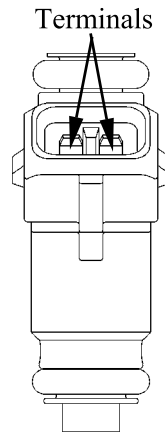

(Using diagnostic tool)

Enter RECEIVE SIGNAL MENU and then read data in page 05 (refer to the “RECEIVE SIGNAL MENU (USING DIAGNOSTIC TOOL)” section in this chapter).

Read the data:
 Injection duration (ms)

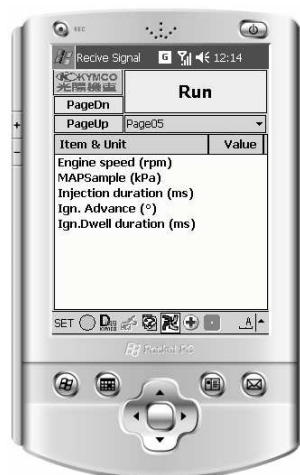

14. DINK 200i: FUEL SYSTEM (Auto Control Fuel Injection System)

FUEL TANK

REMOVAL/INSTALLATION

* When removing the fuel tank, do not allow flames or sparks near the working area and drain the residual gasoline into a container.

Remove the floorboard (refer to the “**FRAME COVERS REMOVAL/INSTALLATION**” section in the chapter 2).

Remove four nuts and fuel tank bridge plate.

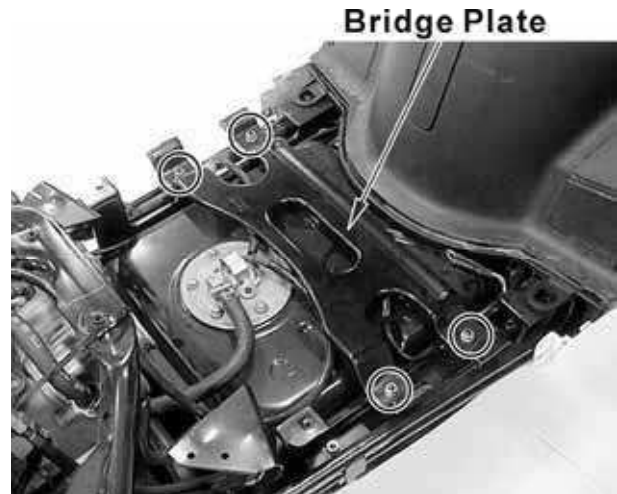

Disconnect the fuel hoses from the fuel pump.

Disconnect the fuel vacuum hose from the intake manifold.

Disconnect fuel pump and fuel unit connectors.

Remove the inner cover (refer to the “**FRAME COVERS REMOVAL/INSTALLATION**” section in the chapter 2).

Remove the right and left fuel tank plate (refer to the “**FUEL TANK**” section in the chapter 13).

Remove the fuel tank.

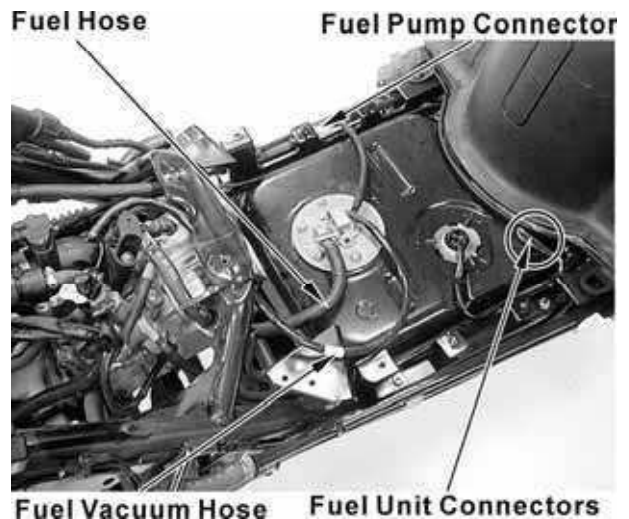

Installation is in the reverse order of removal.

14. DINK 200 i: FUEL SYSTEM (Auto Control Fuel Injection System)

FUEL PUMP

REMOVAL

* When removing the fuel tank, do not allow flames or sparks near the working area and drain the residual gasoline into a container.

Remove the floorboard (refer to the “**FRAME COVERS REMOVAL/INSTALLATION**” section in the chapter 2).

Remove four nuts and fuel tank bridge plate.

Disconnect the fuel hoses from the fuel pump.

Disconnect the fuel vacuum hose from the intake manifold.

Disconnect fuel pump connector.

Remove six bolts.

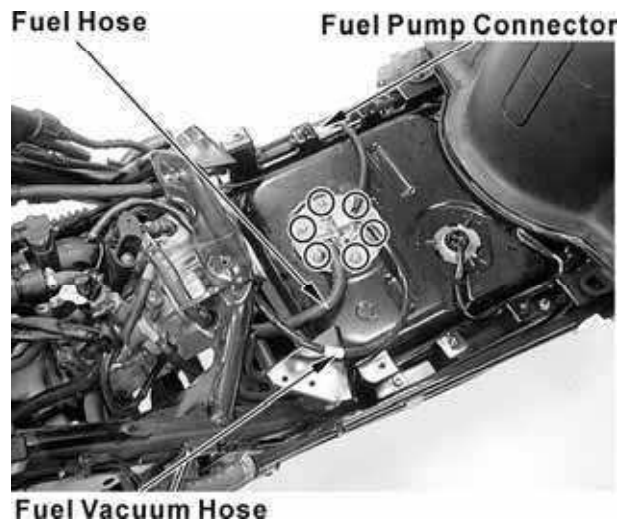
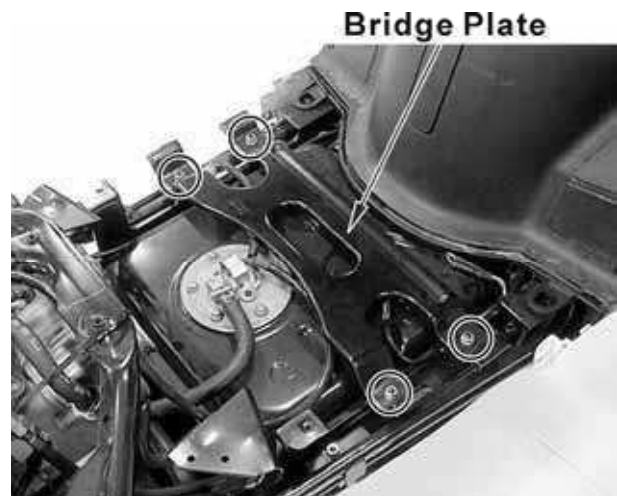

Remove the fuel pump by using two screwdrivers as shown.

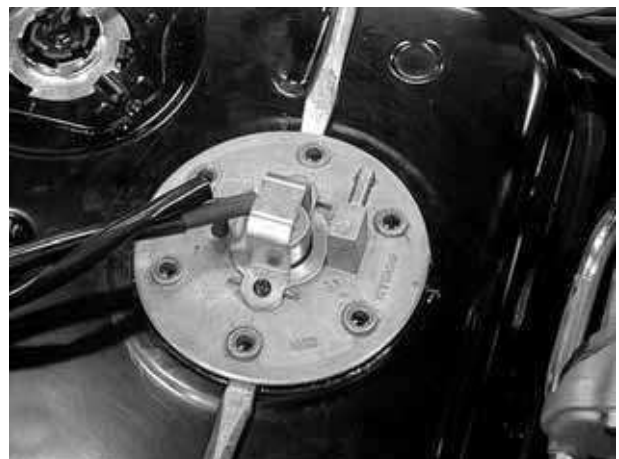

14. DINK 200i: FUEL SYSTEM (Auto Control Fuel Injection System)

INSTALLATION

Install the fuel pump being careful not to damage the fuel pump wire and make sure the fuel hose joint on fuel pump facing rear.
Tighten the bolts using crisscross pattern.
Connect the fuel hose, fuel vacuum hose and fuel pump connector.



INSPECTION

Inspect the O-ring for damage.
Inspect the fuel strainer for clogged or damage.
Inspect the each wire for wear.
Inspect the each wire lead for loose or disconnected.



14. DINK 200 i: FUEL SYSTEM (Auto Control Fuel Injection System)

(Using a commercially available multimeter)

Input voltage

Put the side stand up and the engine stop switch is at “RUN”

Disconnect the fuel pump connector.
Connect the multi-meter (+) probe to the Red/Black terminal and the multi-meter (-) probe to the Green terminal.

Turn the ignition switch to “ON” and measure the voltage between the terminals.
There should be battery voltage for a few seconds.

If there is battery voltage, replace the fuel pump.

If there is no battery voltage, inspect the following:

- Fuse (20 A)
- Fuel pump relay
- ECU

Resistance

Measure the fuel pump resistance.

Standard: $1 \pm 0.2 \Omega$ (20°C/68°F)



14. DINK 200i: FUEL SYSTEM (Auto Control Fuel Injection System)

INSPECTION

(Using diagnostic tool)

Enter RECEIVE SIGNAL MENU and then read data in page 07 (refer to the “RECEIVE SIGNAL MENU (USING DIAGNOSTIC TOOL)” section in this chapter).

Read the data:

Fuel pump state

When the engine is stopping, check the “Fuel pump state” is OFF.

When the engine is running, check the “Fuel pump state” is ON.

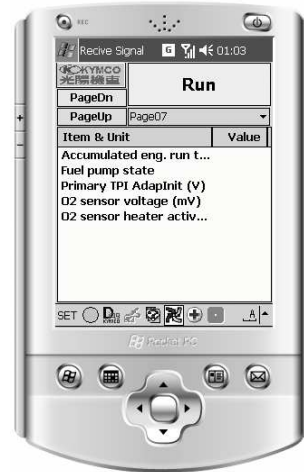

14. DINK 200 i: FUEL SYSTEM (Auto Control Fuel Injection System)

FUEL PUMP RELAY

REMOVAL/INSTALLATION

Disconnect the fuel pump relay connector, then remove the fuel pump relay.

Installation is in the reverse order of the removal.



INSPECTION

Remove the fuel pump relay.
Connect the ohmmeter to the fuel pump relay connector terminals.

Connection: Red – Red/Black

Connect the 12 V battery to the following fuel pump relay connector terminals

Connection: Black/White – Black/Red

There should be continuity only when the 12 V battery is connected.

If there is no continuity when the 12 V battery is connected, replace the fuel pump relay.

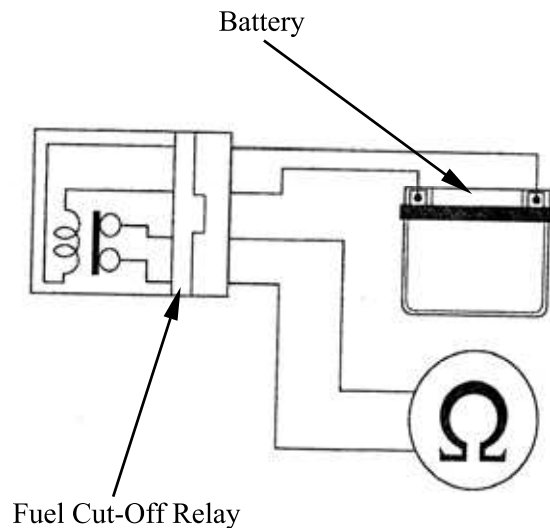

14. DINK 200i: FUEL SYSTEM (Auto Control Fuel Injection System)

O₂/O₂ HT SENSOR

REMOVAL/INSTALLATION

Disconnect the O₂/O₂ HT sensor connector, then remove it from exhaust muffler.

Installation is in the reverse order of removal.

* Apply anti-seize compound on circumference of thread area before O₂/O₂ HT sensor installation.

Tighten the O₂/O₂ HT sensor to specified torque.

Torque: 2.5 kgf-m (25 N-m, 18 lbf-ft)

O₂ sensor data should be outputted only when its temperature over 350°C.

O₂ heater heat O₂ sensor to over 350°C earlier than exhaust muffler.

The data of O₂ sensor is one of the data that control fuel injector operation.

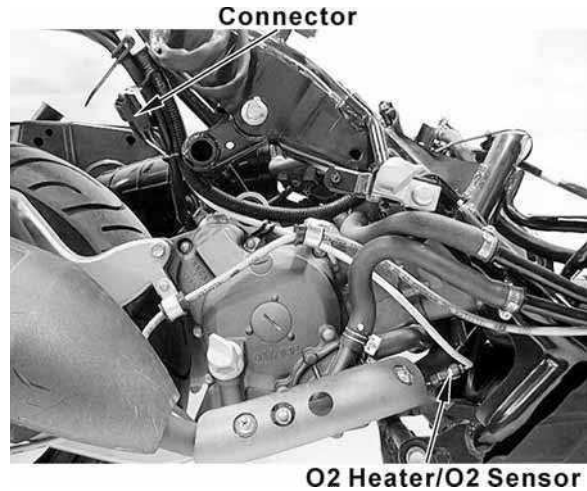

INSPECTION

(Using a commercially available multimeter)

Disconnect the O₂/O₂ HT sensor connector.

Measure the resistance between each White wire terminals of the O₂/O₂ HT sensor side connector.

Standard: 7.7±1.2 Ω (at 20°C/68°F)

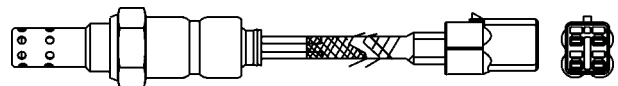

14. DINK 200 i: FUEL SYSTEM (Auto Control Fuel Injection System)

(Using diagnostic tool)

Enter RECEIVE SIGNAL MENU and then read data in page 07 (refer to the “RECEIVE SIGNAL MENU (USING DIAGNOSTIC TOOL)” section in this chapter).

Read the data:

- O2 sensor voltage (mV)
- O2 sensor heater activation

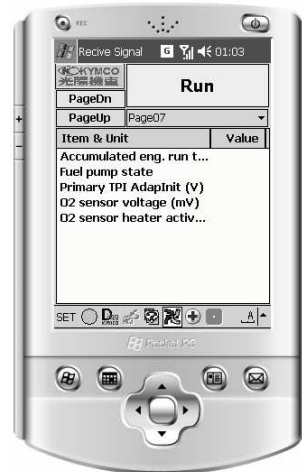

14. DINK 200i: FUEL SYSTEM (Auto Control Fuel Injection System)

ANGLE DETECT SENSOR

REMOVAL/INSTALLATION

Support the scooter level surface.
 Remove the front cover (refer to the “**FRAME COVERS REMOVAL/INSTALLATION**” section in the chapter 2).

Disconnect the angle detect sensor connector.
 Remove the two screws, washers and angle detect sensor.

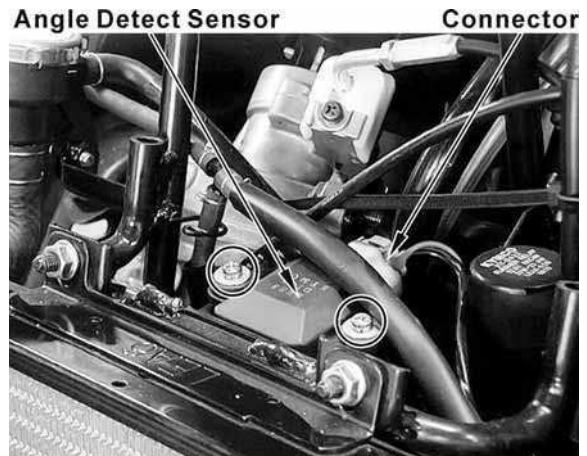

Installation is in the reverse order of the removal.

INSPECTION

The engine should stop as you incline the bank angle sensor approximately degrees to the left or right.

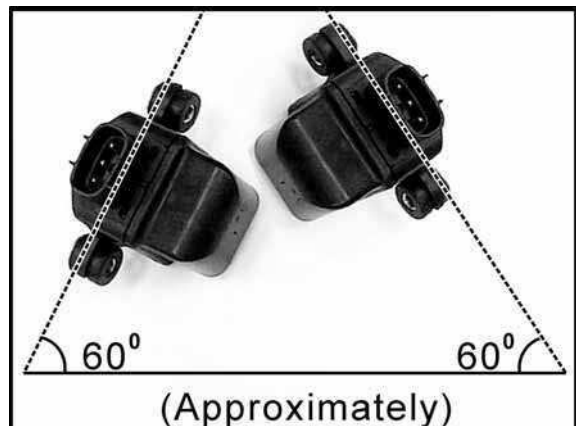

(Using diagnostic tool)

Enter RECEIVE SIGNAL MENU and then read data in page 04 (refer to the “**RECEIVE SIGNAL MENU (USING DIAGNOSTIC TOOL)**” section in this chapter).

Read the data:

Cut Out switch volt (V)

Standard:

Normal: 3.5~4.7V

±60° angle position: 0.3~1.4V

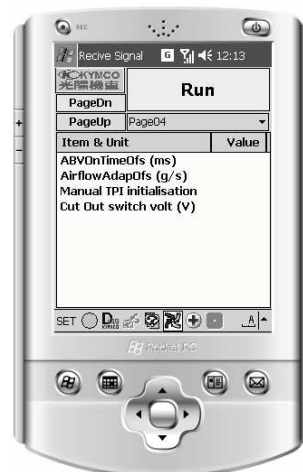

14. DINK 200 i: FUEL SYSTEM (Auto Control Fuel Injection System)

AIR CLEANER HOUSING

REMOVAL/INSTALLATION

Refer to the “**AIR CLEANER**” section in the chapter 13.

**HANDLEBAR/FRONT WHEEL/FRONT BRAKE/
FRONT SHOCK ABSORBER/STEERING STEM**

SCHEMATIC DRAWING -----	15- 1
SERVICE INFORMATION-----	15- 2
TROUBLESHOOTING-----	15- 3
HANDLEBAR -----	15- 4
FRONT WHEEL -----	15- 8
FRONT BRAKE FLUID-----	15-12
FRONT BRAKE PAD -----	15-16
BRAKE DISC INSPECTION -----	15-18
BRAKE MASTER CYLINDER -----	15-19
FRONT BRAKE CALIPER -----	15-24
FRONT SHOCK ABSORBER-----	15-28
STEERING STEM-----	15-29

15. HANDLEBAR/FRONT WHEEL/FRONT BRAKE/
FRONT SHOCK ABSORBER/STEERING STEM

SCHEMATIC DRAWING

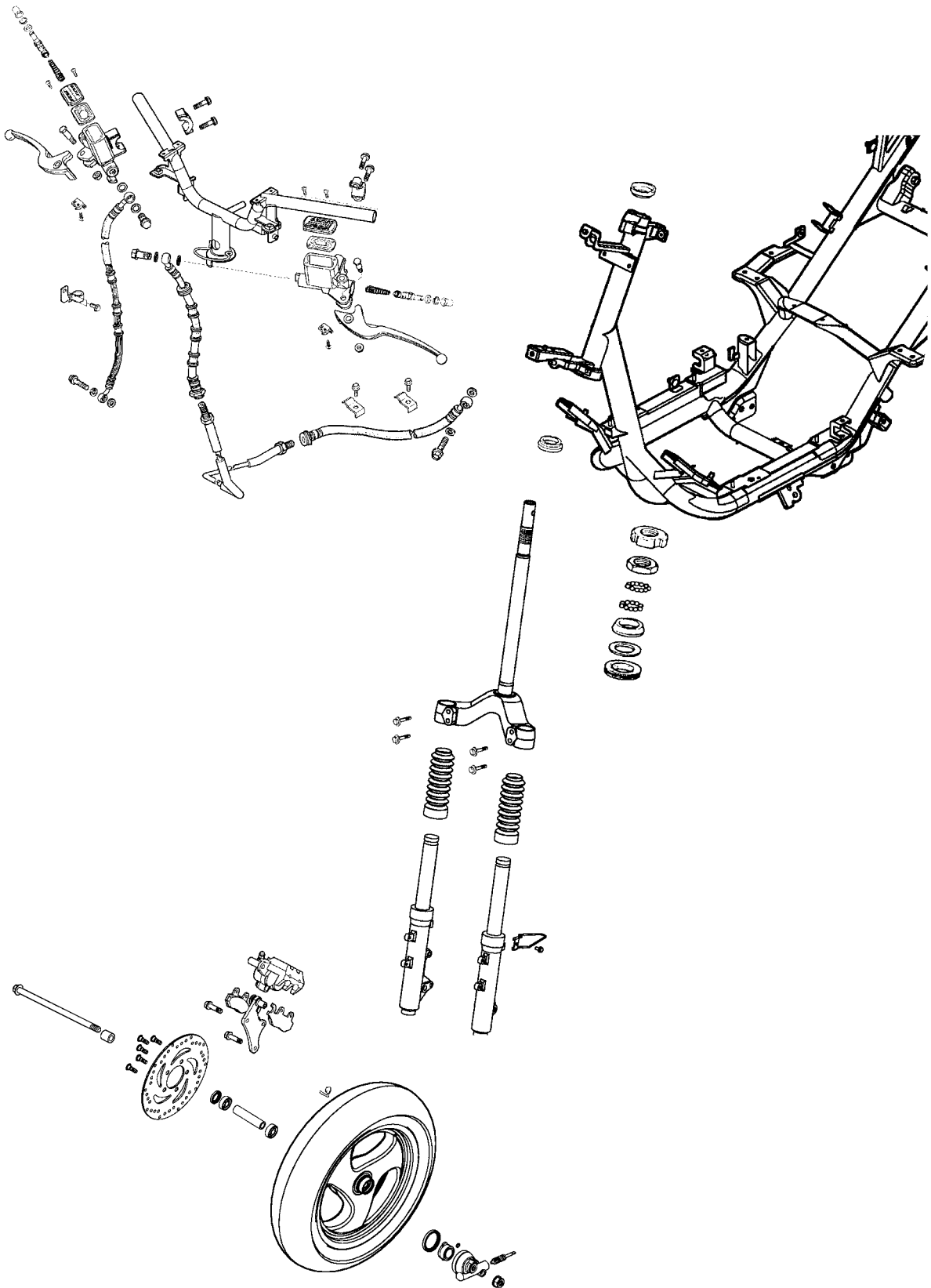

SERVICE INFORMATION

GENERAL INSTRUCTIONS

- Remove the motorcycle frame covers before removing the front wheel, steering handlebar, front shock absorber and front fork. Jack the motorcycle front wheel off the ground and be careful to prevent the motorcycle from falling down.
- During servicing, keep oil or grease off the brake pads and brake disk.

SPECIFICATIONS

Unit: mm (in)

Item	Standard	Service Limit
Axle shaft runout	—	0.2 (0.008)
Front wheel rim runout	Radial	2 (0.08)
	Axial	2 (0.08)
Brake disk thickness	3.5~4.2 (0.14~0.168)	3 (0.12)
Brake disk runout	—	0.3 (0.012)
Brake master cylinder I.D.	12.7~12.74 (0.508~0.5096)	12.75 (0.51)
Brake master cylinder piston O.D.	12.65~12.68 (0.506~0.5072)	12.64 (0.5056)
Brake caliper piston O.D.	25.33~25.36 (1.0132~1.0144)	25.3 (1.012)
Brake caliper cylinder I.D.	25.4~25.45 (1.016~1.018)	25.45 (1.018)

TORQUE VALUES

Handlebar lock nut	45 N•m (4.5 kgf•m, 32 lbf•ft)
Steering stem lock nut	80 N•m (8 kgf•m, 58 lbf•ft)
Steering stem pinch bolt	32 N•m (3.2 kgf•m, 23 lbf•ft)
Front axle nut	60 N•m (6 kgf•m, 43 lbf•ft)
Master cylinder reservoir cover screw	2 N•m (0.2 kgf•m, 1.4 lbf•ft)
Master cylinder holder bolt	12 N•m (1.2 kgf•m, 9 lbf•ft)
Brake lever pivot bolt	2 N•m (0.2 kgf•m, 1.4 lbf•ft)
Brake lever pivot nut	10 N•m (1 kgf•m, 7.2 lbf•ft)
Brake light switch screw	1 N•m (0.1 kgf•m, 0.7 lbf•ft)
Brake caliper mounting bolt	27 N•m (2.7 kgf•m, 19 lbf•ft)
	ALOC bolt: replace with a new one.
Brake caliper bleed screw	6 N•m (0.6 kgf•m, 4.3 lbf•ft)
Brake pad pin	18 N•m (1.8 kgf•m, 13 lbf•ft)
Brake hose oil bolt	35 N•m (3.5 kgf•m, 25 lbf•ft)

SPECIAL TOOLS

Lock nut wrench	A120F00002
Oil seal and bearing installer	A120E00014
Bearing piller	A120E00037

TROUBLESHOOTING

Hard steering (heavy)

- Excessively tightened steering stem top cone race
- Broken steering balls
- Insufficient tire pressure

Steers to one side or does not track straight

- Uneven front shock absorbers
- Bent front fork
- Bent front axle or uneven tire

Poor brake performance

- Worn brake pads
- Contaminated brake pad surface
- Deformed brake disk
- Air in brake system
- Deteriorated brake fluid
- Worn brake master cylinder piston oil seal
- Clogged brake fluid line
- Unevenly worn brake caliper

Front wheel wobbling

- Bent rim
- Loose front axle
- Bent spoke plate
- Faulty tire
- Improperly tightened axle nut

Soft front shock absorber

- Weak shock springs
- Insufficient damper oil

Front shock absorber noise

- Slider bending
- Loose fork fasteners
- Lack of lubrication

HANDLEBAR

REMOVAL

Remove the lower handlebar cover and front cover (refer to the “**FRAME COVERS REMOVAL/INSTALLATION**” section in the chapter 2).

Remove the two bolts (1) and disconnect the brake light switch wire (2), then remove the rear brake master cylinder.

Remove the two bolts (3) and disconnect the brake light switch wire (4), then remove the front brake master cylinder.

Remove the inner cover (refer to the “**FRAME COVERS REMOVAL/INSTALLATION**” section in the chapter 2).

Disconnect the right and left handlebar switch connectors (5).

Remove the handlebar lock nut (6) and take out the bolt (7).

Remove the handlebar and collar (8).

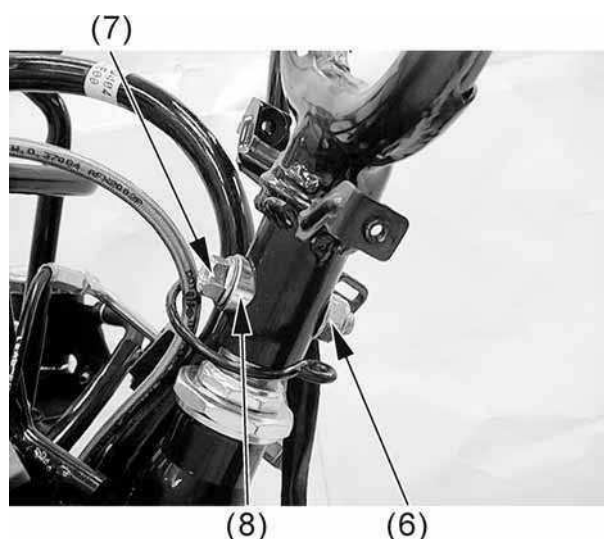
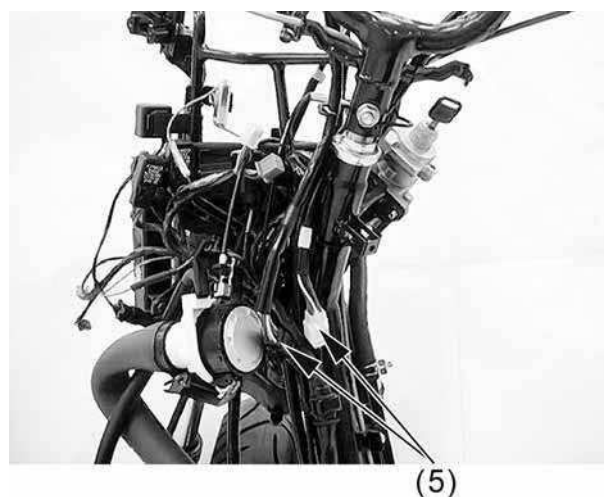
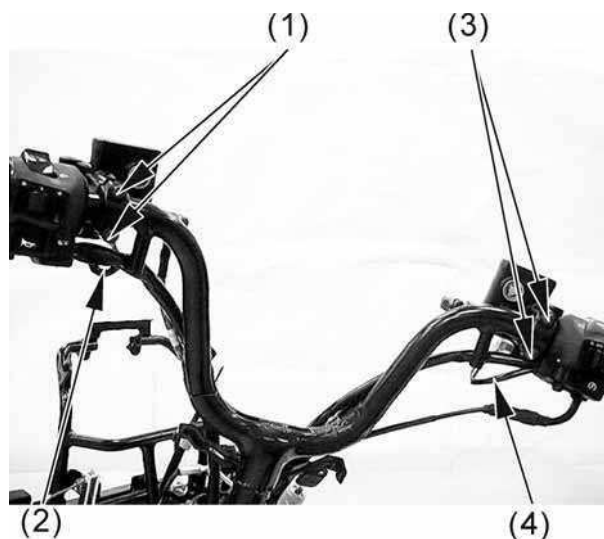

INSTALLATION

Install the handlebar onto the steering stem and install the handlebar collar, lock nut and bolt.

Tighten the bolt to the specified torque.

Torque: 4.5 kgf-m (45 N-m, 32 lbf-ft)



Connect the right and left handlebar switch connectors.



Install the front and rear master cylinders and connect the brake light switch wires (refer to the “**BRAKE MASTER CYLINDER**” section in this chapter and chapter 15).

* Adjust the throttle grip free play to the specified range of 2~6 mm (0.08~0.24 in).

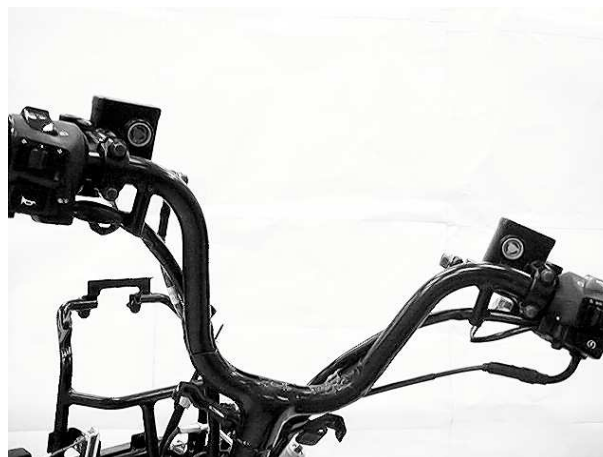

DISASSEMBLY

Remove the two screws (1) from right handlebar switch.



Disconnect the throttle cable (2) from the throttle grip.
Remove the right handlebar switch.

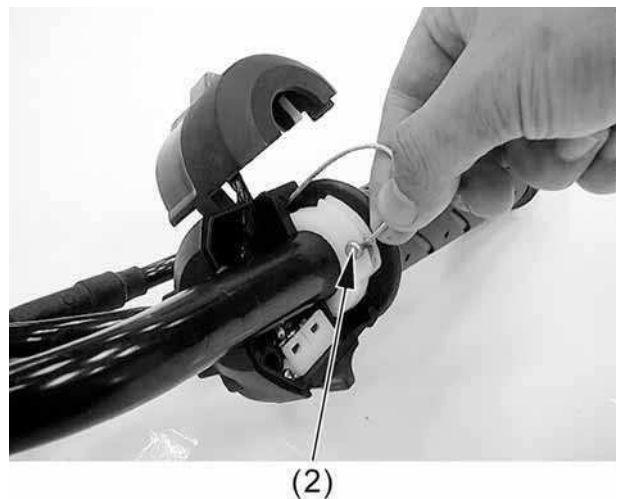

Remove the two screws (3) and then remove the left handlebar switch.

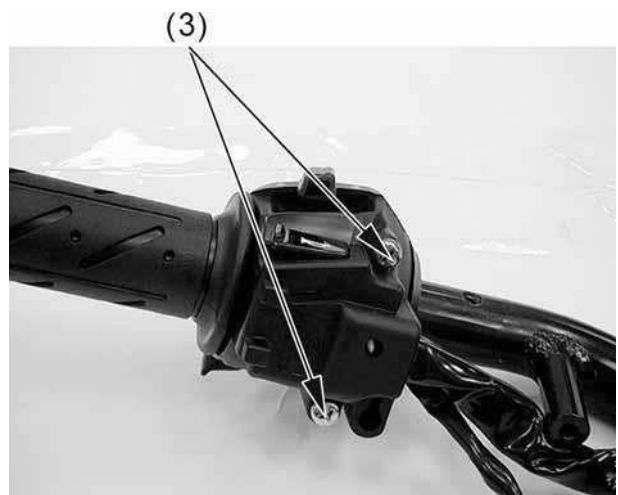

ASSEMBLY

Install the left handlebar switch.

- * Align the pin on the left handlebar switch with the hole on the handlebar.

Install and tighten the two screws securely.



Install the right handlebar switch.

- * Align the pin on the right handlebar switch with the hole on the handlebar.



Lubricate the throttle grip front end with grease and then connect the throttle cable to the throttle grip.

Install and tighten the two screws.



FRONT WHEEL

REMOVAL

Jack the scooter front wheel off the ground.
Remove the nut (1), then pull out the axle (2).
Remove the front wheel and collar.

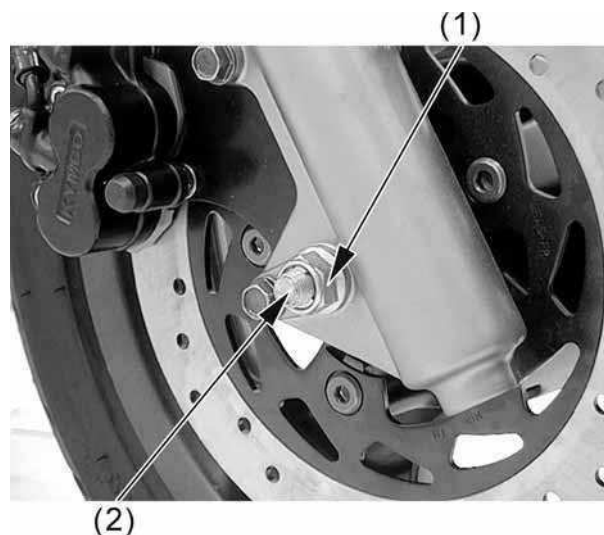

Axle runout inspection

Set the axle in V blocks and measure the runout using a dial gauge.
The actual runout is 1/2 of the total indicator reading.

Service Limit: 0.2 mm (0.008 in)

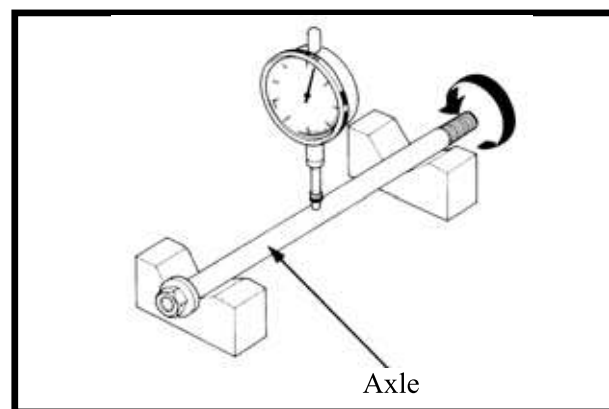

Wheel rim inspection

Check the wheel rim runout.

Service Limits:

Radial: 2 mm (0.08 in)

Axial: 2 mm (0.08 in)

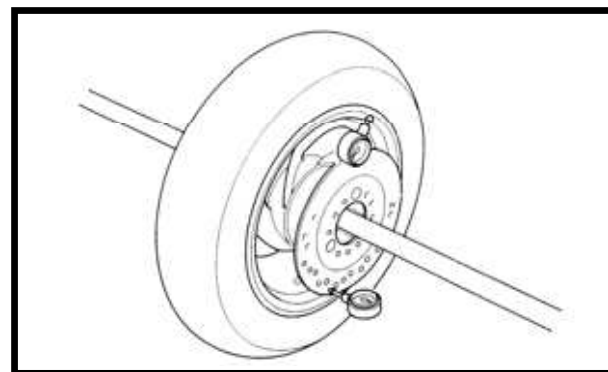

INSTALLATION

Apply grease to the collar (1), then install the collar onto the wheel.

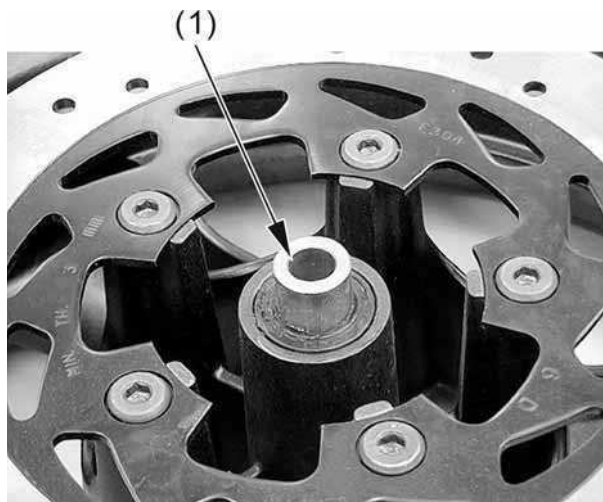

Apply grease to the speedometer gear unit (2).
Install the speedometer gear unit by aligning its retaining pawl with the hub cutout.

* If not aligned, the retaining pawl will be deformed when the axle nut is tightened.

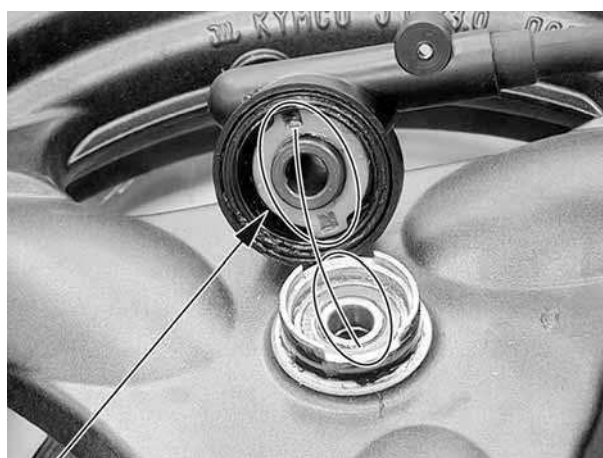

(2)

Install the front wheel by aligning the speedometer gear unit groove with the front shock absorber tab.

Insert the axle and tighten the axle nut to the specified torque.

* When installing the front wheel, position the brake disk between the two brake pads.



Torque: 6 kgf-m (60 N-m, 43 lbf-ft)

DISASSEMBLY

Remove the side collar (1) and dust seal (2).

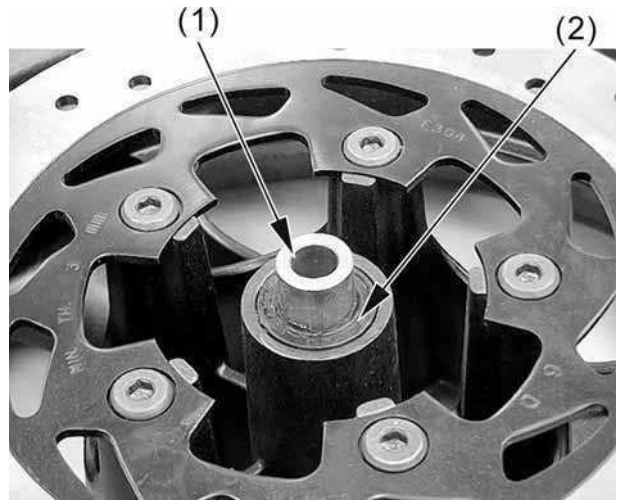

Turn the inner race of each bearing with your finger to see if they turn smoothly and quietly. Also check if the outer race fits tightly in the hub.

Replace the bearings if the races do not turn smoothly, quietly, or if they fit loosely in the hub.



Remove the front wheel bearing (3) by using the special tool.

Special tool:

Bearing puller A120E00037

Remove the distance collar (4) from wheel.

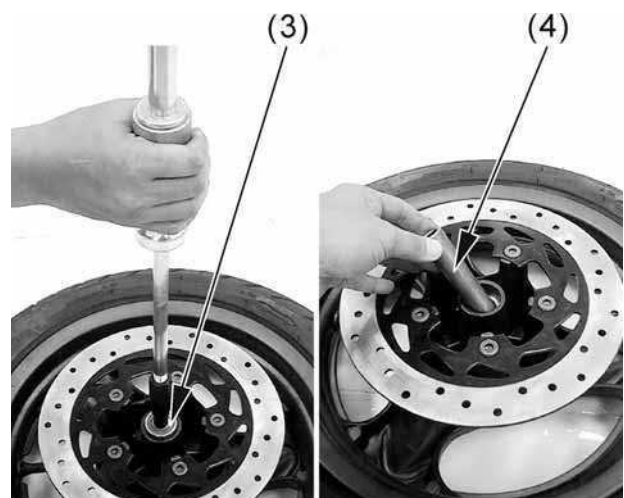

15. HANDLEBAR/FRONT WHEEL/FRONT BRAKE/ FRONT SHOCK ABSORBER/STEERING STEM

Remove the front wheel bearing (5) by using the special tool.

Special tool:

Bearing puller A120E00037

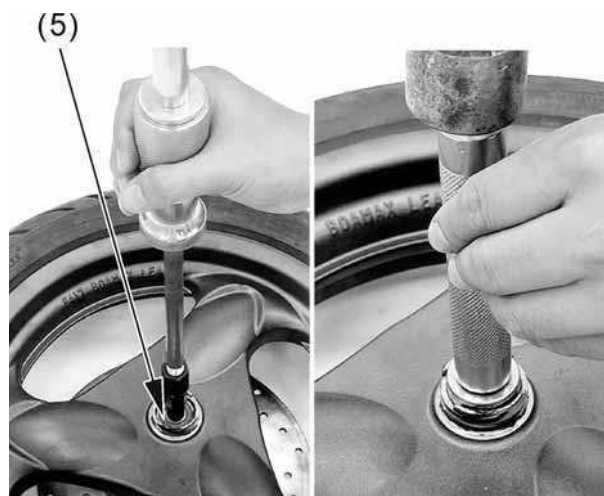

ASSEMBLY

Install the front wheel bearing (5) by using the special tool.

Special tool:

Bearing installer A120E00014

Install the distance collar.

Install the front wheel bearing (5) by using the special tool.

Special tool:

Bearing installer A120E00014



Apply grease to the collar, then install the collar onto the wheel.



FRONT BRAKE FLUID

Check

Brake fluid:

Brake hose:

Cracks/wear/damage → Replace.

Apply the brake lever several times.

Fluid leakage → Replace.

Brake hose clamp:

Loosen → Tighten

FLUID REPLACEMENT/AIR BLEEDING

- A contaminated brake disc or pad reduces stopping power. Discard contaminated pads and clean a contaminated disc with a high quality brake degreasing agent.
- Do not allow foreign material to enter the system when filling the reservoir.
- Avoid spilling brake fluid on painted, plastic or rubber parts. Place a rag over these parts whenever the system is serviced.

Once the hydraulic system has been opened, or if the brake feels spongy, the system must bled. When using a commercially available brake bleeder, follow the manufacturer's operating instructions.

15. HANDLEBAR/FRONT WHEEL/FRONT BRAKE/ FRONT SHOCK ABSORBER/STEERING STEM

Brake fluid draining

Make sure that the master cylinder parallel to the ground, before removing the reservoir cover.

Remove the two screws (1).



Remove the reservoir cover (2), diaphragm plate (3) and diaphragm (4).

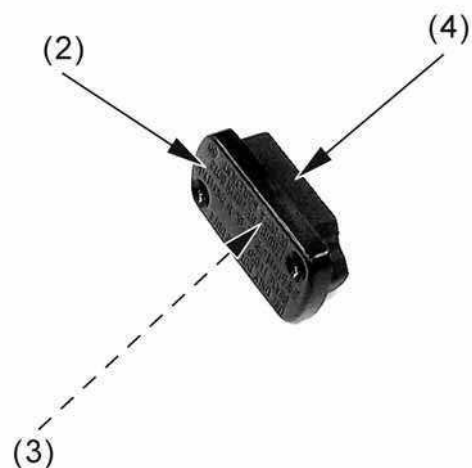

Connect a bleed hose (5) to the bleed valve (6).

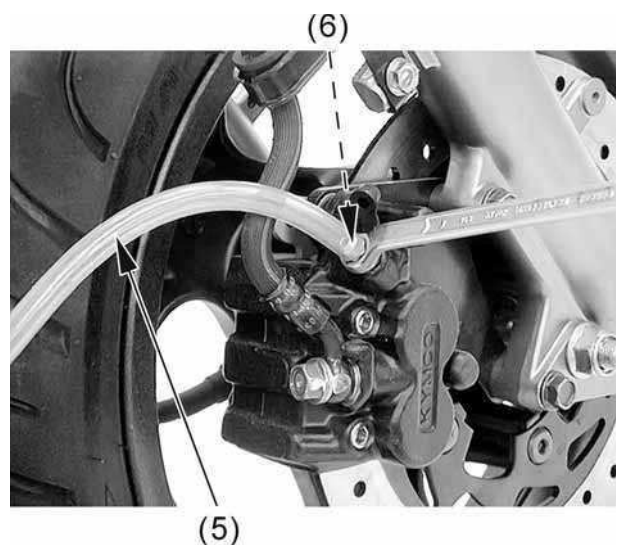

Loosen the bleed valve and pump the brake lever.
Stop operating the brake when no more fluid flows out of the bleed valve.

Brake fluid filling/Air bleeding

* Do not mix different types of fluid since they are not compatible.

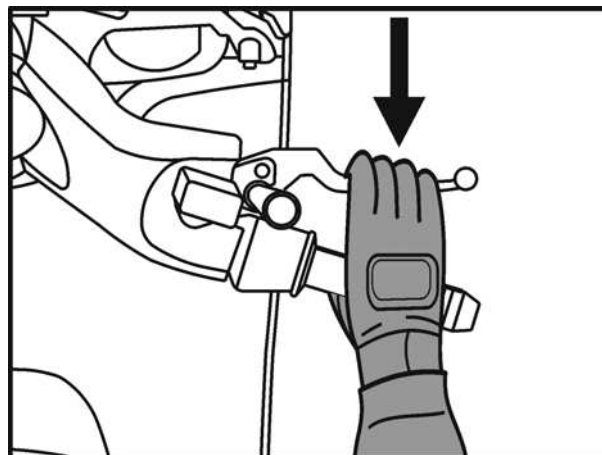

Fill the master cylinder with DOT 4 brake fluid to the upper level.

Connect a commercially available brake bleeder to the front caliper bleed valve.

Check the fluid level often while bleeding the brake to prevent air from being pumped into the system.

When using a brake bleeding tool, follow the manufacture's operating instructions.

* If air enters the bleeder from around the bleed valve threads, seal the threads with teflon tape.

Pump the brake bleeder and loosen the front caliper bleed valve. Add fluid when the fluid level in the master cylinder is low to prevent drawing air into the system.

Repeat the above procedures until no air bubbles appear in the plastic hose.

Close the front caliper bleed valve and operate the front brake lever.

If it still spongy, bleed the system again.

If the brake bleeder is not available, perform the following procedure.

Pump up the system pressure with the brake lever until there are no air bubbles in the fluid flowing out of the reservoir small hole and lever resistance is felt.

1. Pump the brake lever several times, then squeeze the brake lever all the way and loosen the bleed valve 1/4 turn. Wait several seconds and close the bleed valve.

* Do not release the brake lever until the bleed valve has been closed.

2. Release the brake lever slowly until the bleed valve has been closed. Add fluid when the fluid level in the master cylinder is low to prevent drawing air into the system.
3. Repeat the steps 1 - 2 until there are no air bubbles in the bleed hose.

After bleeding air completely, tighten the bleed valve to the specified torque.

Torque: 6 N•m (0.6 kgf•m, 4.3 lbf•ft)

Fill the reservoir to the casting ledge with DOT 4 brake fluid to the upper level.

Install the diaphragm, set plate and reservoir cover and tighten the screws to the specified torque.

Torque: 2 N•m (0.2 kgf•m, 1.1 lbf•ft)

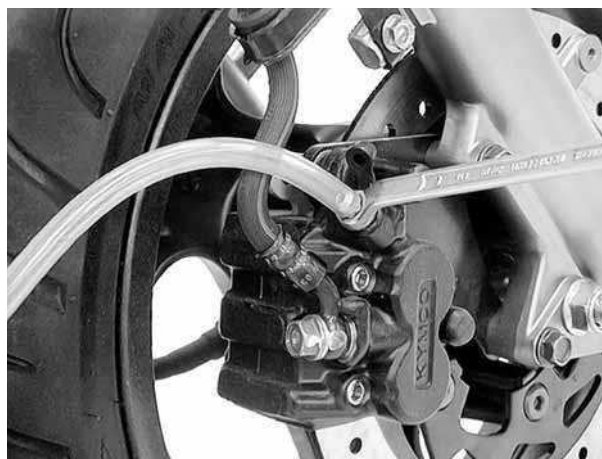
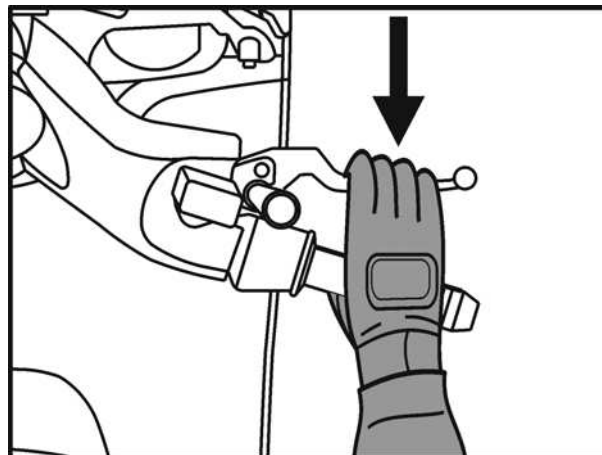

FRONT BRAKE PAD

BRAKE PAD REPLACEMENT

Remove the two pad pins (1).
Remove the two caliper mounting bolts (2),
then remove the caliper.

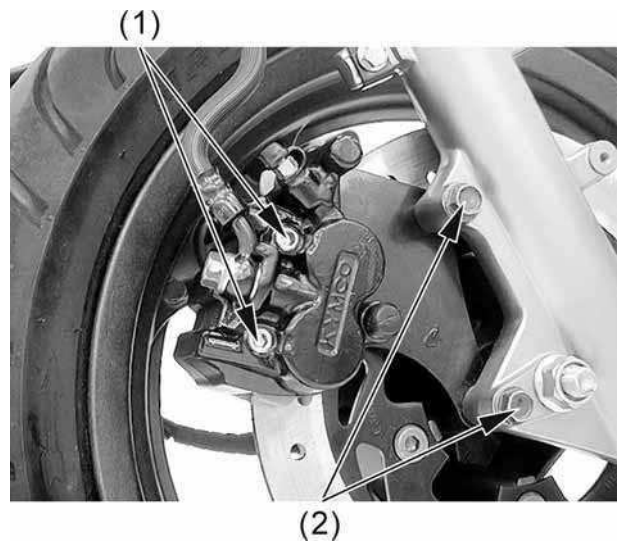

Remove the brake pads.

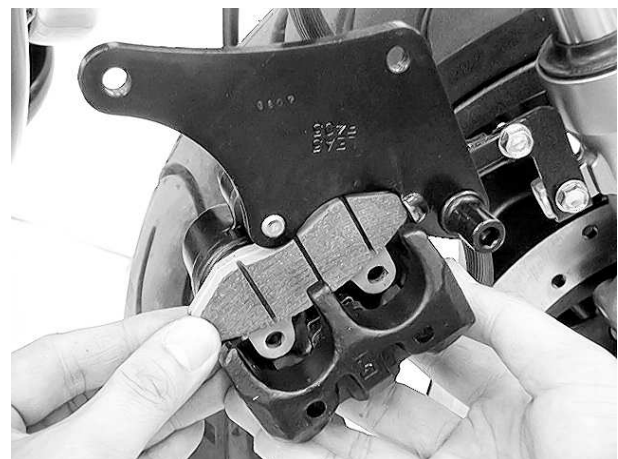
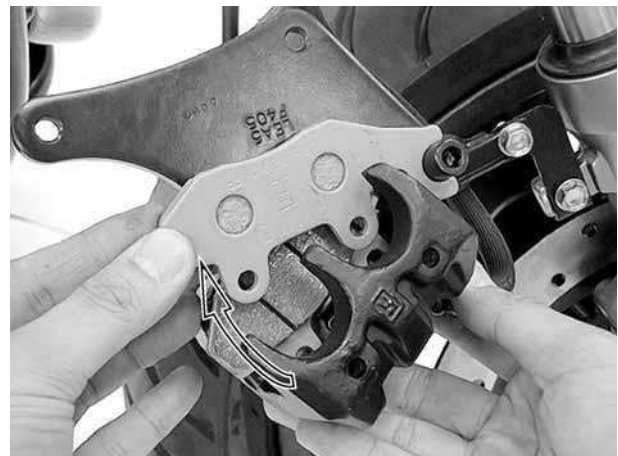

* Always replace the brake pads in pairs to ensure even disc pressure.

Install new pads so that their ends rest on the pad retainer on the brake properly.

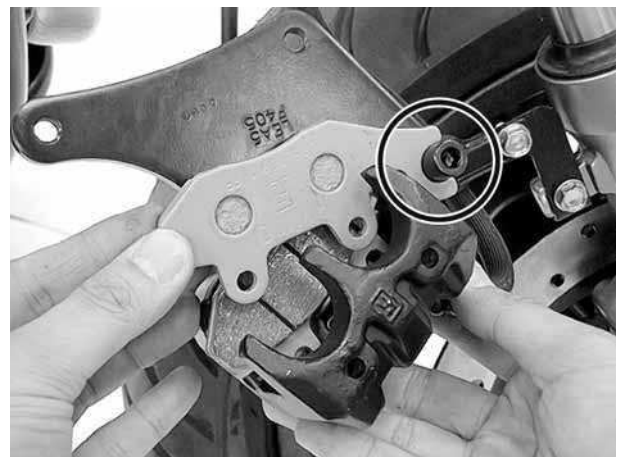
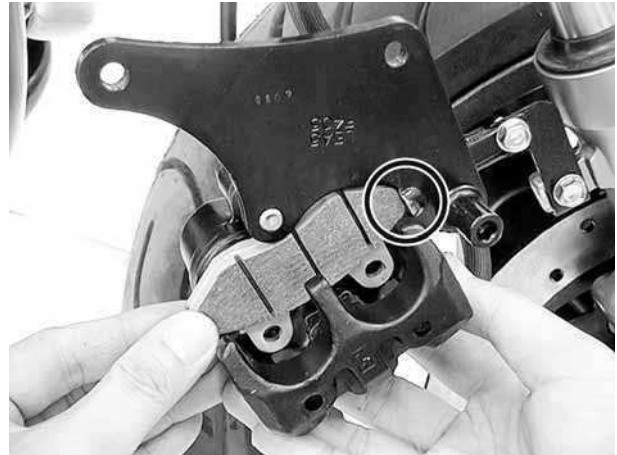

Install the pad pin by pushing the pads against the pad spring to align the pad pin holes in the pads and caliper.

Install the front caliper onto the fork leg and then install and tighten the new two caliper mounting bolts to the specified torque.

Torque: 27 N-m (2.7 kgf-m, 19 lbf-ft)

Tighten the two pad pins to the specified torque.

Torque: 18 N-m (1.8 kgf-m, 13 lbf-ft)



BRAKE DISC INSPECTION

Visually inspect the brake disc for damage or cracks.

Measure the brake disc thickness.

Service limits: 3 mm (0.12 in)

Replace the brake disc if the smallest measurement is less than the service limit.

Measure the brake disc warpage.

Service limits: 0.3 mm (0.012 in)



BRAKE MASTER CYLINDER

REMOVAL

When removing the brake hose bolt, cover the end of the hose to prevent contamination. Secure the hose to prevent fluid from leaking out.

Remove the upper handlebar cover (refer to the “**FRAME COVERS REMOVAL/INSTALLATION**” section in the chapter 2).

Drain the front brake hydraulic system (refer to the “**FRONT BRAKE FLUID**” section in this chapter).

Remove the brake lever pivot bolt (1) and nut (2), then remove the brake lever.

Disconnect the brake light switch connectors (3).

Remove the brake hose oil bolt (4), sealing washer and brake hose eyelet.

Remove the two bolts (5) from the master cylinder holder and remove the master cylinder assembly.

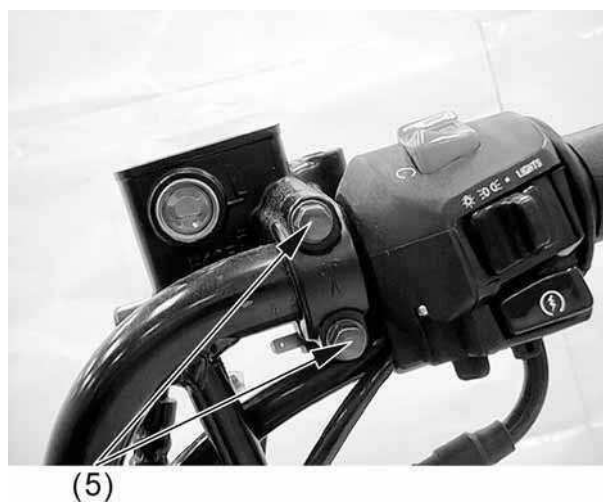
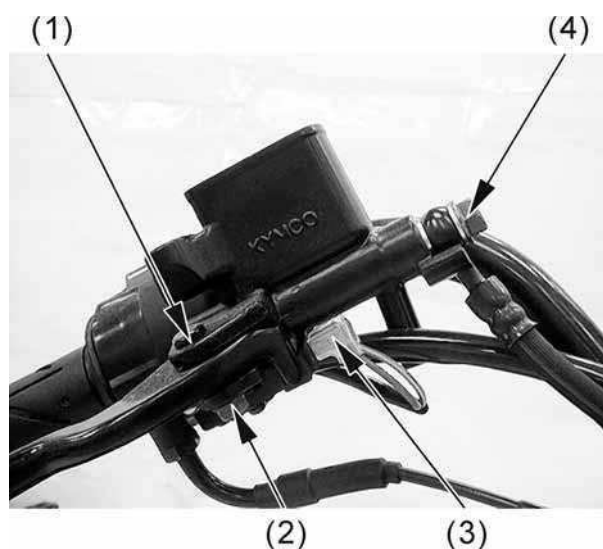

15. HANDLEBAR/FRONT WHEEL/FRONT BRAKE/ FRONT SHOCK ABSORBER/STEERING STEM

Remove the screw (6) and brake light switch.

INSTALLATION

Install the brake light switch and tighten the screw to the specified torque.

Torque: 1 N•m (0.1 kgf•m, 0.7 lbf•ft)

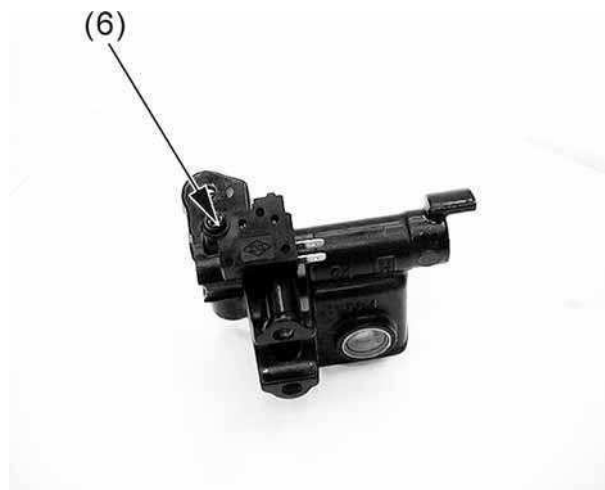

Align the pin on the master cylinder holder with the hole on the handlebar.



Install the front master cylinder and holder with the “UP” mark facing up.

Install the bolts and tighten the upper bolt first then tighten the lower bolt to the specified torque.

Torque: 12 N•m (1.2 kgf•m, 9 lbf•ft)



15.HANDLEBAR/FRONT WHEEL/FRONT BRAKE/ FRONT SHOCK ABSORBER/STEERING STEM

Rest the brake hose eyelet against the stopper.
Install the brake hose eyelet with the oil bolt
and new sealing washers.
Tighten the oil bolt to the specified torque.

Torque: 35 N•m (3.5 kgf•m, 25 lbf•ft)

Apply silicone grease to the master piston tip.
Install the brake lever.

Apply silicone grease to the brake lever pivot
bolt sliding surface.
Install and tighten the pivot bolt to the
specified torque.

Torque: 2 N•m (0.2 kgf•m, 1.4 lbf•ft)

Install and tighten the pivot nut to the
specified torque.

Torque: 10 N•m (1 kgf•m, 7.2 lbf•ft)

Connect the brake light switch connectors.

Fill the reservoir to the upper level and bleed
the brake system (refer to the “**FRONT
BRAKE FLUID**” section in this chapter).

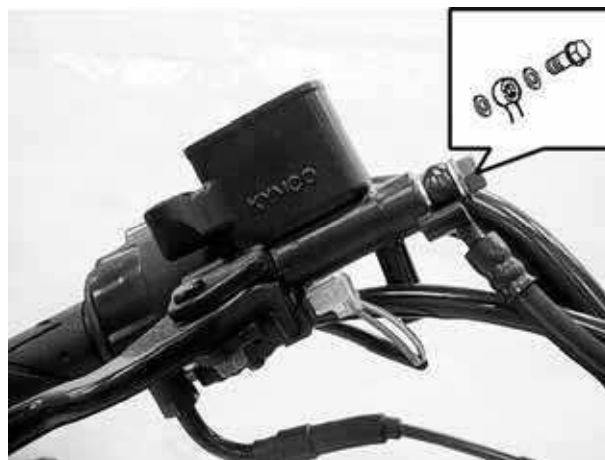

DISASSEMBLY

Remove the piston rubber cover and snap ring from the brake master cylinder.

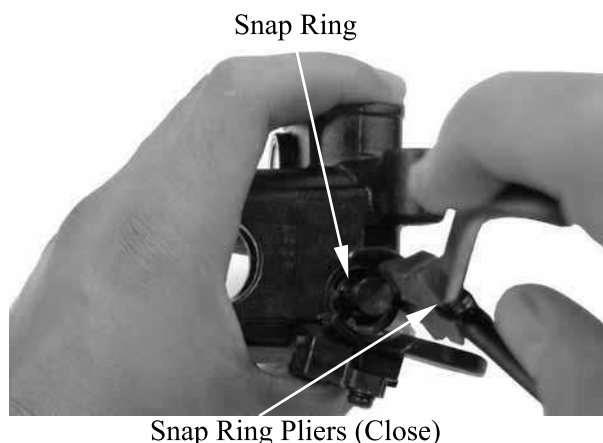

Remove the washer, main piston and spring from the brake master cylinder.
Clean the inside of the master cylinder and brake reservoir with brake fluid.

ASSEMBLY

Before assembly, apply brake fluid to all removed parts.
Install the spring together with the 1st rubber cup.

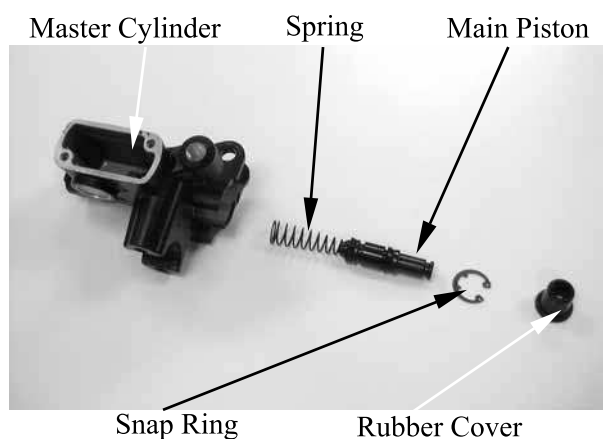

- ***
- During assembly, the main piston and spring must be installed as a unit without exchange.
 - When assembling the piston, soak the cups in brake fluid for a while.
 - Install the cups with the cup lips facing the correct direction.

Install the main piston, spring and new snap ring.
Install the new rubber cover.

INSPECTION

Measure the brake master cylinder I.D.
Inspect the master cylinder for scratches or
cracks.

Service Limit: 12.75 mm (0.5 in)

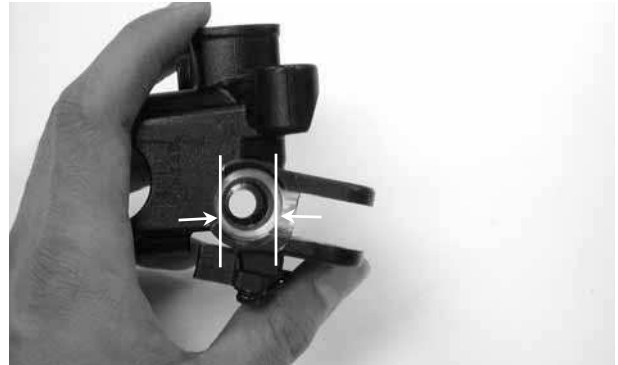

Measure the brake master cylinder piston
O.D.

Service Limit: 12.64 mm (0.5056 in)

Before assembly, inspect the 1st and 2nd
rubber cups for wear.



FRONT BRAKE CALIPER

DISASSEMBLY

Drain the front brake hydraulic system (refer to the **“FRONT BRAKE FLUID”** section in this chapter).

Remove the oil bolt (1), sealing washers and brake hose from the brake caliper.

Remove the brake pads and caliper (refer to the **“FRONT BRAKE PAD”** section in this chapter).

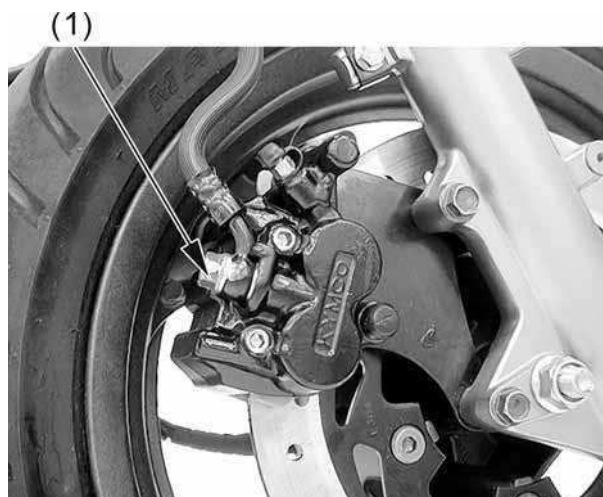

Remove the caliper bracket (2) from the caliper body.

* Do not remove the caliper and bracket pins unless replacement.



Remove pad spring (3) from the caliper body.

* Do not remove the retainer from the bracket unless replacement.



Remove the piston from the brake caliper.
If necessary, use compressed air to squeeze out the piston through the brake fluid inlet opening and place a shop towel under the caliper to avoid contamination caused by the removed piston.
Check the piston cylinder for scratches or wear and replace if necessary.



Push the piston oil seals (4) outward to remove it.

Clean the oil seal groove with brake fluid.

* Be careful not to damage the piston surface.

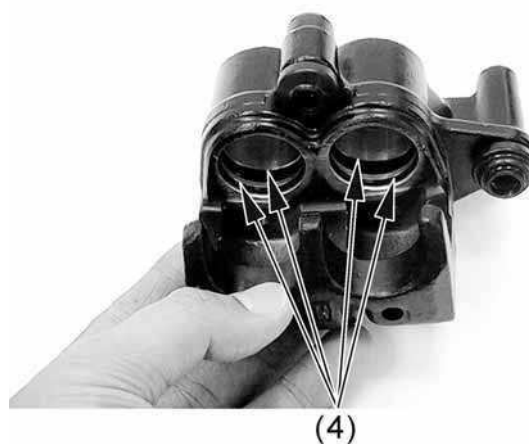

ASSEMBLY

Clean all removed parts.
Apply silicon grease to the piston and new oil seals. Lubricate the brake caliper cylinder inside wall with brake fluid.
Install the new oil seals.
Install the brake caliper piston with grooved side facing out.

* Install the piston with its outer end protruding 3~5mm beyond the brake caliper.

Wipe off excessive brake fluid with a clean shop towel.

Install the pad spring.

Apply silicon grease to the boots inside.
Install the caliper bracket to the caliper



Install the pads and then install the front caliper onto the fork leg (refer to the "FRONT BRAKE PAD" section in this chapter).

Rest the brake hose eyelet against the stopper.
Install the brake hose eyelet with the oil bolt and new sealing washers.
Tighten the oil bolt to the specified torque.

Torque: 35 N•m (3.5 kgf•m, 25 lbf•ft)

Fill the reservoir to the upper level and bleed the brake system (refer to the "FRONT BRAKE FLUID" section in this chapter).



INSPECTION

Check the piston for scratches or wear.
Measure the piston O.D. with a micrometer
gauge.

Service Limit: 25.3 mm (1.012 in)

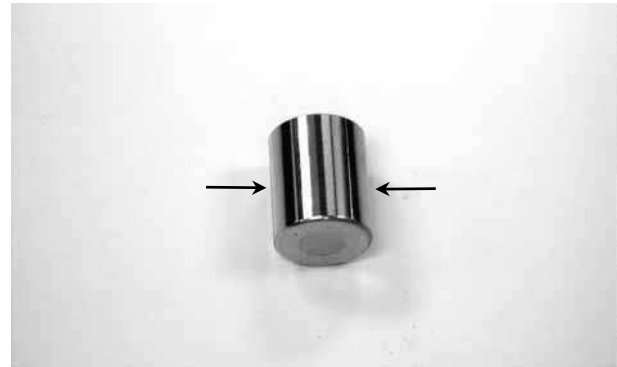

Check the caliper cylinder for scratches or
wear and measure the cylinder bore.

Service Limit: 25.45 mm (1.018 in)



FRONT SHOCK ABSORBER

REMOVAL

Remove the front cover and front fender.
(refer to the “**FRAME CVOERS
REMOVAL/INSTALLATION**” section in
the chapter 2).

Remove the front brake caliper (refer to the
“**FRONT BRAKE PAD**” section in this
chapter).

Remove the front wheel (refer to the
“**FRONT WHEEL**” section in this chapter).

Remove the bolt (1) and then remove the
brake hose guide from right front shock
absorber.

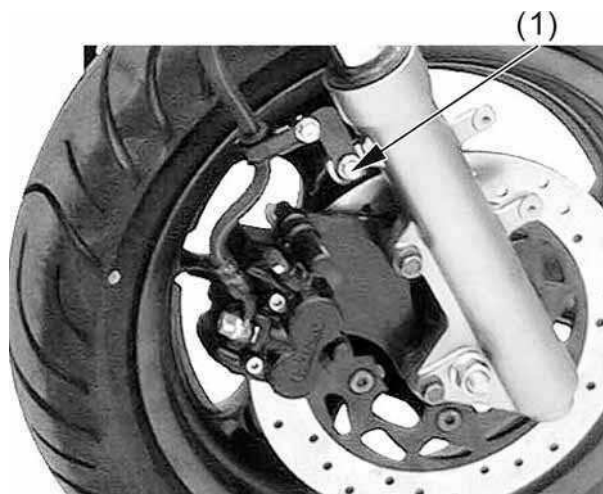

Remove the bolt (2) and then remove the
speedometer cable guide from left front shock
absorber.

Remove the two mounting bolts (3) and then
remove the right front shock absorber.
Remove the two mounting bolts (4) and then
remove the left front shock absorber.

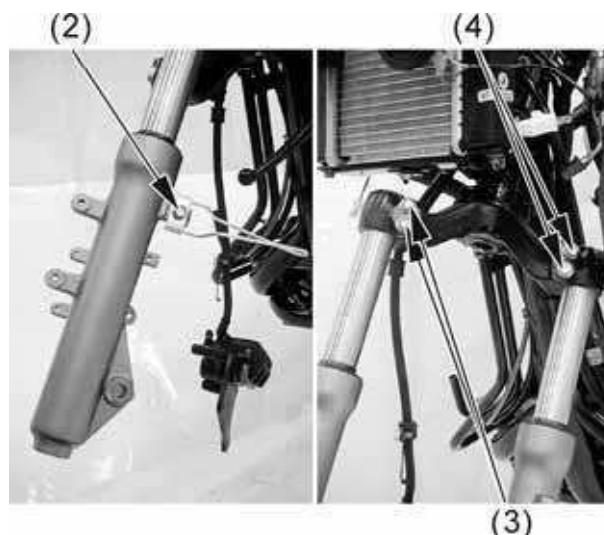

INSTALLATION

Installation is in the reverse order of removal.

* Tighten the shock absorber mounting
bolt to the specified torque.

Torque: 3.2 kgf-m (32 N-m, 23 lbf-ft)

INSPECTION

Inspect the following items and replace if
necessary.

- Front shock absorber tube bending, damage
or wear
- Weak front shock absorber spring
- Damper and damper rod bending
- Oil seal damage or wear

STEERING STEM

REMOVAL

Remove the steering handlebar (refer to the “HANDLEBAR” section in this chapter).
Remove the front shock absorber (refer to the “FRONT SHOCK ABSORBER” section in this chapter).

Remove the front brake hose (1) from the guide.



Hold the steering stem top cone race and remove the steering stem lock nut by using the special tool.

Special tool:

Lock nut wrench A120F00002

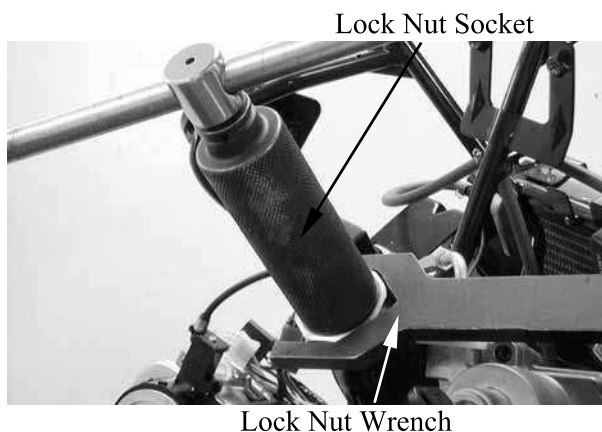

Remove the top cone race and remove the steering stem.

* Be careful not to lose the steel balls (26 on top race and 19 on bottom race).



15. HANDLEBAR/FRONT WHEEL/FRONT BRAKE/ FRONT SHOCK ABSORBER/STEERING STEM

Inspect the ball races, cone races and steel balls for wear or damage. Replace if necessary.

Remove the top balls.

Remove the upper ball race by using a chisel if necessary.



Top Ball Cone Race

Remove the bottom balls.

Remove the bottom ball race by using a pipe if necessary.

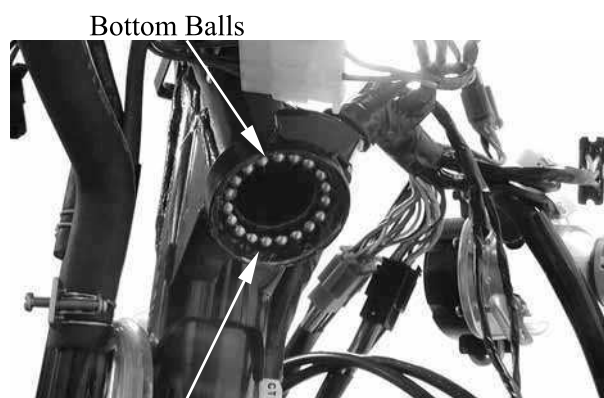

Bottom Ball Race

Remove the bottom cone race by using a chisel if necessary.

* Be careful not to damage the steering stem.

Bottom Cone Race



INSTALLATION

Install the new bottom cone race onto the steering stem.

Install the new upper and bottom ball races into the frame.

Apply grease to the top and bottom ball races and install new 26 steel balls on the top ball race and 19 new steel balls on the bottom ball race.

Install the steering stem.

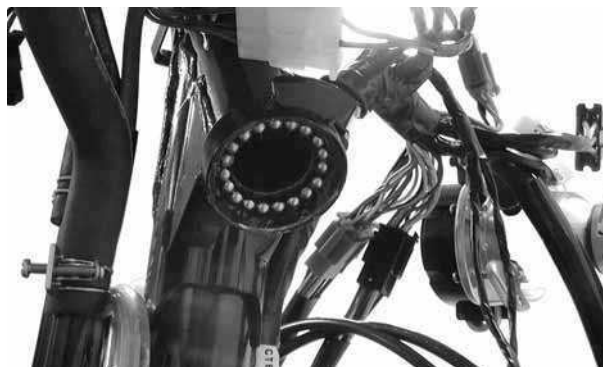

Apply grease to the top cone race and install it.

Tighten the top cone race and then turn the steering stem right and left several times to make steel balls contact each other closely.

*

Check that the steering stem rotates freely without vertical play.



Install the steering stem lock nut and tighten it to the specified torque by using the special tool while holding the top cone race.

Torque: 8 kgf-m (80 N-m, 58 lbf-ft)

Special tool:

Lock nut wrench A120F00002



**REAR BRAKE/REAR FORK/REAR WHEEL/
REAR SHOCK ABSORBER**

SCHEMATIC DRAWING -----	16- 1
SERVICE INFORMATION-----	16- 2
TROUBLESHOOTING-----	16- 3
REAR BRAKE FLUID -----	16- 4
REAR BRAKE PAD -----	16- 8
BRAKE DISC INSPECTION-----	16-10
BRAKE MASTER CYLINDER-----	16-11
REAR BRAKE CALIPER-----	16-16
REAR WHEEL/REAR FORK -----	16-20
REAR SHOCK ABSORBER-----	16-25

16. REAR BRAKE/REAR FORK/REAR WHEEL/REAR SHOCK ABSORBER

SCHEMATIC DRAWING

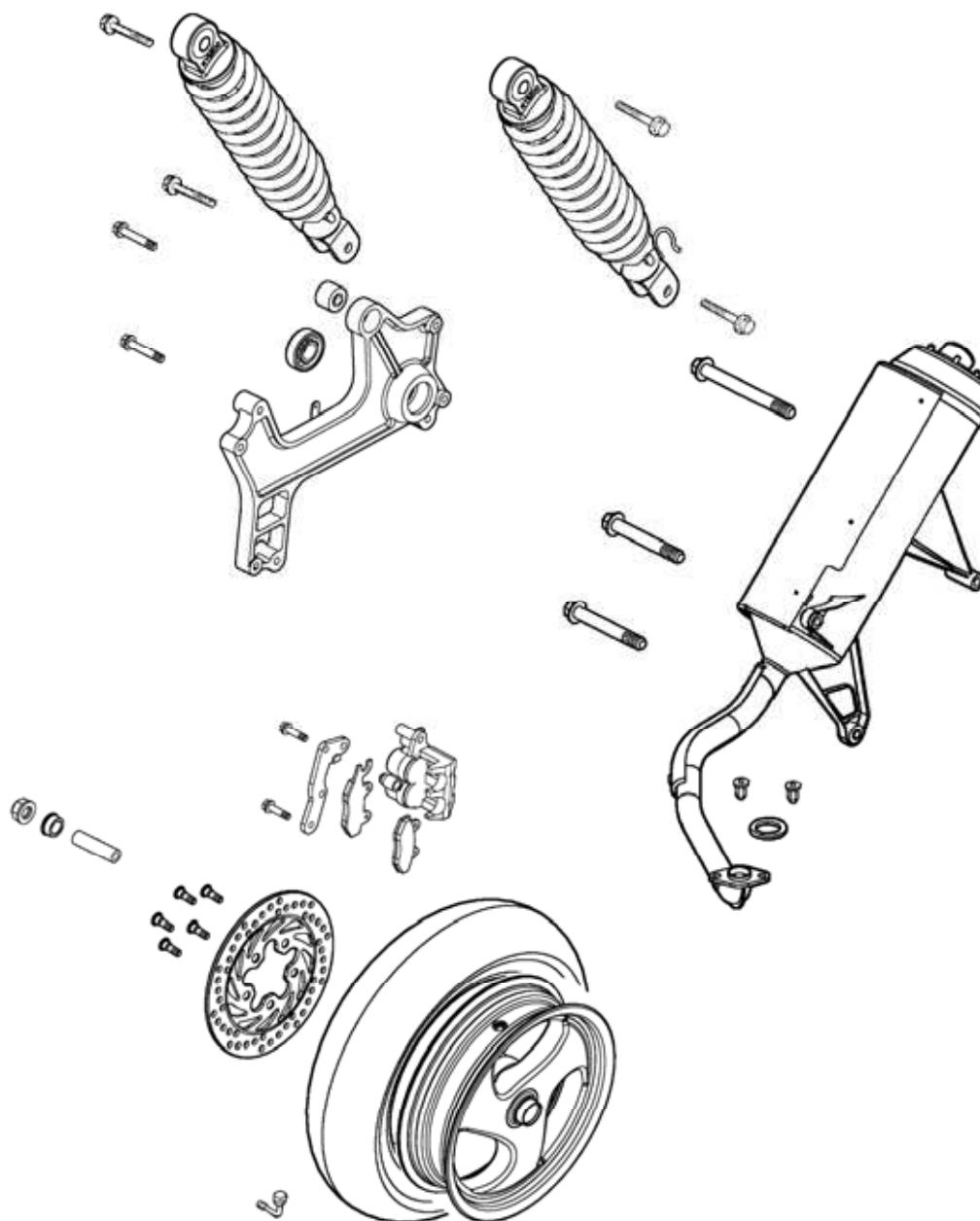

16. REAR BRAKE/REAR FORK/REAR WHEEL/REAR SHOCK ABSORBER



DINK 200i/125

SERVICE INFORMATION

GENERAL INSTRUCTIONS

- When performing the services stated in this section, the engine and exhaust muffler must be cold to avoid scalding.
- During servicing, keep oil or grease off the brake pads and brake disk.

SPECIFICATIONS

Unit: mm (in)

Item	Standard	Service Limit
Rear wheel rim runout	—	2 (0.08)
Rear brake disk thickness	3.5 ~ 3.8 (0.14 ~ 0.152)	3 (0.12)
Rear brake disk runout	—	0.3 (0.012)
Rear brake master cylinder I.D.	12.7 ~ 12.74 (0.508 ~ 0.5096)	12.75 (0.51)
Rear brake master cylinder piston O.D.	12.65 ~ 12.68 (0.506 ~ 0.5072)	12.64 (0.5056)
Rear brake caliper cylinder I.D.	25.4 ~ 25.45 (1.016 ~ 1.0144)	25.45 (1.018)
Rear brake caliper piston O.D.	25.33 ~ 25.36 (1.0132 ~ 1.0144)	25.3 (1.012)

TORQUE VALUES

Rear axle nut	120 N•m (12 kgf•m, 86 lbf•ft)
Rear shock absorber lower mount bolt	27 N•m (2.7 kgf•m, 19 lbf•ft)
Rear shock absorber upper mount bolt	40 N•m (4 kgf•m, 29 lbf•ft)
Rear fork mount bolt	27 N•m (2.7 kgf•m, 19 lbf•ft)
Master cylinder reservoir cover screw	2 N•m (0.2 kgf•m, 1.4 lbf•ft)
Master cylinder holder bolt	12 N•m (1.2 kgf•m, 9 lbf•ft)
Brake lever pivot bolt	2 N•m (0.2 kgf•m, 1.4 lbf•ft)
Brake lever pivot nut	10 N•m (1 kgf•m, 7.2 lbf•ft)
Brake light switch screw	1 N•m (0.1 kgf•m, 0.7 lbf•ft)
Brake caliper mounting bolt	32 N•m (3.2 kgf•m, 23 lbf•ft)
	ALOC bolt: replace with a new one.
Brake caliper bleed screw	6 N•m (0.6 kgf•m, 4.3 lbf•ft)
Brake pad pin	18 N•m (1.8 kgf•m, 13 lbf•ft)
Brake hose oil bolt	35 N•m (3.5 kgf•m, 25 lbf•ft)

SPECIAL TOOLS

Bearing installer A120E00014

TROUBLESHOOTING

Rear wheel wobbling

- Bent rim
- Faulty tire
- Axle not tightened properly

Soft rear shock absorber

- Weak shock absorber spring
- Damper oil leaks

Rear wheel noise

- Worn rear wheel axle bearings
- Worn rear fork bearings
- Deformed rear fork

Poor brake performance

- Air in brake system
- Deteriorated brake fluid
- Contaminated brake pad surface
- Worn brake pads
- Clogged brake fluid line
- Deformed brake disk
- Unevenly worn brake caliper

REAR BRAKE FLUID

Check

Brake fluid:

Brake hose:

Cracks/wear/damage → Replace.

Apply the brake lever several times.

Fluid leakage → Replace.

Brake hose clamp:

Loosen → Tighten

FLUID REPLACEMENT/AIR BLEEDING

*

- A contaminated brake disc or pad reduces stopping power. Discard contaminated pads and clean a contaminated disc with a high quality brake degreasing agent.
- Do not allow foreign material to enter the system when filling the reservoir.
- Avoid spilling brake fluid on painted, plastic or rubber parts. Place a rag over these parts whenever the system is serviced.

Once the hydraulic system has been opened, or if the brake feels spongy, the system must be bled. When using a commercially available brake bleeder, follow the manufacturer's operating instructions.

16. REAR BRAKE/REAR FORK/REAR WHEEL/REAR SHOCK ABSORBER

Brake fluid draining

Make sure that the master cylinder parallel to the ground, before removing the reservoir cover.

Remove the two screws (1).

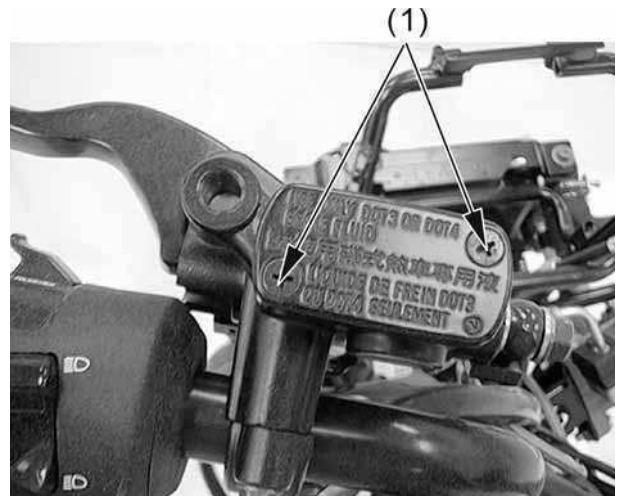

Remove the reservoir cover (2), diaphragm plate (3) and diaphragm (4).

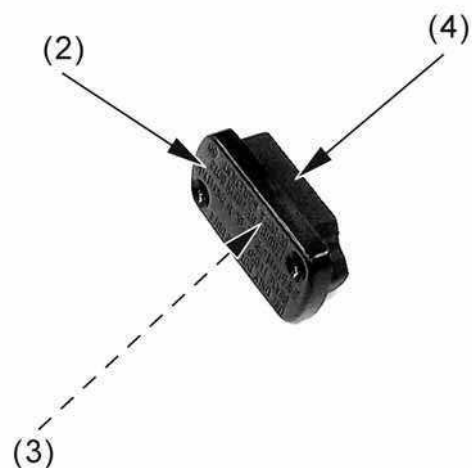

Connect a bleed hose (5) to the bleed valve (6).

* Always let the exhaust system cool before performing this operation.

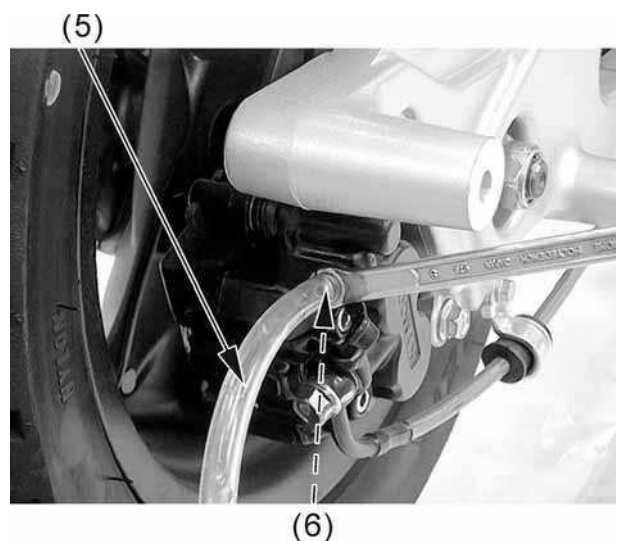

16. REAR BRAKE/REAR FORK/REAR WHEEL/REAR SHOCK ABSORBER

Loosen the bleed valve and pump the brake lever.
Stop operating the brake when no more fluid flows out of the bleed valve.

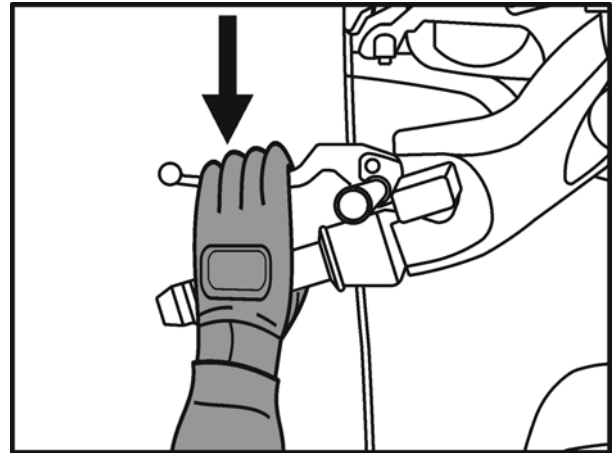

Brake fluid filling/Air bleeding

* Do not mix different types of fluid since they are not compatible.

Fill the master cylinder with DOT 4 brake fluid to the upper level.

Connect a commercially available brake bleeder to the front caliper bleed valve.

Check the fluid level often while bleeding the brake to prevent air from being pumped into the system.

When using a brake bleeding tool, follow the manufacture's operating instructions.

* If air enters the bleeder from around the bleed valve threads, seal the threads with teflon tape.

Pump the brake bleeder and loosen the rear caliper bleed valve. Add fluid when the fluid level in the master cylinder is low to prevent drawing air into the system.

Repeat the above procedures until no air bubbles appear in the plastic hose.

Close the rear caliper bleed valve and operate the rear brake lever.

If it still spongy, bleed the system again.

16. REAR BRAKE/REAR FORK/REAR WHEEL/REAR SHOCK ABSORBER

If the brake bleeder is not available, perform the following procedure.

Pump up the system pressure with the brake lever until there are not air bubbles in the fluid flowing out of the reservoir small hole and lever resistance is felt.

1. Pump the brake lever several times, then squeeze the brake lever all the way and loosen the bleed valve 1/4 turn. Wait several seconds and close the bleed valve.

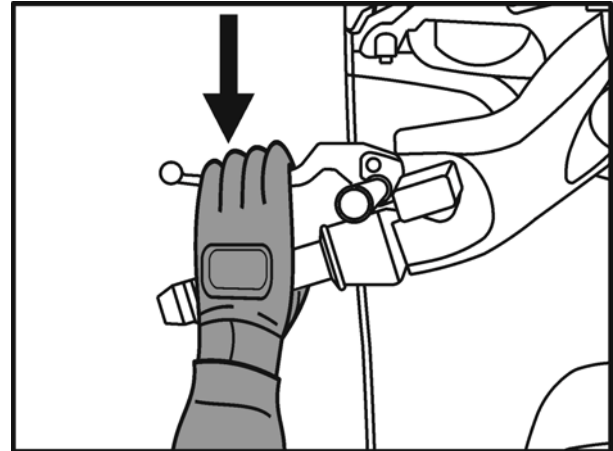

* Do not release the brake lever until the bleed valve has been closed.

2. Release the brake lever slowly until the bleed valve has been closed. Add fluid when the fluid level in the master cylinder is low to prevent drawing air into the system.
3. Repeat the steps 1 - 2 until there are no air bubbles in the bleed hose.

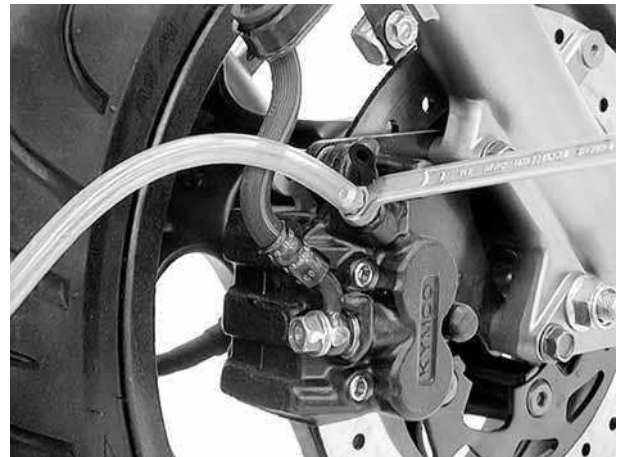

After bleeding air completely, tighten the bleed valve to the specified torque.

Torque: 6 N•m (0.6 kgf•m, 4.3 lbf•ft)

Fill the reservoir to the casting ledge with DOT 4 brake fluid to the upper level.

Install the diaphragm, set plate and reservoir cover and tighten the screws to the specified torque.

Torque: 2 N•m (0.2 kgf•m, 1.1 lbf•ft)

16. REAR BRAKE/REAR FORK/REAR WHEEL/REAR SHOCK ABSORBER

REAR BRAKE PAD

BRAKE PAD REPLACEMENT

Remove the two pad pins (1).
Remove the two caliper mounting bolts (2), then remove the caliper.

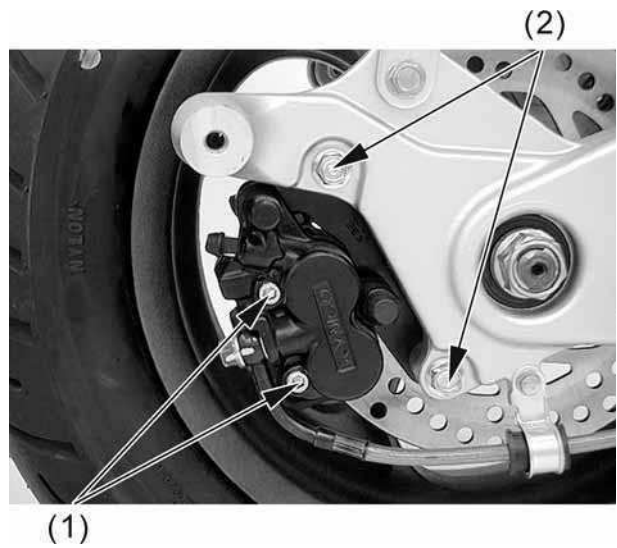

Remove the brake pads.



* Always replace the brake pads in pairs to ensure even disc pressure.

16. REAR BRAKE/REAR FORK/REAR WHEEL/REAR SHOCK ABSORBER

Install new pads so that their ends rest on the pad retainer on the brake properly.



Install the pad pin by pushing the pads against the pad spring to align the pad pin holes in the pads and caliper.

Install the rear caliper onto the rear fork and then install and tighten the new two caliper mounting bolts to the specified torque.

Torque: 32 N-m (3.2 kgf-m, 23 lbf-ft)

Tighten the two pad pins to the specified torque.

Torque: 18 N-m (1.8 kgf-m, 13 lbf-ft)



16. REAR BRAKE/REAR FORK/REAR WHEEL/REAR SHOCK ABSORBER

BRAKE DISC INSPECTION

Visually inspect the brake disc for damage or cracks.

Measure the brake disc thickness.

Service limits: 3 mm (0.12 in)

Replace the brake disc if the smallest measurement is less than the service limit.

Measure the brake disc warpage.

Service limits: 0.3 mm (0.012 in)



BRAKE MASTER CYLINDER

REMOVAL

When removing the brake hose bolt, cover the end of the hose to prevent contamination. Secure the hose to prevent fluid from leaking out.

Remove the upper handlebar cover (refer to the “**FRAME COVERS REMOVAL/INSTALLATION**” section in the chapter 2).

Drain the rear brake hydraulic system (refer to the “**REAR BRAKE FLUID**” section in this chapter).

Remove the brake lever pivot bolt (1) and nut (2), then remove the brake lever.

Disconnect the brake light switch connectors (3).

Remove the brake hose oil bolt (4), sealing washer and brake hose eyelet.

Remove the two bolts (5) from the master cylinder holder and remove the master cylinder assembly.

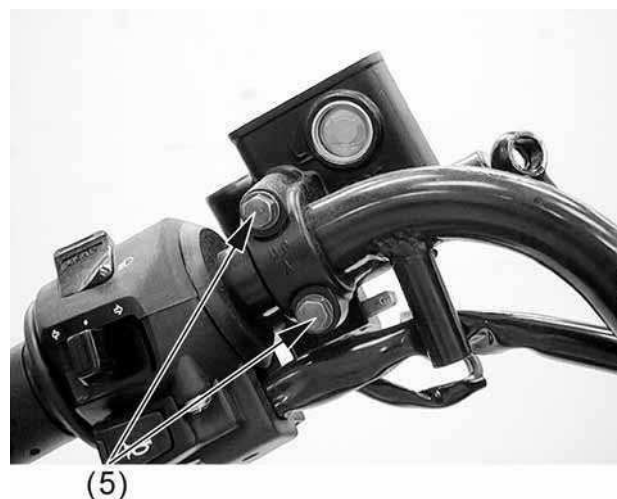
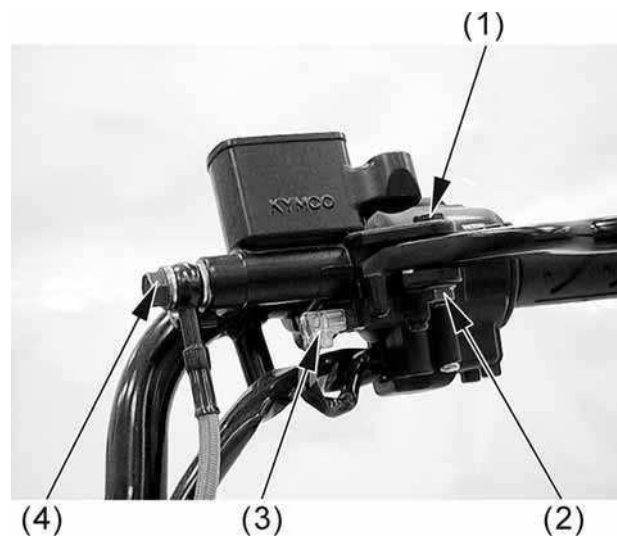

16. REAR BRAKE/REAR FORK/REAR WHEEL/REAR SHOCK ABSORBER

Remove the screw (6) and brake light switch.

INSTALLATION

Install the brake light switch and tighten the screw to the specified torque.

Torque: 1 N•m (0.1 kgf•m, 0.7 lbf•ft)

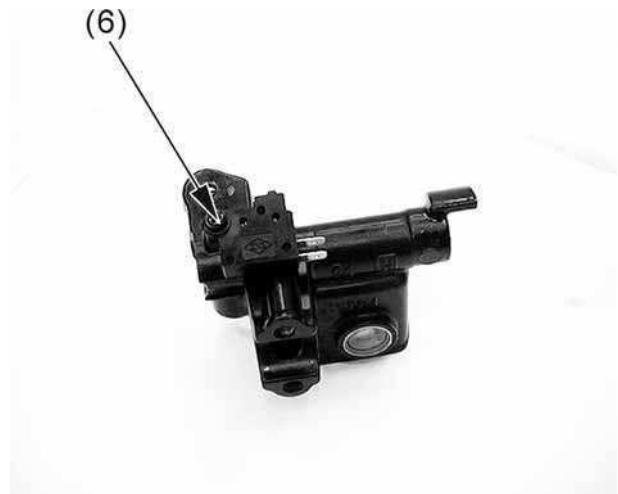

Align the pin on the master cylinder holder with the hole on the handlebar.



Install the rear master cylinder and holder with the “UP” mark facing up.

Install the bolts and tighten the upper bolt first then tighten the lower bolt to the specified torque.

Torque: 12 N•m (1.2 kgf•m, 9 lbf•ft)



16. REAR BRAKE/REAR FORK/REAR WHEEL/REAR SHOCK ABSORBER

Rest the brake hose eyelet against the stopper.
Install the brake hose eyelet with the oil bolt and new sealing washers.
Tighten the oil bolt to the specified torque.

Torque: 35 N•m (3.5 kgf•m, 25 lbf•ft)

Apply silicone grease to the master piston tip.
Install the brake lever.

Apply silicone grease to the brake lever pivot bolt sliding surface.
Install and tighten the pivot bolt to the specified torque.

Torque: 2 N•m (0.2 kgf•m, 1.4 lbf•ft)

Install and tighten the pivot nut to the specified torque.

Torque: 10 N•m (1 kgf•m, 7.2 lbf•ft)

Connect the brake light switch connectors.

Fill the reservoir to the upper level and bleed the brake system (refer to the “**REAR BRAKE FLUID**” section in this chapter).



16. REAR BRAKE/REAR FORK/REAR WHEEL/REAR SHOCK ABSORBER

DISASSEMBLY

Remove the piston rubber cover and snap ring from the brake master cylinder.

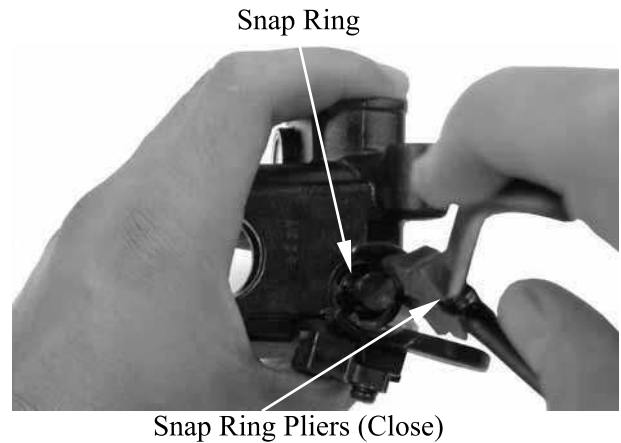

Remove the washer, main piston and spring from the brake master cylinder. Clean the inside of the master cylinder and brake reservoir with brake fluid.

ASSEMBLY

Before assembly, apply brake fluid to all removed parts. Install the spring together with the 1st rubber cup.

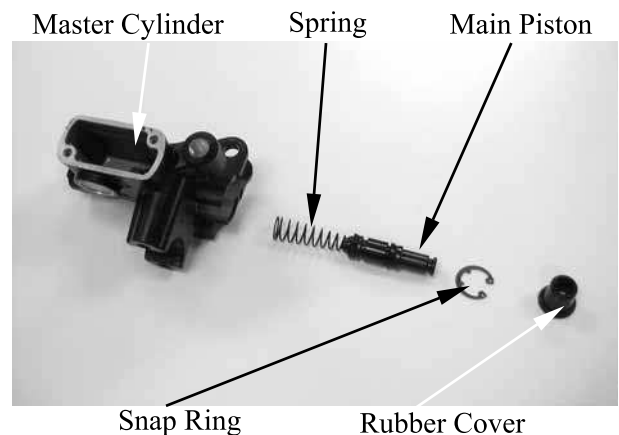

- * During assembly, the main piston and spring must be installed as a unit without exchange.
- When assembling the piston, soak the cups in brake fluid for a while.
- Install the cups with the cup lips facing the correct direction.

Install the main piston, spring and new snap ring. Install the new rubber cover.

16. REAR BRAKE/REAR FORK/REAR WHEEL/REAR SHOCK ABSORBER

INSPECTION

Measure the brake master cylinder I.D.
Inspect the master cylinder for scratches or cracks.

Service Limit: 12.75 mm (0.5 in)

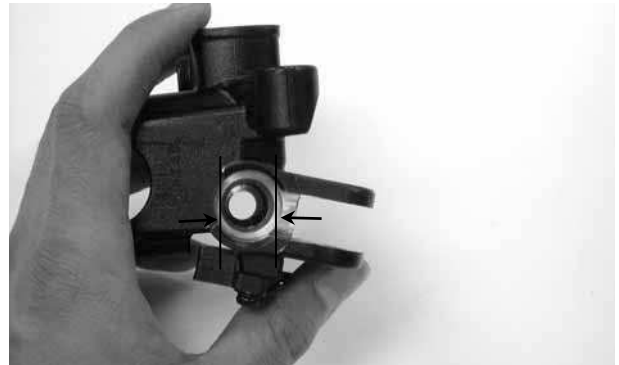

Measure the brake master cylinder piston O.D.

Service Limit: 12.64 mm (0.5056 in)

Before assembly, inspect the 1st and 2nd rubber cups for wear.



REAR BRAKE CALIPER

DISASSEMBLY

Drain the rear brake hydraulic system (refer to the “**REAR BRAKE FLUID**” section in this chapter).

Remove the oil bolt (1), sealing washers and brake hose from the brake caliper.

Remove the brake pads and caliper (refer to the “**REAR BRAKE PAD**” section in this chapter).

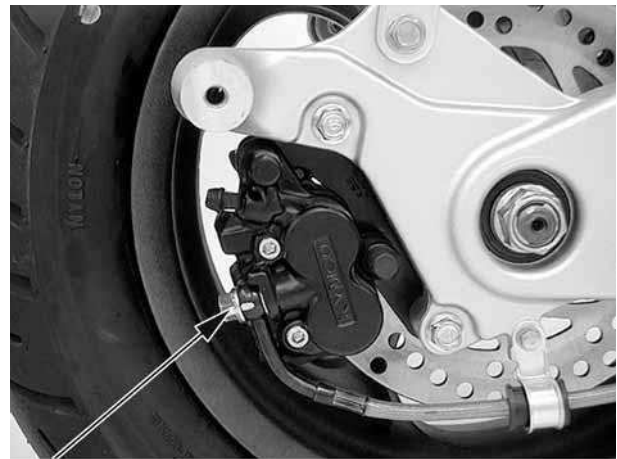

(1)

Remove the caliper bracket (2) from the caliper body.

* Do not remove the caliper and bracket pins unless replacement.

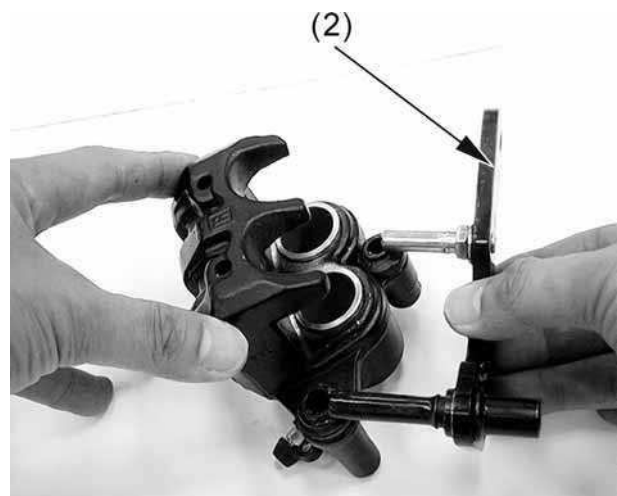

16. REAR BRAKE/REAR FORK/REAR WHEEL/REAR SHOCK ABSORBER

Remove pad spring (3) from the caliper body.

* Do not remove the retainer from the bracket unless replacement.



Remove the piston from the brake caliper. If necessary, use compressed air to squeeze out the piston through the brake fluid inlet opening and place a shop towel under the caliper to avoid contamination caused by the removed piston. Check the piston cylinder for scratches or wear and replace if necessary.



Push the piston oil seals (4) outward to remove it. Clean the oil seal groove with brake fluid.

* Be careful not to damage the piston surface.

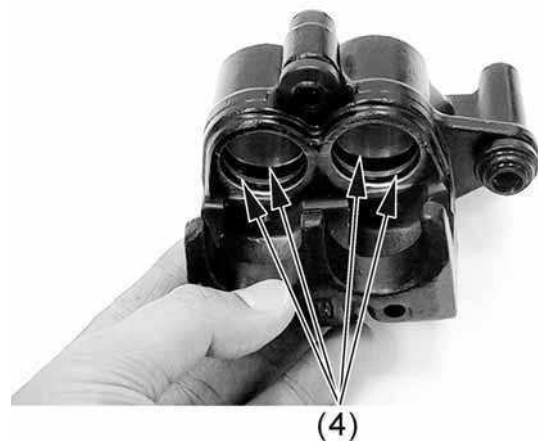

16. REAR BRAKE/REAR FORK/REAR WHEEL/REAR SHOCK ABSORBER

ASSEMBLY

Clean all removed parts.
Apply silicon grease to the piston and new oil seals. Lubricate the brake caliper cylinder inside wall with brake fluid.
Install the new oil seals.
Install the brake caliper piston with grooved side facing out.

* Install the piston with its outer end protruding 3 ~ 5mm beyond the brake caliper.

Wipe off excessive brake fluid with a clean shop towel.

Install the pad spring.

Apply silicon grease to the boots inside.
Install the caliper bracket to the caliper



Install the pads and then install the rear caliper onto the rear fork (refer to the "REAR BRAKE PAD" section in this chapter).

Install the brake hose eyelet with the oil bolt and new sealing washers.
Tighten the oil bolt to the specified torque.

Torque: 35 N•m (3.5 kgf•m, 25 lbf•ft)

Fill the reservoir to the upper level and bleed the brake system (refer to the "REAR BRAKE FLUID" section in this chapter).



16. REAR BRAKE/REAR FORK/REAR WHEEL/REAR SHOCK ABSORBER

INSPECTION

Check the piston for scratches or wear.
Measure the piston O.D. with a micrometer gauge.

Service Limit: 25.3 mm (1.012 in)

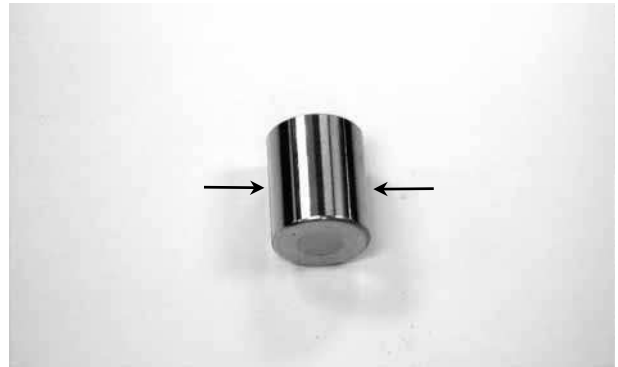

Check the caliper cylinder for scratches or wear and measure the cylinder bore.

Service Limit: 25.45 mm (1.018 in)



16. REAR BRAKE/REAR FORK/REAR WHEEL/REAR SHOCK ABSORBER

REAR WHEEL/REAR FORK

REMOVAL

Remove the muffler (refer to the “EXHAUST MUFFLER” section in the chapter 2).

Loosen the rear axle nut (1).

Support the scooter securely on its main stand.

Remove the rear shock absorber lower mount bolt (2).

Remove the three bolts (3) and brake hose clamps from the rear fork.
Remove the two mounting bolts (4), then remove the rear brake caliper.

Remove the rear axle nut.

Remove the two mounting bolts (5), then remove the rear fork.

Remove the inner side collar (6).

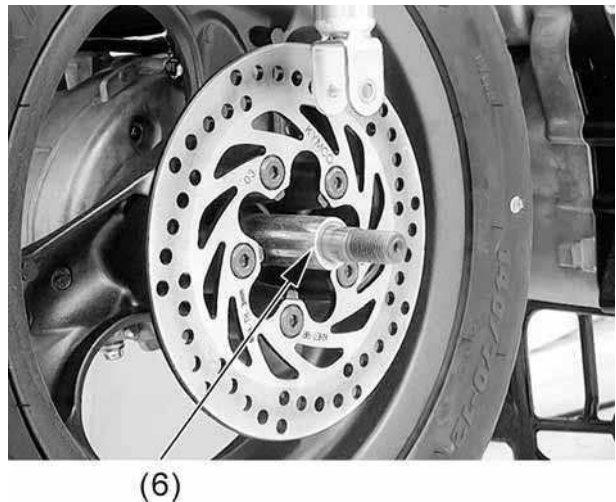
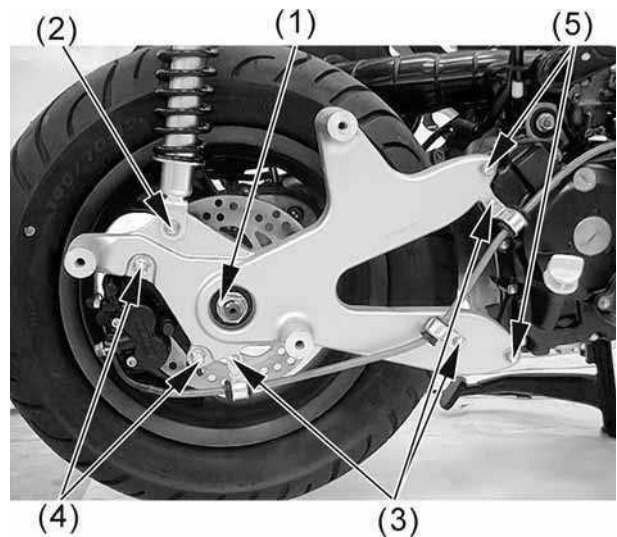

16. REAR BRAKE/REAR FORK/REAR WHEEL/REAR SHOCK ABSORBER

Remove the rear wheel.

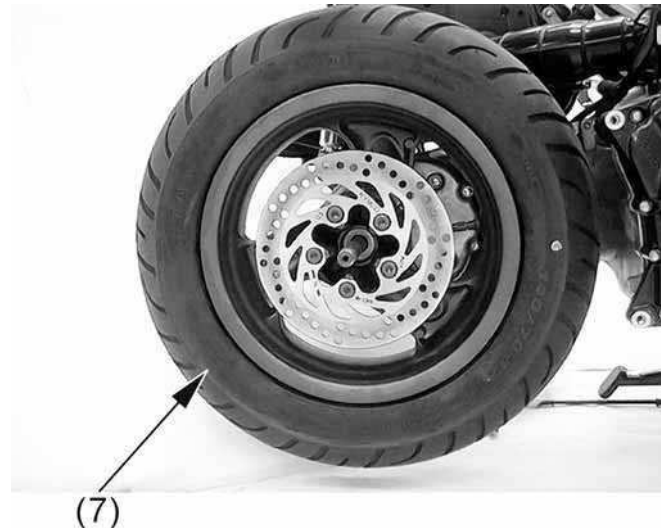

INSPECTION

Wheel

Check the wheel rim runout using dial indicator.

Actual runout is 1/2 the total indicator reading.

Service Limits:

Radial: 2 mm (0.08 in)

Axial: 2 mm (0.08 in)

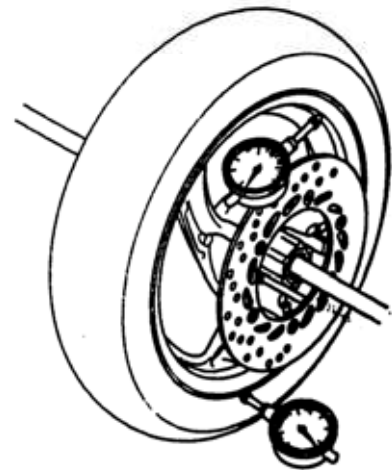

REAR FORK BEARING REPLACEMENT

Remove the outer side collar (1) from the rear fork.

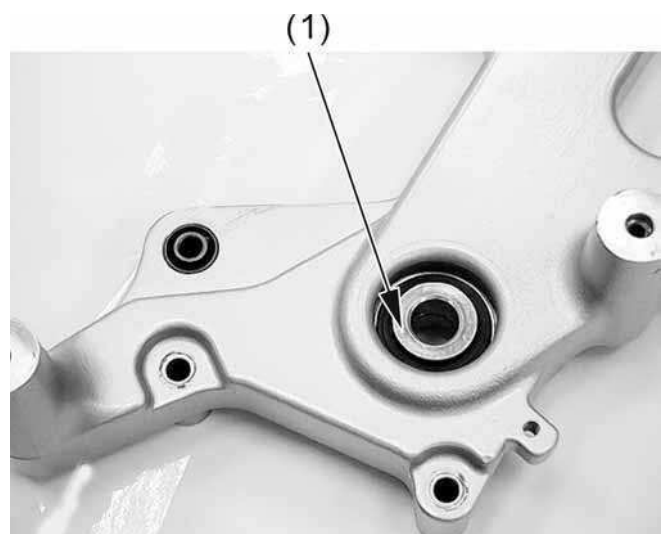

16. REAR BRAKE/REAR FORK/REAR WHEEL/REAR SHOCK ABSORBER

Remove the dust seal (2) from the rear fork.

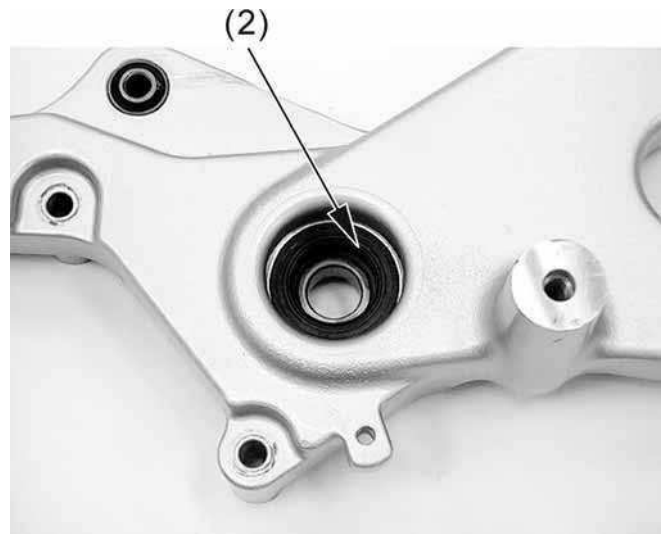

Remove the snap ring (3).

Turn the inner race of the bearing with your finger.
The bearing should turn smoothly and quietly.
Also check that the bearing outer race fits tightly in the rear fork.

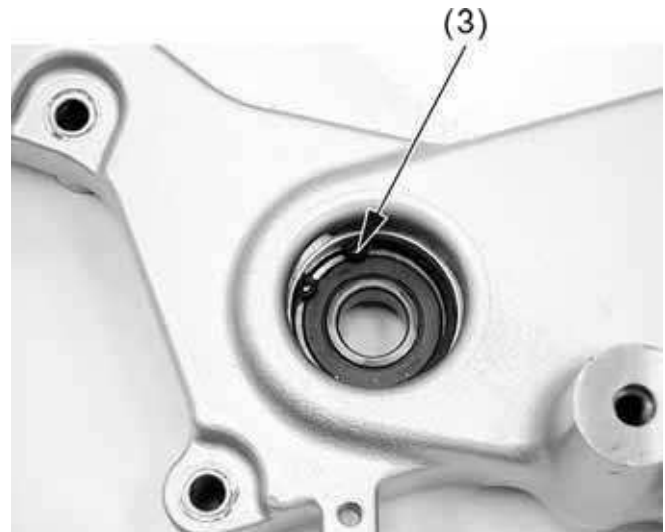

Remove and discard the bearing if the race does not turn smoothly and quietly, or if it fits loosely in the rear fork.

Remove the bearing from the rear fork by using a proper pipe.



16. REAR BRAKE/REAR FORK/REAR WHEEL/REAR SHOCK ABSORBER

Drive in a new bearing squarely until it is fully seated, using the special tools.

Special tool:

Bearing installer A120E00014



Install the snap ring to the groove of the rear fork securely.

Apply grease to the new dust seal lip and install it to the rear fork.

Apply grease to the outer side collar and install it to the rear fork.

Check the bushing (4) for wear or damage.

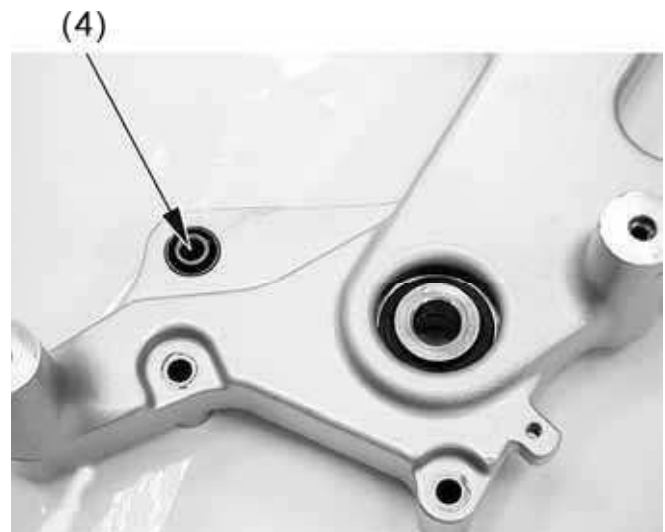

INSTALLATION

Apply grease to the final gear shaft.



Apply grease

16. REAR BRAKE/REAR FORK/REAR WHEEL/REAR SHOCK ABSORBER

Install the rear wheel onto the final gear shaft, aligning the spline.

Install the inner side collar.

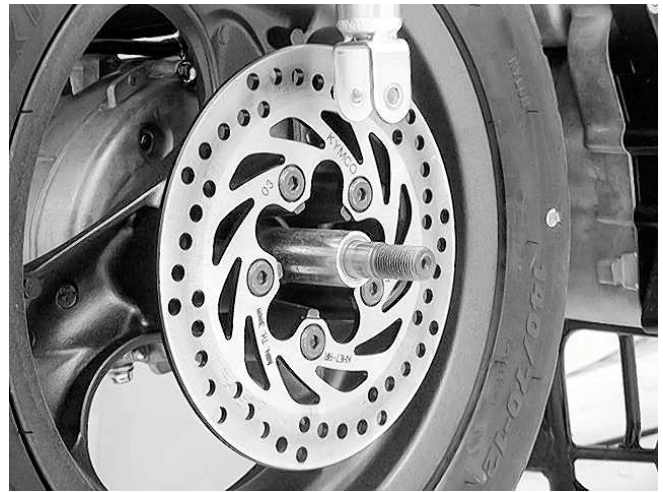

Install the rear fork.
Install the rear fork and tighten the two bolts (5) to the specified torque.

Torque: 27 N•m (2.7 kgf•m, 19 lbf•ft)

Install and tighten the rear axle nut (1) to temporarily.
Install and tighten the rear shock absorber lower mount bolt (2) to the specified torque.

Torque: 27 N•m (2.7 kgf•m, 19 lbf•ft)

Install the rear brake caliper and tighten the two mounting bolts (4) to the specified torque.

Torque: 32 N•m (3.2 kgf•m, 23 lbf•ft)

Install the brake hose clamps to the rear fork and tighten the three bolts (3) securely.

Tighten the rear axle nut (1) to the specified torque.

Torque: 120 N•m (12 kgf•m, 86 lbf•ft)

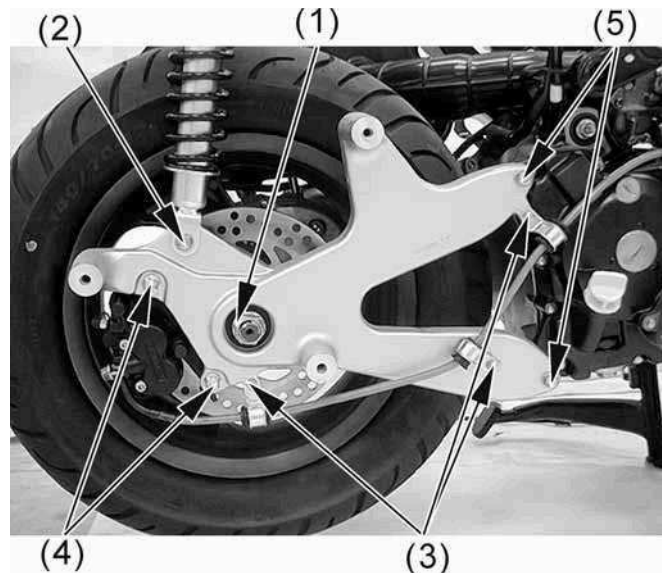

REAR SHOCK ABSORBER

REMOVAL

Remove the luggage box (refer to the “FRAME COVERS REMOVAL/INSTALLATION” section in the chapter 2).

Remove the rear shock absorber lower mount bolt (1).

Remove the rear shock absorber upper mount bolt (2) and shock absorber.

INSTECTION

Check the damper unit for leakage or other damage.

Check the upper joint bushing for wear or damage.

Replace the shock absorber assembly if necessary.

INSTALLATION

Install the rear shock absorber tighten the upper mount bolt to the specified torque.

Torque: 40 N•m (4 kgf•m, 29 lbf•ft)

Install and tighten the lower mount bolt to the specified torque.

Torque: 27 N•m (2.7 kgf•m, 19 lbf•ft)

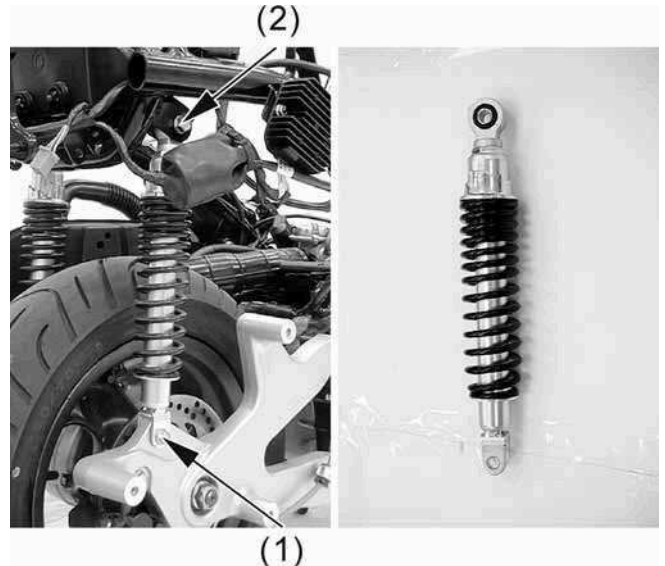

17. BATTERY/CHARGING SYSTEM

17

BATTERY/CHARGING SYSTEM

CHARGING SYSTEM LAYOUT	17-1
CHARGING CIRCUIT	17-1
SERVICE INFORMATION	17-2
TROUBLESHOOTING	17-3
BATTERY	17-4
CHARGING SYSTEM	17-6
ALTERNATOR CHARGING COIL	17-8
REGULATOR/RECTIFIER	17-9

CHARGING SYSTEM LAYOUT

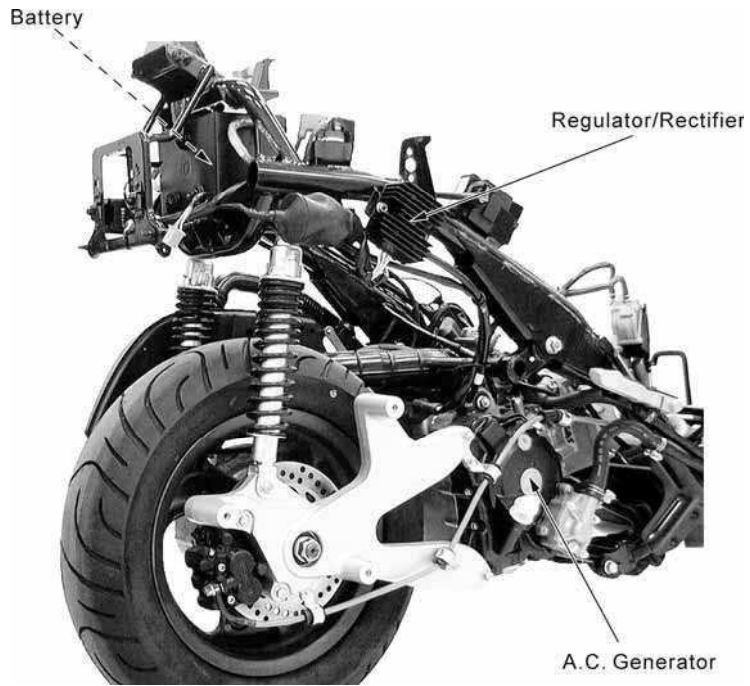

CHARGING CIRCUIT

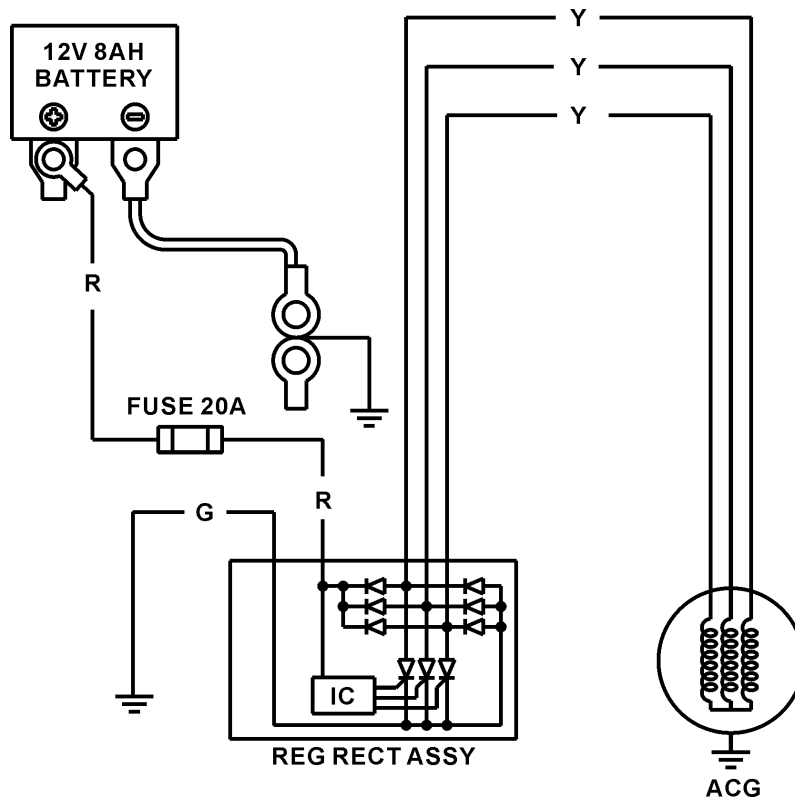

SERVICE INFORMATION

GENERAL INSTRUCTIONS

* The battery electrolyte (sulfuric acid) is poisonous and may seriously damage the skin and eyes. Avoid contact with skin, eyes, or clothing. In case of contact, flush with water and get prompt medical attention

- The battery can be charged and discharged repeatedly. If a discharged battery is not used for a long time, its service life will be shortened. Generally, the capacity of a battery will decrease after it is used for 2~3 years. A capacity-decreased battery will resume its voltage after it is recharged but its voltage decreases suddenly and then increases when a load is added.
- When a battery is overcharged, some symptoms can be found. If there is a short circuit inside the battery, no voltage is produced on the battery terminals. If the rectifier won't operate, the voltage will become too high and shorten the battery service life.
- If a battery is not used for a long time, it will discharge by itself and should be recharged every 3 months.
- A new battery filled with electrolyte will generate voltage within a certain time and it should be recharged when the capacity is insufficient. Recharging a new battery will prolong its service life.
- Inspect the charging system according to the sequence specified in the Troubleshooting.
- Do not disconnect and soon reconnect the power of any electrical equipment because the electronic parts in the regulator/rectifier will be damaged. Turn off the ignition switch before operation.
- It is not necessary to check the MF battery electrolyte or fill with distilled water.
- Check the load of the whole charging system.
- Do not quick charge the battery. Quick charging should only be done in an emergency.
- Remove the battery from the motorcycle for charging.
- When replacing the battery, do not use a traditional battery.
- When charging, check the voltage with an electric tester.

SPECIFICATIONS

Item		Standard	
Battery	Capacity	DINK 200i	12V10AH
		DINK 125	12V8AH
	Voltage (20°C)	Fully charged	13.2V
		Undercharged	12.3V
	Charging current	DINK 200i	STD: 1A Quick: 5A
DINK 125		STD: 0.8A Quick: 4A	
Charging time		STD: 5-10hr Quick: 60min	
A.C. Generator	Capacity	DINK 200i	168W/5000rpm
		DINK 125	33W/5000rpm
	Charging coil resistance (20°C)	Yellow~Yellow	0.4~0.6Ω
Regulator/Rectifier	Limit voltage	14.5±0.5V	

17. BATTERY/CHARGING SYSTEM

TROUBLESHOOTING

No power

- Dead battery
- Disconnected battery cable
- Fuse burned out
- Faulty ignition switch

Low power

- Weak battery
- Loose battery connection
- Charging system failure
- Faulty regulator/rectifier

Intermittent power

- Loose battery cable connection
- Loose charging system connection
- Loose connection or short circuit in ignition system

Charging system failure

- Loose, broken or shorted wire or connector
- Faulty regulator/rectifier
- Faulty A.C. generator

BATTERY

REMOVAL/INSTALLATION

The battery is in the battery box below seat.

1. Open the seat.
2. Remove the two screws and battery cover (1).

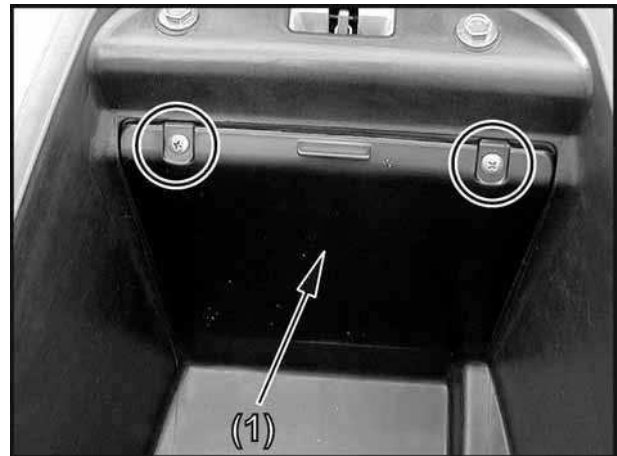

3. Remove the four screws and then remove the battery retainer (2).

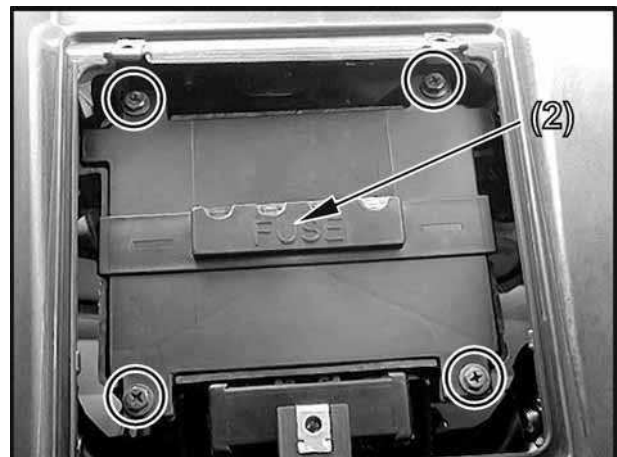

4. Pull battery out to expose the terminal leads
5. Disconnect the negative (-) terminal lead (3) from the battery first, then disconnect the positive (+) terminal lead (4).
6. Remove the battery from the battery box.

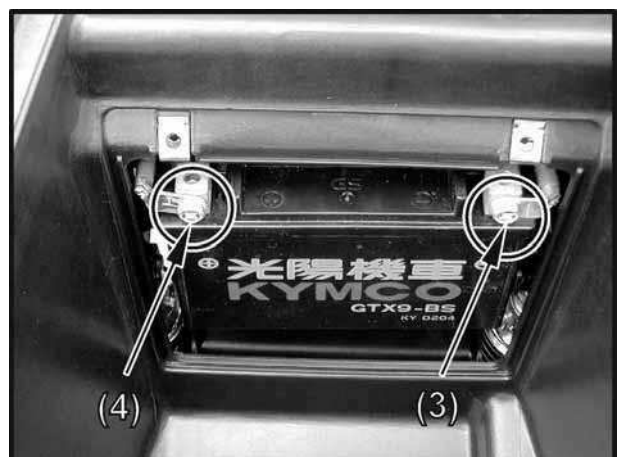

Battery installation:

Install in the reverse order of the removal.

* When install the battery, first connect the positive (+) cable and then negative (-) cable to avoid short circuit.

VOLTAGE INSPECTION

Remove the battery cover (last page).

Measure the battery voltage using a commercially available digital multimeter.

Voltage (20°C/68°C):
Fully charged: 13 – 13.2 V
Under charged: below 12.3 V



BATTERY CHARGING

Remove the battery (page 17-4).

Connect the charger positive (+) cable to the battery positive (+) terminal.

Connect the charger negative (-) cable to the battery negative (-) terminal.

* Turn the power ON/OFF at the charger, not at the battery terminals.

Charging current time:

DINK 200i:

Standard: 1 A/5 – 10 hours

Quick: 5 A/1 hours

DINK 125:

Standard: 0.8 A/5 – 10 hours

Quick: 4 A/1 hours

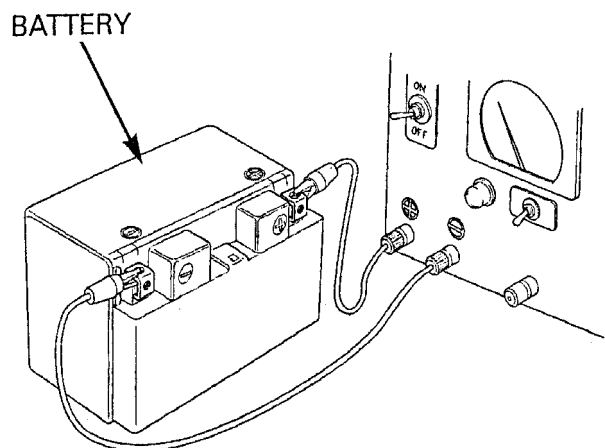

Quick charging should only be done in an emergency; slow charging is preferred. For battery charging, do not exceed the charging current and time specified on the battery. Using excessive current or extending the charging time may damage the battery.

17. BATTERY/CHARGING SYSTEM

CHARGING SYSTEM

INSPECTION

Remove the battery cover (see page 17-4).

CURRENT LEAKAGE TEST

Turn the ignition switch OFF, disconnect the negative (-) cable from the battery.

Connect the ammeter (+) probe to the negative (-) cable and the ammeter (-) probe to the battery (-) terminal.

With the ignition switch OFF, check for current leakage.

When measuring current using a tester, set it to a high range, and then bring the range down to an appropriate level. Current flow higher than the range selected may blow out the fuse in the tester.

While measuring current, do not turn the ignition switch ON. A sudden surge of current may blow out the fuse in the tester.

Specified current leakage: 5 mA max.

If current leakage exceeds the specified value, a shorted circuit is likely.

Locate the short by disconnecting connections one by one and measuring the current.



CHARGING VOLTAGE INSPECTION

Be sure that the battery is in good condition before performing this test.

* Do not disconnect the battery or any cable in the charging system without first switching off the ignition switch. Failure to follow this precaution can damage the tester or electrical components.

Start the engine and warm it up to the operating temperature; stop the engine. Connect the multimeter between the positive and negative terminals of the battery.



To prevent short, make absolutely certain which are the positive and negative terminals or cable.

With the headlight on and turned to the high beam position, restart the engine.

Measure the voltage on the multimeter when the engine runs at 5000 min⁻¹ (rpm).

Standard:

Measured battery voltage (page 17-5) <

Measure charging voltage (see above)

<15.5 V

ALTERNATOR CHARGING COIL

INSPECTION

Remove the luggage box (refer to the “**FRAME COVERS REMOVAL/INSTALLATION**” section in the chapter 2).

Disconnect the alternator connector (1).



(1)

Measure the resistance between each Yellow wire terminals.

Standard: 0.4—0.6 Ω (20°C/68°F)

Check for continuity between each Yellow wire terminal of the alternator side connector and ground.

There should be no continuity.

Replace the alternator stator if resistance is out of specification, or if any wire has continuity to ground.

Refer to chapter 10 for alternator stator replacement.



(1)

REGULATOR/RECTIFIER

WIRE HARNESS INSPECTION

Remove the luggage box (refer to the “**FRAME COVERS REMOVAL/INSTALLATION**” section in the chapter 2).

Disconnect the regulator/rectifier connectors (1).

Check the connectors for loose contacts of corroded terminals.

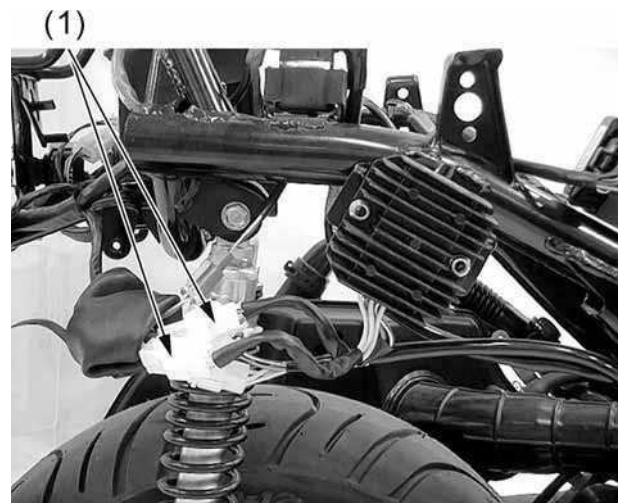

Regulator/Rectifier (DINK 200i type)

Battery line

Measure the voltage between the Red/White wire terminal and ground.

There should be battery voltage at all times.



Regulator/Rectifier (DINK 125 type)

17. BATTERY/CHARGING SYSTEM

Ground line

Check the continuity between the Green wire terminal and ground.

There should be continuity at all times.



Charging coil line

Measure the resistance between each Yellow wire terminals.

Standard: 0.4 – 0.6 Ω (20°C/68°F)



Disconnect the regulator/rectifier connector.

Check for continuity between each Yellow wire terminal regulator/rectifier side and ground.

There should be no continuity.



17. BATTERY/CHARGING SYSTEM

DINK 200i/125

REMOVAL/INSTALLATION

Remove the side body cover (refer to the “**FRAME COVERS REMOVAL/INSTALLATION**” section in the chapter 2).

Disconnect the regulator/rectifier connectors (1).

Remove the two bolts (2), regulator/rectifier (3).

Installation is in the reverse order of removal.

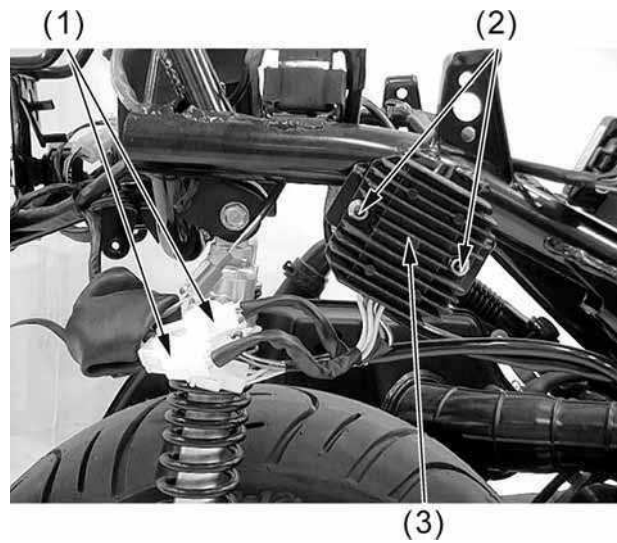

18. IGNITION SYSTEM

18

IGNITION SYSTEM

IGNITION SYSTEM LAYOUT (DINK 200i) -----	18-1
IGNITION CIRCUIT (DINK 200i) -----	18-1
IGNITION SYSTEM LAYOUT (DINK 125) -----	18-2
IGNITION CIRCUIT (DINK 125) -----	18-2
SERVICE INFORMATION-----	18-3
TROUBLESHOOTING-----	18-4
IGNITION COIL INSPECTION -----	18-5
CDI (DINK 125) -----	18-8

18. IGNITION SYSTEM

DINK 200i/125

IGNITION SYSTEM LAYOUT (DINK 200i)

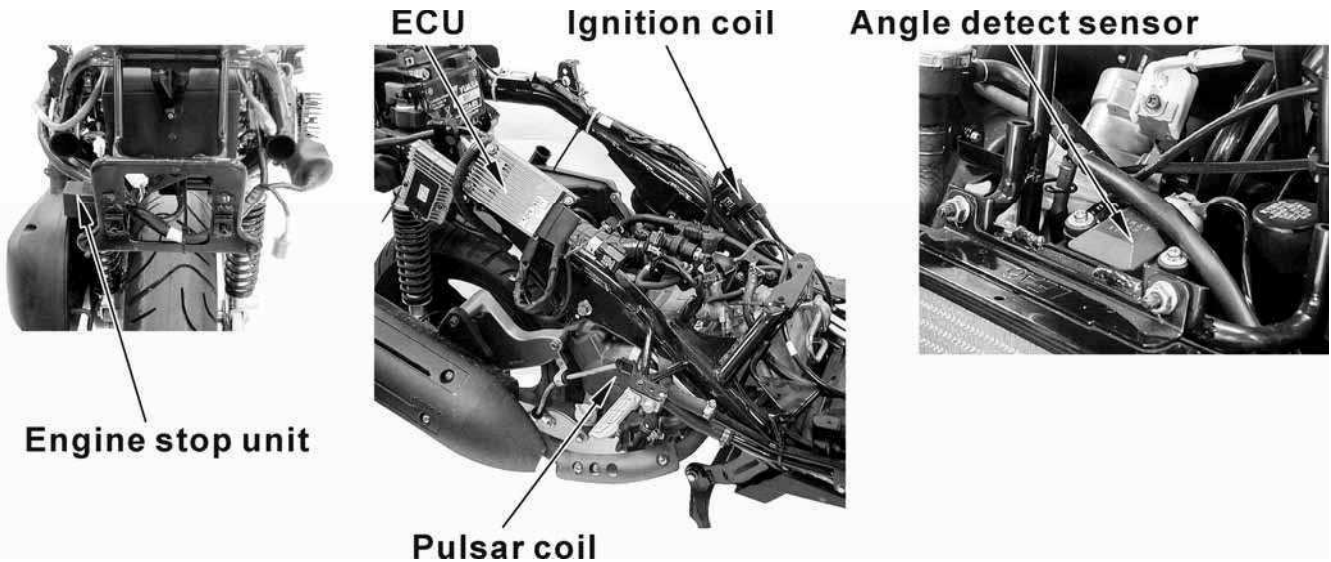

IGNITION CIRCUIT (DINK 200i)

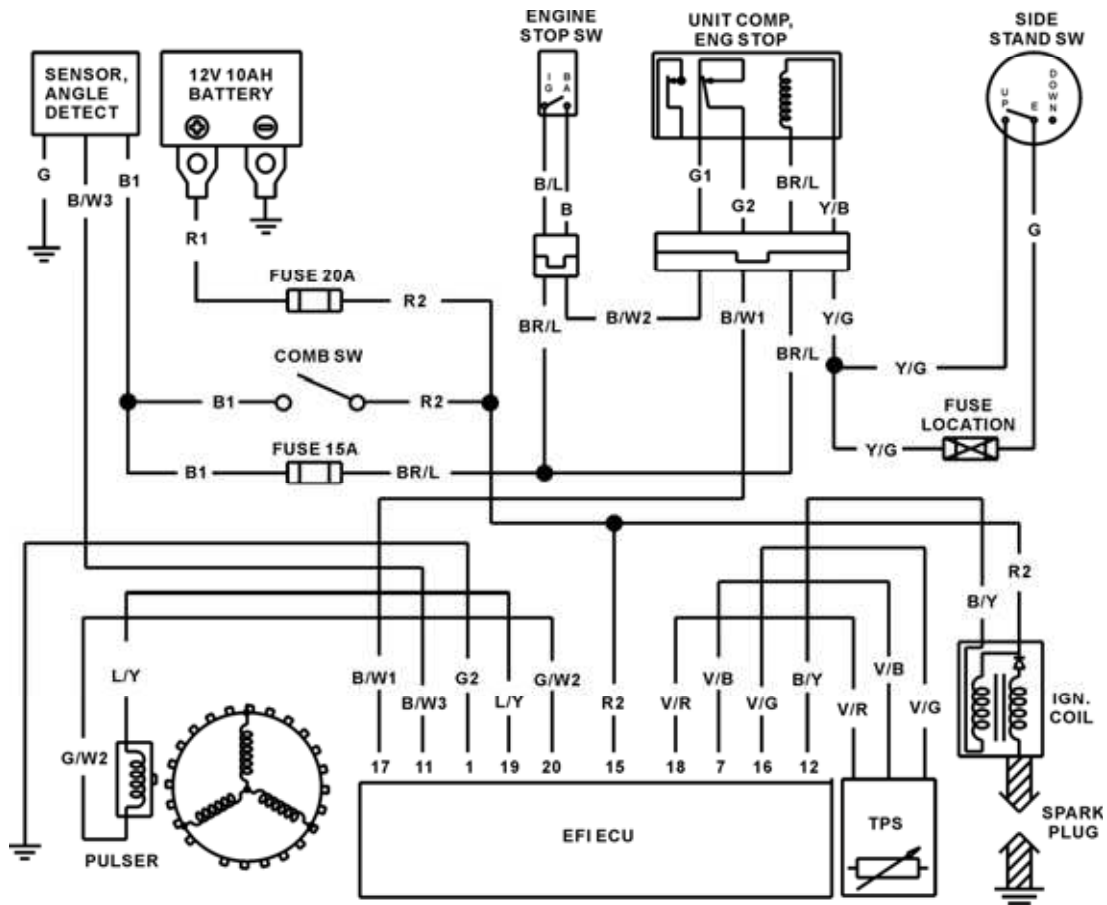

18. IGNITION SYSTEM

DINK 200i/125

IGNITION SYSTEM LAYOUT (DINK 125)

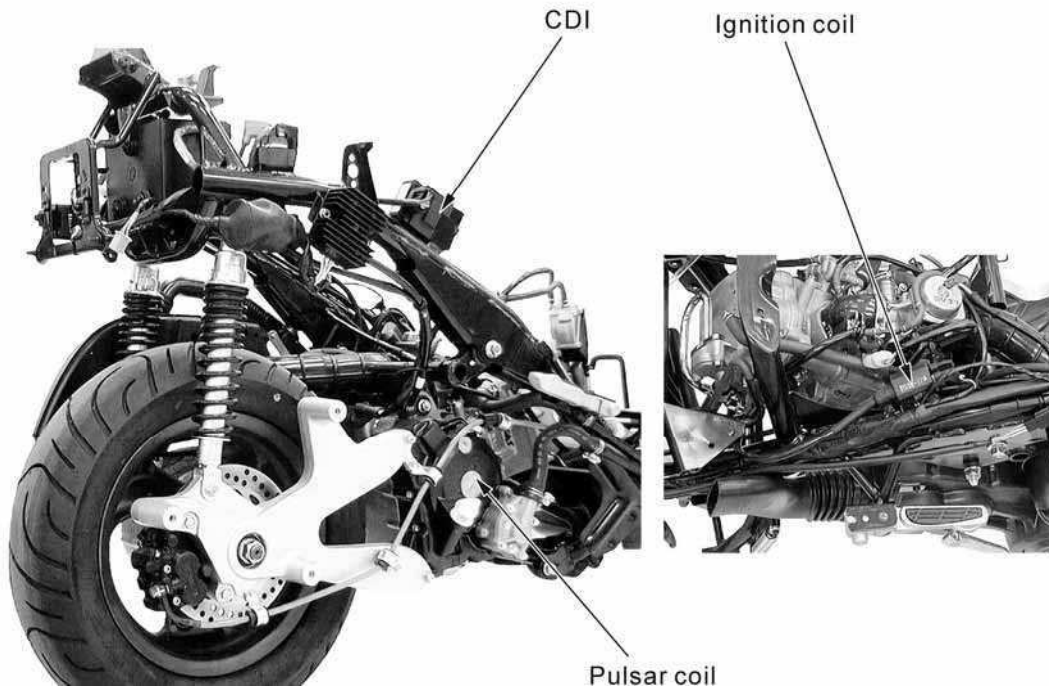

IGNITION CIRCUIT (DINK 125)

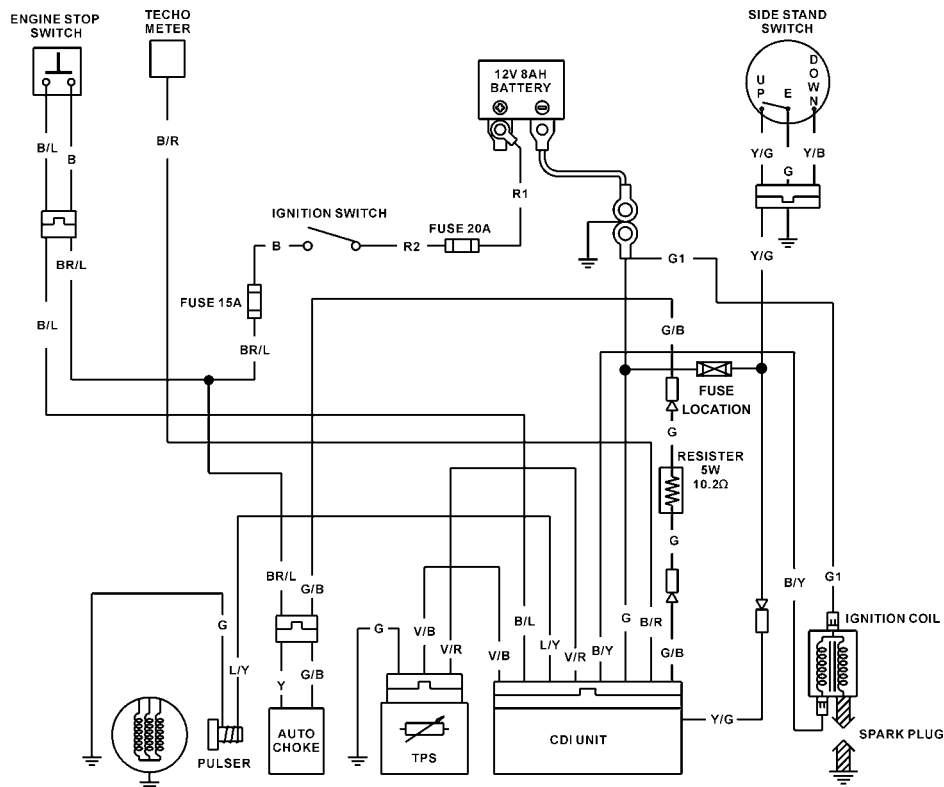

SERVICE INFORMATION

GENERAL INSTRUCTIONS (DINK 200i)

- Some electrical components may be damaged if terminals or connectors are connected or disconnected while the ignition switch is “ON” and current is present.
- When servicing the ignition system, always follow the steps in the troubleshooting.
- The ignition timing cannot be adjusted since the ignition control module is factory preset.
- The ignition control module or ECU may be damaged if dropped. Also, if the connector is disconnected when current is flowing, the excessive voltage may damage the ignition control module or ECU. Always turn off the ignition switch before servicing.
- A faulty ignition system is often related to poor connections. Check those connections before proceeding.
- Make sure the battery is adequately charged. Using the starter motor with a weak battery results in a slower engine cranking speed as well as no spark at the spark plug.
- Use a spark plug of the correct heat range. Using spark plug with an incorrect heat range can damage the engine.
- See chapter 10 for ignition pulse generator removal/installation.
- See chapter 14 for ECU removal/installation/inspection.
- See section 20 for those components: Ignition switch, Engine stop switch

GENERAL INSTRUCTIONS (DINK 125)

- Check the ignition system according to the sequence specified in the Troubleshooting.
- The ignition system adopts CDI unit and the ignition timing cannot be adjusted.
- If the timing is incorrect, inspect the CDI unit and A.C. generator and replace any faulty parts. Inspect the CDI unit with a CDI tester
- Loose connector and poor wire connection are the main causes of faulty ignition system. Check each connector before operation.
- Use of spark plug with improper heat range is the main cause of poor engine performance.
- The inspections in this section are focused on maximum voltage. The inspection of ignition coil resistance is also described in this chapter.
- Inspect the ignition switch according to the continuity table specified in chapter 20.
- Inspect the spark plug referring to chapter 3.
- Remove the A.C. generator and pulser coil referring to chapter 10.

SPECIFICATIONS

Item		Standard
Spark plug	DINK 200i	NGK DPR6EA-9
	DINK 125	NGK DP7EA-9
Spark plug gap		0.8~0.9 mm (0.032~0.036 in)
Ignition timing		TPS
Ignition system	DINK 200i	ECU
	DINK 125	CDI

18. IGNITION SYSTEM

TROUBLESHOOTING

DINK 200i

LOW PEAK VOLTAGE

- Cranking speed is too low (battery is undercharged).
- Poorly connected connectors or an open circuit in the ignition system.
- Faulty ignition-coil.
- Faulty ignition control module.

NO PEAK VOLTAGE

- Short circuit in engine stop switch or ignition switch wire.
- Faulty engine stop switch or ignition switch.
- Loose or poorly connected ignition control module connectors.
- Open circuit or poor connection in ground wire of the ignition control module.
- Faulty ignition pulse generator.
- Faulty ignition control module.

PEAK VOLTAGE IS NORMAL, BUT NO SPARK JUMPS AT THE PLUG

- Faulty spark plug or leaking ignition coil secondary current.
- Faulty ignition coil.

DINK 125

No spark at plug

- Faulty spark plug
- Poorly connected, broken or shorted wire
- Faulty ignition switch
- Faulty ignition coil
- Faulty CDI unit
- Faulty A.C. generator

Engine starts but turns poorly

- Ignition primary circuit
 - Faulty ignition coil
 - Poorly connected wire or connector
 - Poorly contacted ignition switch
- Ignition secondary circuit
 - Faulty ignition coil
 - Faulty spark plug
 - Faulty high-tension wire
 - Poorly insulated plug cap
- Improper ignition timing
 - Faulty A.C. generator
 - Stator not installed properly
 - Faulty CDI unit

18. IGNITION SYSTEM

DINK 200i/125

IGNITION COIL INSPECTION

IGNITION COIL PRIMARY PEAK VOLTAGE

Remove the center cover (refer to the “FRAME COVERS REMOVAL/INSTALLATION” section in the chapter 2).

Check cylinder compression and check that the spark plug (1) is installed correctly in the cylinder.

Disconnect the spark plug cap (2) from the spark plug.

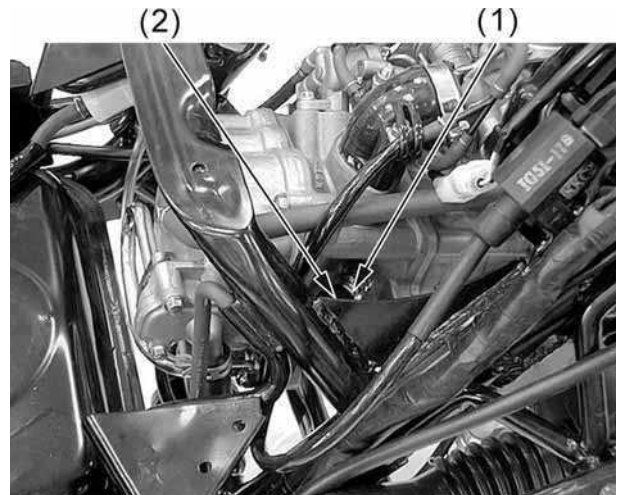

Connect known good spark plug to the spark plug cap and ground the spark plugs to the cylinder as done in the spark test.

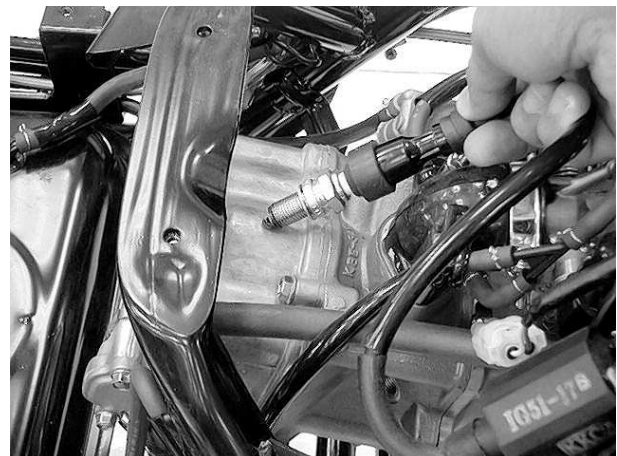

DINK 200i:

Turn the ignition switch to “ON” and engine stop switch ON and side stand is up.

Connect the multimeter (+) probe to the Red wire and the multimeter (-) to the body ground.

Check for initial voltage at this time.

The battery voltage should be measured.

If the initial voltage cannot be measured, check the power supply circuit.



18. IGNITION SYSTEM

DINK 125:

Turn the ignition switch to “ON” and engine stop switch ON and side stand is up.

Connect the multimeter (+) probe to the Black/Yellow wire and the multimeter (-) to the body ground.

Check for initial voltage at this time.

The battery voltage should be measured.

If the initial voltage cannot be measured, check the power supply circuit.

IGNITION PULSE GENERATOR INSPECTION

Remove the luggage box (refer to the “**FRAME COVERS REMOVAL/INSTALLATION**” section in the chapter 2).

Disconnect the ignition pulse generator connector (1).



(1)

Measure the ignition pulse generator resistance between the Green/White wire and Blue/Yellow wire.

Standard:

DINK 200i: 16.4Ω (20°C/68°F)

DINK 125: 106Ω (20°C/68°F)

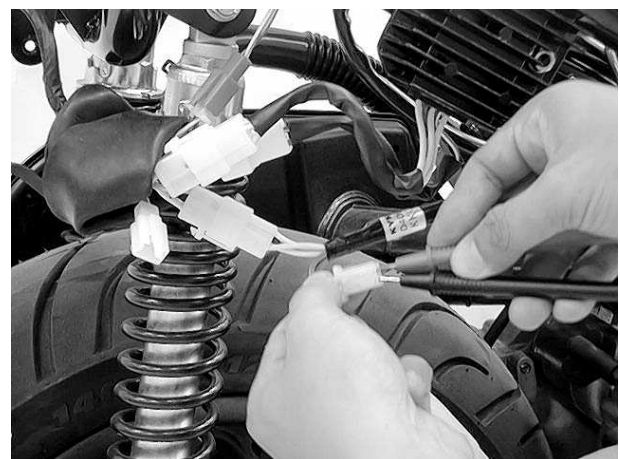

18. IGNITION SYSTEM

DINK 200i/125

IGNITION COIL REMOVAL/INSTALLATION

Remove the luggage box (refer to the “FRAME COVERS REMOVAL/INSTALLATION” section in the chapter 2).

Disconnect the spark plug cap from the spark plug (1).

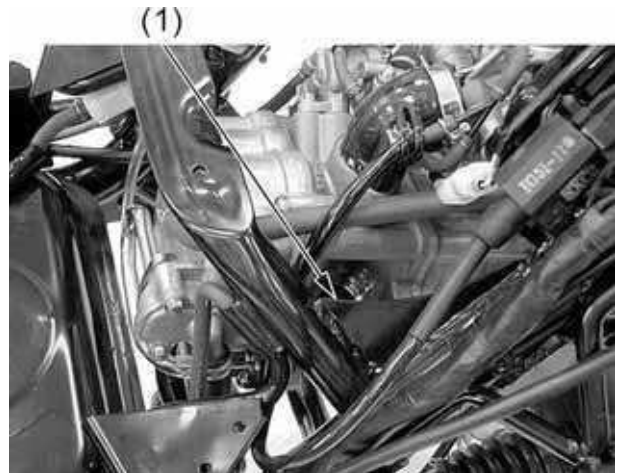

DINK 200i:

Disconnect the ignition coil primary connector (2).

Remove the two bolts (3) and the ignition coil (4).

Installation is in the reverse order of removal.

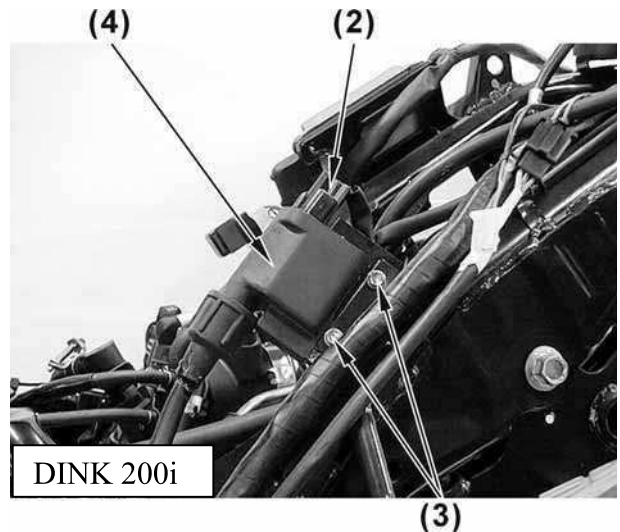

DINK 125:

Disconnect the ignition coil primary connectors (2).

Remove the bolt (3) and the ignition coil (4).

Installation is in the reverse order of removal.

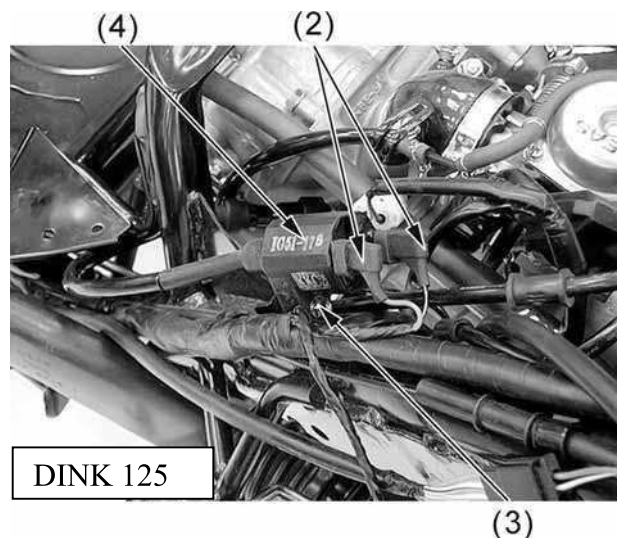

18. IGNITION SYSTEM

CDI (DINK 125)

REMOVAL/INSTALLATION

Remove the luggage box (refer to the “**FRAME COVERS REMOVAL/INSTALLATION**” section in the chapter 2).

Disconnect the CDI connectors (1) and remove the CDI (2).

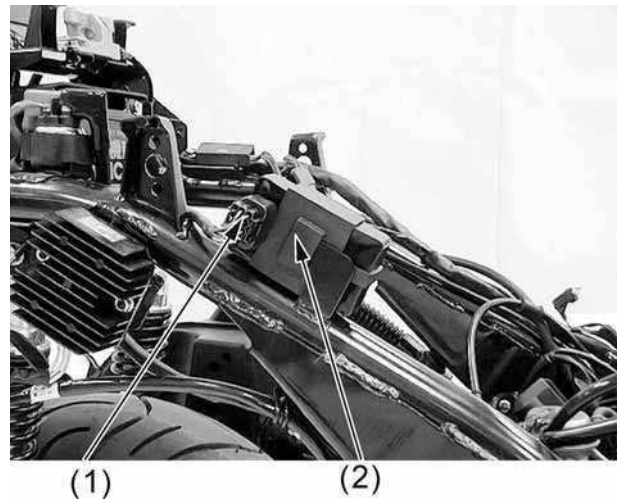

RESISTANCE INSPECTION

Measure the resistance between the terminals.

* Due to the semiconductor in circuit, it is necessary to use a specified tester for accurate testing. Use of an improper tester in an improper range may give false readings.

18. IGNITION SYSTEM

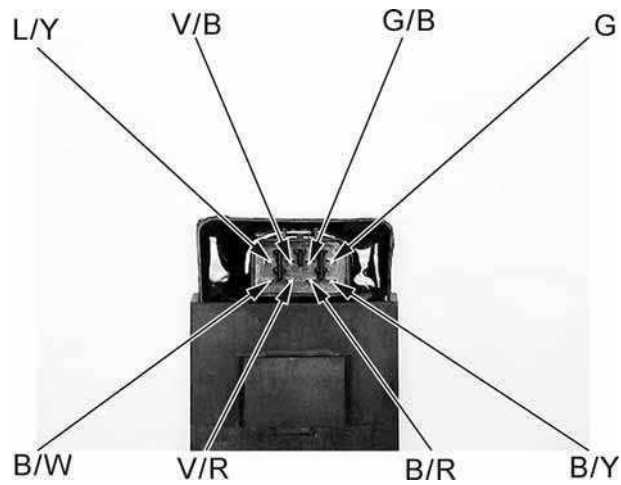

Unit: Ω

(-) \ (+)	L/Y	V/B	G/B	G	B/W	V/R	B/R	B/Y
L/Y		0.27M		1K		2K	6K	0.32M
V/B	0.27M			0.27M		0.27M	0.27M	0.58M
G/B	7.74M	8M		7.74M		7.74M	7.74M	8M
G	1K	0.27M				1K	5K	0.32M
B/W								
V/R	2K	0.27M		1K			6K	0.32M
B/R	6K	0.27M		4.94K		6K		0.32M
B/Y	0.32M	0.6M		0.32M		0.32M	0.32M	

19. STARTING SYSTEM



STARTING SYSTEM

19

STARTING SYSTEM LAYOUT	19-1
STARTING CIRCUIT	19-1
SERVICE INFORMATION.....	19-2
TROUBLESHOOTING.....	19-2
STARTER MOTOR	19-3
STARTER RELAY INSPECTION.....	19-5

19. STARTING SYSTEM

STARTING SYSTEM LAYOUT

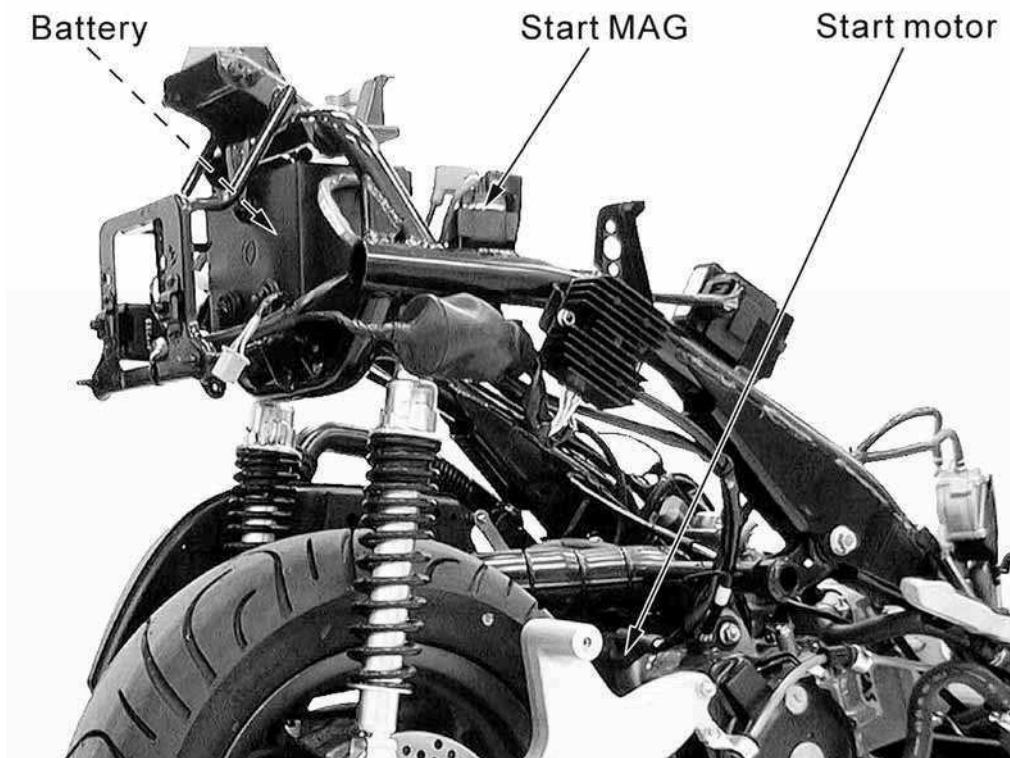

STARTING CIRCUIT

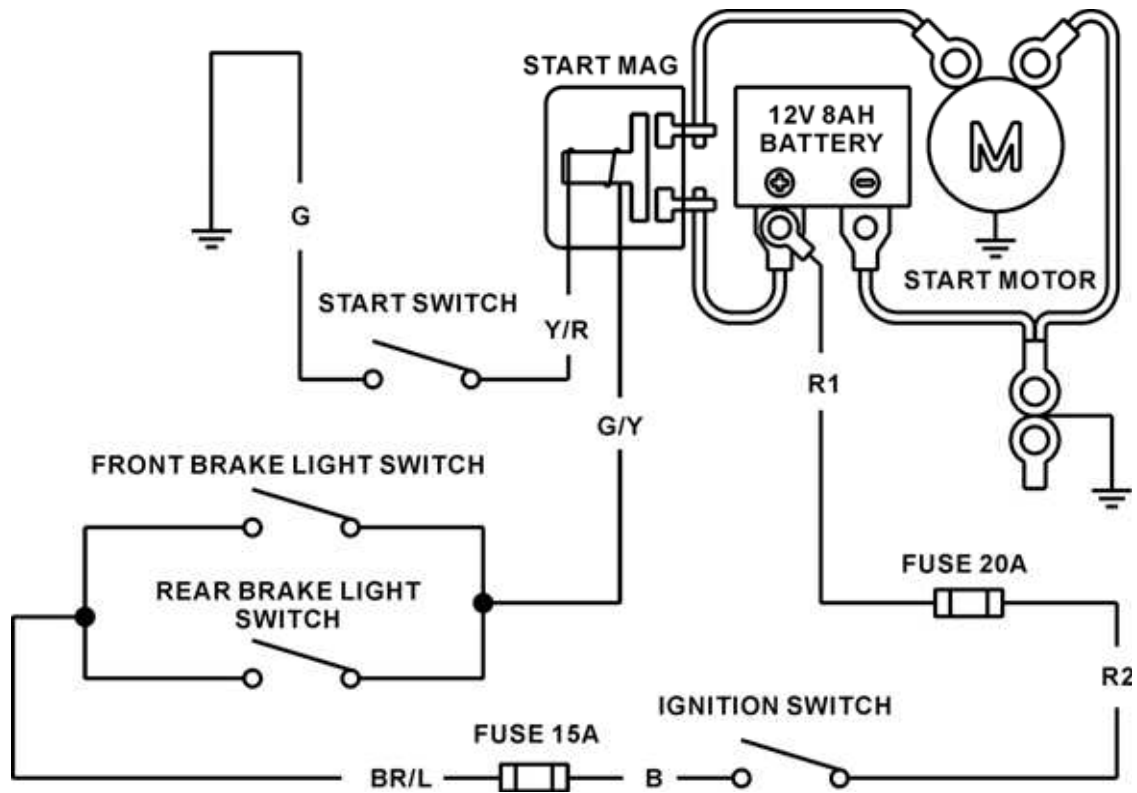

19. STARTING SYSTEM

SERVICE INFORMATION

GENERAL INSTRUCTIONS

- The removal of starter motor can be accomplished with the engine installed.
- For the starter clutch removal, refer to the chapter 10.
- After the starter clutch is installed, be sure to add the engine oil and coolant and then bleed air from the cooling system.

TORQUE VALUES

Starter motor mounting bolt 1 kgf-m (10 N-m, 7 lbf-ft)

TROUBLESHOOTING

Starter motor won't turn

- Fuse burned out
- Weak battery
- Faulty ignition switch
- Faulty starter clutch
- Faulty front or rear stop switch
- Faulty starter relay
- Poorly connected, broken or shorted wire
- Faulty starter motor

Lack of power

- Weak battery
- Loose wire or connection
- Foreign matter stuck in starter motor or gear

Starter motor rotates but engine does not start

- Faulty starter pinion
- Starter motor rotates reversely
- Weak battery

START MOTOR

INSPECTION

Disconnect the start motor cable (2) from the start MAG (1).

Connect the start motor cable directly to the battery positive terminal (3).

If the start motor does not turn, the starter motor is faulty.

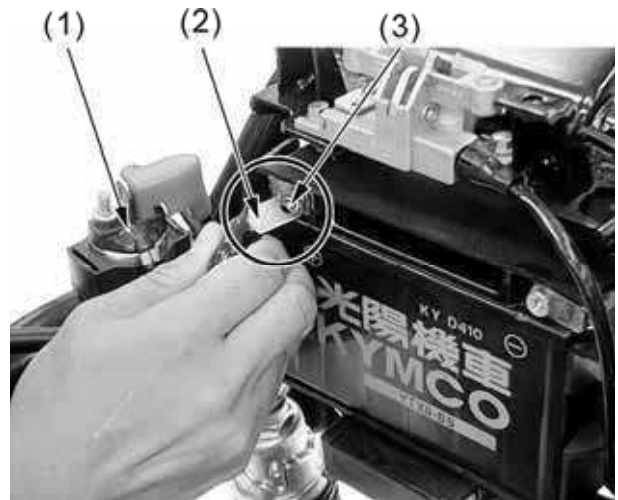

REMOVAL

Remove the air cleaner (refer to the “CARBURETOR” section in the chapter 13).

Turn the ignition switch turned to “OFF”

Release the rubber cap (1) and remove the terminal screw (2) to disconnect the start motor cable from the start motor.

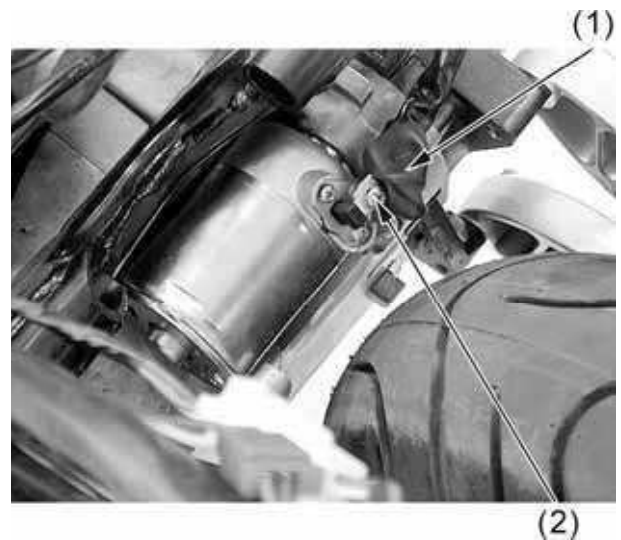

Remove the two mounting bolts (3) and engine ground cable (4), then remove the start motor.

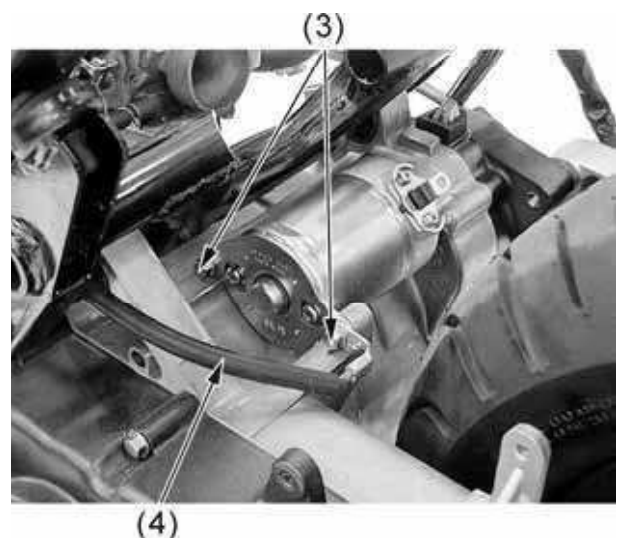

19. STARTING SYSTEM

INSTALLATION

Coat a new O-ring (1) with engine oil and install it into the start motor groove.

Install the starter motor into the crankcase.

Install the two mounting bolts and engine ground cable, then tighten the bolts securely.

Connect the start motor cable to motor terminal with the terminal screw and tighten it securely.

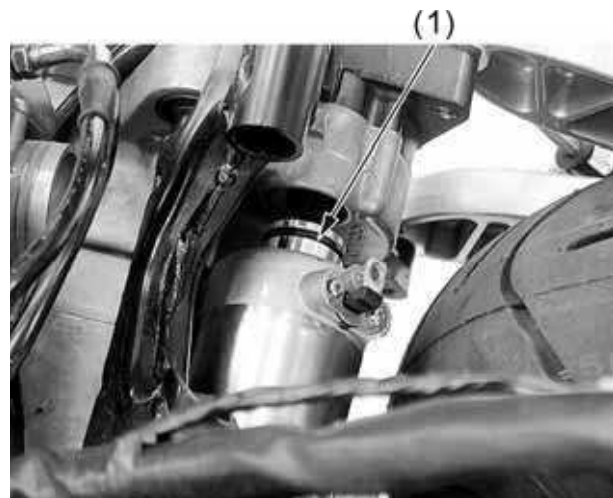

19. STARTING SYSTEM

DINK 200i/125

START RELAY INSPECTION

Release the rubber cap (1) and remove the nut (2), then disconnect the start motor cable. Turn the ignition switch to “ON”.

Squeeze and hold the brake lever fully then push the starter switch.

The coil is normal if the start MAG switch clicks.

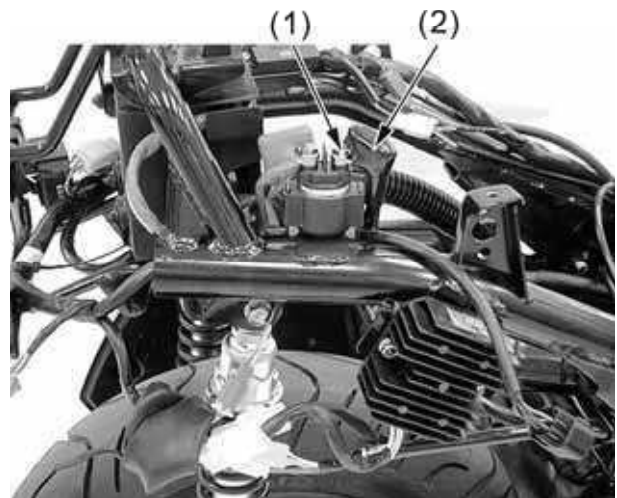

Release the rubber caps (1) and remove the nuts (2), then disconnect the start motor cable, battery positive cable and harness wire.

Disconnect the start MAG switch connector (3) and then remove start MAG.

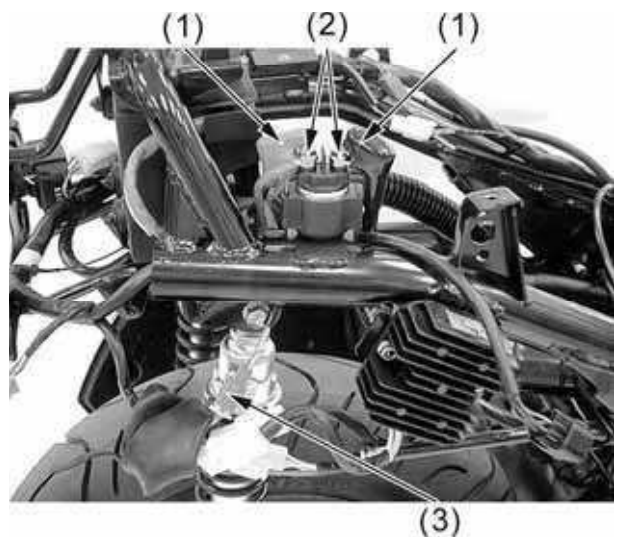

Connect a fully charged 12 V battery positive wire to the relay switch Yellow/Red wire terminal and negative wire to the Green/Yellow wire terminal.

There should be continuity between the cable terminals while the battery is connected, and no continuity when the battery is disconnected.

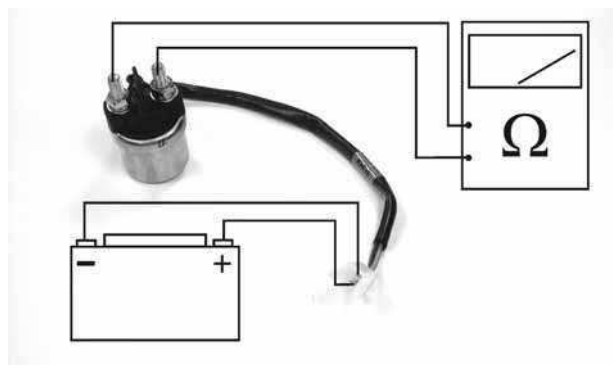

LIGHTS/METERS/SWITCHES

SERVICE INFORMATION-----	20- 1
BULB REPLACEMENT -----	20- 2
BRAKE LIGHT SWITCH-----	20- 6
IGNITION SWITCH -----	20- 6
HANDLEBAR SWITCH -----	20- 7
LUGGAGE BOX LIGHT SWITCH -----	20- 9
FUEL UNIT -----	20-10
SIDE STAND SWITCH -----	20-13
HORN -----	20-14
HEATER CONTROLLER UNIT (DINK 125) -----	20-15

20. LIGHTS/METERS/SWITCHES

SERVICE INFORMATION

GENERAL

- | |
|--|
| A halogen head light bulb becomes very hot while the head light is on, and remains for a while after it is turned off. Be sure to let it cool down before servicing. |
|--|

- Note the following when replacing the halogen headlight bulb
 - Wear clean gloves while replacing the bulb. Do not put finger prints on the headlight bulb, as they may create hot spots on the bulb and cause it to fail.
 - If you touch the bulb with your bare hands, clean it with a cloth moistened with alcohol to prevent its early failure.
 - Be sure to install the dust cover after replacing the bulb.

- Check the battery condition before performing any inspection that requires proper battery voltage.
- A continuity test can be made with the switches installed on the scooter.
- Route the wires and cables properly after servicing each component.

20. LIGHTS/METERS/SWITCHES

BULB REPLACEMENT

POSITION LIGHT

Remove the front cover (refer to the “**FRAME COVERS REMOVAL/INSTALLATION**” section in the chapter 2).

Remove the bulb socket (1).

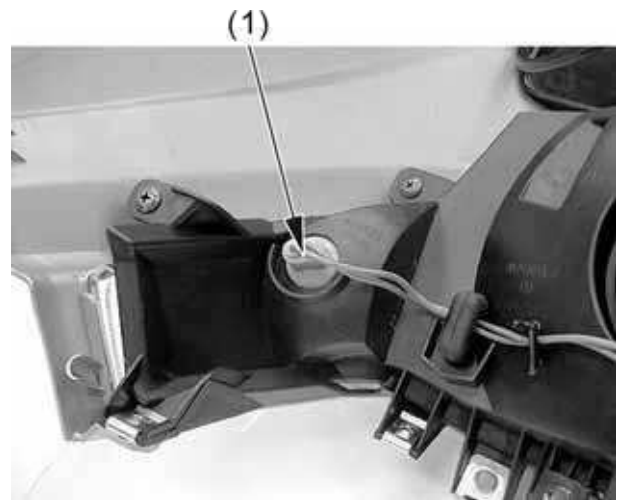

Remove the bulb (2) and replace with a new one.

Installation is in the reverse order of removal.

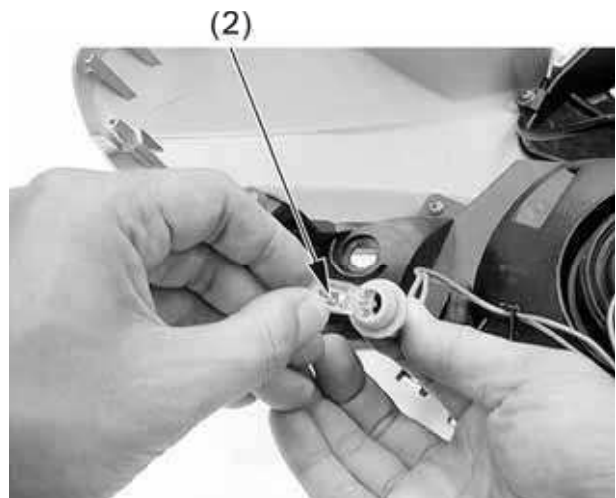

20. LIGHTS/METERS/SWITCHES

HEADLIGHT

- A halogen headlight bulb becomes very hot while the headlight is ON, and remain for a while after it is turned OFF. Be sure to let it cool down before servicing.

Remove the front cover (refer to the “**FRAME COVERS REMOVAL/INSTALLATION**” section in the chapter 2).

Disconnect the headlight connector (1) from the headlight bulb and remove the dust cover (2).

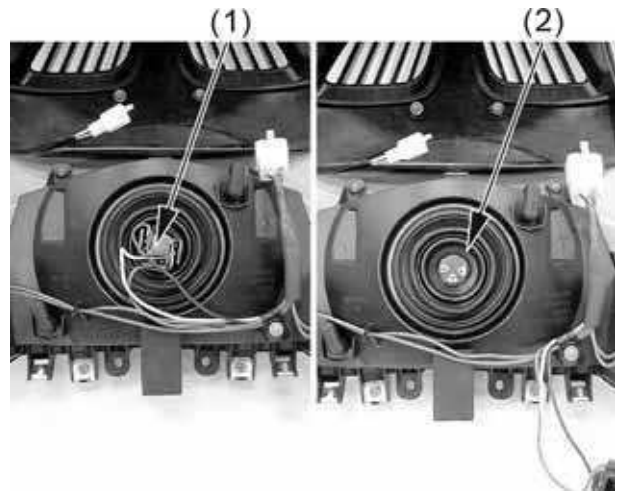

Unhook the retainer (3) and remove the bulb (4) from the headlight case.

- Avoid touching the halogen headlight bulb. Finger prints can create hot spots that cause a bulb to break.

Install a new bulb in the headlight case, by aligning the bulb tab with the case groove.

Hook the retainer.

Install the dust cover properly on to the headlight and connect the headlight connector

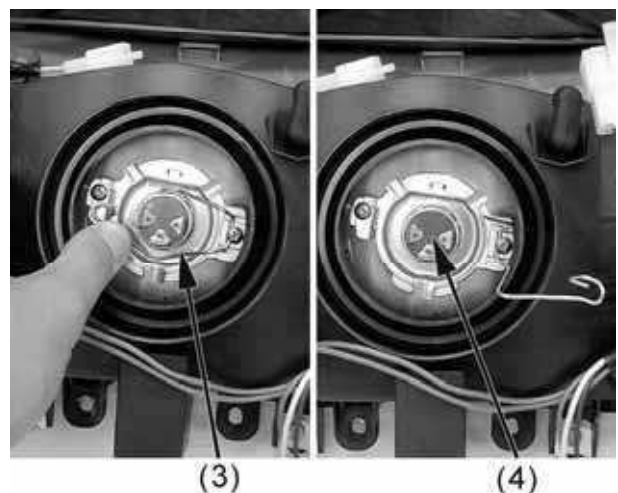

20. LIGHTS/METERS/SWITCHES

FRONT TURN SIGNAL LIGHT

Remove the two screws, then remove the front turn signal light cover.



Push and turn the bulb counterclockwise to remove it, then replace with a new one..

Installation is in the reverse order of removal.



TAILLIGHT/BRAKE LIGHT/REAR TURN SIGNAL LIGHT

Remove the four screws, then remove the light cover.

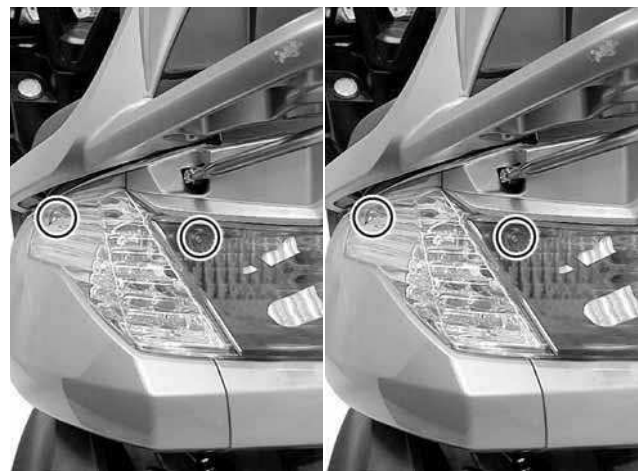

20. LIGHTS/METERS/SWITCHES

Rear turn signal light

Remove the screw and then remove the bulb cover.

Push and turn the bulb counterclockwise to remove it, then replace with a new one.

Installation is in the reverse order of removal.

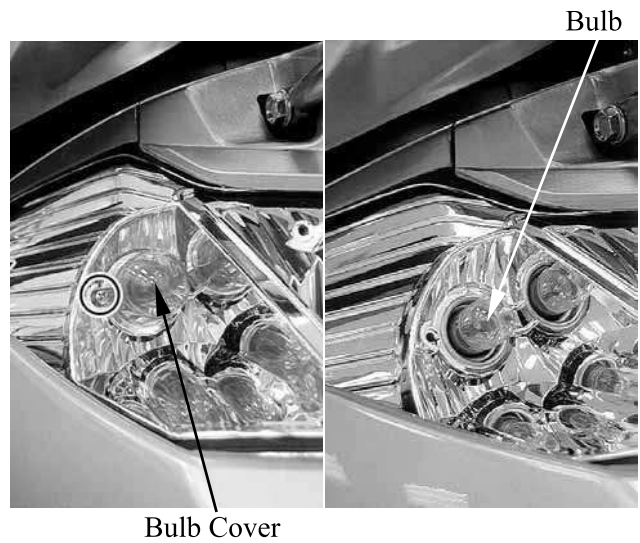

Taillight/Brake light

Push and turn the bulb counterclockwise to remove it, then replace with a new one..

Installation is in the reverse order of removal.

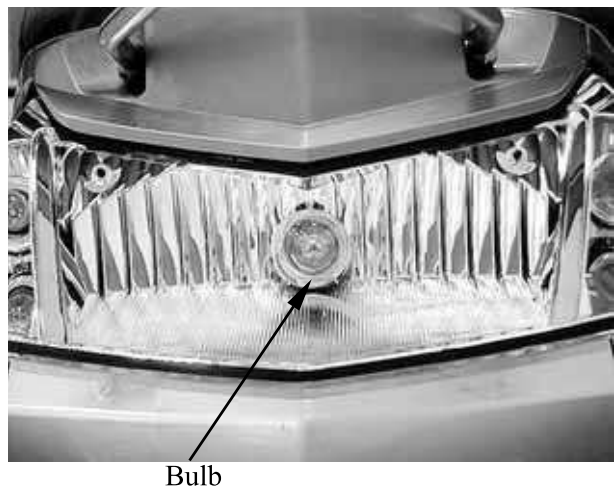

LICENSE LIGHT

Remove the bulb socket (1).

Remove the bulb (2) and replace with a new one.

Installation is in the reverse order of removal.

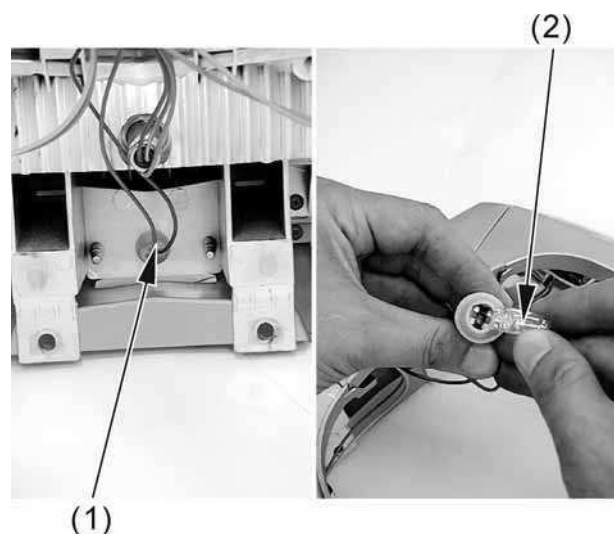

20. LIGHTS/METERS/SWITCHES

BRAKE LIGHT SWITCH

Remove the upper handlebar cover (refer to the “**FRAME COVERS REMOVAL/INSTALLATION**” section in the chapter 2).

Disconnect front or rear light switch connectors and check for continuity between the switch terminals (1).

There should be continuity with the front or rear brake lever squeezed, and there should be no continuity with the front or rear brake lever is released.



IGNITION SWITCH

INSPECTION

Remove the front cover (refer to the “**FRAME COVERS REMOVAL/INSTALLATION**” section in the chapter 2).

Disconnect the ignition switch connector (2) and check the ignition switch (1) for continuity at the switch side connector terminals.

Continuity should exist between the color code wires as follows:

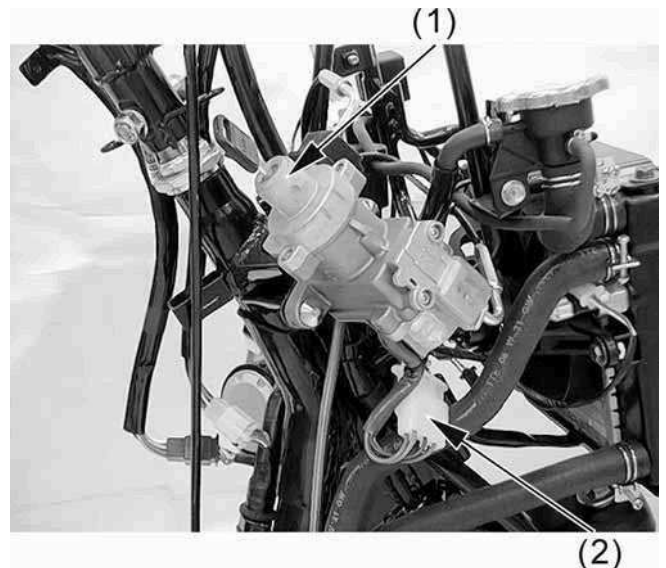

IGNITION SWITCH

	BAT2	IG	E	BAT1	HA
LOCK		○—○			
OFF		○—○	○—○	○—○	○—○
ON	○—			○—○	○—○
COLOR	B	B/W	G	R2	B/L

20. LIGHTS/METERS/SWITCHES

HANDLEBAR SWITCH

INSPECTION

Remove the front cover (refer to the “FRAME COVERS REMOVAL/INSTALLATION” section in the chapter 2).

Right handlebar switch

Disconnect the right handlebar switch connector and check for continuity at switch side connector terminals.

Continuity should exist between the color code wires as follows:

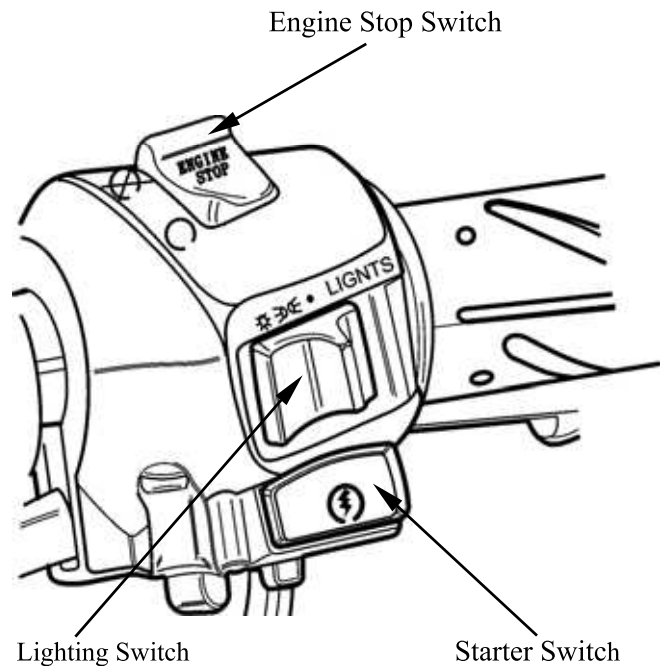

LIGHTING SW

	BAT3	TL	BAT3	HL
●				
P	○—○			
H	○—○	○—○	○—○	
COLOR	BR/L	BR	BR/L	W/L

START SW

	ST	E
FREE		
PUSH	○—○	
COLOR	Y/R	G

ENGINE STOP SW

	IG	BAT
⌚	○—○	
⊗		
COLOR	B/L	B

20. LIGHTS/METERS/SWITCHES

DINK 200i/125

Left handlebar switch

Disconnect the left handlebar switch connector and check for continuity at switch side connector terminals.

Continuity should exist between the color code wires as follows:

TURN SIGNAL LIGHT SW

	R	L	WR
L		○—○	
N			
R	○—○		
COLOR	SB	O	GR

HORN SW

	HO	BAT
FREE		
PUSH	○—○	
COLOR	LG	BR/L

DIMMER SW

	HL	HI	LO
LO	○—○		○
N	○—○—○		
HI	○—○		
COLOR	L/W	L	W

PASSING SW

	HI	PASS
FREE		
PUSH	○—○	
COLOR	L	BR/L

Dimmer Switch

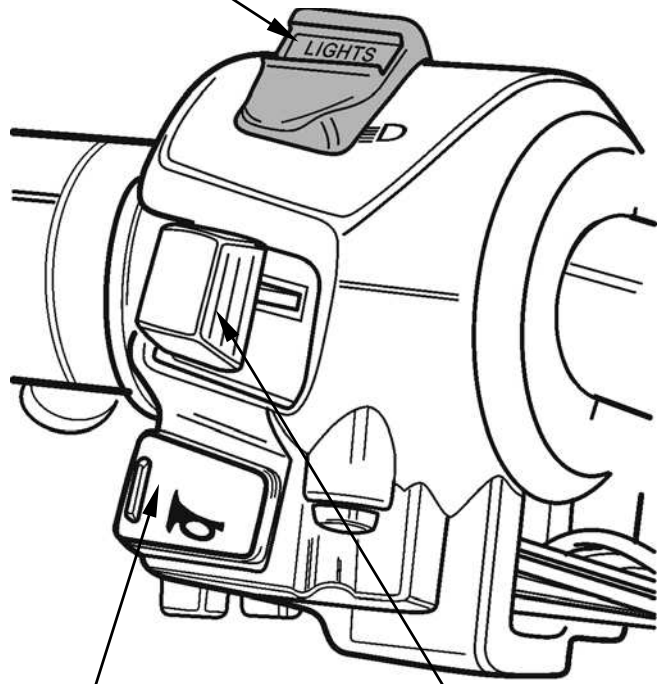

Horn Switch

Turn Signal light Switch

Passing Switch

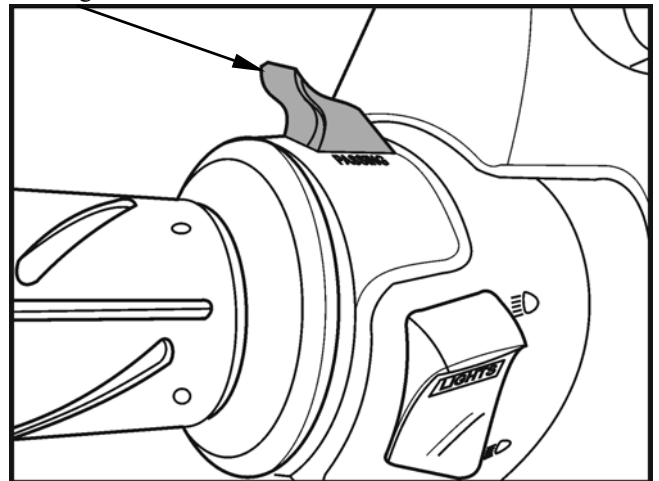

20. LIGHTS/METERS/SWITCHES

LUGGAGE BOX LIGHT SWITCH

INSPECTION

Remove the luggage box (refer to the “**FRAME COVERS REMOVAL/INSTALLATION**” section in the chapter 2).

Disconnect the luggage box light switch connector (2) and check the luggage box light switch (1) for continuity between the switch terminals.

There should be no continuity with the luggage box light switch pushed, and there should be continuity with the luggage box light switch is released.

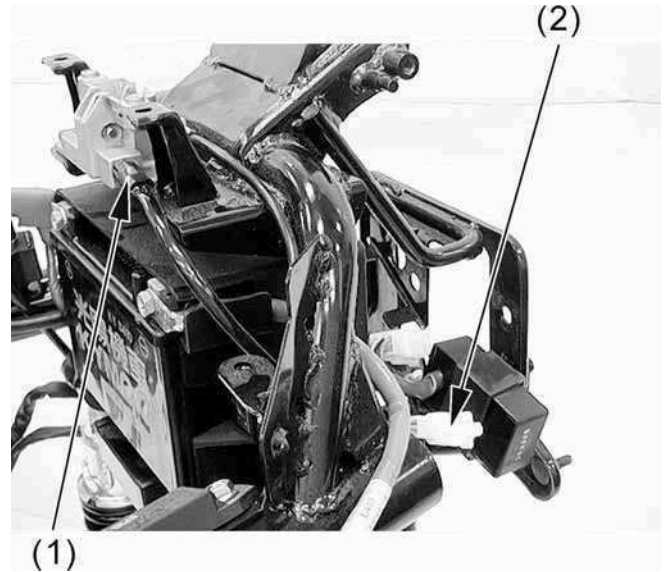

FUEL UNIT**REMOVAL**

Remove the floorboard (refer to the “**FRAME COVERS REMOVAL/INSTALLATION**” section in the chapter 2).

Remove the four nuts (1) and then remove the bridge plate (2).

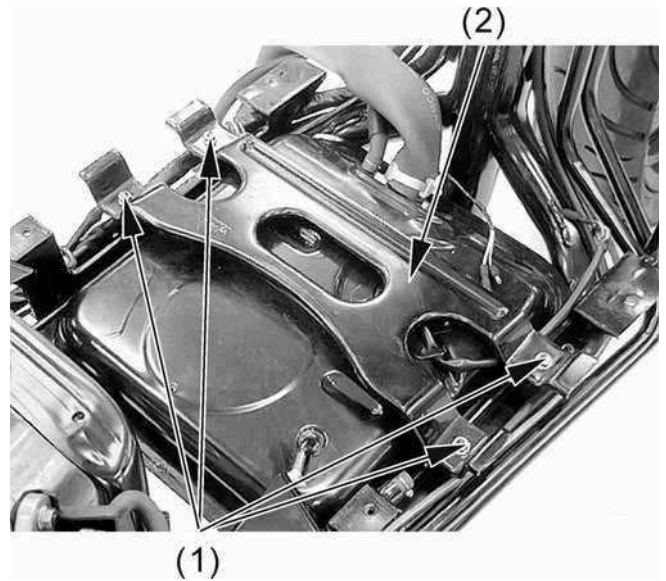

Disconnect the fuel unit connectors (3).

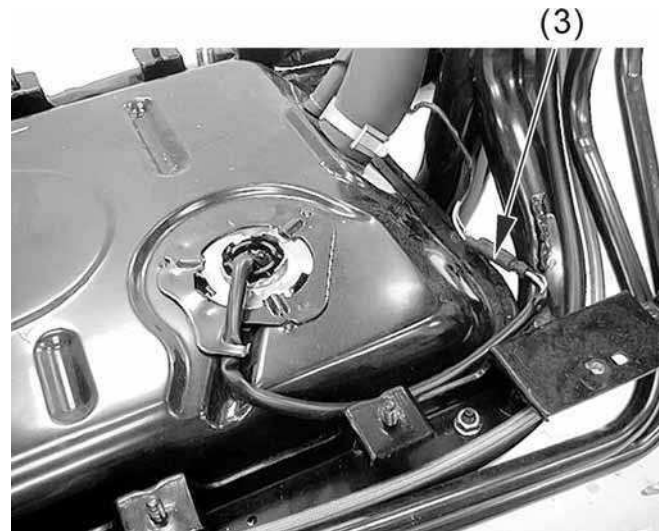

Turn the fuel unit retainer (4) counterclockwise and remove it.

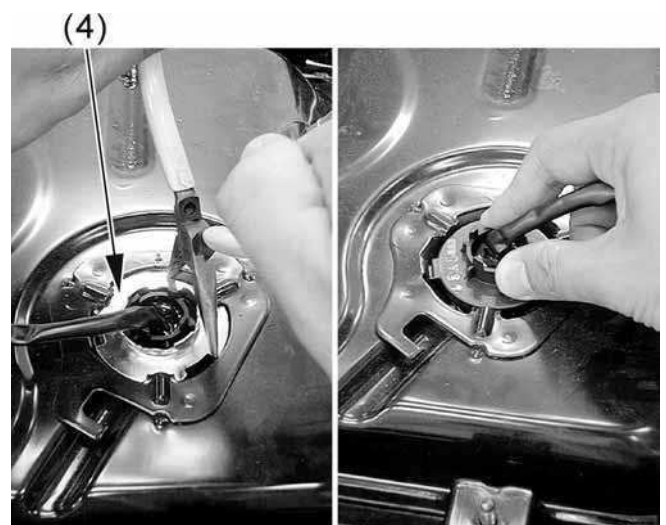

20. LIGHTS/METERS/SWITCHES

Remove the fuel unit (5).

- Be careful not to bend or damage the fuel unit float arm.

INSPECTION

Connect the fuel unit wire connectors and turn the ignition switch "ON".

- Before performing the following test, operate the turn signals to determine that the battery circuit is normal.

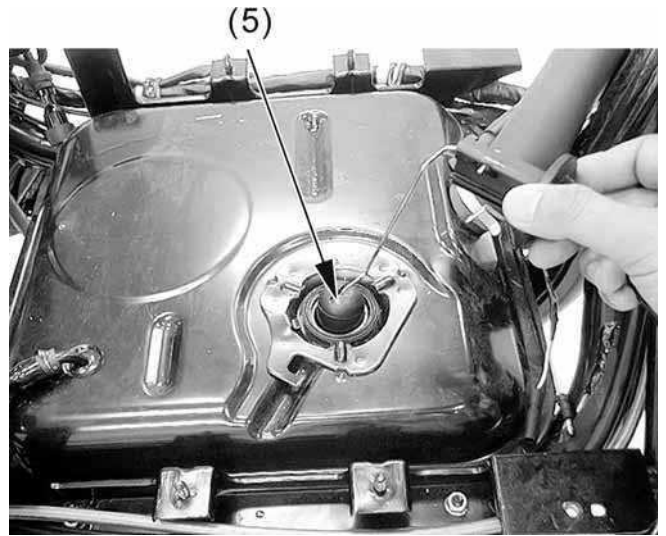

Check the fuel meter for correct indication by moving the fuel unit float up and down.

Float Position	Display
Upper	Much (Full)
Lower	Less (Empty)

Wire Terminals	Display
Free	From Much to Less
Apply	From Less to Much

The fuel meter is normal if it operates as above indicated. If not, check for poorly connected terminals or shorted wires.

Measure the resistance between the Yellow/White and Blue/White terminals of the fuel unit connector.

Standard (at 20°C/68°F):

Float at full position	1100 ± 33 Ω
Float at empty position	100 ± 3 Ω

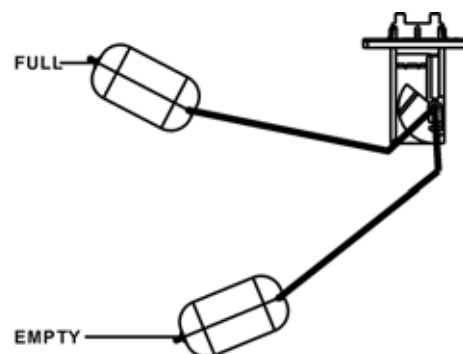
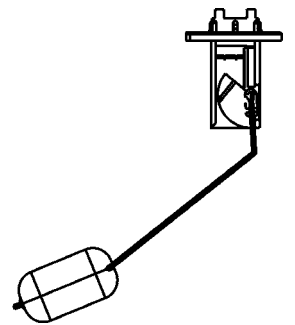
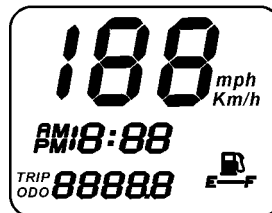
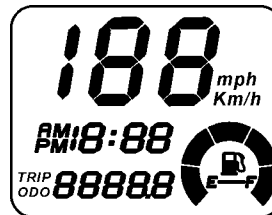

20. LIGHTS/METERS/SWITCHES

INSTALLATION

Install the O-ring (1) and fuel unit (2).

- | |
|---|
| Align the groove on the fuel unit with the flange on the fuel tank. |
|---|

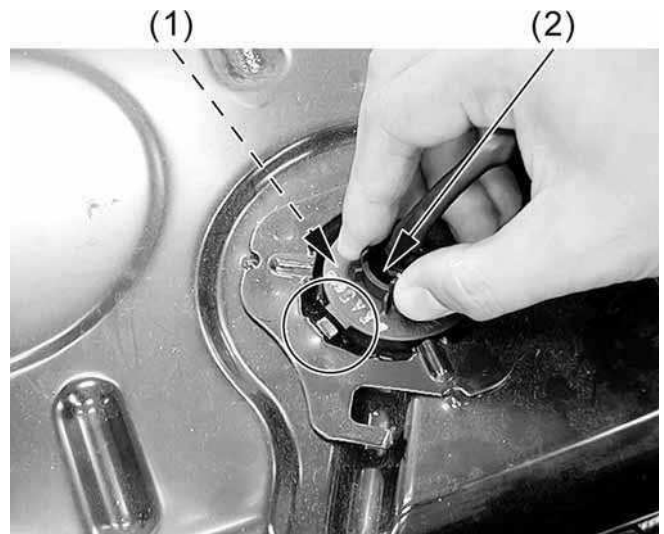

Install the fuel unit retainer.

- | |
|--|
| Align the arrow mark on the fuel unit retainer with the arrow mark on the fuel tank. |
|--|

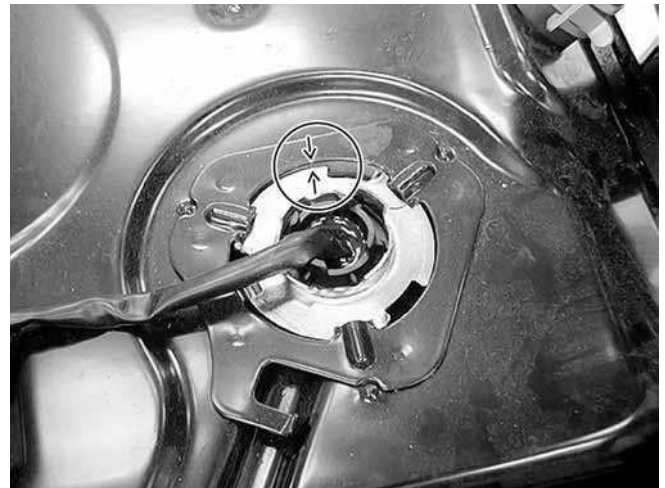

20. LIGHTS/METERS/SWITCHES

SIDE STAND SWITCH

INSPECTION

Remove the luggage box (refer to the “**FRAME COVERS REMOVAL/INSTALLATION**” section in the chapter 2).

Side stand switch (1) is located on side stand

Disconnect the side stand switch connector (2).

There should be continuity between the Yellow/Green and Green with the side stand retracted.

There should be continuity between the Yellow/Black and Green with the side stand applied.

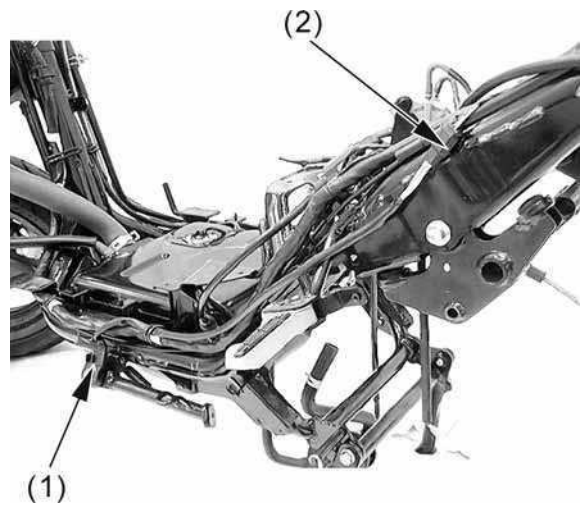

REMOVAL

Disconnect the side stand switch connector.
Remove the bolt (1) and side stand switch from the side stand.

INSTALLATION

Installs the side stand switch aligning the groove on the switch with the pin on the side stand stay.

Install and tighten the side stand switch bolt securely.

Connect the side stand switch connector.

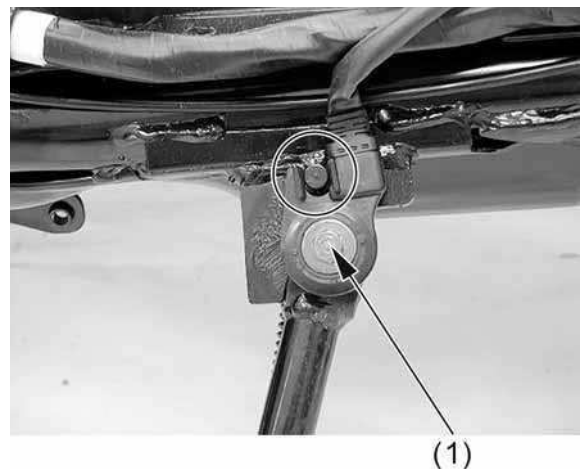

20. LIGHTS/METERS/SWITCHES

HORN

INSPECTION

Remove the front cover (refer to the “**FRAME COVERS REMOVAL/INSTALLATION**” section in the chapter 2)

Disconnect the horn connectors (1) from the horn.

Connect a 12 V battery to the horn terminals.
The horn is normal if it sounds when the 12 V battery is connected across the horn terminals.

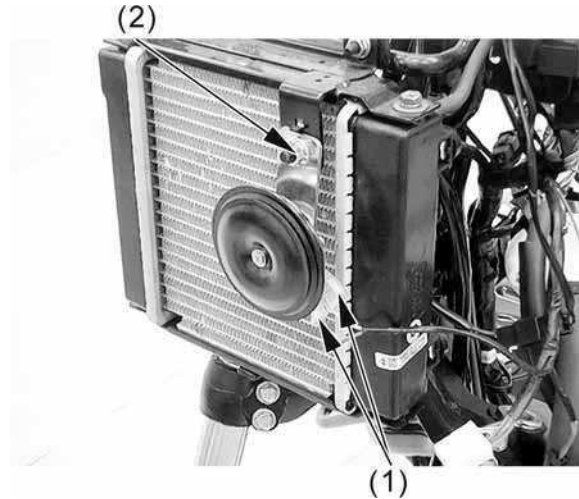

REMOVAL/INSTALLATION

Disconnect the horn connectors from the horn.

Remove the nut (2) and horn.

Installation is in the reverse order of removal.

20. LIGHTS/METERS/SWITCHES

HEATER CONTROLLER UNIT (DINK 125)

INSPECTION

Heater control unit inspection

1. Open ignition switch to check if the brown /blue wire of it is enough voltage.
2. Put the heater controller unit in refrigerator.
Start engine after keeping the temperature under 10 ± 4 °C
3. Start engine and if the temperature of heater controller unit is under 10 ± 4 °C. Check if the white/yellow wire of heater controller unit has output voltage. If it has not any voltage. It is damaged.

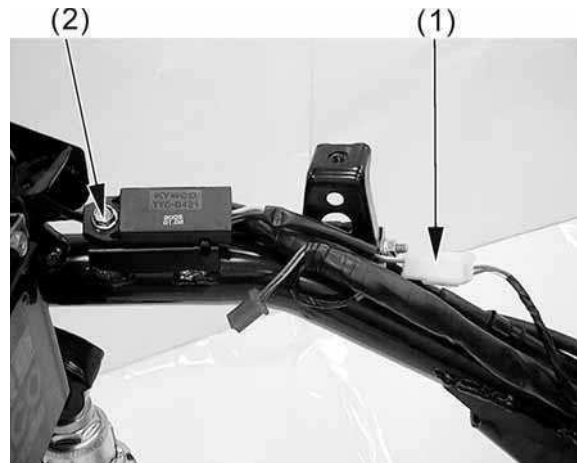

REMOVAL/INSTALLATION

Remove the luggage box (refer to the “FRAME COVERS REMOVAL/INSTALLATION”).

Disconnect the controller unit connector (1).
Remove the bolt (2) and heater controller unit.

Installation is in the reverse order of removal.

HEATER WIRING DIAGRAM

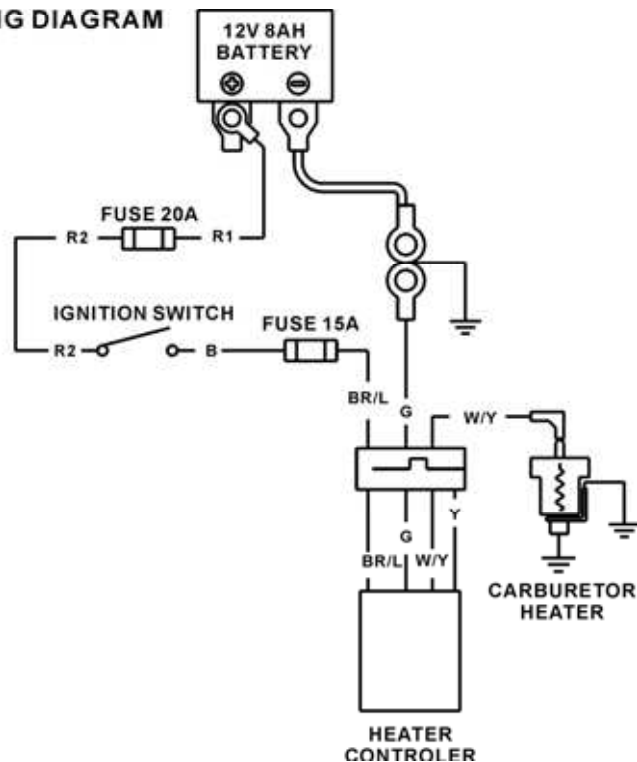

21. WIRING DIAGRAMS

DINK 200i

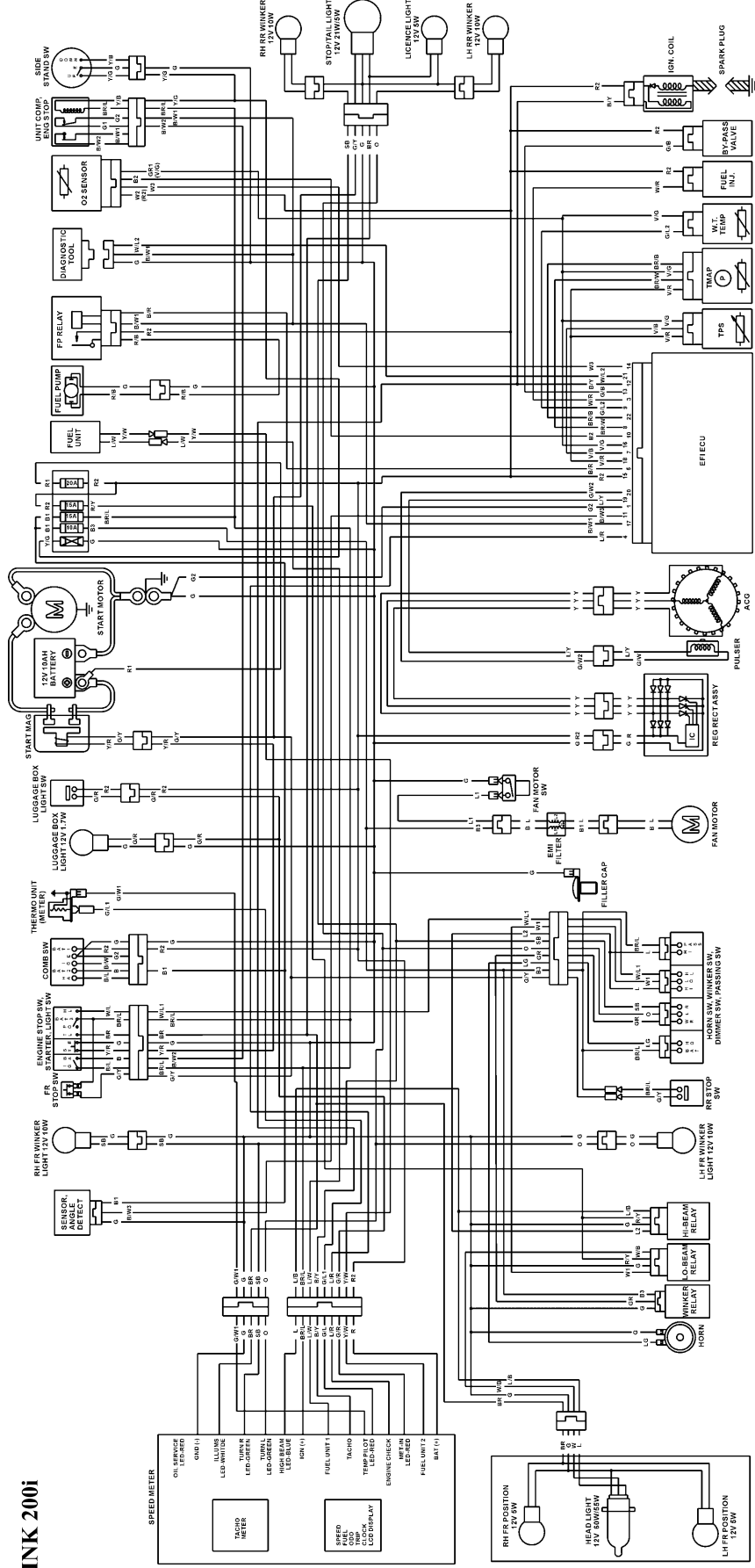

WIRE COLORS (GROUND/MARKING)

B	BLACK	BR	BROWN
G	GREEN	GR	GRAY
O	ORANGE	SB	SKY BLUE
L	BLUE	LG	LIGHT GREEN
W	WHITE	V	VIOLET
Y	YELLOW	R	RED

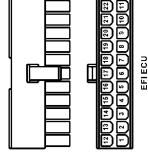

NO.	WIRING COLOR	FUNCTION	WIRING COLOR	FUNCTION
11	BR	MAIN	BR	MAIN
12	BR	MAIN	BR	MAIN
13	BR	MAIN	BR	MAIN
14	BR	MAIN	BR	MAIN
15	BR	MAIN	BR	MAIN
16	BR	MAIN	BR	MAIN
17	BR	MAIN	BR	MAIN
18	BR	MAIN	BR	MAIN
19	BR	MAIN	BR	MAIN
20	BR	MAIN	BR	MAIN
21	BR	MAIN	BR	MAIN
22	BR	MAIN	BR	MAIN

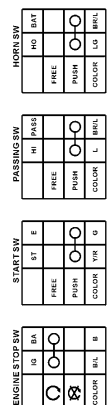

21. WIRING DIAGRAMS

DINK 125

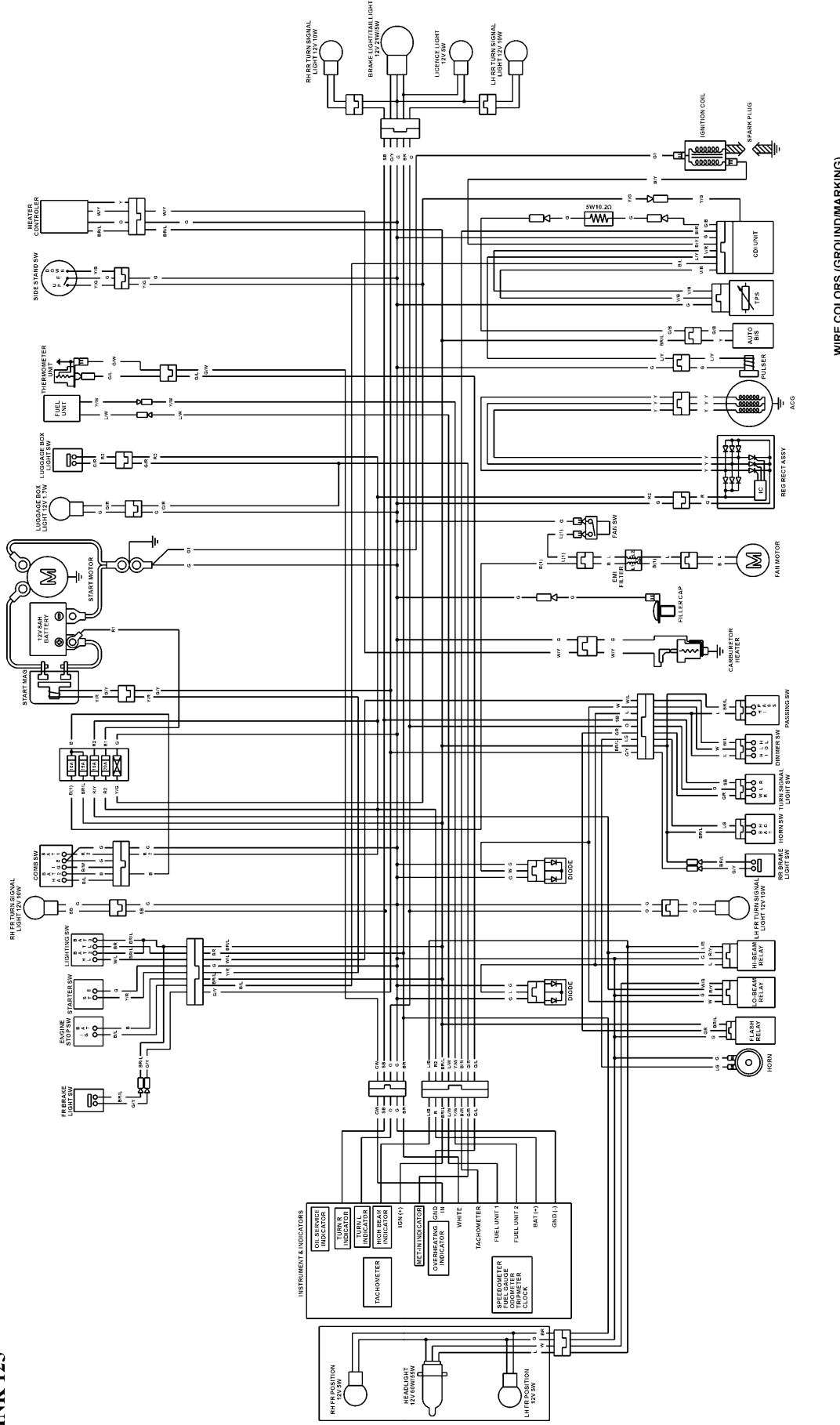
WIRE COLORS (GROUND/MARKING)

B	BLACK	BR	BROWN
G	GREEN	GR	GRAY
O	ORANGE	SB	SKY BLUE
L	BLUE	LG	LIGHT GREEN
W	WHITE	V	VIOLET
Y	YELLOW	R	RED

DIMMER SW		
HI	LO	W
LO		
	HI	
COLOR		
LO	HI	W

LIGHTING SW		
(BAT)	TL (BAT)	HL
COLOR		
HL	HL	HL

TURN SIGNAL LIGHT SW		
L	R	L WR
COLOR		
R	SB	GR

IGNITION SWITCH			
(BAT)	(E)	BATT	HA
LOCK	OFF	ON	ON
COLOR			
B	BN	G	BN

HORN SW		
NO	BAT	
COLOR		
US	BN	

PASSAGE SW		
IN	PASS	
COLOR		
L	BN	

START SW		
ST	E	
COLOR		
TR	GR	

ENGINE STOP SW		
NO	BAT	
COLOR		
IN	B	